

ART MAGAZINE

ck
X



Book No.

ACCESSION

*720.5 Ar24 ¹⁴¹

495977

NOT TO BE TAKEN FROM THE LIBRARY

FORM 3427-SM-B 38

C

SAN FRANCISCO
PUBLIC LIBRARY
PERIODICAL DEPT.

ARCHITECT AND ENGINEER

APRIL, 1940

RECENT WORK OF JOHN EKIN DINWIDDIE





MINUTES MEANT DOLLARS ON THIS JOB

With the opening date pressing, the new store of the George Benioff Fur Company was still without a roof. A concrete roof had to be placed with utmost speed and strength development in a minimum of time. ☆ In stepped Golden Gate 24-Hour Cement. Overnight the roof, skylight and all, was completed, allowing workmen to finish the interior ON SCHEDULE. Another example of how Golden Gate 24-Hour Cement converts time saving into dollars. ☆ When you want safety and permanence—with SPEED—specify Golden Gate 24-Hour Cement and be sure.



George Benioff Fur Store
Oakland, California
Architect: John E. Dinwiddie
Contractor: Willis Lynn
Engineer: Robert J. Fisher



**ASK YOUR DEALER
FOR THIS MANUAL**



POUR TODAY — USE TOMORROW

PACIFIC PORTLAND CEMENT COMPANY
SAN FRANCISCO COASTWISE SERVICE PORTLAND
LOS ANGELES SEATTLE

RUNNING FIRE

by
MARK DANIELS, A.I.A.

Return of the Plague

The advent of the modern house seems to be a mere reversion to type in a great many cases. One of these is the so-called living-dining room combination, the dining room often being an unventilated, partially blocked alcove. In this particular it resembles the social halls of the old fashioned, jig-saw houses of the nineties, where a series of folding doors was used to block off the rear, unaired portion for such nefarious pursuits as a game of whist while the other members of the family sat in the parlor-front.

This curse of construction has been criticized, condemned and prevented by Mr. Thyle of the Division of Housing Inspection in Dr. Geiger's Department of Public Health. Now the jerry-builders of today are doing practically the same thing by claiming that a dining-living room combination, with the dining alcove unventilated and partially separated from the living room, is one room. They make fanciful arches, pilasters and beams to form smoke pockets, odor holes and impediments to air movement between the living room and the so-called dining room. The result smells for a week after the first meal and the first game of cards.

So I propose three solutions to the crime. First, and best, call the alcove a room if there is the least bit of separation and require ventilation in accordance with the Building Code. Second, require that the ceiling of the dining alcove be lower than that of the living room and no separation by columns or beams. Third, require as a minimum, that there be no separation between the rooms whatsoever providing the dining room ceiling is not higher than that of the living room. Well, anyway, let's hope.

★ ★ ★

Machinations

The bartender had just placed an Old Fashioned in front of me when the Little Man grabbed my hand and shook it vigorously, benefiting me with a sour smile.

"Machines and man are cosmic midgets," he remarked.

The Little Man quickly picked

up my drink, swallowed it, and I signalled O'Brien for another one. "We regulate our lives," he continued, "with clocks, working hours, food, diets and doctors. We have telephones, automobiles, airplanes, poison gas, printing presses and arthritis. Then, communication, transportation and orderly existence are suddenly disrupted and the reason is that some star exploded three billion years ago. The sun is so formed that combinations of elements will occasionally result in solar storms that will block telegraph, radio and telephone communication. Disruption of the earth's routine by a measly sunspot will produce atmospheric disturbances and we will be flooded out of our homes. Therefore, the technological development of mankind is no good, and useless besides, because some little bit of a star got mixed up, caused a solar system, and varied itself into a recurring calamity.

"Consequently, I believe we should forget our buildings, our taxis, our inventions and follow the elemental dictates of the host of Angus Og—and Bacchus."

I pondered a moment—and the Little Man was gone—with my drink.

★ ★ ★

Second Hand

I have just heard of the most superb editorial achievement—a climax to all modern developments, mass production and mass circulation. Here it is:

The Reader's Digest purchased an article and the purpose of the purchase was to write a review of it. Then the Reader's Digest gave the article to another national magazine to publish.

This seems to please everyone. The Digest gets a review, the other magazine gets a corking good article, and the author gets his name in two periodicals, plus a pay check. A little complicated and indirect, but conducive to something.

★ ★ ★

History

San Francisco's famous City Hall, its beautiful and majestic

War Memorial Building, Opera House, Public Library, Auditorium, State Building and Federal Building—all congregate at Civic Center. Bright flowers grow in the plaza and fountains and pigeons add their quota.

But I wonder what Mayor La Guardia thought when he looked at the happy scene from Mayor Rossi's well furnished offices. And I wonder what visitors to City Administrator Cleary's office think of the view from his windows. And what do the thousands of visitors to Civic Center think of the three-quarter circle of architecturally perfect and harmonious structures, combined with the ever-present, ever-ugly, unadorned, hideous, disgraceful, back of the Orpheum Theatre.

Years and years ago, as I understand it, the Orpheum Theatre builders set aside a generous sum of money to be used for facing the rough concrete. But the City Planning Commission, or other public authority on the development of Civic Center, could not make up its mind as to the proper steps to get the required effects. Months and months went by and the City still didn't know its own mind. The owners of the Orpheum found they were losing money fast and here was the generous sum and so there it went. And the owners lost all their money and the City has an unfinished concrete wall to off-set the beauty of the Federal Building.

Finally, public organizations began to request action by the City. For years they have requested action—they have even suggested planting ivy as a last resort. Latest support for action came from Dr. Schmidt's City Beautification Committee and the San Francisco Junior Chamber of Commerce—with the vague hope in mind that it would have been nice for the 1939 and 1940 fair visitors to see a real Civic Center rather than a contrast similar to the modern bathroom and the outhouse.

When the Orpheum wall crumbles to dust it will be possible for the proper authority in the City Hall to determine what type of a building it will permit in this location—but then it may never crum-

(Turn to Page 66)

ARCHITECT AND ENGINEER

Since 1905

Volume 141

April, 1940

Number 1

x 720.5
A 24 14
495977

RECENT WORK OF JOHN EKIN DINWIDDIE 17
Frederick W. Jones

FUNCTIONAL DESIGN SEEN IN MODESTO COUNTY BUILDING 45
Russell Guerne de Lappe, Architect

MAKING THE GARDEN AN OUT-OF-DOOR LIVING ROOM . . . 50
Nathan H. Graves

ARCHITECTS' BULLETIN—NATIONAL LEGISLATION 53
Harris C. Allen, Architect

WORK OF JOHN EKIN DINWIDDIE (PHOTOS, RENDERINGS,
DETAILS AND PLANS) 16-44

STANISLAUS COUNTY OFFICE BUILDING, MODESTO 45-49

RESIDENCE OF HARRY R. BUTLER, HILLSBOROUGH 8
Leo J. Sharps, Architect

NEXT MONTH—Mark Daniels, architect, and contributing editor, has his own ideas about how an architectural magazine should be compiled and edited, so he will be given more or less latitude to show his versatility in the May number, with illustrations of his own work predominating.

(Index to advertisements—Page 72)

.....
HONORARY EDITORS

Arthur Brown, Jr., Timothy L. Plueger, Lewis P. Hobart, John J. Donovan, Will G. Corlett, Frederick H. Meyer, Thos. J. Kent, Gordon B. Kaufmann, Ben. H. O'Connor, Michael Goodman, Harry Michelsen.

REGULAR CONTRIBUTING EDITORS

Harris C. Allen, Harry Sanders, Paul H. Hunter, Glenn Stanton, Chas. H. Alden.

.....
EDITOR, FRED'K. W. JONES; ASSISTANT EDITOR, E. N. KIERULFF; CONSULTING AND CONTRIBUTING EDITOR, MARK DANIELS.

ARCHITECT AND ENGINEER is published on the 15th of the month by The Architect and Engineer, Inc., 68 Post Street, San Francisco. President, K. P. Kierulff; Vice President, Fred'k. W. Jones; Secretary and Business Manager, L. B. Penhorwood.

Entered as second class matter, November 2, 1905, at the Post Office in San Francisco, California, under the Act of March 3, 1897. Subscriptions, United States and Pan America, \$3.00 a year; foreign countries \$5.00 a year; single copy \$.50.

Los Angeles office: 832 W. Fifth Street, Bland Ballard, manager.

ARCHITECTS REPORTS are published daily from this office and are sponsored by the Northern Section, State Association of California Architects; Vernon S. Yallop, Mgr.

.....



CLIENT:

"We want a heating system that won't rust out before the last payment is made!"

BUILDER:

"All right. We'll use U·S·S Galvanized Copper Steel... the same rust-resisting metal we install in large buildings."

Will U·S·S Copper Steel Last?

Thin sheets without paint or without galvanizing were exposed to all kinds of weather for 21 years. 91% of them still remained sound after this severe test. Other metals used for the same purpose proved decidedly inferior.



YOU can't blame a prospective home owner for insisting on durable metal work when his mortgage may run for 25 years. What type of steel are you specifying for the duct work in modern homes? Will it have ample rust resistance to combat the higher humidities of today's heating systems? If you are still using conventional metals, it will pay you to get the facts on the superior corrosion resistance of U·S·S Copper Steel.

In large cities where corrosion from smoke is especially severe, the longer life of U·S·S Copper Steel is even more apparent. Here is a steel

"made to order" for air conditioning systems and all sheet metal work exposed to corrosion—yet you need not pay a high price for it. Copper steel sells for only a few per cent more than plain steel. The difference would scarcely be noticed when compared to the total cost of the building.

U·S·S Copper Steel is also used for roofing, gutters, downspouts, flashings. It is available, either plain or galvanized, for quick delivery in all principal localities.

Get our booklet which gives complete proof of the longer life of U·S·S Copper Steel. Write to one of the companies below.



COPPER STEEL SHEETS

Look for this trademark on steel products. It is your assurance of quality and full value for your money.

COLUMBIA STEEL COMPANY, San Francisco
 CARNEGIE-ILLINOIS STEEL CORPORATION, Pittsburgh and Chicago
 TENNESSEE COAL, IRON & RAILROAD COMPANY, Birmingham

Scully Steel Products Company, Chicago, Warehouse Distributors
 United States Steel Export Company, New York

UNITED STATES STEEL

ARCHITECTS COMMENT FAVORABLY ON KENNETH C. BLACK'S RECENT LECTURE

It is quite some time since an article in *ARCHITECT AND ENGINEER* has aroused so much favorable comment as Kenneth C. Black's discussion of Modern Architecture in the February number. Commendatory letters are still pouring in and in a number of instances the writers have not only indorsed Mr. Black's theories but have supplemented their own thoughts on the subject. One or two of these communications are printed below.

William Wilson Wurster, always brief and to the point, writes:

"The article by Kenneth C. Black is top notch—where does Mr. Black live? Is this his real name or a pen name?"

In answer to Mr. Wurster's inquiry he was advised that Mr. Black's address is Detroit, Michigan, and that he is not hiding behind a nom de plume—he doesn't need to!

Harry M. Michelsen, former President of the State Association of California Architects, writes:

Editor *Architect and Engineer*,
San Francisco, California:

The free and easy way in which Mr. Kenneth C. Black described the progress of Modern Architecture in the recent issue of *The Architect and Engineer*, was an explicit description of the trend of architectural practice. Reviews of this character are of value in directing the fate of modern business. It outlines the rapid spread of modern architecture in commercial and monumental buildings, and the slow progress in residential design—also, the relationship that exists between the architects and their clients.

The term "modern," as applied to our recent architecture, is somewhat misleading. In reviewing the original, it is interesting to find that our present day architecture appeared in Austria more than fifty years ago. Since then it was developed and perfected in Eastern Europe, before becoming firmly established in the United States. Some of the earlier buildings in this country which were designed in some form of radical architecture and classified as unusual, monstrous or degrading, are now considered obsolete.

Modern architecture of the future is left open in Mr. Black's article. The evolution of art and architecture has changed with the progress of the world, and will continue to adjust itself, depending on the desires of the people in their modes of existence. Many of us are of the opinion that the historical and traditional styles of architecture are gone forever. During the next decade, we should continue to improve our art, architecture and color harmony, since we are gradually releasing ourselves from the traditional styles and established methods that guided our destiny in the past. Architecture and the allied arts may be developed in the

future into a more gratifying style of form and color, with force, unity and coherence that are now lacking in some structures. It seems to me that the future buildings will be developed into a more substantial style. There should be better proportion, veritable scale, and decorations with natural forms of flowers and foliage, and impressive sculpture, rather than the hard and tortured forms that have been used in the past. The use of combination color tones has advanced faster than either architecture or the allied arts, and in the future, color harmony may be the essential base for our architectural development.

Many architects are in accord with Mr. Black's idea as to how far modern architecture will extend. Looking backward over a few years, we find there was a period of transition between the Modern, Classic and Renaissance. During this change-over, many interesting commercial buildings have been designed. Modern architecture applied to residences seems to be floating and will continue to drift until the public learns to appreciate its features, and the architects are able to design modern houses that reflect the comfort and pleasing appearance that is found in the traditional styles.

Mr. Black's classification of architects is extremely interesting, since we learn that 10 per cent of them are "God's gift to the world" and are masters of all they survey, and the remainder are merchants of architecture. All of us may be considered as merchants, dealing in the sale of a professional commodity. The minority group is offering an unusual or fantastic piece of merchandise, and the others are selling a staple product that the customer is satisfied to accept. The idea of architects being referred to as merchants is somewhat new, and has significant force, character and distinction, and should be commercialized.

It is generally understood that the successful architect sells to his client the type or style of architecture that is desired. The small radical group referred to as the 10 per cent class, is employed for the purpose of designing buildings with extreme forms, mass and color. Clients and investors of the conservative class, desiring to follow the natural trend of the times, and wishing to have their investments properly protected, are satisfied with the method of procedure followed by the 90 per cent group of architects that constitute the rank and file of the profession.

We in the United States, will probably assume the leadership in newer methods and finer developments in the field of design and construction. As time passes, the modern conceptions of art and architecture should be more beautiful than the Classic, Renaissance, Gothic or other periods.

It will be beneficial to the profession if Mr. Black will continue to contribute his

ideas on the subject of modern architects and architecture. His article was illuminating and constructive, and will be helpful in diverting architects into the avenue of progress.

Yours very truly,

HARRY M. MICHELSEN, A.I.A.

San Francisco, March 15, 1940.

Harry Sanders of the United States Department of Agriculture, also wrote a voluntary letter of approval, a copy of which was mailed to Mr. Black who acknowledged receipt of same, together with a copy of *Architect and Engineer* containing reprint of his lecture, as follows:

Editor *Architect and Engineer*,
San Francisco, California:

This will acknowledge receipt of the February copy of *Architect and Engineer* which contains a reprint of my talk on Modern Architectural Theories and will also acknowledge the receipt of the letter from Mr. Sanders of the United States Department of Agriculture which you forwarded.

I would like you to know that I think you did a fine job in setting up my article, and I appreciate very much your courtesy in publishing it. I would also like to compliment you on the general makeup of your publication.

Sincerely,

KENNETH C. BLACK.



Send for
catalog
"The Charm
of a Light-
Conditioned
Home"

MODERN

No furnishings you can buy for so little will give you as much long term satisfaction as a new Lightolier fixture.

**INCANDESCENT
SUPPLY COMPANY**
726 MISSION STREET, SAN FRANCISCO

SPECIFY NAIRN LINOLEUM WITH ASSURANCE

Nairn Linoleum Exceeds New Federal Specification

LLL-L-351a

MAY 2, 1939

SUPERSEDING

Fed. Spec. LLL-L-351

February 3, 1931

FEDERAL STANDARD STOCK CATALOG

Section IV

(Part 5)

FEDERAL SPECIFICATION

FOR

LINOLEUM; BATTLESHIP

This specification was approved on the above date by the Director of Procurement, for the use of all departments and establishments of the Government, and shall become effective not later than March 15, 1940. It may be put into effect, however, at any earlier date after promulgation.

A. APPLICABLE SPECIFICATIONS.

A-1. There are no other Federal specifications applicable to this specification.

B. TYPE AND GRADE.

B-1. Battleship linoleum shall be of but one type and grade and of the following thicknesses: $\frac{1}{8}$ inch, $\frac{3}{16}$ inch, and 6 millimeters.

C. MATERIAL AND WORKMANSHIP.

C-1. *Material.*—Battleship linoleum shall consist of oxidized linseed oil, fossil, or other resins and/or rosin or an equivalent thoroughly oxidized oleo-resinous binder intimately mixed with ground cork, wood flour, and pigments and pressed on a burlap backing.

C-2. *Workmanship.*—The linoleum shall be free from defects affecting its appearance or which may affect its serviceability.

D. GENERAL REQUIREMENTS.

D-1. *Color and finish.*—The surface of the linoleum shall be smooth and free from streaks, spots, indentations, cracks, and protruding particles of cork. The color and finish shall match a sample mutually agreed upon by buyer and seller. Unless otherwise specified the surface of the linoleum shall be factory finished with a clear transparent coating. (See par. F-2b.)

E. DETAIL REQUIREMENTS.

E-1. *Width.*—Unless otherwise specified the width of the linoleum shall be $72\frac{1}{2}$ inches \pm $\frac{1}{8}$ inch. (See par. F-2c.)

E-2. *Burlap backing.*—

159515—39

THE new Federal Specification for Battleship Linoleum, effective not later than March 15th, 1940, is more stringent than ever.

And it is significant that Nairn Linoleum, with no change of its standard factory specifications and tests, not only meets these new Federal requirements, but surpasses them.

What better testimony that Nairn Linoleum may be specified by you on residential, commercial, or government construction with complete client confidence?

Write us now for complete information describing these tests, which were made by the Pittsburgh Testing Laboratory.

Nairn Linoleum, installed by authorized contractors, is covered by a guaranty bond fully covering value of workmanship and materials.

CONGOLEUM-NAIRN INC.

KEARNY, N. J.

NAIRN
TRADEMARK REGISTERED
LINOLEUM
Floors and Walls

There is a Haws Drinking Fountain



Model No. 7A—June



Model No. 7D—Pacifica



Model No. 7F—Manhattan

For every type of public building—schools, theaters, auditoriums, gymnasiums—residences and play-grounds.

THE HAWS 1940 CATALOG

"R Revised" containing our complete line of drinking fountains and electric water coolers, now ready for distribution.

FOR FURTHER INFORMATION



HAWS DRINKING FAUCET COMPANY

1808 HARMON STREET • BERKELEY • CALIFORNIA

Agents in the following cities:

New York • Los Angeles • San Francisco • Seattle • Salt Lake City • Portland

ARCHITECT AND ENGINEER

**IT'S
SCREENLESS!**

-the new
**WATROUS
SILENT-ACTION
FLUSH VALVE**



Tests made by a nationally known, independent research laboratory (name on request) show Watrous SILENT-ACTION equipment eliminates an average of 88.5% of flush valve noise.

Here is a **SILENT TYPE FLUSH VALVE THAT STAYS SILENT**

YOU will find the new Watrous SILENT-ACTION Flush Valve distinguished in two ways: First, it operates with almost unbelievable silence (proved by independent laboratory tests). And second, alone among all silent-type flush valves, it has no screens, shot or mufflers of any type whatsoever to become clogged.

As a result, this valve brings to users 3 highly important advantages: (1) It assures silent operation that **STAYS** silent. (2) It eliminates the need for frequent adjustment of shut-off to compensate for

gradual clogging (such as occurs when screens are employed). (3) It has no parts requiring frequent replacement or cleaning.

All Watrous Flush Valves can be furnished complete with Watrous SILENT-ACTION equipment. Equipment can also be used to eliminate the bulk of flush valve noise on old installations.

For complete information, write for your copy of "A Scientific Method of Silencing Flush Valves."



This patented, corrugated dispersion silencing element does the bulk of the silencing job. **NOTE THAT NO SCREENS ARE USED.**

Patented air inlet completes the elimination of objectionable closing noises. Cushions closing action of the valve.

THE IMPERIAL BRASS MFG. CO.
1237 W. Harrison St., Chicago, Ill.

Watrous
SILENT-ACTION
Flush Valves

See Catalog No. 54—Section 27 of Sweet's Catalog file for specification and installation details.

THIS HOUSE SEEMS TO HAVE GROWN WITH ITS SURROUNDINGS



RESIDENCE OF HARRY R. BUTLER, HILLSBOROUGH, CALIFORNIA

Leo J. Sharps, Architect



ALL-GAS KITCHEN IN HARRY L. BUTLER HOUSE,
HILLSBOROUGH, CALIFORNIA

A HOUSE beautifully adapted to its site is the Harry R. Butler residence in Hillsborough, California, by Leo J. Sharps, architect. It is happily situated on a long, narrow, sloping strip of oak studded land.

Curved tile roof and stucco exterior lend a Spanish feeling to the architectural motif. Large windows in the living room and dining room take advantage of a hillside view, and a patio with barbecue pit connects with the living room on the upper side of the house. Winter heat and summer ventilation provide year-around comfort. This is through a gas-fired forced air heating system with full automatic control. An automatic storage type gas heater assures abundant hot water, and a modern gas range gives utmost cooking facility in the kitchen.

The house consists of a living room, a small reception hall, library, dining room, breakfast room, kitchen and laundry, all on one floor level. From the living room an arched opening leads three steps up to a bedroom hall off of which are two bedrooms with connecting bath. From a rear hall, between living room and kitchen, a stair leads to the basement.

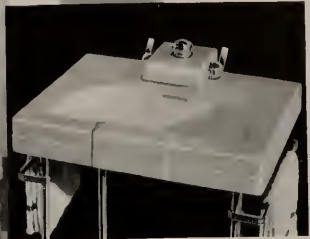

Neuvogue Lavatory

Here Crane has created a new shape of basin. Width is placed exactly where the user wants it—at the front—and because of the sweeping curve of the basin there is a generous amount of space on the lavatory slab. Faucets, handles and waste are grouped together, out of the way.



Neuvogue Closet

Notice how logical is the continuation of the line of the tank to the floor. Note, too, how the base is solid at the floor . . . how the tank conserves wall space. The seat has the correct hygienic curve, with a flat cover.

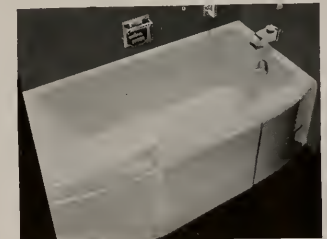

Neuvogue Bath

Here is a new conception of utility. The sides, running in a slight slant to the bottom, provide extra bathing area. The wide front rim is at once a shelf and a seat.

Here's an Architect's eye-view of Crane Neuvogue

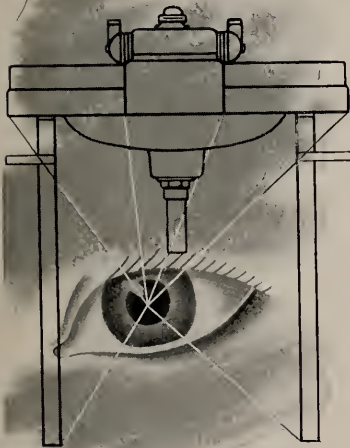

TO your clients, Crane *Neuvogue* expresses a modern freshness—a new smartness—a great new style in plumbing fixtures. To you, who look below the surface to find the basic reasons for its design, Crane *Neuvogue* stands as one of the finest realizations of a modern architectural ideal: making utility beautiful.

Neuvogue represents the application of modern design by Henry Dreyfuss to the problem of making bathroom fixtures smarter, more graceful, more beautiful as well as more functional.

★Despite its originality and greater convenience—Crane *Neuvogue* is priced for the moderate building budget. Remember, too, that Crane Quality is available in every price range. Use your Crane architects' catalog when specifying!

CRANE

CRANE CO., GENERAL OFFICES: 836 SO. MICHIGAN AVENUE, CHICAGO, ILLINOIS

VALVES • FITTINGS • PIPE • PLUMBING • HEATING • PUMPS
NATION-WIDE SERVICE THROUGH BRANCHES, WHOLESALERS, PLUMBING AND HEATING CONTRACTORS



ALTERATIONS AS USUAL DURING BUILDING ?

Architects have become resigned to owners' demands for frequent changes in plans after building has started. They know last-minute changes are to be expected, and allow a little flexibility in budgets to take care of them.

However, the architect alert to changing trends has found that he can avoid annoying changes and additions to the electrical service by giving the wiring plans the necessary attention before building starts.

Electrical service has become so increasingly important to owners during recent years that owners are more aware than ever that wiring should be done right at the time of building.

Architects who have learned the ease with which wiring plans can be made by using Red Seal specifications as a guide, have no worries about the electrical service.

The Red Seal Adequate Wiring plan is a minimum standard to be applied to all homes. Any amount of additional service can be included. It is meant as a guide to be sure that nothing vital is overlooked.

A single sheet of specifications is printed on heavy paper suitable for architect's use. If you do not have your copy, phone or write and one will be sent you free.

PACIFIC COAST ELECTRICAL BUREAU

447 SUTTER STREET • SAN FRANCISCO, CALIFORNIA

We are proud
of our frequent
participation in
buildings designed by
John Ekin Dinwiddie

ALADDIN HEATING CORP.
2222 San Pablo Avenue
OAKLAND, CALIFORNIA

ABBOT A. HANKS, INC. **Engineers & Chemists**

INSPECTING — TESTING — CONSULTING
CONCRETE • STEEL • MATERIALS

CHEMICAL AND TESTING
LABORATORIES

• RESEARCH AND INVESTIGATION •

TESTS OF STRUCTURAL MATERIALS
DESIGN OF CONCRETE MIXES
SHOP AND ERECTION INSPECTION OF
STRUCTURES AND EQUIPMENT
INVESTIGATION OF STRUCTURES
AND MATERIALS
TESTS AND INVESTIGATION OF
FOUNDATION SOILS
FIRE RESISTANCE AND INSULATION
TESTS

624 Sacramento Street

San Francisco

THEY LIKE TO LIVE IN "BIGGER" HOUSES!

YOU CAN WIDEN OUT WALLS WITH GLASS



See what a Picture Window does to a small room. A wall pushed back . . . a room flooded with sunshine . . . just one example of what Glass, used generously, can accomplish in a small home.

● Of course, not all of your clients are looking for mansions. But all of them like the *feeling* of spaciousness—all their money will buy. You can widen out the houses that you plan—*push back the walls*—with glass.

For instance, with a large picture window you can definitely *do things* to dimensions—create a feeling of spaciousness that is almost a new kind of architectural magic.

Corner windows—sparkling areas of glass that meet at right angles—take the “cramps” out of corners.

Partitions—or doors—of beautiful shimmering Louvrex, Flutex or Reedex add to the illusion of more breathing space—and are pleasingly decorative as well.

Well-placed full-length door mirrors will bring new convenience, new roominess to bedrooms, bathrooms and entrance halls.

When you use glass generously in the houses you plan, you add little to cost—add immeasurably to charm and livability. And for best effects in glass nothing but the *best* will do. The L·O·F label on glass is today, as it has been for many years, a symbol of Highest Quality. Libbey·Owens·Ford Glass Company, Toledo, Ohio.



← A dining room door glazed with Satinol Finished Flutex. An interesting effect is obtained by alternating the directional lines of the pattern.

→ An effective and appealing use of mirrors . . . on the inside of the closet door—above the built-in drawer cabinet.

MAKE ROOMS
"GROW" WITH
GLASS!



LIBBEY · OWENS · FORD



QUALITY GLASS

COLORFUL TILE GIVES SALES APPEAL TO MODERN HOMES



KITCHEN IN WILLOW GLEN HOME, NEAR SAN JOSE. KRAFTILE 6x9'S, CEILING HEIGHT, ARE OF SAN GABRIEL YELLOW; THE TRIM IS SEAFOAM GREEN.

ACCORDING to Thomas H. Herschback, general contractor of San Jose, dwellings sell more readily when tile work is installed in generous quantities.

Sales experience in the price bracket of \$5500 to \$7500 justifies wide use of tile because of its appeal of color and ease of cleansing, as well as durability, he said.

For several homes erected by Mr. Herschback in the Willow Glen development, Charles S. McKenzie, architect of San Jose, specified Krafttile 6x9's, attaining excellent results with ceiling-height tile installations in kitchens, tiled splashboards and drains of tile. Tile work in bathrooms included floors, four-foot wainscoting, fully-tiled recesses for bathtubs and fully-tiled showers.

That generously tiled dwellings have sales appeal is the statement of the contractor. "We have found that dwellings sell more readily when tile work is installed in generous amount," said Mr. Herschback.



ARCH OF TILE BETWEEN DINETTE AND KITCHEN IN WILLOW GLEN HOME. KRAFTILE'S SHASTA WHITE WITH TRIM OF LAGUNA GREEN FOR BAND AT CEILING AND FOR BASEBOARD.



LOOKING THROUGH KITCHEN TO LAUNDRY IN WILLOW GLEN HOME. TILE COLORS ARE MONTEREY BUFF AND SEAFOAM GREEN.



LARGE
JOBS

ZOURI STORE FRONTS INCLUDE —

- SASH AND BARS
- AWNING BARS
- MOULDINGS AND SHAPES
- METAL PANELING
- K. Z. S. PORCELAIN ENAMEL
- ENTRANCE DOORS
- SIGN LETTERS
- SPECIAL METAL WORK

Zouri Store Front in bronze for Chicago Department Store

Call on Zouri

FOR ANY STORE FRONT!

No matter what type of store front problem arises— for huge department store or tiny shop—Zouri offers full cooperation in the execution of any design. In most cases, striking effects may be obtained by the use of standard Rustless Metal Mouldings which are carried in stock. In others, Zouri fabricates colorful porcelain enamel panels and special architectural metal work in aluminum, bronze or stainless steel— to face the entire front, to produce doors or letters in harmony with the store front design, or to satisfy any modern demand.

Equally important, Zouri Sash and Bars, in either Rolled or Resilient Extruded types, are scientifically engineered to provide maximum safety—with a firm, secure CUSHION GRIP evenly distributed along each side of the plate glass. For complete information, refer to SWEET'S, contact your Zouri distributor, or write direct to ZOURI STORE FRONTS, NILES, MICH.



SMALL
JOBS

McCRORY SODA & LUNCH

REFRIGERATED

Zouri Store Front for attractive shop in Brooklyn, New York

ZOURI STORE FRONTS

SUPERIOR FIREPLACE

*CIRCULATES WARM AIR
to all corners and adjoining rooms*

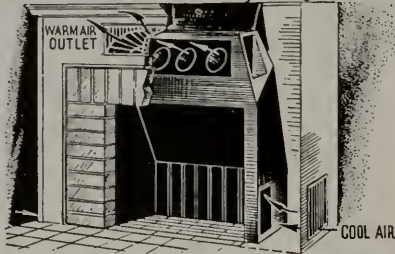

A COMPLETE FORM

(from hearth to flue)

AROUND WHICH IT IS EASY TO BUILD

A new or remodel present fireplace.
—cut fuel bills—correct smoke troubles.
Thousands in use in all climates.
Healthful—because it ventilates, circulates and evenly
distributes warm air.

Write for Superior Fireplace Literature
Manufactured by the *Pioneers of the Industry*—

SUPERIOR FIREPLACE COMPANY

1046 South Olive Street

Los Angeles, California

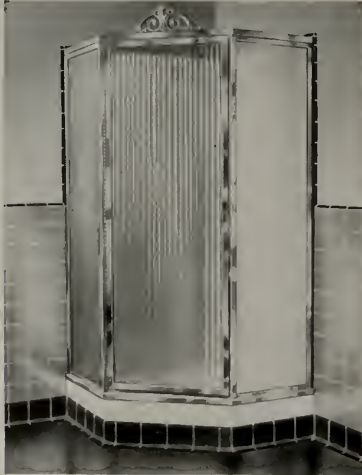

THIS modern beautiful "GLASSHOWER" Model 7436CS is a complete PREFABRICATED unit consisting of the porcelain finished shower floor and back walls, glass side walls and shower door, all plumbing fittings and soap dish.

In addition to its sparkling beauty it saves space, is inexpensive and always light, dry and airy.

Designed and Manufactured by

STAINLESS METAL PRODUCTS INC.

481 - 25TH STREET

OAKLAND, CALIF.

Write for circulars

Cabot's BLEACHING OIL AND STAINS

Specified and used
on the
beautiful homes
designed by
JOHN EKIN DINWIDDIE
ARCHITECT
and illustrated in
this issue.



GUNN, CARLE & CO.

SAN FRANCISCO

20 Potrero Avenue

UNderhill 5480



MR. ARCHITECT:

8 Good Reasons why
you should specify
FRANTZ "Over-the-top"
Garage Door Equipment

Simple and easy to install, the FRANTZ "Over-the-top" set has many advantages over the pivot or counter balanced types. They include:

- 1** Low headroom. Requiring only two inches of clearance above the door header.
- 2** The door — when open — does not project beyond the header, is entirely within the building.
- 3** A reduction in ceiling height in garage construction. As much as 12 to 16 inches.
- 4** The elimination of side wall projections leaving both side walls free and clear. Does not interfere with the location of side door entrances, window opening, shelving or cupboard.
- 5** Elimination of posts, often necessary in multiple garage door installation when using pivot type sets.
- 6** No projections. The garage is entirely free as the hardware is applied on the edge of the door and door jamb.
- 7** Steel "weather-strips" a part of the equipment makes a more complete and "finished" job, makes the door weather tight.
- 8** FRANTZ "Over-the-top" door equipment needs no weights, chains, pulleys or cables.

FRANTZ *Over-the-Top* Door Equipment

*Write for name of authorized distributor
and installation service in your territory.*

FRANTZ SALES COMPANY

ROOM 627-420 S. SAN PEDRO ST., LOS ANGELES
LOS ANGELES, CALIFORNIA

SAN FRANCISCO, CALIF.

PORTLAND, OREGON

OFFICE

OFFICE

200 DAVIS STREET

131 E. W. 4TH AVENUE

SON FRANCISCO
PUBLIC LIBRARY
PERIODICAL DEPT.

DESIGNED TO DRAW TRADE



Gas heat does its part

Contemporary store design attains unique sales appeal in this building for *Sears Roebuck and Co.*, Los Angeles, by Architect *John Stokes Redden*. ✦ The huge display windows fairly shout, "Come and see." Roof parking invites frequent visits and leisurely shopping. And for the welfare of both customers and employes, there is "the latest" in controlled gas heating. ✦ From an automatic gas boiler, steam forces circulation of hot water through coils which temper the evenly circulated air: Comfortable, healthful, economical! ✦ Your Gas Company invites consultation with its engineers about your specifications.

LET GAS THE MODERN FUEL DO THE 4 BIG JOBS

COOKING • HEATING • WATER HEATING • REFRIGERATION



PHOTO BY CEDRIC WRIGHT

SCREEN DETAIL, RESIDENCE NEAR WALNUT CREEK, CALIFORNIA
JOHN EKIN DINWIDDIE, ARCHITECT

RECENT WORK OF JOHN EKin DINWIDDIE, ARCHITECT

By FRED'K. W. JONES

WHEN Eliel Saarinen, distinguished architect of Finland, some few years back, predicted a brilliant future for a young Californian then studying under his tutorage, he had good reason for making that prophecy. "This lad should develop into one of the coming architects of the Pacific Coast," Saarinen further confided to an acquaintance.

That the Finnish architect's prediction was justified one needs no further proof than the pages of this issue of *The Architect and Engineer* which reveal the recent accomplishments of John Ekin Dinwiddie, architect and former student of Saarinen. While a preponderance of Dinwiddie's work shown here is local his talents have earned him national and international recognition. Magazines in this country and abroad have acknowledged his capability, ranked him with the leaders of his profession.

As a background and training Mr. Dinwiddie has had an enviable record, studying at the University of California, the University of Michigan and then under the great Saarinen. After his early training he was awarded the Booth Traveling Scholarship which took him to Europe for a year of study and travel.

One of his first commissions to bring his name into the limelight after taking up the practice of architecture in San Francisco, was to design a series of clever cover pictures for this magazine.

Mr. Dinwiddie has won enviable recognition through his prize winning designs in national competitions. In the last two years he has won honors in contests conducted by the *Ladies Home Journal*, *Productive Homes*, *House and Garden*, as well as honorable mention in the *American Gas Association Competition* and the *United States Government Competition* for a *Post Office Building* at Burlingame, California.

Besides his extraordinary sensitiveness to design, not only in aesthetic but also in analytical qualities, Mr. Dinwiddie is accomplished in the medium of pencil, pen and drypoint.

As the illustrations show, landscape design holds a very important place in his work. He believes that garden formality is the influence of architecture upon the landscape; that garden informality is the influence of the landscape upon architecture. Both are arbitrary conventions which tend to limit the growth of true design forms from their mother context of local conditions and materials.

The landscape designer is not an inspired artist who waits for a brilliant solution to strike him out of the blue, he is a planner who assists the development of the natural solution of forms from the four primarily important factors which appear in every problem: PEOPLE—their physical and psychological properties. SPACE—for life must be given tangible form. MATERIALS—have definite native characteristics which should appear in their final form. LOCAL CONDITIONS—specific site forms, existing trees and special features, must all have an important voice in the final results.

Gardens today must be more than just pictures to justify their existence, they must be planned outdoor environments for the lives of people. They cannot be this if plants are their most important inhabitants. Garden pictures reached peaks during the Italian and French Renaissance, the English Romantic landscape period, and in the Japanese garden.

Former ages emphasized the importance of the Church or ruling clique; today we emphasize the importance of the life of the individual man. Gardens must do likewise in order to be part of the twentieth century.

Associated with Mr. Dinwiddie are Albert Hill and Phillip Joseph, capable designers, both of them, and Garrett Eckbo, landscape consultant, whose ideas synchronize happily with those of his associates.

RESIDENCE OF FRASER COLE, OAKLAND



EXTERIOR VIEWS

PHOTOS BY JOHN LOHMAN



LIVING AND DINING SPACE, RESIDENCE OF FRASER COLE, OAKLAND



NIGHT VIEW AND PLAN

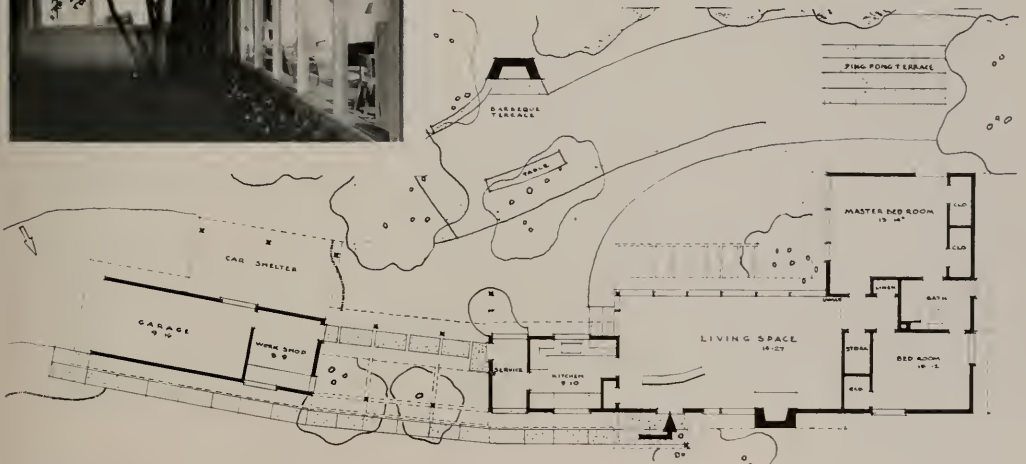

RESIDENCE NEAR WALNUT CREEK



GENERAL EXTERIOR VIEW

GARRETT ECKBO, LANDSCAPE ARCHITECT

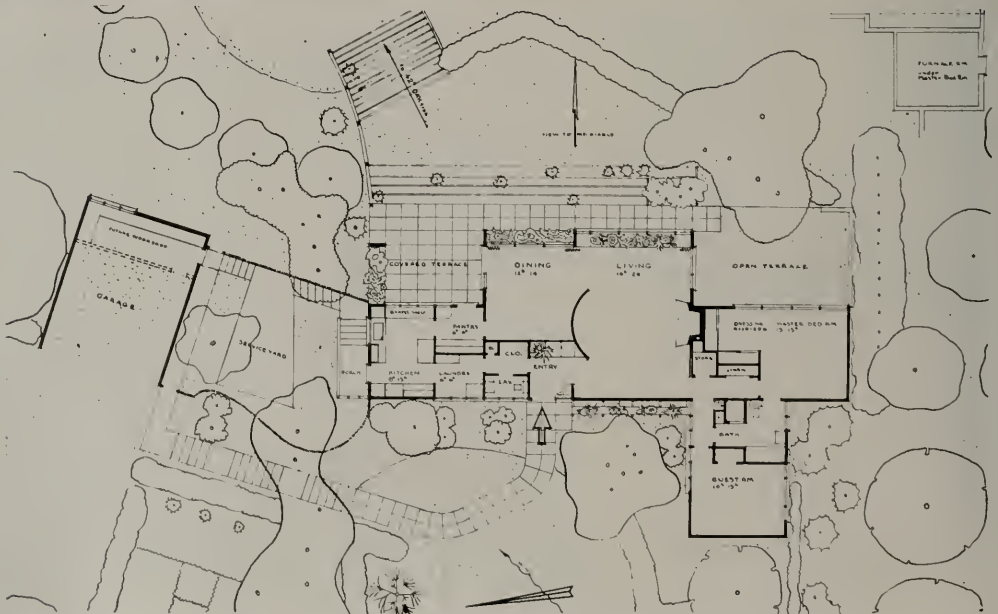

PLAN

ARCHITECT AND ENGINEER



LIVING ROOM, RESIDENCE NEAR WALNUT CREEK



BREAKFAST SHELF

PHOTOS BY CEDRIC WRIGHT

RESIDENCE OF FREDERICK SAMMIS, BERKELEY



STREET VIEW



LIVING ROOM

PHOTOS BY CEDRIC WRIGHT



EXTERIOR FROM STREET



PLANS

GARDEN EXTERIOR

GARRETT ECKBO, LANDSCAPE ARCHITECT



RESIDENCE OF HAROLD SMITH, MENLO PARK



DETAIL

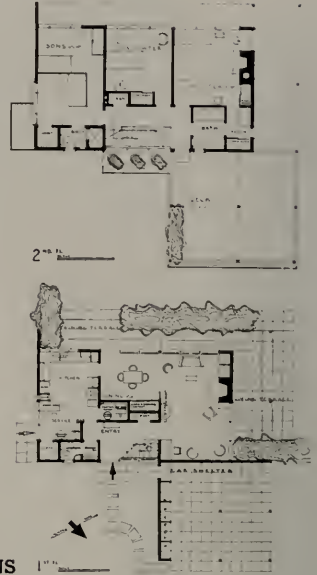

PLANS



GARDEN VIEW

JOHN EKIN DINWIDDIE, ARCHITECT



LIVING AND DINING ROOM, RESIDENCE OF HAROLD SMITH,
MENLO PARK, CALIFORNIA

PHOTO BY ESTHER BORN

RESIDENCE OF S. V. CAMPBELL, ORINDA



GARDEN VIEW

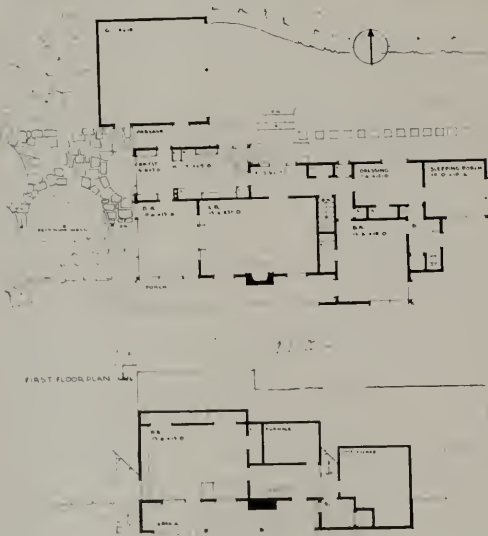

An all wood country home. . . . Shingle roof, shake walls and redwood siding . . . living room, dining room and kitchen walls are of natural wood . . . dining room windows are removable, becoming an outdoor screened porch during the summer months

PLANS

RESIDENCE FOR STANLEY PEDDER. LAFAYETTE



VIEW FROM COURT



VIEW FROM GARDEN

PLAN

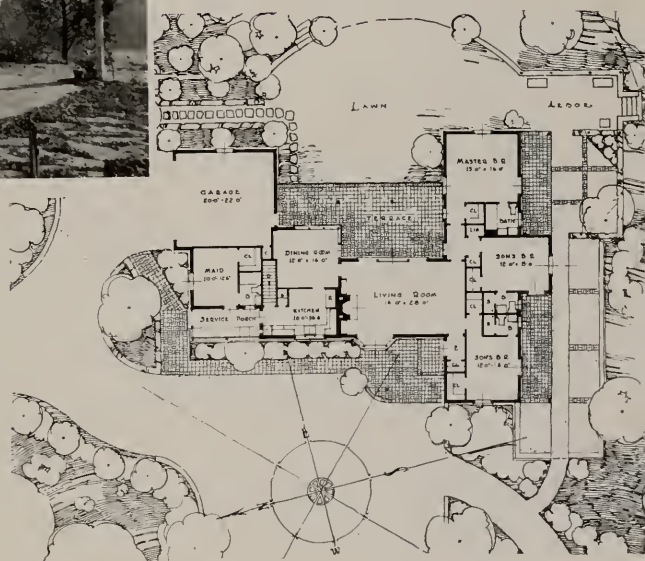

A HOME FOR COUNTRY LIVING. . . . EACH BEDROOM HAS A COVERED TERRACE FOR OUTDOOR SLEEPING

RESIDENCE OF JOHN E. DINWIDDIE, BERKELEY



GENERAL VIEW

THOMAS D. CHURCH, LANDSCAPE ARCHITECT



SPRING BLOSSOMS—

GARDEN VIEW
FROM LIVING ROOM,
HOUSE OF J. N. GHIRARDELLI,
WALNUT CREEK

RESIDENCE OF C. D. BRENNER, BERKELEY

John E. Dinwiddie, Architect

Thomas D. Church, Landscape Architect

PHOTOS BY CEDRIC WRIGHT



GENERAL VIEW

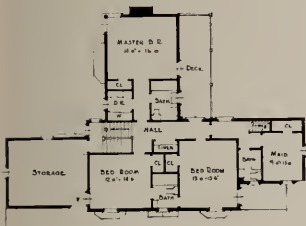

SECOND FLOOR



STUDY

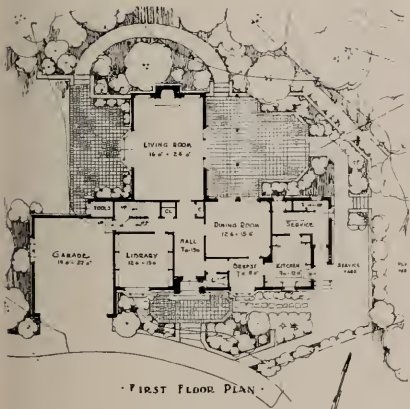

FIRST FLOOR PLAN



EAST GARDEN VIEW

A DRESS SHOP IN BERKELEY



SET BACK SHOP FRONT

PHOTO BY CEDRIC WRIGHT



PLAN



INTERIOR

Exterior color—chocolate brown, golden grey. Jewel box—brilliant crimson.

Interior color—end wall and ceiling, coral; shop walls, oyster white; ceiling, grey blue; display recess, chocolate brown.



GEORGE BENIOFF STORE, OAKLAND



BROADWAY ELEVATION



DRESSING ALCOVES



INTERIOR



SKYLIGHT DETAIL

PHOTOS BY PHILLIP FEIN



CELLAR PLAN



FIRST FLOOR PLAN

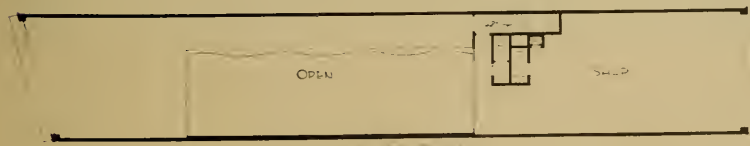

MEZZANINE FLOOR PLAN

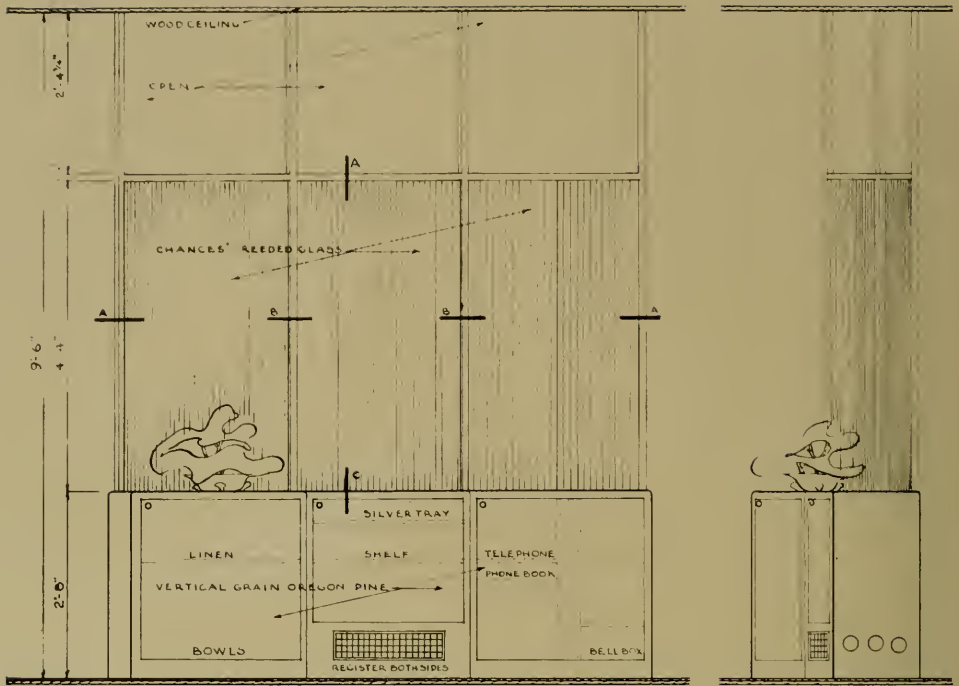

ELEVATION

SIDE ELEV

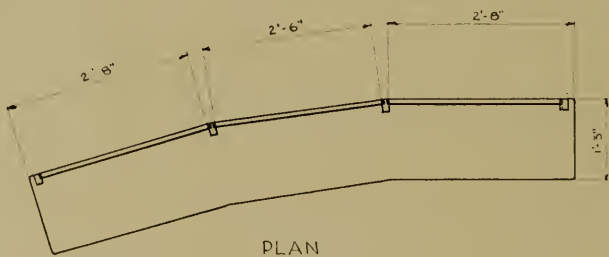

PLAN

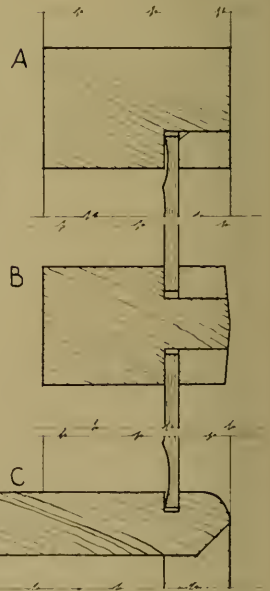

ENTRY
LIVING
DINING
SCREEN
DETAILS

FRASER COLE RESIDENCE, OAKLAND

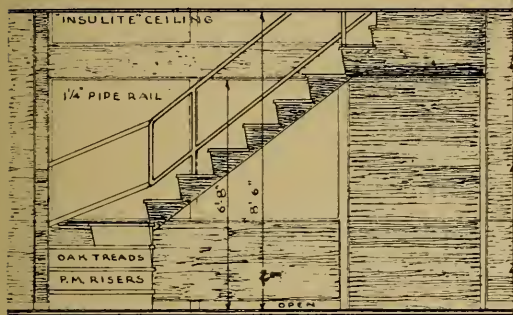
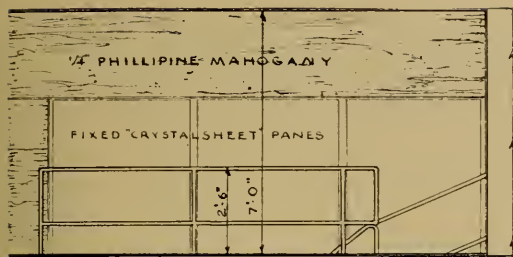

PHOTO BY JOHN LOHMAN

HAROLD SMITH RESIDENCE, MENLO PARK



STAIRCASE



ELEVATION

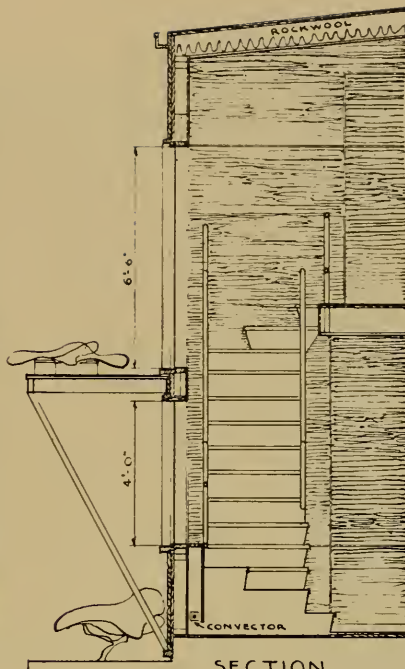

SECTION

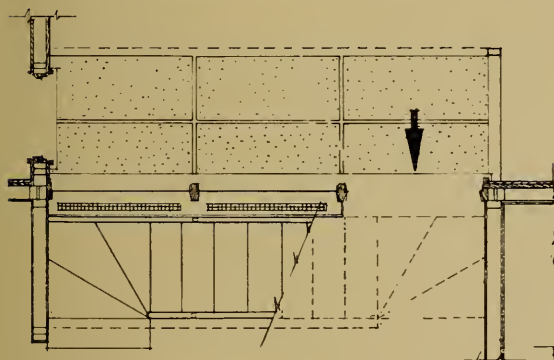

PLAN

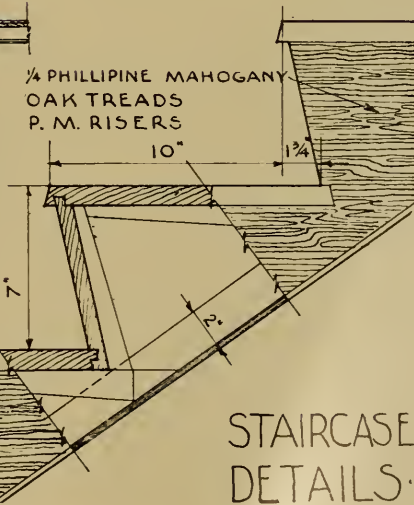
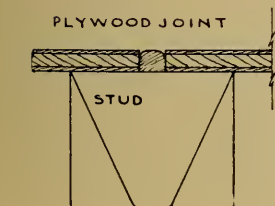

STAIRCASE
DETAILS

RESIDENCE NEAR WALNUT CREEK



FIREPLACE

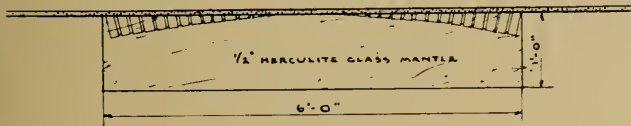
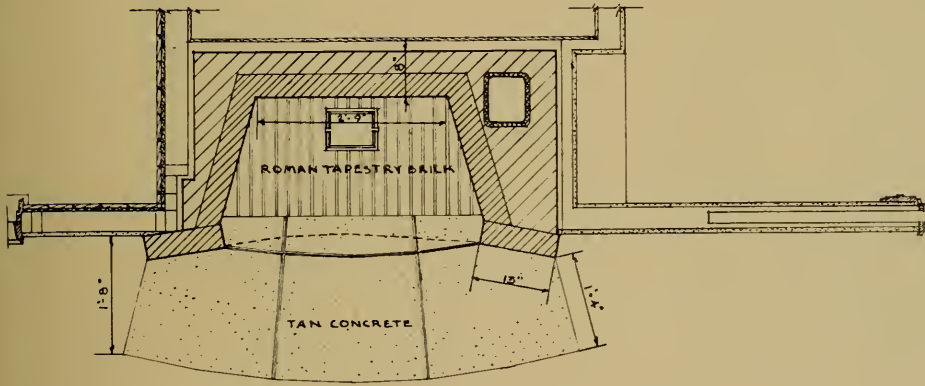
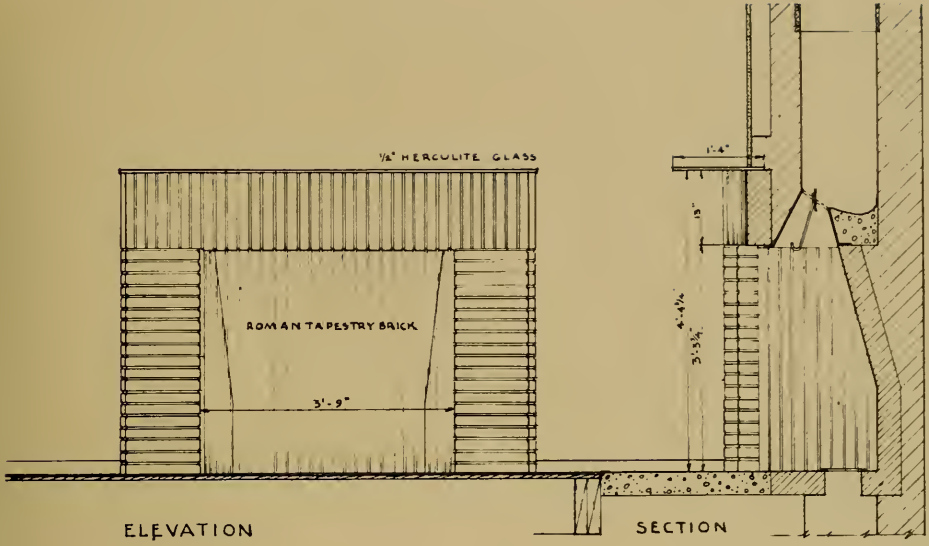

FIREPLACE
DETAILS

RESIDENCE NEAR WALNUT CREEK



PHOTO CEDRIC WRIGHT

ENTRANCE

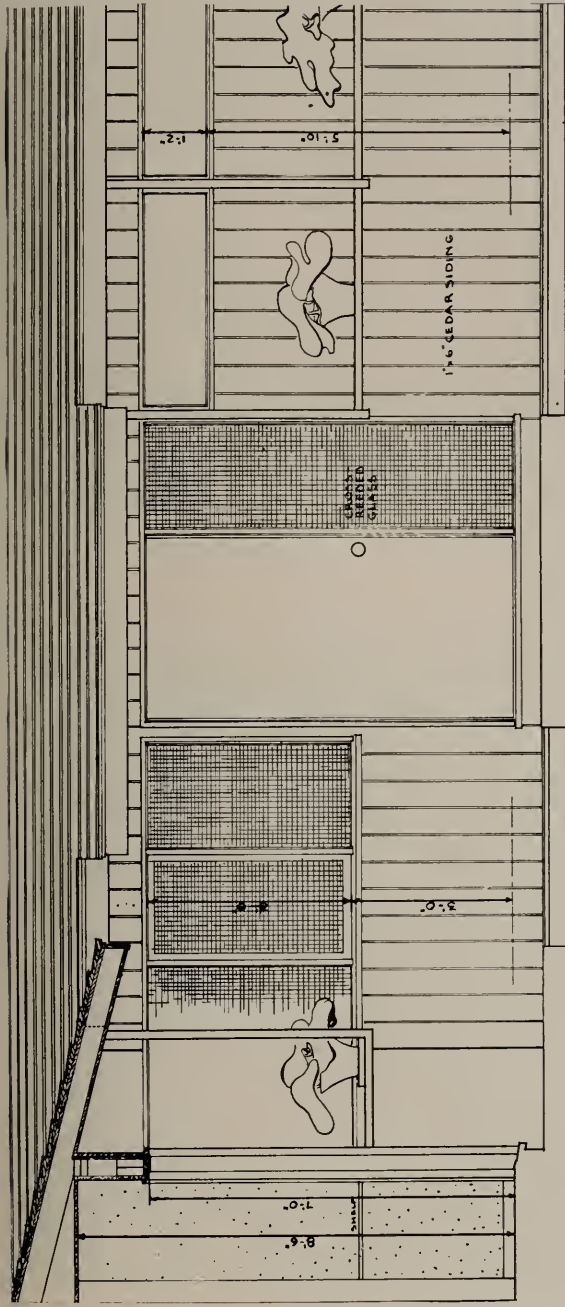

ELEVATION

SECTION

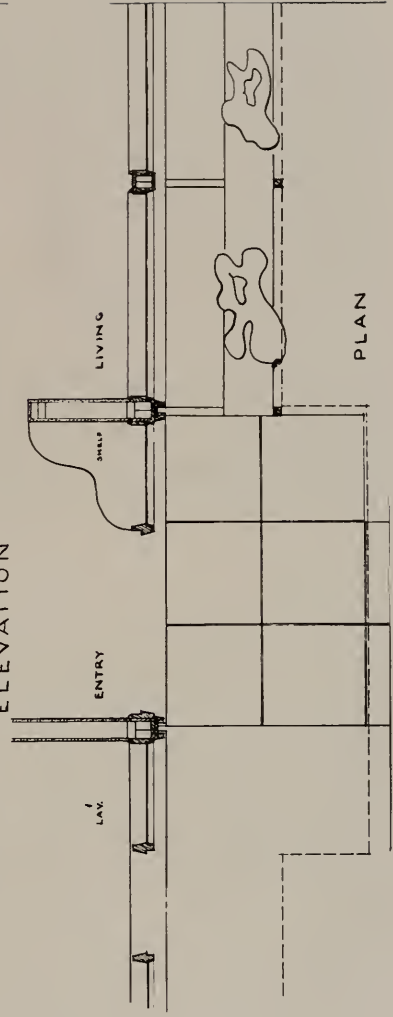

PLAN

MEDICAL BUILDING, BERKELEY, FOR DR. WILSON



EXTERIOR FROM TELEGRAPH AVENUE



ENTRANCE FROM PARKING AREA

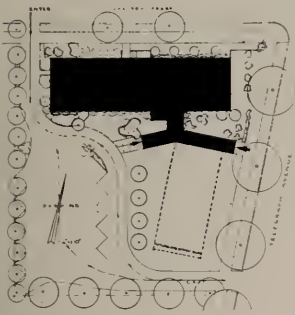

PLOT PLAN



LOBBY

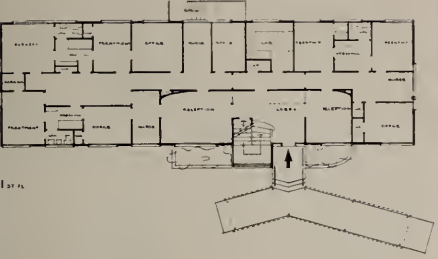

1st fl.



2nd fl.

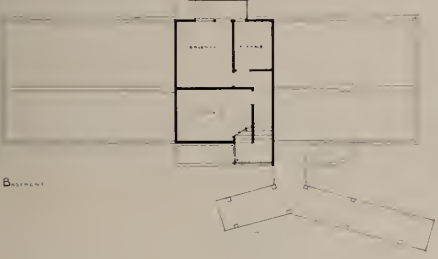

Basement



RECEPTION ROOM



TREATMENT ROOM



CORNER VIEW



ENTRANCE DETAIL



STAIRWAY TO MEZZANINE

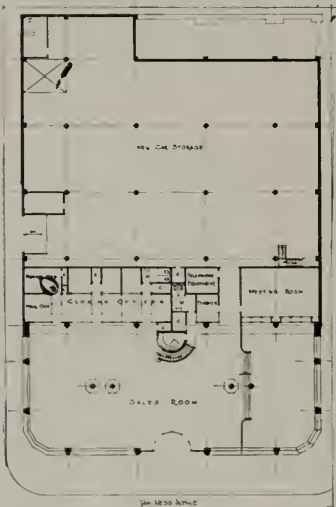

FIRST FLOOR

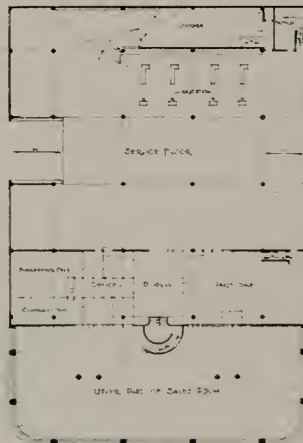

MEZZANINE

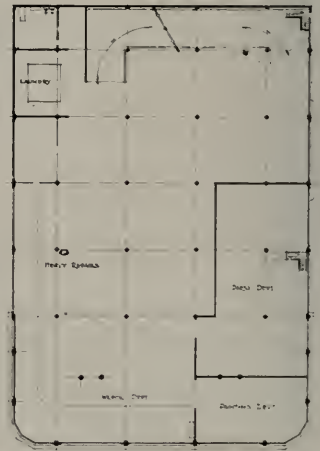

THIRD FLOOR



FUNCTIONAL DESIGN IN MODESTO COUNTY BUILDING

By RUSSELL GUERNE DE LAPPE, ARCHITECT

IN the new county building at Modesto, California, a dearth of Goths, Athenians, Romans, et al., in the community, precluded the adoption of any traditional architectural style. Mild evidences of economic forces resulted in restraint serving as the better part of design. An effort has been made to balance the various dissimilar functional elements. Voids, with the multiplicity of parts present in the form of sash or glass block which, with their reflective surfaces, strike a dynamic note, are complemented by the plain mat surfaces of architectural concrete interposed to strike a static note. At present the concrete surfaces are unpainted. Eventually a coating will be applied and the resulting benefits of color will be had.

The structure was developed as one unit of a group of buildings, all of which are intended to be contiguous. The site is a 300' x 400' rectangular city block with axes at 45° to the compass. The preferred frontage parallels the street on the northwest exposure.

The county departments which were to be housed at this site were readily segregated into four well defined groups based upon their functional character. Those that served the public in a manner comparable to any office-type business were chosen as the occupants of the first unit. This resulted in an effort to create a maximum of occupied or used area and a minimum of hallway or circulation area, keeping the relationship between the outside light facilities and working areas so that interior

COUNTY OFFICE BUILDING, MODESTO



CORNER VIEW

KAWNEER ALUMINUM MARQUEE



FIRST FLOOR CORRIDOR



OFFICE SPACE WITH GLASS BLOCK PARTITION

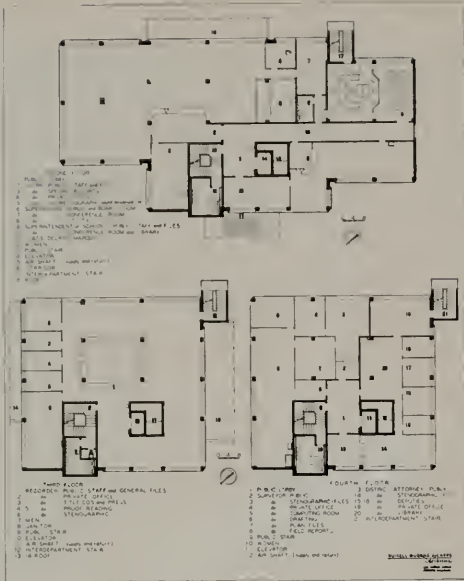

SECOND, THIRD AND FOURTH FLOOR PLANS

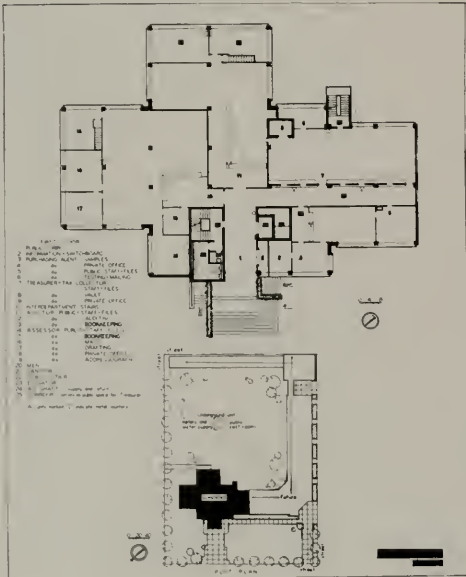

FIRST FLOOR PLAN

subdivisions could be made with reasonable assurance that residual areas, so created, would be the desired sizes for purposes intended.

The degree of interrelation of the various offices as determined by the work they perform, defined their juxtaposition, and their floor location was determined by a survey which was made to reveal the extent of their patronage by the public. Each department head supplied pertinent information on prepared forms. This "Architectural Gallup Poll" provided explicit data on the floor areas required and the nature of their use, furniture and equipment to be installed, storage needs and expansion possibilities. By means of the survey each official was afforded an opportunity to amplify the specific aspects of the type of work performed in his department. In compiling the results of this survey, the working patterns of the personnel were observed to be the unifying agent or, better said, to be the least common denominator used to arrive at a final plan arrangement.

The desirability of having a factor of flexibility in the partitioning of inner offices and working spaces was revealed in the history of changes which had been made in the old courthouse to meet the growing and modified needs of the departments. Two architectural provisions have been made to expedite this condition, namely, the use of the continuous sash and the glazed, sectional partition. The former makes it possible to subdivide on multiples of 3'-9" without loss of natural lighting or the creation of disturbing the balance of walls to voids within rooms. One wall is always a ribbon of light.

The clerk and the recorder have a unique and identical problem. Their records are constantly increasing and must be held and made available for public use. An eventual expansion in floor area is implicit in this condition, therefore these two departments have been placed in direct vertical alignment and the structure has been designed to permit the extension of these two departments toward the Southwest.

Supplementing these architectural considerations, the mechanical equipment has been correspondingly designed to meet the requirements for future change. The phone, annuncia-

MAKING THE GARDEN AN OUT-OF-DOOR LIVING ROOM

By NATHAN H. GRAVES

THE garden is an integral part of the home and should be given the same thought and care in planning. Granted that this is so, why not include in the plans lighting convenience outlets so located as to allow the owner to have full use of his garden? These convenience outlets should be controlled by switches in the house and if installed at the time of construction add very little more than the cost of any outlet inside the house proper. Of course, the size and character of the garden are of prime importance but there is no garden too small to be lighted; in fact a small garden lends itself to lighting effects more easily than do some of the larger ones. The main thing is to have the electrical outlets conveniently installed. In most cases the owner will want to have the pleasure of working out the desired effects himself; this anyone can do and there is no limit to the number of beautiful fantastic effects that may be produced.

To bring the service from the house to the various locations planned, have a trench, about fourteen inches deep run to the several locations, then use a "Parkway Cable" or the new G. E. "Tellurium Cable." Over the top of this lay a 1" x 6" rough Redwood board and then cover with earth. This will give adequate protection in the future from spading and digging.

STANISLAUS COUNTY OFFICE BUILDING

The structure, including an underground, independently constructed vault containing the gas meter, electric transformers and meter and a deep well water pump and pressure system, cost \$211,000.00. The useable floor area totals 38,000 square feet and the enclosed volume totals 445,000 cubic feet. A Public Works Administration grant of \$77,049.00 made the undertaking possible. The balance of the funds were available through the county's reserves.

The structural engineering and the mechanical engineering were done respectively by H. J. Brunnier of San Francisco and Arthur H. Memmler of Berkeley.

The convenience outlets should be located about 4 in. above the ground and should be mounted on 1/2 in. conduit sunk to a depth equal to the trench. The outlet boxes should be capped and so installed as to keep out moisture and rain. In addition to the outlets near the ground others should be located in any large trees that may be in the garden. There should not be more than four outlets to any one circuit. If there is a Landscape Architect on the project he should be consulted as to what plantings are the best subjects to light and where the electrical outlets may be hidden by the plantings. This is important for the daytime effect.

TWO KINDS OF LIGHTING

The owner will expect two kinds of lighting—one for play, and one for beauty. The first year the lighting will undoubtedly be for play areas—making the garden an Out-of-Door Living Room, a place to bring the guests on a warm summer evening for cards or just to enjoy the lovely setting of the garden. The coming of darkness, instead of shutting the home owners off from the beauty they have created, will bring them the new thrill of seeing their garden in a new light. Not only will they find the garden a satisfying picture but also a place where the imagination can be allowed to run free and, with a little ingenuity and not much expense, new effects can be produced nightly. At first the owner will desire to work out effects temporarily, then install the lights permanently in such a way that by touching a switch any or all parts of the garden can be transformed. The one important rule in garden lighting is: Don't try to produce natural effects such as daylight or moonlight. The garden is a stage setting for the home and even on a rainy night will be found a source of beauty when lighted by producing "picture windows." Picture windows are made by having the lights within the home very low, the shades open and then from every angle the effect of the lighted garden beyond is a living picture.

To get started in the hobby of garden lighting I would recommend the following experimental materials:

1. A flexible rubber cable in sections long enough to reach from the nearest outlet to any part of your garden and branching out into two or three lengths of about 30 ft., each of these branch wires terminating in a weather proof socket.

2. Three 40 watt outdoor reflectors and three 100 watt outdoor reflectors, each with a clamping arrangement which will hold it in any position at any height on an iron spike.

3. An assortment of iron spikes from one to six feet in length and a number of flat wooden stakes that you can write on in pencil.

4. Also a selection of waterproof Color Gelatins, large enough to fit over the front of the reflectors—two of each of the following should be on hand: pink, amber, straw, light blue, green blue, and medium green. These colors may be had for a nominal amount from a local theatrical supply house. Later when the final plans are worked out as to location and colors, the owner may invest in one or more of the new fluorescent floodlight units similar to those used so extensively at the 1939 World's Fair at San Francisco.

5. Also have on hand an assortment of plain and daylight lamps, all inside frosted, from 10 watts to 100 watts in size. These will permit experiments with intensities, a most important factor, as it does not follow that the strongest light produces the best results. I have seen far more overlighting than underlighting in gardens of all types.

6. The owner is now ready—he should select a dry moonlight night, have his wife, or a sympathetic friend, in the garden to help and, after the cables are tested, start experimenting.

PROBLEMS CLASSIFIED

Since each garden presents its own peculiar problems according to size and nature, only a brief general advice can be given here, but I would classify the problem as follows:

Flower Beds—Always more than one unit. The use of small tubular lamps partly wrapped in thin lead shields and mounted on slender spikes can be placed so that they are hardly visible. Always conceal the light source but do not try too hard to make the unit invisible. Merely have it as small as possible and with a

harmonious line. Do not, as a rule, have any lamp too near the ground and use the "daylight" lamp, plain lamps and color screens together.

Trees—Always light upward from more than one source concealed in the surrounding shrubbery, or in lower branches of the tree, use no "daylight" lamps. One blue and one green produce a beautiful effect and if the tree is large and the foliage thick, an interesting indirect lighting effect can be produced. The new fluorescent blues and greens are best on these subjects.

Shrubbery—A small reflector unit or shielded lamp back of one or more of the foremost bushes not too near the ground.

Rock Garden—Many small tubular lamps half-wrapped in thin lead sheets and mounted on short spikes—direct light down. Colors used produce many unusual effects.

Paths—The reflected light from the finished job will probably be sufficient, but if not, light the paths with decorative lanterns on posts or brackets.

Shallow Pools—Bottom of pool should be finished a deep turquoise blue. Several small lamps should be located near the bottom in water proof sockets, weighted to hold them down and shielded so that the lamp will be invisible from above.

Deep Pools—One or more 100 watt lamps sealed in waterproof sockets, anchored within a foot of the bottom. Shield light source. One garden lighting fixture particularly suited to garden pools is in the shape of a lily pad and when used with aquatic plantings give perfect results.

Fountains—There is a portable lawn fountain with a light built in it which will give a beautiful effect while the lawn is watered after dark. Fountains in pools should be lighted from sources concealed from sight. A very concentrated spot produces spectacular effects when used directly in line with the column of water.

Water Falls—Small lamps shielded from sight and directed against the fall of the water.

Special Decorative Units—Under this heading come statuary, pergolas, trellises, sun-dials, etc. Use color from concealed sources—several, preferably.

In each case devote time and patience to the problem and do not tackle more than one or two in one night. When satisfied with a result obtained with the experimental equipment, make a list of the required lighting units and length of cable, number and size of spikes, brackets and clamps, and number and size of lamps to be used. Now place one of the white marking stakes at the location of each unit and write the size and nature of the unit, the height over the ground and any additional data on the stake. When this is completed move the equipment to the next location with a perfect record of the work done.

When in this fashion the entire garden has been surveyed and all the desired effects recorded, draw a map and indicate cables and units. Each group should have its own switch so that instead of turning them all on or off at once different combinations can be used. For example: (1) Flower beds, (2) Shrubbery, (3) Large trees, (4) Rock garden (5) Pools and fountains (6) Pathways. This arrangement on six independent switches would make possible many combinations.

With the equipment described here, the owner's garden, sculptured with light, will speak to him in a new language of an old truth—beauty. One night he may light only the trees and wander in the soft diffused light reflected from the foliage. Another night it may be picture windows. Then again, alone, he may call upon the luminous water in a deep pool. Perhaps it will reveal the lace work of delicate branches, swaying in rhythm of light and shadow.

OREGON CHAPTER ACTIVE

Thirty-four members and associates attended the February meeting of Oregon Chapter, A. I. A., at Lloyd's Clubhouse.

President Stanton introduced Robert McMurray of the Commonwealth Trust Company, who talked briefly on the possibility of the architects submitting plans for houses that would be built this year under the FHA insurance, Title I, Class C. on 95 per cent basis. He suggested that the plans might be submitted by a Chapter competition, or by groups of Chapter members. The Commonwealth would display these plans and would send any prospective home-builder to the author of the drawings for blueprints and specifications, and for which the architect would be remunerated.

Bryant W. Moore, secretary of the Oregon Chapter

of the American Society of Heating and Ventilating Engineers, talked briefly on the congress at Corvallis.

President Stanton introduced an old member, Herb Angell, whose cheery face has not been seen for some time.

President Stanton called on Folger Johnson to speak on the small house situation on behalf of the FHA.

Mr. Johnson made a strong appeal to Chapter members to render their services to the public in accepting fees and helping out in the new Small Home Building Program. He felt that they would receive more compensation than at first seemed apparent, in a greater volume of work. He explained further that in most cases the architect's services would be limited and that the majority of prospective home builders would require only blueprints and specifications. He also announced that the Commonwealth Trust Co. had offered prizes amounting to \$750.00 to the members of the Chapter if they would be willing to hold a competition among themselves. He urged the Chapter to give this serious consideration.

President Stanton announced that the Meier & Frank Company had offered their auditorium to the Chapter for a spring Housing Show. Mr. Morin moved that the Chapter accept the offer and hold the show. The motion was carried.

PRaises L. A. RESIDENTIAL AREA

Jan Reiner, architect from Czechoslovakia, was a recent California visitor. He was particularly impressed with Los Angeles' residential area which he pronounced outstanding for beauty and charm.

"Another thing that pleases me here," he said in an interview, "is the penetration of the garden into the home—the planting of trees and flowers so that the outdoors seem to enter the house itself—happy, and I think, typically Californian.

"In the Los Angeles development, in many respects unique, I see the individualism and democracy of America expressing itself."

AMERICAN SOCIETY OF CIVIL ENGINEERS

The bi-monthly meeting of the San Francisco section, American Society of Civil Engineers was held in the Engineers Club, San Francisco, on Tuesday evening April 16.

The principal guest speaker was Ronald L. Cambell, Planning Engineer and Secretary of the San Mateo County Planning Commission. The subject of Mr. Cambell's address was "Recent Parkway and Highway Developments in the Eastern United States." The address covered parkway, highway and subdivision development in the Eastern part of the country and emphasized the excellent manner the New York metropolitan region is solving its automobile traffic problems by the construction of elevated express motorways. The talk was profusely illustrated with motion pictures.

ARCHITECTS' BULLETIN

Issued For

THE STATE ASSOCIATION OF CALIFORNIA ARCHITECTS Northern Section

STATE ASSOCIATION MEMBER
OF THE
AMERICAN INSTITUTE OF ARCHITECTS

Editor
Harris C. Allen

Address all communications for publication
in the Bulletin to the Editor (Harris C.
Allen) 557 Market Street, Room 218, San
Francisco, California.

STATE ASSOCIATION OFFICERS

President.....Ernest E. Weihe, San Francisco
Vice-Pres.....Merrill W. Baird, Glendale
Secretary.....Robert H. Orr, Los Angeles
Treasurer.....Mario Ciampi, San Francisco

Regional Director—Southern Section

Gordon B. Kaufmann, Los Angeles

Regional Director—Northern Section

Harry M. Michelsen, San Francisco

Executive Board—Northern Section

Officers

President.....Ernest E. Weihe, San Francisco
Vice-Pres.....Frederick H. Reimers, San Francisco
Secretary.....Vincent Raney, San Francisco
Treasurer.....Mario Ciampi, San Francisco

Directors

Harold H. Weeks and Wayne Hertzke
(for one year)

Harry J. Devine and William C. Ambrose

Executive Board—Southern Section

Officers

President.....Merrill W. Baird, Glendale
Vice-Pres.....Winsor Soule, Santa Barbara
Secretary.....Robert H. Orr, Los Angeles
Treasurer.....Sylvanus B. Marston, Los Angeles

Directors

A. M. Edelman, George D. Riddle
(for one year)

Sam W. Hammill and Ben H. O'Connor
(for two years)

Northern Section Advisory Council

San Francisco District:

Frederick H. Reimers (President)

J. K. Ballantine, Jr. (Secretary)

Harris C. Allen

Dodge A. Riedy

Ernest E. Weihe

Mario J. Ciampi

Conrad T. Kett

Roland I. Stringham

Wm. H. Knowles

Vincent Raney

North Bay:

J. C. Felciano

Lower San Joaquin:

H. G. Bissell

Santa Clara:

Chester Root

San Mateo:

Clyde Trudell

Upper Sacramento:

Casebolt Dakin

Sacramento:

Alfred Eichler

Upper San Joaquin:

David Horn

Monterey Bay:

Robert Stanton

Palo Alto:

Birge M. Clerk

Merin:

Jas Bertenshaw

East Bay:

Irwin Johnson

Jas. H. Anderson

Ralph N. Kerr

Berkeley:

Gwynn Officer

Redwood Empire:

F. T. Georgheson

Lassen:

Ralph Taylor

UNIFICATION REPORT

THE Joint Committee on Unification has made a detailed report which which will be presented for action at the Institute Convention in May. The present relationship of State Association to Institute is strengthened and amplified. Instead of one delegate to Institute Conventions, each State Association A.I.A. member would add one for every 50 voting Association members in excess of 25. The Chapters would be more closely tied in with the Association by means of Regional Council and Regional Coordinator, who would be under the general direction of the A.I.A. Regional Director.

This report is expected to provide the machinery necessary to bring all practicing architects together in one national organization, without working injury to Institute policies and procedures and without destroying the entity of the State Association within its own territory.

JOINT MEETING

The semi-annual (spring) meeting of the Northern Section of the State Association of California Architects, and the Northern California Chapter of the American Institute of Architects, was held in San Francisco March 26 at the St. Francis Yacht Club. In spite of bad weather and comparatively short notice, the attendance was good and spirits were obviously high. Business routine was disposed of and after enjoying songs contributed by Irwin Johnson—that truly Wagnerian tenor Robusto, and if any clients or contractors got into argument with Irwin, how he could drown 'em out in billows of bellows—the assembly settled down to hear our new Regional Director, Gordon B. Kaufmann, F.A.I.A., of Los Angeles and its environments up to and including San Francisco.

Mr. Kaufmann is not only a fine architect, but a fine gentleman with a fine personality. He took us into his confidence as to the programs and problems which he is now undertaking for Institute and State Association. Touching briefly on some of the important committees (which do the real work of an organization) he made a special tribute to our own John Bakewell for his devotion to the study of architectural education as chairman of that committee.

In regard to the proposed action to further unification, Mr. Kaufmann warned us that the satisfactory relationship between Institute and Association existing here, does not hold true in all other states, and that an open mind is necessary to reconcile conditions generally, according to the best judgement of the profession. He voiced his hope that Northern California would join wholeheartedly in the effort to bring the 1941 A.I.A. Convention to Yosemite, with the opportunity to show traditional western hospitality to delegates from eastern chapters and associations, in San Francisco and Los Angeles, following the convention. The gathering would probably be held in the vacation period, early in June and delegates would be routed west via the Grand Canyon and Boulder Dam.

The prospect of happy relationship with our Regional Director for the next three years appears bright.

EXPOSITION

The Executive Board has appointed a committee to cooperate with other branches, in an exhibit for the Construction Industry, at the 1940 San Francisco World's Fair. Vincent Raney, Mario Campi, and Wayne Hertzka were appointed. The Board is following up its earlier requests to Exposition authorities that the names of architects responsible for the various Fair Buildings, be made public and not kept as a dark secret from those attending the Fair, and the public in general.

PUBLICATIONS

The Executive Board has voted to check with "Architects Reports" and notify all newspapers and other local news publications of the availability of architects' sketches for new and proposed work of interest. Take notice, all members who have drawings that will stand reproduction—the possibility looms that you may receive credit for your next new job! And feel at liberty to call on the editor of Architect and Engineer if you have some interesting work to show. He will be glad to give you a "break."

MICHIGAN SOCIETY

Our members may wonder why so many references to and quotations from the Weekly Bulletin of the Michigan State Society are being published herein. Of course the answer is, they print just too much good material to be wasted on Michigan alone. (Will it be wasted on California?) As the rooster said when he rolled in the ostrich egg, it never hurts to see what other hens are doing.

The latest issue is a Silver Anniversary Number, of 100 pages, on heavy coated paper, for their 26th Annual Convention. It includes programs and reports of committees, district societies, M. S. A. minimum fee schedules, M. S. A. code of practice, latest schedule of unit building costs, and By-Laws of the Society, the State Licensing Architects Act, the State Housing Act, the School Construction Act, and lists of all registered architects, names and addresses.

In the vernacular, this brochure is a WOW! How do they get that way? And here is still another pertinent quotation from their Bulletin, in reference to an architect's talk to a local business club:

"This talk was accompanied by a display of samples and materials, renderings, architectural magazines, blue prints, specifications and the A. I. A. folder, 'The Value of the Architect.' The material used in this display is kicking around any architect's office and was very effective and made a good impression on the club members. It was gratifying to note the number of men who showed interest in these samples and renderings. Many of them had never seen an architect's rendering before and asked many questions regarding

the various building material samples, viz.: glass block, enameled steel, aluminum moldings, plywood, etc.

"This may seem elementary, but I felt, and the reception of the talk bore me out, that this is the type of information needed for the education of the public regarding the architect's services. We are naturally very familiar with our own work, but we are mistaken when we assume that the general public understand even the elementary principles regarding the architect's work. Too large a proportion of the public still feel that the architect is merely an artist concerned only with aesthetics and the frills of building, and knows nothing of practical construction, engineering and costs. These people tend to credit the contractor with the planning and method of construction as well as costs, to the depreciation of the architect's proper place in the building industry. It seems natural for a person to assume that the organization handling the money, which the contractor does on a building project, is the most important.

"We have mass inhibitions to overcome, as far as the public is concerned, and the architect's themselves must shoulder the tremendous job of molding desirable public opinion regarding architects. This can be done through such talks as this, articles in popular magazines, circulars (such as the A. I. A.), radio talks, etc. We have much discussion and many thought-provoking articles regarding the architect's status, in our professional publications and let us hope that these are prologues to action by the architects themselves, but this material does not fall in the hands of the public. Even if it did, much of it is not designed for public consumption, and its effects upon the public might or might not be beneficial.

"We must convince the public that we are honest, hard working, practical men with exceptional knowledge, ability, and experience in the designing, construction and economics of building; that we have a service to sell which is indispensable to those who are considering building.

"In my opinion it would be very helpful to architects who wish to help carry on an educational program, to have a bureau or department in the Michigan Society which would act as a central source for materials for movies, models and other interesting items."

CREDIT WHERE DUE

In the work of Henry Newton and J. Earl Trudeau, illustrated in Architect and Engineer in the February issue, were interiors of All Souls Church, Alhambra, including a detail of the beautiful altar and its furniture. The architect's names appeared as designers of the edifice but no credit was given the designer of the altar and furniture, Miss E. C. Fortune of the Monterey Guild, Monterey. It seems Miss Fortune executed the work under direct contract with the church and she therefore is entitled to credit for her splendid efforts.

ARCHITECTS HEAR ART TALK

Scripps College at Claremont acted as hosts to 70 members of Southern California Chapter, A. I. A., on March 12. Following dinner, the members visited the many interesting departments of Scripps art school.

Millard Sheets, head of the art school, welcomed the guests and told them something of the work that is being done there. Albert Stewart, sculptor and a member of Scripps faculty talked informally on sculpturing and the relationship between it and architecture.

The following were certified by the president as qualified to act as delegates to the Institute Convention in Louisville next month:

S. B. Marston, Ben H. O'Connor, Harold C. Chambers, Earl T. Heitschmidt, Palmer Sabin, Sumner Spaulding, Eugene Weston, Jr., Pierpont Davis, Samuel E. Lunden, David C. Allison, Charles O. Matcham, David J. Witmer, Wm. H. Harrison, A. M. Edelman.

CONTRACTORS' LICENSE BOARD

Three appointments on the California Contractors' State License Board were made in February by Governor Culbert L. Olson. They were J. Philip Murphy, Floyd B. Layne and Jess B. Worthington. Mr. Murphy, an engineering contractor, succeeds Clarence B. Eaton, while Mr. Layne of Los Angeles, succeeds Hugh W. McNulty of Fresno, and Mr. Worthington of San Diego, replaces Stephen L. Ford of Long Beach.

SCHOOL BUILDING ADDITION

The office of Stanton Willard, Bakersfield, has been commissioned to prepare plans and specifications for a ten class room addition to the school building of the Beardsley School District, Kern County. A bond issue of \$95,000 has been approved. Plans should be ready for bids by June 15.

CITY PLANNING CONFERENCE

The National Conference on Planning will be held in San Francisco this year from July 8th to 11th with headquarters at the Fairmont Hotel. Participating organizations will include the American Institute of Planners, American Planning and Civic Association, American Society of Planning Officials and National Economic and Social Planning Association.

STATE BOARD APPOINTEES

Governor Olson has reappointed Frederick H. Reimers and Warren C. Perry to the California State Board of Architectural Examiners, northern section. Winsor Soule of Santa Barbara is a new member of the board from the southern section. He succeeds G. Stanley Wilson of Riverside.

UNIFICATION OF ARCHITECTURAL PROFESSION

A comprehensive program for the unification of the architectural profession will be submitted for adoption by the American Institute of Architects at the Institute's seventy-second convention in Louisville, Ky., next month.

Amendments to the by-laws of the Institute have been prepared by a committee of the Institute's Board of Directors, consisting of Frederic A. Fletcher of Baltimore, chairman of the committee on state organization; Clair W. Ditchy of Detroit, chairman of the committee on unification, and Charles T. Ingham of Pittsburgh, secretary of the Institute.

"If the recommended by-law changes are adopted, the profession will at last possess the machinery necessary to bring all practicing architects together in one national organization without working injury to the old, well-established and well-tried organization and procedures of the Institute and yet preserve the state association member as an entity within its own particular territory," says a statement by Mr. Fletcher.

KINLEY MEMORIAL FELLOWSHIP

By authority of the Board of Trustees of the University of Illinois, the committee in charge announces the ninth annual consideration of candidates for the Kate Neal Kinley Memorial Fellowship.

This fellowship was established in 1931 to promote advanced study in the Fine Arts, in memory of the wife of a former president of the university and in recognition of her influence in promoting these and similar interests.

The fellowship yields the sum of one thousand dollars which is to be used by the recipient toward defraying the expenses of a year's advanced study of the fine arts in America or abroad.

Applications should reach the committee not later than May 15. Requests for application blanks and instructions should be addressed to Dean Rexford Newcomb, College of Fine and Applied Arts, Room 110, Architecture Building, University of Illinois.

PERSONALS

Glenn C. McAlister has moved to Ocean Avenue and Adelaide, Santa Monica. He will be pleased to receive catalogs and literature from the trade.

H. A. Schirmer, formerly works engineer for the Bethlehem Steel Co. at Alameda, has been appointed district engineer with offices at the Alameda Works of the Bethlehem Steel Company.

Timothy L. Pflueger, architect, has been reelected president of the San Francisco Art Association. An added honor for Mr. Pflueger is his appointment to direct the destiny of the Fine Arts Building at the G. G. I. E. this year.

700 FRAME DWELLINGS

Plans for 700 frame houses to be erected on Yesler Hill by the Seattle Housing Authority, 711 Second Avenue, will soon be completed, according to the Housing Authority office. The drawings are being made under the direction of an architectural board consisting of J. Lister Holmes, John T. Jacobsen, William J. Bain, George Wellington Stoddard and William Aitken.

MODERNIZED PRODUCTS

Brief Notes on New Materials and Equipment in the Building Industry.

362. YOUR HOME

United States Gypsum Company have put out a very complete booklet consisting of 116 pages, "a guide to comfort, security and economy." The title of this booklet is "How To Have The Home You Want." There are details, sketches and illustrations and a complete index. This is one of the finest pieces of information to be received by this department. Send for your copy by using the coupon below.

363. FLUSH VALVES

A new brochure on silent action flush valves has been issued by the Imperial Brass Manufacturing Company. It is fully descriptive and illustrated. A table on the back page gives details for specifying and ordering.

364. ARTIFICIAL LIGHT

"Light In The Home," another of the interesting booklets put out by Pacific Coast Electrical Bureau, has been received. These booklets are always well arranged and contain vital information on the subject of proper and harmonious lighting for homes. Send for a copy—use the coupon.

365. PROPELLER FAN

A broadside issued by the Auto-Vent Fan and Blower Company describes this company's new Coolvent Propeller Fan, a system for the ventilation and comfort cooling of residences. Full details are given.

366. ENAMEL FINISH

An attractive booklet, "The Finish On Your Product," by the Ferro Enamel Corporation, gives facts and details about ferro enamel, its uses and application, with a table showing the comparative performances of commercial finishes. The coupon below will insure you of a copy.

367. INSULATION

Another of those excellent booklets by the Celotex Corporation, this one giving sixteen pages of information on this company's insulating materials.

368. SOUND CONTROL

A new booklet, "Sound Control," giving the pertinent facts on Noise Quieting, Vibration Isolation and Acoustical Correction has been received from the Johns-Manville Corporation. Use of the coupon will bring your copy.

369. FIREPROOFING

Partition tile and fireproofing by the use of gypsum are detailed in a booklet issued by the Gypsum Association. Here are included the essential features of these materials; tests, opinions, costs and specifications.

370. WATERPROOFING

Ranetite Manufacturing Company have issued a little folder describing one of their important products—a transparent waterproof coating for brick, stone, and stucco walls. Send for a copy by using the coupon below.

371. INTERIORS

"A Short Course In Interior Decoration" is a beautifully detailed booklet put out by the makers of Luminal Paint, the National Chemical and Manufacturing Company. All in color and with a complete chart, this is one of the most attractive pieces of literature we have received. Send for your copy.

372. NICKEL

Another number of "Inco," the illustrated booklet issued by the International Nickel Company. These booklets have a great deal of interesting information on the various uses and recent installations of nickel materials.

373. FANS

A new booklet on Fans by the Emerson Electric Company. This is their fifteenth anniversary booklet and is very well gotten up with plenty of interesting data. The coupon will bring a copy—it is there for your use.

374. SPRAY PAINTING

A very interesting booklet, the "ABC" of spray painting equipment, is by the DeVilbiss Company. Contains technical details of value. Send direct to the company, mentioning Architect and Engineer, and enclose twenty-five cents. Address: DeVilbiss Company, Toledo, Ohio.

375. BRASS GOODS

H. B. Sherman Company have issued a brochure on plumbing and brass goods. It is in the form of a catalog and gives full details with prices and index. Use the coupon, it is for your convenience.

376. SHOWER DOORS

Data has been issued by Stainless Metal Products on glass shower doors and all-glass showers which gives the details, specifications and has illustrations showing installations of the various types manufactured by this company. Also included in the materials are "Receptors," the happy solution to shower flooring problems. Send for your copy by using the handy coupon below.

377. FIREPLACES

All you want to know about them—large and small, plain and ornate, indoor, outdoor—a booklet named "Superior Fireplaces," available at practically no cost. The book contains many beautiful illustrations, scale drawings and some extremely helpful suggestions for those who contemplate building a new fireplace or remodeling an old one. Fill out the coupon.

FREE FOR THE ASKING

Check items on coupon, paste on letter head or postal card, and mail to Architect and Engineer.

Architect and Engineer
68 Post Street
San Francisco, Calif.

Please send me literature on the items as checked below. This places me under no obligation.

<input type="checkbox"/>	362	<input type="checkbox"/>	370
<input type="checkbox"/>	363	<input type="checkbox"/>	371
<input type="checkbox"/>	364	<input type="checkbox"/>	372
<input type="checkbox"/>	365	<input type="checkbox"/>	373
<input type="checkbox"/>	366	<input type="checkbox"/>	374
<input type="checkbox"/>	367	<input type="checkbox"/>	375
<input type="checkbox"/>	368	<input type="checkbox"/>	376
<input type="checkbox"/>	369	<input type="checkbox"/>	377

My Name

Name of Company.....

Street.....

City..... State.....

Estimator's Guide

Giving Cost of Building Materials, Wage Scale, Etc.

Amounts given are figuring prices and are made up from average quotations furnished by material houses to San Francisco contractors. 3% Sales Tax on all materials but not labor.

All prices and wages quoted are for San Francisco and the Bay District. There may be slight fluctuation of prices in the interior and southern part of the state. Freight cartage, at least, must be added in figuring country work.

Bond—1½% amount of contract.

Brickwork—

Common, \$40 to \$45 per 1000 laid, (according to class of work).
 Face, \$90 to \$100 per 1000 laid, (according to class of work).
 Brick Steps, using pressed brick, \$1.00 lin. ft.
 Brick Veneer on frame buildings, \$0.70 sq. ft.
 Common f.o.b. cars, \$14.00 at yard. Cartage extra.
 Face, f.o.b. cars, \$45.00 to \$50.00 per 1000, carload lots.

HOLLOW TILE FIREPROOFING (f.o.b. job)

3x12x12 in. \$ 84.00 per M
 4x12x12 in. 94.50 per M
 6x12x12 in. 126.00 per M

Building Paper—

1 ply per 1000 ft. roll \$3.50
 2 ply per 1000 ft. roll 5.00
 3 ply per 1000 ft. roll 6.25
 Sisakraft, 500 ft. roll 5.00
 Sash cord com. No. 7 \$1.20 per 100 ft.
 Sash cord com. No. 8 1.50 per 100 ft.
 Sash cord spot No. 7 1.90 per 100 ft.
 Sash cord spot No. 8 2.25 per 100 ft.
 Sash weights, cast iron, \$50.00 ton.
 Nails, \$3.50 base.
 Sash weights, \$45 per ton.

Concrete Aggregates—

Gravel (all sizes) \$1.45 per ton at bunker; delivered to any point in S. F. County \$1.85.
 Bunker Delivered
 Top sand \$1.45 \$1.85
 Concrete mix 1.45 1.85
 Crushed rock, ¼ to ¾ 1.60 2.00
 Crushed rock, ¾ to 1½ 1.60 2.00
 Roofing gravel 1.60 2.00
 City gravel 1.45 1.85
 River sand 1.50 1.90
 Delivered bank sand—\$1.00 per cubic yard at bunker or delivered.

SAND— Bunker Delivered
 River sand \$1.50 \$1.90
 Lapis (Nos. 2 & 4) 2.00 2.40
 Olympia Nos. 1 & 2 1.80 2.20
 Haaldsburg plaster sand \$1.80 and \$2.20
 Del Monte white 50c per sack

CEMENT (all brands, common, cloth sacks) \$2.72 per bbl. f.o.b. car; deliv. \$2.90 per bbl., carload lots; less than carload lots, warehouse or deliv., 80c per sack. (Less 10c per sack returned, 2% 10th Prox.)

Common cement (all brands, paper sacks) carload lots \$2.52 per bbl. f.o.b. car; delivered, \$2.70; less than carloads delivered, 75c per sack. Discount on cloth sacks, 10c per sack. Cash discount on carload lots, 10c a barrel, 10th Prox.; cash discount less than carload lots, 2%.

Atlas White } 1 to 100 sacks, \$2.00 sack,
 Calaveras White } warehouse or delivery;
 Medusa White }

Forms, Labors average \$40.00 per M.
 Average cost of concrete in place, exclusive of forms, 35c per cu. ft.; with forms, 60c.
 4-inch concrete basement floor 12½c to 14c per sq. ft.
 Rat-proofing 7½c
 Concrete Steps \$1.25 per lin. ft.

Dampproofing and Waterproofing—

Two-coat work, 20c per yard.
 Membrane waterproofing—4 layers of saturated felt, \$4.50 per square.
 Hot coating work, \$1.80 per square.
 Medusa Waterproofing, 15c per lb., San Francisco Warehouse.
 Tricoat waterproofing.
 (See representative.)

Electric Wiring—\$12.00 to \$15.00 per outlet for conduit work (including switches).
 Knob and tube average \$3.50 per outlet.

Elevators—

Prices vary according to capacity, speed and type. Consult elevator companies.
 Average cost of installing an automatic elevator in four-story building, \$2800; direct automatic, about \$2700.

Excavation—

Sand, 60 cents; clay or shale \$1 per yard.
 Teams, \$12.00 per day.
 Trucks, \$22 to \$27.50 per day.

Above figures are an average without water. Steam shovel work in large quantities, less; hard material, such as rock, will run considerably more.

Fire Escapes—

Ten-foot galvanized iron balcony, with stairs, \$115 installed on new buildings; \$140 on old buildings.

Floors—

Composition Floors—22c to 40c per sq. ft. In large quantities, 16c per sq. ft. laid.
 Mosaic Floors—80c per sq. ft.
 Dureflex Floor—23c to 30c sq. ft.
 Rubber Tile—50c to 75c per sq. ft.
 Terazzo Floors—45c to 60c per sq. ft.
 Terazzo Steps—\$1.60 lin. ft.

Hardwood Flooring (delivered to building)—

	1½x2¼" T&G	¾x2" T&G	¾x2" Sq.Ed.
Clr. Qtd. Oak	\$144.00 M	\$122.00 M	\$141.00 M
Sel. Qtd. Oak	118.00 M	101.00 M	114.00 M
Clr. Pla. Oak	120.00 M	102.00 M	115.00 M
Sel. Pla. Oak	113.00 M	92.00 M	107.00 M
Clr. Maple	125.00 M	113.00 M	

Wage—Floor layers, \$10.00.
 Note—Above quotations are all board measure except last column which is sq. ft.

Glass (consult with manufacturers)—

Double strength window glass, 20c per square foot.
 Plate 75c per square foot (unglazed) in place, \$1.00.
 Art, \$1.00 up per square foot.
 Wire (for skylights), 40c per sq. foot.
 Obscure glass, 30c to 50c square foot.
 Glass bricks, \$2.40 per sq. ft., in place.
 Note—If not stipulated add extra for setting.

Heating—

Average, \$1.90 per sq. ft. of radiation, according to conditions.
 Warm air (gravity) average \$48 per register.
 Forced air, average \$68 per register.

Iron—Cost of ornamental iron, cast iron, etc., depends on designs.

Lumber (prices delivered to diag. site)

No. 1 common \$30.00 per M
 No. 2 common 28.00 per M
 Select O. P. common 35.00 per M
 2x4 No. 3 form lumber 22.00 per M
 1x4 No. 2 flooring VG 58.00 per M
 1x4 No. 3 flooring VG 51.00 per M
 1x6 No. 2 flooring VG 70.00 per M
 1½x4 and 6, No. 2 flooring 70.00 per M

Slash grain—

1x4 No. 2 flooring \$45.00 per M
 1x4 No. 3 flooring 42.00 per M
 No. 1 common run T. & G. 33.00 per M
 Lath 5.50 per M

Shingles (add cartage to price quoted)—
 Redwood, No. 1 \$1.10 per bdle.
 Redwood, No. 2 1.00 per bdle.
 Red Cedar 1.10 per bdle.

Plywood—Douglas Fir (ad cartage)—

"Plyscord" sheathing (unsanded)
 5/16" 3-ply and 48"x96" \$32.50 per M
 "Plywall" (wallboard grade)—
 1/4" 3-ply 48"x96" \$37.50 per M
 "Plyform" (concrete form grade)—
 5/8" 5-ply 48"x96" \$110.00 per M
 Exterior Plywood Siding—
 7/16" 5-ply Fir \$ 90.00 per M
 Redwood (Rustic) 85.00 per M

Milwork—Standard.

O. P. \$85.00 per 1000. R. W., \$100.00 per 1000 (delivered).
 Double hung box window frames, average, with trim, \$6.50 and up, each.
 Doors, including trim (single panel, 1¾ in. Oregon pine) \$8.00 and up, each.
 Doors, including trim (five panel, 1¾ in. Oregon pine) \$6.00 each.
 Screen doors, \$3.50 each.
 Patent screen windows, 25c a sq. ft.
 Casos for kitchen pantries seven ft. high, per lineal ft., \$8.00 each.
 Dining room cases, \$8.00 per lineal foot.
 Rough and finish about 75c per sq. ft.
 Labor—Rough carpentry, warehouse heavy framing (average), \$17.50 per M.
 For smaller work average, \$35.00 to \$45.00 per 1000.

Marble—(See Dealers)

Painting—

Two-coat work	per yard	42c
Three-coat work	per yard	60c
Cold water painting.....	per yard	10c
Whitewashing	per yard	4c
Turpentine, 65c per gal., in 5 gal. cans, and 55c per gal. in drums.		
Raw Linseed Oil—95c gal. in light drums.		
Boiled Linseed Oil—98c gal. in drums and \$1.08 in 5 gal. cans.		

White Lead in oil

1 ton lots, 100 lbs. net weight.....	Per lb.	13 1/4c
500 lbs. and less than 1 ton.....		12c
Less than 500 lb. lots.....		12 1/2c

Red Lead and litharge

1 ton lots, 100 lbs. net weight.....	Per lb.	13 1/4c
500 lbs. and less than 1 ton.....		12c
Less than 500 lb. lots.....		12 1/2c

Red Lead in oil

1 ton lots, 100 lbs. net weight.....	Per lb.	12 3/4c
500 lbs. and less than 1 ton.....		13c
Less than 500 lb. lots.....		13 1/2c

Note—Accessibility and conditions cause some variance in costs.

Patent Chimneys—

6-inch	\$1.25	lineal foot
8-inch	1.75	lineal foot
10-inch	2.25	lineal foot
12-inch	3.00	lineal foot

Plastering—Interior—

1 coat, brown mortar only, wood lath	Yard	\$0.50
2 coats, lime mortar hard finish, wood lath85
2 coats, hard wall plaster, wood lath.....		.72
3 coats, metal lath and plaster.....		1.25
Keene cement on metal lath.....		1.30
Ceilings with 3/4 hot roll channels metal lath (lathed only).....		.90
Ceilings with 3/4 hot roll channels metal lath plastered.....		1.80
Single partition 3/4 channel lath 1 side (lath only).....		.85

Single partition 3/4 channel lath 2 inches thick plastered.....	\$2.90
4-inch double partition 3/4 channel lath 2 sides (lath only).....	1.70
4-inch double partition 3/4 channel lath 2 sides plastered.....	3.30
Thermax single partitions: 1" channels; 2 1/4" overall partition width. Plastered both sides.....	2.50
Thermax double partition: 1" channels; 4 1/4" overall partition width. Plastered both sides.....	3.40
3 coats over 1" Thermax nailed to one side wood studs or joists.....	1.25
3 coats over 1" Thermax suspended to one side wood studs with spring sound isolation clip.....	1.45

Plastering—Exterior—	Yard
2 coats cement finish, brick or concrete.....	\$1.00
3 coats cement finish, No. 18 gauge wire mesh.....	1.50
Wood lath, \$5.50 to \$6.50 per 1000.....	
2.5-lb. metal lath (dipped).....	.19
2.5-lb. metal lath (galvanized).....	.21
3.4-lb. metal lath (dipped).....	.22
3.4-lb. metal lath (galvanized).....	.24
3/4-inch hot roll channels, \$72 per ton.....	
Finish plaster, \$18.90 ton; in paper sacks.....	
Dealer's commission, \$1.00 off above quotations. \$13.85 (rebate 10c sack).....	
Lime, f.o.b. warehouse, \$2.25 bbl.; cars, \$2.15.....	
Lime, bulk (ton 2000 lbs.), \$1.00 ton.....	
Wall Board 5 ply, \$50.00 per M.....	
Hydrate Lime, \$19.50 ton.....	
Plasterers Wage Scale.....	\$1.67 per hour
Lathers Wage Scale.....	1.60 per hour
Head Carriers Wage Scale.....	1.40 per hour
Composition Stucco—\$1.80 to \$2.00 sq. yard (applied).....	

Plumbing—
From \$70.00 per fixture up, according to grade, quantity and runs.

Roofing—
"Standard" tar and gravel, \$6.00 per sq. for 30 sqs. or over.
Less than 30 sqs. \$6.50 per sq.
Tile, \$20.00 to \$35.00 per square.
Redwood Shingles, \$7.50 per square in place.
Copper, \$16.50 to \$18.00 per sq. in place.
Cedar Shingles, \$8.00 per sq. in place.
Re-coat with Gravel, \$3 per sq.
Asbestos Shingles, \$15 to \$25 per sq laid.

Slate, from \$25.00 per sq., according to color and thickness.....	
Shakes—1x25" resawn.....	\$11.50 per sq.
1/2x25" resawn.....	10.50 per sq.
1/2x25" tapered.....	10.00 per sq.
Above prices are for shakes in place.	

Sheet Metal—

Windows—Metal \$1.75, a sq. foot.
Fire doors (average), including hardware \$1.75 per sq. ft.

Skylights—(not glazed)

Copper, 90c sq. ft. (flat).
Galvanized iron, 30c sq. ft. (flat).
Vented hip skylights 60c sq. ft.

Steel—Structural

\$120 ton (erected), this quotation is an average for comparatively small quantities. Light truss work higher. Plain beams and column work in large quantities \$97 to \$105 per ton.

Steel Reinforcing—

\$80.00 to \$120.00 per ton, set.

Stone—

Granite, average, \$6.50 cu. foot in place
Sandstone, average Blue, \$4.00. Boise \$3.00 sq. ft. in place.
Indiana Limestone, \$2.80 per sq. ft. in place.

Store Fronts—

Copper sash bars for store fronts, corner center and around sides, will average 75c per lineal foot.
Note—Consult with agents.

Tile—Floor, Wainscot, etc.— (See Dealers)
Asphalt Tile—18c to 28c per sq. ft. installed.

Wall Tile—

Glazed Terra Cotta Wall Units (single faced) laid in place—approximate prices:
2 x 6 x 12..... \$1.00 sq. ft.
4 x 6 x 12..... 1.15 sq. ft.
2 x 8 x 16..... 1.10 sq. ft.
4 x 8 x 16..... 1.30 sq. ft.

Venetian Blinds—

40c per square foot and up. Installation extra.

THE BUILDERS' EXCHANGE OF SAN FRANCISCO STANDARD WAGE SCALE

For mechanics employed on construction work in the Bay Region. Effective September 1, 1937

CRAFT	Journeymen	Mechanics
Asbestos Workers.....	\$ 8.00	
Bricklayers (6h-5d).....	10.50	
Bricklayers' Hodcarriers (6h-5d).....	6.75	
Cabinet Workers (Outside) (5d).....	8.00	
Caisson Workers (Open).....	6.40	
Carpenters (8h-5d).....	10.00	
Cement Finishers (8h-5d).....	10.00	
Cork Insulation Workers (8h-5d).....	9.00	
Electric Workers (8h-5d).....	11.00	
Electrical Fixture Hangers.....	8.00	
Elevator Constructors.....	10.40	
Engineers, Portable & Hoisting.....	9.00	
Glass Workers (8h-5d).....	9.68	
Hardwood Floormen.....	9.00	
Housemiths, Architectural Iron (Shop) (8h-5d).....	9.00	
Housemiths, Architectural Iron (Outside) (8h-5d).....	10.00	
Housemiths, Reinforced Concrete or Rod-men (8h-5d).....	10.00	
Iron Workers (Bridge and Structural) Including Engineers (8h-5d).....	12.00	

CRAFT	Journeymen	Mechanics
Laborer, Building (8h-5d).....	\$ 6.00	
Laborers, Common (8h-5d).....	6.00	
Lathers, Channel Iron (6h-5d).....	9.00	
Lathers, All Others.....	9.00	
Marble Setters (8h-5d).....	10.50	
Marble Setters' Helpers (8h-5d).....	6.50	
Milwrights.....	9.00	
Model Makers (\$1.50 per hr-6h).....	9.00	
Modelers (\$2 per hr-6h).....	12.00	
Model Casters.....	7.20	
Mosaic and Tarrazzo Workers (Outside).....	9.00	
Painters (7h-5d).....	8.75	
Painters, Varnishers and Polishers (Outside).....	8.75	
Pile Drivers and Wharf Builders.....	9.00	
File Drivers' Engineers.....	10.00	
Plasterers (6h-5d).....	10.00	
Plasterers' Hodcarriers (6h-5d).....	7.50	
Plumbers (8h-5d).....	11.00	
Roofers, Composition (8h-5d).....	9.00	
Roofers, All Others (8h-5d).....	8.00	
Sheet Metal Workers (8h-5d).....	10.00	
Sprinkler Fitters.....	10.00	

CRAFT	Journeymen	Mechanics
Steam Fitters (8h-5d).....	\$11.00	
Steel Builders (8h-5d).....	9.00	
Stone Cutters, Soft and Granite (8h-5d).....	8.00	
Stone Setters, Soft and Granite.....	12.00	
Stone Derricemen.....	9.00	
Tile Setters (8h-5d).....	11.00	
Tile Setters' Helpers (8h-5d).....	6.50	
Tile, Cork and Rubber (8h-5d).....	9.00	
Welders, Structural Steel Frame on Buildings.....	11.00	
Welders, All Others on Buildings.....	9.00	
Dump Truck Drivers, 2 yards or less.....	6.00	
Dump Truck Drivers, 3 yards.....	6.50	
Dump Truck Drivers, 4 yards.....	7.00	
Dump Truck Drivers, 5 yards.....	7.00	
Dump Truck Drivers, 6 yards.....	7.50	
Truck Drivers of Concrete Mixer Trucks:		
2 yards or less.....	6.50	
3 yards.....	7.00	
4 yards.....	7.50	
5 yards.....	7.50	
6 yards.....	8.00	

GENERAL WORKING CONDITIONS

- Eight hours shall constitute a day's work for all crafts except as otherwise noted.
- Plasterers' Hodcarriers, Bricklayers' Hodcarriers, Roofers, Laborers, and Engineers, Portable and Hoisting, shall start 15 minutes before other workmen, both at morning and at noon.
- Five days, consisting of not more than eight hours a day, on Monday to Friday inclusive, shall constitute a week's work.
- Transportation costs in excess of twenty-five cents each way shall be paid by the contractor.
- Overtime shall be paid as follows: For the first four hours after the first eight hours, time and one-half. All time thereafter shall be paid

- double time. Saturdays (except Laborers), Sundays and holidays, from 12 midnight of the preceding day, shall be paid double time.
- On Saturday, Laborers shall be paid straight time for an eight-hour day.
- Where two shifts are worked in any twenty-four hours, shift time shall be straight time. Where three shifts are worked, eight hours' pay shall be paid for seven hours on the second and third shifts, allowing one-half hour for lunch.
- All work, except as noted in paragraph 9, shall be performed between the hours of 8 a.m. and 5 p.m.
- In emergencies, or where premises cannot be vacated until the close of business, men then

- reporting for work shall work at straight time. Any work performed on such jobs after midnight shall be paid time and one-half up to four hours of overtime and double time thereafter, provided, that if a new crew is employed on Saturdays, Sundays or holidays which has not worked during the five preceding days, such crew shall be paid time and one-half.
- Recognized holidays to be: New Year's Day, Decoration Day, Fourth of July, Labor Day, Admission Day, Thanksgiving Day, Christmas Day.
- Men ordered to report for work, for whom no employment is provided, shall be entitled to two hours' pay.

INSULITE COMPANY EXPANSION

WITH the advent of a tremendous building market, the Insulite Company inaugurated an extensive sales expansion program on the West Coast, effective April 1. To expedite service to building material dealers and jobbers in the far west, a number of direct sales representatives have been added to Insulite's Pacific Coast staff. They will be stationed at key points in five western states — California, Oregon, Washington, Idaho and Nevada.



L. C. MONAHAN

The proposed plans for enlarging and expanding Insulite's sales organization were submitted by L. C. Monahan, Pacific district manager for Insulite, and approved by E. W. Morrill, vice president and sales manager, on a recent trip to the coast.

"The tremendous acceptance of Insulite's new line of materials, plus the desire to give closer service to our customers in the West Coast area, are the compelling reasons behind this expansion of our sales activities," said Mr. Morrill.

The new plans include the establishment of offices for the West Coast operations at 604 Mission street, San Francisco.

A Stanford man and a veteran in the building industry, L. C. Monahan is widely known throughout the Pacific Coast. He was for many years closely associated with Herbert Hoover in the United States Department of Commerce.

Under Mr. Monahan's direction, a number of experienced insulation salesmen have been added to the Pacific district staff. The expanded organization as now



California's Hotel Beautiful

- like a country estate yet in the heart of a throbbing metropolitan area.
- a matchless view—comfortable, luxuriously furnished rooms, excellent cuisine.
- in an atmosphere of quiet and gracious living.

Rooms, with bath, \$2.50 to \$5.00 per day.

Attractive monthly rates

HOTEL CLAREMONT · BERKELEY

STREAM-LINED DIRECT-AIR FIRED AIR CONDITIONER

AEROLUX

**Equipped with
Johnson BH-O "Bankheat"
Pressure Type Oil Burner**

Finished in baked enamel of 2-tone green, rounded corners, all working parts completely enclosed. Designed for highest capacity in a minimum of space with a large amount of heating surface which insures highest over-all efficiency.

Air is filtered, warmed and humidified, then forced to various rooms by twin blower fans driven by direct-connected multi-speed motor. Fan motor is automatically controlled by temperature control.

The AEROLUX is only one unit of a complete line of Oil Burners and Heating, Ventilating and Air Conditioning products for domestic, commercial and industrial use produced by this pioneer manufacturer.

S.T. JOHNSON CO.

940 ARLINGTON, OAKLAND, CALIFORNIA
401 N. BROAD STREET, PHILADELPHIA, PA.



To ARCHITECTS
AND ENGINEERS —

*We offer twenty years experience
in the successful installation of
acoustical and sound control
materials.*

WESTERN ASBESTOS CO.

Building Materials
SACRAMENTO

Mechanical Specialties
OAKLAND
SAN FRANCISCO

POMONA TILES

FOR
Bathrooms and Kitchens
in over 60 colors

Warehouses and Display Rooms

135 Tenth St. San Francisco
629-33 North La Brea Ave. Los Angeles
6106 Roosevelt Way Seattle

POMONA TILE MFG. CO.
PLANT — POMONA, CALIF.

STRUCTURAL STEEL

For Class A Buildings,
Bridges, etc.

JUDSON PACIFIC CO.

1200 SEVENTEENTH STREET
SAN FRANCISCO

Plants: San Francisco - Oakland

A Permanent Exposition
of the newest ideas
in home planning
and equipment.



THE BUILDING MATERIAL EXHIBIT

Architesta Bldg. • Filth & Figueroa • Los Angeles • MU-6306

constituted includes, W. G. Crawford, with headquarters at Seattle; L. M. Griffin, Portland; M. C. Cruse and E. W. Shaw, San Francisco; D. W. Gilfillan, Los Angeles; Mark S. Bailey, San Diego, and E. D. Griffith, who has been appointed as architect's representative, serving the entire Pacific Coast.

The group averages more than ten years' active experience in the sale of insulation and hardboard products in the territory to which each man has been assigned. Additional appointments covering inland territories will be announced shortly.

Eight new materials recently announced by Insulite in its 1940 program, include pre-decorated, washable interior finish materials and two low density insulation tile boards for sound quieting.

The company has its plant at International Falls in northern Minnesota and also maintains a large plant in Finland, which until recently, had served the entire European countries. War developments in Finland have made it necessary to shift the entire export department of the Insulite Company to Minneapolis, where the sales of some 90 export outlets in South Africa, England, Mexico, South America and other parts of the world are now handled. A number of Pacific Coast ports also will serve as export outlets for Insulite products under the new plan.

COLOR GALORE AT THE 1940 FAIR

Color, warm, exotic, living, comes into its own at the Golden Gate International Exposition which opens on Treasure Island in San Francisco bay May 25.

Every hue of the spectrum, from the dazzling reds and yellows to the calm greens and blues, has been called on to play a part in the gay kaleidoscope of radiance which will burst forth with the opening of the Fair.

"Day and night, Treasure Island will present a completely new picture," declared Jesse Stanton, color architect. "The color of the Exposition this year will be set at a far higher key. It will be something to talk about, something to long remember."

Science has delved into the mysteries of black light and at the Exposition substances which have seemed drab and commonplace to the eye turn into opalescent seas of iridescence, with diamond facets that sparkle and gleam and broad bands that glow like coral beds in crystal waters.

The Exposition buildings, walls and columns and towers, turn with the night into enchanted palaces. Aladdin lamps shine through the tangle of shrubbery and fluorescent lights flood the backgrounds with a glareless glow that bathes court and esplanade, sculptured arch and dome.

SPRING GARDEN SHOW

Oakland's annual spring garden show will be held in the usual place, commencing with a preview the night of April 30 and continuing four days.



QUALITY AND DEPENDABLE *Service*

are the factors that influence architects and contractors when selecting lumber and mill work — Quality of merchandise — Integrity and Ability of the firm—Service in physical equipment — Experience and Personnel — All these factors contribute to a speedy and satisfactory completion of construction with minimum of time and expense.

MANUFACTURER OR DEALER IN

Douglas Fir—Redwood—Sugar and Ponderosa Pine — Plywood and Concrete Form Panels — Sash and Doors — Millwork — Insulation — Builders' Hardware.

E. K. WOOD LUMBER CO.

"Goods of the Woods" ©

LOS ANGELES • SAN FRANCISCO • OAKLAND

No Worry for the Architect

"—All acid proof drain pipe and fittings shall be ferro-silicon—CORROSIRON—"

(Write for above specification)



FEDERAL BUILDING • CIVIC CENTER • SAN FRANCISCO

Arthur Brown, Jr., Architect

CORROSIRON DRAIN LINES and FITTINGS and LABORATORY EQUIPMENT was specified because of its superior resistance to corrosion and wear.

Pacific Foundry Company, Ltd.

NEW YORK • 3100 NINETEENTH ST., SAN FRANCISCO • LOS ANGELES

BAXCO

CHROMATED ZINC CHLORIDE

CZC

PRESSURE TREATED LUMBER
● **PROTECTS AGAINST DECAY AND TERMITE ATTACK**

*Specify it in your home
Available through Lumber Dealers*

LOS ANGELES
601 W. 5th Street
Phone Michigan 6294

SAN FRANCISCO
333 Montgomery Street
Phone DOuglas 3883

J. H. Baxter & Co.

AGENTS FOR WEST COAST WOOD PRESERVING CO., SEATTLE, WASH.

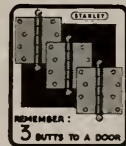
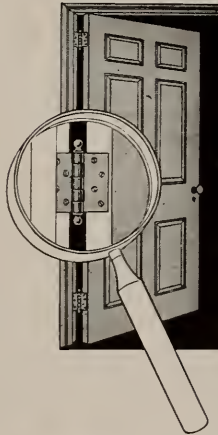

SATISFACTION

calls for the third butt—every time. It holds the door in line, preserves its appearance, keeps the lock working smoothly. Specify *Three Butts To A Door!* The Stanley Works, New Britain, Conn.

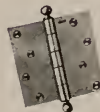

Stanley 241
Standard
of the World
for over
Fifty Years

STANLEY

TRADE MARK

HARDWARE FOR CAREFREE DOORS

*Easier
for You*
**BANKING
BY MAIL**

For your own convenience, why don't you use our Bank-by-Mail Service? It's the simplest and easiest way to handle most banking details for your business and yourself. Overnight service to most points in California, and always as handy as the nearest mailbox. We invite you to open an account with us today, by mail.

**CROCKER FIRST
NATIONAL BANK**
OF SAN FRANCISCO

California's Oldest National Bank
Member Federal Deposit Insurance Corporation

**Clinton
Construction Co.**
of California
*General
Contractors*

923 Folsom Street
San Francisco
SUtter 3440

**JOHN
CASSARETTO**

—Since 1886—And Still Active—

Building Materials

READY MIX CONCRETE
ROCK - SAND - GRAVEL - LIME
CEMENT - PLASTER - MORTAR
METAL LATH - WOOD LATH
STUCCO - WIRE NETTING

Service Unexcelled

Bunkers
Sixth and Channel, San Francisco
Phones: GARfield 3176, GARfield 3177

**SHASTA DAM WILL
RELIEVE FLOOD DANGER**

The Sacramento River flood last month was a graphic and dramatic justification by nature of the multiple purpose Central Valley Project in California.

Walker R. Young, Supervising Engineer of the Project, informed John C. Page, Commissioner, Bureau of Reclamation, that "several million dollars of damage might have been prevented and some lives saved" in the catastrophe that did \$15,000,000 in damage and killed nine, had the Shasta Dam on the Sacramento River above Redding, key structure of the Project now under construction, been completed. The Government suffered no serious loss in its construction work, however.

The flood, which reached record heights in several localities, originated largely in the watershed of the Sacramento, Pit, and McCloud rivers above Shasta Dam. Reduction of floods is one of the principal objectives of Shasta Dam, the major structure of the Central Valley reclamation project.

Had Shasta Dam been completed and in operation, Mr. Young estimated 1,000,000 acre-feet of storage space would have been available when the flood hit. The plan for the dam contemplates reservation of 500,000 acre-feet of storage in the 4,500,000 acre-foot reservoir for floods, and the plan of operation would have made as much more available at the period of the year in which the flood came.

Preliminary estimates show that, had the dam been in operation in this instance, all damage could have been prevented in the vicinity of Redding, where losses amounted to \$400,000; and the record peak flow of 290,000 cubic feet per second at Red Bluff could have been reduced by half.

"Below Red Bluff it has been possible to estimate the dampening effect of Shasta Reservoir accurately without more detailed data," Mr. Young said. "It is believed, however, that the peak at Hamilton City, which is

Pitcher
DOOR SYSTEM

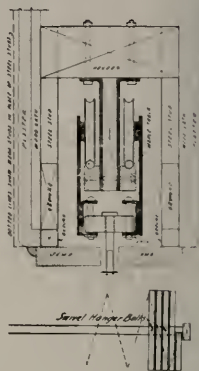

Includes Closet Doors, Interior Disappearing Doors, Exterior French and Screen Doors, Tandem Doors for Wide Openings, Sliding Partitions, Folding Doors, Garage Doors. Send for Details.

E. C. Pitcher Co.

557 Market St., San Francisco
Phone YUkon 1543

VAUGHN - G. E. WITT Co.

Manufacturers and Distributors

Pump Governors	Oil Heaters
Safety Pump Governors	Relief Valves
Automatic Gas Regulating Valves	Oil Burner Governors
Gas Burning Equipment	Oil Burners
Vacuum Pump Governors	Oil Pumping Sets
Vacuum Regulating Valves	Oil Valves
Continuous Flow Steam Traps	Oil and Steam Strainers
Thermostats	Duplex Oil Pumps
Reducing Valves	Rotary Oil Pumps
	Boiler Feed Pumps
	Water Heaters
	Boiler Feed-Water Regulators

4224-28 Hollis St., Emeryville, Oakland

**VERMONT
MARBLE
COMPANY**

Producers and Finishers
of

**Domestic and Imported
Marbles**

San Francisco
Los Angeles
and
Tacoma, Wash.

NEW JOBS AHEAD for architects

People are writing Kraftile by the hundreds for new ideas in kitchen and bathroom planning. Many of these prospects have commissioned no architect as yet. If you are interested in establishing contacts with such prospective builders, write for information on Kraftile's "New Jobs Ahead" plan. Address C. W. Kraft, Kraftile Kilns, Niles, Calif.



PRODUCTS

VAN ARSDALE-HARRIS CO.

ENGINEERS & CONTRACTORS

ACOUSTICAL TREATMENT
INSULATION
SOUND CONTROL

Fifth and Brannan Streets
San Francisco, Calif.

Telephone GARfield 3600

Division

VAN ARSDALE-HARRIS
LUMBER CO., INC.

FINE WATER COLORS
AND PAPERS
FOR ARCHITECTURAL
RENDERINGS

**H. S. CROCKER
COMPANY, Inc.**

720 MISSION STREET
MARKET STREET AT SECOND
SAN FRANCISCO

estimated to have approached 300,000 second-feet, would have been reduced substantially—perhaps to half its actual magnitude. Below Hamilton City the contributions of Stony Creek, Chico Creek, and local drainage appear to have caused a maximum peak somewhat in advance of the arrival of the flood crest from above.

"The regulatory effect of Shasta Dam in this locality would have tended to shorten the duration of the flood. Serious damage is attributable to the sustained nature of the flood flow as demonstrated by several levee failures which resulted from prolonged flood stages long after passage of the actual crest. It, therefore, is considered highly probable that a substantial reduction would have been effected in the general overflow in the upper valley, and that breaks in the levees of Reclamation District 70 near Meridian and Reclamation District 1660 south of Meridian, would have been altogether prevented by regulation at Shasta Dam.

"In the lower valley downstream from Tisdale Weir adequate control of the Sacramento River flood waters was afforded by the existing levee and bypass system."

Shasta Dam is the key structure of the Sacramento River phase of the great Central Valley project. Excavation for its foundation is nearly completed. There were no cofferdams in the river or other temporary structures, except construction bridges, to fail. The principal damage done to project works, apparently, was the settlement of one pier of the long railroad bridge at Redding. This bridge is one unit of the program to relocate the mainline of the Southern Pacific Railroad around the reservoir site. The bridge had not as yet been placed in use.

When the dam is completed and when other project works are in service, flood waters will not be wasted, but will be stored in large part for use in the dry summer and autumn.

INTERIOR FINISH and QUALITY MILLWORK

for

many of the fine buildings and beautiful homes, designed by John E. Dinwiddie, and illustrated in this number, by

**LANNOM BROS.
MFG. CO.**

Fifth and Magnolia Streets
Oakland, California

Telephone: TEmplebar 3663

Pacific Manufacturing Company

High Class Interior Finish
Quality Millwork

142 Sansome St. San Francisco GARfield 7755	6820 McKinley Ave. Los Angeles THornwall 4196
---	---

1315 Seventh Street, Oakland
GLEncourt 7850

Golden Gate Atlas
TRANSIT
MIX CONCRETE
AND MORTAR

**PACIFIC COAST
AGGREGATES, Inc.**

16th and Harrison Streets
85 Second Street San Francisco



CLIENTS will bless you for installing the Wesix "49'er" ELECTRIC BATHROOM HEATER. But try it first in your own home. Certain that you will like its forty-nine inches of INSTANT RADIANT HEAT and QUICK CIRCULATING HEAT, we are offering this smart new heater of factory cost to architects, for personal use! Limit one heater per architect. List price \$21.50. Please write on your regular letterhead, to: 1018 WESIX BLDG., SAN FRANCISCO

WESIX

WESIX ELECTRIC HEATER CO.

Phone GARfield 1164

Hunter & Hudson

Consulting Engineers

DESIGNERS OF HEATING
AIR CONDITIONING
VENTILATING AND WIRING
SYSTEMS, MECHANICAL
AND ELECTRICAL EQUIP-
MENT OF BUILDINGS

41 SUTTER STREET
ROOM 710

San Francisco California

Robert W. Hunt Company

ENGINEERS

Inspection - Tests - Consultation

Schools and Other Structures
Are Built as Designed

*When Construction Materials are
Inspected at point of Manufacture
and during Erection by*

ROBERT W. HUNT COMPANY

*Cement, Concrete, Chemical, Metallurgical,
X-Ray and Physical Laboratories*

Chicago - New York - Pittsburgh
Los Angeles - All Large Cities
San Francisco, 251 Kearny Street

A TRIBUTE TO RAYMOND M. HOOD

BEAUTIFICATION of the "ugly" city, declared to be the first artistic problem of America, awaits the greater participation of the architect in government. Charles D. Maginnis, past president of the American Institute of Architects, said in an address before the anniversary dinner of the Institute's New York Chapter. The commercial violation of landscapes he denounced as "a national scandal." New York, he held, can become the most beautiful city in the world.

The Medal of Honor of the Chapter was awarded posthumously to Raymond M. Hood, architect of Rockefeller Center and the Daily News and American Radiator Company Buildings, who died on August 14, 1934. "for distinguished work and high professional standing." Mr. Hood's son, Raymond M. Hood, Jr., received the medal from Frederick G. Frost, president of the Chapter. The dinner commemorated the eighty-third anniversary of the founding of the Institute in New York in February, 1857.

"Almost nowhere has opportunity yet been offered the architect to extend his skill to the whole organism," Mr. Maginnis pointed out. "In a day when the ugly and undisciplined city has become the first artistic problem of America, the enterprise of the architect is still limited to the unit of his community. We shall never have beautiful cities until the architect is given more responsible place in the official scheme.

"What the architect has contributed to the new arteries leading to New York is only an indication of the quality of his gift. One can now make his approach to New York as to almost no other American city without encountering acres of tin cans and blatant billboards and a general litter of neglected things. This is a self-consciousness worthy of a great municipality. Only the broadening of this solicitude is needed to fulfill the promise New York has always held of an unrivalled beauty among the cities of the world."

Mr. Maginnis, whose theme was "A Provincial Muses on the Metropolis," asserted his belief that "New York architecture is more intelligent than New York."

"Our civic culture is not to be vindicated by the excellence of our skyscrapers," he added. "Perhaps the Empire State and Radio City and Metropolitan Grand Opera have done us too much honor. It is obvious that art is now an interest which has no faculty over our communal emotions.

"In busy Florence of the Renaissance a new public sculpture excited the whole populace. Here, after a brief scrutiny, the effigy becomes an accepted and usually neglected item of the civic scene, occasionally to emerge into a fatal notoriety as some whimsical soul discovers a latent humor in it.

"Whether or not art is actually becoming less or only more inscrutable, I question if the high estate of our American architecture which is now arresting the world's attention

INCLUDE TREES IN YOUR PLANS

DAVEY, ORIGINATOR OF TREE SUR-
GERY, OFFERS FREE INSPECTION
AND ESTIMATE.



SAN FRANCISCO SUTter 3377
Russ Bldg.

FRESNO
Mattei Bldg.

LOS ANGELES TUcker 1929
Stary Bldg.

Local phones in: Pasadena, Palo Alto,
Oakland, San Rafael, San Mateo

**SKILL - KNOWLEDGE -
RESPONSIBILITY**

THE TORMEY COMPANY

GENERAL PAINTERS
AND DECORATORS

Phone UNDERhill 1913

563 FULTON STREET
San Francisco

Donovan Automatic Awning Type Windows

Give 100% natural ventilation
and day-lighting control

UNIVERSAL WINDOW
COMPANY
Berkeley, California

ILLUSTRATIONS OF SUPERIOR CONSTRUCTION

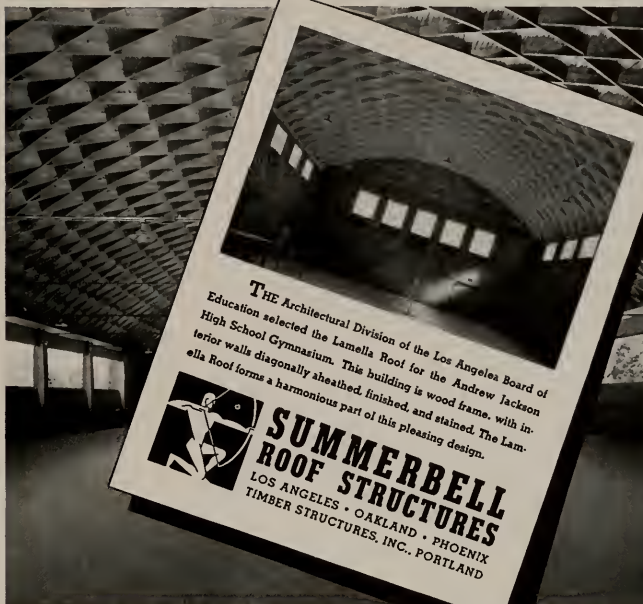

THE Architectural Division of the Los Angeles Board of Education selected the Lamella Roof for the Andrew Jackson High School Gymnasium. This building is wood frame, with interior walls diagonally sheathed, finished, and stained. The Lamella Roof forms a harmonious part of this pleasing design.



SUMMERBELL ROOF STRUCTURES
LOS ANGELES • OAKLAND • PHOENIX
TIMBER STRUCTURES, INC., PORTLAND

ROOFS OF WOOD—BUILT TO ENDURE

is the measure of our civilization, or is it found in the tolerance with which we suffer that commercial violation of our beautiful landscapes which has now reached the proportions of national scandal?"

Mr. Maginnis said that he detected a good while ago that "New York is not nearly so formidable as its architectural countenance."

"I cannot easily believe there is an architect of sensibility who is not moved by the New York scene whatever reservations he may hold as to its reasonableness," Mr. Maginnis continued.

"One who has acquired the habit of coming here is impressed by the awful impermanence of things. We look about for buildings we have been accustomed to admire and though we had seen them but a week ago they are no longer there.

"This architectural here-kiri is, of course, only part of the process of rejuvenation, but it puts obstacles in the way of the affectations. I miss not least among other things Madison Square Garden with the charming and disciplined fancy of Stanford White. Perhaps one should not indulge this wistfulness in the presence of so many brilliant things which have been done since.

"The 'little old New York' of the nineties never had the look of a great city. For its particular challenge in those days it depended on Broadway, Fifth Avenue, the Bowery, and Greenwich Village, which gave a pale illusion of Montmartre. The immediate curiosity of the architectural stranger was gratified mostly by the incipient perpendicularity of the World and Singer buildings at the lower end of Manhattan, and by the flamboyancy of the Vanderbilt residence in upper Fifth Avenue. The city lacked sadly that articulation of significant places which so well indicated when you achieved the splendid railway stations and the Public Library, and now that the Sixth Avenue elevated has been removed, I am ready to join in your prayers for the complete wiping out of this diabolical institution."

Mr. Maginnis also commented that he had never overcome "the wonder of the still pervasive ferry-boat, so triumphantly the ugliest piece of naval architecture afloat that I love it."

Mr. Hood, who was also architect of the McGraw-Hill Building and the Beaux Arts Apartments in New York, and the Chicago Tribune Tower and buildings of the Century of Progress Exposition in Chicago, was cited as "a man of unique and outstanding qualities."

"Raymond M. Hood was known in the profession as a stormy petrel. He stirred the minds of his architectural confreres, always putting out new ideas at variance with accepted traditions, seeing the problems of the profession in a new light, and yet always developing his ideas with a solid common sense approach.

"He was an inspiration to students and

HERRICK IRON WORKS
STRUCTURAL STEEL
REINFORCING STEEL
18TH AND CAMPBELL STS.
OAKLAND, CALIF.
Phone GLencourt 1747

Independent Iron Works

Structural Steel
Ornamental Iron
Steel Service Stations
Steel Tanks
Standard Steel Mill Buildings
Bridges

821 Pine Street Oakland

FORDERER CORNICER WORKS

Manufacturers of
Hollow Metal Products
Interior Metal Trim
Elevator Fronts and Cabs
Metal Plaster Accessories
Sanitary Metal Base
Metal Cabinets
Flat and Roll Metal Screens
Commercial Refrigerators

269 POTRERO AVE.
San Francisco, Calif.
HEmlock 4100

**"AMERICAN MARSH"
Redi-Vac Vacuum Heating Pump**

Send for Bulletin 441

SIMONDS MACHINERY CO.
San Francisco Los Angeles
816 Folsom St. 455 East Fourth St.

BASALITE

CAMBERED SHINGLE TILE

PERMANENT
FIREPROOF
STORMSAFE
COLORFUL
ECONOMICAL

Manufactured by

BASALT ROCK CO., Inc.
NAPA, CALIFORNIA

ALLEN STRUCTURAL PORCELAIN PANS

The ultimate in porcelain enamel construction.

Details and specifications now available.

FRANK ALLEN

Ferro-Porcelain Construction
320 MARKET ST., SAN FRANCISCO

Melrose Lumber & Supply Co.

LUMBER AND
MILL WORK

46th Ave. and E. 12th St.
Oakland

Phone: FRuitvale 0251

the record of his important buildings demonstrates his great breadth of vision and willingness to change."

A guest of honor at the dinner included Edwin Bergstrom of Los Angeles.

RUNNING FIRE

(Continued from Page 1)

ble for a solid reinforced concrete wall may last any number of years.

★ ★ ★

Song

I have an unsigned letter in front of me which, to my mind, is one of the most pleasant and constructive communications I have ever received. It is the story of a bird, found on the window ledge of a house. But I think it best to quote directly from the unknown author of the letter.

"A fluttering bird was found on a window ledge and taken into the home. It became a pet to the man who had rescued it and he taught it to sing a song: "Freud euch das Lebens."

"But the bird longed for freedom and flew away. After a year, the man heard a tapping at his window, and beheld his former pet, who was accompanied by another bird of its kind. In appreciation of his former kindness, the birds sang to him in duet, "Freud euch das Lebens."

★ ★ ★

Briefcases

My son has a briefcase that baffles description—it is immeasurably old, I can't make the lock work but he can, the rear pocket is completely torn on one side and partly on the other, the handle looks like it will last about five minutes and yet he carries as much as thirty pounds load in the case. In his accounting office, I have examined the contents secretly and discovered books, folders, pencils, blotters (he doesn't carry a pen), and a number of crumpled letters underneath the folders and books.

For the past month I have been making remarks like "Your briefcase is a bit shabby" and surreptitiously commenting that there was a new and extra one in my office. To this he merely says "Oh, thanks" and both briefcases stay with their present owners. I think he aspires to a hallmark like the white carnation of Mayor Rossi.

Quality Hardware

The beautiful home in Walnut Creek, Contra Costa County, California, designed by John E. Dinwiddie, and illustrated in this issue, has Russwin finish hardware throughout.

Furnished by

MAXWELL HARDWARE CO.

1320 Washington Street, Oakland

ANDERSON & RINGROSE

General Contractors

320 Market Street, San Francisco

Phone GARfield 2245



MERCURY DRESS

We Print
The ARCHITECT and
ENGINEER

"A Thing of Beauty
Is a Joy Forever"

942 HOWARD STREET
SAN FRANCISCO

ARCHITECT

AND

ENGINEER

UNIVERSITY OF CALIFORNIA
PUBLIC LIBRARY
BERKELEY, CALIF.

MAY, 1940

HOME ARCHITECTURE AND LANDSCAPE ARCHITECTURE BY MARK DANIELS

This "NEWS" ran in all four San Francisco Newspapers

**64 DAYS
SAVED**
to
San Franciscans

"What—Post Street tied up for weeks?"
"Not in 1940!" said Contractor Chas. L. Harney. "Golden Gate 24-Hour Cement will cut concrete curing time 80%. Instead of 10-day waits required for ordinary concrete to harden, city specifications are 2 days when 24-Hour cement is used." Saved—8 days per block—64 days in 8 blocks' paving on Post Street! Free folder "When Minutes Mean Dollars" tells how.

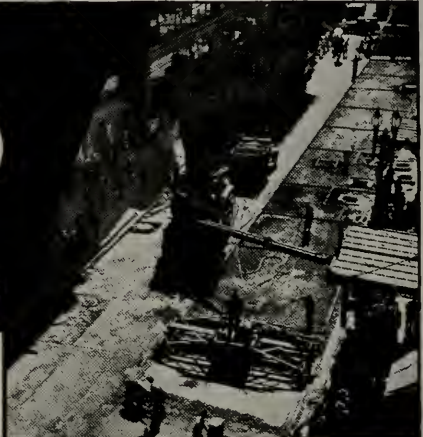

WED. Pouring concrete made with Golden Gate 24-Hour Cement on Post St. paving.



THURS. Deliveries as usual over new concrete, thanks to Golden Gate 24-Hour Cement!

SAVES BOTH TIME
AND MONEY

PACIFIC PORTLAND CEMENT COMPANY

111 Sutter — San Francisco

**Use Golden Gate 24-Hour Cement
on YOUR next job**

RUNNING FIRE

by
MARK DANIELS, A.I.A.

Kibitzing

There is something bred in the human race that will make it catch any construction job, no matter how small or how large. People will stand for hours and watch the man with the jack-hammer (I think this should be Jackhammer) break up paved streets, watch his muscles jerk to the movement of the drill. But if there is anything the public likes, which is doubtful, it is a steam shovel, or a concrete mixer with a carrier arm, or a grader. Anything big and complicated will draw them like a mustard plaster.

In the repaving of San Francisco's Post Street, the shovel operator is a genius—he picks up one-ton chunks of pavement and bounces them lightly into the truck—he separates a piece of wood weighing ten pounds from the pile of rock—he drops the bucket to break up large pieces of paving, much the same as I scramble eggs. I expect the watchers to burst into 'hoorahs' or handclaps any moment—I almost do myself. Then there is a grader with a blade that moves in any direction. And a concrete mixer that is as big as a small house, has a carrier arm that is really the grand finale to the operations. For the past two weeks Post Street from Montgomery to Stockton has been jammed with a contractor's audience.

One noon time I was walking up the street. There was no big machine in operation, yet to one side of the street was a large crowd. All were silent with the deadly seriousness of the kibitzer. I joined them. Working my way through the people I saw four men with their feet dangling into an open man-hole. Across the top of it was a twelve inch plank over which the four men were leaning tensely. The crowd was breathless. Could a child have fallen into the depths of the man-hole? Was someone injured? Suddenly, one man slammed his hand on the plank—the man across from him looked startled—then, "Why, you damn fool, you trumped my ace!" A sigh went up from the onlookers, a little gust of exasperation.

Questionable Ability

The British seem to be having a time of it. Each day's front page fills us with new despair. The Nazis seem always to be two jumps ahead of the allies. Each day starts with the question "Has Britain been out-smarted again?"

But Mr. Baldwin and the Archbishop of Canterbury have one consolation. They have a king of their own making and, if matters come to the worst, they can also throw him out, even though his wife is not American.

★ ★ ★

Congratulations and Retractions

Last month I made some derogatory remarks concerning certain types of construction practice that were permitted by the Department of Public Health. This was in reference to the jerry-builders who make living rooms and dining alcoves one and the same room but so separate the alcove as to keep it unventilated. Now I feel better—maybe my article brought about a change but I have a sneaking suspicion that Dr. Geiger and Mr. Thyle had the move all planned out and were hoping to have some public support to put it over. Anyway, here is a little quotation from an order issued by the Department to home builders and which Dr. Geiger sent me either as a reproof or an enjoinment in the cause.

" you are hereby advised that any and all applications for building permits submitted will be disapproved by the Department of Public Health unless drawings and specifications filed therewith conform to the following requirements. 2. In the matter of irregular or so-called "L" shaped rooms any attempt to divide this room into two sections will not be permitted. Any such room is to be entirely 100% (open) as one room. A pilaster at sidewalls not exceeding $\frac{3}{4}$ " in projection and a single beam, or dropped soffit at ceiling not exceeding 3" in depth, are the maximum encroachments into this opening that will be permitted at any time. Built in cases, cabinets, or other permanent fixtures, are ob-

structions and will not be allowed.

.....
All I can say is "congratulations" to the Department of Public Health and the Division of Housing Inspection. Personally, I am glad to see a city department take quick action for the public benefit.

POST SCRIPT

I wonder if something like this could be done about the Orpheum Wall, but of course that's not in the health field.

★ ★ ★

Nuts

The well known patience is about exhausted. For days and days the Jackhammers have been working in our street. How I wish they finally would get that nut cracked.

★ ★ ★

Bone to Pick with Julia

In Berkeley, the Women's City Club stands as a monument, one of many, to the genius of Julia Morgan. Obviously it was designed and erected for the use of women, but not exclusively, for many men have dined and spent a pleasant evening there.

Here is the bone to pick with Julia. The men's rest room and lavatory are about the size of a ticket booth. The lavatory and toilet, half equipped, are little more than a glorified broom closet, barely large enough to accommodate one small hall boy. The remainder of the building is spacious and commodious.

Now, when we men build a club where women are welcome, we devote as much attention, space and equipment to the comfort of the women as we do to that of the men. Of course, it is possible that Miss Morgan did not think the members would have many boy friends, or that since there was to be no bar in the club, the men's rest room was more or less superfluous. There may be other reasons, but it looks a little like sex prejudice—in which case I think Julia was right.

(Turn to Column 3, Page 4)

ARCHITECT AND ENGINEER

Since 1905

Volume 141

May, 1940

Number 2

SOME FRESH EXAMPLES OF TODAY'S ARCHITECTURAL TREND	17
GARDEN ARCHITECTURE	8
Berniece Ashdown, Landscape Architect	
THE WORK OF MARK DANIELS, ARCHITECT AND LANDSCAPE ARCHITECT	19
Mark Daniels, A.I.A.	
LANDSCAPE VALUE OF TREES ON SMALL HOME GROUNDS .	31
Richard K. Wilcox	
FILTER PLANT OF EAST BAY MUNICIPAL UTILITY DISTRICT.	43
R. C. Kennedy	
STANFORD LABORATORY HAS UNIQUE STRUCTURAL FEATURES	45
Harry Sanders	
BY REQUEST—A REPEAT PERFORMANCE OF GOLDEN GATE EXPOSITION	45
E. N. Kierulff	
FIREPLACES	47
SUGGESTIONS FOR LIGHTING MUNICIPAL AUDITORIUMS .	50
Nathan H. Graves	

ILLUSTRATIONS

WORK OF MARK DANIELS, A.I.A.	18-41
LABORATORY, STANFORD MEDICAL SCHOOL, SAN FRANCISCO	45
Birge M. Clark, Architect	
PLATE SECTION AND MEASURED DRAWINGS	33-40
Mark Daniels, Architect	

NEXT MONTH—WORK OF PAUL R. WILLIAMS, ARCHITECT, LOS ANGELES.

(Index to Advertisements—Page 72)

HONORARY EDITORS

Arthur Brown, Jr., Timothy L. Pflueger, Lewis P. Hobart, John J. Donovan, Will G. Corlett, Frederick H. Meyer, Thos. J. Kent, Gordon B. Kaulmann, Ben. H. O'Connor, Michael Goodman, Harry Michelsen.

REGULAR CONTRIBUTING EDITORS

Harris C. Allen, Harry Sanders, Paul H. Hunter, Glenn Stanton, Chas. H. Alden.

EDITOR, FRED'K. W. JONES; ASSISTANT EDITOR, E. N. KIERULFF; CONSULTING AND CONTRIBUTING EDITOR, MARK DANIELS.

ARCHITECT AND ENGINEER is published on the 15th of the month by The Architect and Engineer, Inc., 68 Post Street, San Francisco. President, K. P. Kierulff; Vice President, Fred'k. W. Jones; Secretary and Business Manager, L. B. Penhorwood.

Entered as second class matter, November 2, 1905, at the Post Office in San Francisco, California, under the Act of March 3, 1897. Subscriptions, United States and Pan America, \$3.00 a year; foreign countries \$5.00 a year; single copy \$.50.

Los Angeles office: 832 W. Fifth Street, Bland Ballard, manager.

ARCHITECTS REPORTS are published daily from this office and are sponsored by the Northern Section, State Association of California Architects; Vernon S. Yallop, Mgr.

JOY OF LIVING



SUN DECK, FLAT BUILDING

DR. W. M. SCHIFF, MARINA DISTRICT

SAN FRANCISCO

R. NEUTRA, ARCHITECT

O. WINKLER, COLLABORATOR

The sheer beauty of "Alameda" Clay Tile still lives long after its utility is taken for granted. It does the job, no matter to what surroundings it is adapted by the architect. Tile manu-

factured by N. Clark & Sons, whether it is intended for outdoor or indoor use, contributes in a way few other materials can to the joy of living of your clients.



N · CLARK AND SONS

116 Natoma Street • San Francisco

LOS ANGELES

SALT LAKE CITY

PORTLAND

PRODUCERS OF QUALITY ARCHITECTURAL CLAY PRODUCTS

SOME FRESH EXAMPLES OF TODAY'S ARCHITECTURAL TREND

PARKING STATION

Beauty above, utility below—this is the theme of the Union Square Garage Corporation's plans for a sub-surface parking station under San Francisco's famed Union Square. The present contour of the park would be retained, embellished by illuminated foun-

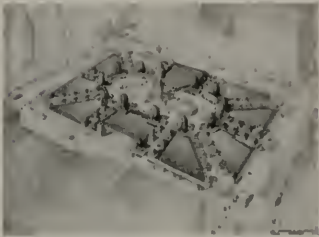

tains in the central court, as well as trees and shrubbery landscaped to permit colorful lighting and decoration for holidays and celebrations. Arches, such as those shown for the Post (in foreground) and Geary Street "in" and "out" ramps, would be of granite, walks would be of terrazzo, helping make Union Square the most beautiful metropolitan park in America. Below this beauty would be a three-level parking station, with accommodations for 1,700 automobiles—to relieve San Francisco's traffic problem. T. L. Pflueger is the architect.

western motif executed in frame and stucco. The structure has been described by many architects as beautiful in design and complete in appointments.

The wing of the building housing the ticket office and waiting lounge is semi-circular surrounded on three sides by a sheltered promenade, and one story in height.

The baggage and express departments, and the offices of the operating and other rail officials, are accommodated in the main portion of the building, which rises to two stories.

Clevery concealed in a spectacular tower surmounting the building is the cooling equipment for the refrigerating apparatus of the air-conditioning system.



OFFICES

Stephen F. Voorhees, architect and president of the corporation owning the Architects Building, 101 Park Avenue at 40th Street, New York, pictured above, has announced publication of the first edition of a classified directory containing 2,000 listings, over 200 of architects, engineers and builders, and nearly 400 building material manufacturers.

RUNNING FIRE

(Continued from Page 1)

Goats and Camels

In San Francisco I continue to hear monologues and diatribes on life and conditions in the South. There is no business there. The lowans have it, nothing but bungalows. This is not a case of pot and kettle; it is more like pot and porcelain.

Last week I drove along street after street of Los Angeles bungalows and small houses. They are all set back 15 to 20 feet from the property line with the vacant area devoted to lawn. Why, the old has-beens had from 15 to 20 feet of space between houses. Think of it! Not a street like so many of ours in the western district, where twenty-five-foot Jerry-builts stretch block after block, touching one another and built to the property line, all arranged to make a beautiful fire of sufficient size to get a man out of bed in the night. The unused land is bad enough, but imagine a house exposed to sunlight on all four sides, with children running around risking sunstroke.



HOTEL

Recently completed to replace the building destroyed by fire, the new Arrowhead Springs Hotel in the San Bernardino, California, mountains, is attracting tourist, likewise local, patronage greater than anticipated. Designed by Paul R. Williams and Gordon B. Kaufmann, the hotel contains 150 guest rooms, a theater, costume shops and a "cure" house, the latter equipped with an amazing series of steam caves carved into the heart of the mountain and complete with mud baths, radio-active waters and massage rooms. Modern Georgian answers the question of architectural style. A spacious swimming pool, surrounded by numerous Lamella roofed cabanas, forms a setting for the exquisite landscaping.

NEWSPAPER PLANT

The San Francisco Call-Bulletin is to have a new building. The publishers say it will be the most modern newspaper production plant in the West. Located on Howard Street, between Fourth and Fifth, the building will bring all of the San Francisco metropolitan dailies, except the Examiner, inside a two-block area. The design is functional. The plans are from the engineering office of William D. Coffey of Los Angeles. Construction is under way.

(See elevation on the left.)



DEPOT

Since 1905, when the Union Pacific completed the westward drive of its main-line rails to the Coast and established its first station at Las Vegas in a railroad car, the railroad has kept pace with the continued development of the community. The latest improvement is the new station, just completed, and pictured above.

The station has a typical modernistic,



AT VALLEJO HIGH SCHOOL

*Kraftile Terra Cotta Wall Unit partitions shown to have
10 times the stress resistance required by State*



Vallejo, California. High School. John J. Donovan, architect. Reed & Reed, masonry contractors. Inset photograph shows preliminary testing of Kraftile Terra Cotta Wall Unit reinforced partitions in Kraftile plant at Niles, California

BEFORE WORK started on Kraftile's revolutionary Terra Cotta Wall Unit shower partitions at the new Vallejo High School, engineers raised sample structures for testing.

A load equal to State requirements was applied. Then twice the load . . . then triple . . . finally the strain was increased to *ten times the State minimum* . . . and still the partitions held!

Needless to say, a shower partition failure is something the City of Vallejo need never face in this structure.

Kraftile Terra Cotta Wall Units can be used economically for many types of partitions. Pre-tiled on one or both sides, they reduce building time considerably. Labor costs run over . . . as much as a third less. One craft can do the whole job.

Upkeep cost on these modern walls is next to nothing. The jewel-hard Kraftile surface

Kraftile Company is a member of the Producers' Council, Inc., the national organization of manufacturers of quality materials.



KRAFTILE TERRA COTTA WALL UNITS

is fireproof, moistureproof, stainproof. It can take any amount of scuffing and abuse. A cloth and a little water is usually all the "retouching" ever needed.

A comparatively new development in modern building, Kraftile Terra Cotta Wall Units are already in use in 21 states, and in Canada, Hawaii and the Canal Zone—in schools, hospitals, food products plants, laboratories and public buildings. For further information mail coupon.

SEND FOR FREE HANDBOOK

KRAFTILE COMPANY, Niles, California

Please send me without cost or obligation "Handbook of Specifications and Suggestions on Glazed Terra Cotta Wall Units" ()

Please have representative call ()

Name

Address

City State

USE "Pennvernon" ...
NOT JUST "WINDOW GLASS"

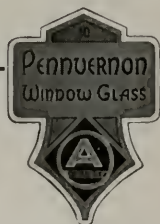

WINDOWS are no better than the glass with which they are glazed. The use of Pennvernon Window Glass insures windows which are exceptionally transparent, which permit clear, satisfying vision and which add to the appearance of a home by their brilliant, reflective surface finish.

DISTRIBUTED BY

W · P · FULLER & CO

BRANCHES AND DEALERS THROUGHOUT THE WEST

For more rigid, warmer, dustproof houses, specify Plyscord

THE UTILITY GRADE OF DOUGLAS FIR PLYWOOD

● Plyscord is the unsanded utility grade of Douglas Fir Plywood. Because it affords superior rigidity and strength; quick, economical application, air-tightness; and large size... it is unsurpassed for wall and roof sheathing, sub-flooring, one-use concrete forms and similar construction work. Progressive lumber dealers everywhere handle Plyscord in 5/16", 3/8", 1/2" and 5/8" thicknesses and in 32" x 96" and 48" x 96" sizes.

You will find Plyscord easy to specify and identify because every panel is manufactured in strict accordance with U. S. Commercial Standard CS45-38 and stamped with a distinctive "grade trade-mark."

For more information, consult Sweet's Catalog or write for these free booklets: Suggested Specifications for Douglas Fir Plywood, Commercial Standard CS45-38, Dri-Bilt Manual, Douglas Fir Plywood Association, Tacoma Bldg., Tacoma, Washington.



The Plyscord-sheathed walls of this residence in Seattle, Wash., are 40% more rigid than if diagonal board sheathing had been used. The big panels also save up to 80% on sawing, fitting and joining... 50% on nailing. Tenny Francis Bellamy was the architect on this residence.



In this Stamford, Conn., home designed by Provest and Edwards, Plyscord provided a smooth base for finish flooring and linoleum—insulates and protects against drafts from below—gives a horizontal diaphragm to resist earthquakes and high winds. Recommended thicknesses are 1/2" and 5/8".







Plyscord is suitable for any type of roofing—shingles, composition roofing, asbestos tile or slate. Illustration shows Plyscord roof sheathing on a Portland, Ore., residence designed by Richard Sundeleit.

The face of every genuine Plyscord panel contains the circular stamp (left) and guide line 16" on center which speed nailing.

FHA has accepted Douglas Fir Plywood for home construction, and its use is approved in Uniform Building Code.

At right: Tests at Forest Products Laboratory, Madison, Wisconsin, showed Plyscord 5.3 times as rigid as horizontal board sheathing—40% more rigid than diagonal board sheathing.

	10
HORIZONTAL LUMBER	
	3.0
25/32" FIBRE BOARDS	
	4.2
1" X 4" LET-IN BRACING	
	4.3
1" DIAGONAL SHEATHING	
	5.9
1/4" DOUGLAS FIR PLYWOOD	



DOUGLAS FIR PLYWOOD
Real Lumber
**MADE LARGER, LIGHTER
 SPLIT-PROOF
 STRONGER**



SPECIFY DOUGLAS FIR PLYWOOD BY THESE "GRADE TRADE-MARKS"

PLYFORM D.F.P.A.

EXT. - D.F.P.A.



INDUSTRIAL EFFICIENCY

with TEMPERATURES
controlled by **JOHNSON**

GARDEN ARCHITECTURE

By BERNIECE ASHDOWN

Landscape Architect

FROM the very beginning of gardens, they have included various architectural features. In a truer sense, the gardens of antiquity were founded upon architectural construction and plants were used only as further embellishment.

Many of our present-day gardens have quite reversed this practice and have sadly neglected architectural features. This is indeed regrettable, since there is nothing which adds more genuine charm and individuality to a garden than a properly designed, proportioned and constructed architectural feature. It should be chosen and constructed for endurance as well as beauty and placed where it will be of the greatest pictorial value—perhaps as the center of interest for the whole garden, or for a garden picture designed to be seen from the window of an important room of the house. Always such a feature should be used sparingly and should be chosen with care. A poorly built structure or a piece of cheap, gaudy statuary is worse than none at all.

Garden pergolas and vine arbors had a place in the earliest American gardens and are still very popular. They may be adapted to large or small gardens and may be simple wooden structures or large, elaborate constructions of stone; they must fit the particular requirements. Pergolas and arbors if their truest capacity should serve as a passage-way and a shelter where one may look back into the enclosed peacefulness of the garden or out upon a particularly nice view. They must be large enough to allow reasonable space for several people to sit beneath them comfortably and high enough to allow free passage under them. Vines and climbers suitable for covering them are numerous. Wisteria, climbing roses and clematis are perhaps most popular. Grape arbors, too, still are widely used and combine utility with beauty.

Pools have recently gained popular favor. When properly planted, the garden pool will reflect month by month the loveliest flowers that the season has to offer. Small pools are simply constructed and can be built by the amateur, but large pools require special construction. If water lilies are desired, the pool should be at least 24 inches deep. The sides and bottom should be of 6 inches of waterproofed, reinforced concrete, with an inch of finish coat. Large pools should be connected with a central water supply and should be provided with a drain and overflow pipe large enough to take care of the excess water at all times. These should be screened to prevent the small fish from being carried away. The water level should be the same as or slightly below the level of the garden. Gold fish not only add the desirable touch of color and

(Turn to Page 12)

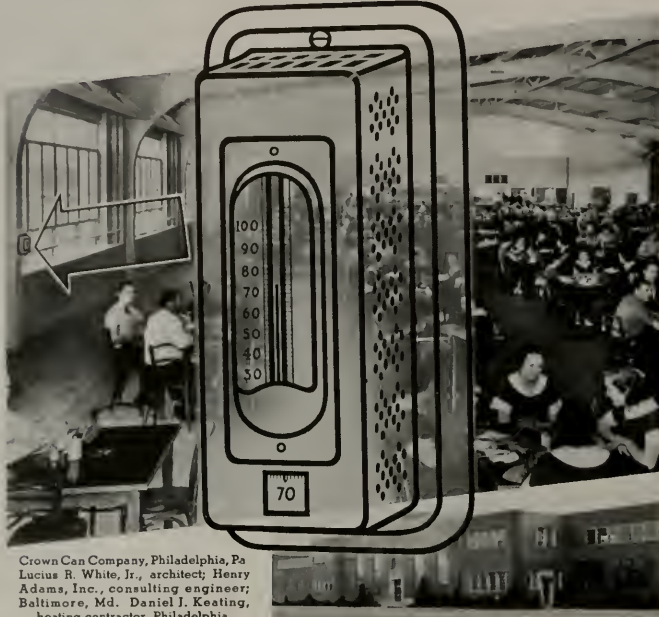

Crown Can Company, Philadelphia, Pa. Lucius R. White, Jr., architect; Henry Adams, Inc., consulting engineer; Baltimore, Md. Daniel J. Keating, heating contractor, Philadelphia.

This Philadelphia manufacturer, like other progressive producers, considers the comfort and health of employees as an important contribution to operating efficiency. Here at Crown Can, the office and cafeteria sections of the plant are equipped with JOHNSON Automatic Temperature Control, involving more than 60 room thermostats to operate radiator valves and also dampers and valves in unit ventilating machines . . . Whatever or wherever the problem in temperature, humidity and air conditioning control, the nation-wide Johnson organization is nearby, at your service with its broad experience of more than half a century.

Also: JOHNSON CONTROL FOR INDUSTRIAL PROCESSES

Send for Bulletins

JOHNSON

Automatic TEMPERATURE AND AIR CONDITIONING *Control*

JOHNSON SERVICE COMPANY: MILWAUKEE, WIS. AND DIRECT BRANCHES IN PRINCIPAL CITIES



The New SLOAN

LO-FLO

A Flush Valve Water Closet for Small Piping

● Sloan engineers, with 33 years of flush valve experience and intimate knowledge of every make of closet bowl, have produced a flush valve closet combination that brings to residential installations with small piping the advantages now enjoyed by buildings with large supplies. Here's what to expect from LO-FLO—

HALF THE RATE OF FLOW ORDINARILY REQUIRED! The LO-FLO Closet Combination will give a positive, cleansing flush at a rate of flow of 12 gallons per minute. This rate is easily attainable in most residences and thus, for the first time, the advantages of a Sloan flush valve installation are available to home owners.

ABSOLUTE QUIETNESS! You'll have to revise your ideas of quiet action when you try to hear the LO-FLO. No turbulence, no hissing refill—just a quiet murmur that is almost inaudible nearby and which cannot penetrate a closed door. Nor are piping noises telegraphed, even at pressures as high as 100 pounds.

AUTOMATIC ADJUSTMENT! Fluctuations in pressure, so common in small piping installations where the demands of one fixture rob the supply to another, do not affect the action of the LO-FLO. An automatic throttling valve adjusts itself instantly to pressure variations up to 100 lbs. so that the valve constantly adjusts itself to the exact requirements of the bowl.

AMAZINGLY CONVENIENT OPERATION! The unsightly handle is done away with. In its place is a molded rubber bumper, operated by a slight pressure from the seat cover, a device so simple and obvious that perfect sanitation and freedom from carelessness is assured.

The entire combination is protected by a vacuum breaker approved by the National Plumbing Laboratory and local authorities everywhere. Write for complete information today.



The streamlined housing which covers the flush valve is easily removed for inspection. The entire combination is compact and space-saving, roughing-in normally at 10" with ample tolerances for both water and waste connections.

Remember that for regular flush valve installations Sloan Quiet-Flush Valves provide genuine Sloan quality with the quietest operation available today. You have to LISTEN to hear a Quiet-Flush Valve in operation!

THIS SIMPLE DEVICE CAN PREVENT AN EPIDEMIC!



The Sloan V-100-B Vacuum Breaker fills a vital need for a back-syphonage preventive on fixtures with small supplies and a low rate of flow, such as are commonly found in hospitals, hotels, restaurants, beauty parlors, etc.

Subjected to tests more severe than will ever be encountered in service, the V-100-B provides a simple

and inexpensive method of obtaining positive safety from water pollution.

Use the V-100-B with the certainty of complete protection, for no fixture to which this modern safeguard is applied correctly can back-syphon, regardless of the degree of vacuum, or the suddenness with which it develops.

SLOAN VALVE CO. • CHICAGO

PEOPLE DON'T LIKE INADEQUATE ELECTRICAL WIRING

Clients are sometimes unreasonable in blaming inadequate wiring on the architect.

If, moving into a new home, they are constantly annoyed because they cannot attach appliances where they wish, more often than not they think the architect is at fault.

They may have approved every plan submitted, and followed the building process closely, but it never occurs to them to wonder why they didn't specifically mention the electrical service themselves.

The architect's one protection against this unfair attitude is to suggest adequate wiring at the time building plans are submitted. If he plans adequate wiring and the owner vetoes part of the job, the architect is cleared of any charge of negligence.

Submitting plans for adequate wiring has another great advantage for the architect. It eliminates those annoying revisions in wiring plans that so often upset the building budget. If the owner has either approved or rejected adequate wiring plans, it is unlikely he will ask for last-minute revisions.

Our RED SEAL plan offers an easy guide covering minimum specifications. It will prevent oversights in planning.

Send for your free copy of the special Architects Specification Sheet.

PACIFIC COAST ELECTRICAL BUREAU

447 SUTTER STREET • SAN FRANCISCO, CALIFORNIA

AQULUX 85

NEW Oil Burning
Water Heating Unit

This powerful and compact vertical unit, beautiful in appearance, is designed to supply hot water at minimum cost in the modern home. It can also be used to supply heat and hot water automatically for small homes without the necessity for basement installation. Complete data on this new "package unit" now ready.

Burns No. 3 C. S. G.
fuel or Diesel oil

S. T. JOHNSON CO.

940 ARLINGTON, OAKLAND, CALIF.
401 N. BROAD ST., PHILADELPHIA, PA.

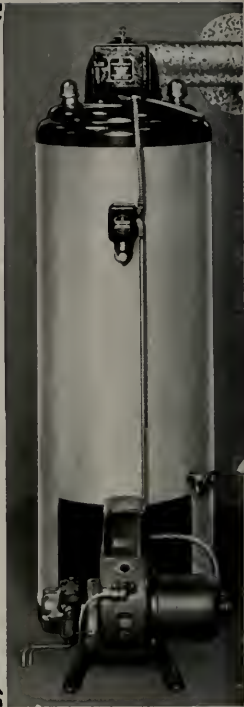

CABOTS INSULATING QUILT FOR SOUND DEADENING AND THERMAL INSULATION

IN BLANKET FORM

EASY TO INSTALL

EXTREMELY FIRE

RESISTANT

VERMIN PROOF

WILL NOT DECAY



GUNN, CARLE & CO.

SAN FRANCISCO

20 Potrero Avenue

Underhill 5480

Safeguard Against Destructive Condensation



WITH THE NEW WALL OF PROTECTION

NO HOUSE is modern unless the condensation problem has been squarely met and overcome.

Vapor is always prevalent in the air. It generally travels from warm to cold areas, quickly passing through unprotected inside walls into stud spaces and there condenses.

The *New* INSULITE WALL OF PROTECTION controls vapor. The combination of *Sealed Graylite Lok-Joint Lath* effectively retards the passage of vapor, while *Bildrite Insulating Sheathing* allows any possible vapor within the stud spaces to escape.

Sealed Graylite Lok-Joint Lath is the same, safe, rigid plastering surface. The famous "Lok" secures each unit, reduces danger of plaster cracks to the minimum, thus assuring smooth walls and ceilings.

Bildrite Sheathing with four times the bracing strength of wood sheathing horizontally applied, offers you the ultimate in strong, practical insulating sheathing. Together these insulating materials form the INSULITE WALL OF PROTECTION.

Write Insulite, Dept. AE50, Minneapolis, Minnesota, for complete information describing how the INSULITE WALL OF PROTECTION controls vapor, guards against condensation within wall areas.

INSULITE PRODUCTS INCLUDE:

Structural: Sealed Graylite Lok-Joint Lath, Graylite Lok-Joint Lath, Ins-Lite Lok-Joint Lath, Bildrite Sheathing.

Interior Finishes: Ins-Lite, Graylite, Smoothcote, Satincote in 4 washable colors, Hardboards, Acoustilite, Fiberlite

Copyright 1940,
by Insulite

INSULITE



MINNEAPOLIS
MINNESOTA

THE ORIGINAL WOOD FIBRE STRUCTURAL INSULATING BOARD

CALIFORNIA COMMISSION
GOLDEN GATE INTERNATIONAL EXPOSITION
ON SAN FRANCISCO BAY

EXHIBITOR OFFICES

October 11, 1939

Roy F. Wilcox Co.
Montealeo, Calif.

Gentlemen:

I have just completed my final inspection of the landscape treatment of the State of California section of the Golden Gate International Exposition in preparation of my final report to the Commission and I cannot refrain from telling you how pleased I have been with both the plants and services which you furnished.

In almost every instance your prices were lower than those of competitive bidders. The work of your organization and the deliveries of stock, both by rail car loads and by trucks, were all that could be asked and far more prompt and efficiently handled than I had expected under the trying conditions made unavoidable by the schedule of building operations and the shortness of time.

The high quality of the stock and its condition on arrival need no better testimonial than the fact that nearly every tree, shrub and plant is thriving today after eight months of the most trying weather and soil conditions. In fact, out of more than 100,000 plants, only 27 were rejected, which you replaced without question, adding some fifty specimens for good measure.

It seems strange that during thirty years of practice in landscape architecture, mostly on the Pacific Coast, I should have had no dealings with the Roy F. Wilcox Company until the problem of the California section of the Golden Gate International Exposition arose. This I deeply regret, for it has been a great loss to me and my clients as it has to your company.

In sincere gratitude for your splendid cooperation, I beg to remain,

Cordially yours,

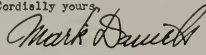

Mark Daniels, A. I. A.
Landscape Architect for the California
Commission, Golden Gate International Exposition

MD:ldg



514 SIXTY MARKET STREET • SAN FRANCISCO, CALIFORNIA U. S. A. • TELEPHONE GARFIELD 0242

Landscape Architects

We are now advertising to home owners the value of planting Wilcox Trade Marked Gold Medal & Blue Ribbon field-grown Shade Trees because of their outstanding merit, standard quality, trunk caliper, well-shaped top and root structure.

GARDEN ARCHITECTURE

(Continued from Page 8)

life to the pool but keep it free from insect larvae.

Bird baths are simple, inexpensive and charming. They are splendid ornaments and encourage birds in the garden. Their design should harmonize with the character of their settings. In informal settings, a large boulder may be hollowed into a basin, deeper at one end than the other. They should be located where they offer the birds protection from cats.

Fountains are lovely garden ornaments but must be well designed. Well executed fountains are quite expensive but it is better to have none at all than to have one of inferior design or craftsmanship.

Seats in the garden should be comfortable and should be placed where they provide a pleasing view. An additional note of pleasure can be added by planting a fragrant plant nearby. Seats near a pool or under a pergola always are welcome additions to the garden.

Statues and vases are not in keeping with good taste in the natural style of small-scale landscaping. Where they are carefully chosen and located they are appropriate for small, formal gardens. The placing of a piece of statuary is of utmost importance; it should be placed where it plays an important part in the design of the garden. It appears to best advantage if it is given a background of evergreens where it can be shaded from the direct rays of the sun with-

out hiding it from view. Garden statuary should be simple, of excellent quality and of a design suited to the character of the garden.

A sun dial, in order to be of any use, must be set where it will get the direct rays of the sun at all times. There are hundreds of different designs for sun dials and it is possible to choose the one most appropriate for the particular setting. Numerous also are the inscriptions which accompany them. Unfortunately many of them are morbid and seem better suited for use as epitaphs than for the garden enclosure which should be peaceful and happy.

THE SPRING GARDEN SHOW

The California Spring Garden Show in Oakland this year attracted a banner attendance and was pronounced one of the most successful shows of the eleven that have been sponsored by this organization. A great deal of praise is due Howard E. Gilkey, landscape architect, who has designed eight of the ten garden shows and who was largely responsible for this year's successful exposition.

More than 100 exhibitors displayed their individual gardens of blooms and shrubs that combined to make the show a riot of color and beauty. The list included amateur gardeners, garden clubs, private estates, nurserymen and famed horticulturists who specialize and are known throughout the world for their horticultural discoveries and developments. Cash awards totaling approximately \$10,000 were made.

The growth and improvement in the show, which has been evident year by year, is due in no small measure to the financial support received from the First District Agricultural Association. The money comes from the California State Pari-mutuel Race Track Fund, authorized and allotted to the show by directors of the local Agricultural Association, including Bestor Robinson, president; Dr. Warren Allen, Joseph L. Callaghan, M. C. Colleghan, Peter Hoare, Phil C. Riley and Hollis R. Thompson.

A. C. S. VISITS CLAY PRODUCTS PLANTS

Production of clay products made in three specialized plants located near Niles, California, attracted more than fifty members of the Northern California Section, American Ceramic Society, to a spring tour and outing.

Included in the inspection was a variety of methods of forming clay shapes: extrusion, sewer-pipe press, hand pressing, jiggering and casting. Firing equipment of the three plants visited combines to sixteen periodic down-draft kilns and a tunnel kiln.

The clay plants visited, all neighbors, were: M. & S. Company, George Smith, president; Kraftite Company, C. W. ("Chuck") Kraft, president; and California Pottery Company, George A. Meys in charge.

M
A
Y
C
O

M
A
Y

Get Maximum Glass Protection

WITH

Kawneer RESILIENT STORE FRONT SASH!

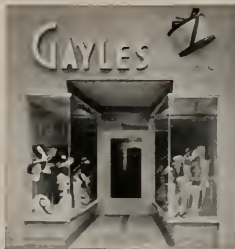

IMPORTANT TO OWNERS, as well as to designers, is the efficiency, as well as the beauty, of store front construction.

YOU CAN DEPEND on Kawneer Resilient Sash and Bars to hold show window glass with a firm, evenly distributed, yet yielding grip—an almost human grip, designed to cushion inevitable shocks, vibration, and pressure. This RESILIENCY and consequent protection against glass breakage is a vital Kawneer principle of 35 years' standing.

Use Kawneer construction—for this feature, and for latest store front developments, such as Doors, Concealed Awning Bars, Aluminum and Porcelain Enamel Facing, trim mouldings.

WRITE THE KAWNEER COMPANY, BERKELEY, CALIFORNIA

Illustrated: May Co., Los Angeles, Cal. Albert Martin, Arch.
S. A. Marx, Assoc. Gayles Shop, Emanuel Alberts, Arch.

ALUMINUM, BRONZE AND OTHER NON-FERROUS METAL—

Kawneer

END SHOWER TROUBLES



A modern, permanent replacement of the old style shower. Easy to install . . . colorful . . . light . . . airy . . . sanitary and inexpensive.

See models in our showroom.

STAINLESS METAL PRODUCTS

481 - 25th Street Oakland, California
Phone TEmplebar 7774

*Biltwel
Furnaces*

are

**Built
Well**

A mammoth 200-ton press forms the sections of the heating element out of heavy heat-resisting steel. The *Biltwel* Gas Furnace is built up of multiple sections welded into one piece. Air flow is split into thin streams for closer contact with the large amount of heating surface, resulting in high efficiency.



FRASER & JOHNSTON CO.

725 POTRERO AVE.
SAN FRANCISCO, CALIF.

MR. ARCHITECT:
8 Good Reasons why you should specify FRANTZ "Over-the-top" Garage Door Equipment

Simple and easy to install, the FRANTZ "Over-the-top" set has many advantages over the pivot or counter balanced types. They include:

- 1 Low headroom. Requiring only two inches of clearance above the door header.
- 2 The door — when open — does not project beyond the header, is entirely within the building.
- 3 A reduction in ceiling height in garage construction. As much as 12 to 16 inches.
- 4 The elimination of side wall projections leaving both side walls free and clear. Does not interfere with the location of side door entrances, window opening, shelving or cupboard.
- 5 Elimination of posts, often necessary in multiple garage door installation when using pivot type sets.
- 6 No projections. The garage is entirely free as the hardware is applied on the edge of the door and door jamb.
- 7 Steel "weather-strips" a part of the equipment makes a more complete and "finished" job, makes the door weather tight.
- 8 FRANTZ "Over-the-top" door equipment needs no weights, chains, pulleys or cables.

FRANTZ Over-the-Top Door Equipment

Write for name of authorized distributor and installation service in your territory.

FRANTZ SALES COMPANY

ROOM 627-420 S. SAN PEDRO ST., LOS ANGELES
LOS ANGELES, CALIFORNIA

SAN FRANCISCO, CALIF.
OFFICE
200 DAVIS STREET

PORTLAND, OREGON
OFFICE
131 S. W. 4TH AVENUE

No Worry for the Architect

"—All acid proof drain pipe and fittings shall be ferro-silicon—CORROSIRON—"

(Write for above specification)



FEDERAL BUILDING • CIVIC CENTER • SAN FRANCISCO

Arthur Brown, Jr., Architect

CORROSIRON DRAIN LINES and FITTINGS and LABORATORY EQUIPMENT was specified because of its superior resistance to corrosion and wear.

Pacific Foundry Company, Ltd.

NEW YORK • 3100 NINETEENTH ST., SAN FRANCISCO • LOS ANGELES

QUIET



Santa Cruz Municipal Auditorium, Santa Cruz, California
MARK DANIELS, ARCHITECT

James Patt, Plastering Contractor

TREATED WITH **KALITE** ACOUSTICAL PLASTER

MARK DANIELS, A.I.A.
ARCHITECT

101 Post Street, San Francisco, California

April 29, 1940

Gladding, McBean & Co.
9th and Harrison Sts.
San Francisco, Calif.

Gentlemen

In the Santa Cruz Municipal Auditorium, Kalite was used for acoustical correction on all reflecting walls and ceiling. The Auditorium presented a problem in this connection, with its 120 foot clear span of ceiling trusses, and I was worried over the possible development of bad acoustics.

On the night of the dedication a full brass band was on the program followed by a young coloratura soprano. There was no vibration or repeat from the loudest trumpet blasts and the soprano's voice was as clear as though she were singing in a drawing room. I attribute this to the use of Kalite and the fact that it was put on as you directed.

With congratulations to you on the manufacture of this material and my thanks for the opportunity of using it, I am

Sincerely yours,

Excerpt from a letter by Mr. H. R. Judah, Manager Santa Cruz Auditorium, Santa Cruz, Calif.

"The people of Santa Cruz County and all others who may enjoy the facilities which this new Auditorium offers can be particularly happy over the matter of acoustics. We can congratulate ourselves that unlike several other large and important auditoriums in Northern California cities, this Auditorium in Santa Cruz has by far the most perfect acoustics. Few of us realize the value of this great quality, but I can assure you that it will have much to do with the success of the property because if people hear well in a public place it is one of the main reasons for increased attendance at all events as the years go along."

MD:ldg

A development of

GLADDING, McBEAN & CO.

2901 LOS FELIZ BOULEVARD • LOS ANGELES, CALIFORNIA

San Francisco • Portland • Seattle • Oakland • Spokane • Vancouver, B. C.

For Sale — Business Leads — at One Cent Each !

APRIL BUILDING TOTALS SHOW SLIGHT FALL

Building totals for April showed a slight drop over the preceding month due to fewer government projects on the boards and in the market for bids. However, under "Contracts Awarded" there was an increase over March of nearly \$5,000,000. The following totals are from Architects' Reports for April:

Plans in Preparation

Apartments	\$ 12,000	
Residences	73,000	
City, County & State.....	458,000	
Government	164,000	
Schools & Colleges.....	2,005,000	
Churches, Theatres, etc.....	360,000	
Office Buildings	905,000	
Stores & Markets.....	185,000	
Industrial	2,740,000	\$ 6,902,000

Projects out for Bids, but not awarded

Apartments	\$ 91,185	
Residences	137,000	
City, County & State	116,359	
Government	5,869,288	
Schools & Colleges.....	1,060,879	
Theatres, Depot, etc.....	95,000	
Office Buildings	65,000	
Stores & Markets.....	101,600	
Industrial	733,426	\$ 8,269,737

Contracts Awarded

Apartments	\$ 666,100	
Residences	448,650	
City, County & State	585,382	
Government	13,653,102	
Schools & Colleges.....	197,250	
Hotels, Theatres, etc.....	470,765	
Office Buildings	459,171	
Stores & Markets.....	372,085	
Industrial	718,523	\$17,570,828

Total..... \$34,742,565

THE daily advance building news service, reporting construction projects for the Northern California area, comes to its subscribers in the form of handy, individual slips, giving name of owner, location, architect, proposed cost and other pertinent and valuable data.

ARCHITECTS' REPORTS, as the service is called, is mailed daily, and the average number of these reports runs over ONE THOUSAND MONTHLY, based on our current count.

At a cost of \$10 per month, the reports actually reach the subscriber at less than ONE CENT EACH.

Building material houses and contractors in the San Francisco Bay region use ARCHITECTS' REPORTS to help their salesmen round out a profitable day. This service is sponsored and endorsed by the State Association of California Architects. Its compilation cost runs into the thousands of dollars, yet the service is made quickly available to subscribers for a most nominal charge. If you want YOUR share of this daily big business in materials, ARCHITECTS' REPORTS can be of invaluable service. Sample reports sent on request.

ARCHITECTS' REPORTS

Published by

The ARCHITECT AND ENGINEER, INC.

68 Post St.

SAN FRANCISCO

Telephone EXbrook 7182

"I'VE MOVED UPSTAIRS"
G
A

Gas heating plant
IS ON THE ROOF!

STANISLAUS COUNTY OFFICE
BUILDING, MODESTO, CALIF.

ONLY to the uninitiated would this job seem topsy-turvy. Architects and engineers will recognize consistent advanced design: A 2,000,000-B.t.u., automatic gas heating plant, located "topside", delivering instant, even warmth... restful wall areas balanced against continuous windows... simplicity and strength throughout. ☆ The more modern your design, the more appropriate an *all-gas* installation. Your Gas Company invites free consultation.

Architect, Russell Guerne de Lappe; Structural Engineer, H. J. Brunner; Mechanical Engineering, A. H. Memmler; General Contractor, Dinwiddie Construction Co.; Heating Contractor, Air Conditioning of the Pacific.

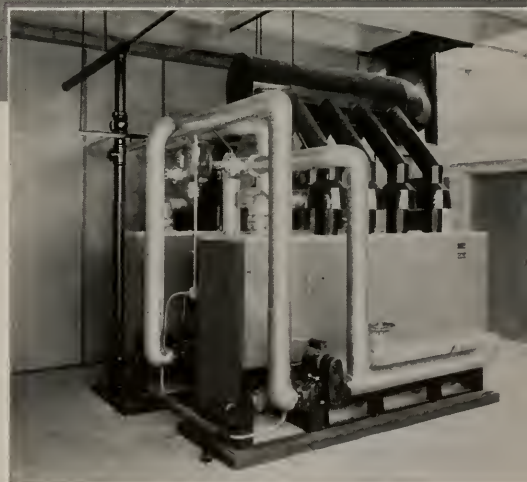

LET GAS THE MODERN
FUEL DO THE 4 BIG JOBS



HOUSE HEATING ★ WATER HEATING ★ COOKING ★ REFRIGERATION

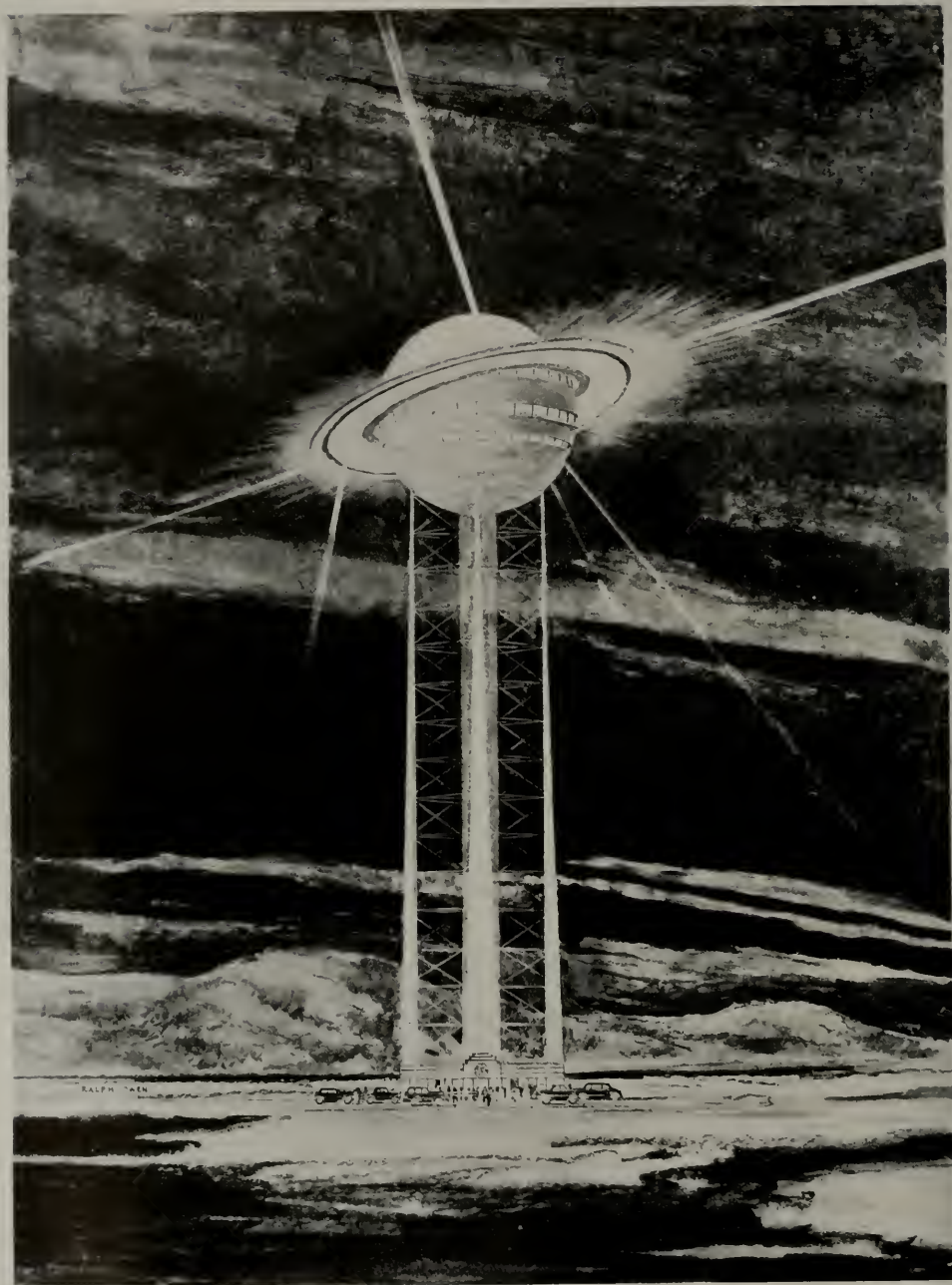

SATURNIUM . . . MARK DANIELS, ARCHITECT, JOS. B. STRAUSS, STRUCTURAL ENGINEER
A REVOLVING SKY DINER



PRELIMINARY PLAN FOR CHINESE VILLAGE IN SOUTHERN CALIFORNIA

ORCHIDS OR CABBAGES?

The Work of Mark Daniels, A.I.A., Architect and Landscape Architect

By MARK Himself

AN old Spanish grandee, whose finances had suffered greatly during the long wars, complained to a friend that his wife served only ham and eggs for dinner every night. He said, "If she serves same to-night I shall go to Casa Botin an' there order me one fine dinner."

That evening his wife served him ham and eggs. The old grandee rose, took his high hat and gold headed cane from the closet and stalked from the house.

At the Casa Botin the waiter asked for his order. After a thoughtful pause, the old grandee threw up his hands. "Damn!" he said, "I can think of nothing but those ham an' eggs!"

I am in the same predicament. Year after year I have seen my masterpieces drift into the limbo of forgotten work, "unwept, unhonored and unsung." The press was often kind but why didn't they rave a lot more? Why didn't the magazines jump up and down and give these products of genius a big spread? Well, some day I would do it myself. I would dwell on the surpassing beauty of this tower, that simple wall, those exquisite corbels. Yes sir, I would write up my own work!

The time has come. But now that I am confronted with the task, I find myself in the identi-

cal dilemma of the old Spanish gentleman. I can think of nothing but, "Damn! How I wish I could do them all over."

However, perhaps it is possible to introduce a new note in magazine articles by telling something about the buildings illustrated and add some information of interest to both the layman and the architect.

THE HALL OF FLOWERS

Cel-O-glass comes in white opaque, clear, red, blue, green and gold. The clear admits too many of the sun's rays for most purposes. The white opaque is not so lasting but gives a softer light. The Hall of Flowers at the G. G. I. E. was more or less of a pioneer job and through a misunderstanding the clear was used. It was disastrous to some plants. The material is applied in overlapping horizontal strips and must be covered at the lap joints with a two inch bat. Otherwise it flaps in the wind and tears loose from the largest nail heads. It costs from 10 $\frac{1}{4}$ to 12 $\frac{1}{4}$ cents per square foot.

SANTA CRUZ AUDITORIUM

The uses to which a municipal auditorium will be put varies inversely as the population of the city in which it is built. In great cities it may function strictly as an auditorium. In

HALL OF FLOWERS, G. G. I. EXPOSITION



A rigid frame with Translucent walls and roof. The translucent or semi-opaque white, is recommended for greenhouses and pavilions such as the Hall of Flowers.

smaller cities the building must function as a theater, a lecture hall, a public dance hall, for auto shows, sports, conventions, small and large exhibits, and minor meetings of local organizations. Added to these general conditions were many others, including P. W. A. requirements, under which this building was built.

Some of the specific conditions were: the style had to be in keeping with the traditions of the city, NOT MODERN; a budget fixed by a bond issue; stipulated lot dimensions; champion basketball floor; entire floor visible from every fixed seat in the auditorium; twelve committee rooms; a large stage and grid; public address system and hard of hearing equipment; built under the uniform code.

As to the final budget, there were eight dollars unexpended when the city took over. The building occupied the site to the inch in depth. To satisfy the condition of visibility of the entire floor from every fixed seat, the amphitheater type was adopted. Much can be said in favor of this type of auditorium. In Europe is in becoming almost prevalent. Considerable study was spent on the acoustic problems. Acoustically it is said to be one of the best in the west. (That was a break.) The buildings are on concrete piles. The discovery that this was necessary was a blow.

Accurate cost figures are available. They had to be to get by the very efficient accounting of the P. W. A. which, by the way, was a fine

HOME OF MR. AND MRS. GEORGE A. DAVIS, ATHERTON, CALIFORNIA



An all concrete house. Even the major studs are concrete poured in place. Secondary wood studs, really nailing bucks, are spaced between the 6 x 6 concrete studs. The glorious oaks preclude a claim to all the landscaping.



FIRST FLOOR SECOND FLOOR

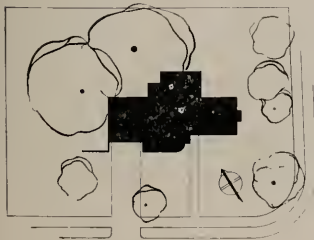

PLOT PLAN

FLOOR AND
PLOT PLANS



SANTA CRUZ MUNICIPAL AUDITORIUM



CARL W. ZOLLNER, STRUCTURAL ENGINEER

One-multi-purpose building that works. . . Twelve rooms in addition to a large stage and auditorium built of steel and concrete at a unit cost of 22c per cubic foot.



EXTERIOR DETAIL



FIREHOUSE



Each of the seven steel roof trusses would span San Francisco's Market Street from building line to building line. The auditorium can be evacuated of full capacity in less than four minutes.



AUDITORIUM, LOOKING TOWARDS STAGE

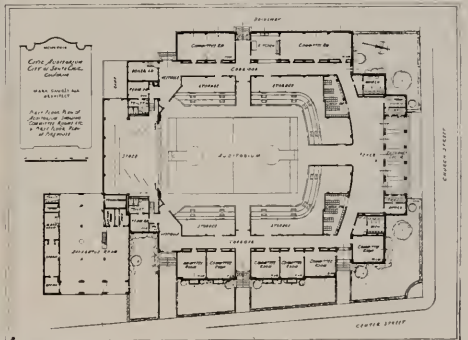
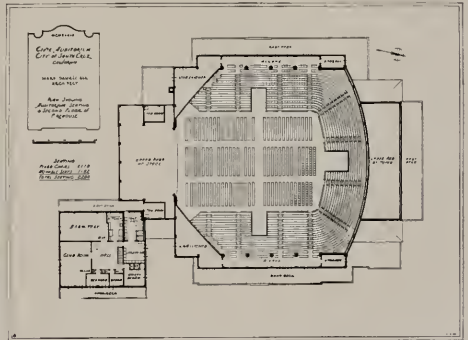

PLANS

MOUNT ST. MARY'S COLLEGE, LOS ANGELES



"Where there is no vision the people perish," wrote one of the Sisters of St. Joseph of Carondelet.



Mt. St. Mary's College in Los Angeles, on a lofty promontory, commands a view of the sea and nearly all of the city.

organization of reasonable, capable men. In the following, cubage is figured to the outside of all walls and eighteen inches below finished floors. It does not include concrete piles nor pile caps although cost of these is included in units of cost. The type is steel and reinforced concrete.

Total cubage of auditorium1,048,309 cubic feet
 Total cubage of firehouse..... 90,077 cubic feet

COSTS
Firehouse

	Total cost	Cubic foot cost
Bare construction	\$17,282	19.192c
Construction, equipment & architect's fee	\$24,926	27.677c
(Firehouse equipment is costly.)		
Total cost construction, equipment, legal, & interest while under construction	\$25,670	28.479c

Auditorium

	Total cost	Cubic foot cost
Bare construction	\$201,194	19.192c
Construction, equipment & architect's fee	\$227,112	21.664c
Total cost construction, equipment, legal, & interest while under construction	\$235,152	22.336c

MOUNT SAINT MARY'S COLLEGE

The Sisters of Saint Joseph of Carondelet are a very old order with a very broad vision. They chose the heights for their new college.

Educational and devotional structures should be looked up to, not down at. Fourteen buildings with adequate grounds were planned. Their completion will require years. The residence hall, here shown, includes an auditorium, sun decks, sleeping porches and such modern features as an open air fireplace on one of the decks. The chapel has just been completed in Spanish Gothic and the faculty building is under construction. Yes, you really can build a college residence hall so attractive that the girls prefer to toast their marshmallows at the fireplace of their own.

THE CHINESE VILLAGE

If anyone is looking for a field for a lifetime study of art, architecture and abstract beauty, let him turn to China, the home of philosophy. There, in the land of Lao Tze, Confucius, Mencius, Mecius, the land of the first brick building, the home of the modern frame structure, where in 3322 B. C., Fu Hsi developed the Pa Kwa of the eight natural phenomena, he can spend a lifetime of thrilling discoveries.

The field of architecture is alone inexhaustible. The variation in styles in the various provinces is as wide as the difference between a

THE SHELLY SHRINE, W. A. CLARK LIBRARY



Bequeathed by the late William Andrews Clark, Jr., to the University of California. World famous for its collection of Elizabethan literature, the library houses priceless volumes of Milton, Pope, Dryden, and the Shakespeare folios and many quartos. Buildings shown in this picture by Mark Daniels, Architect and Landscape Architect.

HOLLYWOOD RIVIERA CLUB, LOS ANGELES



As is customary in most beach clubs in Los Angeles, this also has a large swimming pool, so that those who come to the seashore can take a dip or, perhaps, a plunge.

THE PAGODA, G. G. INTERNATIONAL EXPOSITION



China, Mother of Moderns, "Mother of Gardens," offers about as many styles of architecture as does the rest of the civilized world, yet they are all Chinese. How they did it in only four thousand years is a mystery. All of this 134-foot structure that is occidental is the steel frame.



To the left, a double roof shop in Shensi style. To the right, a Pailou entrance done strictly in the style of Szechewan Province. The great flare of roofs and finials is characteristic of the western provinces.

Cape Cod cottage and a Hopi house in Arizona.

It was the desire of the Chinese that the architecture of their Village at the G. G. I. Exposition should exemplify, as accurately as practicable, the styles of the various provinces. They wanted no brown wax dummies stretched on a mat in a glass case, sucking an opium pipe. They wanted to show something of cultural China.

To cover them all was impossible, but the styles of the provinces of Chihli, Shensi, Kuangtung, Kiangsu, Szechewan and Honan were used. The Pagoda, with the exception of some minor details, fairly well reproduces the famous pagoda at Shanghai. The main gate, or Pailou, forty feet in height, shown in the background of the double roof shop, is closely in the style of Shantung province as developed in the noted

pailou in Yenchoufu. Other buildings not illustrated here, such as the pavilion of the Princess Derling, were in the Peiping style while one, larger, was accurately Chinese baroque.

Of the infinite number of forms in Chinese architecture that might contribute to our own, a very important one is their treatment of gable ends. There they—but enough. This is drifting into a treatise on Chinese architecture and I'm saving that for six elephant folios.

Yes, I would like to do them all over, with the possible exception of the carved brackets and posts in the Douglas Fairbanks, Jr. home. You see, I couldn't improve that—the wood carver is dead.

As to the Chinese buildings I most emphatically would like to do them over, over, and over again.



EXECUTIVE WING, BEL-AIR ADMINISTRATION BUILDING, LOS ANGELES, CALIFORNIA



LANDSCAPE VALUE OF TREES ON SMALL HOME GROUNDS

By RICHARD K. WILCOX

IN driving about the residential areas of Southern California, it might be observed that the houses which excite admiration and merit a second glance are invariably those whose owners have made a discriminating and intelligent use of trees. If you have ever watched the progress of a house under construction you have undoubtedly noticed the improvement that takes place after the building itself is completed and trees and shrubbery take their places to enhance and beautify the whole. The transformation is likened to a woman and her make-up; it is the finishing touch which makes a man venture a second glance.

Who does not enjoy the sight of a garden where trees provide shade, accent or background? With the large variety of evergreen trees available in Southern California, there is no one who must deprive himself of this pleasure, whether his house be located on a small city lot or surrounded by a large estate.

Trees in Southern California are as essential to a well planned garden as water is to a fish. However, in the majority of localities throughout Southern California, native trees in their natural habitat are not available to the home

builder, but these trees can be obtained from reliable nurseries for planting in your own grounds. It is not absolutely necessary that you employ a landscape architect to plan minor additions to your garden, as undoubtedly you know the spot where you would like to have a tree. It might be a patio or a terrace to shade; a barbecue to seclude; a feature in your garden to accent or frame; or there might be a location where a tree could be successfully used to insure privacy from neighboring property. But, on the other hand, if it is a new home you are planning to landscape, it is most advisable to consult a landscape architect so that you may be sure that the fine features of your home or surrounding areas will be used to the best advantage.

One of the best trees for use in the small home grounds is the *Ceratonia Siliqua*, also known as the Carob, or St. John's Bread tree. This is a handsome evergreen with rounded compact crown and clean, dark green foliage. It is an exceptionally fine shade tree for the average size garden in Southern California as it is a moderately rapid grower, attaining a maximum height of approximately thirty-five feet. The name, "St. John's Bread," derives

from the legend that the seeds and sweet pulp of the edible fruit pods are, respectively, the locusts and wild honey which St. John found in the wilderness. The dry valves or pods are also supposed to have been the husks referred to as the subsistence of the Prodigal Son in the Biblical parable. The Carob is a tree that is well adapted to the mild climatic conditions prevalent throughout the Southern California area, and, as pointed out, it is one of the finest of garden or shade trees. Its fruit is edible.

The **Tricuspidaria dependens**, or Lily of the Valley tree, derives its common name from its flower, which is similar to, though larger than, the lily of the valley. It is a fine ornamental tree whose foliage, at first glance, resembles the well-known California Live Oak in its grayish green tinge. It is a moderate grower and reaches a height of approximately thirty to forty feet. The **Tricuspidaria** is an evergreen somewhat pyramidal in shape and certainly deserves a place in the landscape of your garden. It is not particularly well known throughout this area, although it was introduced into Southern California from Chile some time ago. It is fine for the location in your garden which does not need heavy shade, as its habit of growth allows the sunlight to filter through, creating a pleasing effect.

The **Ulmus parvifolia sempervirens**, or Evergreen Chinese Elm, is another fine shade tree for any landscape. The arboreal effect created by its spreading habit and low growth can be used to advantage in many locations. It is ideal for patio shade, or for planting beside a garden pool, as its small drooping foliage

moves with the breeze to create a feeling of motion in the garden.

Another tree that has fine landscape value is the **Ficus microphylla**, or Small-Leaf Rubber Tree, whose heavy leaves are of a fine green color. Its tropical appearance is well suited to the majority of Southern California gardens and it can be used in almost any situation that is suitable to the **Ceratonia** or **Tricuspidaria**.

Entirely different in type from the trees mentioned is the **Cedrus Atlantica Glauca**, or Mount Atlas Cedar, a large pyramidal conifer of picturesque habit, valued as a landscape accent as well as for its ornamental appearance in the background or on the lawn. The hardiest of all cedars, it is a moderately rapid grower and may attain a height of 100 feet, in time. Its gray-green foliage is outstanding in any landscape, and it could be used at Christmas time for the well-known outdoor Christmas tree so conspicuous in the residential areas of Southern and Northern California during the festive season.

Residents of California are becoming increasingly "tree conscious" and with the expressed intention of keeping our state the garden spot of America, local clubs and municipalities are sponsoring and encouraging programs of tree planting. We should all support this movement by doing our share of planting, so take a tip and decide to do something about those barren areas in your yard or garden, thereby beautifying your home and adding to the appearance of your community. It has been said that "Beauty never follows commerce, but Commerce does follow Beauty."

Selected Details
by
Mark Daniels, Architect



A LION DOG

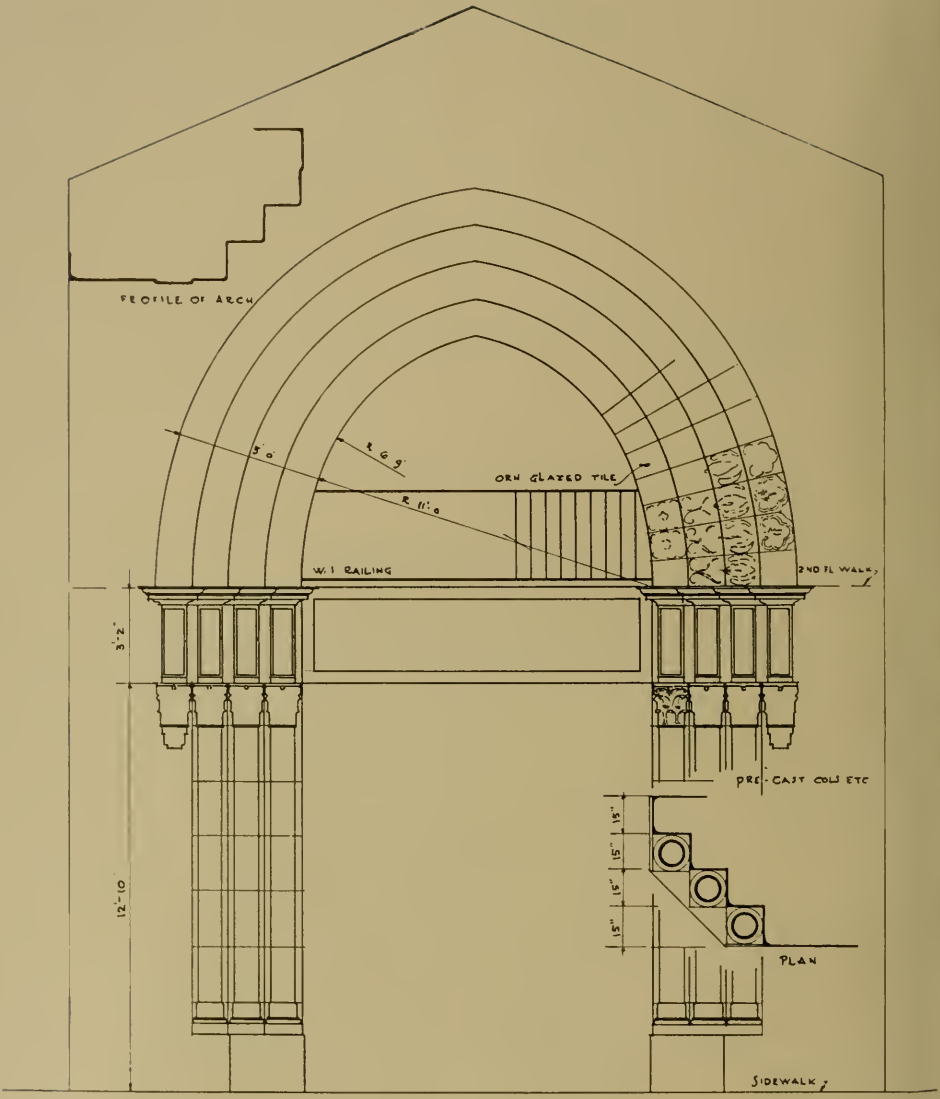

ENTRANCE
 CASTELLAMMARE BUILDING
 LOS ANGELES

CASTELLAMMARE BUILDING. LOS ANGELES



ENTRANCE DETAIL

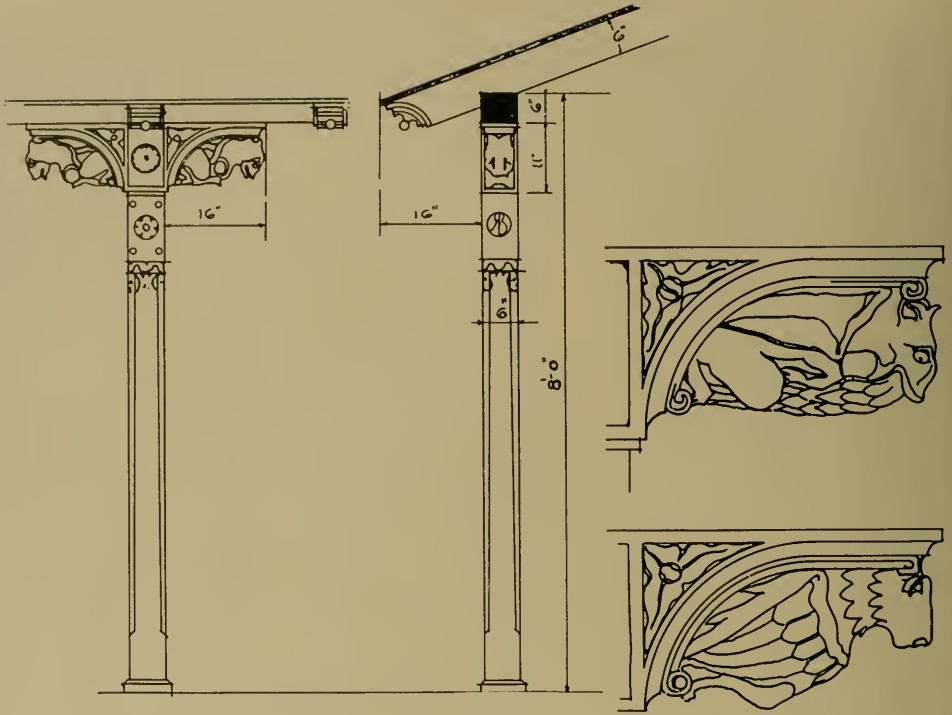

PATIO DETAILS
RESIDENCE OF
DOUGLAS FAIRBANKS JR.

DETAIL OF CARVED WOOD POSTS & BRACKETS

RESIDENCE OF DOUGLAS FAIRBANKS, JR.



LOGGIA POSTS AND BRACKETS

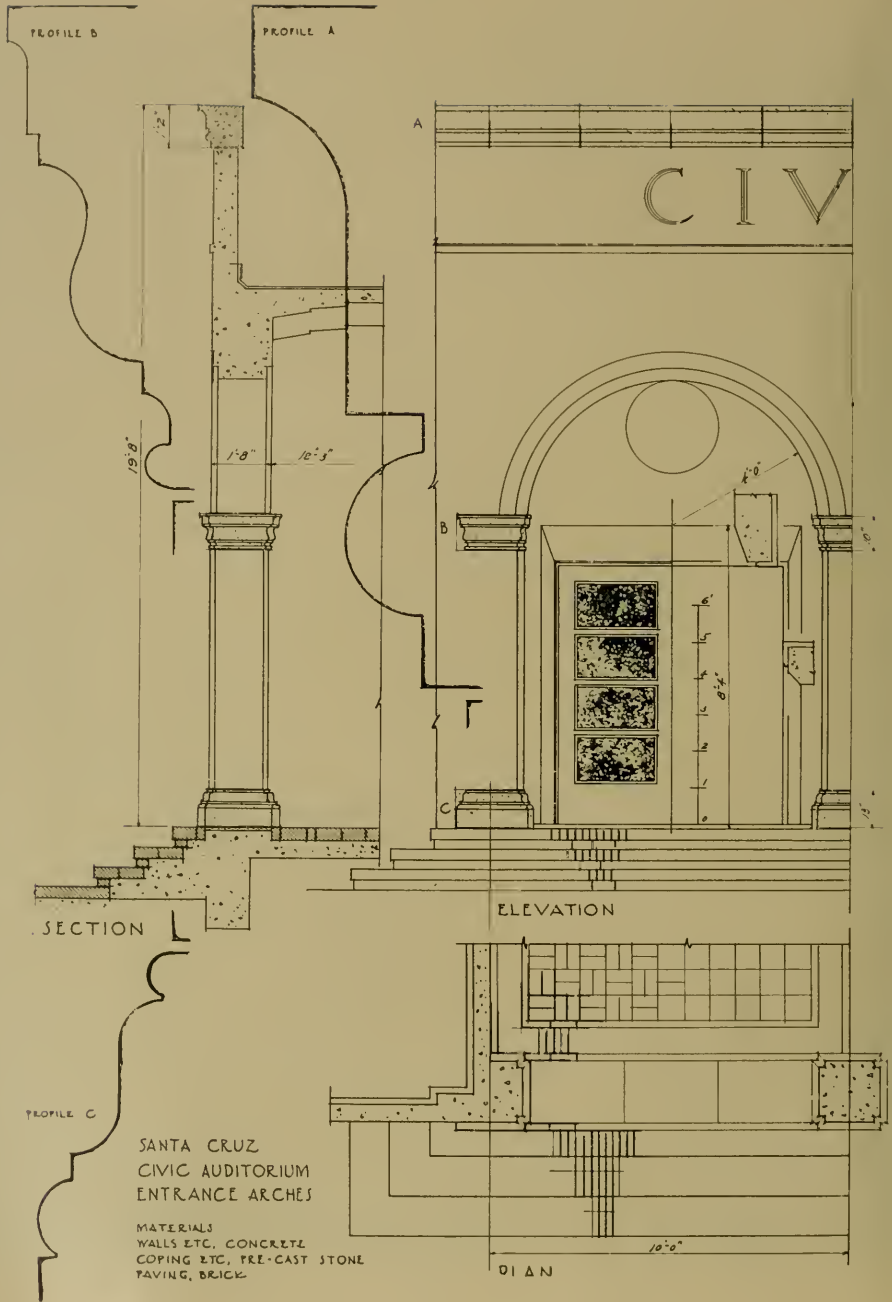

SANTA CRUZ MUNICIPAL AUDITORIUM



EAST ENTRANCE

STUDIO AT PEBBLE BEACH, CALIFORNIA



BENDING A HOUSE AROUND A TREE

"The lace of a thousand trees" is all the decoration needed on a well designed, simple wall.

HOUSE AT PEBBLE BEACH, CALIFORNIA



THE POPULARITY OF THIS HOME ON THE GOLF COURSE JUSTIFIES A REPEAT



Home of Dr. and Mrs.
Leighton Ray, Santa Rosa,
California
Mark Daniels, Architect

akes sunlight to make a house a home.



FILTER PLANT OF EAST BAY
MUNICIPAL UTILITY DISTRICT,
ORINDA, CALIFORNIA
MARK DANIELS, ARCHITECT

View of the gallery looking toward
the administration building. Only
half of the gallery is built.

INTERIOR OF THE GALLERY

Modern meters and controls direct
the filtering of all the potable
water for the cities of Oakland,
Alameda, Berkeley and neighbor-
ing towns.





ADMINISTRATION BUILDING . . . CHEMICAL BUILDING IN DISTANCE

Even in the country they must have light poles that spoil pictures.

FILTER PLANT OF EAST BAY MUNICIPAL UTILITY DISTRICT

By R. C. KENNEDY*

UNTIL the spring of 1929, the cities of Oakland, Berkeley, Alameda, Richmond, Piedmont, Albany, San Leandro, Emeryville and El Cerrito received their water supply from the runoff of local watersheds and from wells. Depletion of the underground storage and the uncertainty of the surface yield made necessary the development of a foreign supply, and it was determined that the Mokelumne River offered the most advantageous source.

During the first few years of use of the new water supply, it was dropped into the old San Pablo Reservoir, from whence it was drawn as required through the existing filter plant. This manner of operation resulted in a large increase in turbidity of the raw water and the loss of about 150 feet of head, much of which had to be regained by pumping. Studies showed that the increased cost of chemicals, plant operation and power was sufficient to pay for a new filter plant to handle Mokelumne River water alone in about seven years, and at the same

time a new independent feed into the distribution system could thereby be created. It was therefore decided to construct the Orinda Filter Plant.

The new plant was placed at the juncture of the Lafayette Tunnel, bringing the raw water from the distant source, the Claremont Tunnel, which carries the filtered product under the coastal hills to the East Bay cities, and the San Pablo Creek, which carries the excess raw supply and the used wash water down to the lower reservoir, to be held until needed.

The comparative freedom from turbidity of the Mokelumne water makes possible a large saving in plant and operating costs, since the usual sedimentation basins are not required, but provision has been made for adding facilities for this process in the future and the injection of the required coagulent chemical, should it become necessary. The filters are of the rapid sand type, with 16 rectangular beds, each 20 feet by 30 feet; arranged to operate in pairs but to be washed separately. This washing ar-

* Assistant Chief Engineer and Assistant General Manager, East Bay Municipal Utility District.



CHEMICAL BUILDING

When completed, the gallery will form an unbroken connection between this building and the Administration Building in the distance.

rangement results in economy in piping and involves only a few minutes of extra time in the washing process. After passing through the filters, the water is given a small dosage of lime to bring the "pH" to a determined value, followed by a light chlorine treatment. It then flows over a circular weir and into the Claremont Tunnel, from which it enters into the general distribution system.

The nominal capacity of the first unit of the Orinda Filter Plant is 42,000,000 gallons per day. Provision has been made for the construction of 24 additional filter beds as required in the future, with practically no interference with the operation of the original plant. When all of the beds have been completed, the capacity will be 105,000,000 gallons daily.

The Chemical Building was constructed for the ultimate capacity of the plant, since additions to this structure would be difficult to make. It has provision for storage of about 8,000 cubic feet of aluminum sulphate and quicklime, and several one-ton cylinders of

chlorine. The dry chemicals are elevated to the bins by means of pneumatic conveyors, and an hydraulic elevator is provided for handling other materials. Equipment is installed for feeding the dry chemicals at any rate desired, for dissolving the aluminum sulphate, slaking the quicklime and for feeding the chlorine dosage.

The Administration Building contains an office, laboratory, work shop, and a room containing lockers, tables, cooking facilities, showers, etc., for the convenience of the operators. A Service Building has been added recently, with space for storage of automobiles, garden equipment and fertilizers, and for laborers' quarters.

The country about Orinda is deeply involved in Spanish tradition, which is reflected in most of the existing buildings. It was therefore fitting that the new filter plant should be of Spanish architecture. All buildings are of solid concrete, wash-coated on the outside. The Administration Building and the operating room of the Filter Building have interior walls plastered



with textured stucco. The floor of the operating room and of the Administration Building entrance is of quarry tile. Battleship linoleum covers the floor of the office, laboratory and operators' quarters. Hand rails around openings in the operating room floor are made of aluminum tubes with flush joints. The property about the plant is largely in lawn, with conifers and low shrubs in the background, thus producing an attractive setting for the white buildings and red tile roofs.

The architect for the project was Mark Daniels, while the structural and hydraulic design was under the direction of the writer. The improvements were made under the general supervision of J. S. Longwell, chief engineer and general manager.

RESEARCH LABORATORY HAS UNIQUE STRUCTURAL FEATURES

BY HARRY SANDERS

A THREE story building with a plan as flexible as a stage set! A type of construction where there is almost a complete absence of structural elements in the exterior walls!

Such are the achievements of one of San Francisco's newest buildings—and certainly one of its best examples of modern architecture: the Ruth Lucie Stern Research Laboratory of the Stanford Medical School, Birge M. Clark, architect.

Requirements of a research laboratory, shift continuously, as Architect Clark explains, and frequently it is necessary to reconstruct the



PLANS. LABORATORY BUILDING FOR STANFORD UNIVERSITY MEDICAL SCHOOL

laboratories and work space. Hence, in the clever designs for the Stanford laboratory, the architect cantilevered floors and exterior walls from the fourteen central columns, thereby omitting all structural elements in the exterior walls with the exception of two columns on the front and two on the rear elevations.

This type of construction permitted the use of a continuous band of windows around the building and made it practical to use flexible interior partitions of wood studs and plywood. Since these partitions are easily moved or removed, it would appear that Mr. Clark has unlocked the meaning of the word "functional"?

There are continuous work counters under the windows on each floor, and below these counters run hot and cold water, sewers, gas, vacuum and compressed air; above the counters run metal boxes carrying direct current and alternating current. All heating elements are on the ceiling and are equipped with thermostatically controlled fans.

To save weight, Haydite concrete was used in the construction of the building, which was designed to withstand earthquake stresses developing lateral loads up to 10 per cent gravity. The interior is entirely utilitarian, the concrete being left exposed and the ceilings open.

A REPEAT PERFORMANCE OF GOLDEN GATE EXPOSITION

By E. N. KIERULFF

AS it is on the stage with a popular play so it is with the Golden Gate International Exposition on San Francisco's Treasure Island—there is to be a repeat performance by request.

San Francisco has always been loath to say farewell to any of its great and glamorous spectacles. Genuine sadness reigned when the Nineteen Fifteen Exposition finally closed its doors and the wish was expressed so many times, "Oh, why can't we have the Fair just a few more months." We are more fortunate with our Golden Gate Fair. We are to have "a few more months" to enjoy the color, lights,

fountains, gardens and varied attractions that delighted thousands through last year.

There has been real house cleaning over on Treasure Island—a refurnishing in all departments, making ready for May 25th. The promise is that the Exposition will be more breath-taking in its sheer beauty than it was on the original opening. All this has not been without effort, untiring effort and heartbreaking delay. First there was the contingent to win over which couldn't see the wisdom of having the Exposition again; then the money to be raised and pledged to insure the complete rehabilitation

(Turn to Page 52)

FIREPLACES

IN spite of the shortcomings of the old-fashioned fireplace—its poor construction, smoke troubles, high fuel consumption and loss of heat up the flue—it, nevertheless, has retained its popularity through the ages and today, fully modernized, it is as much an integral part of the home as the roof which protects it. Young and old sit before the open fire to dream of the future or to reminisce of the past. No home is truly a home without its fireplace.

In the last twenty years there have been many important improvements in fireplace construction. These betterments include a device that eliminates practically all of the unsatisfactory features of the old-time fireplace. The important problem of circulation has been solved by constructing around the fireplace a com-

plete double-walled metal form, with built-in damper made to proper dimensions to assure effective construction of throat and hearth. The device not only provides proper circulation of warm air in the room in which it is located but it helps to heat adjoining rooms. This metal form is known as the Superior Fireplace Circulator and in addition to providing better circulation the device eliminates smoke troubles and reduces installation costs (masonry) to a minimum. The circulator in no way limits the variety of designs of a fireplace in keeping with whatever style of architecture desired, as shown in the accompanying illustrations by courtesy of the Superior Fireplace Company of Los Angeles.

Fluted, glazed, vitrified composition forms the face of this fireplace and a metal bar holds the sliding mesh fire screen. Note the warm-air outlet near the ceiling.





Upper photo shows possibilities of modern design for living room fireplace. The corrugated effect is obtained by using specially milled $\frac{3}{4}$ -inch half round from $1\frac{3}{4}$ x 6-inch boards, tongue and grooved, and placed over the bricks. Eight-inch black glazed tile form the trim.

At the right is an interesting red brick fireplace framed by knotty pine walls.





The Spanish influence is reflected in the fireplace pictured above. The bricks are of native California adobe, painted white. Intakes and outlet are formed of masonry.

Fireplace below is built of red brick, suitable for ranch house or mountain lodge. Split bricks are spaced to allow a maximum of warm air passage.



SOME SUGGESTIONS FOR LIGHTING MUNICIPAL AUDITORIUMS

By NATHAN H. GRAVES

RECENTLY, I returned from the first annual conclave of the Illuminating Engineering Society in Los Angeles, at which numerous papers were presented on today's lighting problems in our civic auditoriums.

During the discussion of several of these papers it was interesting to note that members of the architectural profession laid the lack of improper use of artificial lighting and general misinformation, directly in the laps of the illuminating engineers. This is undoubtedly justifiable, in many instances, though if the architect, when planning a new structure or remodeling an old one, will consult with an illuminating engineer and request that all lighting be of such quality as to incorporate the latest practices and standards as set up by the Illuminating Engineering Society, he may feel assured that his lighting will be everything that he and his clients desire.

* * * * *

In the lighting of municipal auditoriums there are several primary factors to be considered, the most important of which is the amount set aside in the budget to take care of the entire artificial lighting system.

First, there must be adequate service capacity to handle all lighting and power requirements. Modern practice recommends the installation of the fuseless type of switchboard, which eliminates the necessity of spare fuses or copping to take care of overloads. The switchboard is simple to operate and the most inexperienced can place a circuit back in use by a simple re-set operation. From the main service, adequate copper should feed to several other points of distribution where similar type switching arrangements are located. Though this type of switchboard normally costs approximately twice as much as the

dead-front fuse type panel board, its advantages more than offset the extra cost, and when charged off over a number of years does not add materially to the annual cost of such a long lived installation. The wire sizes used in feeding the various panels as well as in the branch circuits, should be such that there will be not more than a 2 per cent drop in voltage between the switch and the end of the longest circuit, with all lamps burning. This will insure the greatest possible amount of light with the least loss from voltage drop. Because public auditoriums are only periodically used, and because at such times practically all the lights are turned on, a load factor of not less than 80 per cent should be used in estimating service and feeder capacity. It might be added that in laying out the wiring for an auditorium and its stage, dimmer loops should be provided so that dimmers may be placed in the circuit to control any lighting at some future date. The use of dimmers in any such installation provides for a flexibility and smooth control of light that would be impossible without them.

MARQUEE AND LOBBY

In lighting auditoriums it might be well to start at the entrance and from there work back. Some sort of a marquee is usually provided. On the face of this, electrical service should be installed for the use of a replacement type letter sign for announcing any current features. On the under side of the marquee, lighting should be installed; this may be elaborate or simple, according to the budget, though of a type that will make the entrance to the auditorium attractive.

The function of the outer lobby is principally that of a passageway to the foyer. The lighting should create a feeling of spaciousness, no matter what type is used. This can be accom-

plished by having ceiling and wall areas of a fairly high brightness. It is recommended that 10 to 20 footcandles as measured on the horizontal plane be used for general illumination. This fulfills the necessary intermediate level of illumination to accustom the eyes to a difference between the high level outside lighting and the darkened auditorium. The wall areas may well be used for advertising space for coming attractions, provisions should be made for advertising these displays. A number of the types of lighting that can be used in this area are, for example, lamps recessed at ceiling line, making a continuous luminous element when covered by louvres or white flashed glass.

In the use of silver bowl lamps in architectural coffers, it is recommended that these be louvered in such a way as will best tie in with the design elements of the room. Another interesting treatment is by the use of beam elements with coves added to the lower edge to create a broad silhouette ceiling pattern. Still another way is the use of continuous recessed reflectors, the outer face of which will be covered with flashed glass. These may be inserted in the walls, horizontally or vertically, or in the ceiling in straight lines or in geometric pattern. This latter type of installation calls for proper engineering to eliminate the possibility of spottiness from lamp sources, and overbrightness from the flashed glass. Particular care should be taken when this type of installation is planned, though it is usually very successful when incorporated in modern style of architecture, if the surface brightness per square inch is kept low.

THE LOUNGE

In the foyer, which is commonly known as the promenade or lounge, a type of lighting should be installed incorporating features that will bring out more of the aesthetic appeal, and should be somewhat lower in levels of illumination, usually from 3 to 5 footcandles. This serves to condition the eyes, and the order of illumination dispels any feeling of dinginess or gloom. This inner lobby also serves as the distributing center to the auditorium entrances and exits, and should, therefore, be provided with recessed type spotlights to light the ushers

standing at the doorways. Interestingly lighted architectural elements are often used in the general decoration of this area. They are too numerous to list, but in the case of statuary, a most pleasing effect can be created by lighting the image from two or three locations. This lighting is best done by the use of recessed spotlights, with proper lens controlling devices so that the image appears luminous and no stray light meets the eye of the casual on-looker. One of the first successful installations of this type was done several years ago in the Louvre in Paris, France, where the lighting designers took pictures of the statuary from a location identical to that where the spotlights would be located, and then from the picture cut metal mats that were inserted in the spotlights, giving a perfect control to the beam pattern.

AUDITORIUM PROPER

On moving into the auditorium we are presented with two types of lighting problems. (1) Lighting that will give a level of illumination sufficient to provide ease in reading programs, and (2) a type of lighting that should be of a very low level, as it is used during performances and often is entirely of a decorative nature. For general illumination a method often used is stepped coves, which are usually wired on two or three alternate circuits so that color can be introduced. New light sources, such as the fluorescent lamp and the ultra violet generating type of lamp, are used to good advantage in these coves. The fluorescent, of course, produces a smooth level of white light. In the case of the ultra violet lamp, fluorescent paints are often applied in design pattern to the ceiling and when the lights are on produce both decoration and light. In Los Angeles a manufacturer of rugs has come out with a product that incorporates the use of fluorescent dyes for floor coverings. These rugs, when lighted with ultra violet light, create an unusual effect and replace the aisle lights, which would otherwise be necessary. Lighting for the auditorium space may also be done by the use of ceiling coffers, properly designed hanging fixtures, silhouette strip lighting, recessed pin spots or concentrat-

ing type reflectors installed in the ceiling with decorative louvres or suspended glass panels with lamps concealed above. Indirect wall urns, cast of plaster or molded in glass, or one of the newer plastics, can be very nicely used in the smaller type of auditorium. It is recommended that because each auditorium presents its own individual problem, that proper consideration for the lighting be given when the original design is planned. Of course it is necessary to provide proper type exit lights over all doorways.

THE STAGE

Lighting for the stage may be as simple or elaborate as the budget will permit. Therefore, I will recommend only a type of installation such as is installed in the new Santa Cruz Auditorium illustrated in this issue. Border lights should be hung from the grid and counter-balanced so that they can be raised or lowered with ease. These border lights should be wired on three operating circuits, and provided with color mediums. Disappearing footlights are most satisfactory for public auditoriums. These should be so wired that it will be impossible to turn them on when they are lowered. Stage floor convenience outlets should always be provided, with a minimum of three to each side of the stage. It is suggested that a four-gang type outlet be installed at the front of the stage on either side and wired for 50 amperes capacity, the remaining four floor outlets should be of the two-gang outlet type and wired for 20 amperes each. Provision should be made on the switchboard to control separately each of the floor outlets. Other equipment for the production of plays, musicals, or operas should include at least six 1,000-watt hanging type olivettes, four 1,000-watt stand type olivettes, at least three hanging type border light spotlights, two 1,000-watt stand type spotlights, and a minimum of three footlight spotlights.

If there is a balcony in the auditorium, wiring should be installed so that several (at least three) 1,500-watt spotlights may be mounted on the face. Projection booth equipment should include movie projection equipment that will take sound film and spotlights, using the new 2,000-watt projection lamps. The control of all

equipment should be such that any or all of it may be used at one time. Dimmers are especially important for the stage lighting equipment. No modern auditorium should go unwired for a public address system, and a telephonic control between the switchboard, the projection booth and the orchestra should be provided. The orchestra should be furnished with sufficient convenience outlets to provide service for the orchestra standlights.

The above outline is somewhat sketchy, but covers many of the salient features found in auditoriums of the Santa Cruz type. It is always well to provide an emergency lighting system, usually from storage batteries or some other method, as a precaution against panics that might take place were the auditorium to go into complete darkness.

A REPEAT PERFORMANCE

(Continued from Page 46)

and to carry on during the months when the Fair lay idle.

Someone has said that San Francisco can always do a thing if it puts its collective shoulder to the wheel, particularly when it is something San Francisco wants. We must have wanted our Exposition pretty badly to go to the lengths we have gone, but the principal thing is that we are to have a Fair in 'Forty and we can do naught else now but give it every encouragement possible; talk it up, sell it far and wide, go as often as our pockets will let us. For when this session is over there will be no more gardens with fountains like a fairy land, no more glamour, or music on Treasure Island and the Golden Gate Exposition will be but a memory.

There will be new shows, new music, new color, replanted gardens; the bay will sparkle, the lights will gleam and afternoon and evening San Franciscans will stream eastward through the old Ferry Building bound for a brief stay in a dream world, flinging care to the four winds as only San Franciscans can. The Architect and Engineer is happy to extend the heartiest wishes to the people who have made the reopening possible and to bid it's readers to go, see and enjoy again this fairyland of beauty.

ARCHITECTS' BULLETIN

Issued For

THE STATE ASSOCIATION OF CALIFORNIA ARCHITECTS
Northern Section

STATE ASSOCIATION MEMBER
OF THE
AMERICAN INSTITUTE OF ARCHITECTS

Editor
Harris C. Allen

Address all communications for publication
in the Bulletin to the Editor (Harris C.
Allen) 557 Market Street, Room 218, San
Francisco, California.

STATE ASSOCIATION OFFICERS

President.....Ernest E. Weihe, San Francisco
Vice-Pres.....Merrill W. Beird, Glendale
Secretary.....Robert H. Orr, Los Angeles
Treasurer.....Mario Ciampi, San Francisco

Regional Director—Southern Section

Gordon B. Kaufmann, Los Angeles

Regional Director—Northern Section

Harry M. Michelsen, San Francisco

Executive Board—Northern Section

Officers

President.....Ernest E. Weihe, San Francisco
V. Pres.....Frederick H. Reimers, Santa Barbara
Secretary.....Vincent Raney, San Francisco
Treasurer.....Mario Ciampi, San Francisco

Directors

Herold H. Weeks and Wayne Hertzka
(for one year)

Harry J. Devine and William C. Ambrose

Executive Board—Southern Section

Officers

President.....Merrill W. Beird, Glendale
Vice-Pres.....Winsor Soule, Santa Barbara
Secretary.....Robert H. Orr, Los Angeles
Treasurer.....Sylvanus B. Marston, Los Angeles

Directors

A. M. Edelman, George D. Riddle
(for one year)

Sam W. Hammill and Ben H. O'Connor
(for two years)

Northern Section Advisory Council

San Francisco District:

Frederick H. Reimers (President)

J. K. Ballantine, Jr. (Secretary)

Harris C. Allen

Dodge A. Riedy

Ernest E. Weihe

Mario J. Ciampi

Conrad T. Kett

Roland I. Stringham

Wm. H. Knowles

Vincent Raney

North Bay:

J. C. Felciano

Lower San Joaquin:

H. G. Bissell

Santa Clara

Chester Root

San Mateo:

Clyde Trudell

Upper Sacramento:

Casebolt Dakin

Sacramento:

Alfred Eichler

Upper San Joaquin:

David Horn

Monterey Bay:

Robert Stanton

Palo Alto:

Birge M. Clark

Marin:

Jas Bertenshaw

East Bay:

Irwin Johnson

Jas. H. Anderson

Ralph N. Kerr

Berkeley:

Gwynn Officer

Redwood Empire:

F. T. Georgeson

Lassen:

Ralph Taylor

1940 Treasure Island Fair

A JOINT appropriation has been made by the State Association of California Architects and the Northern California Chapter, AIA, to cover initial expenses for representation in the 1940 Golden Gate Fair. This will be in two sections; one, an exhibit of photographs and art objects—to be in the Fine Arts Building—the other an exhibit of scale models of buildings, to be in the Construction Industries Building, which is on the east side of the Court of the Moon.

Two committees have been appointed. For the exhibit of photographs and arts, Norman Blanchard is chairman and Ernest Born vice-chairman. For the exhibit of models, Vincent Raney is chairman and William Merchant and Mario Ciampi are on the committee.

For the four months of the Fair, it is estimated that seven million people will attend. Naturally most of these will be out-of-State visitors, but it is safe to assume that more local citizens will see these exhibits than recorded for any previous showing.

President Ernest Weihe will go to the 1940 Convention of the Institute, to be held at Louisville, Kentucky, the latter part of May, as Official Delegate of the California State Association. If the proposed unification program is adopted, our Association will have at least seven delegates at the 1941 Convention. There are many attractions in the Blue Grass State which appeal to Californians—beautiful women, horses, whisky—perhaps it is just as well we have but one delegate this year. There can be no passing the buck when it comes to reporting the activities and actions of the Convention proper.

Norman Blanchard and his Public Relations Committee have been meeting and stewing over the problems of publicity in its many forms, and what would be efficient and what would be feasible, for the past two months. The Committee report is again delayed, but another month ought to round out the program. This is pregnant with possibilities; after laboring for all these months, what will the mountain deliver?

Here we have been picking bits and tidbits from the Bulletin of the Michigan Society of Architects and reprinting them in our own modest columns, and lo! and behold! if they don't go and reprint an article from our monthly. Well, to be frank, it wasn't really an article; it was a letter from that indefatigable opinion-expressor, Harry Michelsen, commenting favorably on the article by President Kenneth Black of the Michigan Society, which had adorned our pages by courtesy, and throwing in a few extra points and comments—as Harry will, you know. Have we started an Alphonse and Gaston affair in our profession?

SOUND PRACTICE

And so we are going to reprint another jewel from the treasure house of the Michigan Society of Architects' Bulletin. This is a definition of sound architectural practice which was adopted at the MSA 1938 Convention, which is not a code of ethics but is certainly a standard of professional service:

REQUIREMENTS, ARCHITECTURAL PRACTICE—STATE OF MICHIGAN.

"Professional Architectural Practice is any service of an advisory character, which requires architectural knowledge, experience and skill, for which a charge is made, when such service is not influenced by prejudicial interest in the pertinent project.

"When the project is of such character as to require that the advice of the Architect be recorded in the form of documents, professional architectural service is interpreted as including the preparation of drawings and specifications, either or both. These, as instruments of service, are the property of the Architect and may not be reproduced or used without his knowledge and consent.

"When the drawings and specifications are intended to become the documents upon which to base a contract, they shall be sufficiently complete to determine the amount, kind and quality of workmanship, materials and equipment to be furnished, and shall be so prepared that the work shall comply with all governing codes, ordinances and regulations, and with sound architectural practice.

"Complete architectural service is interpreted as including the necessary conferences, the preparation of preliminary studies, working drawings and specifications, the drafting of proposal forms, the taking of bids, the drafting of the contract and the supervision of the construction, also the preparation of large scale and full size details and such bulletins as are necessary to explain and amplify the contract documents, the keeping of records of inspections and issuing certificates of payment and the keeping of records of all transactions and correspondence relating to the work.

"The Architect's supervision is held to refer to the enforcement of the terms of the contract documents and is distinguished from the superintendence furnished by the Contractor or the continuous inspection on the part of a Clerk-of-the-Works employed by the Owner and selected by the Architect.

"As Advisor to the Owner, the Architect cannot guarantee estimates of cost or the satisfactory performance of the work but can only endeavor to obtain compliance with the contract documents. The Architect is the Owner's Agent with respect only to work covered by the contract documents.

"The Architect may contract with an Owner for complete or partial service but he may not contract to furnish supervisory service to enforce the documents

prepared by another Architect without the latter's consent and approval.

"If the Architect contracts with an Owner to furnish less than complete architectural services, he shall indicate on all documents pertaining to that particular work, the extent of the service which he is performing. All incomplete documents shall be labeled 'Not to be used for Construction Purposes.'"

MISS SPRAGUE PASSES

On April 24, Miss Bessie Sprague died suddenly in her sleep, at her Berkeley home. For 32 years Miss Sprague served efficiently as secretary and librarian in the School of Architecture at the University of California. Incisive and positive in character, her advice and guidance were appreciated by both faculty and students. Miss Sprague had a unique personality, and hundreds of graduates will honor her memory with a smile and a sigh, a tribute to her loyalty, integrity and efficiency.

ARCHITECTURAL EXHIBIT AT FINE ARTS

An exhibition of photographs and plans of recent work by leading California Architects, will be one of the 1940 features in the Palace of Fine Arts, Golden Gate International Exposition. Financial support has been promised by both the Northern California Chapter, A.I.A., and the State Association of California Architects. The show will be in charge of Ernest Born who so successfully handled a similar exhibition in the Fine Arts Building, San Francisco Civic Center, two years ago.

This exhibition in the Palace of Fine Arts should not be confused with the proposed "Gallery of Masterpieces of California Homes" in the Homes and Gardens Building, which is to a considerable extent a commercial enterprise open to "any architect home builder, home owner or member of a company interested in the encouragement of home building," upon payment of a fee of \$10 for each house submitted.

In other words, no matter how good your house may be, architecturally or otherwise, your exhibit is "out" unless you subscribe \$10 a picture.

"CALIFORNIA, HERE WE COME!"

California architects attending the A. I. A. Convention in "Kaintucky" are expected to make an effective drive to bring the 1941 meeting to California. With the Institute's president, Edwin Bergstrom, pulling for the Golden State and solidly backed by the Pacific Coast delegation, there would appear to be little possibility of the Convention turning down the invitation. The Institute Journal for March paved the way by publishing a tentative program with four pages of enticing literature describing our beautiful scenery and interesting points for visitors—such as the Yosemite, San Francisco and Los Angeles; with side trips north into Canada and south into Mexico.

With the Architects

BEAUTY IN ARCHITECTURE

Architects in the Pacific Northwest are still enjoying memories of a recent visit to Seattle and Portland of Dr. William Emerson, dean emeritus of the Massachusetts Institute of Technology, and his well-worded discussion of "Beauty in Architecture."

Essaying a definition of beauty, Dr. Emerson explained that "the thing sought is far too subtle to be the product of any formula, for beauty lies in the eyes of the beholder. One should be trained to the recognition of beauty without interfering with expressions of personality. Students should have their perceptions sharpened and their standards raised. They say if it's functional, it's beautiful. Here Dr. Emerson hesitated a little, then went on: "And now look at the damn thing." Architecture, according to him, loses its very soul if devoid of beauty and there are "infinite varieties of expressions of beauty—often the product of faith and sincerity and harmony, or possibly color and form, in a myriad subtleties."

The most practical-minded of those who enjoyed Dr. Emerson's lecture appreciated his contention that "Beauty, even if it costs a little more in dollars, will pay dividends in national culture."

ARCHITECTS' DRAWINGS EXHIBITED

Model-community drawings by William Wilson Wurster of San Francisco have been added to the permanent architectural exhibit in the Richmond City Hall.

The exhibition is sponsored by the Richmond Civic League in an attempt to make the city one of the most beautiful industrial centers in the West.

Other architects who have contributed to the collection are Prof. Michael Goodman, University of California; George P. Simonds, Roland Stringham, Keith Narbett and Paul Hammarberg.

ARIZONA CHAPTER ELECTS

Frederick W. Whittlesey of Phoenix has been elected president of Arizona Chapter, American Institute of Architects, succeeding M. H. Starkweather of Tucson. Other officers are: Richard A. Morse, Tucson, vice-president; Charles J. Gilmore, Phoenix, secretary, and Josias T. Joesler, Tucson, treasurer (reelected). Mr. Starkweather was elected member of the executive committee for a three-year term. Hold-overs of the committee are: Royal W. Lescher, Phoenix, and Roy Place, Tucson.

FIRST PRIZE WINNER

Edwin Peterson, Spokane architect, won the first prize of \$150 in the competition for the design of a \$4,000 residence, conducted by the Spokane Better Housing Commission.

ARCHITECT'S WORK RECEIVES RECOGNITION

Arthur Brown, Jr., is the only San Francisco architect to receive an excellence in design award by the Fifth Pan American Congress of Architects, held recently in Montevideo, Uruguay. Brown received a silver medal and diploma for his design of the Department of Labor and Interstate Commerce Commission Building, Washington, D. C.

Other Pacific Coast architects given awards, out of a total of 143 in the United States, were:

Gordon B. Kaufman of Los Angeles—Boulder Dam and Power House, Colorado River, Colorado.

Bertram Grosvenor Goodhue and Carleton Monroe Winslow of Los Angeles—California State and Fine Arts Building, San Diego.

Reginald D. Johnson of Los Angeles—Santa Barbara Biltmore Hotel, Santa Barbara.

Richard J. Neutra of Los Angeles—School buildings, Los Angeles.

John Parkinson and Donald B. Parkinson of Los Angeles—Los Angeles Coliseum.

Marston & Maybury of Pasadena—Pasadena Public Library, Hill Avenue Branch, Pasadena.

Albertson, Wilson & Richardson of Seattle, Wash.—Church of St. Joseph, Seattle, Wash.

CHICAGO SCHOOL OF DESIGN HERE

Considerable interest is being aroused in western art circles by the announcement that the Chicago School of Design, directed by L. Moholy-Nagy, will spend the summer on the Mills College campus, Oakland, June 23-August 3.

Moholy-Nagy will bring with him from Chicago four members of his staff: Mrs. Marli Ehrmann, Gyorgy Kepes, Charles Niedringhaus, and Robert Jay Wolff. Together they will give a course in "Bauhaus Practice and Its Present-day Development," consisting of a basic workshop, workshops in drawing, modeling, color, photography and weaving. Moholy-Nagy, formerly a master at the Bauhaus in Germany, will also offer a seminar in contemporary art problems, designed especially for architects and craftsmen wishing advanced work with him.

MOVES TO TEXAS

Acquaintances of Norman W. Kelch, formerly secretary-manager of the Clay Products Institute of California, will doubtless be interested in the announcement that he has recently been named to a similar position with the Clay Products Association of the Southwest, with headquarters in Austin, Texas. Inquiries concerning the association may be addressed to P. O. Box 4, Austin, Texas.

MODERNIZED PRODUCTS

Brief Notes on New Materials and Equipment in the Building Industry.

378. FLOOR POLISH

Glyco Products Company have issued a booklet dealing with the essential chemicals used in various floor polishes and finishes for automobiles, walls, etc. The booklet is well arranged and gives formulae and lists of basic ingredients. Use the coupon below to secure your copy.

379. INSULATION

"Housing for Farm Profits" is the title of a new booklet by Celotex in which is to be found some interesting data on guaranteed insulation for dwellings, barns and all other farm buildings.

380. AIR CIRCULATORS

Emerson Electric Company have a brochure describing their new Air Circulators, "The Modern Way to Summer Comfort." These can be used in homes, business quarters and in industry. Send in the coupon to obtain a copy.

381. STEEL "LUMBER"

The April issue of the Electromet Review, little sheet put out by Electro Metallurgical Company, has some interesting facts and data. Of special interest is the article on stainless steel "lumber," and a new, flexible alloy screen cloth. The coupon below will bring you a copy.

382. BATH CABINET

A stainless steel bathroom cabinet is the latest product of National Metal Products Company. Equipped with plate glass mirror, the cabinet comes in three sizes. Data and further information can be obtained by using the coupon.

383. PRESERVATIVE

Western Pine Association has a new revised technical bulletin describing "Permatol," a preservative treatment for exterior mill work. This leaflet contains some very valuable data and technical information.

384. WALL FINISH

A nicely arranged booklet on

"Transite" walls, a product of the Johns-Manville Company, is out. Details concerning the methods of applying and certain data on the product are given. Send in the coupon.

385. ARC WELDING

An elaborate booklet issued by the James F. Lincoln Arc Welding Foundation has been received. It details the \$200,000 industrial progress program (award). Complete tables and illustrations are included.

386. PAINT

"Paint Progress," the little magazine put out by New Jersey Zinc Company, is here again. This number contains an interesting article and pictures Dust Bowl refugees, the camps being built for them in various localities and the paint problem in connection therewith.

387. PORCELAIN ENAMEL

The Porcelain Enamel and Manufacturing Company have a new brochure on the application of porcelain enamels to steel. This is really a fine brochure and has a definite place in the industrial literature listed this month. Send for a copy by using the coupon.

388. HEATERS

Bulletin No. 140-A, issued by Modine Manufacturing Company, deals with this firm's equipment, especially the vertical delivery unit heaters. This piece of new equipment is fully described and tables of data are included.

389. ELECTRODES

Wilson Welder and Metals Company have a new booklet describing and detailing their arc welding electrodes. Full details and technical information is given. Send for a copy. Use the coupon.

390. SWIMMING POOLS

Swimming pool equipment and shower room water mixing valves are two new subjects to receive detailed data in booklets by the Josam Manufacturing Company. Both of these in-

teresting booklets will be sent you upon receipt of the coupon below. The water mixing valves offer protection against accidental scalding.

GARAGE DOOR HARDWARE

The Frantz Manufacturing Co., of Sterling, Ill., pioneers in the manufacture of quality hardware, report increasing sales of their "Over-the-Top" garage door hardware.

The Frantz Sales Company, with headquarters in Los Angeles and offices in San Francisco and Portland, are distributors of this hardware in the Pacific Coast states. They are not only interested in selling hardware but in rendering installation service. They have divided the State of California into districts and named authorized distributors for each.

FREE FOR THE ASKING

Check items on coupon, paste on letter head or postal card, and mail to Architect and Engineer.

Architect and Engineer
68 Post Street
San Francisco, Calif.

Please send me literature on the following items as checked below. This places me under no obligation.

378 384
379 385
380 386
381 387
382 388
383 389
390

My Name.....

Name of Company.....

Street.....

City.....State.....

Estimator's Guide

Giving Cost of Building Materials, Wage Scale, Etc.

Amounts given are figuring prices and are made up from average quotations furnished by material houses to San Francisco contractors. 3% Sales Tax on all materials but not labor.

All prices and wages quoted are for San Francisco and the Bay District. There may be slight fluctuation of prices in the interior and southern part of the state. Freight cartage, at least, must be added in figuring country work.

Bond— $1/2\%$ amount of contract.

Brickwork—

Common, \$40 to \$45 per 1000 laid, (according to class of work).
 Face, \$90 to \$100 per 1000 laid, (according to class of work).
 Brick Steps, using pressed brick, \$1.00 lin. ft.
 Brick Veneer on frame buildings, \$0.70 sq. ft.
 Common f.o.b. cars, \$14.00 at yard. Cartage extra.
 Face, f.o.b. cars, \$45.00 to \$50.00 per 1000, carload lots.

HOLLOW TILE FIREPROOFING (f.o.b. job)

3x12x12 in. \$ 84.00 per M
 4x12x12 in. 94.50 per M
 6x12x12 in. 126.00 per M

Building Paper—

1 ply per 1000 ft. roll \$3.50
 2 ply per 1000 ft. roll 5.00
 3 ply per 1000 ft. roll 6.25
 Sisalkraft, 500 ft. roll 5.00
 Sash cord com. No. 7 \$1.20 per 100 ft.
 Sash cord com. No. 8 1.50 per 100 ft.
 Sash cord spot No. 7 1.50 per 100 ft.
 Sash cord spot No. 8 2.25 per 100 ft.
 Sash weights cast iron, \$50.00 ton.
 Nails, \$3.50 base.
 Sash weights, \$45 per ton.

Concrete Aggregates—

Gravel (all sizes) \$1.45 per ton at bunker; delivered to any point in S. F. County \$1.85.

	Bunker	Delivered
Top sand	\$1.45	\$1.85
Concrete mix	1.45	1.85
Crushed rock, $1/4$ to $3/4$	1.60	2.00
Crushed rock, $3/4$ to $1 1/2$	1.60	2.00
Roofing gravel	1.60	2.00
City gravel	1.45	1.85
River sand	1.50	1.90

Delivered bank sand—\$1.00 per cubic yard at bunker or delivered.

	Bunker	Delivered
River sand	\$1.50	\$1.90
Lepis (Nos. 2 & 4)	2.00	2.40
Olympia Nos. 1 & 2	1.80	2.20
Headburg plaster sand	1.80	2.20
Del Monte white	1.80	2.20

Del Monte white \$1.80 per sack

CEMENT (all brands, common, cloth sacks) \$2.72 per bbl. f.o.b. car; deliv. \$2.90 per bbl., carload lots; less than carload lots, warehouse or deliv. 80c per sack. (Less 10c per sack returned, 2% 10th Prox.)

Common cement (all brands, paper sacks) carload lots \$2.52 per bbl. f.o.b. car; delivered, \$2.70; less than carloads delivered, 75c per sack. Discount on cloth sacks, 10c per sack. Cash discount on carload lots, 10c a barrel, 10th Prox.; cash discount less than carload lots, 2%.

Atlas White } 1 to 100 sacks, \$2.60 sack,
 Calaveras White } warehouse or delivery;
 Medusa White }

Forms, Labors average \$40.00 per M.
 Average cost of concrete in place, exclusive of forms, 35c per cu. ft.; with forms, 60c.
 4-inch concrete basement floor $12\frac{1}{2}$ to 14c per sq. ft.
 Rat-proofing $7\frac{1}{2}$ c per sq. ft.
 Concrete Steps \$1.25 per lin. ft.

Dampproofing and Waterproofing—

Two-coat work, 20c per yard.
 Membrane waterproofing—4 layers of saturated felt, \$4.50 per square.
 Hot coating work, \$1.80 per square.
 Medusa Waterproofing, 15c per lb., San Francisco Warehouse.
 Tricoel waterproofing.
 (See representative.)

Electric Wiring—\$12.00 to \$15.00 per outlet for conduit work (including switches).
 Knob and tube average \$3.50 per outlet.

Elevators—

Prices vary according to capacity, speed and type. Consult elevator companies.
 Average cost of installing an automatic elevator in four-story building, \$2800; direct automatic, about \$2700.

Excavation—

Sand, 60 cents; clay or shale \$1 per yard.
 Teams, \$12.00 per day.
 Trucks, \$22 to \$27.50 per day.
 Above figures are an average without water. Steam shovel work in large quantities, less; hard material, such as rock, will run considerably more.

Fire Escapes—

Ten-foot galvanized iron balcony, with stairs, \$115 installed on new buildings; \$140 on old buildings.

Floors—

Composition Floors—22c to 40c per sq. ft. In large quantities, 16c per sq. ft. laid.
 Mosaic Floors—80c per sq. ft.
 Dureflex Floor—23c to 30c sq. ft.
 Rubber Tile—50c to 75c per sq. ft.
 Terazzo Floors—45c to 60c per sq. ft.
 Terazzo Steps—\$1.60 lin. ft.

Hardwood Flooring (delivered to building)—

	$1\frac{1}{2}$ "x2 $\frac{1}{4}$ " T&G	$2\frac{1}{2}$ "x2" T&G	$3\frac{1}{2}$ "x2" S&E
Clr. Qtd. Oak	\$144.00 M	\$122.00 M	\$141.00 M
Sel. Qtd. Oak	118.00 M	101.00 M	114.00 M
Clr. Pla. Oak	120.00 M	102.00 M	115.00 M
Sel. Pla. Oak	113.00 M	92.00 M	107.00 M
Clr. Maple	125.00 M	113.00 M	

Wage—Floor layers, \$10.00.
 Note—Above quotations are all board measure except last column which is sq. ft.

Glass (consult with manufacturers)—

Double strength window glass, 20c per square foot.
 Plate 75c per square foot (ungleazed) in place, \$1.00.
 Art. \$1.00 up per square foot.
 Wire (for skylights), 40c per sq. foot.
 Obscure glass, 30c to 50c square foot.
 Glass bricks, \$2.40 per sq. ft., in place.
 Note—If not stipulated add extra for setting.

Heating—

Average, \$1.90 per sq. ft. of radiation, according to conditions.
 Warm air (gravity) average \$48 per register.
 Forced air, average \$68 per register.

Iron—Cost of ornamental iron, cast iron, etc., depends on designs.

Lumber (prices delivered to bldg. site).

No. 1 common	\$30.00 per M
No. 2 common	28.00 per M
Select O. P. common	35.00 per M
2x4 No. 3 form lumber	55.00 per M
1x4 No. 2 flooring VG	58.00 per M
1x4 No. 3 flooring VG	51.00 per M
1x6 No. 2 flooring VG	70.00 per M
1/4x4 and 6, No. 2 flooring	70.00 per M

Slash grain—

1x4 No. 2 flooring	\$45.00 per M
1x4 No. 3 flooring	42.00 per M

No. 1 common run T. & G. 33.00 per M
 Lath 5.50 per M
 Shingles (add cartage to price quoted)—
 Redwood, No. 1 \$1.10 per bble.
 Redwood, No. 2 1.00 per bble.
 Red Cedar 1.10 per bble.

Plywood—Douglas Fir (ad cartage)—

"Plyscord" sheathing (unsanded)
 5/16" 3-ply and 48"x96" \$32.50 per M
 "Plywall" (wallboard grade)— 37.50 per M
 1/2" 3-ply 48"x96" 37.50 per M
 "Plyform" (concrete form grade)— 110.00 per M
 Exterior Plywood Siding
 7/16" 5-ply Fir \$ 90.00 per M
 Redwood (Rustic) 85.00 per M

Millwork—Standard.

O. P. \$85.00 per 1000. R. W., \$100.00 per 1000 (delivered).
 Double hung box window frames, average, with trim, \$6.50 and up, each.
 Doors, including trim (single panel, $1\frac{3}{4}$ in. Oregon pine) \$8.00 and up, each.
 Doors, including trim (five panel, $1\frac{3}{8}$ in. Oregon pine) \$6.00 each.
 Screen doors, \$3.50 each.
 Patent screen windows, 25c a sq. ft.
 Cases for kitchen pantries seven ft. high, per lineal ft., \$8.00 each.
 Dining room cases, \$8.00 per lineal foot.
 Rough and finish about 75c per sq. ft.
 Labor—Rough carpentry, warehouse heavy framing (average), \$17.50 per M.
 For smaller work average, \$35.00 to \$45.00 per 1000.

Marble—(See Dealers)

Painting—

Two-coat work	per yard	42c
Three-coat work	per yard	60c
Cold water painting	per yard	10c
Whitewashing	per yard	4c
Turpentine	65c per gal. in 5 gal. cans, and 55c per gal. in drums.	
Raw Linseed Oil	—95c gal. in light drums.	
Boiled Linseed Oil	—98c gal. in drums and \$1.08 in 5 gal. cans.	

White Lead in oil

	Per Lb	
1 ton lots, 100 lbs. net weight	113 ³ / ₄ c	
500 lbs. and less than 1 ton	12c	
Less than 500 lb. lots.	12 ¹ / ₂ c	

Red Lead and litharge

1 ton lots, 100 lbs. net weight	113 ³ / ₄ c
500 lbs. and less than 1 ton	12c
Less than 500 lb. lots.	12 ¹ / ₂ c

Red Lead in oil

1 ton lots, 100 lbs. net weight	123 ³ / ₄ c
500 lbs. and less than 1 ton	13c
Less than 500 lb. lots.	13 ¹ / ₂ c

Note—Accessibility and conditions cause some variance in costs.

Patent Chimneys—

6-inch	\$1.25 lineal foot
8-inch	1.75 lineal foot
10-inch	2.25 lineal foot
12-inch	3.00 lineal foot

Plastering—Interior—

	Yard
1 coat brown mortar only, wood lath	\$0.50
2 coats, lime mortar hard finish, wood lath	.85
2 coats, hard well plaster, wood lath	.72
3 coats, metal lath and plaster	1.25
Keene cement on metal lath	1.30
Ceilings with 3/4 hot roll channels metal lath (lathed only)	.90
Ceilings with 3/4 hot roll channels metal lath plastered	1.80
Single partition 3/4 channel lath 1 side (lath only)	.85

Single partition 3/4 channel lath 2 inches thick plastered	\$2.90
4-inch double partition 3/4 channel lath 2 sides (lath only)	1.70
4-inch double partition 3/4 channel lath 2 sides plastered	3.30
Thermax single partition: 1" channels; 2 1/4" overall partition width. Plastered both sides	2.50
Thermax double partition: 1" channels; 4 1/4" overall partition width. Plastered both sides	3.40
3 coats over 1" Thermax nailed to one side wood studs or joists	1.25
3 coats over 1" Thermax suspended to one side wood studs with spring sound isolation clip	1.45

Plastering—Exterior—

2 coats cement finish, brick or concrete wall	\$1.00
3 coats cement finish, No. 18 gauge wire mesh	1.50
Wood lath, \$5.50 to \$6.50 per 1000.	
2.5-lb. metal lath (dipped)	.19
2.5-lb. metal lath (galvanized)	.21
3.4-lb. metal lath (dipped)	.22
3.4-lb. metal lath (galvanized)	.24
3/4-inch hot roll channels, \$72 per ton.	
Finish plaster, \$18.90 ton, in paper sacks.	
Dealer's commission, \$1.00 off above quotations. \$13.85 (rebate 10c sack).	
Lime, f.o.b. warehouse, \$2.25 bbl.; cars, \$2.15	
Lime, bulk (ton 2000 lbs.), \$16.00 ton.	
Wall Board 5 ply, \$50.00 per M.	
Hydrate Lime, \$19.50 ton.	
Plasterers Wage Scale	\$1.67 per hour
Lathers Wage Scale	1.60 per hour
Hod Carriers Wage Scale	1.40 per hour
Composition Stucco—\$1.80 to \$2.00 sq. yard (applied).	

Plumbing—

From \$70.00 per fixture up, according to grade quantity and runs.

Roofing—

"Standard" tar and gravel, \$6.00 per sq. for 30 sqs. or over.
 Less than 30 sqs. \$6.50 per sq.
 Tile, \$20.00 to \$35.00 per square.
 Redwood Shingles, \$7.50 per square in place.
 Copper, \$16.50 to \$18.00 per sq. in place.
 Cedar Shingles, \$8.00 per sq. in place.
 Re-coat with Gravel, \$3 per sq.
 Asbestos Shingles, \$15 to \$25 per sq laid.

Slate, from \$25.00 per sq., according to color and thickness.
 Shakes—1x25" resawn \$11.50 per sq.
 1/2x25" resawn 10.50 per sq.
 1/2x25" tapered 10.00 per sq.
 Above prices are for shakes in place.

Sheet Metal—

Windows—Metal, \$1.75 a sq. foot.
 Fire doors (average), including hardware \$1.75 per sq. ft.

Skylights—(not glazed)

Copper, 90c sq. ft. (flat).
 Galvanized iron, 30c sq. ft. (flat).
 Vented hip skylights 60c sq. ft.

Steel—Structural

\$120 ton (erected), this quotation is an average for comparatively small quantities. Light truss work higher. Plain beams and column work in large quantities \$97 to \$105 per ton.

Steel Reinforcing—

\$80.00 to \$120.00 per ton, set.

Stone—

Granite, average, \$6.50 cu. foot in place
 Sandstone, average Blue, \$4.00. Boise \$3.00 sq. ft. in place.
 Indiana Limestone, \$2.80 per sq. ft. in place.

Store Fronts—

Copper sash bars for store fronts, corner center and around sides, will average 75c per lineal foot.
 Note—Consult with agents.

Tile—Floor, Wainscot, etc.—(See Dealers)

Asphalt Tile—18c to 28c per sq. ft. installed.

Wall Tile—

Glazed Terra Cotta Wall Units (single faced) laid in place—approximate prices:
 2 x 6 x 12 \$1.00 sq. ft.
 4 x 6 x 12 1.15 sq ft.
 2 x 8 x 16 1.10 sq ft.
 4 x 8 x 16 1.30 sq ft.

Venetian Blinds—

40c per square foot and up. Installation extra.

SAN FRANCISCO BUILDING TRADES WAGE SCALES

All crafts 8 hour day (except as otherwise noted) and 5 day week. Effective as of May 1, 1940.

CRAFT	Journeyman Mechanics	CRAFT	Journeyman Mechanics	CRAFT	Journeyman Mechanics
Asbestos Workers	\$10.00	Millwrights	10.00	\$Dump Truck Drivers, 3 yards	7.50
*Bricklayers	10.50	Mosaic and Terrazzo Workers	8.00	\$Dump Truck Drivers, 4 yards	8.00
*Bricklayers' Hodcarriers	7.50	†Painters	8.75	\$Dump Truck Drivers, 5 yards	8.00
Cabinet Workers (outside)	10.00	Pile Drivers and Wharf Builders	11.20	\$Dump Truck Drivers, 6 yards	8.50
Caisson Workers (Open)	8.80	Pile Drivers Engineers	12.80	Truck Drivers of Concrete Mixer	
Carpenters	10.00	*Plasterers	10.00	Trucks:	
Cement Finishers	10.00	*Plasterers (Hodcarriers)	8.40	2 yards or less	8.00
Electricians	11.00	Plumbers	11.20	3 yards	8.57
Elevator Constructors	12.00	Roofers	9.68	4 and 5 yards	9.14
Engineers (Portable and Hoisting)	10.00	Sheet Metal Workers	10.00	6 yards	9.71
Glass Workers	9.68	Sprinkler Fitters	11.00		
‡Housesmiths, Ornamental Iron (Shop and Outside)	10.00	Steamfitters	11.00		
Housesmiths, Reinf. or Rodmen	10.50	Stein Builders	9.00		
Ironworkers (Bridge and Structural—Engineers)	12.80	Stone Cutters	10.00		
Laborers (Building and Common)	6.50	*Stone Setters	10.50		
*Lathers	9.60	Tile Setters	11.00		
Marble Setters	10.50	Welders, Structural Steel Frame on Buildings	12.80		
		\$Dump Truck Drivers, 2 yards or less	7.00		

EXPLANATION:

*—6 Hour Day.
 †—7 Hour Day.
 ‡—Term "Architectural Iron" no longer used. This craft "Ornamental Ironworker."
 \$—Dump Truck Drivers work 7 HOURS ON PUBLIC WORK, 8 HOURS ON PRIVATE WORK; starting time 7:30 A.M.

ARCHITECTS GIVEN CERTIFICATES

Provisional certificates have recently been granted by the California State Board of Architectural Examiners (Northern District) as follows:

Robert J. Evans, 1104 Mound Street, Alameda; William F. Hempel, 943 Guinda Street, Palo Alto; Irvin William Goldstine, 2030 12th Avenue, San Francisco; Walter E. Mooney, 816 Taraval Street, San Francisco; Oscar M. Price, 1782 Capistrano Avenue, Berkeley; James A. Gillem, 1317 O Street, Sacramento; Francis Lai Chin, Park Lodge, Golden Gate Park, San Francisco.

The board issued certificates to the following last year:

Keplar B. Johnson, 6300 Broadway Terrace, Oakland; Elizabeth Hillier Witkin, 2687 Shasta Road, Berkeley; Gordon Stafford, 1517 13th Street, Sacramento; Edmund P. DeMartini, 948 Broadway, San Francisco; Ralph Neilsen Kerr, 302 Broadmoor Boulevard, San Leandro; Aage Lewis Kone, 419 Vernon Street, Oakland; J. Clarence Felciano, 426 Rosenberg Building, Santa Rosa; Harold N. Wolfard, 2772 Shasta Road, Berkeley; William Koblik, 1325 15th Street, Sacramento; Lawrence G. Thomson, 1284 Thorne Street, Fresno; Milton T. Pflueger, 1430 Ulloa Street, San Francisco; Chris W. Runge, 815 25th Avenue, Oakland; Clayton Van Wagner, 671/2 Norman Lane, Oakland.

The next examinations for a certificate to practice architecture will be held June 10, 11, 12, 13 at the University of California in the School of Architecture. The last day for acceptance of applications for this examination is May 27.

In the future, examinations will be given only once a year—in June. The December session has been eliminated.

PERSONALS

Earl T. Heitschmidt has been appointed by the Southern California Chapter, A. I. A., to the executive board of the State Association, Southern Section, to succeed S. B. Marston, who resigned to assume the presidency of the Southern California Chapter, A. I. A.

Charles T. Leeds, Raymond A. Hill and Archer F. Barnard, announce the admission of John Quincy Jewett to partnership and change of the firm name to Leeds, Hill, Barnard & Jewett, consulting engineers. The firm—which has offices in Suite 1000 Edison building, Los Angeles—was formerly known as Quinton, Code & Hill-Leeds & Barnard.

WASHINGTON STATE CHAPTER

At the April 11th meeting of Washington State Chapter, A. I. A., delegates were elected to attend the Kentucky Convention and addresses were given by Nelson Perkins, chief engineer, Washington Plywood



California's Hotel Beautiful

—like a country estate
yet in the heart of a throbbing
metropolitan area.
—a matchless view—
comfortable, luxuriously furnished
rooms, excellent cuisine.
—in an atmosphere of quiet
and gracious living.

Rooms, with bath, \$2.50 to \$5.00 per day.

Attractive monthly rates

HOTEL CLAREMONT • BERKELEY

Association, and Homer Bergren.

The four delegates elected are: William J. Bain and Joshua Vogel, Seattle; Nelson J. Morrison, Tacoma; and John W. Maloney, Yakima. President Floyd A. Naramore and Secretary Victor N. B. Jones are officio delegates.

Lance Gowen submitted a report for the Civic Design and Planning Committee. The chapter members expressed approval of the program of Mayor Arthur B. Langlie to revamp the Seattle City Planning Commission.

CHESTER A. HOUGHTALING, ARCHITECT

Chester A. Houghtaling, active in designing buildings in Portland since 1909, died March 31, aged 58. His professional work included the design of the St. Stephen's Cathedral, Washington High School, Elks Temple, Fitzpatrick and Medical Arts buildings, and the Ross Island and Burnside bridges. He was a captain in the U. S. Army Engineer Corps during the World War. Mr. Houghtaling was born October 27, 1882, in Cleveland, Ohio. He is survived by a son and two daughters.

Charles A. Haynes, architect of Aberdeen, Wash., died April 11, after a lingering illness. He designed many of the outstanding commercial buildings and residences during his 30 years' residence in the Grays Harbor country. Mr. Haynes was 54 years of age and a native of Minnesota.

TO ARCHITECTS
AND ENGINEERS —

*We offer twenty years experience
in the successful installation of
acoustical and sound control
materials.*

WESTERN ASBESTOS CO.

Building Materials *Mechanical Specialties*
SACRAMENTO OAKLAND
SAN FRANCISCO

POMONA TILES

FOR
Bathrooms and Kitchens
in over 60 colors

Warehouses and Display Rooms

135 Tenth St. San Francisco
629-33 North La Brea Ave. Los Angeles
6105 Roosevelt Way Seattle

POMONA TILE MFG. CO.
PLANT — POMONA, CALIF.

STRUCTURAL STEEL

For Class A Buildings,
Bridges, etc.

JUDSON PACIFIC CO.

1200 SEVENTEENTH STREET
SAN FRANCISCO

Plants: San Francisco - Oakland

A Permanent Exposition
of the newest ideas
in home planning
and equipment.



THE BUILDING MATERIAL EXHIBIT

Architects Bldg. • Fifth & Figueroa • Los Angeles • MU-6306

DISTINGUISHED EDUCATORS HONORED

Dr. R. B. von KleinSmid, president of the University of Southern California, and Remsen Du Bois Bird, president of Occidental College, were honored by Southern California Chapter, A. I. A., at its April 9th meeting for their contributions to the cause of education and civic betterment. Citations to the two educators read as follows:

"An educator of distinction, who as president of the University of Southern California, has through his appreciation of architecture and the fine arts, fostered the development of the Department of Architecture into the present widely recognized College of Architecture and Fine Arts and secured for it adequate housing in the Harris Hall of Architecture and Fine Arts and the Fisher Gallery of Fine Arts. For this achievement and his ability as a builder of universities, and for his active interest in civic affairs and in the development of the cultural life of the community, the Southern California Chapter, American Institute of Architects, confers the title of honorary associate upon Rufus Bernard von KleinSmid."

"For the esteem in which he is held by the citizens of this community, for his unselfish contributions of time and effort toward the advancement of city planning, for his active interest in the humanities and especially in fostering civic appreciation of music, and for the contribution which he has made to the cause of education during the last twenty years in his capacity as president of Occidental College, the Southern California Chapter, American Institute of Architects, confers the title of honorary associate upon Remsen Du Bois Bird."

Presentation of the certificates to Dr. von KleinSmid and Dr. Bird was made by David J. Witmer, a fellow of the Institute.

Speaker of the evening was L. Deming Tilton of the Haynes Foundation, an organization formed for the purpose of studying city planning and advising on problems pertaining thereto.

The meeting was attended by 70 members and guests, including Ernest E. Weihe and Frederick H. Reimers of San Francisco, Winsor Soule of Santa Barbara and Louis J. Gill of San Diego.

BIG FEDERAL COMMISSION

Albert Kahn, Incorporated, architects of Detroit, have been commissioned by the United States Navy to prepare plans for the \$63,000,000 naval base building program in the Pacific.

While the Kahn office has been working on such plans for some time, the Government has only recently released information regarding the construction of bases on a string of small islands stretching westward across the Pacific from Hawaii, another group on the coast of Alaska and a base at San Juan, Puerto Rico.

The firm, it is understood, are also architects for bases at Midway Island, Kodiak and Puerto Rico.

ART AT TREASURE ISLAND

Art lovers are going to have their fill at the Golden Gate Exposition this year. Timothy Pflueger, vice-chairman of the Palace of Fine Arts Committee, is overlooking nothing to satisfy the whims of the most critical. It is really marvelous the things being planned for art ing nothing to satisfy the whims of the most critical. lovers by Pflueger and his committee, of which the Editor of Architect and Engineer has been honored to membership.

For example, there will be an "Art in Action" exhibit which will give the public an opportunity to view an artists' studio with artists and models at work. Diego Rivera, famed Mexican artist, will be among the participants. Others will include Helen Forbes of San Francisco, Maxine Albro of Carmel, Glen Lukens, one of the foremost American artists in his field; Dudley Carter, known to many fair-goers for his splendid work on the Shasta Building last year; Michael Chepurkoff, animal sculpture in metal; and Antonio Sotomayor, clever Bolivian-born San Franciscan. Marion Simpson of Berkeley has returned from Mexico to paint in oil. There will be weaving demonstrations by Maga Albee and her group, including Jean Fay and Adaline Emerson. Esther Meyer, Ray Burrell and the Austrian-American Max Pollack will demonstrate graphic arts.

As a bridge from the "Art in Action" division of living California art to the section of European and American painting and sculpture, there will be a special show of California artists of the past. Considerable space will be devoted to the well-loved historical figures of California painting, William Keith, Thomas Hill, Jules Tavernier and many others.

From the Middle Ages to the present, every major trend and period in the history of European and American art will be represented in the Painting and Sculpture Division of the Fine Arts Palace at the Fair.

Among some of the most famous works to be shown in the Old Masters section will be Breughel's "Wedding Dance" from the Detroit Art Institute, two magnificent El Grecos, several Van Dycks, Rembrandts, Murillos and Franz Hals and a group of early Italians. There will also be a superb Madonna in terra cotta by Mino da Fiesole, two works by the Italian fifteenth century sculptor Amadeo, several fine pieces of Greek statuary, also a considerable number of fine other Dutch seventeenth century paintings, and English and French oils of the eighteenth century.

As a departure from last year's Fine Arts exhibit, there will be a special section of art works from Central and South American countries of the Pacific coast.

A unique, comprehensive show of photography will be held in the east section of the Fine Arts Building. This exhibition is being directed by two men who are known for their outstanding achievements in the field of photography: Ansel Adams of San Francisco and T. J. Maloney, editor of the U. S. Camera Magazine. Object of the exhibit is to present photography from the

A good investment—

is a well designed, well built structure, properly located.

Lindgren & Swinerton, Inc.

have been building substantial buildings for over a half of a century, are still building them and will continue building them for another half a century.

Lindgren & Swinerton, Inc.

Standard Oil Building
San Francisco
619 H Street
Sacramento

605 W. Olympic Boulevard
Los Angeles
1723 Webster Street
Oakland

PRODUCT OF THE CHEMICAL AGE

Chemical Fusing — The Saveall Sprinkler is the first and only approved sprinkler employing a solid chemical for its fusible element. This fusible element has a definite unchanging fusing temperature, each temperature rating being obtained by the use of a different compound. As the surrounding atmos-



phere attains the temperature corresponding to the rating of the sprinkler, the chemical compound undergoes a physical transformation, changing from a solid to a liquid, whereupon there is no resistance to the load exerted by the plunger and the sprinkler operates with positive and sharp action.

USED IN THE NEW SANTA CRUZ AUDITORIUM

CALIFORNIA AUTOMATIC SPRINKLER CO.

Engineers, Contractors,
Installers of Approved
Automatic Sprinklers

Office, Warehouse and
Fabricating Plant: 665
6th St., San Francisco

STAGE CURTAINS and RIGGING

of the Santa Cruz Civic Auditorium
were furnished by

FRED E. TURNER

557 Market St.

San Francisco



A comfortable, enjoyable place to stay for over night or vacation.

EL ENCANTO HOTEL & VILLAS

Just above Santa Barbara Mission

Frank J. McCoy, Managing Director

Fred F. Pimentel, Manager



QUALITY AND DEPENDABLE *Service*

are the factors that influence architects and contractors when selecting lumber and mill work — Quality of merchandise — Integrity and Ability of the firm—Service in physical equipment — Experience and Personnel — All these factors contribute to a speedy and satisfactory completion of construction with minimum of time and expense.

MANUFACTURER OR DEALER IN

Douglas Fir—Redwood—Sugar and Ponderosa Pine — Plywood and Concrete Form Panels — Sash and Doors — Millwork — Insulation — Builders' Hardware.

E. K. WOOD LUMBER CO.

"Goods of the Woods" ©

LOS ANGELES • SAN FRANCISCO • OAKLAND

BAXCO

CHROMATED ZINC CHLORIDE



PRESSURE TREATED LUMBER
● **PROTECTS AGAINST DECAY**
AND TERMITE ATTACK

Specify it in your home
Available through Lumber Dealers

LOS ANGELES
601 W. 5th Street
Phone Michigan 6294

SAN FRANCISCO
333 Montgomery Street
Phone DOuglas 3883

J.H. Baxter & Co.

AGENTS FOR WEST COAST WOOD PRESERVING CO., SEATTLE, WASH.

earliest day to the present time, both in still and motion picture fields. The exhibit will comprise presentations of historic, documentary and experimental films, a show of color photography, a section of technological, scientific and news photography, contemporary American photography and a special section devoted to works by living California artists. The foyer to the exhibition will be decorated with large photo murals.

Miniature rooms by Mrs. James Ward Thorne, which were one of the most popular features of last year's exhibition at the Fine Arts Palace, will again be included in the Fine Arts show, but they will be entirely different from those on display last year.

Altogether there will be twenty-nine rooms. Of special interest are a Japanese and a Chinese interior, which will provide a unique insight into the nature of living of the Oriental. The remaining twenty-seven units consist of six American rooms, eight French rooms, three Spanish rooms, a very handsome Venetian salon, a fine early Italian room and eight English rooms.

As an additional new feature of the exhibit at the Fine Arts Palace, an unusual show of fine printing is being prepared. Commemorating the 500th anniversary of printing with movable types, 500 books of the finest presses of the world will be on display.

NATIONAL PLANNING CONFERENCE

For the first time on the Pacific Coast, the National Conference on Planning will be held this year in San Francisco. Public administrators, conservationists and planners from all over the nation will assemble at the Fairmont Hotel, July 8-11, to discuss Planning for America at Peace. This annual conference is sponsored jointly by four national societies—American Society of Planning Officials, American Institute of Planners, American Planning and Civic Association, and the National Economic and Social Planning Association.

The program for the four-day meeting will appeal to all who are interested in basic problems facing the American people. Speakers of national prominence will discuss industrial expansion, the use of our resources, migration and resettlement, and the nature of planning in a democracy. Other conservation and planning problems will also be considered.

Rexford G. Tugwell, chairman of the New York City Planning Commission, will discuss similarities between the New York and San Francisco metropolitan regions, and the development of a metropolitan regional plan. Following his talk, a tour will be made of San Francisco, terminating at Treasure Island.

The conference was brought to San Francisco largely through the efforts of the San Francisco City and County Planning Commission, of which Mrs. Albert W. Stokes is president and Mark Jorgensen, architect, is secretary. Conference chairman is Dr. B. M. Woods, 303 Mercantile Building, Berkeley.

*Business
Travelers
Do their Banking
with us*
BY MAIL

Deposit your pay check
... send money home ...
handle most banking details
in your spare time while
traveling. Wherever you go
our Bank-by-Mail Service is
as convenient to you as the
nearest mail box. Here is a
really helpful service. Why
not take advantage of it?

**CROCKER FIRST
NATIONAL BANK**
OF SAN FRANCISCO

California's Oldest National Bank
Member Federal Deposit Insurance Corporation

**Clinton
Construction Co.**
of California

*General
Contractors*

923 Folsom Street
San Francisco
SUtter 3440

**JOHN
CASSARETTO**

—Since 1886—And Still Active—

Building Materials

READY MIX CONCRETE
ROCK - SAND - GRAVEL - LIME
CEMENT - PLASTER - MORTAR
METAL LATH - WOOD LATH
STUCCO - WIRE NETTING

Service Unexcelled

Bunkers

Sixth and Channel, San Francisco
Phones: GARfield 3176, GARfield 3177

MORE S. F. SLUM CLEARANCE

Rapidly moving forward in its program to relieve a mounting shortage of decent homes for its low-income families, San Francisco last month received approval of a loan contract for two more public housing projects totaling 470 dwellings.

Under previous loan contracts, San Francisco has three USHA-aided developments totaling 1,359 dwellings under construction, another scheduled to get under way this summer, and a fifth in the blueprint stage. Those under construction are "Fioli Courts," 118 units, which is nearing completion; "Sunnydale," 772 units, and "Potrero Terrace," 469. "Bernal Dwellings," 228 units, is nearing the construction stage and plans are being drawn for "Valencia," 278 units.

The larger of the two projects planned under the April loan contract will consist of about 270 dwellings, and the other of about 200, practically all in 2-story-and-base-ment row houses and flats. Surfaced play areas will be provided for the children, with indoor space for the tenant families' social activities.

San Francisco's growth has been rapid in recent years, with private enterprise failing to meet the ever-growing need for decent homes at rents within the means of low-income families, the application stated.

Although the number of families in San Francisco increased from 178,625 enumerated in 1930 to an estimated 212,404 in 1938—a gain of 33,779—only 13,846 dwellings were constructed in that nine-year period. Moreover, the new houses for the most part were built in outlying sections of the city at a cost which put them far beyond the low-rental range. Meanwhile, 393 dwellings which, as a rule, had housed low-income families were demolished, with the result that the net gain fell 20,326 short of the estimated family increase.

It is estimated on the basis of a current WPA Real Property Survey, that there are 59,000 dwelling units occupied by families in San Francisco who, because of lack of decent low-rent homes, are now living under sub-standard housing conditions.

Pitcher
DOOR SYSTEM

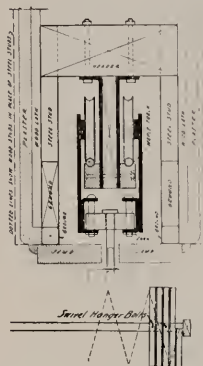

Includes Closet Doors, Interior Disappearing Doors, Exterior French and Screen Doors, Tandem Doors for Wide Openings, Sliding Partitions, Folding Doors, Garage Doors. Send for Details.

E. C. Pitcher Co.

557 Market St., San Francisco
Phone YUkon 1543

VAUGHN - G. E. WITT Co.

Manufacturers and Distributors

Pump Governors	Oil Heaters
Safety Pump Governors	Relief Valves
Automatic Gas Regulating Valves	Oil Burner Governors
Gas Burning Equipment	Oil Burners
Vacuum Pump Governors	Oil Pumping Sets
Vacuum Regulating Valves	Oil Valves
Continuous Flow Steam Traps	Oil and Steam Strainers
Thermostats	Duplex Oil Pumps
Reducing Valves	Rotary Oil Pumps
	Boiler Feed Pumps
	Water Heaters
	Boiler Feed-Water Regulators

4224-28 Hollis St., Emeryville, Oakland

**VERMONT
MARBLE
COMPANY**

Producers and Finishers

of

**Domestic and Imported
Marbles**

San Francisco
Los Angeles
and
Tacoma, Wash.

MULLEN MFG. COMPANY

BANK, STORE AND OFFICE
FIXTURES—CABINET WORK
OF GUARANTEED QUALITY
CHURCH SEATING

Office and Factory:
60-80 RAUSCH ST., Bet. 7th and 8th Sts.
San Francisco
Telephone UNderhill 5815

JOSEPH MUSTO SONS-KEENAN CO.

MARBLE
and ABRASIVES
ONYX

535 NORTH POINT STREET
SAN FRANCISCO
1801 S. SOTO STREET
LOS ANGELES

G. P. W. JENSEN & SON

Building Construction

320 Market Street, San Francisco
Phone: CArfield 2444

THE MOST COMPLETE LINE
OF STEELS AND STEEL BUILD-
ING MATERIALS MADE BY A
SINGLE PRODUCER



See Sweet's Catalog File or write us for
full information.

Republic Steel Corporation
General Offices: Cleveland, Ohio

Denver, Colo. . . . Continental Oil Bldg.
Los Angeles, Calif. . . . Edison Bldg.
Salt Lake City, Utah . . . Walker Bank Bldg.
San Francisco, Calif. . . . Rialto Bldg.
Seattle, Wash. . . . White-Henry-Stuart Bldg.

Copper Halftones
in this issue

Made by

Continental Engraving
& Color Plate
Co.

156 Second Street
San Francisco

DINWIDDIE CONSTRUCTION COMPANY

BUILDERS

CROCKER BUILDING
SAN FRANCISCO

Louis C. Dunn, Inc.

GENERAL
CONTRACTORS

Monadnock Building
San Francisco

Phone: DOuglas 4632

ALADDIN Heating Corp.

Specializing in
QUALITY HEATING
EQUIPMENT

2222 San Pablo Avenue
Oakland
TWInoaks 1022

COMFORT



New HOTEL CLARK

in Downtown
LOS ANGELES

Convenience is another offering of
this hotel. Whether on business or
pleasure bent, the Hotel Clark
makes an ideal "base of operations,"
as well as a restful "billet" at the
end of the day's "campaign." Good
Food, naturally. And moderate
charges, as well as for room accom-
modations, give final significance
to assuring word — COMFORT

Single from \$2.50
Double from \$3.50

ROOMS
555
BATHS

Fifth and Hill

P. G. B. MORRIS, Manager

Smith

Lumber Company

WHOLESALE - JOBBING - RETAIL
FACTORY AND BUILDING LUMBER
PLYWOODS - ROOFING

DISTRIBUTING YARDS

San Francisco	Oakland
4th & Channel	19th Ave. & Estuary
Market 0103	FRuitvale 3174

YOUR INQUIRIES SOLICITED

SISALKRAFT

REG. U. S. PAT. OFF.

"More than a
building paper"

THE SISALKRAFT CO.

205 West Wacker Drive
(Canal Station) Chicago, Ill.
55 New Montgomery Street
San Francisco, Calif.

ABBOT A. HANKS, INC.

Engineers & Chemists

INSPECTING — TESTING — CONSULTING
CONCRETE • STEEL • MATERIALS
CHEMICAL AND TESTING
LABORATORIES
• RESEARCH AND INVESTIGATION •

TESTS OF STRUCTURAL MATERIALS
DESIGN OF CONCRETE MIXES
SHOP AND ERECTION INSPECTION OF
STRUCTURES AND EQUIPMENT
INVESTIGATION OF STRUCTURES
AND MATERIALS
TESTS AND INVESTIGATION OF
FOUNDATION SOILS
FIRE RESISTANCE AND INSULATION
TESTS

624 Sacramento Street, San Francisco

HIGH GRADE MILLWORK
AND INTERIOR FINISH
SASH AND DOORS

LANNOM BROS. MFG. CO.

FIFTH AND MAGNOLIA STREETS
OAKLAND, CALIFORNIA

Telephone: TEmplebar 3663



PRODUCTS

VAN ARSDALE-HARRIS CO.

ENGINEERS & CONTRACTORS

ACOUSTICAL TREATMENT
INSULATION
SOUND CONTROL

Fifth and Brannan Streets
San Francisco, Calif.
Telephone GARfield 3600

Division

VAN ARSDALE-HARRIS
LUMBER CO., INC.

FINE WATER COLORS
AND PAPERS
FOR ARCHITECTURAL
RENDERINGS

H. S. CROCKER COMPANY, Inc.

720 MISSION STREET
MARKET STREET AT SECOND
SAN FRANCISCO

A majority of San Francisco's low-income families are concentrated in five census tracts which extend across the city from north to south. These areas are characterized by dilapidated wood frame structures built more than half a century ago, and overcrowding and insanitation are prevalent, the application stated.

STORE WINDOW INSULATION

Who ever heard of a store owner putting double windows on his entrance displays just as the hot summer season is about to start?

Paradoxical and unseasonal as such a move may sound, it is, in effect, just what many far-sighted store owners are doing today, according to architectural service experts.

It is a new variation—with reverse English—of the time-honored practice of using "storm sash" for cold weather insulation, in homes as well as stores. In this modern application, a newly-developed, heat-absorbing plate glass called aklo is used in the outer pane, to provide protection against heat gains in summer as well as heat loss in winter.

The rapid growth of air-conditioning as a lure to summer-time shoppers is one of several factors reported to the architectural service division of the Libbey-Owens-Ford glass company by store proprietors as recommending this form of heat insulation, as it helps lessen the load on the conditioning system. In this connection it is applicable to skylights also.

Other factors contributing to the trend to this form of double glazing are the protection the heat-absorbing glass provides for merchandise in the show windows, preventing spoiling, wilting or fading of goods, and the prevention of moisture condensation which in cold weather mars the display value of a window.

STUDENTS VISIT KRAFTILE PLANT

Students from the College of Mines, Mining Metallurgical and Ceramic Engineering of the University of Washington, Seattle, visited the Kraftile plant at Niles recently, and, notebooks in hand, went into all details of operation.

SPECIFY SUPERIOR FORM DAMPERS

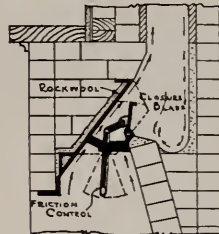

By specifying Superior Form Damper you are assured of proper throat construction and smokeless operation.

The Superior is not just another damper but a perfect guide and a complete form around which the masonry is built.

The method of hinging and operation of the damper forms a natural pocket in back which prevents down draft trouble.

A pad of rock wool insulation is furnished with each form to prevent cracking of masonry from metal expansion.

Write Dept. "AE" or call for complete information.

SUPERIOR FIREPLACE CO.

1046 SOUTH OLIVE STREET, LOS ANGELES

Manufacturers of wood, coal and gas fired fireplace circulators.

Pacific Manufacturing Company

High Class Interior Finish
Quality Millwork

142 Sansome St. 6820 McKinley Ave.
San Francisco Los Angeles
GARfield 7755 THornwall 4196

1315 Seventh Street, Oakland
GLEncourt 7850

Golden Gate Atlas

TRANSIT
MIX CONCRETE
AND MORTAR

PACIFIC COAST AGGREGATES, Inc.

16th and Harrison Streets
85 Second Street San Francisco



Clients will bless you for installing the Wesix "49'er" ELECTRIC BATHROOM HEATER. But try it first in your own home. Certain that you will like its forty-nine inches of INSTANT RADIANT HEAT and QUICK CIRCULATING HEAT, we are offering this smart new heater at factory cost to architects, for personal use! Limit one heater per architect. List price \$23.50. Please write on your regular letterhead, to: 1018 WESIX BLDG., SAN FRANCISCO

WESIX

WESIX ELECTRIC HEATER CO.

Phone GARfield 1164

Hunter & Hudson

Consulting Engineers

DESIGNERS OF HEATING
AIR CONDITIONING
VENTILATING AND WIRING
SYSTEMS, MECHANICAL
AND ELECTRICAL EQUIP-
MENT OF BUILDINGS

41 SUTTER STREET
ROOM 710

San Francisco California

Robert W. Hunt Company

ENGINEERS

Inspection • Tests • Consultation

Schools and Other Structures
Are Built as Designed

*When Construction Materials are
Inspected at point of Manufacture
and during Erection by*

ROBERT W. HUNT COMPANY

*Cement, Concrete, Chemical, Metallurgical,
X-Ray and Physical Laboratories*

Chicago • New York • Pittsburgh
Los Angeles • All Large Cities
San Francisco, 251 Kearny Street

The eight students were accompanied by Dr. Carl H. Zwermann, assistant professor of ceramic engineering, and Wendell Keith, instructor in the college.

Besides making flow charts and other visual scrutinizing production of ceramics, the teachers and students studied Kraftile's unusual safety record, personnel program and cost control. Particularly impressive to the visitors was the cleanliness of the plant with its yellow-tinted motor casings (to detect oil smudges) and its workers dressed in white and working in conditions which include perfect control of dust and spray.

LOS ANGELES HOUSING

With "Ramona Gardens," a 60-unit project under construction, and three other U. S. H. A.-aided developments scheduled to be advertised for bids this summer, the city of Los Angeles last month received approval of a loan contract for a fifth project in its program to provide badly needed decent housing for its low-income families.

The three developments upon which construction is yet to be started will have a total of about 896 dwelling units. Including the 800 dwellings planned for the latest project, Los Angeles upon completion of the five developments now under loan contract, will have a total of 2,306 units in public housing. The number of families living in substandard housing in the "downtown" area of Los Angeles alone totals over 30,000, the application stated.

The project planned under the loan contract approved in April will consist of two-story row houses, two-story flats and three-story, gallery-type flats, all of fireproof construction. The kitchens will be equipped with cooking range, and combination sink and laundry tray. There will be surfaced play areas for the children and a separate building is planned to house administrative and social facilities. Nearly 90 per cent of the landscaped areas will be maintained by the tenants.

During the nine years 1930-38 the net gain in new dwelling units con-

INCLUDE TREES IN YOUR PLANS

DAVEY, ORIGINATOR OF TREE SUR-
GERY, OFFERS FREE INSPECTION
AND ESTIMATE.



SAN FRANCISCO
Rush Bldg. Sutter 3377

FRESNO
Maifei Bldg.

LOS ANGELES
Story Bldg. Tucker 1929

Local phones in: Pasadena, Palo Alto,
Oakland, San Rafael, San Mateo

SKILL - KNOWLEDGE -
RESPONSIBILITY

THE TORMEY COMPANY

GENERAL PAINTERS
AND DECORATORS

Phone UNderhill 1913

563 FULTON STREET
San Francisco

Donovan Automatic Awning Type Windows

Give 100% natural ventilation
and day-lighting control

UNIVERSAL WINDOW
COMPANY

Berkeley, California

structed by private enterprise fell 31,465 short of the estimated increase of 89,877 families in the city's population and comparatively little of the new construction was standard housing available to low-income families.

The city's population in 1938 was estimated at 1,540,000, an increase of nearly 25 per cent since 1930 and almost treble the 1920 population of 576,673.

A survey of 19 slum and blighted areas in Los Angeles has disclosed that the net cost of law enforcement in these sections is \$10.62 per inhabitant, as against \$4.80 for the city at large. The excess cost of law enforcement over tax revenues in these areas was \$1,009,000. Although the 19 areas housed less than 15 per cent of the city's population, they produced 37 per cent of all its felonies, the survey showed.

TYPES OF ARCHITECTURE TO BE SHOWN

All space in the Homes and Gardens Building at the Golden Gate International Exposition has been assigned to the building industry for an exhibit. Principal feature will be the showing of 100 to 150 models of residential and other buildings, illustrating different types of architecture; also a model of commercial buildings showing "before and after" store fronts in a modern shopping district.

A special committee representing the construction industries, to promote the exhibit, has been formed, with Fred J. Early, Jr., chairman and D. C. Tait, vice-chairman. Among the groups cooperating are the American Institute of Architects, State Association of California Architects, Associated General Contractors of America and Cabinet Manufacturers Institute.

A NEW ART MEDIUM

Ten tons of stainless steel—the first piece of heroic sculpture ever cast in this new art medium—has arrived in New York and is being assembled for installation over the main entrance of the Associated Press Building in Rockefeller Center. Designed by Isamu Noguchi, 35-year-old Japanese-

ILLUSTRATIONS OF SUPERIOR CONSTRUCTION

CONSOLIDATED Motors Inc. Garage, Phoenix, Arizona
 —H. H. Green, Architect. Summerbell Trusses spanning from wall to wall in this 102-ft. wide building, permit the utilization of the entire floor area. Absence of posts is essential in such a building, and the Summerbell Trusses make this possible as well as provide a safe, strong, and dependable roof support.

SUMMERBELL ROOF STRUCTURES
 LOS ANGELES • OAKLAND • PHOENIX
 TIMBER STRUCTURES, INC., PORTLAND

ROOFS OF WOOD—BUILT TO ENDURE

HERRICK IRON WORKS
STRUCTURAL STEEL
REINFORCING STEEL
 18TH AND CAMPBELL STS.
 OAKLAND, CALIF.
 Phone GLencourt 1767

Independent Iron Works

Structural Steel
 Ornamental Iron
 Steel Service Stations
 Steel Tanks
 Standard Steel Buildings
 Bridges

821 Pine Street Oakland

FORDERER CORNICER WORKS

Manufacturers of
 Hollow Metal Products
 Interior Metal Trim
 Elevator Fronts and Cabs
 Metal Plaster Accessories
 Sanitary Metal Base
 Metal Cabinets
 Flat and Roll Metal Screens
 Commercial Refrigerators

269 POTRERO AVE.
 San Francisco, Calif.
 HEmlock 4100

"AMERICAN MARSH" Redi-Vac Vacuum Heating Pump

Send for Bulletin 441

SIMONDS MACHINERY CO.
 San Francisco Los Angeles
 816 Folsom St. 455 East Fourth St.

BASALITE

CAMBERED SHINGLE TILE

PERMANENT
FIREPROOF
STORMSAFE
COLORFUL
ECONOMICAL

Manufactured by

BASALT ROCK CO., Inc.
NAPA, CALIFORNIA

ALLEN STRUCTURAL PORCELAIN PANS

The ultimate in porcelain enamel construction.

Details and specifications now available.

FRANK ALLEN

Ferro-Porcelain Construction
320 MARKET ST., SAN FRANCISCO

Melrose Lumber & Supply Co.

LUMBER AND
MILL WORK

46th Ave. and E. 12th St.
Oakland

Phone: FRuitvale 0251

American artist and winner of the national competition for the Associated Press Building plaque, the huge panel is the largest metal bas relief ever cast.

Designed as a symbol of "News," the panel depicts in bold and simple lines the heads and torsos of five men. Four of them are working with the swift tools of modern journalism—the teletype, wirephoto, camera and telephone, while the fifth one carries the pad and pencil—trademark of all reporters.

FOR BETTER HOUSING CONDITIONS

Four proposals for creating better housing conditions for low-income groups in cities have been advanced by the Public Housing Committee of the Chamber of Commerce of the United States. Briefly, they are:

Enforcement of legislation by city governments to compel repair of low-standard dwellings.

Changes in the public housing policy of the Federal Government.

Encouragement of means for lowering building costs.

Concerted effort by private enterprise for reconstruction of blighted, downtown areas.

"The most urgent immediate need and opportunity to improve the housing of the lowest income families," the committee declares, "is the enforcement by city governments of sanitary and housing legislation which will compel the repair of dwellings below minimum standards and the demolition of those unfit and beyond repair. This program should be worked out in cooperation with local relief administrations, in order that families which might otherwise suffer hardship through a thorough-going enforcement of existing legislation in this field would receive assistance in adjusting themselves, including rental aid where needed.

"Chambers of commerce and other civic organizations are urged to provide the essential public understanding and support for enforcement programs in their communities."

Send for catalog
"The Charm of a Light-Conditioned Home"



No furnishings you can buy for so little will give you as much long term satisfaction as a new Lightolier fixture.

**INCANDESCENT
SUPPLY COMPANY**
726 MISSION STREET, SAN FRANCISCO

ANDERSON & RINGROSE

General Contractors

320 Market Street, San Francisco
Phone GARfield 2245



MERCURY PRESS

We Print
The ARCHITECT and
ENGINEER

*"A Thing of Beauty
Is a Joy Forever"*

942 HOWARD STREET
SAN FRANCISCO

ARCHITECT
AND
ENGINEER



JUNE, 1940



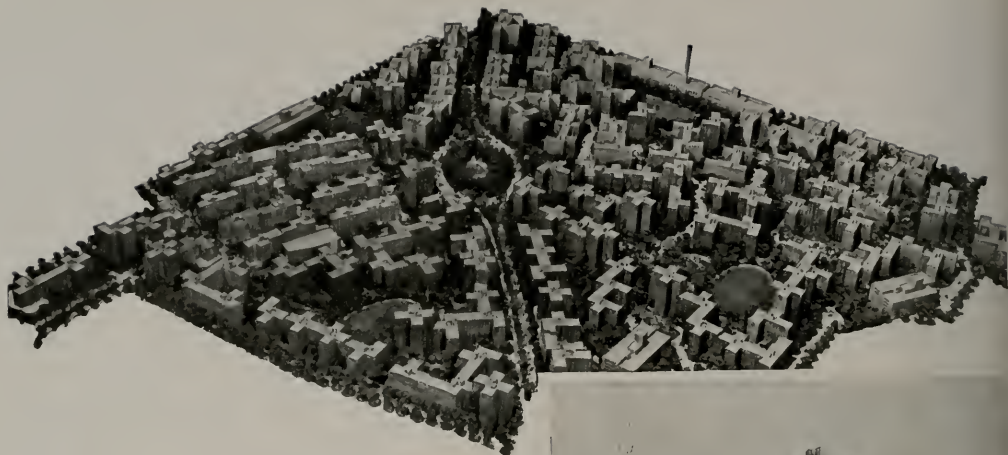

12,275 WATROUS FLUSH VALVES for Parkchester—the world's largest housing project



WHEN you write flush valve specifications for your jobs we believe it might be helpful to consider the same factors that were weighed when Watrous Flush Valves were selected for Parkchester, the huge housing project now being built by the Metropolitan Life Insurance Co. in the Bronx, New York City.

In presenting the merits of Watrous Flush Valves for Parkchester, we based our case on the assumption that:

1. They wanted the maximum value in tenant satisfaction.
2. They wanted equipment that would last as long as the amortization period of the building.
3. They wanted equipment that

would cut operating costs wherever possible.

4. They wanted to eliminate maintenance troubles.
5. They wanted to keep the cost of the project down.

We consider it one of the finest tributes that Watrous Flush Valves have ever received that the Board of Design approved the selection of Watrous for this huge project. It represented, so far as we know, the largest order ever placed for flush valves—over 12,275 units.

Write for complete information on Watrous Flush Valves, including a copy of "A Scientific Method of Silencing Flush Valves." For specification details, see Catalog 54—Section 27 of Sweet's Catalog File.

•The Board of Design for the amazing development which the Metropolitan Life Insurance Co. is now constructing on a site covering 46 city blocks in the Bronx consists of: R. H. Shreve, Chairman, Shreve, Lamb and Harmon—Architects; Andrew J. Eken, President, Starrett Brothers and Eken, Inc., Contractors; Gilmore D. Clarke, City Planning and Landscape Engineer; Irwin Clavan, Architect; Robert W. Dowling, Vice-President, Starrett Brothers and Eken, Inc., Contractors; George Gove, Manager of Housing Projects, Metropolitan Life Insurance Co.; Henry C. Meyer, Jr., Meyer, Strong & Jones, Inc., Consulting Engineers.

Plumbing Contractor is J. L. Murphy, Inc., New York City.

When completed there will be 51 apartment buildings totaling 42,000 rooms, separated into 12,275 apartments of from 2 to 5 rooms. There are also stores, theatres, garages, parks with playgrounds, wading pools, roller skating paths, hand ball and softball courts.



THE IMPERIAL BRASS MFG. CO., 1237 W. Harrison St., Chicago, Ill.

Watrous Flush Valves

**DIAPHRAGM AND
PISTON TYPES**
—also furnished with
SILENT ACTION equipment

DISTRIBUTED EXCLUSIVELY THROUGH WHOLESALEERS OF PLUMBING MATERIALS

RUNNING FIRE

by
MARK DANIELS, A.I.A.

The Radio and the Architect

Silence may be golden but it's no good for coinage. Further, when it is resorted to as a defense it implies acquiescence to the charge. The architects of Southern California have come to this conclusion, for they are at least speaking up for their profession over the radio.

Why not? We should have spoken "right out in meetin'" long before this. After all, even though some of us are benefactors to mankind whose genius must be sought in high and hidden places, we are men merchandizing our services—when we can. Some use political, others social pull. Some go in for competitions, some pound pavements, but it's all merchandizing.

When contractors and materials men tell people they don't really need an architect, what do the architects do? They sit back and tell each other it's all wrong. That might be well if any architect were ever another architect's client. What we should do is tell the rest of the world, the possible customers, it's all wrong. That's just what the Southern California architects are doing. In Los Angeles the architects are on the air every Sunday morning at 10:00 a.m. over KXV telling the prospective clients what's what about architects and architecture. It costs \$122.00 for fifteen minutes. The program is sponsored by the Southern Section of the State Association which, in turn, is supported by contributions from its members. The plan is producing results; why not start it in San Francisco?

There are more ways of being modern than bending over the draughting board.

★ ★ ★

Speed

A hundred and ninety pound athlete, student at the University of California for two years, answered the urgent call of the War Department for cadets for the flying corps. The repeated statements that our country was in dire need of just such men as he for pilots filled him with patriotic fervor. Enthusiastically he sent in his application and college record.

After weeks of waiting he received a notice that he was being

considered. Later he was told to report to a certain corps commander. Still later he was told that his scholastic record was below par and that ten weeks later they would give him an examination. He was a student in agriculture and possibly a low mark in "Apiculture" disqualified him for handling "Wasp" and "Hornet" motors.

★ ★ ★

Recession

I sipped the Old Fashioned in a tired way. There was a lot of noise and bustle. One man was arguing whether or not the District of Columbia was one of the forty-eight states, and The Little Man patted me sorrowfully on the shoulder. "A depression," he remarked, "is a cumulative reaction to business retrogressions and regressions."

I looked startled and the Little Man waved his cane at the O'Brien and myself, with a net result of two drinks. "We have," he continued, "an innumerable series of statistics, indices and accounts purporting to describe recessions and accessions in business production through the medium of price changes, for the past hundred and fifty years. Beyond that we are statistically and informationally ignorant. Periods of business peaks and bottoms cannot be noted with a great degree of accuracy; and a good part of this is due to accountants. The breed has inhabited the earth for many years. Ever since the first printed book of accounting by Paciolo in the fifteenth century we have been cursed with double entry bookkeeping—even Vitruvius in *Ex Editione* wrote about it. If we didn't know whether we were making or losing money, there wouldn't be any boom or fall. A natural corollary of this knowledge is the practice of accounting. During the middle ages we didn't know how much we made or lost and so there was no depression. But accounting dates back to the gods of Rome and Greece. In the days of Nero Petronius wrote of casting accounts and auditors.

"Then the gods were happy. Jove didn't have an auditor to tell him he had spent more thunderbolts in June than he did in May; Hebe didn't have a cost accountant to tell her that ambrosia had risen in price and she would have to water

it; Apollo didn't have an efficiency engineer to tell him that chasing Daphne interrupted the efficient operation of his chariot; Bacchus had no financial organization that rode to hounds in depression and recession."

I started to ask the meaning of this last but noticed that the Little Man was trying to climb his cane which he had hung over the bar rail—the two Old Fashioned's were gone.

★ ★ ★

Public Opinion

Los Angeles has completed a canvass of public opinion on the quality, beauty, charm or anything you may call it of her major buildings. This may be a good idea but its value as a guide to architects in planning future buildings is questionable. What the people like is often a matter of tradition or prejudice.

In the latter part of the fifteenth century strenuous efforts were made to introduce anesthetics to relieve pain. One hospital in Holland was burned down to prevent the use of them. Did not the Bible say man was born in pain? If a public vote had been taken there would have been few in favor of easing suffering. True, that was not an aesthetic question; it was anesthetic. Nevertheless, perhaps it is not so important that the people get what they like as it is that they get what they should have.

★ ★ ★

How're Your Kidneys?

Do they ache? Do you have colic in them? Are you a collection of nephritic pains? Well, get yourself a piece of nephrite and wear it constantly. Simple, isn't it?

For several thousand years the Chinese have had unflinching faith in the efficacy of nephrite in all cases of kidney trouble. Our mothers used to tie a red string around our necks to stop "nose bleed," carry a piece of raw potato to cure rheumatism. That was all nonsense. But when it comes to kidney trouble take it from the Chinese there is nothing like nephrite. It is the quintessence of creation, the "traditional food of the Taoist geni." We call it white jade.

(Turn to Page 8)

ARCHITECT AND ENGINEER

Since 1905

Volume 141

June, 1940

Number 3

MUSIC CORPORATION OF AMERICA BUILDING, Beverly Hills 18
Paul R. Williams, Architect

RECENT WORK OF PAUL R. WILLIAMS, ARCHITECT . . . 19

ARROWHEAD SPRINGS HOTEL, Arrowhead Springs, California . 20
Gordon B. Kaufmann and Paul R. Williams, Associated Architects

NEW SCHOOL UNIT FILLS TODAY'S EDUCATIONAL NEEDS . 43
Paul E. Gustafson

THE ARCHITECT: FORGOTTEN MAN? 46
William A. Delano, Architect

ELECTRIC FIXTURE INDUSTRY IN NEED OF FRESH IDEAS . . 49
Mary Davis Gillies

UNIFICATION—A REASON 53
Harris Allen

WITH THE ARCHITECTS 55

WORK OF PAUL R. WILLIAMS 19-41
(Photos, Plans, Measured Drawings)

RALPH WALDO EMERSON JUNIOR HIGH SCHOOL, Los Angeles 42-4
Richard J. Neutra, Architect

NEXT MONTH—RECENT WORK OF CLARENCE W. W. MAYHEW,
ARCHITECT, SAN FRANCISCO

(Index to Advertisements—Page 72)

HONORARY EDITORS

Arthur Brown, Jr., Timothy L. Pflueger, Lewis P. Hobart, John J. Donovan, Will G. Corlett, Frederick H. Meyer, Thos. J. Kent, Gordon B. Kaufmann, Ben. H. O'Connor, Michael Goodman, Harry Michelsen.

REGULAR CONTRIBUTING EDITORS

Harris C. Allen, Harry Sanders, Paul H. Hunter, Glenn Stanton, Chas. H. Alden.

EDITOR, FRED'K. W. JONES; ASSISTANT EDITOR, E. N. KIERULFF; CONSULTING AND CONTRIBUTING EDITOR, MARK DANIELS.

ARCHITECT AND ENGINEER is published on the 15th of the month by The Architect and Engineer, Inc., 68 Post Street, San Francisco. President, K. P. Kierulff; Vice President, Fred'k. W. Jones; Secretary and Business Manager, L. B. Penhorwood.

Entered as second class matter, November 2, 1905, at the Post Office in San Francisco, California, under the Act of March 3, 1897. Subscriptions, United States and Pan America, \$3.00 a year; foreign countries \$5.00 a year; single copy \$.50.

Los Angeles office: 832 W. Fifth Street, Bland Ballard, manager.

ARCHITECTS REPORTS are published daily from this office and are sponsored by the Northern Section, State Association of California Architects; Vernon S. Yallop, Mgr.



DIFFERENT FAMILIES—DIFFERENT HOMES

the Crane Heating Line

INCLUDES A SYSTEM FOR EACH

THE Robinsons have steam heat—the Smiths have a hot water system—the Browns have a gas-fired furnace. One architect satisfied all these heating needs—from one heating line: Crane.

And every one of those clients will get better heating to suit his own special conditions . . . in *his* size of home . . . in *his* location! For whatever the heating need—whatever the type of fuel to be burned—whatever the locality—the Crane complete heating line fills all requirements!

Crane heating systems are many—but there's a single responsibility behind them all—a responsibility that extends to every part of the

system—boiler, furnace, radiators, oil burners, stokers, controls, valves and fittings. Crane systems, you see, are unified with every part designed to work harmoniously with the others for better heating satisfaction.

Crane advanced engineering assures your clients of getting latest heating advantages . . . special features that assure more complete combustion and lower fuel costs . . . whether the fuel is coal, oil or gas . . . whether the system is completely automatic, stoker-fired or hand-fired. A post card to us will bring you all the facts about the complete Crane heating line—without obligation on your part.



This symbol identifies a Heating Contractor able to provide complete Crane heating service.



CRANE

CRANE CO., GENERAL OFFICES:
836 S. MICHIGAN AVE., CHICAGO
VALVES • FITTINGS • PIPE
PLUMBING • HEATING • PUMPS

NATION-WIDE SERVICE THROUGH BRANCHES, WHOLESALE, PLUMBING AND HEATING CONTRACTORS

SOME FRESH EXAMPLES OF TODAY'S ARCHITECTURAL TREND

FACTORY

Outstanding among industrial plants and factories of the United States the home of the Friden Calculating Machine Company in San Leandro California is modern, light and airy. The building, which is an excellent example of streamlined industrial architecture,

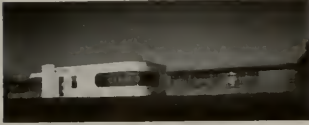

is located on a large plot of ground which has been landscaped and planted. Frederick H. Reimers, San Francisco, who was the architect for the building, is now working on plans for a major addition to the



office wing of the building.

The plant was completed several years ago and serves a dual role; executive and busi-

ness offices are located on the street front of the building while mechanical equipment, storage rooms and work space are found in long narrow wings extending back from the office space. Since the building is but one story high, skylights and vents provide adequate ventilation and cross ventilation and good light are found in every portion of the factory.

The office section of the building is built of steel frame construction with plaster finish on the interior and exterior. There is a composition floor over a concrete slab; interior partitions are of wood construction; steel sash is used throughout.

Construction items in the factory wings include structural steel frame, steel sash, sheet metal cornice and composition roof.

OFFICE BUILDING

Below is the architect's conception of a 12 story professional office building which A. W. Ross and Associates plan to erect on the south side of Wilshire Boulevard, near Ogden Drive, Los Angeles. Modern in design, it indicates an interesting treatment of glass brick and glass windows providing abundance of light needed for a building of this character. There will be two floors of garage space below the street. Plans are being prepared by Stiles O. Clements of Los Angeles in collaboration with E. A. Hamilton and Henry F. Reitz. The illustration is shown by courtesy of Southwest Builder and Contractor.



TICKET OFFICE

Striking departures from the conventional in design, lighting and decoration characterize the new Union Pacific Railroad passenger and freight offices at Geary and Powell Streets, San Francisco.

The Offices were designed by Robert C. Williams of Chicago and the construction work was supervised by Williams and Grimes, Albert R. Williams, architect. Lindgren and Swinnerton were the general contractors.

The "streamlined" exterior of the ticket office is of yellow porcelain enamel with red and grey trim, the Union Pacific streamliner colors, and are floodlighted with super-neon fluorescent light.

NATIONAL PLANNING CONFERENCE

The National Conference on Planning, the most important planning conference held yearly in the United States, will convene in San Francisco, July 8-11. There will be an attendance upwards of 500 delegates representing the four participating organizations, the American Society of Planning Officials, the American Institute of Planners, the American Planning and Civic Association, the National Economic and Social Planning Association, as well as members of Planning Commissions throughout the Nation. Walter H. Blucher, Executive Director of the American Society of Planning Officials, is Conference Director. Dr. Baldwin M. Woods, Chairman Region VIII National Resources Planning Board, is Chairman of the Conference. The official sponsor for the Conference is the City Planning Commission of San Francisco. Mrs. Albert W. Stokes, President. Mark Jorgensen, Secretary of the Planning Commission, is Chairman of the Committee on Local Arrangements.

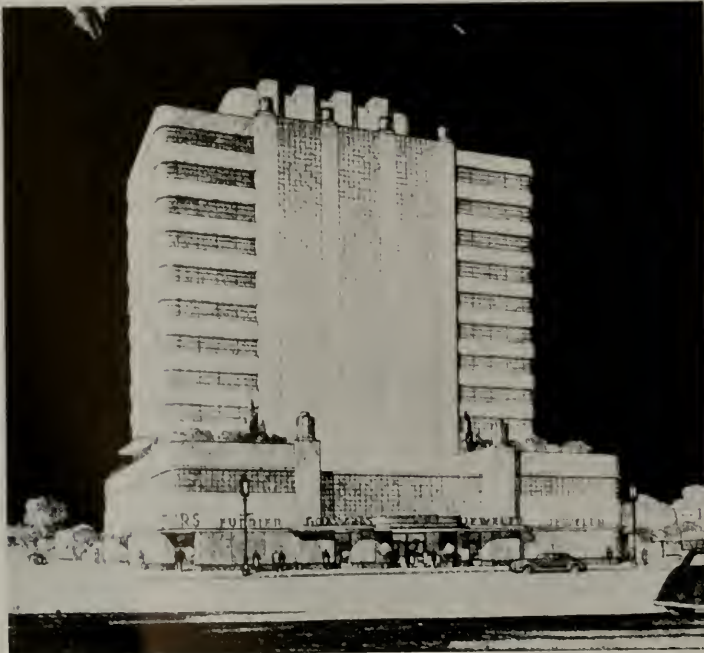

See what **6x9** tiles do for a Kitchen!

YOUR CHOICE OF 18 DELICATE PASTELS EXCLUSIVE WITH KRAFTILE



These Master Kraftile 6x9's have created a new look in bathroom and kitchen wall beauty.

Picture your modern bathroom and kitchen fixtures in such smart company! And what charming Western pastels you have to choose from!

Master Kraftile is different from anything you have ever seen in ceramic wall tile. Each square is a masterpiece of modern design—like a piece of art—long, narrow, wide and durable.

Each square is a masterpiece of modern design—like a piece of art—long, narrow, wide and durable.

MASTER KRAFTILE 6x9's

... AND DATE YOUR BATHROOMS "TOMORROW"... NOT "YESTERDAY"

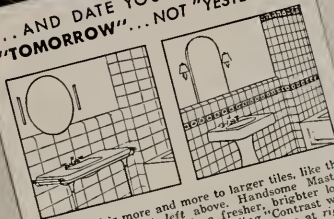

The trend is more and more to larger tiles. Like the 6x9's pictured at left above. Handsome Master Kraftile 6x9's give walls a fresher, brighter look... and robins a more "open feeling." Contrast with the old-fashioned "fussiness" of bathroom at right.

FREE Idea Folder and Your local Kraftile dealer

This Master Kraftile 6 x 9 ad appeared in full color in the April issue of *Sunset*, favorite magazine of more than 230,000 western home lovers

The Master Kraftile 6x9 ad reproduced above has drawn hundreds of inquiries from *Sunset* magazine readers.

Yes, home owners today are interested in smarter surroundings . . . in bathrooms and kitchens designed along "tomorrow's" lines . . . not "yesterday's."

If you'd like to capitalize on some of this new-home desire which Master Kraftile ads are bringing to light, write for data on Kraftile's "New Jobs Ahead" program. Fill out coupon.

Kraftile Company is a member of the Producers' Council, Inc., the national organization of manufacturers of quality materials



MAIL TODAY

KRAFTILE COMPANY, Niles, California

Please send me information on your "New Jobs Ahead" program of cooperation with architects

Name _____

Address _____

City _____ State _____

MASTER KRAFTILE 6 x 9's

JOHNSON Temperature Control



A Committee Conference in an outstanding American School . . .
Nichols Intermediate School . . . Evanston, Ill.

Architects of Modern Schools Demand Comfort, Health and Lower Fuel Bills

Comfort is one of the principal benefits offered by Johnson automatic temperature control systems. But, incidentally, Johnson control has produced such large fuel savings that, today, those responsible for the construction and modernization of economical school plants urge the use of modern Johnson precision control apparatus . . . Schools, public buildings, factories and every other type of building present specialized heating and air conditioning control problems. Year after year, the Johnson organization has added to its large fund of knowledge in designing and installing automatic control for every type of heating and ventilating system. Save your valuable time. Call a Johnson engineer for recommendations and estimates.

JOHNSON STARTS AND FINISHES THE JOB— A COMPLETE ORGANIZATION

• Johnson designs, manufactures, installs and services its own precision control installations. A nation-wide organization, with more than 50 years experience in just one line of business—automatic temperature and humidity control.



JOHNSON

Automatic TEMPERATURE AND AIR CONDITIONING *Control*

JOHNSON SERVICE COMPANY: MILWAUKEE, WIS. AND DIRECT BRANCHES IN PRINCIPAL CITIES

A widely diversified program has been arranged for the discussion of planning in all its phases: city, county, regional, state and national. Special topics will cover problems in zoning, architectural control, housing programs, decentralization of downtown districts, highway planning and roadside protection. The use of tax abandoned lands, migration and re-settlement of people and, in general, the nature of planning in democracy, will also be discussed. Competent and recognized authorities will be chairmen and principal speakers at the sessions, which will be open to the public.

On Tuesday, July 9th, a general civil luncheon will be held in connection with the Conference. The speaker of the day will be Rexford G. Tugwell, Chairman of the New York City Planning Commission, whose topic will be: "San Francisco as seen from New York." The speaker and the topic should result in an informative and interesting talk on the comparative plans and development for the two metropolitan areas. A city wide tour is scheduled for the afternoon which will be followed by entertainment at the San Francisco Building, Golden Gate International Exposition. The remainder of the evening will be free to the delegates to visit the Exposition where special attractions will be offered in keeping with the designation of the day as "National Conference on Planning Day."

STARTED SOMETHING

Architect and Engineer
San Francisco

Please wire collect whether you can send immediately by air mail "tear sheets" of Kenneth Black's discussion of Modern Architectural Theories in your February issue. Billing us accordingly. Thank you.

Architectural Forum

While on the subject of Architect Black's following letter, which came about the same time as the Forum's wire, is printed because it throws some interesting light on the early career of John Dinwiddie, whose work was pictured in the April issue of Architect and Engineer.

Dear Mr. Jones:—

Mr. Talmage C. Hughes, Editor of the Weekly Bulletin of the Michigan Society of Architects, has just sent me a copy of the April issue of Architect and Engineer.

His object in sending it was to acquaint me with the fact that you had published some of the letters which came to you as a result of the publication of my lecture on Modern Architectural Theories in your February issue. He also directed my attention to the other kind things you said about the Michigan Society on page 54 of the April issue.

But the thing which pleased me most about that issue was the presentation of the work of John Dinwiddie. Because believe it or not, I too was a member of Mr. Elie Saarinen's class at Ann Arbor, to which you refer at such length in your introduction of

EVERY ACCEPTED MEASURE OF HEAT LOSS PROVES

SIDEWALLS NEED INSULATION



... and Economy Says—

INSTALL IT WHEN BUILDING!



Russell Mills, arch., planned this handsome home for D. O. Robinson, Reno, Nev. Sidewalls and top-floor ceilings are safeguarded by Celotex Insulation.

CELOTEX GUARANTEED INSULATION REPLACES OTHER MATERIALS — PROVIDES STRUCTURAL STRENGTH, INSULATION, VAPOR SEAL, AT ONE COST!

SIDEWALLS represent definitely large heat-loss areas in a house. They need insulation if the owner is to realize economy of fuel. And economy of construction calls for installing sidewall insulation *at the time the house is built*. By building with Celotex Vapor-seal Sheathing and Celotex Vapor-seal Lath—*both of which replace other materials at small extra cost*—this vital sidewall protection is permanently assured, at minimum expense!

This fact has been emphasized to millions of magazine readers by the current Celotex advertising campaign. That campaign has been planned to make it

easier for you, the architect, to persuade your clients to include sidewall insulation when they build.

By providing structural strength, insulation, and vapor seal—all at a single cost—Celotex Vapor-seal Products are enabling thousands of owners to enjoy the *complete protection* they might otherwise neglect. Further advantages include permanent protection against termites and dry rot, provided in all Celotex cane fibre products by the exclusive, patented Ferox Process—and the famous Celotex written life-of-building guarantee.* Mail the coupon for full details.

*This guarantee, when issued, applies only within the Continental United States.

CELOTEX

REG. U. S. PAT. OFF.

BUILDING PRODUCTS

The word Celotex is a brand name identifying a group of products marketed by The Celotex Corporation, including **CANE FIBRE INSULATING SHEATHING, LATH, INTERIOR FINISH ASPHALT SHINGLES, SIDING, ROLL ROOFING • ROCK WOOL BATTS, BLANKETS • GYPSUM PLASTERS, LATH, WALL BOARDS**

Sole Distributors Throughout the World

THE CELOTEX CORPORATION AE 6-40

919 N. Michigan Ave., Chicago, Ill.

Please send complete details about Celotex Guaranteed Insulation.

Name _____

Address _____

City _____

County _____ State _____

Mr. Dinwiddie on page 17; and I too had the pleasure of studying in Europe as holder of the Booth Traveling Scholarship!

My first glance at the cover of your April issue brought forth a flood of memories. Not only did I see a picture of Mr. Dinwiddie—looking not a day older than he did fifteen years ago—but in my mind's eye I could see him rushing into the drafting room in the old Engineering Building at Ann Arbor. (Those were the days before the erection of the fine building which now houses the College of Architecture at Michigan) banding his tall frame over the board, and slaving away at the delicate details of the model for the development of the San Francisco waterfront which appears in the lower right hand corner of your cover.

While he was meticulously modeling the group for San Francisco, Ray Weber and I were working away at the next table on models for a new group of buildings for the Michigan State Capitol at Lansing. I wonder if John's classroom dream is any nearer fulfillment than ours?

I certainly hope so, because while the enthusiasm generated in Mr. Searinen's classroom has led me to serve for the past ten years as Secretary of the Lansing City Plan Commission and for the past two years as a member of the Michigan Planning Commission, (which incidently was cut off without any funds by the last legislature) both have been labors of love, with only an occasional feeling that some progress is being

made in overcoming public apathy toward planning. But even an occasional feeling of progress seems to keep the spark alive, and isn't most everything relating to architecture a labor of love anyway? Or are things different in California?

In any case I think you will agree it is quite a co-incidence that with this common educational background, Mr. Dinwiddie and I should suddenly break into print in such a commendatory manner in the same issue of the same magazine! Especially when the magazine is published about three thousand miles from our Alma Mater and the Editor couldn't possibly have suspected any connection. Page Mr. Ripley!

The issues of your magazine which have reached me lately have led me to suspect that maybe there is something good in California besides climate and scenery. Just to find out for sure, I am enclosing my check for a year's subscription, and if you continue to publish work as interesting as Mr. Dinwiddie's I will probably become a permanent member of your family.

Sincerely yours,

KENNETH C. BLACK.

President, Michigan Society of Architects,
Detroit, Michigan.

RUNNING FIRE

(Continued from Page 1)

The early Spaniards called it "piedra de hijada," the French "pierre de l'ejade,"

which proves in both names, that it was a kidney stone, not the kind you have cut out but the kind you cut into. But it really is the first form of what we now call jade, worshipped for many centuries by the wise Chinese.

If you really want to learn all about nephrite and all other forms of jade, go to the Chinese Village at the Golden Gate International Exposition and talk to Chang Wen-Ti. This year the world famous collection of jade has returned to Treasure Island, greatly amplified, in a large space where you can really see it. Mr. Chang will tell you all about it, and many other things you ought to know about jade, the most beautiful stone in the world. And, what is more, he has hundreds of pieces of incomparable beauty to illustrate his dissertation.

★ ★ ★

APHORISMS FROM "RUNNING FIRE"

"All things come to him who waits," said Poverty as she socked Honesty in the eye.

Some men have so many talents that they cannot find time to develop their own.

Living too much in the past gets your mind all cluttered up with rear vision mirrors.

Only grown-ups can be "cleaned," without water.

Lincoln was the great liberator but he freed only the black slaves.

Many people can see no relation between a revolver and a revolt.

A. F. MATTOCK CO.

BUILDERS

SAN FRANCISCO * BURLINGAME

EARLY CALIFORNIA COMES OF AGE



ALL-GAS PLANNING ADDS COMFORT TO ROMANTIC CHARM



FOLD back both ends of a century until they overlap . . . blend 1840 romance with 1940 practicality . . . add a California backdrop of warm brown and living green . . . and the stage is set for Home Contentment. ☆ In this appealing house for *Mr. and Mrs. Bert E. Taylor*, Rancho Santa Anita, Arcadia, Architect *Kenneth A. Gordon* employed handmade adobe and natural wood for authentic character—all-gas planning for effortless comfort: Forced-air gas heating, gas water heater, gleaming gas range, silent gas refrigerator, all automatically controlled. ☆ Your Gas Company volunteers helpful cooperation in preparing *your* specifications—a *free* technical service.

LET GAS THE MODERN FUEL DO THE 4 BIG JOBS

HEATING • WATER HEATING
COOKING • REFRIGERATION



The House That Is DESIGNED for LIVING

The architect's plans for this house include provision for ADEQUATE electrical wiring, because that is the basis of comfort and convenience for those who will live in it.

Adequate electrical wiring is the architect's concern because wiring is an integral part of the structure. It must provide plenty of outlets for appliances in use at present and new ones as they are acquired, as well as for lighting. If it does not, it will be a source of inconvenience and annoyance.

If the building has to be rewired after it is completed, it will be much more expensive than if it had been done correctly in the first place.

Specify RED SEAL wiring in your plans, and be assured a sound foundation for adequate electrical convenience both now and for the future.

PACIFIC COAST
ELECTRICAL BUREAU

447 SUTTER STREET • SAN FRANCISCO, CALIFORNIA

AQULUX 85

NEW Oil Burning
Water Heating Unit

This powerful and compact vertical unit, beautiful in appearance, is designed to supply hot water at minimum cost in the modern home. It can also be used to supply heat and hot water automatically for small homes without the necessity for basement installation. Complete data on this new "package unit" now ready.

Burns No. 3 C. S. G.
fuel or Diesel oil

S. T. JOHNSON CO.

940 ARLINGTON, OAKLAND, CALIF.
401 N. BROAD ST., PHILADELPHIA, PA.

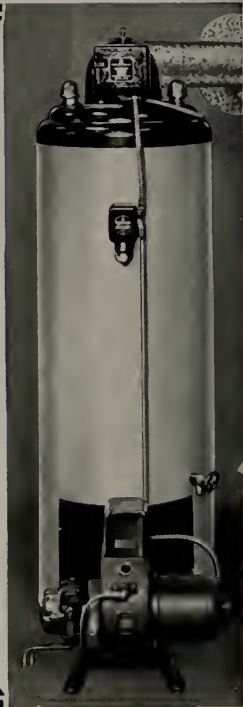

When you are Building Material minded think of GUNN, CARLE

Time has proven the worth of their goods

BULL DOG CLIPS



Securely anchor sleepers in concrete slabs.

CABOT'S BLEACHING OIL

permanently preserves wood exteriors, giving that soft, weather-beaten silver grey effect.

VENETIAN BLINDS

Afford Light and Air without draft or glare.



GUNN, CARLE & CO.

SAN FRANCISCO

20 Potrero Avenue

Underhill 5480

For more rigid, warmer, dustproof houses, specify **PLYSCORD**

THE UTILITY GRADE OF DOUGLAS FIR PLYWOOD

PLYSCORD is ideal for wall and roof sheathing, sub-flooring and one-use concrete forms!

● Plyscord is the unsanded utility grade of Douglas Fir Plywood. Because it affords superior rigidity and strength; quick, economical application, air-tightness; and large size... it is unsurpassed for wall and roof sheathing, sub-flooring, one-use concrete forms and similar construction work. Progressive lumber dealers everywhere handle Plyscord in 5/16", 3/8", 1/2" and 5/8" thicknesses and in 32" x 96" and 48" x 96" sizes.

You will find Plyscord easy to specify and identify because every panel is manufactured in strict accordance with U. S. Commercial Standard CS45-38 and stamped with a distinctive "grade trade-mark."

For more information, consult Sweet's Catalog or write for these free booklets: Suggested Specifications for Douglas Fir Plywood, Commercial Standard CS45-38, Dri-Bilt Manual. Douglas Fir Plywood Association, Tacoma Bldg., Tacoma, Washington.



WALL SHEATHING The Plyscord-sheathed walls of this residence in Seattle, Wash., are 40% more rigid than if diagonal board sheathing had been used. The big panels also save up to 50% on sawing, fitting and joining... 50% on nailing. Tezaya Francis Bellamy was the architect on this residence.



SUB-FLOORING In this Stamford, Conn., home designed by Provost and Edwards, Plyscord provided a smooth base for finish flooring and linoleum—insulates and protects against drafts from below—gives a horizontal diaphragm to resist earthquakes and high winds. Recommended thicknesses are 1/2" and 5/8".



ROOF SHEATHING Plyscord is suitable for any type of roofing—shingles, composition roofing, asbestos tile or slate. Illustration shows Plyscord roof sheathing on a Portland, Ore., residence designed by Richard Sundeleaf.

FHA has accepted Douglas Fir Plywood for home construction, and its use is approved in Uniform Building Code.

GRADE-MARKED The face of every genuine Plyscord panel contains the circular stamp (left) and guide line 16" on center which speed nailing.

PROVED BETTER

At right: Tests at Forest Products Laboratory, Madison, Wisconsin, showed Plyscord 5.9 times as rigid as horizontal board sheathing—40% more rigid than diagonal board sheathing.

	1.0
HORIZONTAL LUMBER	
	3.0
25/32" FIBRE BOARDS	
	4.2
1" X 4" LET-IN BRACING	
	4.3
1" DIAGONAL SHEATHING	
	5.9
1/4" DOUGLAS FIR PLYWOOD	

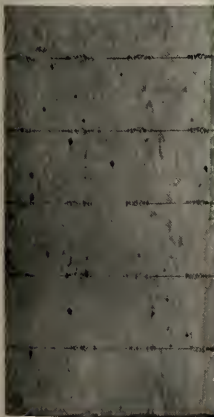

SPECIFY DOUGLAS FIR PLYWOOD BY THESE "GRADE TRADE-MARKS"

PLYSCORD D.F.P.A.

EXT.-D.F.P.A.



DOUGLAS FIR PLYWOOD
Real Lumber
MADE LARGER, LIGHTER
SPLIT-PROOF
STRONGER

Contrasts in Modern Art

Students of art and art critics have accepted Surrealism and Abstract Art as serious and important art expressions of our time. The general public has been less willing to "follow." It is this discrepancy between the critic's appreciation and the layman's lack of response which has given the museum of today a new responsibility.

With the recent shows of works by the Frenchmen, Tanguy, and four American abstract artists, the San Francisco Museum of Art assumed the roll of mediator. Those puzzled with the "meaning" of abstract and surrealist art may not have found full satisfaction as they witnessed these works by Tanguy and the four Americans.

The simultaneous showing of Tanguy's paintings and the works of the four Americans presented some interesting contrasts: The surrealist's approach is thoroughly emotional.—emotional and irrational to the same degree our dreams are. What links the abstracts' work is determined by strict logic and calm order. What links the two, is their lack of concern with the representational, with the obvious elements of reality in its plain, concrete manifestations. What links them further, is their utmost sensitivity and their sound grasp of forms and color.

The four abstract artists are George L. K. Morris, Charles G. Shaw, Susie Frelinghuysen, and Albert Gallatin, the latter a member of a prominent Eastern family and the founder and director of the Museum of Living Art in New York. Tanguy's paintings will be retained until late this month.

Luis Alberto Acuna

Art's South-American way is powerfully demonstrated in another important show now at the Museum, of paintings and chalk drawings by the young Colombian, Luis Alberto Acuna.

Acuna's work is deeply rooted in the past of his country. Obviously he likes (and follows here and there) Picasso. But he is more concerned with the symbols and forms of expressions of the Indians. Bold outlines, rich colors, simplicity of arrangement and a strong sense of rhythm give a strong flavor of originality and genuine talent to his allegories and phantasmagories.

Art at the Exposition

Some of Acuna's work is also shown in the section of South-American paintings at Treasure Island, which Dr. Morley gathered on her recent trip to Chile, Peru, and the other western states of South America.

In many ways the Museum will actively participate in the great show at the Exposition which once again is one of the main attractions on the Island. Particularly in the field of education and art appreciation the Museum will work closely with the Fine Arts Palace. As in 1939, special tours and lectures will be arranged for members of the Museum.

**PAUL R. WILLIAMS, ARCHITECT**

Probably no one architect on the Pacific Coast has achieved greater success in domestic architecture than Mr. Williams. His work has received national recognition, a tribute particularly noteworthy in view of the handicaps which Mr. Williams faced at the start of his career. He was fortunate in being able to work for and with such capable architects as Reginald D. Johnson and John C. Austin. The several pages devoted to illustrating Mr. Williams' work in this issue reflect the fine understanding for good design which Mr. Williams enjoys.

Carnegie Grant

For the third time, the San Francisco Museum of Art has received a grant for the support of its educational activity from the Carnegie Corporation in New York.

According to word received by Dr. Grace L. McCann Morley, Director of the San Francisco Museum of Art, the Museum will receive \$5,000 for a program of visual individual art instruction by microfilm. The project will be carried on at the Golden Gate International Exposition's Fine Arts Palace during the summer and will be completed at the Museum.

Illustrated analyses of some of the great Old Masters to be shown at the Fair will be given on microfilms and will be available for individual use to visitors of the Fine Arts Palace. It is planned to make microfilms dealing with important art movements and great artists which later will be sent to every country school and to every small town library. Art in an entirely new and strikingly lively form will thus be brought to thousands of individuals all over the country.

The American architect has been accused of employing bricks without brains but we will have them so long as we have brains without bread.

THE Golden Gate International Exposition of 1940 has opened its gates to the world on Treasure Island in San Francisco Bay.

Education, visualized and streamlined; facts and data, sugar-coated for easy consumption; art in action; history dramatized against a spectacular background; fun and frolic from all parts of the world; entertainment that runs the gamut of stage and screen. . . . this is the Exposition of 1940, a new world's fair re-created on the man made island in one of the world's greatest natural harbors.

Whether you are an intellectual and enjoy the chiaroscuro of Rembrandt and Renoir; whether you are a slave to appetite and admire the chef and his spoon more than the artist and his brush; whether you find inspiration in the hues of nature's blooms or the fluorescence of mercury-vapor tubes on tower and arch and wall . . . there is stimulus at Treasure Island, intriguing, mystifying, intense.

There is a distinct and original appeal for every one of the five senses: color, gay by day and iridescent by night, to delight the eye; odors of blossoms, fragrant and delicate, that conjure up memories of cottage gardens, broad meadows and the scent of forest glens in the spring; music of bands and orchestras and choral voices raised in vibrant song to satisfy the ear; textiles from wide reaches of the Pacific that invite an admiring touch; and viands of the seven seas, prepared as for a king, to beguile the gourmet as he sits at ease.

Here are a few of the highlights of the Exposition:

Art in action. Diego Rivera Herman Volz, Helen Forbes, Maxine Albro, Gen Lukens, Dudley Carter, Michael Chepourkoff, Antonio Sotomayor, Marion Simpson, and other artists at work. Weaving and graphic arts. Printing exhibit commemorating 500th anniversary of invention of printing from movable types; pageant of photography; old masters and contemporary American and European art; Thorne miniature rooms.

America, Calcade of a Nation. Great events in the history of the United States portrayed by 500 characters on a gigantic stage. A dramatic thriller from the landing

(Turn to Page 66)

FLOORS FLEXIBLE TO THE ARCHITECT'S DESIGN

... PRACTICAL FOR HIS CLIENTS!



Kindergarten interior, Netherwood School, Plainfield, N. J. Note distinctive Personal-sized floor of Nairn Linoleum.*

IN PLANNING beautiful, distinctive school floors the architect finds Nairn Linoleum "ready made" for his purposes. Extremely flexible, easy to work with, it fits any decorative scheme. Allows new and wider scope in designing interesting interiors.

At the same time, Nairn Linoleum furnishes the client with a practical floor that meets every school requirement. Beautiful and distinctive. Built for years of service. Easy to clean. Requires little maintenance. Footeasy and quietizing. Sanitary, because its satin-smooth surface is completely free from cracks that retain dirt.

Installed by Authorized Contractors, Nairn Linoleum carries a guaranty bond covering the full value of workmanship and materials. CONGOLEUM-NAIRN INC., KEARNY, NEW JERSEY.

*Trademark Registered

JUNE, 1940

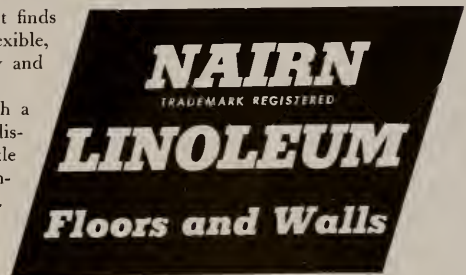

END SHOWER TROUBLES



STAINLESS METAL PRODUCTS — OAKLAND

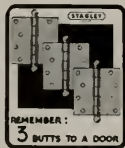
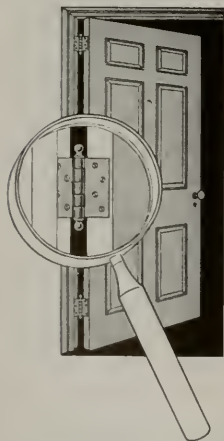

SATISFACTION

calls for the third butt—every time. It holds the door in line, preserves its appearance, keeps the lock working smoothly. Specify *Three Butts To A Door!* The Stanley Works, New Britain, Conn.



Stanley 241
Standard
of the World
for over
Fifty Years

STANLEY

TRADE MARK

HARDWARE FOR CAREFREE DOORS



MR. ARCHITECT:

8 Good Reasons why you should specify FRANTZ "Over-the-top" Garage Door Equipment

Simple and easy to install, the FRANTZ "Over-the-top" set has many advantages over the pivot or counter balanced types. They include:

- 1 Low headroom. Requiring only two inches of clearance above the door header.
- 2 The door — when open — does not project beyond the header, is entirely within the building.
- 3 A reduction in ceiling height in garage construction. As much as 12 to 16 inches.
- 4 The elimination of side wall projections, leaving both side walls free and clear. Does not interfere with the location of side door entrances, window opening, shelving or cupboard.
- 5 Elimination of posts, often necessary in multiple garage door installation when using pivot sets.
- 6 No projections. The garage is freely free as the hardware applied on the edge of the door and jamb.
- 7 Steel "weather-strips" make the equipment makes a more complete and "finished" job, making the door weather tight.
- 8 FRANTZ "Over-the-top" equipment needs no weights, chains, pulleys or cables.

FRANTZ Over-the-Top Door Equipment

Write for name of authorized distributor and installation service in your territory.

FRANTZ SALES COMPANY

ROOM 627-420 S. SAN PEDRO ST., LOS ANGELES
LOS ANGELES, CALIFORNIA

SAN FRANCISCO, CALIF.

OFFICE

200 DAVIS STREET

PORTLAND, OREGON

OFFICE

131 S. W. 4TH AVENUE

No Worry for the Architect

"—All acid proof drain pipe and fittings shall be ferro-silicon—CORROSIRON—"

(Write for above specification)



FEDERAL BUILDING • CIVIC CENTER • SAN FRANCISCO

—Arthur Brown, Jr., Architect

CORROSIRON DRAIN LINES and FITTINGS and LABORATORY EQUIPMENT was specified because of its superior resistance to corrosion and wear.

Pacific Foundry Company, Ltd.

NEW YORK • 3100 NINETEENTH ST., SAN FRANCISCO • LOS ANGELES

Give Your Clients More "Breathing Space" Broaden and Brighten Homes With Glass

● You know how clients suffer from claustrophobia—feel cooped up—hemmed in by walls, no matter how hard you try to please.

You can avoid this complaint by using glass—generously. With picture or corner windows, or with sparkling mirrors, dusky corners disappear and walls move back! The whole house broadens and brightens—assumes a semblance of bigness and airiness.

In countless other ways, you can make glass *make* homes—homes that people *like to live in*. For instance, few features are so appealing to women as low-cost, full-length door mirrors. They widen entrance halls and bring a cheery note of welcome to guests. In bedrooms and bathrooms the head-to-foot reflections are appreciated by every member of the family. And partitions or doors of shimmering figured glass add beauty, brightness and a pleasing new dimension to rooms.

Talk to your L·O·F glass dealer.



See how spacious areas of glass open up this room—make it bright, airy and cheerful.

You'll find he has a fund of information about glass that will inspire and facilitate your use of this fascinating material. And it's well to keep in mind that for best effects with glass nothing but the *best* will do. You can specify none *better* than L·O·F glass, yet it costs no more. Libbey·Owens·Ford Glass Company, Toledo, Ohio.



Glass makes a gem of this breakfast bar between the dining room and the kitchen. When not in use the doors swing out to form a mirrored panel between the upper and lower cupboards. Upper cupboard doors are glazed with *Louvrex decorative glass*.



Women appreciate the check-up of every detail of appearance that full-length door mirrors provide.



LIBBEY·OWENS·FORD QUALITY GLASS

NATIONAL BUILDING COST SURVEY

The final report in the spring 1940 national construction cost survey conducted by The Dow Service while showing a minor composite national building increase of one per cent since January 1939, is exceedingly noteworthy in many of its details.

One half of the 75 cities reported show increases, six show no change and the balance a decrease. The area of greatest cost increase is in the northern half of the State of New Jersey.

The highest increase in general building cost was at Passaic, N. J., and Wyandotte, Michigan, each with an eleven and one-half per cent rise. The greatest decrease was at Los Angeles with a ten per cent drop.

Bricklayers are highest paid in New York and Pittsburgh where they draw \$1.90 an hour. Carpenters are paid best in New York, Newark, Jersey City and East Orange where they receive \$1.75 per hour. Cement finishers receive highest wages in Newark and East Orange. Composition roofers are best paid in Jersey City and Chicago at \$1.75. Electricians at \$2.00 an hour draw most in New York. At \$1.75 an hour painters get paid most in Jersey City. Common labor at \$1.20 an hour is highest paid in Jersey City. Plasterers get \$2.00 an hour in New York and Washington. New York plumbers and steamfitters are the nation's highest paid at \$2.00 an hour. Sheet metal workers receive best pay in New York and Jersey City at \$2.00. Structural iron workers are the highest paid building trades mechanics in the country at \$2.125 an hour in Yonkers, N. Y. They get \$2.00 an hour in Washington, D. C. and Paterson, Passaic, East Orange, Newark, Jersey City, Hackensack and Elizabeth—all in Northern New Jersey. Yonkers pays tile setters best at \$1.71 an hour. New York City building trades wages, generally speaking, are 38 per cent higher than the nation's average wages for all cities reporting.

The following table compares Pacific Coast cities' costs with New York, N. Y. The latter is given as 100.0

(per cent). Seattle, Washington, shown at 71.3 in the table means that Seattle building costs are 71.3 per cent of New York's costs or 28.7 per cent less than New York costs. Other cities can be read similarly:

Los Angeles, California	65.9
Oakland, California	74.8
Portland, Oregon	64.5
San Francisco, California	73.3
Seattle, Washington	71.3

These computations and statistics are based upon written information secured from sources considered authoritative by the Dow Service. Information is not guaranteed though believed accurate. Over 500 sources were contacted and are experienced in this work.

BAY BRIDGE TRAFFIC

April proved to be another month of heavy traffic on the San Francisco-Oakland Bay Bridge, Director of Public Works Frank W. Clark reported to Governor Olson. The total number of vehicles crossing fell just under the one million mark.

The increase over the same month a year ago was 114,487 vehicles, or 13.5 per cent. If the Exposition traffic last April is eliminated, the net bridge traffic shows an increase of 256,560 vehicles, or 37.8 per cent.

The total vehicular revenue was less in April, 1940, than a year ago by \$84,879.

April traffic on the San Francisco-Oakland Bay Bridge and comparative figures are:

	April 1940	April 1939	March 1940	Total since opening
Passenger autos and auto trailers	874,469	767,327	879,559	30,966,127
Motorcycles and tricars	3,788	3,467	3,301	141,961
Buses	17,970	16,407	17,990	508,761
Trucks and truck trailers	49,231	44,790	46,612	1,497,674
Others	18,346	17,326	16,898	530,242
Total vehicles	963,804	849,317	964,360	33,644,765

CONTRACTOR'S QUANTITY PURCHASE BUILDING MATERIAL PRICES DELIVERED JOB SITE—APRIL 1940

	BRICK	CEMENT	PLASTER	LUMBER 2ND GRADE		
				1 x 6	2 x 4	2 x 10
Los Angeles, California	12.00	2.10	17.00	25.00	26.00	26.00
Oakland, California	14.00	2.80	21.60	25.00	26.00	24.00
Portland, Oregon	17.00	2.55	20.00	17.00	17.00	17.00
San Francisco, California	14.50	2.50	20.00	26.00	22.00	24.00
Seattle, Washington	17.50	2.75	20.00	20.00	20.00	20.00

(Brick is common hard per thousand; Cement is per bbl in paper; Plaster is neat wall per ton in paper; Lumber is second grade per thousand board feet, most generally used local specie.)

For Sale — Business Leads — at One Cent Each!

SLUMP IN MAY BUILDING

"Architects' Reports" for the month of May showed a considerable drop in the number and value of new projects for which plans were reported in progress. The total sum credited under this classification for April was \$6,902,000 as against \$3,951,300 for May. The \$3,000,000 shortage is attributed to absence of new governmental work (industrial) which totalled \$2,740,000 in April, and which dropped to \$740,000 in May. Following are the totals under the three main classifications which comprise the main features of Architects' Reports Daily Service:

*

Plans in Preparation

Residence	\$ 207,000	
City, County and State.....	85,000	
Schools and Colleges.....	2,186,300	
Theatres, Churches, etc.	423,000	
Office Buildings	230,000	
Stores and Markets	80,000	
Industrial	740,000	\$ 3,951,300

*

Projects out for bids, but not awarded

Residences	\$ 239,000	
City, County and State.....	668,661	
Government	6,270,757	
Schools and Colleges	656,995	
Theatres, Churches, etc.	275,140	
Office Buildings	25,000	
Stores and Markets	131,000	
Industrial	542,000	\$ 8,808,553

*

Contracts Awarded

Apartments	\$ 287,764	
Residences	502,069	
City, County and State	499,705	
Government	3,228,046	
Schools and Colleges	537,403	
Theatres, Churches, etc.....	677,977	
Office Buildings	93,655	
Stores and Markets	509,323	
Industrial	635,823	\$ 6,971,765
		\$19,731,618

A DAILY advance building news service, reporting construction projects for the Northern California area, comes to subscribers in the form of handy, individual slips, giving name of owner, location, architect, proposed cost and other pertinent and valuable data.

ARCHITECTS' REPORTS, as the service is called, is mailed daily, and the average number of these reports runs over ONE THOUSAND MONTHLY, based on our current count.

At a cost of \$10 per month, the reports actually reach the subscriber at less than ONE CENT EACH.

ARCHITECTS' REPORTS

Published by

The ARCHITECT AND ENGINEER, INC.

68 Post St. SAN FRANCISCO

Telephone EXbrook 7182



Saks

ENCORES PAYNEHEAT!

The Annex of Saks Fifth Avenue Store, Beverly Hills is *PAYNEHEATED* . . . as is the original building. Patrons of Saks are thus assured of healthful warmth in winter, cooling ventilation in summer. *PAYNE* "CB" Gas Furnaces are ideal for this sized building. ☆ For jobs large or small, *Payneheat* tops them all.

PAYNEHEAT *Payne* FURNACE & SUPPLY CO., INC.

BEVERLY HILLS • CALIFORNIA



MUSIC CORPORATION OF AMERICA BUILDING, BEVERLY HILLS

PAUL R. WILLIAMS, ARCHITECT

Photo by Maynard L. Park



PROPOSED PROFESSIONAL BUILDING, LOS ANGELES

RECENT WORK OF PAUL R. WILLIAMS, ARCHITECT

By ANITA MORRIS

MODERN architecture today is divided into two groups; Contemporary—in which the architect uses the period styles as a foundation for proportion in combination with functional planning; Modern—wherein the architect just wants to create something which is different, mixes it with color and calls it modern. Paul R. Williams is very definitely one of the former group, basing his contention upon the old formula that good architecture is still "the pleasing assemblage of parts and not the assembly of pleasing parts." Another approach to planning which he discussed with the writer was to forget the old formula for designing a home or industrial plant and plan it around the way we live and work today.

I was very much interested in Mr. Williams' architectural background, especially since both of his parents died before he was five years old. Fortunately he was raised by foster parents who were considerably concerned in his choice of profession. His spending money was earned by making watch fobs for stores located near schools and colleges. This side line developed to such an extent that an old barn was turned into a workshop with five students on the payroll and young Williams' architectural future seemed momentarily in jeopardy. However, the urge to be an architect soon overcame the desire to manufacture jewelry.

A course in architectural engineering at the University of Southern California and in a Beaux Arts Atelier was followed by intensive study in interior design, color harmony and rendering.

Mr. Williams' favorite story regarding his early office training relates how on his first job he was interested only in design and making sketches, but when leaving to take a position in a larger office his employer told him he would never develop into a successful architect because he was interested only in the artistic side of architecture, and that this embodied about one fourth of an architect's duties, citing as one of the most important phases of architectural

(Turn to Page 23)

ARROWHEAD SPRINGS HOTEL, SAN BERNARDINO



Wm. Simpson Co., Builders

LANDSCAPING NOT COMPLETED WHEN THIS VIEW OF HOTEL WAS TAKEN

COMBINING an interesting plan with architecture and color, was the formula used by the architects and decorator in creating the new Arrowhead Springs Hotel.

With eighteen hundred acres to work with there was no worry about side line restrictions or back yard ordinances which so often determine the plan of a city hotel. However, being spread over so much territory meant the entire project had to be developed as a separate community, providing adequate water storage and supply, sewage disposal plant and a careful analysis of the location of the various units so that they could be tied in with the utilities and still take advantage of the sun and view.



G. C. Hewitt Co., Painting Contractor

GARDEN FRONT

The exterior of the Arrowhead Springs Hotel is an adaptation of the Regency period, modified to fit the climate of Southern California with many outside porches and terraces for dining and lounging. With its white roof and warm, grey walls in which the shutter's architectural detail and iron work are carried out in white, one acquires something of the feeling of the type of architecture one would expect to see around Nassau. In carrying out the color scheme, Mr. Trout, the landscape architect, has selected deep shades of green and petunia

(Turn to Page 42)



CABANAS AT SWIMMING POOL

Paddock Engineering Co., builders of swimming pool



ARROWHEAD - 350 ROOMS - HOTEL
 200000 sq. ft. - San Bernardino Co. Calif.
 GORDON B. KAUFMANN
 & PAUL R. WILLIAMS
 ASSOCIATED ARCHITECTS
 EDWARD DE BEJANIAN - SCULPTOR
 LANDSCAPE ARCHITECT



ENTRANCE OFF PARKING AREA

Photo by Maynard Parker



DRESS SALON

PAUL WILLIAMS' WORK

(Continued from Page 19)

practice the preparation of working drawings, also knowledge of construction, engineering and detailing. So, on the very first day in the new office Mr. Williams informed the chief draftsman he was a working drawing man. He bluffed his way through fairly well that day, and at night took his drawing home and worked till day break. Reaching the office early the next morning, he displayed his work conspicuously and waited for the chief draftsman to drop over to his table. The chief draftsman appeared satisfied but astonished at the speed his new employee displayed. Thereafter young Williams was considered the fastest working drawing man in that office. Climax to the story is that this architect, in later years, was an applicant of Mr. Williams for a job.

He later was employed by a landscape architect where he received a three year rehearsal in town planning and how to synchronize the planning of house and garden. The next three years were spent in the office of Reginald D. Johnson, which, as Mr. Williams says, was really an eye opener because it was in this office that he received his first opportunity to work on a home costing over one hundred thousand dollars. From residential work his next jump was to acquire some experience in school and commercial work. Having heard that John C. Austin needed another designer, he knocked on his door and got a job. During the three years with Mr. Austin about thirty schools were designed and built, besides an occasional office building and church.

Upon opening his own office Mr. Williams was handed a \$90,000 residence commission by his former employer with the admonition "Let this be a starter for your new office." This was just about the time small house competitions were being released throughout the country and Mr. Williams won three in succession which resulted in classifying him as a residence specialist. These small houses eventually grew in size until one day a new client called on the phone for an appointment to discuss sketches for a new home. When Mr. Williams



ENTRANCE TO ELEVATOR LOBBY



MILLINERY SALON

RESIDENCE IN BEL-AIR, CALIFORNIA

PAUL R. WILLIAMS, ARCHITECT



RENDERING BY JAMISON



STABLES ON PRIVATE ESTATE, LOS ANGELES

Paul R. Williams, Architect

RESIDENCE OF WILLIAM PAYNE, SAN FRANCISCO

PAUL R. WILLIAMS, ARCHITECT



Photo by Roger Sturtevant

FRONT VIEW

A. F. Mattock Co., Builders

arrived for the appointment, to his surprise the new client was E. L. Cord who wanted to build a \$250,000 home. Mr. Cord proceeded to bombard his visitor with a barrage of questions, such as desirable sizes of rooms, location of stables, swimming pool, garage for 15 cars, how he could best orient the various rooms, what would be the cost of materials and finally when could he have some sketches. To the last request Mr. Williams answered that sketches would be ready the following evening. To Mr. Cord's amazement the next evening the complete sketches were ready. Two days later the rumor was around town that Mr. Williams had been selected as the architect because he had

completed sketches for a quarter of a million dollar house in twenty-four hours.

When I asked Mr. Williams how he happened to pull this fast one, he said, "I had read the day before how Cass Gilbert landed the Woolworth Building by drawing a sketch right in front of Mr. Woolworth while all the other architects, after discussing the requirements, wanted at least two weeks, so I wanted to see if I could work the same system."

The commission to design the Beverly Hills Store for Saks-Fifth Avenue has an interesting background. Mr. Williams was called to New York by Mr. Gimbel, president of Saks, who

(Turn to Page 42)

RESIDENCE OF DR. LEON G. CUENIN, SAN FRANCISCO



LEFT—STREET ELEVATION

BELOW—STAIRCASE

Paul R. Williams, Architect

Butler Sturtevant, Landscape Architect
Architect's Rendering—Page 41

A. F. Mattock Co., Builders

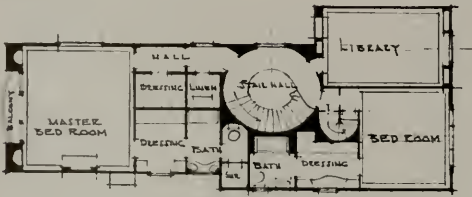

SECOND FLOOR PLAN



FIRST FLOOR PLAN

PLANS



Photos by Charlotte R. Sibi

ARCHITECT AND ENGINEER

RESIDENCE OF JAY PALEY, BEVERLY HILLS



GARDEN PORCH

Photo by Mott Studios

RESIDENCE OF JAY PALEY, BEVERLY HILLS



ENTRANCE DETAIL

Photo by Mott Studios

PAUL R. WILLIAMS, ARCHITECT



GARDEN PAVILION, RESIDENCE OF JAY PALEY, BEVERLY HILLS, CALIFORNIA

RESIDENCE OF DOCTOR VICTOR M. DILLON, S. F.
Paul R. Williams, Architect



Photo by Roger Sturtevant

DETAIL OF FRONT

A. F. Mattock Co., Builders

RESIDENCE OF LESLIE KELLEY, BEL-AIR

Paul R. Williams, Architect

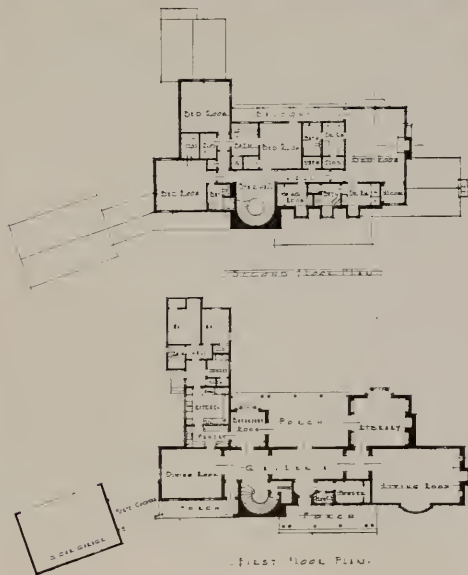

Photo by Mott Studios

ENTRANCE APPROACH



GARDEN VIEW AND PLANS



RESIDENCE OF GRACE MOORE, BRENTWOOD

Paul R. Williams, Architect



STAIR HALL

Photo by Maynard Parker

RESIDENCE OF TYRONE POWER, BRENTWOOD

Paul R. Williams, Architect



GARDEN VIEW

Photo by Maynard Parker

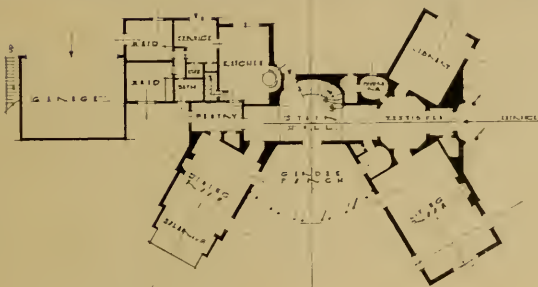

PLAN OF FIRST FLOOR

HOUSE OF TYRONE POWER, BRENTWOOD

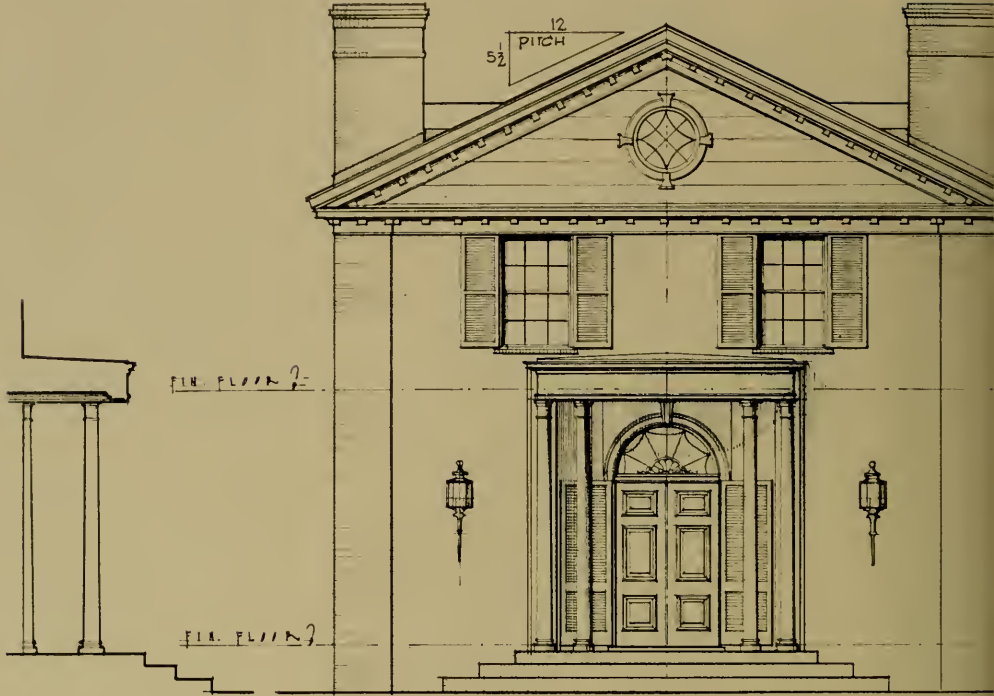

ELEVATION OF ENTRANCE FACADE

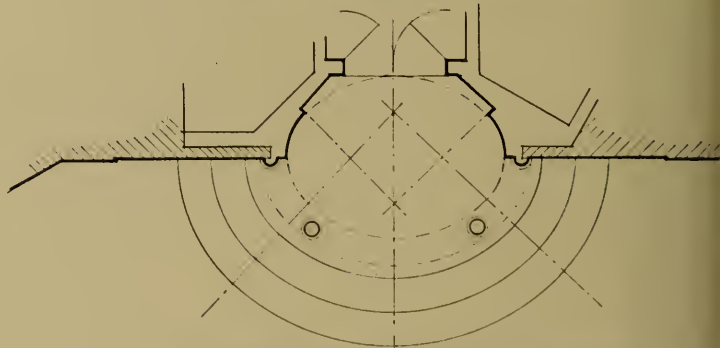

PLAN OF ENTRANCE FACADE



ENTRANCE DETAIL

Photo by Maynard Parker

MUSIC CORPORATION OF AMERICA, BEVERLY HILLS

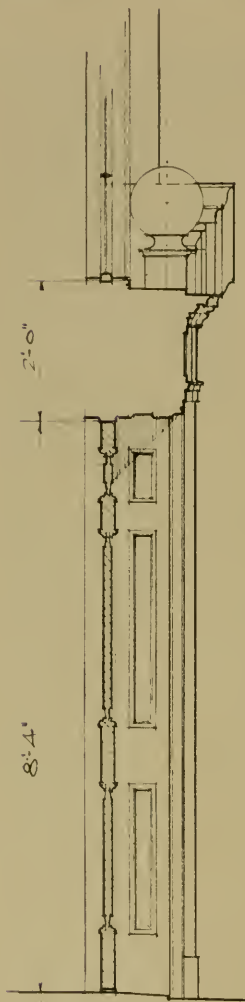

2'-0"

8'-4"



SECTION

ELEVATION OF MAIN ENTRANCE

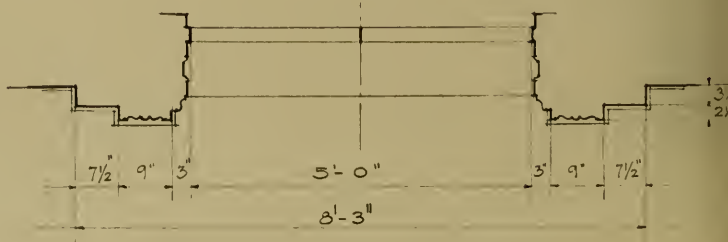

7 1/2" 9" 3' 5'-0" 3' 9" 7 1/2"

8'-3"

PLAN OF ENTRANCE



Photo by Maynard Parker

FRONT FACADE AND ENTRANCE DETAIL

SETH HART RESIDENCE, BEVERLY HILLS

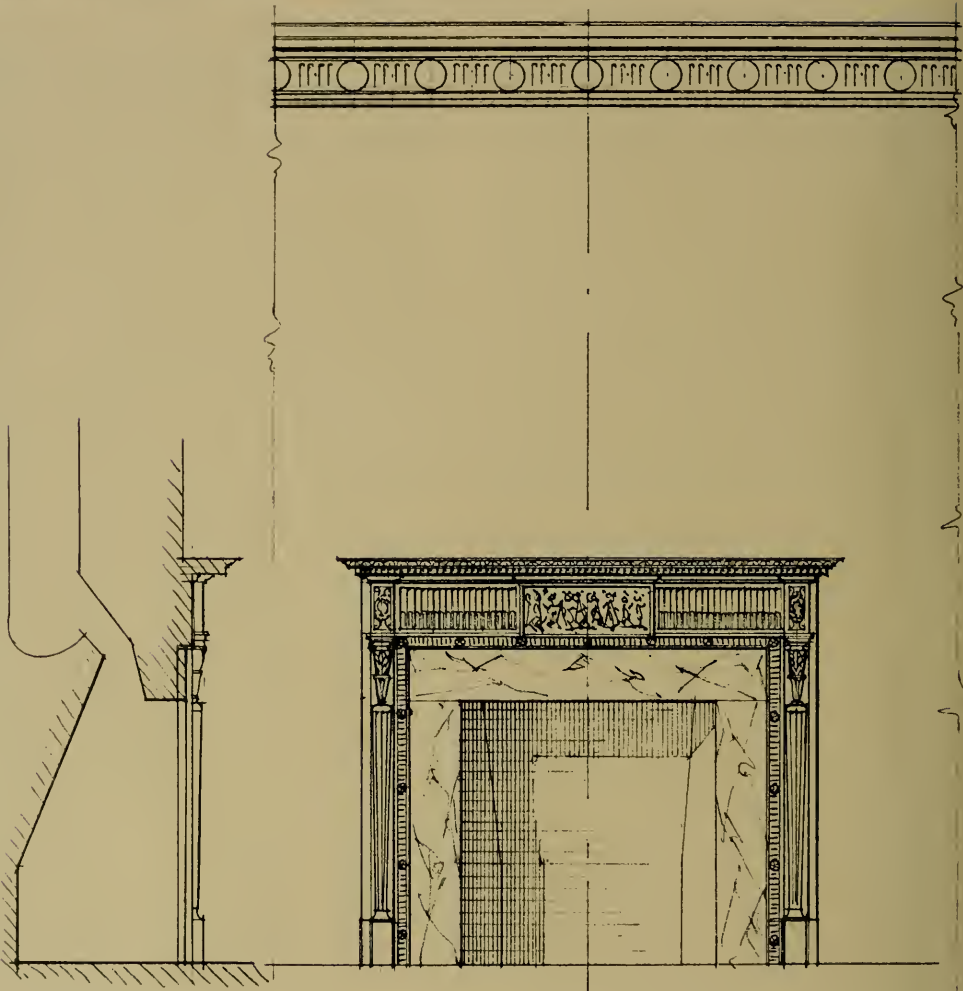

SECTION

ELEVATION

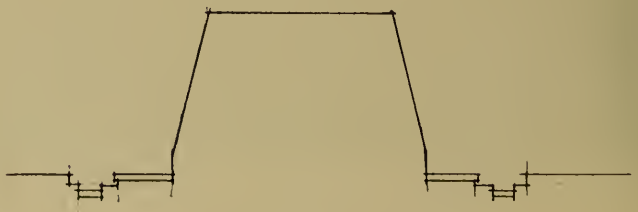

PLAN

MANTELL DETAIL

SCALE 3/4" = 1'-0"



CORNER OF LIBRARY AND FIREPLACE

SETH HART RESIDENCE. BEVERLY HILLS



Photo by Mott Studios

BED ROOM



BED ROOM SKETCH



RESIDENCE FOR DR. LEON G. CUENIN, SAN FRANCISCO
(Other pictures on Page 26)

PAUL WILLIAMS' WORK

(Continued from Page 25)

explained that they were contemplating a new store in the west, and because of their type of merchandise, did not wish to use a commercial architect. And, since they wanted this store to express the warmth of a fine home, they decided to call in a residential architect. As Mr. Gimbel explained, "We want you to design the background and color scheme and we will tell you how we wish to sell our merchandise."

In developing the sketches Mr. Williams made a survey of several of the major stores, making notations, principally of the various items of merchandise in these stores. The result of this research is definitely shown in the lighting and display fixtures and blending of the background colors.

Six years ago ninety per cent of Mr. Williams' work was residential. Today this percentage has changed to forty per cent residential and sixty per cent commercial.

When I asked him the reason for this trend his answer was quite logical. Having designed so many homes in the brackets above \$25,000 it meant that later these clients would be interested in some type of commercial enterprise in which event the architect to get the first call would usually be the one whom the owner had worked with on his home. The other reason has been the Saks achievement, which started out as a three-story unit and is now being planned for a third addition.

Another building in which Mr. Williams has used his residential background is expressed in the structure designed for the Music Corporation of America. In this structure the entrance lobby and all of the private offices are designed and furnished just as though they were sitting rooms or a library in a fine home. While the main building is designed in the 18th Century manner, it also contains a radio broadcasting studio which is quite modern and yet seems to be at home in its Georgian environment.

To review some of the clients for whom Mr. Williams has built is like reading a page from the Blue Book of Hollywood. The list includes such well-known celebrities as Will Hays, Joe

Schenck, Grace Moore, Charles Correll ("Andy" of Amos 'n' Andy), Tyrone Power, Dick Arlen, Leon Errol, Sally Eilers, Jay Paley, Zasu Pitts, Bill Robinson and many of the motion picture executives.

Mr. Williams' office is in Los Angeles, but he also maintains an office in Washington, D. C., where he is associate architect on two large government buildings and, in addition to these, his Los Angeles office is just starting the preparation of plans for a palatial residence in South America and one in Oregon.

ARROWHEAD HOTEL

(Continued from Page 20)

pink which emphasize the grey walls, forming a very pleasing picture against the dark green mountains which surround the hotel upon three sides.

The hotel is planned so that in approaching the main entrance you are facing the mountains and not until you enter do you see the marvelous view of the San Bernardino valley stretching out for miles, 2000 feet below.

The interiors show the definite influence of Dorothy Draper, the New York decorator, especially in the profuse use of color and the large scale used in the furnishings. The walls of the entrance and lobby are of bleached oak flexwood and the exposed columns are black lacquer; the floor is of black and white linoleum tile in which only the border is exposed, the balance of the floor being covered with a beige color hand-tufted rug. The furniture is also a beige color matching the walls with incidental pieces in black lacquer.

The dining room, while planned as three separate rooms in the event of large crowds can be used as one room. The wall opposite the garden terraces has been treated almost entirely in mirrors so that everyone seated has a full view of the garden. The main dining room walls are white with green doors and shutters, the carpet is also green with large pink cabbage roses which match the chair coverings. At the end of the main room is a semicircular garden room, again featuring the pink rose combination with a black and white floor.

The bedrooms offered a problem in planning as it was thought necessary to locate as

(Turn to Page 45)



EMERSON JUNIOR HIGH SCHOOL, LOS ANGELES
Richard J. Neutra, Architect

NEW SCHOOL UNIT FILLS TODAY'S EDUCATIONAL NEEDS

By PAUL E. GUSTAFSON

THE Ralph Waldo Emerson Junior High School in West Los Angeles represents an interesting example of an attempt to plan a school structure with modern educational purposes in mind. Designed by Richard J. Neutra, some of the many features introduced in the building include:

Abundant fenestration to allow uniformity in distribution of light in the class rooms as well as lobbies and corridors. This is controlled by Venetian blinds which have been installed throughout the entire building in class rooms as well as corridor entrances and stairways.

Commodious class rooms to allow freedom of activity on the part of pupils in planning and executing projects and dramatizations involved in class work.

Sliding class room walls and doors opening from ground floor class rooms to permit of pupil activity in patios adjacent to the class rooms. These devices double the working area ordinarily available to class work and at the same time allow for supervision by the class room teacher.

The library and textbook rooms have been located on the same floor in adjoining rooms,

EMERSON JUNIOR HIGH SCHOOL, LOS ANGELES



RALPH WALDO EMERSON JUNIOR
HIGH SCHOOL, LOS ANGELES

Upper picture—View of Auditorium, seating approximately 900.

Lower photograph shows Entrance to Administration Building, containing 26 rooms.

Illustrations courtesy Southwest Builder and Contractor

to permit general supervision of both distribution by the librarian and her staff. This arrangement allows for a constant flow of reading and illustrative materials to the various class rooms supplementary shelves which have been installed as permanent equipment. This makes possible a decentralization of library service and a more intensive use of needed books by a larger number of pupils.

The traditional blackboards have been replaced in large part by cork boards, allowing for frequent and more general posting of illustrative materials and pupil projects.

Electrical outlets have been installed in class room walls offering facilities for the use of radio and motion pictures.

The main corridor on the lower floor of the building has been staggered at the entrance lobby to allow greater freedom of movement on the part of large numbers of pupils; at the same time giving interest and character to floor design otherwise conventional and institutional in effect.

The stairways, divided to control traffic, and well lighted with tall windows reaching to the top of the second floor ceiling, offer inviting passage between floors.

The library, though located on one side of the upper floor, is lighted from two sides, the corridor side having access to light through a tier of transom windows above the roof level of the adjoining corridor.

The second floor also offers a number of rooms for conference purposes, smaller in dimension than the regular class rooms, with lower ceilings. Rest rooms are also provided, along with the conference rooms, giving adequate accommodations for teachers and others to assemble for conferences and relaxation.

The administrative and student body offices are located on the first floor in a suite of adjoining rooms. An inside corridor admits of ready access to all offices including those of the principal and vice-principals, the counselor and attendance office, and a utility room for conference and testing purposes.

Pupil work rooms adjoining the regular class rooms permit storage for supplies, and provide

RICHARD J. NEUTRA. ARCHITECT

space for activity involving use of specialized materials, particularly those needed in the development of large projects.

The art rooms form a T at one end of the building, and are arranged to receive northern lighting. These rooms form a one-story addition of the main two-floor structure. Its roof is surfaced with a grided flooring so that groups of pupils may assemble thereon for various types of class activity.

Many of the class rooms are equipped with movable tables and chairs, offering flexibility in arrangement, and freedom in adjusting to many of the informal practices prevalent in the class room procedure.

Artificial lighting fixtures in the corridors are recessed to conform to the simplicity of the line which characterizes both the interior and exterior of the building.

The landscaping surrounding the buildings calls for plantings of trees and hedges bordering the class rooms, designed to lend not only utility but beauty as well, to the immediate school environment.

From the foregoing it is evident that Mr. Neutra had in mind, definitely, the planning of a school building designed to meet educational needs.

ARROWHEAD SPRINGS HOTEL

(Continued from Page 42)

many rooms as possible on the sunny side which was accomplished by the angular plan. Fifty per cent of the bedrooms open onto private balconies and due to the angular plan it is impossible for occupants on one deck to see occupants on the adjoining deck.

Nestled snugly in between low rolling hills and located about 600 feet from the main hotel lies the swimming pool and recreation center for the guests. Here again the atmosphere of Nassau is carried out with the bright colored roofs of the cabanas, palms and pavilions.

Surrounding the hotel, sites have been planned and several bungalows have been built for individuals, all of which form an integral part of the landscape scheme, together with the stables for riding horses, and the golf course which is located in the valley below.



RALPH WALDO EMERSON JUNIOR HIGH SCHOOL, LOS ANGELES

Upper—General view of Administration Building with Auditorium in distance.

Below—Class Room Entrances connecting Inner Courts. All buildings are of structural steel and reinforced concrete.

THE ARCHITECT: FORGOTTEN MAN?

By WILLIAM A. DELANO, A. I. A.

Widespread debate over public housing and buildings, the employment of architects, etc., has aroused new interest in architecture, as indicated in the following article by William A. Delano, A.I.A., in a recent number of the New York Times magazine. Delano deals with architecture as an art and raises the question whether the architect, as compared with other creative artists, receives the recognition he deserves.

BUILDING is a business. Architecture is an art. From remote time architecture has been justly called "The Mother of the Arts." Painting and sculpture have been her handmaidens. The works of architecture of the past and present give the most complete and enduring record of the social, religious and economic conditions of civilization. Men have employed this art to aggrandize themselves, to perpetuate their fame, to render homage to their gods and by giving buildings for public use, to carry favor with the people.

Of all the arts, architecture is the one that has given the greatest emotional thrill to the greatest number of people, yet it is the least understood. Men have stood in awe and amazement before the monuments of Egypt and Asia, before the temples of Greece and Rome, before the cathedrals of Europe and before many of the great buildings of our own continent; yet they seldom ask who the authors were or how the buildings came into being. They assume that these buildings, like babies, were dropped by the stork. The great names in architecture—the Palladios, the Mansards, the Christopher Wrens, the Bullfinches, to name only a few—are hardly known to the general public, while the names of painters and

sculptors like Leonardo, Raphael, Titian, Velasquez, Michelangelo, who have left their record on the walls of buildings, on canvas or in marble, are known to almost every school child. Why should this be?

It is comparatively easy, by means of engraving, photography and plaster casts, to give a fairly accurate reproduction of a painting or a work of sculpture, but it is almost impossible by any method to reproduce adequately a work of architecture, for a building must be seen in its three dimensions to be understood and appreciated; one must explore its interior to know how well it fulfills the purpose for which it was built. A photograph or an engraving gives at best an inadequate impression. Therefore, while the walls of museums and schools may be lined with the reproductions or original works of painters and sculptors, only a privileged few can visit the great works of architecture outside their own town or country.

Moreover, architecture seems to lack the personal touch of a painting or work of sculpture. This is a misconception. A great building is as truly the creation of one mind as any other work of art in spite of the fact that many hands may have been employed in its erection: like a symphony which requires for its performance an orchestra of sixty or seventy pieces to render it a reality to the audience, it is the work of an individual imagination. To the ordinary man it is almost a work of magic to put on canvas or in bronze something that looks like the original model, but to pile one stone upon another is a commonplace accomplishment.

Furthermore, there is the daily intimate contact of every one with the elements that make up a building. The walls, floors, doors, windows,

stairs, etc., are as familiar as the food men eat or the clothes they wear. It appears to them, therefore, that a building is nothing more than a combination of these familiar objects—a combination that they themselves might make if they had the time or inclination. If they think of architecture at all as an art, it seems only a window-dressing that is put on these familiar objects. The public needs education.

Since men first left their tree-tops and caves there has been a great deal of building; only a small fraction of it can properly be called architecture. Architecture is more than four walls and a roof, a shelter from the elements. It implies intent in planning, imagination and an emotional quality—let us call it—which only the trained artist can inspire. No great work of art can be created without this quality: reasoning and logic alone cannot produce it. In the minds of the cultured the cathedral architecture of France has always stood as the high-water mark of reasoned construction, but it is its emotional quality, not its logic, that makes appeal to the general public.

To draw a distinction, therefore, between building and architecture is not easy—it is a difference that can be felt rather than described—so when architects ask that this distinction be recognized and credit given to the architect for some outstanding achievement, they are asking much but no more than the accomplishment deserves. Perhaps if we could make plain what is expected of that anomalous creature, the architect, we might light the way to a greater appreciation of his efforts.

It is the object of all arts to create an emotion. If the artist attempts to create this emotion as an actor, an orator or musician, he receives—for better or for worse—an immediate response from the audience, but if he practices one of the static arts—architecture, painting or sculpture—recognition of what he has created comes to him indirectly and belatedly. Today, with the newspapers and the radio, this indirect recognition has become well-nigh universal for all the arts save architecture. Compared to the painter and sculptor, the musician or the actor, the architect has limited palette; he has to create emotion, out

of such vague qualities as mass, line, proportion and color.

Because architecture embraces so many activities other than pure design there is an understandable confusion in the public mind. A great architect must be a designer, engineer, business man and diplomat—but first of all a designer. By that is meant one who has vision and imagination enough to combine, in the most serviceable manner, all the units desired by his client; to make these many units into a useful and workable whole and at the same time arrange them so that within and without the building is an agreeable object to look at. To make it function well, "A Machine for Living," as the Advanced School likes to say, is not enough, nor merely to make it pleasant to look upon.

A great building, not necessarily of great size, must be a combination of serviceability and beauty. An architect must be skilled enough as an engineer to understand the principles of construction and to know how and why the strains and stresses in the various parts of his building resist the law of gravity. He must be a business man able to safeguard his client's interests and see that his money is both wisely and economically spent, and he must have the tact of a diplomat to persuade his client and those who work with him to carry out his conception of what the finished structure should be, for to complete the design for a complicated modern building he must employ and coordinate the work of engineers, structural and mechanical, specialists of all kinds, as well as the builder. He must see that one does not interfere with the other nor any one of them detract from his conception of the completed building.

All this requires a close supervision of detail as well as of the general mass. From the first thumbnail sketches until he puts the final touches upon his building, the architect is the nerve center, the moving innerspring force. He cannot work in remote seclusion like the painter and sculptor and turn over to the public, as they do, the finished product. The public sees the result of his work during the process of its erection, but none of the creative thought be-

hind it. No wonder there is confusion in the public mind.

Today this confusion is worse confounded by the civil war now waged in all the arts, architecture included. In this war, the Advanced School, which has thrown aside precedents and what heretofore have been considered artistic canons, is pitted against the more conservative. The latter stamp these iconoclasts as revolutionists, which in fact they are if one takes a short view, but every revolution, if considered in the broad perspective of history, is but one more step in a forward or backward evolution, depending upon the point of view of the historian. As always, the revolutionist is much more vocal than the conservative. What he has to say is new and, therefore, news. Today he is using all the implements of modern warfare—propaganda and surprise attack—to win the fight.

Along the entire battlefield nowhere is the struggle hotter than among the architects. Reports from the front are printed almost daily in the art columns of the press from painters and sculptors, from every sector save that held by the architects. There, there seems to be an almost complete "blackout." In most newspapers, in the real estate sections, to be sure, a building is occasionally mentioned and illustrated, though its artistic worth is never discussed. The names of the real estate operator, the promoter and the photographer are given but rarely the name of the architect whose creation it is.

Even the Federal Government which today lays so much stress on what it is doing to bring art before the public, publishes a volume of over 600 views of buildings—postoffices, court houses, schools, etc.—erected from public funds (derived, be it said, from taxes to which even the architects are compelled to contribute) and yet there is no single mention in this volume of any architect whose skill designed these buildings. The majority of them are admirably designed, some conspicuously so; they represent both the Traditional and Advanced School; but once again the reader is led to believe that these monuments have sprung into being by spontaneous construction. This could

not have happened in any country that lays claim to a native culture, for in all such countries architecture is recognized as an art and the recognition of the artist widely distributed.

Every now and then something is created by an architect of such civic importance that it stands out from the general run of apartment houses and commercial buildings. As an artist's achievement, should it not be noted in the art columns of the press and appraised, as paintings are, in the measure of its merit?

Future generations will not appraise our present-day culture by the paintings and detached works of sculpture but by the buildings that contain them—the museums, schools, hospitals, skyscrapers, power plants, etc., that represent the trend of our day as the church architecture of the Middle Ages represents that period or the palaces and chateaux of royalty and the aristocracy represent the age of feudalism and concentrated political power.

If our papers were to emphasize this contribution to the public and if critical discussion of how well or how badly a new building serves the purpose for which it was erected became a more general practice, the chances are that the man in the street would grow conscious of "The Mother of the Arts."

Architects, like other artists, are temperamental individualists to whom recognition of their accomplishments means as much as or more than financial reward and, with a few conspicuous exceptions, are modest men who hate to employ press agents and shun the advice of W. S. Gilbert:

If you wish in the world to advance
And your credit you wish to enhance
You must stir it and stomp it
And blow your own trumpet
Or, believe me, you haven't a chance.

If the achievements of the architects received in our widely read publications the same discussion and recognition that are given to painting or sculpture—a recognition they richly deserve—it would be an immense stimulus to the culture of the present day. A eulogistic obituary gives no encouragement or satisfaction to a dead architect.

ELECTRIC FIXTURE INDUSTRY IN NEED OF NEW IDEAS

Critic Urges Application of Modern Design to Replace Antique Forms

AS architects build for function so should design lighting equipment for function. Modern concealed light sources should supplant portables which belong to the obsolete class. In a frank rigorous discussion of the domestic lighting situation, Mary Davis Gillies of McCall's magazine places responsibility on our decorators, designers and architects for the little if any progress made in the development of indoor illumination in recent years. Decoratively speaking, Miss Gillies says, we are still living back in the 18th and 19th centuries.

Quoting from Miss Gillies talk we are advised that:

"All the decorative lamp market can talk about today is Early American, Georgian, Regency, and 19th Century—otherwise known as the 'Gone With the Wind' trend—with a little Bronx, or shall we say Germantown Renaissance, thrown in. Frankly, it would take not a wind but a tornado to clear the market of the incongruities which deliver light into our homes today.

"As we well know, one of the most remarkable things about electricity is its fluidity, flexibility and availability. Today it is no problem at all to deliver 50 or even 150 foot candles of pleasant, usable light but because of the perverseness of the human animal this beautiful light is camouflaged. An oil lamp is made to appear as the source!

"We have tortured electric light for so long in this way that we are becoming blinded to its possibilities. We are so ready to think in the conventional terms of ceiling fixtures, portables and wall brackets that we forget that there is practically no limit to electricity.

"When architecture, interior design and public acceptance catch up with engineering developments, we may expect improvements in the methods by which light is delivered to us.

"Probably real advances in lighting will be only as rapid as the general application of modern design to domestic dwellings. Inevitably the public will realize the witlessness of reproducing antique forms today. The consumer will

see the artistic suicide which results from reproducing designs by machine which were originally conceived as hand-made products. Without question, the public eventually will gain the courage of its convictions and will turn to modern design. Do you realize that in the whole history of design there has never been such a copy cat period as the 20th Century? Certainly in time we will gain confidence and turn to designs expressive of our own day. When that time comes electric lighting will gain new prestige.

"Notwithstanding the fact that portables are the most important form of illumination today, they are less pleasing in design than almost any other accessory going into the home.

"For some time now I have been concentrating on low priced rooms, developed on budgets attainable by the upper middle class. The groups which we identify not as "prosperous" but as those who are "comfortable" and "just getting by." Terms which aptly describe the largest groups in this country.

"Five dollars per lamp is the maximum price which should be spent by this group and three dollars would be a more acceptable figure when you consider that four to five lamps for every living room are desirable.

Just try and find table lamps which are good-looking, a minimum of 24 inches over all, with an I. E. S. reflector bowl for that price. I've tramped the streets of New York trying to find them. As much as I am embarrassed to admit it, I find that I can best the price game most successfully by having a 35c jug or water bottle that is large and good in shape wired. I then add a textolite reflector bowl and have a decent lamp of large size for \$3.00.

"I'm not the only one who feels thus critical of available decorative lamps. The Modern Museum of Art had an exhibit of decorative accessories costing not over \$10.00 a few months ago. Everything was represented but lamps. They couldn't find any that were acceptable. There was some criticism in the trade about the Museum stand on the matter but

my opinion agrees with the Museum 100 per cent.

"True there probably is not enough consumer pressure at the moment to force a change. Manufacturers show me the worst-looking lamp in their line—all onyx, gilt and curlicues. I object. Up go the hands and 'But it sells!' is the cry.

"Sometimes I think such purchases are made out of desperation. Women who are not quite sure of their taste buy what is available. They haven't the courage to hold out for what they want. I honestly believe if they were shown good simple light-giving lamps at a figure within their price range, they would buy them. In fact, I'm willing to bet that the worm will turn. If you want evidence look at mail-order catalogues. You will be surprised at the improved design in home furnishings classifications during the last two years.

"Again, I would like to reaffirm that practically all lamps are too narrow, too small at the base, as well as too low. In my mind light sources should have a sense of size and opulence. Dinky light sources are inconsistent with the service rendered.

"So until the time when built-in illumination is common practice, the best we can hope to do is to improve lamp design. While we are doing that we might also give a thought to the fixture manufacturers who, I notice, have organized themselves into an association. No doubt with the idea of perpetuating themselves.

"They are pursuing the right course. Their first action as a group has been the creation of a Board of Design to be composed of: Two interior designers, two architects and one industrial designer. It is hoped that the manufacturers will listen to this group. That as a result of it at least 95 per cent of existing lines will be turned into scrap metal and that some simple ceiling lights and wall reflectors will be devised which will help tide us over to the day when illumination is approached primarily from the standpoint of function."

CONCRETE UNDER STARS

Researches in the plastic flow of concrete are contributing to the safer design of concrete structures, according to a report to the Engineering Foundation, which is sponsoring a testing program at the University of California.

"The results have led to new conceptions of the behavior of concrete under the action of stress and to important modifications of practice, both in design and construction," it is declared by Professor Raymond E. Davis, who is directing the work.

"As building materials go, concrete in its present form is a fairly new product. Such success as had been attained in the scientific control of concrete is due largely to the efforts of research-minded engineers who have sought to improve its qualities. Better proportioned, stronger, and more durable concrete structures, today as compared with yesterday, tomorrow as compared with today, are and will be the result of carefully planned research on some of the lesser understood properties of concrete.

"The improvement of the materials of construction with which man has had to deal has come about by a gradual process. This process has sometimes involved the bitter experience of failure; but, for the most part, the patient accumulation of a systematic body knowledge with the development of more accurate and dependable information as to the properties of our materials of construction has greatly increased our efficiency in their use."

In the field of reinforced concrete design, Professor Davis explains, new formulas for the construction of concrete columns take into consideration the effects of plastic flow, which is the deformation or gradual yielding caused by the continual application of heavy loads.

These new formulas are based on the ultimate strength of the concrete, which is measured by crushing a standard six by twelve inch cylinder after it has been allowed to harden for twenty-eight days, and on the yield point of steel. The latter is the unit load at which a steel bar will continue to "stretch" without increase of load.

"A property which influences the behavior of concrete under almost any condition of service is plastic flow," Professor Davis says. "The distribution of stresses due to applied loads, now only approximated by our ordinary formulas, is often to a considerable degree affected by plastic flow.

"The thermal stresses in mass concrete, generally disregarded in the analysis of dams, may be fully as important as stresses due to gravity loads and are to an appreciable extent influenced by plastic flow. The importance of plastic flow in connection with the cracking of concrete, whether the cracking is due to thermal stresses or stresses caused by drying shrinkage, is now generally recognized."



FENESTRA PACKAGE WINDOW AS IT APPEARS IN A MODEST-PRICED DWELLING

FIRST PREFABRICATED STEEL WINDOW UNIT

ONE of the important new-product developments of the year is the Fenestra Package Window—produced in the plants of Detroit Steel Products Company, makers of Fenestra steel casements.

The manufacturer reports that the new unit is the first completely prefabricated steel window unit ever devised, and when delivered to the building job is completely equipped with glass, cased with genuine California redwood, and all bronze-finish operating hardware already attached, and interior wood trim cut and fitted ready to be nailed into place by a carpenter.

The Package Window is the result of several years of research and development and is engineered particularly for the low-cost frame dwelling, although entirely adaptable for brick veneer homes also.

According to the manufacturer, the new Fenestra Package Window is low-priced—lower in price and more complete than a steel window ever before has been sold and quicker and easier to install. Furthermore, it eliminates the necessity of having the builder go back to the job to refit or rehang windows—an annoyance to both builder and owner.

It is described as having slender, graceful lines of steel, which lend added beauty to the small home, both inside and out. The air-deflector ventilator admits breezes from several directions, rather than only one. Since all moving parts are of steel, the windows are always easy to open and close—for steel does not warp, shrink, swell or stick. Being precision-fitted at the



INSIDE VIEW OF WINDOW AFTER PRE-FITTED INSIDE TRIM IS ATTACHED



USING ONLY HAMMER AND NAILS, ANY CARPENTER CAN INSTALL THIS WINDOW IN LESS THAN FIVE MINUTES

factory, the window stays weather-tight. There are eight standard sizes of the Package Window.

Fenestra's redwood casing fits ordinary wood stud wall construction, allowing three-quarters of an inch on the outside for sheathing and three-quarters of an inch on the inside for plaster, insulating board, etc. This permits its use in brick veneer, or in frame houses with shingle, clapboard or other types of siding.

WILLIAM GRANT FOSTER

William Grant Foster, architect, of 34 Avon Road, Berkeley, died suddenly while on a visit to his former home in Armstrong, Ill., April 28.

Mr. Foster was a graduate of the University of Illinois, and practiced for many years in Streator, Illinois, before coming to the west coast in 1925. In California he specialized in home design and building, some of his recent houses in redwood construction including the Erle Loran residence at 10 Kenilworth Court in Berkeley; the R. F. Cleary residence at Hayes and Washington Streets, Albany; and the John E. Fairfield residence in Richmond Annex.

He was for many years of his Illinois practice a member of the Illinois Society of Architects, serving on several boards and committees dealing with minimum building requirements, etc.

Surviving are Mrs. Foster and four children, Mrs. Glenn Wessels (Kathryn Foster), Mrs. D. A. Rodecape (Lois Foster) and Stanton and Willis Foster, all of Berkeley, and three brothers, Stanton, Edward and Theodore Foster of Illinois.

BOOK REVIEWS

PORTLAND CEMENT: By Richard K. Meade; Chemical Publishing Co., 148 Lafayette St., New York. Price: \$10.00.

A complete treatise on Portland Cement; its composition, raw materials, testing and analysis, of special interest and value to engineers, contractors, chemists and those engaged in the inspection and testing of concrete.

STANDARD CHEMICAL AND TECHNICAL DICTIONARY: By H. Bennett; Chemical Publishing Co., 148 Lafayette St., New York. Price: \$10.00.

One of the finest and most modern of technical dictionaries. There are over 25,000 definitions, covering the latest advances in chemistry and technology. A standard system of alphabetizing has been used and the symbols arranged for easy and rapid cross reference. The book is guaranteed by its publishers to be accurate, practical to use.

ARCHITECTURAL SPECIFICATIONS: By Harold Reeve Sleeper, A.I.A.; John Wiley and Sons Co., 440 Fourth Avenue, New York. Price: \$10.00.

This book is a companion volume to *Architectural Graphic Standards*, by Ramsey and Sleeper. It contains all the data relative to specifications with model work, cost sheets and other important information. It is one of the most complete volumes we have seen and though it is a little too large to be taken on the job, on the estimator's or specification writer's desk as a standard reference book it should be of great value.

WALL SHRUBS AND HARDY CLIMBERS: By W. J. Bean, Macmillan Company, New York, N. Y. Price: \$3.00.

This is a practical and distinguished book for the professional as well as the amateur gardener. The chief factors that contribute to the successful growth of members of the shrub and climber family—climate, soil, pruning and support—are here thoroughly summarized.

There is an encyclopaedic list of the genera of all climbers and wall shrubs and a description of shape, appearance and habits of each species.

An exhaustive and authoritative volume for gardeners.

METAL COLORING AND FINISHING: By Hugo Krause; Chemical Publishing Co., 148 Lafayette Street, New York, N. Y. Price: \$5.00.

Tells all the methods for coloring metals and alloys. How to prepare metal surfaces for coloring; how to finish colored metals.

THE NATIONAL PAINT DICTIONARY: By Jeffrey R. Stewart; Chemical Publishing Co., New York, N. Y. Price: \$5.00.

An excellent reference book. Especially useful for production managers, chemists, salesmen and distributors.

ARCHITECTS' BULLETIN

Issued For

THE STATE ASSOCIATION OF CALIFORNIA ARCHITECTS

Northern Section

STATE ASSOCIATION MEMBER
OF THE
AMERICAN INSTITUTE OF ARCHITECTS

Editor
Harris C. Allen

Address all communications for publication
in the Bulletin to the Editor (Harris C.
Allen) 557 Market Street, Room 218, San
Francisco, California.

STATE ASSOCIATION OFFICERS

President.....Ernest E. Weihe, San Francisco
Vice-Pres.....Merrill W. Baird, Glendale
Secretary.....Robert H. Orr, Los Angeles
Treasurer.....Mario Ciampi, San Francisco

Regional Director—Southern Section

Gordon B. Kaufmann, Los Angeles

Regional Director—Northern Section

Harry M. Michelsen, San Francisco

Executive Board—Northern Section

Officers

President.....Ernest E. Weihe, San Francisco
Vice-Pres.....Frederick H. Reimers, San Francisco
Secretary.....Vincent Raney, San Francisco
Treasurer.....Mario Ciampi, San Francisco

Directors

Harold H. Weeks and Wayne Hertzka
(for one year)

Harry J. Devine and William C. Ambrose

Executive Board—Southern Section

Officers

President.....Merrill W. Baird, Glendale
Vice-Pres.....Winsor Soule, Santa Barbara
Secretary.....Robert H. Orr, Los Angeles
Treasurer.....Sylvanus B. Marston, Los Angeles

Directors

A. M. Edelman, George D. Riddle
(for one year)

Sam W. Hammill and Ben H. O'Connor
(for two years)

Northern Section Advisory Council

San Francisco District:

Frederick H. Reimers (President)

J. K. Ballantine, Jr. (Secretary)

Harris C. Allen

Dodge A. Riedy

Ernest E. Weihe

Mario J. Ciampi

Conrad T. Kett

Roland I. Stringham

Wm. H. Knowles

Vincent Raney

North Bay:

J. C. Felciano

Lower San Joaquin:

H. G. Bissell

Santa Clara:

Chester Root

San Mateo:

Clyde Trudell

Upper Sacramento:

Casebolt Dakin

Sacramento:

Alfred Eichler

Upper San Joaquin:

David Horn

Monterey Bay:

Robert Stanton

Palo Alto:

Birge M. Clark

Marin:

Jas Bertenshaw

East Bay:

Irwin Johnson

Jas. H. Anderson

Ralph N. Kerr

Berkeley:

Gwynn Officer

Redwood Empire:

F. T. Georgeson

Lassen:

Ralph Taylor

Unification — A Reason

IN a recent national questionnaire by the Architectural Record, on the future of the architectural profession, one point was emphasized in analyzing the answers—88 per cent favored group effort, agreement and action, through professional association.

Here are excerpts from individual comments:

"Unification of architectural organizations, both local and national, would tend to create more widespread recognition and enable enforcement of laws governing practice."

"The profession will stumble along in its present groping way until architects pool their interests, ideas, and to a limited extent their finances, in a broad program of education of (1) architects, to fit them (more) efficiently to serve the public, and (2) the public, to acquaint it with the (necessary) leadership of the architect in the building industry."

"Group effort is the only hope if it includes the education of the architect as to his professional obligations."

"Architects can improve their economic position by (a) constantly endeavoring to improve the quality of service to their clients, (b) giving as careful attention to supervision and business relations as to design, and (c) taking a more active part in civic affairs—becoming better known in their communities."

"How to awaken the consciousness of need for publicity, and for considerable financial support (to securing publicity) in the average architect—has stumped me for fifteen years."

It must be obvious that only through a common association of all architects in one organization, close enough to represent the entire profession, and loose enough to permit separate local action, can the objectives be obtained that are voiced by this 88 per cent. And even then it will be a long, slow campaign in which outside activities must always be accompanied by steady progress within the profession—both in competent service, and in fair competition. No war is ever won by unprepared, undisciplined troops.

At last a start has been made toward the preparation of a Building Code for San Francisco, to replace the Joseph's Coat of patches and tatters that now attempts to protect the city's building skeletons from indecent exposure. Director of Works, Al Wilder, has appointed an advisory committee consisting of representatives from interested organizations (architects, engineers, contractors), to collaborate with city department heads in a preliminary study. It is expected that full use will be made of the "State Code" published by the California State Chamber of Commerce after ten years' careful and arduous research. Its systematic and thorough, logical and clear treatment of proper Code material should make

it an admirable guide in forming a satisfactory code for any city, large or small.

ARCHITECTURAL SCHOOL for Architects brought a large number of them to the "Ark" at the University of California on May 14th. A very complete and interesting display of student work was on view, and medals and prizes were awarded in the new brick-paved court. This sunny, sheltered spot is a welcome addition to the life of the Ark; its calm beauty is enhanced by a serene, small statue carved by Jacques Schnier of San Francisco, and presented to the school by Albert Bender of San Francisco, patron saint to young art in all its manifestations—guest of honor on this occasion.

And John Bakewell, chairman of the A.I.A. Committee on Education, presented the Institute Medal to the most distinguished graduate. But why, John, why, did you say that it was a pleasure to see the work of the young men—when you had just given that medal to a radiant girl—Miss Marriott? We must assume that you were guided by that good old generality of etymology, "Man embraces woman," and we must rejoice, "But surely not in an architectural school, Mr. Bakewell!"

SCHOOL SECRETARY Mr. Warren Perry, Head of the School of Architects at the University of California, announces that Mrs. Mardel Cathcart has been chosen as successor to Miss Bessie Sprague as secretary of the school. (Correcting a statement in this column last month, Miss Sprague's tenure of office at the University was not 32 years, but 35 years.)

Mrs. Cathcart will bring to her new post the wide experience and acquaintance gained through her position as secretary of the State Board of Architectural Examiners for the past eight years. Her loyalty to the profession, her understanding sympathy with ambitious young architectural students, is unquestioned. Architects old and young will approve the choice for this responsible position on the staff of the school.

CHAPTER ENJOYS VARSITY NIGHT

The annual "University Night" meeting of Northern California Chapter, A.I.A., was held at the University of California in Berkeley, Tuesday evening, May 14, President James H. Mitchell presiding.

Members present were: Messrs. Harris C. Allen, G. Frederic Ashley, John Bakewell, Jr., Arthur Brown, Jr., Will G. Corlett, John J. Donovan, Edward R. French, Jr., Andrew Hass, William C. Hays, Lester Hurd, Raymond W. Jeans, A. Lewis Koue, Chester H. Miller, Leffler B. Miller, James H. Mitchell, Howard Moise, Irving F. Morrow, Gwynn Officer, Edward B. Page, Warren C. Perry, Vincent G. Raney, Roland I. Stringham, Louis M. Upton, Harold H. Weeks, Winfield S.

Wellington, Alfred C. Williams, W. R. Yelland, John Davis Young.

Guests Present: Messrs. Albert Bender, Francis L. Chinn, Stafford Jory, Ralph N. Kerr, Walter E. Mooney, Ralph N. Pollach, Malcolm D. Reynolds, Clyde F. Trudell, and Messrs. Schneer, Stump and Torosian.

Mr. Mitchell introduced the guests, Albert Bender, donor of the statue in the new court on the university campus, Walter E. Mooney, whose application for associate membership has been received, Jack Schneer, sculptor of the courtyard figure, and Messrs. Jory, Stump, and Torosian of the faculty of the Architectural Department.

Mr. Mitchell spoke briefly of the opposition to the program of the San Francisco Housing Authority, describing the action of the emergency organization, the "Save the Housing Program." Members were asked to send in individual letters immediately, asking the Housing Authority to continue the program.

Mr. Donovan moved that the Chapter send a letter to the Housing Authority urging the adoption of Low Rent Housing. Seconded by Mr. Ashley, the motion was passed.

On the motion of Mr. Perry, seconded by Mr. Moise, the sum of twenty-five dollars was appropriated, to be sent at once to the "Save the Housing Program" organization for the campaign in behalf of the contemplated projects.

The meeting then adjourned to the Architectural Building, where the exercises of the Department of Architecture were held in the newly paved courtyard. Mr. Perry presented the school awards to the various students, and Mr. Bakewell, Chairman of the Institute Committee on Education, made the presentation of the Institute Medal award, referred to in Mr. Allen's report in the Architect's Bulletin.

After the ceremonies, opportunity was given to see the exhibit of student work. This was of unusually high caliber and excited many favorable comments. Outstanding among the exhibits was the work of the sons of several Chapter members. This was enthusiastically viewed and compliments were many.

ONE ON MARK DANIELS

Spokane, Wash.
May 28, 1940

Editor Architect and Engineer
San Francisco, California
Dear Sir:

On page 24 of the May issue you have named the incorrect source for your quotation. You have given credit to a Sister of St. Joseph for a statement whose authentic source is Proverbs 29:18. May we expect a correction in favor of the Bible?

Sincerely yours,

The Wife of an Architect.

With the Architects

N. B. C. BUILDING

The National Broadcasting Company has selected the northeast corner of Ellis and Taylor Streets, San Francisco, as the location for its proposed new building. Albert F. Roller of San Francisco, has been selected architect, and Barrett & Hilp have been named the contractors. Construction will go forward as soon as plans are completed. Estimated cost of the project is \$600,000. H. J. Brunner is the structural engineer.

U. C. ADMINISTRATION BUILDING

Plans have been completed in the office of Arthur Brown, Jr., 251 Kearny Street, San Francisco, for a new administration building for the University of California, to be built on Telegraph Avenue, near Sather Gate, Berkeley. Plans are now in the hands of contractors for bids. The improvements are estimated to cost \$850,000.

NEW STATE ARCHITECT

Appointment of a State Architect in California to succeed George McDougall who retired a couple of years ago, has finally been made. The successful appointee is Anson Boyd of Pasadena, a practicing architect in Southern California since 1923. Appointment was made under civil service. The office carries a salary of \$600 a month.

DOCTORS' OFFICE BUILDING

John K. Ballantine, Jr., 137 Harlan Place, San Francisco, has completed plans for five suites of offices for a group of East Bay physicians, the building to be a two-story brick structure, located at Ellsworth and Durant Streets, Berkeley. The cost is estimated at \$25,000.

SOUTHERN CALIFORNIA CHAPTER

The faculty of the Art Center School, Los Angeles, acted as hosts to the Southern California Chapter of the American Institute of Architects at the regular monthly meeting, Tuesday evening, May 14th. Dinner was served informally in the drafting room. The program which followed the dinner was most interesting.

The entertainment included a series of slides made by Harry Hartman, exposing Architectural Wrongdoings in and around Los Angeles. Kem Weber and Palmer Sabin led a discussion—half serious, half in fun—pointing out some L. A. architectural blunders. Movies made in New Zealand by one of Mr. Weber's students were shown, and also there was an exhibit of student projects on industrial and interior design.

PERSONAL

William J. Bain, vice-president; Robert F. McClelland, past president, Washington State Chapter, attended the recent A.I.A. Convention in Kentucky.

Paul Thiry, Seattle architect, active in the design of residences and school buildings, was recently retained as consulting architect by the Sand Point Country Club.

H. F. Claussen, member of the firm of Claussen and Claussen, Guardian Building, Portland, has been confined to his bed as a result of injuries suffered from a fall.

Edwin Peterson, Sherwood Building, Spokane, was recently awarded a limited commercial flying license at Felts Field.

Walter E. Kelley, who formerly maintained offices in the Artisans Building at Broadway and Oak St., Portland, has moved to Suite 405 Fitzpatrick Building, 917 S. W. Oak Street, Portland.

L. L. Dougan, 1326 S. W. Columbia Street, Portland, is in San Francisco, where he is receiving treatment for an optical disorder.

Clyde F. Trudell, architect, announces opening of an office for the practice of his profession at 251 Kearny Street, San Francisco. His phone number is Garfield 7255.

WINNER OF TACOMA P. O. COMPETITION

Truman E. Phillips, Pearson Fourth Avenue Building, Tacoma, is the winner in the sixth regional architectural competition for the proposed new Federal office building at Tacoma. Entries were received from architectural offices in Oregon, Washington, Montana, Idaho, Utah, Wyoming and Colorado. The jury of awards was composed of Ronald E. Coate, Los Angeles; Henry F. Hoit, Kansas City; and Alfred Shaw, Chicago.

The success of Mr. Phillips in submitting the winning design assures award of \$3000 prize money and his retainer as consultant for preparing plans and specifications of a three-story Class A building with provision being made for possible later addition of two more stories.

Honorable mention in the contests was awarded to the following: Whitehorse & Church, Portland, Ore.; Ashton & Evans, Salt Lake City, Utah; Paul Gordon Carlson, Seattle, Wash.

COMPLIMENTED FOR BANK DESIGN

Compliments for designing a bandit-proof bank were received by William Aitken, 408 Marion St., Seattle, from the officials of the Orting State Bank, Orting, Wash., following the capture of a bandit by Miss Emma Olsen, bank bookkeeper, on Thursday morning, May 9. The research and planning which Architect Aitken did in the spring of 1936 has produced satisfactory results, the bank officials told the architect.

MODERNIZED PRODUCTS

Brief Notes on New Materials and Equipment in the Building Industry.

391. SWIMMING POOLS

Paddock Engineering Company have issued a very attractive booklet, illustrated in natural colors, describing their swimming pools. These pools are designed for every purpose and are especially adapted for estates and private use. Send for a copy of this beautiful booklet by using the coupon.

392. CASEMENTS

From The Casement Hardware Company we have received two little booklets which are titled "Things you ought to know about casement windows" and "How to modernize your home with casement windows." Both of these small books are very well illustrated and have plenty of descriptive matter.

393. PLUMBING FIXTURES

A new booklet just off the press from Crane Company illustrates some of the latest equipment for kitchen, laundry, bathroom and heating units. Color is used for the illustrations and the equipment is shown in the proper groups as it would be installed in a home. Send for a copy—the coupon is for your convenience.

394. SCREENS

Ingersoll Steel and Disc Division of the Borg-Warner Corporation have put out a brochure on their "Koolshade" Screen. These new type screens are a complete change in screen design and are intended to admit maximum light and keep out glare and heat.

395. FORM LINING

A new type form lining for case-hardening concrete is described in a memorandum issued by Fir-Tex Insulating Board Company. This new lining according to the data can be used in dwellings, buildings, dams and bridges. Send for the complete data by using the coupon.

396. PLYBOARD

The Speedwell Company have put out a broadside depicting the uses of their product "Jumbo Speedwall"; this is a fabric covered plyboard

which has a wide variety of uses in the home. The coupon will bring you a copy and all pertinent data.

397. RADIO CONTROL

Barber-Colman Company have a brochure dealing with their "Model C Radio Control" for use with garage doors and gates directly from an automobile. A full description with details is contained in this brochure.

398. FANS

A new all-purpose fan is the subject of a broadside put out by Auto-Vent Fan and Blower Company. This broadside describes the uses of this system of ventilation and the installation features. Send for a copy.

399. LIGHTING FIXTURE

Announcement is made of a new fluorescent fixture and the details are given in a broadside issued by the Mozart Specialty Corporation. According to the broadside this fixture is available for homes, offices, sales-rooms and other public spaces.

400. WATER TANKS

A line of hot water tanks manufactured by a subsidiary company of the American Rolling Mill is fully described in a news memorandum. Send for data by using the coupon below.

401. SAFETY TREAD

The National Bronze and Aluminum Foundry Company have issued a brochure descriptive of "Ten-Lox," a safety treads for stairways and floors. This new product has been accepted by the Underwriters Laboratories. The coupon will assure you of full information on this product.

402. FOR GLASS ROOFS

American Bar Lock Company have a news memorandum out on their new patented insulated glass roof construction. This is a solid aluminum frame for setting horizontal glass blocks. Send for further data; use the coupon below.

403. KITCHEN CABINETS

A little booklet by the Bennett Manufacturing Company illustrates their kitchen cabinets; all-metal, re-

cessed and with the latest innovations in this type of installation. The coupon will bring your copy.

404. FLOOR POLISH

A broadside by the Tamms Silica Company describes a floor dye and a self-polishing wax especially for use on concrete floors, either interior or exterior. This broadside has a color scheme showing the various shades with directions for applying and a price list. Send for a copy by using the coupon.

405. PINE

Western Pine Association has another of their really fine booklets. This one is entitled "The Story of Western Pines," and has illustrations showing the complete story of Western pine lumber from stand through mill to finished product. The coupon below will bring you a copy.

406. VENTILATION

Ilg Electric Ventilating Company announce new literature featuring their recent installation of ventilating equipment in eight model homes at the World's Fair in New York. The latest in electric ventilating is described in this new folder. Send for your copy.

FREE FOR THE ASKING

Check items on coupon, paste on letter head or postal card, and mail to Architect and Engineer.

Architect and Engineer
68 Post Street
San Francisco, Calif.

Please send me literature on the items as checked below. This places me under no obligation.

391 <input type="checkbox"/>	396 <input type="checkbox"/>
392 <input type="checkbox"/>	397 <input type="checkbox"/>
393 <input type="checkbox"/>	398 <input type="checkbox"/>
394 <input type="checkbox"/>	399 <input type="checkbox"/>
395 <input type="checkbox"/>	400 <input type="checkbox"/>
	401 <input type="checkbox"/>

My Name.....

Name of Company.....

Street.....

City.....State.....

Estimator's Guide

Giving Cost of Building Materials, Wage Scale, Etc.

Amounts given are figuring prices and are made up from average quotations furnished by material houses to San Francisco contractors. 3% Sales Tax on all materials but not labor.

All prices and wages quoted are for San Francisco and the Bay District. There may be a slight fluctuation of prices in the interior and southern part of the state. Freight charge, at least, must be added in figuring country work.

and—1/2% amount of contract.

Brickwork—

Common, \$40 to \$45 per 1000 laid, (according to class of work).
 Face, \$90 to \$100 per 1000 laid, (according to class of work).
 Brick Steps, using pressed brick, \$1.00 lin. ft.
 Brick Veneer on frame buildings, \$0.70 sq. ft.
 Common f.o.b. cars, \$14.00 at yard. Cartage extra.
 Face, f.o.b. cars, \$45.00 to \$50.00 per 1000 carload lots.

HOLLOW TILE FIREPROOFING (f.a.b. job)

3x12x12 in. \$ 84.00 per M
 4x12x12 in. 94.50 per M
 6x12x12 in. 126.00 per M

Building Paper—

1 ply per 1000 ft. roll \$3.50
 2 ply per 1000 ft. roll 5.00
 3 ply per 1000 ft. roll 6.25
 Stielkraft, 500 ft. roll 5.00
 Sash cord com. No. 7 \$1.20 per 100 ft.
 Sash cord com. No. 8 1.50 per 100 ft.
 Sash cord spot No. 7 1.90 per 100 ft.
 Sash cord spot No. 8 2.25 per 100 ft.
 Sash weights, cast iron, \$50.00 ton.
 Nails, \$3.50 base.
 Sash weights, \$45 per ton.

Concrete Aggregates—

Gravel (all sizes) \$1.45 per ton at bunker; delivered to any point in S. F. County \$1.85.

	Bunker	Delivered
Top sand	\$1.45	\$1.85
Concrete mix	1.45	1.85
Crushed rock, 1/4 to 3/4	1.60	2.00
Crushed rock, 3/4 to 1 1/2	1.60	2.00
Roofing gravel	1.60	2.00
City gravel	1.45	1.85
River sand	1.50	1.90

 Delivered bank sand—\$1.00 per cubic yard at bunker or delivered.

SAND—

	Bunker	Delivered
River sand	\$1.50	\$1.90
Lapis (Nos. 2 & 4)	2.00	2.40
Olympia Nos. 1 & 2	1.80	2.20
Healdsburg plaster sand	\$1.80 and \$2.20	
Del Monte white	.50c per sack	

CEMENT (all brands, common, cloth sacks) \$2.72 per bbl. f.o.b. car; deliv. \$2.90 per bbl., carload lots; less than carload lots, warehouse or deliv., 80c per sack. (Less 10c per sack returned, 2% 10th Prox.)

Common cement (all brands, paper sacks) carload lots \$2.52 per bbl. f.o.b. car; delivered, \$2.70; less than carloads delivered, 75c per sack. Discount on cloth sacks, 10c per sack. Cash discount on carload lots, 10c a barrel, 10th Prox.; cash discount less than carload lots, 2%.

Atlas White }
 Calaveras White } 1 to 100 sacks, \$2.00 sack,
 Medusa White } warehouse or delivery;

Forms, Labors average \$40.00 per M.
 Average cost of concrete in place, exclusive of forms, 35c per cu. ft.; with forms, 60c.
 4-inch concrete basement floor 12 1/2c to 14c per sq. ft.
 Rat-proofing 7 1/2c
 Concrete Steps \$1.25 per lin. ft.

Dampproofing and Waterproofing—

Two-coat work, 20c per yard.
 Membrane waterproofing—4 layers of saturated felt, \$4.50 per square.
 Hot coating work, \$1.80 per square.
 Medusa Waterproofing, 15c per lb., San Francisco Warehouse.
 Tricocel waterproofing.
 (See representative.)

Electric Wiring—\$12.00 to \$15.00 per outlet for conduit work (including switches).
 Knob and tube average \$3.50 per outlet.

Elevators—

Prices vary according to capacity, speed and type. Consult elevator companies. Average cost of installing an automatic elevator in four-story building, \$2800; direct automatic, about \$2700.

Excavation—

Sand, 60 cents; clay or shale \$1 per yard.
 Teams, \$12.00 per day.
 Trucks, \$22 to \$27.50 per day.

Above figures are an average without water. Steam shovel work in large quantities, less; hard material, such as rock, will run considerably more.

Fire Escapes—

Ten-foot galvanized iron balcony, with stairs, \$115 installed on new buildings; \$140 on old buildings.

Floors—

Composition Floors—22c to 40c per sq. ft. In large quantities, 16c per sq. ft. laid.
 Mosaic Floors—80c per sq. ft.
 Duraflex Floor—23c to 30c sq. ft.
 Rubber Tile—50c to 75c per sq. ft.
 Terrazzo Floors—45c to 60c per sq. ft.
 Terazzo Steps—\$1.60 lin. ft.

Hardwood Flooring (delivered to building)—

	3 1/2"x2 1/4"	3 1/2"x2"	3 1/2"x2"
	T & G	T & G	Sq. Ed.
Clr. Qtd. Oak	\$144.00 M	\$122.00 M	\$141.00 M
5el. Qtd. Oak	118.00 M	101.00 M	114.00 M
Clr. Fla. Oak	120.00 M	102.00 M	115.00 M
5el. Fla. Oak	113.00 M	92.00 M	107.00 M
Clr. Maple	125.00 M	113.00 M	

Wage—Floor layers, \$10.00.
 Note—Above quotations are all board measure except last column which is sq. ft.

Glass (consult with manufacturers)—

Double strength window glass, 20c per square foot.
 Plate 75c per square foot (unglazed) in place, \$1.00.
 Art. \$1.00 up over square foot.
 Wire (for skylights), 40c per sq. foot.
 Obscure glass, 30c to 50c square foot.
 Glass bricks, \$2.40 per sq. ft., in place.
 Note—If not stipulated add extra for setting.

Heating—

Average, \$1.90 per sq. ft. of radiation, according to conditions.
 Warm air (gravity) average \$48 per register.
 Forced air, average \$68 per register.

Iron—Cost of ornamental iron, cast iron, etc., depends on designs.

Lumber (prices delivered to bldg. site).

No. 1 common	\$30.00 per M
No. 2 common	28.00 per M
Select O. P. common	35.00 per M
2x4 No. 3 form lumber	22.00 per M
1x4 No. 2 flooring VG	58.00 per M
1x4 No. 3 flooring VG	51.00 per M
1x6 No. 2 flooring VG	70.00 per M
1 1/2x4 and 6, No. 2 flooring	70.00 per M

Slash grain—

1x4 No. 2 flooring	\$45.00 per M
1x4 No. 3 flooring	42.00 per M
No. 1 common run T. & G.	33.00 per M
Lath	5.50 per M

Shingles (add cartage to price quoted)—
 Redwood, No. 1 \$1.10 per bdle.
 Redwood, No. 2 1.00 per bdle.
 Red Cedar 1.10 per bdle.

Plywood—Douglas Fir (add cartage)—

"Plyscord" sheathing (unsanded)
 5/16" 3-ply and 48"x96" \$32.50 per M
 "Plywall" (wallboard grade)—
 1/4" 3-ply 48"x96" \$37.50 per M
 "Plyform" (concrete form grade)—
 3/4" 5-ply 48"x96" \$110.00 per M
 Exterior Plywood Siding—
 7/16" 5-ply Fir \$ 90.00 per M
 Redwood (Rustic) 85.00 per M

Millwork—Standard.

O. P. \$35.00 per 1000. R. W., \$100.00 per 1000 (oboevce).
 Double hung box window frames, average with trim, \$6.50 and up, each.
 Doors, including trim (single panel, 1 3/4 in. Oregon pine) \$8.00 and up, each.
 Doors, including trim (five panel, 1 3/8 in. Oregon pine) \$6.00 each.
 Screen doors, \$3.50 each.
 Parent screen windows, 25c a sq. ft.
 Cases for kitchen pantries seven ft. high per lineal ft., \$8.00 each.
 Dining room cases, \$8.00 per lineal foot.
 Rough and finish about 75c per sq. ft.
 Labor—Rough carpentry, warehouse heavy framing (average) \$17.50 per M.
 For smaller work average \$35.00 to \$45.00 per 1000.

Marble—(See Dealers)

Painting—

Two-coat work	per yard	42c
Three-coat work	per yard	60c
Cold water painting	per yard	10c
Whitewashing	per yard	4c
Turpentine	65c per gal., in 5 gal. cans, and 55c per gal. in drums.	
Raw Linseed Oil	—95c gal. in light drums.	
Boiled Linseed Oil	—98c gal. in drums and \$1.08 in 5 gal. cans.	

White Lead in oil

	Per Lb.	
1 ton lots, 100 lbs. net weight	113/4c
500 lbs. and less than 1 ton	12c
Less than 500 lb. lots	12/2c

Red Lead and litharge

1 ton lots, 100 lbs. net weight	113/4c
500 lbs. and less than 1 ton	12c
Less than 500 lb. lots	12/2c

Red Lead in oil

1 ton lots, 100 lbs. net weight	123/4c
500 lbs. and less than 1 ton	13c
Less than 500 lb. lots	13/2c

Note—Accessibility and conditions cause some variance in costs.

Patent Chimneys—

6-inch	\$1.25 lineal foot
8-inch	1.75 lineal foot
10-inch	2.25 lineal foot
12-inch	3.00 lineal foot

Plastering—Interior—

	Yard	
1 coat, brown mortar only, wood lath	\$0.50
2 coats, lime mortar hard finish, wood lath85
2 coats, hard wall plaster, wood lath72
3 coats, metal lath and plaster	1.25
Keene cement on metal lath	1.30
Ceilings with 3/4 hot roll channels metal lath (lathed only)90
Ceilings with 3/4 hot roll channels metal lath plastered	1.80
Single partition 3/4 channel lath 1 side (lath only)85

Single partition 3/4 channel lath 2 inches thick plastered	\$2.90
4-inch double partition 3/4 channel lath 2 sides (lath only)	1.70
4-inch double partition 3/4 channel lath 2 sides plastered	3.30
Thermax single partition: 1" channels; 2 1/4" overall partition width. Plastered both sides	2.50
Thermax double partition; 1" channels; 4 3/4" overall partition width. Plastered both sides	3.40
3 coats over 1" Thermax nailed to one side wood studs or joists	1.25
3 coats over 1" Thermax suspended to one side wood studs with spring sound isolation clip	1.45

Plastering—Exterior—

2 coats cement finish, brick or concrete wall	\$1.00
3 coats cement finish, No. 18 gauge wire mesh	1.50
Wood lath, \$5.50 to \$6.50 per 1000.		
2.5-lb. metal lath (dipped)19
2.5-lb. metal lath (galvanized)21
3.4-lb. metal lath (dipped)22
3.4-lb. metal lath (galvanized)24
3/4-inch hot roll channels, \$72 per ton.		
Finish plaster, \$18.90 ton; in paper socks.		
Dealer's commission, \$1.00 off above quotations.		
\$13.85 (rebate 10c sack).		
Lime, f.o.b. warehouse, \$2.25 bbl.; cars, \$2.15		
Lime, bulk (ton 2000 lbs.), \$16.00 ton.		
Wall Board 5 ply, \$50.00 per M.		
Hydrite Lime, \$19.50 ton.		
Plasterers Wage Scale	\$1.67 per hour
Lathers Wage Scale	1.60 per hour
Hod Carriers Wage Scale	1.40 per hour

Composition Stucco—\$1.80 to \$2.00 sq. yard (applied).

Plumbing—

From \$70.00 per fixture up, according to grade quantity and runs.

Roofing—

"Standard" tar and gravel, \$6.00 per sq. for 30 sqs. or over.
 Less than 30 sqs. \$6.50 per sq.
 Tile, \$20.00 to \$35.00 per square.
 Redwood Shingles, \$7.50 per square in place.
 Copper, \$16.50 to \$18.00 per sq. in place.
 Cedar Shingles, \$8.00 per sq. in place.
 Re-coat with Gravel, \$3 per sq.
 Asbestos Shingles, \$15 to \$25 per sq. laid.

Slate, from \$25.00 per sq., according to color and thickness.
 Shakes—1x25" resawn \$1.50 per sq.
 1/2x25" resawn 10.50 per sq.
 1/2x25" tapered 10.00 per sq.
 Above prices are for shakes in place.

Sheet Metal—

Windows—Metal, \$1.75 a sq. foot.
 Fire doors (average), including hardware \$1.75 per sq. ft.

Skylights—(not glazed)

Copper, 90c sq. ft. (flat).
 Galvanized iron, 30c sq. ft. (flat).
 Vented hip skylights 60c sq. ft.

Steel—Structural

\$120 ton (erected), this quotation is an average for comparatively small quantities. Light truss work higher. Plain beams and column work in large quantities \$97 to \$105 per ton.

Steel Reinforcing—

\$80.00 to \$120.00 per ton, set.

Stone—

Granite, average, \$6.50 cu. foot in place.
 Sandstone, average Blue, \$4.00. Boise \$3.00 sq. ft. in place.
 Indiana Limestone, \$2.80 per sq. ft. in place.

Store Fronts—

Copper sash bars for store fronts, corner center and around sides, will average 75c per lineal foot.
 Note—Consult with agents.

Tile—Floor, Wainscot, etc.—(See Dealers)
 Asphalt Tile—18c to 28c per sq. ft. installed.

Wall Tile—

Glazed Terra Cotta Wall Units (single faced) laid in place—approximate prices:
 2 x 6 x 12 \$1.00 sq. ft.
 4 x 6 x 12 1.15 sq. ft.
 2 x 8 x 16 1.10 sq. ft.
 4 x 8 x 16 1.30 sq. ft.

Venetian Blinds—

40c per square foot and up. Installation extra.

SAN FRANCISCO BUILDING TRADES WAGE SCALES

All crafts 8 hour day (except as otherwise noted) and 5 day week. Effective as of May 1, 1940.

CRAFT	Journeyman Mechanics
Asbestos Workers	\$10.00
*Bricklayers	10.50
*Bricklayers' Hodcarriers	7.50
Cabinet Workers (outside)	10.00
Caisson Workers (Open)	8.80
Carpenters	10.00
Cement Finishers	10.00
Electricians	11.00
Elevator Constructors	12.00
Engineers (Portable and Hoisting)	10.00
Glass Workers	9.68
†Housesmiths, Ornamental Iron (Shop and Outside)	10.00
Housesmiths, Reinf. or Rodmen	10.50
Ironworkers (Bridge and Structural—Engineers)	12.80
Laborers (Building and Common)	6.50
*Lathers	9.60
Marble Setters	10.50

CRAFT	Journeyman Mechanics
Millwrights	10.00
Mosaic and Terrazzo Workers	8.00
†Painters	8.75
Pile Drivers and Wharf Builders	11.20
Pile Drivers Engineers	12.80
*Plasterers	10.00
*Plasterers (Hodcarriers)	8.40
Plumbers	11.20
Roofers	9.68
Sheet Metal Workers	10.00
Sprinkler Fitters	11.00
Steamfitters	11.00
Steir Builders	10.00
Stone Cutters	9.00
*Stone Setters	10.50
Tile Setters	11.00
Welders, Structural Steel Frame on Buildings	12.80
\$Dump Truck Drivers, 2 yards or less	7.00

CRAFT	Journeyman Mechanics
\$Dump Truck Drivers, 3 yards	7.50
\$Dump Truck Drivers, 4 yards	8.00
\$Dump Truck Drivers, 5 yards	8.00
\$Dump Truck Drivers, 6 yards	8.50
Truck Drivers of Concrete Mixer Trucks:	
2 yards or less	8.00
3 yards	8.57
4 and 5 yards	9.14
6 yards	9.71
EXPLANATION:	
*—6 Hour Day.	
†—7 Hour Day.	
‡—Term "Architectural Iron" no longer used. This craft "Ornamental Ironworker."	
\$—Dump Truck Drivers work 7 HOURS ON PUBLIC WORK, 8 HOURS ON PRIVATE WORK; starting time 7:30 A.M.	

AQUACADE INTRIGUES ARCHITECTS-ENGINEERS

Architects, engineers and contractors are manifesting unusual interest in the construction of Billy Rose's Aquacade on Treasure Island.

The tremendous task of building the world's largest theater, seating 7,000 within the shell of a 190' by 650' structure, which last year housed International Exhibits, developed many new problems.

General Manager Lincoln G. Dickey surveyed the structure and planned the entire operation from plans by Clark Robinson of New York, Mario Ciampi and W. H. Ellison of San Francisco.

Barrett and Hilp, awarded the general contract, took up the first flooring April 9, and shortly steam shovels began biting into the sandy soil of Treasure Island. Though in digging deep foundation for the swimming tank no water seepage problem was encountered, B. A. Stevenson, engineer in charge for Barrett and Hilp, found that the sand of the Island dug from the deep end of the tank was not the proper soil for tamping under the flooring of the tank so a special sand was used.

Though other swimming tanks are made of concrete, and the New York Aquacade is made of steel, the Treasure Island tank is constructed of Western wood—two inch tongue-in-groove Oregon pine. It is 50 by 250 feet, 12 feet deep at the diving ends and 5 feet in the middle. It will hold nearly half a million gallons of fresh water, supplied from the Exposition reservoir on Yerba Buena Island, and heated to 72 degrees.

The water flows by gravity from the tank into two huge filters under the stage, is treated with chlorine and ammonia, then goes back into the tank. During 12 hours every drop of water is filtered and treated.

The 12,650 square feet of pool surface is covered with white lead, then with a mopping of pure asphalt. This is covered with two membranes of a composition rubber. The pool is painted in turquoise blue water-proof paint.

The largest theater stage in the world, 50 by 250 feet, is flanked by two diving towers, each 50 feet high.

More light is used for the production of Aquacade than ever before seen on the West Coast—enough, in fact, to supply a town of 5,000 population.

Two catwalks on 35 and 45 foot levels 100 feet from the stage support banks of 120 2000 watt spotlights. Four arc lights are 5000 watts apiece. In all, 350,000 watts of light pour from the spots on the catwalks, each spot being 22 inches on center, with 72,000 additional watts coming from 18 spots on the proscenium arch on both sides of the stage. General house illumination requires 50,000 watts, the dressing rooms using 10,000 watts more. Two hundred and fifty thousand feet of wiring is used on the job.

The blue sky canopy embodies 11,000 square yards of canvas, supplemented by 1,000 square yards of silver gray velour side stage. One thousand yards of theatrical



California's Hotel Beautiful

- like a country estate yet in the heart of a throbbing metropolitan area.
- a matchless view—comfortable, luxuriously furnished rooms, excellent cuisine.
- in an atmosphere of quiet and gracious living.

Rooms, with bath, \$2.50 to \$5.00 per day.

Attractive monthly rates

HOTEL CLAREMONT • BERKELEY

STREAMLINED CONSTRUCTION DEMANDS SPEED IN CONCRETE HARDENING

When Minutes Mean DOLLARS

This 20 page MANUAL TELLS HOW TO GET IT ECONOMICALLY ASK FOR IT

GOLDEN GATE PORTLAND CEMENT

A "Pacific" Product sold by Building Materials Dealers

24 HOUR SERVICE

Produced by
PACIFIC PORTLAND CEMENT COMPANY
SAN FRANCISCO • SEATTLE COASTWISE SERVICE LOS ANGELES • PORTLAND

ACOUSTI-CELOTEX

for office-quieting provides . . .

- PAINTABILITY
- PERMANENT LIGHT-REFLECTION
- HIGH EFFICIENCY

Acoustical Engineers & Contractors

WESTERN ASBESTOS CO.

Building Materials *Mechanical Specialties*
SACRAMENTO OAKLAND
SAN FRANCISCO

POMONA TILES

FOR
Bathrooms and Kitchens
in over 60 colors

Warehouses and Display Rooms

135 Tenth St. San Francisco

629-33 North La Brea Ave. Los Angeles

6106 Roosevelt Way Seattle

POMONA TILE MFG. CO.
PLANT — POMONA, CALIF.

STRUCTURAL STEEL

For Class A Buildings,
Bridges, etc.

JUDSON PACIFIC CO.

1200 SEVENTEENTH STREET
SAN FRANCISCO

Plants: San Francisco - Oakland

A Permanent Exposition
of the newest ideas
in home planning
and equipment.



THE BUILDING MATERIAL EXHIBIT

Architects Bldg. • Fifth & Figueroa • Los Angeles • MU-6306

cal gauze is hung over the stage. Made to order is 72,000 feet of manila rope for the canopy canvas. The canopy follows the curve of the ceiling trusses and is 650 feet long and 225 feet wide, with opening for lights and ventilators.

No spectator, despite the size of the theater, is more than 65 feet from the runway surrounding the great aquapool which fronts the stage and diving towers. There are nine entrances and eleven exits for the 7,000 spectators.

There are dressing rooms for 250 persons, with both a "wet" and "dry" side. The sound system is declared to be the best ever perfected for a similar production.

SCHOOL OF DESIGN

The School of Design in Chicago announces three full tuition scholarships for the school year 1940-1941 each \$351.50. One of the scholarships can be received by any student who has graduated from a high school and who has an ability for concentrated work in art, science and technology. Two other scholarships are reserved for graduates of a liberal arts college and of a technological institute. All applicants must be under 24 years of age. Inquiries should be made to L. Moholy-Nagy, Director, School of Design in Chicago, 247 East Ontario Street, Chicago, Ill., not later than July 20, 1940.

The School of Design in Chicago, incorporated not for profit, embodies the principles and educational methods of the world famed Bauhaus founded in 1919.

STRUCTURAL STEEL WELDING

Formation of a Structural Steel Welding Research Committee to study problems of design and fabrication in the building field, is announced by the Engineering Foundation, research organization of the national engineering societies.

Leon S. Moisseiff, New York consulting engineer, and designer of the George Washington and Triboro bridges in New York and the Golden Gate and San Francisco-Oakland Bay bridges, has been chosen chairman.

The program includes the establishment of research fellowships in American universities. The first fellowship goes to Lehigh University for a two-year period and carries with it an annual stipend of \$1,100. Other fellowships will be established as soon as the committee maps a complete program of research projects. The investigations at Lehigh will be directed toward developing a satisfactory design procedure for beam-to-girder and beam-to-column connections for all kinds of welded building construction.

HIGH SCHOOL GYMNASIUM

Plans are being prepared by G. N. Hilburn of Modesto for a one-story frame and stucco gymnasium for the Hughson Union High School District at Hughson, Stanislaus County. There is \$30,000 available for the project.

SHOWER TROUBLES ENDED

The answer to shower troubles would seem to have been found in the SMP Glasshower, recently placed on the market by the Stainless Metal Products, Inc., of Oakland. Models of this improved fixture may be seen at the company's show rooms, 481 Twenty-fifth Street, and it should pay architects and builders to investigate the merits of this new product before making up their bathroom specifications. It is truly a marvelous shower—economical, beautiful and practical. Porcelain back



GLASS AND STAINLESS STEEL SHOWER

walls in restful pastels are substituted for enamel tile and are as easily cleaned as a china dish. Clear or obscure glass, framed in stainless steel, completes the unit. The element of space, important in the average bathroom, has not been overlooked and at least three square feet of floor room is saved by elimination of wall space.

The construction details are such that this unit is not affected by shrinkage or settling.

In addition to these improvements Glasshower eliminates the furring down from the ceiling as well as the lead or copper pan commonly used in construction of shower floors, thereby cutting cost in labor, materials and finishing.

The shower, modern in design, has an open top, which allows free circulation and infiltration of air, features conducive to sanitation and dryness of walls and floors.

Many different models in color variations are available to meet the demands of the most discriminating.

A good investment—

is a well designed, well built structure, properly located.

Lindgren & Swinerton, Inc.

have been building substantial buildings for over a half of a century, are still building them and will continue building them for another half a century.

Lindgren & Swinerton, Inc.

Standard Oil Building
San Francisco
619 H Street
Sacramento

605 W. Olympic Boulevard
Los Angeles
1723 Webster Street
Oakland

DECORATION OF MODERN INTERIORS SPECIALIZATION IN THE FABRICATION OF LUCITE AND OTHER PLASTICS

TWO OUTSTANDING RECENT INSTALLATIONS, RESIDENCE OF DR. L. G. CUENIN.
NEW UNION PACIFIC TICKET OFFICE.

Plastic Display Laboratories

SAN FRANCISCO

729 MINNA STREET

HEMLOCK 9941

BAXCO

CHROMATED ZINC CHLORIDE

CZC

PRESSURE TREATED LUMBER

● PROTECTS AGAINST DECAY
AND TERMITE ATTACK

*Specify it in your home
Available through Lumber Dealers*

LOS ANGELES
601 W. 5th Street
Phone Michigan 6294

SAN FRANCISCO
333 Montgomery Street
Phone DOuglas 3883

J. H. Baxter & Co.

AGENTS FOR WEST COAST WOOD PRESERVING CO., SEATTLE, WASH.



QUALITY AND DEPENDABLE Service

are the factors that influence architects and contractors when selecting lumber and mill work — Quality of merchandise — Integrity and Ability of the firm — Service in physical equipment — Experience and Personnel — All these factors contribute to a speedy and satisfactory completion of construction with minimum of time and expense.

MANUFACTURER OR DEALER IN

Douglas Fir—Redwood—Sugar and Ponderosa Pine — Plywood and Concrete Form Panels — Sash and Doors — Millwork — Insulation — Builders' Hardware.

E. K. WOOD LUMBER CO.

"Goods of the Woods" ©

LOS ANGELES • SAN FRANCISCO • OAKLAND



Arrowhead Springs Hotel Swimming Pool—Paul R. Williams and Gordon B. Kaufman, Architects. Builder: Paddock Engineering Company.

Congratulations to PAUL R. WILLIAMS

with whom we have had the pleasure of being associated over many years.

PADDOCK ENGINEERING CO.

FINE SWIMMING POOL AND TENNIS COURT INSTALLATIONS IN CONJUNCTION WITH CALIFORNIA'S LEADING ARCHITECTS

1014 N. LA BREA AVE.

HILLSIDE 8161

LOS ANGELES

RESIDENTIAL BUILDING UPTREND

The accompanying chart, prepared by Merrill Lynch, E. A. Pierce & Cassatt, members of New York, San Francisco and other leading stock and commodity exchanges, indicates that the index of value of new residential construction permits issued in the Twelfth District stood at 66 for April, a new high level since 1929

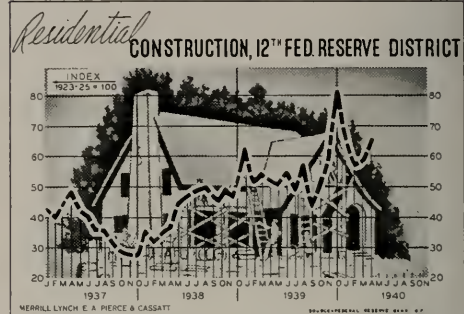

when the figures for last December and January are adjusted to eliminate special U.S.H.A. projects. In those months, special large multiple dwelling residences were started in San Francisco, Oakland and Los Angeles.

The low level of such construction during the current year occurred in February, when the index was 57, comparing with 52 in April a year ago. A 10% rise is being estimated for this year over 1939, stimulated by F.H.A. assistance and the vigorous drive of building materials companies.

PASSING OF JAS. A. WETMORE

Pacific Coast architects who for many years deplored the Federal Government's appointment of James Wetmore as Acting Supervising Architect, because he was not an architect, will learn with sadness of Mr. Wetmore's passing on March 14 at his home, following a lingering illness. He was 77. Educated as a lawyer, Mr. Wetmore was moved from the Government Law of Records Division to the Supervising Architect's office, succeeding Oscar Wenderoth who resigned because of ill health in 1915. Mr. Wetmore remained in office until 1934, a period of great building activity during which more buildings were erected than had been built in the whole history of the Government previous to 1915. Because Wetmore's name appeared upon the cornerstone of each one of these buildings, the cartoonist Ripley listed him as having his name carved on more buildings than any other man in history, a statement which was without doubt true.

While Mr. Wetmore, "Judge" Wetmore as he was called by all his friends, was neither an architect nor an engineer, he had an uncanny facility for knowing the intent and purpose of the architectural and engineering actions of his organization.

MULLEN MFG. COMPANY

BANK, STORE AND OFFICE
FIXTURES—CABINET WORK
OF GUARANTEED QUALITY
CHURCH SEATING

Office and Factory:
60-80 RAUSCH ST., Bet. 7th and 8th Sts.
San Francisco
Telephone UNderhill 5815

G. P. W. JENSEN & SON

Building Construction

320 Market Street, San Francisco
Phone: GARfield 2444

DINWIDDIE CONSTRUCTION COMPANY

•
BUILDERS

•
CROCKER BUILDING
SAN FRANCISCO

A L A D D I N Heating Corp.

Specializing in
QUALITY HEATING
EQUIPMENT

2222 San Pablo Avenue
Oakland
TWinoaks 1022

acres of fertile lands and make available to the Pacific Northwest an abundant supply of low-cost electricity.

KITCHEN AND BATHROOM IDEAS

With an artistic appeal to the consuming public, the new issue of Kraftile's "Ideas for Kitchens and Bathrooms" is being distributed not only to prospective owners of dwellings but to architects, engineers, builders, contractors and tile dealers.

Two half-pages in four colors feature installations. A kitchen design for a \$7500 dwelling by Fred'k H. Reimers, architect, makes attractive art for the first page of the six-page folder. Another attractive page shows a bathroom designed by Fredrick L. Confer, architect.

Two other widely known architects are quoted in the folder which carries their photographs. These are Mario Corbett, whose California homes have attracted national attention, "an enthusiastic admirer of Master Krafttile 6 x 9's" and Wilton Smith, of San Francisco. Mr. Smith considers Master Krafttile 6 x 9's "the smartest trend in wall tiling in the last twenty years."

Besides four-color cuts, the folder in featuring Krafttile colors "inspired by nature's tints and hues in the West," carries a group of line sketches showing various types of installation. Patio, door-way, and other features are depicted, as well as the handsome color swatches in like-like reproduction.

Krafttile Company's consumer campaign has resulted in thousands of inquiries, according to C.W. "Chuck" Kraft, president.

OWN-A-HOME SAVINGS CLUB

The new Own-a-Home Savings Club of the U. S. Savings & Loan League, which is being launched by hundreds of building and loan associations in the United States, will enable tens of thousands of newly-weds to build and own their own homes, predicts E. W. Morrill, vice-president and general sales manager of the Insulite Co., with headquarters in Minneapolis, Minnesota.

The main purpose of these new sav-

Millwork on the following
jobs by the

VALLEY PLANING MILL, Inc.

Phone: State 52183
6103 CEDROS AVE.
Van Nuys, Calif.



Music Corporation of America
Mr. and Mrs. F. R. Bain, residence
Dr. and Mrs. Joseph Harris, residence
Mr. and Mrs. Harry Joe Brown, residence
Mr. and Mrs. L. L. Cady, residence
Chas. E. McGinley, residence
Mr. and Mrs. Leon Schlessinger, residence
Mr. and Mrs. Felix Chappellet, residence
Mr. and Mrs. W. S. Warfield, residence
Mr. and Mrs. Irving Metzler, residence
Mr. and Mrs. John C. Woodall, residence
Morris Landeau, residence
Mr. and Mrs. Frank Wood, residence
T. Keith Glennan, residence
Mr. and Mrs. Geo. L. Fernbacher, residence
Mr. and Mrs. Nat Goldstone, residence

Paul R. Williams, Architect

Smith

Lumber Company
WHOLESALE - JOBBING - RETAIL
FACTORY AND BUILDING LUMBER
PLYWOODS - ROOFING
DISTRIBUTING YARDS
San Francisco | Oakland
• | 19th Ave. &
4th & Channel | Estuary
MArket 0103 | FRuitvale 3174
YOUR INQUIRIES SOLICITED

SISALKRAFT

REG. U. S. PAT. OFF.

"More than a
building paper"

THE SISALKRAFT CO.
205 West Wacker Drive
(Canal Station) Chicago, Ill.
55 West Montgomery Street
San Francisco, Calif.

ABBOT A. HANKS, INC.
Engineers & Chemists

INSPECTING — TESTING — CONSULTING
 CONCRETE • STEEL • MATERIALS
 CHEMICAL AND TESTING
 LABORATORIES
 • RESEARCH AND INVESTIGATION •

TESTS OF STRUCTURAL MATERIALS
 DESIGN OF CONCRETE MIXES
 SHOP AND ERECTION INSPECTION OF
 STRUCTURES AND EQUIPMENT
 INVESTIGATION OF STRUCTURES
 AND MATERIALS
 TESTS AND INVESTIGATION OF
 FOUNDATION SOILS
 FIRE RESISTANCE AND INSULATION
 TESTS

624 Sacramento Street, San Francisco

HIGH GRADE MILLWORK
 AND INTERIOR FINISH
 SASH AND DOORS

LANNOM BROS.
MFG. CO.

FIFTH AND MAGNOLIA STREETS
 OAKLAND, CALIFORNIA
 Telephone: TEmplebar 3663



PRODUCTS

VAN ARSDALE-HARRIS CO.
 ENGINEERS & CONTRACTORS

ACOUSTICAL TREATMENT
 INSULATION
 SOUND CONTROL

Fifth and Brannan Streets
 San Francisco, Calif.
 Telephone GARfield 3600

Division
 VAN ARSDALE-HARRIS
 LUMBER CO., INC.

**FINE WATER COLORS
 AND PAPERS
 FOR ARCHITECTURAL
 RENDERINGS**

**H. S. CROCKER
 COMPANY, Inc.**

720 MISSION STREET
 MARKET STREET AT SECOND
 SAN FRANCISCO

ings clubs is to encourage young married couples to save enough money on a monthly savings plan to make first payments on new homes, and thus render it possible for them to own their own homes.

Any person who can save \$10 or more a month is eligible to join a club. It is estimated that it will take a member from 36 to 60 months to save enough to make a first payment on a new home. The building and loan association sponsoring the club is to finance the balance on a long term monthly payment basis.

OREGON OPPOSED TO FILIATION

Present at the regular monthly meeting April 16 were Messrs. Stanton, Belluschi, Morin, Aandahl, Herzog, Crowell, Turner, Hilgers, Annand, Morden, Wick, R. Logan, Zeller, Bailey, Mockford and Wallman. Guest: M. B. Harrison, Columbia Steel Co.

After diner Mr. Harrison showed a very interesting film of steel production.

The meeting was called to order at 7:07 by President Stanton.

A recent communication from Mr. Fuller, Regional Director, concerning a proposal for the formation of certain regional councils was clarified by Mr. Crowell. The councils as proposed would be formed of representatives from Chapters and State Associations within a region and would deal with problems in the region.

Crowell read excerpts from his letter to Mr. Fuller regarding the proposal, in which he recommended in general that such a council in this region would impose too much of an administrative load and duplication of Chapter organization.

A letter from Mr. Fuller to Mr. Fletcher, chairman of the committee on State organizations, concerning the above proposal, was read, which contained the opinion that in our region Chapters would rather increase their own membership or number of Chapters rather than affiliate State Associations.

It was moved by Mr. Belluschi and seconded by Mr. Aandahl, that the Chapter concur with sentiments ex-

**JOSEPH MUSTO
 SONS-KEENAN
 CO.**

**MARBLE
 and ABRASIVES
 ONYX**

535 NORTH POINT STREET
 SAN FRANCISCO
 1801 S. SOTO STREET
 LOS ANGELES

THE MOST COMPLETE LINE
 OF STEELS AND STEEL BUILD-
 ING MATERIALS MADE BY A
 SINGLE PRODUCER



See Sweet's Catalog File or write us for full information.

Republic Steel Corporation
 General Offices: Cleveland, Ohio

Denver, Colo. . . . Continental Oil Bldg.
 Los Angeles, Calif. . . . Edison Bldg.
 Salt Lake City, Utah . . . Walker Bank Bldg.
 San Francisco, Calif. . . . Rialto Bldg.
 Seattle, Wash. . . . White-Henry-Stuart Bldg.

**Pacific
 Manufacturing
 Company**

High Class Interior Finish
 Quality Millwork

142 Sansome St. 6820 McKinley Ave.
 San Francisco Los Angeles
 GARfield 7755 THornwall 4196

1315 Seventh Street, Oakland
 GLencourt 7830

Some of the fine residences recently finished by the

G. A. BOLLAERT CO.

Painters and Decorators

3839 Wilshire Boulevard
 LOS ANGELES

Seth Hart.....	Holmby Hills
Lesley Kelly.....	Bel-Air
Jay Palley.....	Holmby Hills
Frank Wood.....	Bel-Air
Chas. Correll.....	Holmby Hills
T. R. Craig.....	Chatsworth
S. C. Hookstraeten.....	Whittier
F. R. Bain.....	Holmby Hills
Miles Gray.....	Holmby Hills
Tyrone Power.....	Brentwood

Paul R. Williams, Architect



WOMEN go into raptures over this new Wesix "Perfect Thirty-Six" electric bathroom heater. Its instant, head-to-foot heat, they exclaim, "is simply marvelous!" You will like it because it fits perfectly into 42-inch wainscots. For details write Dept. 206, Wesix Electric Heater Co., 390-1st St., San Francisco.

WESIX

World's Largest Manufacturers of Major Electric Heaters

Phone GARfield 1164

Hunter & Hudson

Consulting Engineers

DESIGNERS OF HEATING
AIR CONDITIONING
VENTILATING AND WIRING
SYSTEMS, MECHANICAL
AND ELECTRICAL EQUIP-
MENT OF BUILDINGS

41 SUTTER STREET
ROOM 710

San Francisco California

Robert W. Hunt Company

ENGINEERS

Inspection • Tests • Consultation

Schools and Other Structures
Are Built as Designed

When Construction Materials are
Inspected at point of Manufacture
and during Erection by

ROBERT W. HUNT COMPANY

Cement, Concrete, Chemical, Metallurgical,
X-Ray and Physical Laboratories

Chicago • New York • Pittsburgh
Los Angeles • All Large Cities
San Francisco, 251 Kearny Street

pressed in Mr. Crowell's and Mr. Fuller's letters regarding the above proposal. Motion carried.

President Stanton reported briefly upon the status of the Stearns Memorial Fountain. The Chapter is trying to arrange some sort of small competition for the design of the fountain which will meet the approval of all concerned.

The Waterfront Development was viewed with alarm. A proposal was made by Mr. Morin et al. that the Chapter committee on civic design be reminded of the previous resolution to make available for publication certain studies prepared by the Chapter. The suggestion was also made that a great deal of value might be realized from publication of outstanding examples of such developments elsewhere in the country.

TREASURE ISLAND

(Continued from Page 12)

of Columbus to the gay "nineties" in San Francisco. 3-4 shows daily.

Aquacade. Billy Rose's thrilling show which was an outstanding success at the 1939 New York Fair. 250 swimmers, divers, singers and dancers. 3 to 4 shows daily at popular prices.

Folies Bergere. Clifford C. Fischer's French hit with a cast of 65 artists direct from a year's engagement in Australia. Elaborate costumes and amazing novelty effects. Popular prices.

Salici puppets. Italian marionettes in amazing vaudeville acts, opera and drama. Popular prices. Hall of Western States.

Music features. Grace Moore, Jan Peerce, Gladys Swarthout, Alec Templeton, Lily Pons, Lauritz Melchior, Oscar Levant, Meredith Wilson, Pierre Monteux, Gaetano Merola and many others.

Ice Follies. "A Night at Lake Placid," spectacular ice show in the former French pavilion, featuring comedy, eccentric and figure-skating. Popular prices.

National Garden Show. Thirty-five gardens designed by leading landscape architects; 25-foot sun dial; garden ornaments and furniture; style show.

Federal Building. Airplane Models; "G" men exhibit; Indian craft, including Mayan and Incan tribes; skiing; mountain sports; bomb proof shelter and modern trench system; flying fortress; housing; publications; Boulder Dam model etc.

State and County exhibits. Historical and scenic dioramas; products of soil and industry; natural resources etc.

Radio. Red and blue network stars, as puppets, in complete show on twelve stages

INCLUDE TREES IN YOUR PLANS

DAVEY, ORIGINATOR OF TREE SUR-
GERY, OFFERS FREE INSPECTION
AND ESTIMATE.



SAN FRANCISCO

Russ Bldg. Sutter 3377

FRESNO
Mattei Bldg.

LOS ANGELES Tucker 1929
Story Bldg.

Local phones in: Pasadena, Palo Alto,
Oakland, San Rafael, San Mateo

SKILL - KNOWLEDGE -
RESPONSIBILITY

THE TORMEY COMPANY

GENERAL PAINTERS
AND DECORATORS

Phone UNDERhill 1913

563 FULTON STREET
San Francisco

Donovan Automatic Awning Type Windows

Give 100% natural ventilation
and day-lighting control

UNIVERSAL WINDOW
COMPANY

Berkeley, California

to represent hours. Continuous performances from 10 a.m. National Broadcasting Company exhibit. Short-wave station KGEI in "fish-bowl" studio. General Electric exhibit.

Television. RCA with "roaming reporter" in Court of the Seven Seas flashed on screen at RCA exhibit. Music room and lounge.

University of California Exhibit. Model of cyclotron. Action displays illustrative of laws of mechanics, physics and mathematics. Library, music, home economics, agriculture displays.

Homes. Miniature village comprising more than 100 model homes with home products, materials and furnishings. Homes and Gardens Palace.

Ice Industries. Live chinchillas in air-conditioned refrigerator. Robophone lectures.

Pacific Gas & Electric Co. Diorama of days of '49 and city of the future. Shooting gallery, "Electric" demonstrations.

Hobby Show. Miniature railroads, model boats, snakes, stamps, coins and aquariums, Jules Charbneau's collection of 28,500 tiny objects.

Telephone exhibit. Pedro the Voder, to talk and sing, recite nursery rhymes and imitate animals; long distance demonstration; word and tone hearing tests; voice mirror.

General Motors. Talking cars, stroboscopic clock, Jacob's ladder, weighing device, lectures. "Sparky" the horse, new model cars and engineering displays.

Chinese Village. Shops and bazaars, vaudeville, art exhibits, puppet show, flower and tea shops, restaurant and cocktail lounge, jade exhibit.

Petroleum exhibit. Puppet show, "Buoy meets Gull"; magic show, "Oil for Aladdin's Lamp"; graphic displays.

Bank of Tomorrow. Exhibit of Bank of America, streamlined with glass tile counters; lounge and writing room.

Westinghouse. Willie Vocalite the mechanical man with Sparko, the mechanical dog. Science "playground." Model telescope. Movies in color and sound. Television lounge.

Gayway. Lost World, Wild Animal Show, Fun house, Strat-o-ship, ballroom; Nude Ranch, Miss America, Bob Ripley, Candid Camera, Elysium, Glass Blowers, Thrill rides, snake show, incubator babies, etc.

ILLUSTRATIONS OF SUPERIOR CONSTRUCTION



CLEAN, well lighted interiors with maximum ventilation are absolutely necessary for modern food stores. That is why Architect Stiles O. Clements and Ralphs Grocery Company have used Lamella Roofs on so many of their fine stores. Lamella Roofs are lighter, appear less crowded, and are cooler in summer. They actually do provide much nicer surroundings and a more pleasant atmosphere for the transaction of business.



**SUMMERBELL
ROOF STRUCTURES**
LOS ANGELES • OAKLAND • PHOENIX
TIMBER STRUCTURES, INC., PORTLAND

ROOFS OF WOOD—BUILT TO ENDURE



HERRICK IRON WORKS

STRUCTURAL STEEL
REINFORCING STEEL

18TH AND CAMPBELL STS.
OAKLAND, CALIF.
Phone GLencourt 1767

Independent Iron Works

Structural Steel
Ornamental Iron
Steel Service Stations
Steel Tanks
Standard Steel Mill Buildings
Bridges

821 Pine Street Oakland

The Klassen Company

2335 E. 27th Street
LOS ANGELES

Manufacturers of Store Equip-
ment and Architectural
Woodwork

Congratulations to Architect Paul R. Williams, with whom it is frequently our privilege to work!

FORDERER CORNICIE WORKS

Manufacturers of
Hollow Metal Products
Interior Metal Trim
Elevator Fronts and Cabs
Metal Plaster Accessories
Sanitary Metal Base
Metal Cabinets
Flat and Roll Metal Screens
Commercial Refrigerators

269 POTRERO AVE.
San Francisco, Calif.
HEmlock 4100

"AMERICAN MARSH" Redi-Vac Vacuum Heating Pump

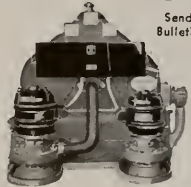

Send for Bulletin 441

SIMONDS MACHINERY CO.
San Francisco Los Angeles
816 Folsom St. 455 East Fourth St.

C. L. PECK

Contractor



Builder of Saks-Fifth Ave.

Store, Los Angeles



354 South Spring Street

MUtual 2367

Los Angeles, Calif.

ALLEN STRUCTURAL PORCELAIN PANS

The ultimate in porcelain enamel construction.

Details and specifications now available.

FRANK ALLEN

Ferro-Porcelain Construction
320 MARKET ST., SAN FRANCISCO

Melrose Lumber & Supply Co.

LUMBER AND
MILL WORK

46th Ave. and E. 12th St.
Oakland

Phone: FRuitvale 0251

Western Pacific. Scenes in action. Animated displays. Feather River canyon and Great Salt Lake.

International Court. Pavilions of Colombia, Ecuador, Peru, Portugal, Uruguay, Switzerland, Malaysia, Japan, Brazil, Czechoslovakia, Italy, Norway, Mexico, French Indo-China. Exhibits of life and culture, mining and travel attractions.

International Market. Rumania, Hungary, Alaska, Brazil, French Indo-China, Holland, Java, Bali, Switzerland, Belgium, Italy, Philippines, Persia, India, Egypt, France, England, South Africa and West Indies represented in former Philippine building. Products from every part of the world offered for sale.

American art. Paintings from artists of each of the 48 states displayed in International Business Machines exhibit.

Pacific Greyhound. Super-coach. Cartoon map. Mechanical displays. Photographs of old-time transportation.

General Electric. Phantom House of 5 rooms built of plate glass and fully equipped. Largest light in the world. Fish-bowl studio of KGEI. Edison's laboratory. Magic Kitchen. House of Magic. Tire-o-scope.

State of California. Exhibits of agriculture, Central Valley project, Education, Industrial relations, Narcotic enforcement, Natural resources and highways, employment, industry etc.

Flower displays. Magic carpet of 25 acres at gateway of Fair. Flanders poppies. Millions of blossoms landscaped into general color scheme. Rare blooms from the Pacific area in the Hall of Flowers.

Treasure House. Displays of gold and silverware; from Egypt, Arabia, Mesopotamia, Transjordan, Nepal, Tibet, Turkey, Greece, Malaysia, China and Japan. The "Wishing Rug." In former Netherlands East Indies building.

Hollywood Show, Stage 9. Movies in the making. Color and sound. A "show within a show."

Santa Fe. Model railroad system valued at \$200,000. Streamliners, safety devices, freight and passenger trains in operation. Scale of 1 to 48.

Temple of Religion. Exhibits of rare books, archaeological items, Biblical garden. Rare carvings and ancient works of art in precious metals. Sunday vespers at 5 p.m.

G. C. HEWITT CO.

Painting Contractors



174 Glendale Boulevard

Phone: MUtual 2505

Los Angeles, California

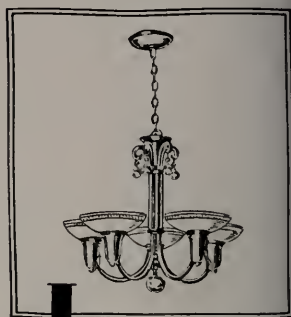

INDIRECT

A fixture to impress your guests with its beauty and your good taste. Your home is only as lovely as its lighting.

So—may we offer the assistance of our "lighting stylists" in selecting the correct fixtures on your limited budget?

**INCANDESCENT
SUPPLY COMPANY**
726 MISSION ST., SAN FRANCISCO

ANDERSON & RINGROSE

General Contractors

320 Market Street, San Francisco
Phone GARfield 2245

BASALITE

CAMBERED
SHINGLE TILE

PERMANENT • FIREPROOF
STORMSAFE • COLORFUL
ECONOMICAL

Manufactured by

Basalt Rock Co., Inc.

NAPA, CALIFORNIA

ARCHITECT
AND
ENGINEER

SAN FRANCISCO
PUBLIC LIBRARY
PERIODICAL DEPT.

JULY, 1940





RESIDENCE OF JONATHAN H. ROWELL, BERKELEY, CALIFORNIA • CLARENCE W. W. MAYHEW, ARCHITECT

How TAN PLASTIC keeps this home DRY and SAFE

Leading Architects Specify It
Competent Builders Use It
Reliable Dealers Handle It



Rightly Used,
It Never Disappoints

"Because the house had to be built extremely rigid and earthquake resistant, four structural U-frames were anchored into and connected by beams in the foundation. • To assure a smooth, dense concrete, easy to pour, Tan Plastic waterproof cement was specified and used in the foundation. • Tan Plastic was also used for a water-tight stucco job."

(Signed) *Clarence W. W. Mayhew*
Architect

PACIFIC PORTLAND CEMENT COMPANY

SAN FRANCISCO •

SEATTLE

COASTWIDE SERVICE

LOS ANGELES •

PORTLAND

RUNNING FIRE

by
MARK DANIELS, A.I.A.

Morals and Money

Lo these many years we have heard the debate on the merits of the moral over the financial obligation and vice versa. The old-fashioned banker, God rest his soul, was prone to prefer the security of a moral obligation to that of a financial one. I am no banker, thank you, and am therefore not qualified to decide which is best in these days. However, I feel safe in calling attention to the few bank failures in the old days of personal notes and word-of-honor security, as compared with the avalanche of failures since the introduction of cash or equivalent securities.

The same principle holds good in the architectural profession. Some architects do their work for little consideration other than the fee. If the fee is fat they do a fat job. If not, they slap out the plan. Others, upon signing a contract, feel that they are under a moral obligation to do the the best job they can, regardless of profit or loss.

In the question of architectural services the client is in the position of the banker and, in my opinion, is much safer with the security of the moral obligation.

* * *

You Say It!

The old proverb of the light under the bushel has taken on an added significance. Nowadays, if you keep your light there, your dinner pail will join it. It's all right to talk ethics but in the same manner that many tetolers die of diabetes, many of our good architects are starving to death on ethical excesses.

Let's speak up. At least we can tell the world, which seems to have forgotten that there is such a profession, that architecture and architects are just as vital to civilization as they were in the days of Ptolemy. We don't have to come out individually and say that this or that one is the only person who can design a dining room that you can eat in without getting gastritis, although some of our leading architects do just that, indirectly. But we can, as a group, tear a page out of the adventures of Ulysses and plug a

little wax in the ears of the public which seems to hear nothing but the siren song of the contractor-designer.

In Los Angeles the architects are telling an amazed world that architects are not a luxury, that they keep their clients out of jams, that the building cost, by their plans, is reduced by a sum considerably more than they get for their work, and that, with an architect, you can see what you are going to get before you get it. If telling these truths to the world is unethical, then we'll have to lie about it or keep our mouths shut, both of which alternatives have been practiced for much too long a time.

* * *

Chinese City Planning

Stealing a jump on the City Fathers, the Chinese J. C. C. is out-planning the City Planning Commission. They have gathered a group of artists, architects, and designers in their organization and these men are now in the process of making architectural studies for the beautification of Chinatown. The studies are in Chinese architectural character and have the benefit of the true Chinese touch of James Lum, an architect recently returned from China.

At the National Planning Conference at the Fairmont Hotel on July 9, 10 and 11, the Chinese Junior Chamber and the San Francisco J. C. City Planning Committee put on a joint exhibit. The Chinese showed studies of possible rehabilitations in Chinatown, prospective reformation of the Greco-French - Roman - Spanish - Chinese architecture now on display to visitors of this district.

Well, if the Chinese can make studies and proceed with a plan for Chinatown, I wonder why the deuce we can't do it too. But then, of course, they had the jump on us by some four thousand years in the arts, literature, science and philosophy. Let's hope it doesn't take us four thousand years to catch up.

* * *

Libation

I ordered my Old Fashioned to the tune of Boogie-woogie on St. Louis Blues. A curved brunette next to me had an Irisher cornered

with the story of her life—I listened. The Little Man siddled up and said, "Eavesdropping is the biggest profession in the world."

I started to explain that the girl was talking loudly, that I was sitting next to her and that it didn't matter much anyway, as the story to date had apparently not been one of a private life—but the Little Man interrupted.

"Every government has an infinitude of spies," he remarked, "to the extent where spies spy on spies that spy on other spies, until eventually this goes to the fifth or sixth order. Politics is overridden with eavesdroppers—words said at a table by a Representative are carefully catalogued, the right people informed and then something happens. The man who can say the most to the people he wants to say something to, without saying it to people he doesn't want to say it to, is the most successful, providing he can find out what the other person is saying when the other person doesn't want him to know. Some eavesdroppers are intentional listeners, either on their part or on the part of the party talking. Mati Hari talked too much to the wrong people—she didn't want to be heard but was. And when the Dinne heard Topanashka of the Quere, the Navajo shot him with an arrow. Even the bartender has sharp ears—whisper that you want a drink and he will bring it; shout for it and he won't. Look at your funny pages: Buck Rogers is besieged by Killer Kane; Superman is following a criminal; Secret Agent X-9 is a spy; everyone is trying to find out something from somebody else.

"Even the gods spied on themselves. Jupiter and Mercury visited Baucis and Philemon in the form of travelers, to learn their hospitality; Procris spied on husband Cephalus, to be killed with a javelin; Actaeon wanted a glimpse of the nude Diana and promptly became a stag."

Putting on my hat, in disgust at not having overheard whether the young girl had gotten her divorce or not, I walked out. As I left, the Little Man was pounding on the bar, shouting for a drink; but the O'Brien paid no attention.

ARCHITECT AND ENGINEER

Since 1905

Volume 142

July, 1940

Number 1

SLIDING DOOR DETAIL, RESIDENCE OF HAROLD V. MANOR	18
Clarence W. W. Mayhew, Architect	
RECENT WORK OF CLARENCE W. W. MAYHEW, ARCHITECT	19
Frederick Jennings	
SAFEGUARDING THE PACIFIC COAST FROM AIR RAIDS	41
Colonel L. H. Stanford	
WELL DESIGNED SCHOOLS RESIST IMPERIAL VALLEY QUAKE	47
INSTITUTE ADOPTS UNIFICATION PLAN	50
Ernest E. Weihe, Architect	
NEW CALIFORNIA STATE ARCHITECT	51
EXHIBITS AT THE FAIR	53
Harris C. Allen, Architect	

PLATES AND ILLUSTRATIONS

RECENT WORK OF CLARENCE W. W. MAYHEW, ARCHITECT	19-40
DETAILS AND MEASURED DRAWINGS	33-40
Clarence W. W. Mayhew, Architect	
PACIFIC COAST AIR DEFENSE	41-43
PHOTOS OF BUILDINGS IN RECENT IMPERIAL VALLEY	
EARTHQUAKE	47-49

NEXT MONTH—SCHOOLS AND OTHER BUILDINGS BY
WILLIAM H. HARRISON, ARCHITECT, LOS ANGELES

(Index to Advertisements—Page 72)

HONORARY EDITORS

Arthur Brown, Jr., Timothy L. Pflueger, Lewis P. Hobart, John J. Donovan, Will G. Corlett, Frederick H. Meyer, Thos. J. Kent, Gordon B. Kaufmann, Ben. H. O'Connor, Michael Goodman, Harry Michelsen.

REGULAR CONTRIBUTING EDITORS

Harris C. Allen, Harry Sanders, Paul H. Hunter, Glenn Stanton, Chas. H. Alden.

EDITOR, FRED'K. W. JONES; ASSISTANT EDITOR, E. N. KIERULFF; CONSULTING AND CONTRIBUTING EDITOR, MARK DANIELS.

ARCHITECT AND ENGINEER is published on the 15th of the month by The Architect and Engineer, Inc., 68 Post Street, San Francisco. President, K. P. Kierulff; Vice President, Fred'k. W. Jones; Secretary and Business Manager, L. B. Penhorwood.

Entered as second class matter, November 2, 1905, at the Post Office in San Francisco, California, under the Act of March 3, 1897. Subscriptions, United States and Pan America, \$3.00 a year; foreign countries \$5.00 a year; single copy \$.50.

Los Angeles office: 832 W. Fifth Street, Bland Ballard, manager.

ARCHITECTS REPORTS are published daily from this office and are sponsored by the Northern Section, State Association of California Architects; Vernon S. Yallop, Mgr.

EVERY ACCEPTED MEASURE OF HEAT LOSS PROVES

SIDEWALLS NEED INSULATION



... and Economy Says—

INSTALL IT WHEN BUILDING!



Russell Mills, arch., planned this handsome home for D. O. Robinson, Reno, Nev. Sidewalls and top-floor ceilings are safeguarded by Celotex Insulation.

CELOTEX GUARANTEED INSULATION REPLACES OTHER MATERIALS — PROVIDES STRUCTURAL STRENGTH, INSULATION, VAPOR SEAL, AT ONE COST!

SIDEWALLS represent definitely large heat-loss areas in a house. They need insulation if the owner is to realize economy of fuel. And economy of construction calls for installing sidewall insulation *at the time the house is built*. By building with Celotex Vapor-seal Sheathing and Celotex Vapor-seal Lath—*both of which replace other materials at small extra cost*—this vital sidewall protection is permanently assured, at minimum expense!

This fact has been emphasized to millions of magazine readers by the current Celotex advertising campaign. That campaign has been planned to make it

easier for you, the architect, to persuade your clients to include sidewall insulation when they build.

By providing structural strength, insulation, and vapor seal—all at a single cost—Celotex Vapor-seal Products are enabling thousands of owners to enjoy the *complete protection* they might otherwise neglect. Further advantages include permanent protection against termites and dry rot, provided in all Celotex cane fibre products by the exclusive, patented Ferox Process—and the famous Celotex *written life-of-building guarantee*.* Mail the coupon for full details.

*This guarantee, when issued, applies only within the Continental United States.

CELOTEX

REG. U. S. PAT. OFF.

BUILDING PRODUCTS

THE CELOTEX CORPORATION AE-6-40
919 N. Michigan Ave., Chicago, Ill.

Please send complete details about Celotex Guaranteed Insulation.

Name

Address

City

County State

The word Celotex is a brand name identifying a group of products marketed by The Celotex Corporation, including

CANE FIBRE INSULATING SHEATHING, LATH, INTERIOR FINISH ASPHALT SHINGLES, SIDING, ROLL ROOFING • ROCK WOOL BATTS, BLANKETS • GYPSUM PLASTERS, LATH, WALL BOARDS

Sales Distributors Throughout the World

An interested audience attended the special preview of Picasso's work at the San Francisco Museum of Art, June 25 from 4:30 to 7:00. This long-awaited exhibit is appropriately titled "Picasso: Forty Years of His Art" and consists of more than two hundred oils, watercolors, gouaches, temperas, drawings, prints, bronzes, collages and other items. Safe to say, it is the largest one-man show of a living artist ever held in San Francisco.

Why is this elaborate showing of Picasso's work an important exhibition? There are several reasons. Primarily, because Picasso, in his successive periods, has such great influence on other artists of all countries. His views and theories of art have penetrated all art of our time, even to a certain extent, acting on the art expression of his opponents in art. From the historical viewpoint, therefore, whether one like or dislikes his work, he cannot be ignored because of this influence.

Many experts in contemporary art consider him great. Without exception, competent scholars conversant with the whole contemporary field in art, think him the most creative force in art of our time, and perhaps the most creative personality in painting that art history records. Many of his works in the various periods have an undeniable mastery and quality. Others seem not so sure, though usually it is possible to discover the particular art problem to which he is applying himself.

The current exhibition is rich in masterpieces, but it also contains many of those studies of various problems which are interesting less for the result than for the insight they permit into his manner of working. Whether many of his devices of expression, especially those of the later periods where he uses several points of view at once, for example—merging profile and front face of a figure—will eventually become part of the general vocabulary of art or will simply remain an interesting idiom peculiar to him, there is no means of knowing. The fine quality of his color when he chooses, and the incredible sureness and eloquence of his line in all his styles are undeniable. To see his work is to see in the person of one man much of the evolution of art of our time.

The exhibit was originally assembled by the Museum of Modern Art in New York, where more than 100,000 people saw it during the 54 days it was open. Similarly, the exhibit drew record-breaking crowds as it was shown in Chicago and most recently in Boston.

In spite of the war risk, the Museum of Modern Art was able to secure some of the most important works from Europe. The largest European lender is the artist himself, with a loan of thirty works. Walter P. Chrysler, Jr., one of the nation's leading collectors of modern art, has made the largest

American loan: thirty-two paintings and drawings and one sculpture.

Art at Treasure Island

Art lovers find much to interest them this year at Treasure Island. To miss one or more visits to the Palace of Fine Arts is to go away from the Island without seeing one of the best features of the Exposition. And that is no exaggeration. In many respects the works of art shown in the Palace this year excel in number and quality last year's exhibition. The show of old masters, for example, includes Flemish, Spanish and French 19th century groups that are definitely superior to those on display in 1939.

There are two hundred old masters and nineteenth century paintings, and an additional one hundred works by the leading European artists of today. Virtually none of these paintings has ever been brought to the West before.

Contemporary American artists are represented in a special group of three hundred pictures.

Practically all the great schools of painting are represented with choice items. The Italian section includes canvases by Pallaiuolo, Fra Filippo Lippi, Titian, Tintoretto, Guardi, and Tiepolo.

In the Flemish group are works by Pieter Brueghel, Van Dyck and Rubens. The Dutch school is splendidly represented with paintings by Rembrandt, Hals, Van Goyen and other seventeenth century artists.

Works by Poussin, Fragonard, Boucher and Nattier are in the French section, as are a number of first rate oils by Carot, Courbet, Renoir, Monet, Manet, Degas, Cezanne and Toulouse-Lautrec.

There are works by Lawrence, Raeburn, Gainsborough and Reynolds in the English section, and two magnificent El Grecos, two Murillos, one Velasquez and three Goyas in the Spanish group.

Ten canvases, among them two Gilbert Stuarts, come from the Metropolitan Museum of New York, which for the first time in the history of this museum, has agreed to lend works from its collections. Other famous institutions that have celebrated paintings in the Old Master show include Yale University, the Kress collection and the Art Institute of Chicago.

Art in Action

With painters, sculptors and print makers busy in the art demonstration project of the Palace of Fine Arts on Treasure Island, a new group of artists has arrived to join them in taking the public "backstage" in the arts to show the layman how art is being made.

Ruth Cravath, the well known sculptor member of the San Francisco Art Commission, has begun to work on a horse's head in pelsite, a hard stone, the texture of which lends itself particularly well to the subject.

It is a dark gray stone with a grain suggesting massiveness. Miss Cravath picked the stone herself in the Montana mountains when she was spending some time at a ranch studying the anatomy of work horses such as the one which serves as model for this sculpture.

Other artists with Ruth Cravath in the Sculptor's Pit of the Active Arts Plaza include the well known Dudley Carter, whose impressive Mountain Goat, hewn out of solid redwood timber, is taking final shape; Fred Olmsted and his assistant who, with tireless zeal, are forming their ten-ton block of limestone into a gigantic head of Leonardo da Vinci; and Cecilia Graham, who is doing clever and sophisticated clay modeling.

In the field of crafts, Eloise Krysiak of San Francisco is demonstrating block printing for table linens. She is working on a design of coffee berries, for use on a breakfast tray cloth.

The interrelationships between the various crafts is actively demonstrated by Bernice Band, Associate Professor of Related Arts at Oregon State College. Miss Band is not only weaving upholstery fabrics, but is also engaged in screen printing of materials for draperies and in hand tufting of rugs.

Jane Wilhoit of Bolinas, California, is cutting stylized figures of animals and people out of sheet metal: copper, brass, and aluminum.

Meanwhile, Diego Rivera, greatest of all living muralists, is finishing the preliminary sketches for the huge mural on the north wall of the Active Arts Plaza at the Palace of Fine Arts. Upon Rivera's request, the size of the mural has been enlarged from 45 to 75 feet in width, in order to give him added space to express the full meaning of his mural composition which will symbolize the fusion between the traditional elements of Mexico's civilization with the high technical accomplishments of our own.

Federation of Arts

Upon the invitation of Dr. Grace L. McCann Morley, Director of the San Francisco Museum of Art, the American Federation of Arts, of which Dr. Morley is vice-president, held its first West Coast meeting in San Francisco, July 11, 12 and 13.

The convention considered topics of both national and regional character. On the opening day, July 11, the program was devoted exclusively to a subject considered by art leaders to be of increasing importance in light of the expanding art interest throughout the country—"Art Education in the United States."

The symposium included a survey of the whole field of art education, commencing with primary and secondary school, proceeding through high school and preparatory.

(Turn to Page 12)

HERMOSA TILE

INSURES QUALITY AND PERMANENCE

KITCHEN is no longer a dark, uninteresting workshop. The modern housewife demands her kitchen to be the brightest and most cheerful room in the house. The use of Hermosa Tile will result in a job that will remain forever a thing of beauty and satisfaction.



BATH in the house of today can certainly be made one of the most attractive points in the home with the use of Hermosa Tile. The modern interpretation of this material includes many shapes, glazes and surface textures that are most adaptable to any type of design.

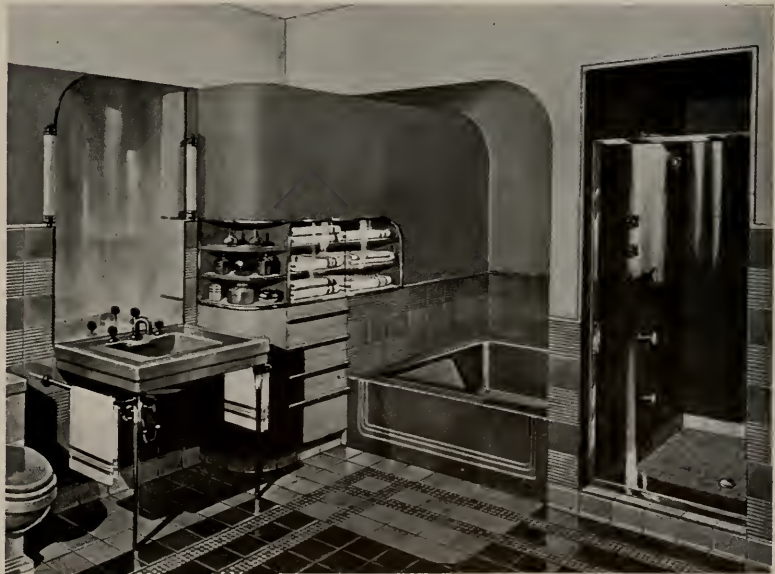

GLADDING, McBEAN & CO.

LOS ANGELES · SAN FRANCISCO · SEATTLE · PORTLAND · SPOKANE · DALLAS · DENVER · HONOLULU, T. H.

A new idea for a Store front . . .



*Chestnut Tree Inn, 826 Market Street, San Francisco.
Designed by Frank Stauffacher and Henry McChesney.*

Actual photograph of a San Francisco restaurant front, showing possibilities of an unusual color design treatment for a permanent exterior surface . . . the sturdy Chestnut tree in the foreground is part of this cleverly designed front . . . lasting and colorful . . . built of

ALLEN STRUCTURAL PORCELAIN PANS

(Patent applied for)

FRANK ALLEN
320 MARKET STREET
SAN FRANCISCO SUTTER 8236

The new Union Pacific R. R. Offices illustrated on opposite page is another Frank Allen Ferro-Porcelain job.

PORCELAIN ENAMEL FOR EXTERIORS

A comparatively new building material that ties in splendidly with modern design, is porcelain enamel which lends itself admirably to almost any exterior color scheme, is permanent, easily handled and inexpensive. The successful use of porcelain enamel is due largely to Allen Structural Porcelain Pans and Allen Lock Clips, improved methods, aided in their manufacture by the testing laboratories of the steel companies, the unlimited facilities of the enamel manufacturers, and the cooperation of the fibre products and elastic cement companies.

Allen Structural Porcelain Pans offer a building surfacing material for permanent exterior and interior finish with an unlimited choice of colors, textures and forms long sought after by architects and builders. Competent trained engineers are employed to handle large or small jobs. Allen's workmanship is backed with the longest record of uninterrupted and specialized porcelain enamel construction of any organization on the Pacific Coast.

Recent outstanding contracts awarded for Allen Structural Pans include the following:

Chestnut Tree, Inc., stores at 826 Market Street and 47 Kearny Street, San Francisco, both of which embody the most elaborate color design on any small storefront.

Union Pacific Railroad Company ticket offices, one at Powell and Geary Streets, San Francisco, and one at Broadway and Southwest Washington Streets, Portland, Oregon, embodying the use of the largest full-porcelain one-piece letters ever manufactured.

North Pole Bakery, two-story store and office building at Fairbanks, Alaska. This is the first exterior porcelain enamel work to be installed in the Alaska territory and is built to stand the most severe weather treatment, the temperature varying from 70 degrees above zero in the summer to 70 degrees below zero in the winter.

Grass Valley Memorial Hospital, Grass Valley, California. This is a five-story all-steel hospital building of approximately 150 beds and is said to be the largest installation of exterior porcelain enamel work so far attempted anywhere.

POURING CONCRETE ON SHASTA DAM

Actual building of the second largest masonry dam in the world, as a water conservation structure for one of the nation's most important agricultural areas—the Central Valley of California—was begun on the upper Sacramento River near Redding, July 8.

Almost 4,000,000 cubic yards of earth and rock have been removed from the site of Shasta Dam since work was started in September, 1938.

Concrete placement also was started this month on Friant Dam, the other Central Valley Project storage dam located on the upper San Joaquin River near Fresno. Friant will be the fourth largest concrete dam in the world.

Union Pacific Streamlines New Office with *Low Cost* Porcelain Enamel



STREAMLINED SPEED is suggested by this new office of the Union Pacific Railroad on the corner of Geary and Powell Streets, San Francisco, Calif. Credit for the design belongs to Mr. R. C. Williams, Mr. A. R. Williams of Williams and Grimes, San Francisco, was the supervising architect. The porcelain enameled panels and letters were detailed, furnished and installed by Frank Allen, Ferro-Porcelain Construction. The enameling was done by Ferro Enameling Company of Oakland, Calif., on U·S·S VITRENAMEL sheets; general contractors, Lindgren and Swinerton, of San Francisco.

IN keeping with its policy of using the newest materials and latest equipment, the Union Pacific Railroad chooses porcelain enamel for its new San Francisco office. The characteristic colors of the road are carried out in red letters on a yellow background, the whole set off by a grey cornice and bulkhead. Even the red, white and blue shield is executed in durable porcelain enamel.

Any design is easily reproduced at low cost in porcelain enamel, because the steel base is inexpensively formed.

Construction costs are low. Light in weight—less than three pounds per square foot — porcelain enamel is easily handled. Concealed mechanical fastenings support each panel independently, producing a permanent, attractive job, firmly anchored.

No other structural material possesses such versatility. Striking effects are accomplished simply, with an almost unlimited choice of colors. And with only ordinary care its beauty remains unaffected by time.

Porcelain enamel is adaptable to

almost any purpose—interior or exterior. It is equally good for new work or remodeling; on masonry, wood or steel construction. For complete working details be sure to refer to the Don Graf Data Sheets. Copies are available on request.

Always specify the base metal. U·S·S VITRENAMEL Sheets are specially made for porcelain enameling. They are uniformly flat and have the necessary ductility which makes shaping easy. Their prepared surface assures better enameling.

U·S·S VITRENAMEL SHEETS

COLUMBIA STEEL COMPANY, San Francisco, Pacific Coast Distributors of U·S·S VITRENAMEL Sheets

Manufactured by

CARNEGIE-ILLINOIS STEEL CORPORATION, Pittsburgh and Chicago

United States Steel Export Company, New York · Scully Steel Products Company, Chicago, Warehouse Distributors



UNITED STATES STEEL

I CAN'T DRAW PEOPLE

By CLYDE TRUDELL

I can't draw people.

I can draw thread as fine as gold,
But I can't draw people, hot or cold.

I can draw two cards to an inside straight,
But I can't draw people, early or late.

I can draw flies, crowds, butter and water,
But I can't draw people as I oughter.

I can draw houses, factories, saloons and
banks,
But people I draw all come out blanks.

I can draw conclusions, apt as the next,
But I can't draw people and that's why I'm
 vexed.

I can draw plans, sections, elevations and
details,
But I can't draw people, the outsides or en-
trails.

I can draw a bead on a bird at four and
twenty paces,
But people I draw have something wrong
with their faces,
and other places.

I can draw parabolas, hyperbolas, apple,
peach and octupi,
But I can't draw people and, to save my life,
can't tell why.

I can draw the shortest distance between
two or more points,
But people I draw have grave disorders in
their joints.

I can draw the Great Bear, the Big Dipper
and the North Star,
But I can't draw people, I mean as they
really are.

I can draw out savings, checking, joint and
commercial accounts,
But I can't draw people, afoot or on mounts.

I can draw rhomboids, spheroids, dodeca-
hedrons and trapezoids,
But I can't draw people, not even their ade-
noids.

I can draw a deep, shallow, medium deep,
or passing shallow breath,
But I can't draw people, alive, dying or in
death.

I can draw the long bow, the short straw,
the odd gal old and fat,
But I can't draw people, and that is defi-
nitely that.

I can draw a red herring across a path, or
from a hat draw out a white rabbit,
But I can't draw people—in fact, for me,
not drawing them is a habit.

I can draw to one side, in fact either side,
or both sides at once in a pinch,
But I can't draw people, I know, I've tried,
Not drawing them is a cinch.

Other folks can draw people, nice as you
please.

Complete with noses, necks and knees,
Running a race or painting a steeple,
But as for me, I just can't draw people.

MURDERED MODERN

To the Editor:

In the first stages of the movement to eliminate gingerbread, gadgets and gew-gaws in architecture in this country, a movement that was old abroad, a number of the profession quickly adopted a certain element of design and rubber-stamped all plans that embraced it "Modern." That element of design was the aluminum-painted, horizontal gas pipe. Any building that incorporated this beautiful, new and thrilling "motif" was modern. Why, you could see at a glance how modern it was, and the more pipes, the more modern.

This great stride in the advance of building design was to revolutionize the art. All you needed to do was to bend a lot of pipes horizontally around corners, across windows and along corridors and you became a modern. Of course, if you were ultra and had the real gift you would put them in groups of three.

Finally space, and possibly pipe, was exhausted. Undismayed, this group of moderns resorted to painting horizontal strips on their buildings. They painted them on electric signs, half way around door jambs, anywhere there was room. Yes sir, they were modern, and modern was here to stay. But strange to say, the stupid public began to sense a lamentable paucity of charm and a definite feeling of monotony in this treatment of surfaces. So, the pseudo moderns developed a new, and equally useful, motif.

Of late, the hall mark of the modern is a vertical element sticking up in the air from a building of horizontal lines. It does not need to be any functioning part of the building nor in any particular location, so long as it sticks up in the air. Its use is generally as sign board, or something on which may be hung an electrical display. It has become the symbol of the drive-in market and the gas station. It gives the city the lovely effect of being forested with decapitated poles and pilons.

All this silly effort to make a building look modern whether it is modern or not is like trying to make a horse function as a cow by tying an udder under him.

Real modern architecture, as I see it, is that which results in a building constructed for domestic or commercial uses as they exist today, untrammelled by tradition. If we should begin to live on tablets, eating no other food, as the scientists predict, there would be no use for a kitchen. If we have an automobile we want a garage. We may yet learn that artificial light and ventilation is better than nature's.

Traditional architecture is beautiful in its place, particularly in the domestic field where the client has most to say about the style, but putting a gothic exterior, frosted

with crockets, carved corbels, and pointed arch windows, on a warehouse seems to me like wearing a coon skin coat in the tropics. If you really want to be modern don't depend on a new style of gingerbread. Design your building for conditions as they exist today or maybe tomorrow and try to forget what they did a century ago.

M. D. NIELS.

San Francisco, July 1, 1940.

ARCHITECT OF PAYNE RESIDENCE

To the Editor:

Enclosed is a copy of letter sent Mr. Paul Williams regarding the William Payne residence of Atherton, which was incorrectly published in the June issue of Architect and Engineer as his work.

I hope this will be corrected in a future issue of your magazine.

I am still enjoying your magazine, as I have for many years.

Yours very truly,

ARTHUR D. JANSSEN.

San Mateo, June 26, 1940.

Mr. Paul Williams,

3839 Wilshire Boulevard,
Los Angeles, California.

Dear Mr. Williams:

I had the pleasure of seeing your fine work featured in the June issue of the Architect and Engineer, but I was very much surprised to see the Payne residence, which I had designed, shown as your work.

I had been the victim of circumstances on this project. You were brought into the picture when the project was nearing completion, to make some changes in the interior; also a change in the entrance doorway and, I believe, some other minor changes. I am sure you never intended taking full credit for this work and probably did not wish it published with that intention.

I sincerely wish you continued success in the fine work you are doing.

Yours very truly,

ARTHUR D. JANSSEN, Architect.

MANY READERS

To the Editor:

I did not know so many people read the Architect and Engineer. I have been receiving so many letters from architects, together with laymen, commenting on the June issue.

I also wish to thank you for the splendid manner in which the entire subject was presented, as I think you did a swell job.

Just by way of suggestion for one of your future issues, have you ever thought of contacting the Art Department of some of the major studios with the thought of publishing photographs of their outstanding sets? I think it is a pity that a record of these is not collected and presented so that the profession might see it.

Cordially,

PAUL R. WILLIAMS, Architect.

Los Angeles, June 29, 1940.

FIRST AMONG 2,000

✓ ✓ ✓ *this ALL-GAS prize home**

Designed for its mountain setting, this home of architect-owner HAROLD J. BISSNER, in Altadena, features 20th-century comfort. ☆ Hence, gas cooking, heating, refrigeration and water heating . . . all four major household jobs *streamlined* by automatic control for convenience, economy and livability. ☆ When you plan new construction, use your Gas Company's technical advisory service—free to Architects and Owners.

**First award, \$1,000, was given the Bissner home for the ideal all-gas installation, in a recent nation-wide contest with 2,000 entries.*



LET GAS THE MODERN
FUEL DO THE 4 BIG JOBS

COOKING ★ WATER HEATING ★ HOUSE HEATING ★ REFRIGERATION

NOBLESSE OBLIGE

In the days when the phrase "Noblesse Oblige" was coined, it was taken for granted that members of the nobility owed certain obligations to those of lesser rank. Of course we have no such class distinctions in America, but we do have the learned professions and the doctrine of Noblesse Oblige applies just as much to them as to the nobility.

Clients trustfully take for granted that a doctor or an architect is omniscient at least in his own field, and few would question his judgment.

Justifiably or not, a client loses his complete faith in his architect's abilities if he finds, for instance, that the architect has neglected detailed plans for the electrical service.

If the client finds that suitable switches have not been provided for turning lights on and off without traversing dark areas, if outlets have not been provided at every point they are needed, or if suitable lighting is not included in the plans, his faith in the architect is badly shaken.

Electrical service today is the vital life-blood of a home, and has assumed a more important place than ever before. Adequate electrical service is now a necessity, and if the architect is to hold his client's regard and good-will, he must include proper wiring in his plans.

A special Architects Specification Sheet has been prepared for quick reference in preparing home wiring plans.

Write or 'phone for your free copy.

PACIFIC COAST ELECTRICAL BUREAU

447 SUTTER STREET • SAN FRANCISCO, CALIFORNIA

AQULUX 85

NEW Oil Burning Water Heating Unit

This powerful and compact vertical unit, beautiful in appearance, is designed to supply hot water at minimum cost in the modern home. It can also be used to supply heat and hot water automatically for small homes without the necessity for basement installation. Complete data on this new "package unit" now ready.

Burns No. 3 C. S. G.
fuel or Diesel oil

S. T. JOHNSON CO.

940 ARLINGTON, OAKLAND, CALIF.
401 N. BROAD ST., PHILADELPHIA, PA.

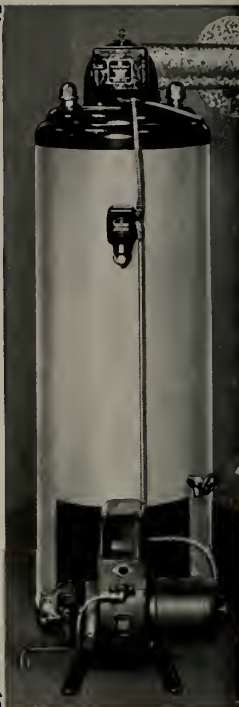

When you are Building Material minded think of GUNN, CARLE

Time has proven the worth of their goods

BULL DOG CLIPS



Securely anchor sleepers in concrete slabs.

CABOT'S BLEACHING OIL

permanently preserves wood exteriors, giving that soft, weather-beaten silver grey effect.

VENETIAN BLINDS

Afford Light and Air
without draft or glare.



GUNN, CARLE & CO.

SAN FRANCISCO
20 Potrero Avenue
Underhill 5480

USE "Pennvernion" ...
NOT JUST "WINDOW GLASS"



WINDOWS are no better than the glass with which they are glazed. The use of Pennvernion Window Glass insures windows which are exceptionally transparent, which permit clear, satisfying vision and which add to the appearance of a home by their brilliant, reflective surface finish.

DISTRIBUTED BY

W • P • FULLER & CO

BRANCHES AND DEALERS THROUGHOUT THE WEST

TELESIS

A number of young planners, architects, landscape and industrial designers in the San Francisco Bay region have formed a group, to be known as Telesis. According to Webster telesis means: "progress intelligently planned and directed; the attainment of desired ends by the application of intelligent human effort to the means." The group is interested in careful and continued research into all the phases of our physical environment, and the factors which form it. The members are aware that the social and economic forces under which we live are not the same as those which formed our present surroundings. They feel that the success of all our future development hinges on careful study of these changing forces.

At the invitation of the San Francisco Museum of Art Telesis is planning an exhibit, to be shown during August. This exhibit will present an analysis of man's present living conditions and suggest ends and means for their improvement. The analysis will be based on a study of man's needs, the geographical nature of the localities in which he lives, and the technical possibilities he has developed. The basic relationship between land and people will be emphasized. The main body of the exhibit will deal with the breakdown of their environment into space for working, living, and leisure, all integrated by service facilities. The conclusion will promote the use of existing legislative machinery for the improvement of our surroundings.

After the exhibit the group plans to continue with a careful and thorough study of the possibilities for development inherent in the San Francisco Bay Region, considered as an environment for the life of man. It is expected that further exhibits will summarize the results of this research from time to time. Telesis is interested in correspondence and co-operation with all individuals and groups whose objectives are similar.

FRESH TECHNIQUES IN DESIGN

The function of the independent architect in the field of design as it is affected by the current accelerated activity in housing throughout the country has given rise to new

problems for which the A. I. A. is seeking solution.

Mass production techniques as necessarily employed in large scale housing where heavy capital outlays and thousands of dwelling units are involved, naturally result in a repetition of design. It is true that building costs must be kept at a minimum to keep rents at a minimum, but it is also true that sameness makes for dullness. Ever fresh techniques in design are needed.

"If uniformity in large scale housing projects becomes accepted as necessary, the function of the independent architect will become affected, perhaps curtailed," opines Wm. F. R. Ballard, a New York City architect, who says "it behooves the architect to find a solution which will reconcile variety of design to minimum cost. He must evolve fresh designs for large developments which, without adding to building cost, will lend themselves to creation of stimulating architectural effects. He must not rely on his present knowledge of the field, but must constantly seek new ideas to prove his worth."

PASSING OF PROMINENT ENGINEER

Raymond F. Walter, engineer in the service of the Bureau of Reclamation for 37 years and its chief engineer for the last 15 years, died June 30 of a heart attack in Fresno, Calif. He was 66 years old.

Mr. Walter had not been feeling well for some time, and late this spring illness compelled brief absences from his office at his Denver, Colo., headquarters. Feeling better, he visited the construction work in progress at Friant Dam on June 29, and became suddenly ill there. Taken to a hospital in Fresno, he died during the night.

John C. Page, commissioner, Bureau of Reclamation, in notifying Secretary of the Interior Harold L. Ickes of the chief engineer's death, said:

"With deep regret I must tell you that the Bureau of Reclamation has lost its most valued employee, Chief Engineer Raymond F. Walter. His death leaves a gap which can never quite be filled. Mr. Walter was the country's recognized authority on heavy con-

struction. The Bureau will miss him sorely. He was respected and loved by all of us who had worked with and for him these many years."

Secretary Ickes said:

"The death of Chief Engineer Walter, after a lifetime of service to the Bureau of Reclamation and the Department of the Interior, is a severe blow. For 15 years Mr. Walter had been in active charge of what is generally recognized as the greatest engineering office in the world—the Denver engineering headquarters of the Bureau of Reclamation. His services were outstanding. His unflinching loyalty to his organization, to his Bureau and his Department, and to the United States Government, has provided an example for the thousands of younger men working under him."

Mr. Walter was born in Chicago, Ill., October 31, 1873. His father was a printer and publisher who moved the family to Colorado by covered wagon during the gold rush of the late seventies, when Mr. Walter was five years old.

The construction of Grand Coulee Dam in Washington and Shasta Dam in California, largest and second largest concrete dams in the world, was begun under Mr. Walter's guidance.

LIFE 1940 HOUSES

Continuing its program of informative data and active cooperation in home building, Life magazine, in its July 1 issue, announced that 121 Life 1940 houses are today being built in 73 cities, towns and communities of the United States and Canada; that many others are planned and that 51 of those completed have been furnished for demonstration purposes by 31 department and furniture stores, involving an investment of more than \$1,000,000.

The 1940 Life houses, already an accomplished fact in wood, brick, stucco and stone, are displayed in a 15-page portfolio.

A house by Gardner A. Dailey of San Francisco is included in the 1940 house showing. It is designed for the man with an income of from \$2300 to \$3000 a year.

FEDERATION OF ARTS

(Continued from Page 4)

college and university, graduate school, professional art school and museum. The successes and failures of both traditional and progressive systems of art education were brought into the open. Following the symposium the meeting was turned into an open forum.

July 12 was spent visiting San Francisco's art centers of the Exposition on Treasure Island. As on the initial day, the final session on July 13 centered on a single topic—"The Rise of Art in the West"—"West" meaning west of the Mississippi. Leading off with architecture, the session continued with developments of painting, the craft movement, the growth of museums and schools, collecting and the moving picture.

SEND FOR THIS FIREPLACE BOOK— it is



the result of 19 years' experience in fireplace heating engineering.

It contains 32 pages of interior installation photographs and other very valuable fireplace information.

Single courtesy copy to architects, builders, contractors and building supply dealers who make request on their letterhead. For additional copies please enclose 25c per copy to cover handling cost.

SUPERIOR FIREPLACE CO., 1046 South Olive St., Los Angeles, Calif.
Pioneer Builders of Heat Circulating Fireplaces

When you want weather-proof exteriors, specify **EXT-DFPA**

the type of Douglas Fir Plywood made for permanent exposure to weather and water!

EXT-DFPA is widely used for modern streamlined residences, stores, service stations!

EXT-DFPA—the exterior type of Douglas Fir Plywood—is made with synthetic resin binder, hot-pressed under hydraulic pressure to form panels that are guaranteed by the manufacturer against ply separation due to moisture or any sort of weather condition. All EXT-DFPA is made in strict accordance with U. S. Commercial Standard CS45-38 and is edge-branded with a distinctive "grade trade-mark" for easy specification and identification.

EXT-DFPA is unsurpassed for use as exterior finish on residences, stores, service stations, warehouses, farm and other buildings . . . for signs and displays, boats, refrigerator cars and boxes, milkhouses, auto trailers, bus bodies and floors, gusset plates for bolted and ring-connected joints in trusses for roofs and bridges. EXT-DFPA is made in a variety of thicknesses and sizes and in several appearance grades. All progressive lumber dealers handle it.

For your information, consult Sweet's Catalog or write for any of this free literature: Suggested Specifications for Douglas Fir Plywood; Commercial Standard CS45-38; Construction Manual for Douglas Fir Plywood Dri-Bilt Houses; or Finishing Booklet, Douglas Fir Plywood Association, Tacoma Bldg., Tacoma, Washington.



RESISTS HURRICANE AND SALT WATER

Built in 1936 and located near the ocean, neither the salt-laden storms, heavy logs nor the September, 1938, hurricane had any effect on the EXT-DFPA exterior of this residence in Marblehead, Mass. It was designed by Donald Chapin Goss for John T. Robbins. 3/4" 5-ply was specified.



SPECIFIED BY AIR CORPS

More than 1,000,000 sq. ft. of EXT-DFPA were used in the Army Air Corps' emergency barracks building program undertaken at 11 air fields in August, 1939. Economy, speed of erection and permanence were the reasons for the selection.

Left: IDEAL FOR ALL BOATS

More and more boats, from dinghies to cruisers, are being built every year of EXT-DFPA, each a testimonial to its water-proofness.



Left: LOOK FOR THIS EDGE BRAND

Every genuine EXT-DFPA panel has this "grade trade-mark" stamped on its edge. Specify and insist on it . . . for it's your protection.



DOUGLAS FIR PLYWOOD
Real Lumber
MADE LARGER, LIGHTER SPLIT-PROOF STRONGER



SPECIFY DOUGLAS FIR PLYWOOD BY THESE "GRADE TRADE-MARKS"

PLY-PANEL D.F.P.A.

EXT. - D. F. P. A.





As Specified
by
MAYHEW

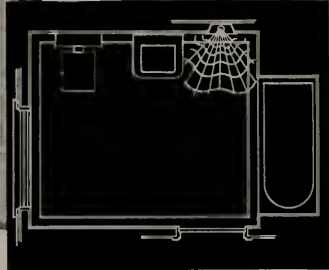

NEW WESIX "PERFECT THIRTY-SIX"—
fits perfectly into 42-inch wainscots.

WESIX electric bathroom heaters were used in all of architect Mayhew's houses featured in this issue of Architect and Engineer. "Perfect bathroom heating," says Mr. Mayhew, "calls for the Wesix Perfect Thirty-Six, built into wall facing drying zone." Write for details to Wesix Electric Heater Co., 390 First Street, San Francisco.

WESIX

World's Largest Manufacturers of Major Electric Heaters

CLARENCE W. W. MAYHEW
ARCHITECT

June 17, 1940

The Pomona Tile Co.
629 North La Brea Ave.
Los Angeles, California.

Dear Sir:

Some years ago I had the interesting experience of seeing the process of making tile at your Pomona plant. During my visit I talked with one of your plant foremen. With the pride of a true craftsman for his work, he told me how Pomona Tile was made, from beginning to end. He finished by saying, "If you want to make a good product, you have to be honest and put good things into it; material and workmanship alike".

When writing specifications for tile work, I always recall that conversation. Your foreman was a good salesman for Pomona Tile. I have been specifying Pomona Tile for twelve years, and to date I have no reason to doubt the honesty of your foreman.

Yours very truly,

712 Montgomery Street
San Francisco, Calif.

ARCHITECT MAYHEW'S LETTER

confirms our belief, that it pays to constantly improve our product so that Pomona Tile is better each year.

• Pomona "Space-Rite" Tile, New Crystal Glaze Floor Tile, and Pomona's Full Vitreous drainboard tile and trimers are some of the many features that win new friends and justify continued faith by users of Pomona Tile Products.

POMONA TILE MANUFACTURING CO.

629-33 N. La Brea Avenue
Los Angeles, Calif.

135 Tenth Street
San Francisco

PLANT
POMONA, CALIF.

6106 Roosevelt Way
Seattle, Wash.

HOME TO STAY—FOREVER'N A DAY

THE name "Dunmovin" for a home, in which the owners really expect to stay, has been used on country places before, but a metal silhouette that symbolizes the name in an original manner appears over



CLOSE UP OF METAL SILHOUETTE

the doorway of the home recently built for Dr. and Mrs. N. A. Bowers at Atherton.

The silhouette depicts the most typical act of moving—carrying a trunk—and the spirit of the occasion is carried out even by the family cat with her kitten. Although the scene portrayed is in no sense a funny thing and, on the contrary, is a most serious event, yet when coupled with the name below the silhouette, gives an impression that almost invariably surprises the stranger into a laugh. He sees at once that the griefs and tribulations of moving (of which he probably knows only too well) have driven these people to a declaration of intention in the name of the new home.



SILHOUETTE AT RIGHT OF FRONT ENTRANCE

Some have pointed out that, judging from the silhouette, this must be a family in which the wife enjoys moving. She certainly is going about it with much

verve and, presumably, by her enthusiasm has overcome the discouraging reaction of her husband who appears none too cheerful about lugging his end of the trunk. Bringing up the rear, the proudly erect tail of the cat puts the stamp of great confidence and approval on the move.

The silhouette cannot tell the whole story, however, for there is much homey attractiveness in the new domicile and the visitor readily agrees that the owners probably are through with moving. The house centers about a large living room opening out onto a sheltered terrace at one side of a wide garden graced by enormous oaks and attractively landscaped. The area included is just one acre, arranged to provide ample space for expansion of the landscaping.

Going back to the silhouette, possibly some of our readers may have similar ideas that would help new home owners to add a touch of practical originality to their abodes. If so, a snapshot or two mailed to the editor may start an interesting and unique new feature to these pages.

ARCHITECTS' SUMMER OUTING

The regular Tacoma outing of the members of Washington State Chapter and the Tacoma Society of Architects, was held at Tacoma, Saturday, June 22. The program included a visit to the historical spots of old Steilacrom and a stag dinner at McChord Field.

BAXCO

CHROMATED ZINC CHLORIDE

CZC

PRESSURE TREATED LUMBER

● **PROTECTS AGAINST DECAY
AND TERMITE ATTACK**

Specify it in your home

Available through Lumber Dealers

LOS ANGELES

601 W. 5th Street
Phone Michigan 6294

SAN FRANCISCO

333 Montgomery Street
Phone DOuglas 3883

J. H. Baxter & Co.

AGENTS FOR WEST COAST WOOD PRESERVING CO. SEATTLE, WASH.



Clarence W. W. Mayhew, Architect

SUNSET HOUSE THAT 300 WOMEN HELPED TO DESIGN

Equipped with
PITCHER INTERIOR DISAPPEARING DOORS



E. C. Pitcher & Co.

557 Market Street, San Francisco

Phone YUkon 1543

See our exhibit in the Homes and Gardens Pavilion,
Golden Gate International Exposition

Efficiency Too!

It isn't enough that the BILTWEL Furnace should have an unusually attractive exterior appearance. Its streamlined beauty betokens other things. Scientific design, with large heating surfaces, gives durable, efficient service. Pressed steel sections of the BILTWEL, welded into one piece, give rigid construction, offer minimum resistance to air flow.

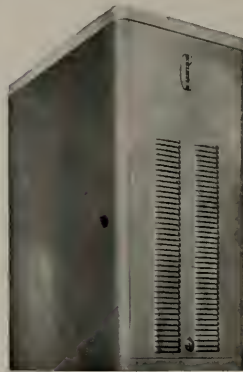

Our literature explains 16 points of superiority of the BILTWEL AIR CONDITIONING FURNACE.

Fraser & Johnston Co.
725 POTRERO AVE.
SAN FRANCISCO

Manufacturers of
BILTWEL
and
TORIDAIRE
GAS FURNACES

Finish Hardware



in the beautiful homes
illustrated in this number
and designed by Clarence
W. W. Mayhew,
architect.



furnished by

MAXWELL HARDWARE CO.

14TH AND WASHINGTON STREETS
OAKLAND

No Worry for the Architect

"—All acid proof drain pipe and fittings
shall be ferro-silicon—CORROSIRON—"

(Write for above specification)



FEDERAL BUILDING • CIVIC CENTER • SAN FRANCISCO

Arthur Brown, Jr., Architect

CORROSIRON DRAIN LINES and FITTINGS
and LABORATORY EQUIPMENT was specified because of its superior resistance to corrosion and wear.

Pacific Foundry Company, Ltd.

NEW YORK • 3100 NINETEENTH ST., SAN FRANCISCO • LOS ANGELES

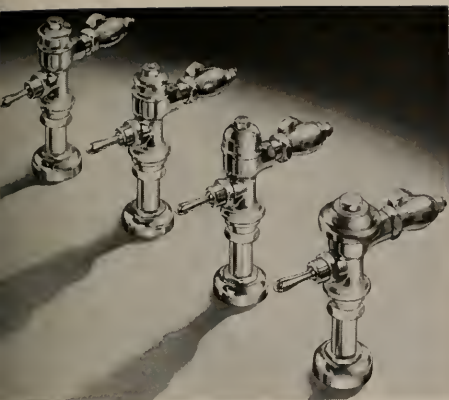

SPECIFY *Silence*

• There is no reason, now, for installing noisy flush valves or plumbing that will telegraph the roar of rushing water throughout the building. Modern plumbing *can* be quiet—so noiseless, indeed, that the sound of a toilet bowl flushing cannot be heard through a closed door.

• Architects everywhere are specifying Sloan *Quiet-Flush* Valves. Literally thousands of installations have proved that Sloan *Quiet-Flush* Valves reduce the sound of running water to scarcely a murmur. —And they *stay* quiet, too, because no water flows through screens, perforations or obstructions which could clog. The silencing elements in Sloan *Quiet-Flush* Valves are constantly washed clean by the action of the water itself.

• When you specify Sloan *Quiet-Flush* you get more than silence—you get nationally recognized Sloan superiority in the construction of the valve itself. During the past 34 years Sloan valves have proved themselves so economical of water, so resistant to wear, so low in maintenance cost that today more Sloan Valve Valves are specified and installed than all other makes *combined*. The many thousands of *Quiet-Flush* installations throughout the country have again demonstrated that *any* Sloan product has *Sloan* quality—the unequalled standard by which all other flush valves are judged.



SLOAN VALVE COMPANY
4300 WEST LAKE STREET • CHICAGO

SPECIFY *Safety*

• All water-borne diseases and many intestinal disorders may be transmitted through unprotected plumbing. We all know, too well, the costly (and needless) epidemics of dysentery in hotels, hospitals, schools and other buildings because of water pollution through back-syphonage.

• "Needless" epidemics—because Sloan offers complete, positive protection against back-syphonage for a wide variety of fixtures, Sloan *Quiet-Flush* Valves can be furnished with the V-100-A Vacuum Breaker as an integral part thereof. Specify Sloan *Quiet-Flush* Valves with integral vacuum breaker and give your client positive protection against back-syphonage.

• The Sloan "V-100-B" Vacuum Breaker is an inexpensive device designed to prevent back-syphonage in fixtures having small supplies and low rate of flow. There are scores of places in restaurants, bars, beauty parlors, hotels, hospitals, clubs, laboratories, etc., that need the new Sloan V-100-B Vacuum Breaker for protection against water pollution.

• And in Sloan Vacuum Breakers you naturally find *Sloan* quality. They are not only fully approved by health authorities everywhere, but bear the seal of acceptance of the National Plumbing Laboratory maintained by the National Association of Master Plumbers at the University of Iowa, under the direction of the Dean of the College of Engineering. Protect all danger spots.

SLOAN VALVE COMPANY
4300 WEST LAKE STREET • CHICAGO

SLOAN *Quiet Flush*

SLOAN VACUUM
BREAKERS



PHOTO BY RODGER STURTEVANT

SLIDING DOOR DETAIL, RESIDENCE OF HAROLD V. MANOR, CONTRA COSTA COUNTY
CLARENCE W. W. MAYHEW, ARCHITECT

RECENT WORK OF CLARENCE W. W. MAYHEW, ARCHITECT

By FRED'K JENNINGS

ARCHITECTURE today, to be truly modern and distinctly American, must be original, individual and honest in design. It should not only reflect the character of our times, but it should recall our past heritage, to a greater or less extent.

More reference is made to "style" today than ever before. Probably because, shall we say, there is none. We hear constant reference to "modern" and "functional" with only occasional allusion to the classic, Italian, English, French, Spanish and California-Colonial. This word "modern" is being used to cover a lot of ground. A multitude of sins, somebody has said.

But it has afforded the architect the opportunity he has been looking for. An opportunity to design along original lines. An opportunity to develop a "new" style. If it's a design by Jim Brown and we ask him to name the style he has chosen, his answer, somewhat guardedly, is: "No style in particular, just call it Jim Brown." If he is not of the old school you may safely classify him among the moderns.

In the work of a young San Francisco architect, illustrated somewhat fully in this issue, we note an individuality and honesty in design that would seem to bear out our opening thought. There is no self-conscious desire for attention reflected in Clarence Mayhew's work. His designs are straight forward, simple, developed with complete unity of thought. The style of other designers, either here or abroad, if used at all, is of secondary importance to Mayhew's own originality and efforts to successfully solve the multitudinous problems of his clients.

We detect a leaning towards Japanese architecture in some of the Mayhew residences. In explanation, the young San Francisco architect says the use of certain principles of Japanese architecture have helped him to overcome some of his problems, especially where flexibility of design is demanded. The use of sliding partitions, both interior and exterior, for example, is characteristic of Mayhew houses.

Adoption of scale cardboard models in the Mayhew office has been followed with considerable success. Although cardboard models are not especially popular with some architects, who think they are too suggestive of class work in a technical school, Mayhew has found them extremely satisfactory. Informative plans and cost data usually accompany the models and the client is further able to visualize the project by an ingenious method of showing the floor plans beneath the roof, which may be removed without injury to the complete model. This clever arrangement makes it possible to study the plan readily in relation to the elevations.

Design models are studied and built before working drawings are prepared. Defects that might otherwise work their way into the final design can readily be discovered and corrected. The architect is frank to admit that this approach to the plan problem has struck a popular chord with the average layman, who seems better able to picture the ultimate appearance of his prospective home with the model before him.

The problem of Function, Form, and Material is solved with incomparable ease in the Manor house illustrated on Page 20. The design represents the simple working out of an idea. That which you will note as decorative, is the outcome of necessity. This is also true in the Sebree house, where the variety of rectangular planes playing one into the other, the rectangles drawn by the battens necessary to cover the joints of the ceiling material, the variable openings on the garden, are all decorative as the outcome of well designed construction. It is through increased simplicity and elimination that the man of taste finds elegance. It would seem that

RESIDENCE OF HAROLD V. MANOR, CONTRA COSTA COUNTY



COURT VIEW

GARDEN VIEW



PLAN

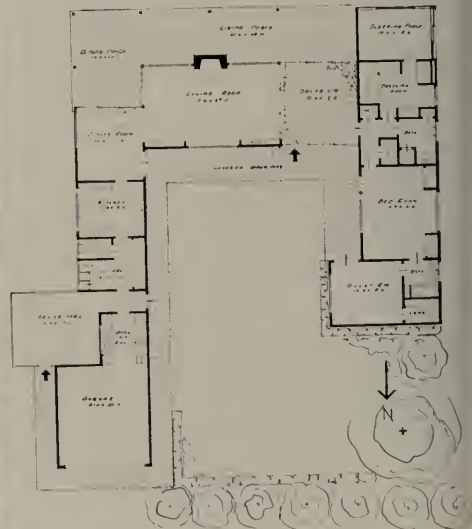

ARCHITECT AND ENGINEER

by eliminating the unessential and seeking the essence of things that these designs take form, have substance, and gain that ever-sought quality—space.

Mr. Mayhew's plans possess an unusual amount of flexibility. By the use of sliding partitions it was possible in the Rowell, Mayhew, and Manor houses to greatly increase both the size and use of the planned space. It will be seen that by sliding the exterior partitions away, the house and garden become as one. The garden enters the house and the house creeps through the garden. Inasmuch as most of the houses shown, face the south, the window openings are on that side, ingulfing the south-west breezes in the summer and the sun in the winter.

When I asked Mr. Mayhew if he was "sold" to the modern school, he replied: "Not at all," and continued, "I think to much emphasis is being placed on this word 'modern.' We are living in a changed world and these changes demand a different approach in residence design to any followed in the past. New building products have inspired greater originality; the call of the out-of-doors has brought living quarters into our gardens, so to speak, and the demand for space and more space has resulted in replacing wherever possible the old-time solid partitions with rolling doors, sliding windows, and glass partitions.

"As to the word 'style,' I personally strive to design houses that have style, rather than to design within a traditional style."



LIVING ROOM, RESIDENCE OF HAROLD V. MANOR
Clarence W. W. Mayhew, Architect

RESIDENCE OF JONATHAN H. ROWELL, BERKELEY



ENTRANCE DETAIL

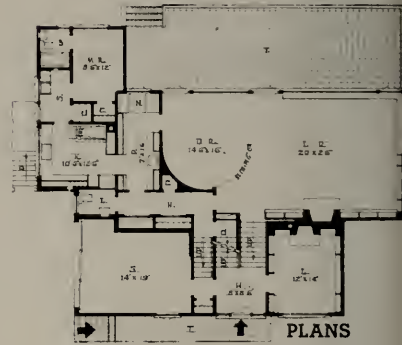
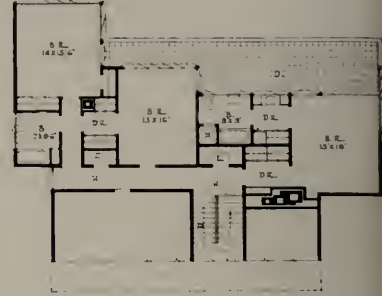

PHOTOS BY RODGER STURTEVANT



GARDEN VIEW



FIREPLACE DETAIL



LIVING ROOM, SHOWING CIRCULAR SLIDING DOOR TO DINING ROOM

RESIDENCE OF WILLIAM MORGAN, SAN RAFAEL



VIEW FROM ROAD

VIEW FROM
BOTTOM OF HILL



LIVING ROOM



RESIDENCE OF J. K. SEBREE, BERKELEY



DETAIL AND PLAN

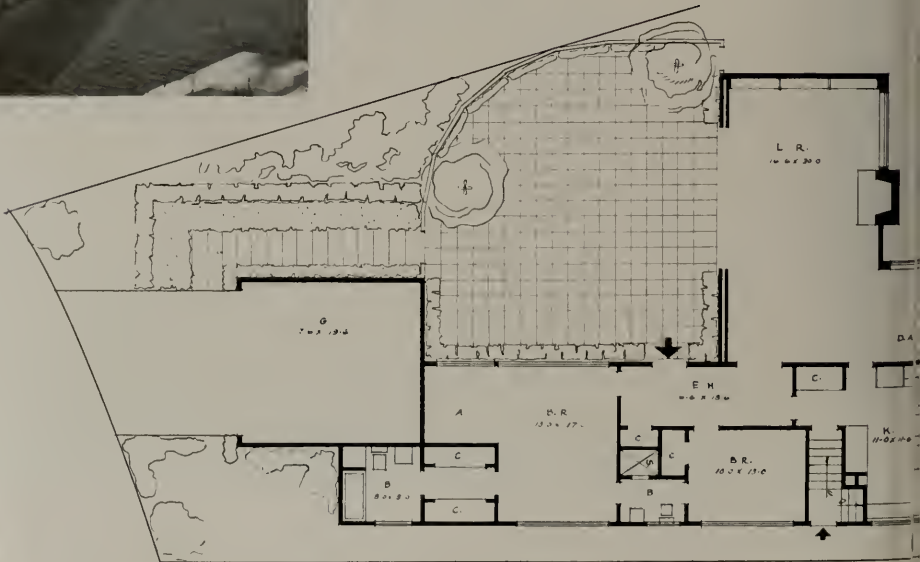



LIVING ROOM, SLIDING DOORS CLOSED



LIVING ROOM, SLIDING DOORS OPEN
PHOTO BY RODGER STURVEYANT
Released by American Home

RESIDENCE OF EDW. G. MAYHEW, OAKLAND



EXTERIOR
VIEW



PLAN

CLARENCE W. W. MAYHEW, ARCHITECT

STUDY OR BEDROOM

Note sliding doors



LIVING ROOM



PHOTOS BY JOHN LOHMAN

OAKLAND RESIDENCE



STREET VIEW



COURT

CLARENCE W. W. MAYHEW, ARCHITECT



FIRST FLOOR

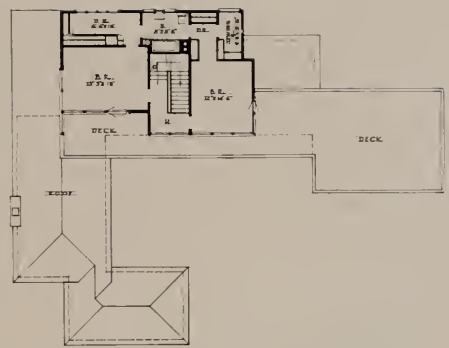

SECOND FLOOR



LIVING ROOM

PHOTOS BY RODGER STURTEVANT

RESIDENCE OF ROBERT McHALE, OAKLAND

PLANS

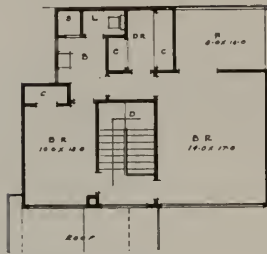

SECOND FLOOR



GENERAL VIEW

FIRST FLOOR

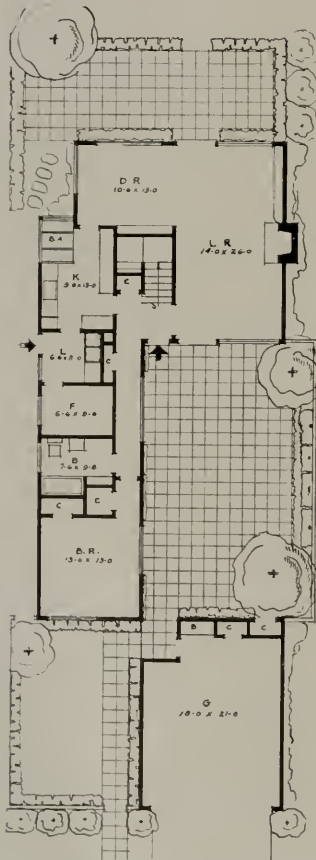

COURT VIEWS



CLARENCE W. W. MAYHEW, ARCHITECT

PHOTOS BY RODGER STURTEVANT

ARCHITECTURAL DETAILS

By Clarence W. W. Mayhew



RESIDENCE OF WILLIAM MORGAN, SAN RAFAEL

COVERED WAY

HAROLD V. MANOR RESIDENCE, CONTRA COSTA

SECTION

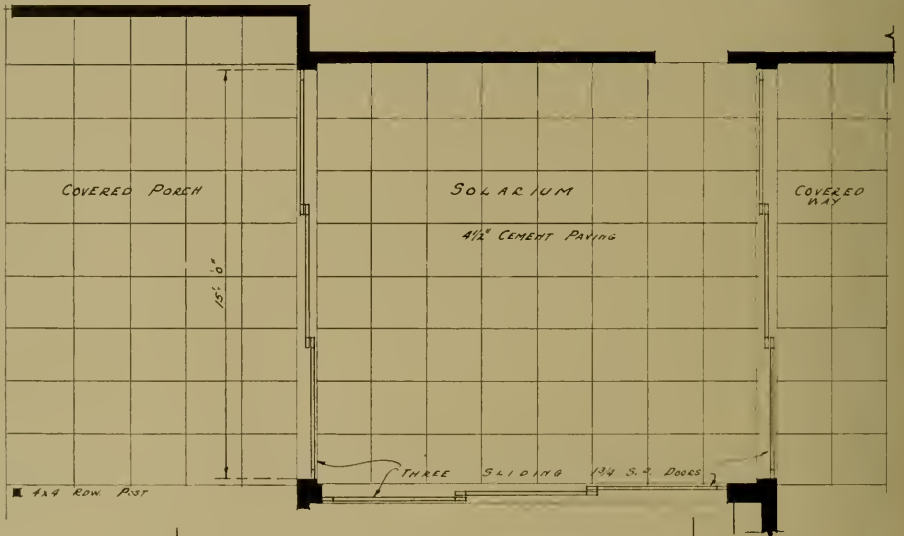
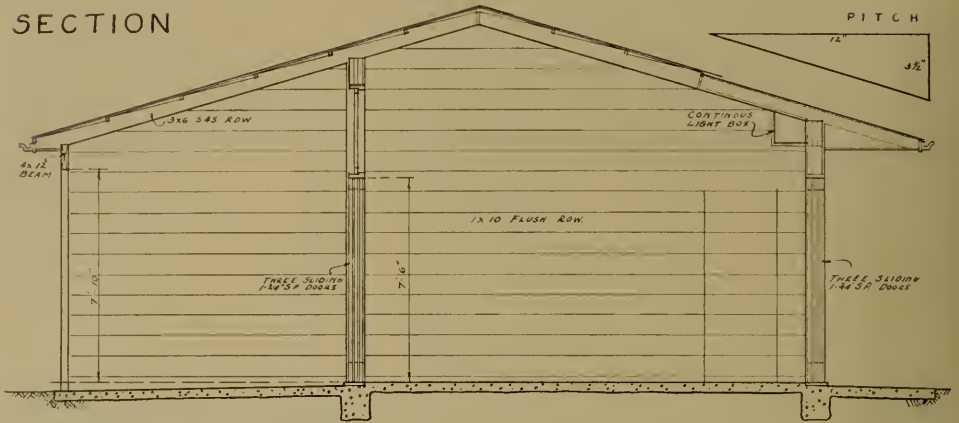

PLAN

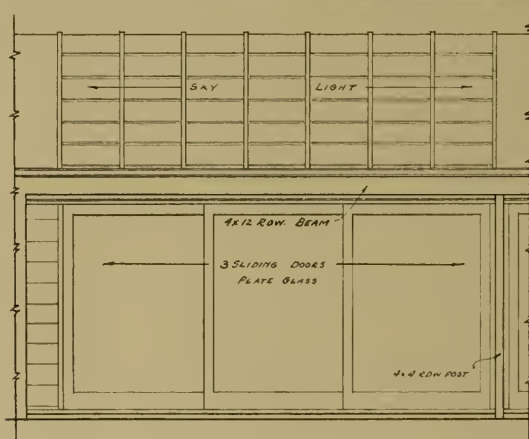

SOLARIUM DETAILS ELEVATION



SOLARIUM

OTHER PICTURES ON PAGES 18 AND 20

WILLIAM MORGAN RESIDENCE, SAN RAFAEL

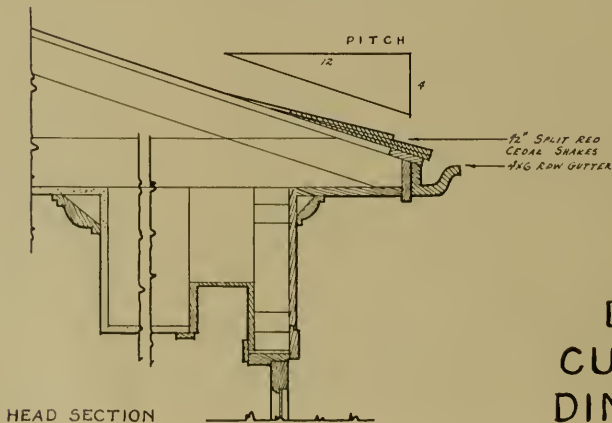
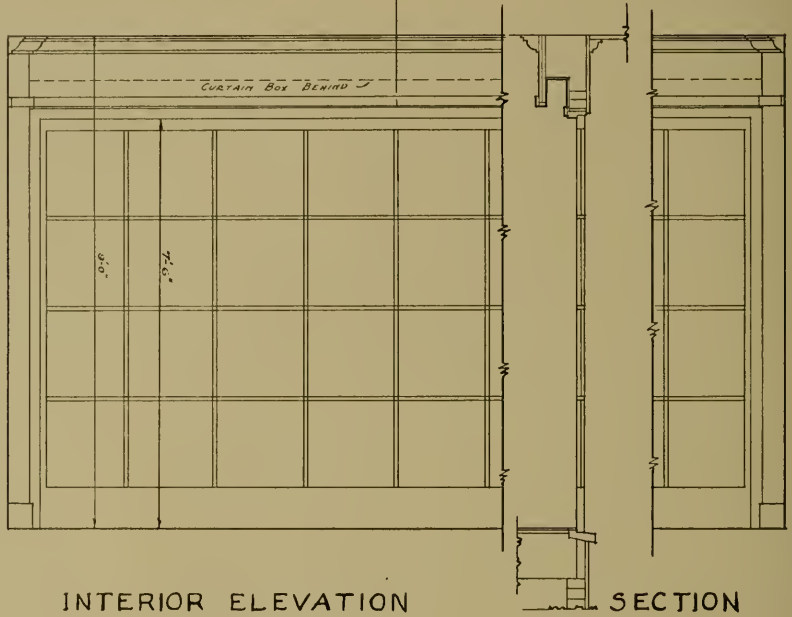
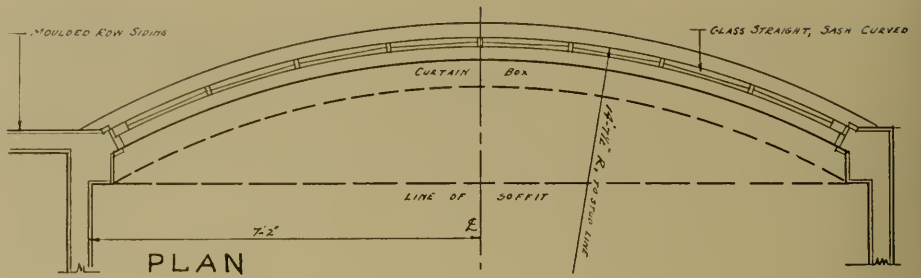

DETAIL OF CURVED BAY DINING ROOM



BAY WINDOW, DINING ROOM

PHOTO BY RODGER STURTEVANT

ROBERT McHALE RESIDENCE, OAKLAND

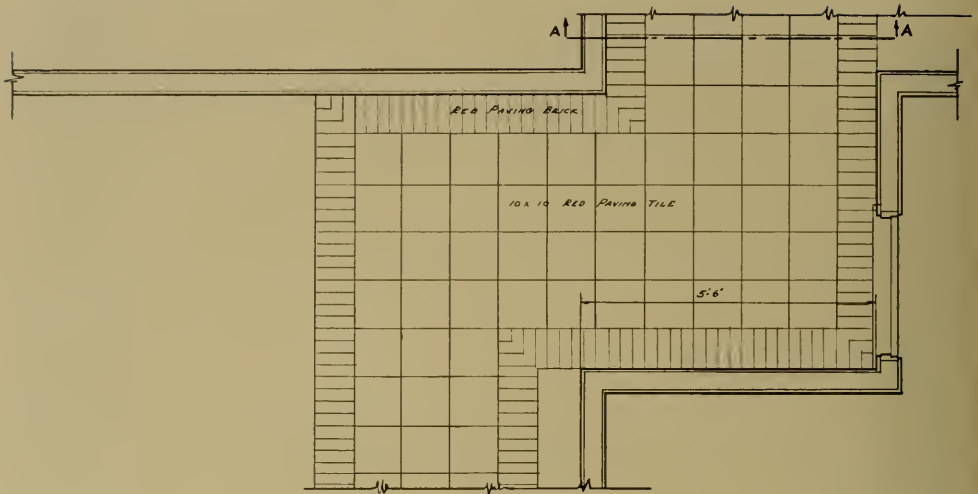

PLAN

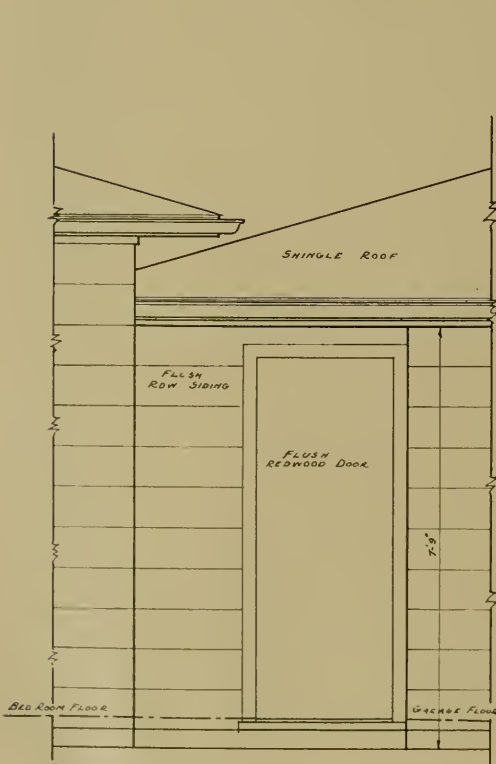

ELEVATION

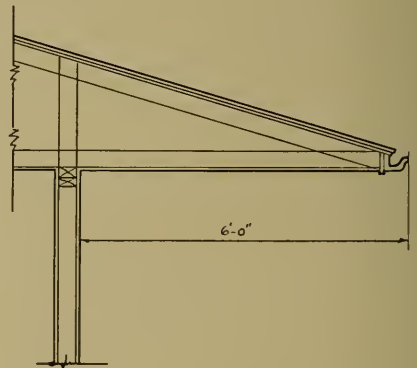

SECTION "A-A"
THRU
COVERED WAY

DETAIL OF
ENTRANCE
TO COURT



ENTRANCE TO COURT

PHOTO BY RODGER STURTEVANT

JONATHAN H. ROWELL RESIDENCE, BERKELEY



STAIR DETAIL

PHOTO BY RODGER STURTEVANT

SAFEGUARDING THE PACIFIC COAST FROM AIR RAIDS

By COLONEL L. H. STANFORD, U. S. Army Corps

When Colonel L. H. Stanford of the U. S. Army Corps described the War Department's program of Pacific Coast defense in *Electrical West* a year ago, the details were read with probably little more than ordinary interest. The possibility of an attack by an overseas nation seemed remote, indeed. But since this article was written things have been happening and a situation that once seemed unlikely has become the reverse. So Colonel Stanford's story of our Coast defenses has aroused new interest, particularly with reference to the Pacific air fleet and the anti-aircraft artillery. With McGraw Hill Company's permission Colonel Stanford's article and accompanying illustrations, are reprinted here.

WE of the Army are, of course, by the very nature of our duty, concerned with giving full consideration to whatever may happen to this country from storms, floods and other natural catastrophes; from internal strife and dissension, and from international situations. Plans evolved to meet these circumstances are not divulged to the public; one reason being that they are what we might term "trade secrets" and another being that undue publicity would give rise to needless alarm. Situated as this country is, it is doubtful if we would be subjected to an attack from any nation from over the seas. Broad expanses of water give us a large measure of security.

However, world unrest, development of aircraft, and the fact this country has resources beyond those of any other nation, are causing our security to diminish as time goes on. No matter how great our security may be, it behooves us to consider what might happen, even though the possibility of the occurrence may be very remote.

It is but natural that power men should have an interest in what the War Department has considered with respect to the utilization of power facilities in event of a possible but not probable war. Fundamental to such a discussion of facilities in connection with the defense of the Pacific Coast is the national organization for defense.

The defensive agencies of our nation are, of course, the Army and the Navy. The mission of the Navy is to meet the enemy at sea and, in so far as possible, to destroy him upon the waters; to protect movements of our own troops in convoy across the waters, and to convey to our shore establishments all information

possible of the disposition and movements of enemy forces. The Navy on the Pacific Coast is organized into the Pacific fleet. The shore establishments are at three district headquarters, namely, the 11th, 12th, and 13th Naval Districts, located at San Diego, San Francisco and Seattle. The mission of the Army is to protect land establishments and the civilian population from sea and air bombardment by such enemy elements as may have eluded the Navy; to prevent enemy landings, and to defeat such enemy troops as may be in its front.

For purposes of administration and mobilization the War Department has divided the



KEY MAP OF NINTH CORPS AREA SHOWING LOCATION OF MAJOR ELECTRIC UTILITIES, COOPERATING IN AIRCRAFT WARNING SERVICE.

- (1) Puget Sound Power & Light Co.; (2) California-Oregon Power Co.; (3) Pacific Gas and Electric Co.; (4) San Joaquin Power Division, P. G. & E.; (5) Southern California Edison Co.; (6) San Diego Consolidated Gas & Electric Co.; (7) Nevada California Electric Corp.; (8) Sierra Pacific Power Co.; (9) Pacific Power & Light Co.; (10) Washington Water Power Co.; (11) Idaho Power Co.; (12) Arizona Power Co.; (13) Standard Gas & Electric Co.; (14) Montana Power Co.; (15) Mountain States Power Co.; (16) Portland General Electric Co.; (17) Northwestern Electric Co.



Official photo, U. S. Army Signal Corps

BOMBERS IN ACTION FLY BY THREES. THIS FLIGHT CONSISTS OF DOUGLAS B18 BOMBERS (Sky Background) AND BOEING B17 FLYING FORTRESSES, SIMILAR TO MODEL ON EXHIBITION AT TREASURE ISLAND.

United States into nine Corps Areas. Each of these is capable of raising upon initial mobilization, throughout the Regular Army establishments therein, an Army corps. The Corps Areas are, in turn, grouped into Army areas. Thus we find that the 1st, 2d, and 3d Corps Areas constitute the First Army Area; the 5th and 6th Corps Areas the Second Army Area; the 4th and 8th Corps Area the Third Army Area and the 7th and 9th Corps Areas the Fourth Army Area.

Our particular interest is in this last, inasmuch as the entire Pacific Coast is a portion of the 9th Corps Area. The 9th Corps Area embraces the States of Washington, Oregon, California, Idaho, Nevada, Utah, Wyoming and Montana. Its headquarters is at the Presidio of San Francisco. It contains one Regular Army division and two National Guard divisions. In addition, there are a regiment of cavalry, and Coast Artillery troops, the latter being stationed at the Harbor Defenses of San Diego, Los Angeles, San Francisco, the Columbia and Puget Sound. Coast Artillery Harbor Defense troops are organized into the 9th Coast Artil-

lery District with headquarters at Fort Winfield Scott, San Francisco.

In an event of an attempted invasion, the Harbor Defense establishments of the Coast Artillery would deny to the enemy the use of our most important harbors and force the enemy to attempt to land at less favorable points. Any such attempt to land troops would be met by the mobile forces assisted by the heavy mobile artillery. The Coast Artillery is charged also with detecting the approach of enemy aircraft and with warning the Air Corps anti-aircraft artillery and the civilian population of the impending attack, and then with firing upon the attacking airplanes should they fly over a defended area. Should a mobilization be ordered, the Coast Artillery organization would come into being for actively defending the coast.

THE BOMBER'S MISSION

Prior to considering the measures to be taken to provide for an anti-aircraft defense, let us briefly consider some of the characteristics of aircraft and the problems which face them in making an attack. Aircraft is in general divided into four classifications, namely, Observation,

Challenging the ultimate in air speed is this Curtiss XP40 Pursuit, powered by in-line engine, and unofficially reported to have exceeded 500 miles per hour.



Official photo, U. S. Army Air Corps

Night action. Three-inch anti-aircraft guns are the end-points in a network of communications which is essential to successfully repulsing air raids.



Photo by U. S. Army Signal Corps

Pursuit, Attack, and Bombardment. Bombardment aviation consists of large multi-motored airplanes capable of carrying several tons of bombs, and its prime mission is dropping these bombs over establishments justifying attack.

In general, it is not expected that a bomber would be employed against a group of men or temporary emplacements. Normal target for this aviation would be permanently emplaced artillery, large industrial establishments, concentrations of troops, munitions plants, and large establishments of essential utilities, as well as areas where the population is congested, as in cities. All of this aviation flies at speeds ranging from 150 to possibly 400 or 450 miles per hour. In bombing, the altitude at which the aviation is flown must be sufficient to allow the ships to be free from the effect of bombs they drop and relatively free from the effect of anti-aircraft fire from the ground.

The first consideration indicates that over undeveloped areas bombing may be expected at altitudes of 2,000 to 5,000 ft. However, the latter consideration makes it necessary that that bombing be undertaken from altitudes of better than 15,000 ft. over areas which are defended with anti-aircraft artillery.

In the forward part of each bomber will be found a bombardier whose duty it is to adjust the bomb sight, and, when the target appears in his sight, to release the bombs. Upon this bomb sight must be set off the air speed of the ship, the altitude, the drift, and several other factors. Obviously the bomb sight cannot be completely adjusted until the last few seconds prior to arrival over the target, and if the work of the bombardier can be interfered with during these critical moments the accuracy of the bombing is lost.

Let us assume that some period such as 45 sec. might be required for the last-moment operations of the bombardier.

A bomb falls by gravity, and the time of its descent may be approximated by the well-known formula: $S = \frac{1}{2}GT^2$. At the moment of its release the bomb is being transported forward at the speed of the airplane. Let us assume that a bomb is dropped from an altitude of 15,000 ft. by an airplane flying at 200 mi. per hr. The time of flight of the bomb would

then be about 30.5 sec. and in the meantime the airplane would have traveled 3,000 yards.

Thus the bomb-release line is approximately 3,000 yards from the target. At 200 mi. per hr., an airplane will travel 4,400 yards in the 45 sec. allowed to the bombardier for his final adjustments. Beyond the bomb-release line, therefore, lies a critical area of 4,400 yds. in depth. If, over this area, it is possible to interrupt the bombardier or the plane, the bombing will be less accurate and probably ineffectual.

Aviation flies in a variety of formations varying in width, depth and altitude, the basic formation being that of a flight of three ships flying in a V. Each type of airplane has a distinctive appearance and a distinctive sound. A trained observer can readily identify the type of plane from its silhouette against the sky or by its sound if the plane is not visible. From sound, the observer can fairly accurately estimate the number of airplanes and can accurately determine their location. It is not difficult to estimate speed and altitude with a fair degree of accuracy. It is on these factors that we rely for identification and intelligence of enemy aircraft from ground stations.

Anti-aircraft artillery is organized into regiments which are equipped with anti-aircraft guns, fire-control equipment, searchlights, and sound locators. The modern 3-in. anti-aircraft gun, using the mechanical fuse and a muzzle velocity of 2,800 ft. per sec., can deliver fire upon a target at an altitude of 17,000 ft. and 6,000 yards horizontally from the gun. These guns are, in general, emplaced approximately along the bomb-release line and are so spaced that at least two batteries cover each portion of the critical area. Prevailing winds and the nature of the surrounding terrain very often influence the location of the guns and the density of the guns will be greatest over the expected avenues of approach available to the enemy.

Anti-aircraft searchlights are emplaced on the arcs of circles surrounding the target, having radii in general approximately one-half the distance to the bomb-release line for the inner circle of lights, and to approximately 10,000 yards beyond the circle of the guns for the outer ring of searchlights. Sound locators are placed near the searchlights. Five to 8 mi. be-

yond the outer ring of searchlights is a ring of listening or observation posts.

INTELLIGENCE CENTER

Each observation post, searchlight and sound locator is connected by telephone to the center of the defended area from which telephone lines radiate to the gun batteries. As soon as the sound locators pick up and locate the approaching aircraft, this intelligence is communicated to the gun batteries and the airplanes are taken under fire as they come within the range of the guns.

When bombing takes place at night the target is illuminated by the searchlights as soon as possible after its general location is determined by the sound locator, and the approaching airplanes are kept illuminated by searchlights the entire time that they are within the range of the guns. Clouds, surrounding terrain and extraneous noises are factors which interfere with the prompt detection of approaching aircraft.

The above information or intelligence network is established by the anti-aircraft artillery for the fire-control of the batteries, and it is not to be confused with the aircraft warning service which covers a wide expanse of territory and is not organized for any single target but for all targets within a defended area.

Thus it is highly desirable that an extensive warning service be established far beyond the range of the aircraft intelligence net above described, to enable the defending troops to receive timely warning of the approach of the enemy. Such a warning net for any given locality would consist of observation stations placed in general on concentric circles having radii of 40 to 60 mi., 80 to 100 mi. and 120 to 150 mi. These stations should be not more than 10 mi. apart. It will be observed that the complete warning service of any single target would therefore involve the establishment of about 300 observation stations manned for 24-hour operation.

For a warning service covering an area in which there were several targets, the station locations would approximate those of a single target but would also be established along several radii like the spokes of a wheel. Each station would be connected by some means of

communication with the center of the defended area.

The information center to which the lines of the warning service converge is also provided with communication to other defense elements from which intelligence will be received, such as the offshore and inshore patrols of the Navy.

Information received from any source is plotted on a map, and two or more reports of any enemy formations will reveal the course and speed of the approach. All possible information of impending attack is promptly furnished the airdromes and the anti-aircraft artillery commands. It is likewise furnished to other troops by land wire and to the civilian population through commercial radio broadcasting stations.

Thus nearly as much personnel is required in manning the anti-aircraft warning service as in manning the batteries defending the area. Important as this anti-aircraft warning service is, it is manifestly impossible to spare from combat purposes sufficient personnel to operate it, and the means for manning any such vast network has presented quite a problem to the War Department.

Several solutions of the problem have been offered, depending upon local conditions. However, here in the West we are fortunate that along the Pacific Coast there is an extensive power development. Each of these power systems is provided with communication channels.

Through the cooperation of Southern California Edison Co. with Colonel Thiele of the 63d Coast Artillery, an anti-aircraft warning service utilizing communications channels of power lines, augmented by forestry lines, was organized in Southern California for the General Headquarters Air Force maneuvers held at Muroc Dry Lake in 1937. This initial network was extended and improved and again used in the exercises held in April 1938.

The personnel used for the observing stations was the personnel which manned the various substations of the power companies and forestry service observation stations embraced by the system.

Communications from these observing stations followed the regularly accepted form of the flash message, for example:

"Flash I High Bay."

This means that station No. 1 has observed airplanes at high altitude in the sector bay. Such a message may be amplified by repeating the number and type of planes, the time heard or seen, and the direction of flight. Thus:

"Flash No. 1, Six Bombers, 1:56, High Bay Southwest."

Such a report, when relayed through the various substations of the network to the central office, would be plotted upon a board and its value determined from information received from other nearby stations. The course of the approaching airplane would be plotted from successive observations which would prepare the anti-aircraft defense to pick up the target when it came within the combat intelligence system immediately surrounding the target. Were the information of value to a more distant area, it would be relayed at once to the information center charged with the protection of the apparent destination of the flight.

SOUTHERN CALIFORNIA PROBLEM

In the April 1938 exercises the information center was established at the Alhambra station of the Southern California Edison Co. Relay points were established at important substations.

Personnel regularly assigned to duty at the various stations were given only very brief training in what was expected of them. With this meager training and the silhouettes of the various types airplanes furnished them, they were able to identify accurately the various types of airplanes observed and to report promptly and efficiently all flights made over their stations. Even from the outermost stations the reports reached the information center only a minute or so after the airplanes had been observed from these points.

The efficiency of this aircraft warning service, established around the communications network of the Southern California Edison Co., augmented by the networks of adjacent power companies and the Federal and State Forestry Services, has led to the development of aircraft warning service arrangements for the protection of areas around San Francisco and Monterey, and Portland and Seattle.

The problem of protecting Los Angeles and San Diego, as well as San Francisco and Monterey, is a relatively simple one because of the small number of agencies to be considered in establishing each network. However, the greater number of companies represented in Washington and Oregon makes the problem for the protection of Portland and Seattle somewhat more complex.

In both Washington and Oregon, and in Northern California, there are likewise many dead spaces which are not adequately covered by any kind of communication. This is apparent in Fig. 1. It would probably be necessary to lease from the telephone company or telegraph companies wire lines to interconnect the centers of the power companies which are not provided with facilities for interconnection over their own lines.

In the network of Southern California Edison, use was made of mobile radio transmitters to bridge gaps not covered by wire service, and this is a possible answer to gaps existing elsewhere along the coast.

The factors which make the utilization of the lines of the power companies ideal for this work are that their personnel is of high intelligence and widely scattered over the area to be covered; that their lines of communication feed to central locations suitable for the concentration of information from the observation stations, and that the use of these lines for this purpose leaves the telephone and telegraph lines free for the tactical use of mobile troops.

TACTICAL USES

There might, however arise situations in which the lines of the power companies might be required also for the use of tactical troops. Imagine, for example, that an enemy has landed at San Francisco and at Los Angeles and has seized those two centers. The telephone lines along the coast would be well nigh useless to the troops defending the country and striving to dislodge the enemy because of the fact that below Gilroy there is no telephone line connecting the coastal telephone route with the valley telephone routes. It is possible that the coastal telephone lines between Salinas and Ventura might at any one of several points

WELL DESIGNED SCHOOLS RESIST IMPERIAL VALLEY 'QUAKE

THE recent earthquake in Imperial Valley (May 18), proved the effectiveness of the Field Bill and Riley Act, California state laws regulating public building construction. The remarkable thing about the disaster was the fact that not a single one of the fifteen new school buildings built in the Imperial Valley under jurisdiction of the California State Division of Architecture was damaged in any way, not even to the minor cracking of plaster.

On the other hand, schools built prior to 1933 were, without exception, found lacking in the necessary stability to assure safety. Some were shattered beyond economical repair.

temporarily be interconnected through the facilities of the power system with the valley telephone lines connecting Stockton, Fresno, and Bakersfield until telephone plant could be constructed.

Among the targets which enemy aviation might seek out are various sources of power such as substations, dams, etc., supplying the coast. The damage to these installations would cripple industry beyond measure and would also affect water supply to the population in general. Thus in assisting the Army in its mission of defending the Pacific Coast by placing the communication channels at the disposal of the Army, electric utilities are not only permitting their facilities to be used for the general good but are, in fact, enabling the Army better to defend the utilities' own critical establishments.

It is noteworthy that the Army must have a system of intelligence service for the anti-aircraft defense of the Pacific Coast. The voluntary assistance rendered by the power companies for this work is appreciated by the military personnel. It is realized that the assistance which the Army has received and will receive in the future has been offered patriotically, without any great thought to the benefit which will accrue to the power industry from the utilization of its facilities by the military forces.

Chimneys came through the ceilings carrying with them portions of the roof and floor framing. Entire ceilings dropped in some instances (see photograph), wall plastering and blackboards were dislodged and thrown into the room, gables were shaken loose, and concrete and brick walls badly shattered.



TOP PICTURE SHOWS SHATTERED ADOBE WALLS OF BRAWLEY FIRE HOUSE AFTER RECENT IMPERIAL VALLEY TREMOR. LOWER PHOTO SHOWS FAILURE OF POORLY DESIGNED CONCRETE WALLS.

Illustrations courtesy of California Highways and Public Works and Southwest Contractor and Builder.

Loss to the Brawley elementary school district alone has been estimated at between \$250,000 and \$300,000.

In all parts of California, as well as many other localities, history has proven that we may

anticipate the occurrence of earthquakes of varying duration and intensities, at irregular intervals. The Imperial Valley earthquake was the 28th destructive one to occur in California in the last hundred years, but it was not until 1933 that State legislation was enacted to provide some degree of safety in the construction of buildings.

The cost of the new schools which withstood the shock, is reported to have been but very little more than those that failed. In checking over the some 3,300 school projects supervised by the California State Division of Architecture, totaling over \$140,000,000, it was found that additional construction expense, over what the buildings would have originally cost, was less than 2 per cent. It should be remembered that the additional 2 per cent has been spent in strengthening and making the building safe, the main expense being in the strengthening of the structural portion of the building, which portion represents from one-fifth to one-third the actual cost of the entire structure.

Examination of the demolished buildings revealed the same old story of improper design and poor construction. In that respect it was merely a repetition of what was observed at Santa Barbara, Long Beach, and Compton.

Nearly every damaged structure showed at least partial lack of continuity between structural members. This is well illustrated by the arcades built over the sidewalks as is the custom in Imperial Valley towns. The vertical supports were generally not rigidly connected to the girders they carry. This was true of wood, steel, masonry, and even concrete construction. This lack of continuity allowed the girders to shift on the piers in many cases. In other cases where there was a small degree of rigidity the piers were broken at top and bottom. The arcades in many cases collapsed on to the sidewalk. Lack of proper tying together of component parts was evidenced where the front wall of the arcade was returned across the sidewalk above the roof or second floor level at the end of the building. These walls span the sidewalk on concrete or steel beams. They were



TOP AND LOWER PICTURES SHOW CRUMBLED ADOBE WALLS OF BRAWLEY CITY HALL. MIDDLE PHOTO SHOWS STEEL REINFORCING BARS PULLED OUT OF GIRDER. NOTE HOW TWO BARS IN GIRDER WERE DISCONTINUED AT SECTION OF MAXIMUM MOMENT.

not tied to the building at the inner end nor to the pier at the outer end. This resulted in the precipitation of a mass of masonry into the sidewalk. Fortunately a shock previous to the destructive one had caused people to flee from the buildings and remain in the open. Had this not been the case the resultant loss of life might well have compared to a small section of the "blitzkrieg."

Brick masonry was of uniformly poor quality with weak lime mortar, unfilled joints, and poor workmanship the rule from which there was little exception. Walls were frequently inadequately and improperly anchored to roof or floor framing. Concrete buildings showed poor concrete, and improper detailing and placing of reinforcing steel. Several failures were observed which were due to the fact that no reinforcing steel was continued around the corner of a wall.

Elevated steel water tank towers fared badly if of older design. Some newer ones appeared to be undamaged. One collapsed at Holtville and another at Imperial. One at Brawley which remained standing showed severe damage to diagonal rods in the upper panels.



CEILING DROPPED TO FLOOR IN ONE OLD SCHOOL BUILDING



NEW BRAWLEY UNION HIGH SCHOOL BUILDINGS WERE UNDAMAGED



Pictures illustrating intensity of earthquake in Imperial Valley May 18. Left, elevated steel water tank and tower at Holtville. Diagonal rods failed and columns buckled dropping tank within the area included by four legs. Right, rift eight miles east of Calexico shown by pile of earth running across picture. Offset in fence, where man is standing, is between 8 and 9 feet. Intensity of the earthquake is estimated at 10 on modified Mercalli scale, more severe than Long Beach earthquake of 1933.

Photos by Frank Baudino

INSTITUTE ADOPTS UNIFICATION PLAN

The following is Ernest E. Weihe's report to the Northern California Chapter, A.I.A., and the State Association of California Architects, Northern Section of the 72nd A.I.A. Convention in Louisville, Kentucky, May 21st to 24th:

American architects convened in Louisville, Kentucky, in the Brown Hotel, on Tuesday morning, May 21, and carried on to the close of the banquet on Friday, May 24, at 11:30 p.m. The program as arranged by the directors of the Institute simplified matters, as many things as possible were decided in committee. Committee recommendations were accepted and voted upon on the floor.

Hubert G. Ripley of Boston read the dedication Tuesday morning, followed by the welcome of the Mayor of Louisville, in person, and that of the Governor of Kentucky by Hugh Meriwether of Lexington, President of the Association of Kentucky Architects. Announcement of scholarships, honorary memberships, and the conferring of Fellowships followed.

The first session closed with the address of Past-President Maginnis on "The Profession of Architecture—interesting and amusing.

On Wednesday morning came the president's address, reports of the directors, credentials committee, treasurer's reports, etc., and the nomination and election of officers. All incumbents were re-elected by acclamation.

Luncheon was arranged with a series of round tables for discussion. The architects discussed "Housing,"

"The Relationship of the Architectural Profession to Society," "Rural Practice," etc. These round table meetings, which were repeated on Wednesday evening, were well attended, and many lively discussions ensued.

On Thursday, the third day, reports of the various committee chairmen were received and adopted in routine order on the floor of the convention. The session finished with the reading of a paper by Dr. Constantine E. McGuire, economist, who was introduced by former President Stephen F. Voorhees. With the appearance and manner of a gentle, retiring scholar, Dr. McGuire read his paper, "Trends of Our Time and the Trend of Our Times," which contained many startling and impressive economical and statistical matters. It is my opinion that many architects learned more about what was really the matter with our profession from Dr. McGuire's economic explanation than from any other single document or report at the convention.

Friday, the final day's meeting, brought action on the Board of Directors' report, which included a resolution regarding a special committee of architects to advise the Government on the general Preparedness Program.

John Bakewell, Jr., National Chairman of the Committee on Education, presented his report, which was

supported by statements from several of the Education Committee members from different parts of the country. This report stressed the necessity of the Institute concerning itself with the education of the young architect from the time he finishes college until he applies for a Certificate of Registration in any of the States.

The afternoon of the last day was given over to the National Committee of the Producers' Council.

The convention closed with a banquet on Friday evening.

In addition to the routine matters mentioned, there were several social affairs, including a reception by the Louisville Society of Architects, a horse show, a mint julep barbecue (do they barbecue juleps, or do the juleps barbecue you?—Ed.) at the Country Club, and various sightseeing tours around Louisville.

My strongest personal recollection of the convention is that it was a matter of very hard work, meetings extending from morning until almost midnight nearly every day. Among its compensations were meeting old friends and acquaintances and the making of new friends.

One of the matters in which the California delegates were most interested was the Institute's so-called "Unification Plan." We can report that the plan was adopted without a dissenting voice after certain proposed amendments had been defeated on the floor of the convention.

WINNER OF SCULPTURE PRIZE

The winner of the sculpture prize of the American Academy in Rome is Loren Russell Fisher, of Needham, Indiana. This is the Jacob H. Lazarus Fellowship of \$4,000 provided by the Metropolitan Museum of Art and starts its two-year term October 1, under the same conditions as the \$2,000 Sculpture Fellowship which has been awarded to John Gulias of New York.

Four senior prizes in architecture have recently been awarded to Vincent G. Kling, of East Orange, N. J., top-ranking student in the June class in the School of Architecture of Columbia University, bringing to seven his share of the 10 prizes offered by the School. Dean Arnoud states that this establishes a record.

Dr. Frederick P. Keppel, president of the Carnegie Corporation of New York and formerly a dean of Columbia University, was awarded the Friedsam medal for 1940 at a dinner at the Architectural League last month.

The competition was acclaimed one of the most successful ever offered by the Beaux-Arts Institute of Design. It called for the design of a 1 kw. broadcast transmitter station and was open to architectural students of American architectural schools. More than one hundred entries were received and judging of the entries took place June 11 and 12 at the Beaux-Arts headquarters.

WITH THE ENGINEERS

San Francisco Section, American Society of Civil Engineers, was addressed at its June 18th dinner meeting by Professor C. F. Tolman of Stanford University, on "The Geological History of California. Professor Tolman gave a non-technical description of the rock formations of California and their origin, with special emphasis on the relationship between these formations and the foundation and engineering problems which arise when dealing with them.

Chairman L. Harold Anderson reports that several committee meetings have been held to decide on the annual convention of the Section to take place probably in September. He promises that this year will be the best convention ever held, with golf, tennis, swimming, dancing and everything else to make a worthwhile get-together of the Section members and their wives.

A change from twenty-nine to thirty-five years as the age limit for junior membership in the Engineers' Club of San Francisco has been adopted. Dues for this grade of membership are now two dollars per month and the initiation fee is ten dollars.

H. H. Hall, chairman, announced that at a recent meeting of the committee, a suggestion was adopted that the Section initiate an effort to induce Student Chapter members to take summer employment of an engineering nature and that the Section appoint a special committee to assist in the placement of all students desiring such work.

L. H. Nishkian, chairman of the Legislative Committee, recently reported favorable consideration by the Federal Government of a request that Uncle Sam employ San Francisco engineers wherever possible on Army and Navy projects. Through the assistance of the San Francisco Chamber of Commerce the matter was brought to the attention of officials in Washington, D. C., who replied that the Section was justified in taking such action.

Nathaniel J. Kendall, who has been editor of the San Francisco Section's Bulletin since it was initiated in 1937, has resigned his post due to moving his office to San Jose.

REAR VIEWS

From S. C. Chapter Bulletin

An ordinance requiring architectural conformity for the sides and rears of business buildings which adjoin residential zones has recently been passed by the Los Angeles City Council.

It occurs to us, however, that this idea could very well be applied to a number of other types of buildings. Flats, apartments and several others are usually found with an elaborate front and a decidedly bald rear. Why not carry on?

NEW STATE ARCHITECT



ANSON BOYD
SUCCESSOR TO GEO. B. McDOUGALL

Anson Boyd, California's new State Architect, appointed last month by Frank W. Clark, Director of the State Department of Public Works, was chosen from the civil service eligible list and succeeds George B. McDougall, retired. Since the latter's retirement in 1938, the duties of the Division have been under the charge of W. K. Daniels, Assistant State Architect.

Mr. Boyd is a graduate of the School of Fine Arts and Architecture, University of Pennsylvania, where he was the holder of the Sims Memorial Scholarship. He pursued his profession in Philadelphia and New York until 1917 when he was commissioned in the U. S. Army Air Service. He was demobilized in April, 1919, and resumed architectural work in New York. In March, 1923, he took up his residence in Los Angeles, where he became architect for the Los Angeles District Board of Education.

In this capacity, he supervised the expenditure of the \$35,000,000 bond issue which involved the construction of 30 junior high schools, 18 senior high schools, more than 200 elementary schools, gymnasiums, vocational centers, development schools, etc.

In private practice, he helped in the designing of many buildings in Southern California, including the California Club, Los Angeles; Beverly Hills High School and Pomona Progress-Bulletin Building.



Glazed terra cotta wall units, Krafftile's 6 x 12's, precision sized, were specified for San Francisco's newest fire house, Number 35, in Bluxome Street, near Fourth Street. Designed and constructed by Bureau of Architecture, Board of Public Works, San Francisco; Dodge A. Riedy, City Architect.



"Monterey Buff" was selected as the color for this installation which assures resistance to fire, acid stains, moistures, and other hard usage and at the same time affords a surface easy to clean and one that need never be painted or otherwise reconditioned.

HONOR FOR MOVIE ARCHITECT

The gold medal recognition award of Scarab Architectural Fraternity, "for signal professional achievement" among architects under 35, has been given to William L. Pereira, architect-designer of Paramount's contemplated new \$15,000,000 studio. He is the first recipient of the award, which will become an annual affair.

The medal was presented to Pereira at a meeting of the Southern California Chapter of the American Institute of Architects by R. Van Buren Livingston, architect, national president of the Scarab body, on the basis of balloting by men of the profession throughout the country.

Pereira, who is 30 and a graduate of the University of Illinois' class of 1930, has gained wide attention as the designer of notable structures, including the Esquire Theater in Chicago, the interiors, facilities and facade of which are illustrated in the Encyclopedia Britannica.

He also designed several structures at the San Francisco Fair.

ARCHITECTS' BULLETIN

Issued For

THE STATE ASSOCIATION OF CALIFORNIA ARCHITECTS

Northern Section

STATE ASSOCIATION MEMBER
OF THE
AMERICAN INSTITUTE OF ARCHITECTS

Editor
Harris C. Allen

Address all communications for publication in the Bulletin to the Editor (Harris C. Allen) 557 Market Street, Room 218, San Francisco, California.

STATE ASSOCIATION OFFICERS

President.....Ernest E. Weihe, San Francisco
Vice-Pres.....Merrill W. Baird, Glendale
Secretary.....Robert H. Orr, Los Angeles
Treasurer.....Mario Ciampi, San Francisco

Regional Director—Southern Section
Gordon B. Kaufmann, Los Angeles

Regional Director—Northern Section
Harry M. Michelsen, San Francisco

Executive Board—Northern Section
Officers

President.....Ernest E. Weihe, San Francisco
V-Pres.....Frederick H. Reimers, San Francisco
Secretary.....Vincent Raney, San Francisco
Treasurer.....Mario Ciampi, San Francisco

Directors

Harold H. Weeks and Wayne Hertzka
(for one year)

Harry J. Devine and William C. Ambrose

Executive Board—Southern Section
Officers

President.....Merrill W. Baird, Glendale
Vice-Pres.....Winsor Soule, Santa Barbara
Secretary.....Robert H. Orr, Los Angeles
Treasurer.....Sylvanus B. Marston, Los Angeles

Directors

A. M. Edelman, George D. Riddle
(for one year)

Sam W. Hammill and Ben H. O'Connor
(for two years)

Northern Section Advisory Council

San Francisco District:

Frederick H. Reimers (President)
J. K. Ballantine, Jr. (Secretary)
Harris C. Allen
Dodge A. Riedy
Ernest E. Weihe
Mario J. Ciampi
Conrad T. Kett
Roland I. Stringham
Wm. H. Knowles
Vincent Raney

North Bay:
J. C. Felciano

Lower San Joaquin:
H. G. Bissell

Santa Clara
Chester Root

San Mateo:
Clyde Trudell
Irwin Johnson
Jas. H. Anderson
Ralph N. Kerr

Upper Sacramento:
Casebolt Dakin

Sacramento:
Alfred Eichler
Redwood Empire:
F. T. Georgeson

Upper San Joaquin:
David Horn

Monterey Bay:
Robert Stanton

Palo Alto:
Birge M. Clark

Marin:
Jas Bertenshaw

East Bay:
Irwin Johnson
Jas. H. Anderson
Ralph N. Kerr

Berkeley:
Gwynn Officer

Redwood Empire:
F. T. Georgeson

Lassen:
Ralph Taylor

Exhibits At The Fair

ARCHITECTS, and the Building Construction Industry, are officially recognized and represented at the 1940 Golden Gate Exposition. One main building is entirely devoted to Construction, and through its center run two long tables holding models of small homes, one labeled "Architects' Models," the other more or less anonymous. People love to look at miniature models—witness the outstanding popularity of Mrs. Thorne's miniature rooms in the Art Palace. So there is a publicity value for the profession. But it is unfortunate that this combination exists, of "legitimate" designs and those produced "without the benefit of clergy," especially as the general public can not be expected to discriminate. And the architect's models are not accompanied by informative plans and descriptive notes of requirements, site, cost and other conditions. Also, there is a large proportion of cardboard models, suggesting the class work of a technical school, rather than practical building studies for actual clients. Allowance must be made, of course, for the short period of time in which these exhibits had to be collected and installed.

In addition to this display connected with the commercial exhibits of the building industry, is a large, centrally located section of the Fine Arts Building devoted to Architecture. Here an extraordinarily interesting and well-planned scheme has been worked out, presenting a quite dramatic picture of the complications of modern building construction. One large wall is covered with innumerable samples of building materials and equipment, explained and coordinated.

Illustrations of buildings by architects are presented through the mediums of photograph, model, plan, sketch and printed story. Tables with reading matter, stools, a screen for movies such as "The City" are provided. As with the last architectural exhibit of the A.I.A. Chapter, this vivid, attractive, educational show was installed with the help of a few faithful enthusiasts. Go to see it, and spread the news about it.

EXECUTIVE BOARD Recent activities of the Board have covered several subjects of concern to architects. Relations were established with the Naval Construction department which will probably open the way for local professional services on much of the new building program. Members have been requested to state their interest in such work, together with their experience and general qualifications, for listing with the proper authorities.

The Board has recommended to the San Francisco administration that an annual license tax of \$10.00 would be appropriate for architectural firms, in fair relation to fees for other professions and businesses.

UNIFICATION

A full report of the 1940 A.I.A. Convention is not yet available, but our delegate, President Ernest Weihe, reports that the proposed amendments to further the Unification Program were adopted by a large vote, after considerable discussion. Ernest informs us that the aspersions in our last Bulletin, questioning his ability to withstand the allurement of Louisville, were unwarranted. Mrs. Weihe accompanied him.

PRODUCERS' COUNCIL

Repeating, but not duplicating, its 1939 party on Treasure Island, the San Francisco Producers' Council Club entertained a large number of local architects on June 25th. Meeting at the Architectural Exhibit in the Fine Arts Building, the group enjoyed in turn a movie at the P. G. & E. exhibit, a special demonstration at the General Electric House of Magic, another movie in the Westinghouse Auditorium, then to cocktails and canapés in the comfortable Westinghouse Lounge (where by television we saw and heard President Victor Anderson, who happens to be with the Otis Elevator Company, protesting to Mr. Lewis against riding up to the lounge in a Westinghouse elevator, but accepting his fate like a good trouper), then to dinner at the Continental Café, and afterward to the Folies Bergere. This affair was fully up to the Producers' brilliant record of success in demonstration of mutual good will and cooperation.

PUBLIC RELATIONS

From the "Southwest Builder and Contractor" we reprint the account of recent activities of our Southern Section, which should be carefully considered in relation to our own proposed program.

ARCHITECTS START NEW PROGRAM FOR BUILDING BETTERMENT

"By Vincent Palmer, Chairman, Professional Betterment Committee.

"Over one hundred fifty architects joined together on April 26th at the State Association dinner, to hear and take part in an aggressively new program for "Building Betterment."

"The theme of the evening was the recognition that an architect's certificate represents a public trust in the safeguarding of the uninformed home-buyer.

"To this end, a large part of the evening was devoted to an exposé of frauds or dishonesties in which many home-buyers were victimized. Photographic slides were thrown on the screen which revealed violations of essential building requirements, and which showed complete disregard for building codes. Fraudulent advertising was likewise shown. So unsecure and poorly constructed were the homes thus illustrated, that a 'Building Practice' committee was organized to

report these and similar instances to the proper authorities. This committee will act as a handling medium for complaints and reports involving fraudulent or dishonest or incompetent construction, and the Association will be pleased to refer any complaints of victimization to the proper authorities.

"The Association also authorized the preparation of 300 natural color photographic slides. These slides are offered with a lecture to all clubs, civic groups, educational bodies, and such organizations. The programs are edited and classified for type of work and are selections from the work of the profession itself. The three following programs are offered:

"First. Housing in the \$5,000 cost class, showing one hundred of California's finest small homes, and accompanied by slides showing good construction photographs and faulty, dishonest practice. Proper annotations accompany construction photographs so that the prospective home-buyer can see for himself.

"Second. Housing in the above-\$10,000 cost class showing one hundred of California's finest homes, and likewise accompanied by good and bad construction photographs.

"Third. Commercial buildings, store-fronts, modernization, and income-producing buildings. The modernization phase of this particular program will show 'before' and 'after' photographs.

"Authorities in the building industry are so alarmed at the mal-practice and incompetency of many 'Jerry'-builders, contractors and 'carpitects' that these educational lectures are offered by the Association at no cost or expense.

"The radio program, sponsored by the Association over KNX every Sunday morning at 10 a.m., was previewed and received the hearty endorsement and enthusiasm of all present. This radio education of the home-owning public is designed to save innocent buyers from worry and travail of meeting incompetency in the securing of their homes. Under such radio program the Association offers the services of the Architect's Bureau for the answering of such questions as—How to plan a home; What pitfalls to avoid; Selecting your home-site; What an architect does; How to select an architect.

"But the entire meeting was not devoted to safeguarding the public entirely. The architects took time out to thoroughly enjoy themselves, and to sample the programs they are offering. The favorite buildings of many architects were shown on the screen in color photographs, and the individual architect was then introduced to the assembly at large. Applause welcomed the work of each architect who, in many cases, blushing accepted this whole-hearted acclaim by his fellows. The entire body is anticipating the next meeting with great interest and architects who missed this one really missed a treat."

With the Architects

OFFICE BUILDING CHANGES

Bliss and Fairweather, Balboa Building, San Francisco, have completed plans for remodeling the rear of the first floor of the Morris Plan Company building at 717 Market Street, San Francisco. The improvements will include changes to the basement to provide for a garage. G. P. W. Jensen is the general contractor.

DRIVE-IN MARKETS

A drive-in market is planned for 46th Avenue and Judah Street, San Francisco, from plans by Kaj Theill, structural engineer, 580 Market Street, San Francisco.

Another drive-in market will be built at Channing Way and Shattuck Avenue, Berkeley, for Mr. Norton, the designer being Earl R. MacDonald, architect, of Oakland. Construction will be of reinforced concrete.

ADDITION TO PAROCHIAL SCHOOL

A \$30,000 addition to the Immaculate Conception parochial school in Sacramento, is being built from plans by Harry J. Devine, architect, Cronan Building, Sacramento. There will be two class rooms and an auditorium.

TWELVE-ROOM RESIDENCE

Messrs. Farr and Ward, Foxcroft Building, San Francisco, have completed plans and taken bids for a 12-room and 5-bath residence at Pierce Street and Broadway, San Francisco, for an unnamed client. Construction will be brick veneer, ship-lap and slate roof.

JUSTICE COURT AND GARAGE

From plans by Carl Werner and H. A. Minton, a one and two-story reinforced concrete building has been started for Alameda County at 13th and Madison Streets, Oakland, estimated to cost \$111,000. The structure will cover ground area 175x100 and will accommodate the justice's court rooms and county automobiles.

TWO FLAT BUILDINGS

Plans have been completed by Messrs. Hertzka and Knowles, 369 Pine Street, San Francisco, for two frame and stucco flat buildings to be built on the northeast corner of Chestnut and Stockton Streets, San Francisco, for Charles Morosin and Pietro Arrigoni. The two buildings will represent a total outlay of \$22,000.

ATTENDED INSTITUTE CONVENTION

Southern California Chapter was well represented at the Institute Convention in Louisville, Ky. The delegation included Gordon B. Kaufmann, Regional Director; A. Bergstrom, S. B. Marston, Pierpont Davis, Wil-

liam H. Harrison, Samuel E. Lunden and Charles O. Matcham.

ARCHITECTS' DAY AT THE FAIR

Colorful Exposition buildings and exhibits had an opportunity to "meet" their designers en masse on June 20.

The occasion was Architects' Day on Treasure Island, sponsored by the Producers Council, the Northern California organization dedicated to the creation of closer relationship and mutual understanding among architects, engineers, manufacturers, contractors and owners. Participating were 121 guests whose names included the leaders of the building industry in the entire Bay Region.

Architects' Day began with a visit to the architects' exhibit in the Palace of Fine Arts. After an inspection of this fine exhibition, the visitors moved on to the Hall of Construction Industries, where they found much of interest and many a business associate to greet and chat with.

Next on the itinerary was the Hall of Electricity and Communication, with the first stop the Pacific Gas and Electric Company exhibit where there was a showing of the motion picture, "Blame It on Love."

This was followed by a visit to the General Electric exhibit at the other end of the building where the group enjoyed a special show in the new House of Magic.

Last stop in the Hall of Electricity and Communication was the Westinghouse exhibit where a preview of the full-color comedy picture "Bugaboo of Bugville," dramatizing the use of the Sterilamp, was shown.

James H. Mitchell, president of the San Francisco Chapter; V. F. Anderson of the Otis Elevator Co., president of the Producers Council; and G. H. Lewis, manager of the Westinghouse exhibit, went to the RCA exhibit where they were televised and the result transmitted to a receiving set in the Westinghouse lounge, where the rest of the party had assembled.

A dinner (sans speeches) at the Café Continental was the next event on the program.

Needless to say, the brains of the building industry thoroughly enjoyed the Folies Bergere, which wound up a most enjoyable day.

In addition to members of the San Francisco Chapter, A.I.A., a large delegation was present from the California State Association of Architects, led by President Ernest E. Weihe.

Much credit for the success of the get-together goes to President Anderson of the Council; A. D. Chalmers of W. P. Fuller and Company, Council secretary; and L. D. Saylor of the Vermont Marble Company, who chairmanned the program committee.

MODERNIZED PRODUCTS

Brief Notes on New Materials and Equipment in the Building Industry.

407. PRESERVATIVE

"Denso-Guard" a new preparation for the preservation and protection of wall paper and flat wall painted surfaces is explained in detail in a broadside issued by the manufacturer, The Densol Paint Co. This is apparently a very unique product. Samples and detailed information may be had by using the coupon.

408. SWIMMING POOLS

Josam Manufacturing Company have another interesting booklet out on Swimming Pool Equipment. This booklet gives full details and is in the form of a partial catalog, with plenty of illustrations and diagrams.

409. FLOOR PROTECTION

Flexrock, Bakeflex, and Colorflex, three products put out by the Flexrock Company are fully described and illustrated in three little booklets. These floor protective coverings are of considerable interest. Your copies may be obtained by simply sending in the coupon.

410. "COOLER-AIR"

Payne Furnace and Supply Company have an exceptionally interesting brochure out, entitled, "Payne Coolerair" for "When that next hot spell comes along." Full details are included. Send for your copy now.

411. CELOTEX NEWS

Celotex Corporation has sent us another of their little magazine-form brochures, "The Celotex News." In this interesting fact-containing paper there is truly a wealth of information; there are colored illustrations and details concerning many of the products of this company. The coupon will insure your getting a copy.

412. GLASS PANELS

"Glass Waffles" in reality pressed glass panels, a new development in glassware designed for lighting with the new fluorescent light source, are explained in a new broadside issued by the famous Corning Glass Works.

413. INSULATED WINDOWS

The Curtis Companies Service Bureau have issued a new booklet titled "Curtis Silentite Insulated Windows," which gives all necessary information about these new modern windows for homes. Send for your copy by using the coupon below.

414. HOT WATER UNITS

Ruud Manufacturing Company have a brochure describing their two new Ruud-Monel Units designed for small hot water users. There is some interesting reading here. Send for a copy.

415. PLASTER

Crescent Rock Company has a new booklet out descriptive of their product "Diacrete Plaster." This is an interior covering and has some rather unique features. Send for your copy by using the coupon below.

416. ELECTRICAL INSULATION

National Electric Products Company have a broadside just issued on "FireStop" a new electrical conductor which has as a covering a still newer product, "Safecote." A full description of these important advances in electrical insulation will be found in the broadside.

417. VALVES

A little booklet containing the essential information on Fast Action Air Shut-Off Valves has been issued by the Homestead Valve Manufacturing Company. The coupon will assure you of receiving this information and other pertinent facts about valves.

418. LAMP SHADES

A new innovation in lamp shades for hospitals, schools, public and private office buildings has been put out by the Higgins Products Company. This shade is called "Light-Tight" and is fully described in a broadside just issued by the company. Send for your copy.

419. AIR CONDITIONING

Air Conditioning with a new Humidifier Water Control is the subject of a booklet issued by McDonnell & Miller Company. There are several very pertinent facts concerning air conditioning contained in this booklet.

420. FOR WAXED FLOORS

New safe Rubber Gloss to render waxed floors absolutely safe, is detailed in a brochure put out recently by the Franklin Research Company. This product is a floor wave and from its description is most interesting. The coupon below will have a copy reach you.

421. FOR FIREPLACES

Heatilator Company have issued a beautiful booklet with drawings and details of their new "Heatilator Fireplaces." This is an exceptionally attractive booklet and has some interesting facts to go with the excellent illustrations: The coupon is for your convenience—use it now.

FREE FOR THE ASKING

Check items on coupon, paste on letter head or postal card, and mail to Architect and Engineer.

Architect and Engineer
68 Post Street
San Francisco, Calif.

Please send me literature on the items as checked below. This places me under no obligation

407	<input type="checkbox"/>	414
408	<input type="checkbox"/>	415
409	<input type="checkbox"/>	416
410	<input type="checkbox"/>	417
411	<input type="checkbox"/>	418
412	<input type="checkbox"/>	419
413	<input type="checkbox"/>	420
421	<input type="checkbox"/>	

My Name.....
Name of Company.....
Street.....
City.....State.....

Estimator's Guide

Giving Cost of Building Materials, Wage Scale, Etc.

Amounts given are figuring prices and are made up from average quotations furnished by material houses to San Francisco contractors. 3% Sales Tax on all materials but not labor.

All prices and wages quoted are for San Francisco and the Bay District. There may be slight fluctuation of prices in the interior and southern part of the state. Freight cartage, at least, must be added in figuring country work.

Bond—1/2% amount of contract.

Brickwork—

Common, \$40 to \$45 per 1000 laid, (according to class of work).
Face, \$90 to \$100 per 1000 laid, (according to class of work).
Brick Steps, using pressed brick, \$1.00 lin. ft.
Brick Veneer on frame buildings, \$0.70 sq. ft.
Common f.o.b. cars, \$14.00 at yard. Cartage extra.
Face, f.o.b. cars, \$45.00 to \$50.00 per 1000, carload lots.

HOLLOW TILE FIREPROOFING (f.o.b. job)

3x12x12 in. \$ 84.00 per M
4x12x12 in. 94.50 per M
6x12x12 in. 126.00 per M

Building Paper—

1 ply per 1000 ft. roll \$3.50
2 ply per 1000 ft. roll 5.00
3 ply per 1000 ft. roll 6.25
Sixkraft, 500 ft. roll 5.00
Sash cord com. No. 7 \$1.20 per 100 ft.
Sash cord com. No. 8 1.50 per 100 ft.
Sash cord spot No. 7 1.90 per 100 ft.
Sash cord spot No. 8 2.25 per 100 ft.
Sash weights cast iron, \$50.00 ton.
Nails, \$3.50 base.
Sash weights, \$45 per ton.

Concrete Aggregates—

Gravel (all sizes) \$1.45 per ton at bunkers; delivered to any point in S. F. County \$1.85.
Bunker Delivered
Top sand \$1.45 \$1.85
Concrete mix 1.45 1.85
Crushed rock, 3/4 to 3/4 1.60 2.00
Crushed rock, 3/4 to 1 1/2 1.60 2.00
Roofing gravel 1.60 2.00
City gravel 1.45 1.85
River sand 1.50 1.90
Delivered bank sand—\$1.00 per cubic yard at bunker or delivered.

SAND— Bunker Delivered
River sand \$1.50 \$1.90
Lapis (Nos. 2 & 4) 2.00 2.40
Olympia Nos. 1 & 2 1.80 2.20
Healdsburg plaster sand \$1.80 and \$2.20
Del Monte white 50c per sack

CEMENT (all brands, common, cloth sacks) \$2.72 per bbl. f.o.b. car; deliv. \$2.90 per bbl., carload lots; less than carload lots, warehouse or deliv., 80c per sack. (Less 10c per sack returned, 2% 10th Prox.)

Common cement (all brands, paper sacks) carload lots \$2.52 per bbl. f.o.b. car; delivered, \$2.70; less than carloads delivered, 75c per sack. Discount on cloth sacks, 10c per sack.
Cash discount on carload lots, 10c a barrel, 10th Prox.; cash discount less than carload lots, 2%.

Atlas White } 1 to 100 sacks, \$2.00 sack,
Calaveras White } warehouse or delivery;
Medusa White }

Forms, Labors average \$40.00 per M.
Average cost of concrete in place, exclusive of forms, 35c per cu. ft.;
with forms, 60c.
4-inch concrete basement floor 12 1/2c to 14c per sq. ft.
Ret-profiling 7 1/2c
Concrete Steps \$1.25 per lin. ft.

Dampproofing and Waterproofing—

Two-coat work, 20c per yard.
Membrane waterproofing—4 layers of saturated felt, \$4.50 per square.
Hot coating work, \$1.80 per square.
Medusa Waterproofing, 15c per lb., San Francisco Warehouse.
Tricoat waterproofing.
(See representative.)

Electric Wiring—\$12.00 to \$15.00 per outlet for conduit work (including switches).
Knob and tube average \$3.50 per outlet.

Elevators—

Prices vary according to capacity, speed and type. Consult elevator companies.
Average cost of installing an automatic elevator in four-story building, \$2800; direct automatic, about \$2700.

Excavation—

Sand, 60 cents; clay or shale \$1 per yard.
Teams, \$12.00 per day.
Trucks, \$22 to \$27.50 per day.

Above figures are an average without water. Steam shovel work in large quantities, less; hard material, such as rock, will run considerably more.

Fire Escapes—

Ten-foot galvanized iron balcony, with stairs, \$115 installed on new buildings; \$140 on old buildings.

Floors—

Composition Floors—22c to 40c per sq. ft.
In large quantities, 16c per sq. ft. laid.
Mosaic Floors—80c per sq. ft.
Duraflex Floors—23c to 30c sq. ft.
Rubber Tile—50c to 75c per sq. ft.
Terazzo Floors—45c to 60c per sq. ft.
Terazzo Steps—\$1.60 lin. ft.

Hardwood Flooring (delivered to building)—

	1 1/2" x 3 1/2"	3 1/2" x 7"	3 1/2" x 9"
	T&G	T&G	5 1/2 Ed.
Clr. Qtd. Oak	\$144.00 M	\$122.00 M	\$141.00 M
Sel. Qtd. Oak	118.00 M	101.00 M	114.00 M
Clr. Pla. Oak	120.00 M	102.00 M	115.00 M
Sel. Pla. Oak	113.00 M	92.00 M	107.00 M
Clr. Maple	125.00 M	113.00 M	

Wage—Floor layers, \$10.00.
Note—Above quotations are all board measure except last column which is sq. ft.

Glass (consult with manufacturers)—

Double strength window glass, 20c per square foot.
Plate 75c per square foot (unglazed) in place, \$1.00.
Art, \$1.00 up per square foot.
Wire (for skylights), 40c per sq. foot.
Obscure glass, 30c to 50c square foot.
Glass bricks, \$2.40 per sq. ft., in place.
Note—If not stipulated add extra for setting.

Heating—

Average, \$1.90 per sq. ft. of radiation, according to conditions.
Warm air (gravity) average \$48 per register.
Forced air, average \$68 per register.

Iron—Cost of ornamental iron, cast iron etc., depends on designs.

Lumber (prices delivered to bidg. site).

No. 1 common	\$30.00 per M
No. 2 common	28.00 per M
Select O. P. common	35.00 per M
2x4 No. 3 form lumber	22.00 per M
1x4 No. 2 flooring VG	58.00 per M
1x4 No. 3 flooring VG	51.00 per M
1x6 No. 2 flooring VG	70.00 per M
1 1/4x4 and 6, No. 2 flooring	70.00 per M
Slash grain	
1x4 No. 2 flooring	\$45.00 per M
1x4 No. 3 flooring	42.00 per M
No. 1 common run T. & G.	33.00 per M
Lath	5.50 per M
Shingles (add cartage to price quoted)—	
Redwood, No. 1	\$1.10 per bdle.
Redwood, No. 2	1.00 per bdle.
Red Cedar	1.10 per bdle.

Plywood—Douglas Fir (add cartage)—

"Plyscord" sheathing (unsanded)
5/16" 3-ply and 48"x96" \$32.50 per M
"Plywall" (wallboard grade)—
3/4" 3-ply 48"x96" \$37.50 per M
"Plyform" (concrete form grade)—
5/8" 5-ply 48"x96" \$110.00 per M
Exterior Plywood Siding—
7/16" 5-ply Fir \$ 90.00 per M
Redwood (Rustic) 85.00 per M

Millwork—Standard.

O. P. \$85.00 per 1000. R. W., \$100.00 per 1000 [delivered].
Double hung box window frames, average with trim, \$6.50 and up, each.
Doors, including trim (single panel, 1 3/4 in. Oregon pine) \$8.00 and up, each.
Doors, including trim (five panel, 1 3/8 in. Oregon pine) \$6.00 each.
Screen doors, \$3.50 each.
Patent screen windows, 25c a sq. ft.
Cases for kitchen pantries seven ft. high, per lineal ft., \$8.00 each.
Dining room cases, \$8.00 per lineal foot.
Rough and finish about 75c per sq. ft.
Labor—Rough carpentry, warehouse heavy framing (average), \$17.50 per M.
For smaller work average, \$35.00 to \$45.00 per 1000.

Marble—(See Dealers)

Painting—

Two-coat work	per yard	42c
Three-coat work	per yard	60c
Cold water painting.....	per yard	10c
Whitewashing	per yard	4c
Turpentine, 65c per gal., in 5 gal. cans, and 55c per gal. in drums.		
Raw Linseed Oil—95c gal. in light drums.		
Boiled Linseed Oil—98c gal. in drums and \$1.08 in 5 gal. cans.		

White Lead in oil

	Per Lb.	
1 ton lots, 100 lbs. net weight.....	113/4c	
500 lbs. and less than 1 ton.....	12c	
Less than 500 lb. lots.....	12 1/2c	

Red Lead and litharge

1 ton lots, 100 lbs. net weight.....	113/4c
500 lbs. and less than 1 ton.....	12c
Less than 500 lb. lots.....	12 1/2c

Red Lead in oil

1 ton lots, 100 lbs. net weight.....	123/4c
500 lbs. and less than 1 ton.....	13c
Less than 500 lb. lots.....	13 1/2c

Note—Accessibility and conditions cause some variance in costs.

Patent Chimneys—

6-inch	\$1.25 lineal foot
8-inch	1.75 lineal foot
10-inch	2.25 lineal foot
12-inch	3.00 lineal foot

Plastering—Interior—

	Yard
1 coat, brown mortar only, wood lath	\$0.50
2 coats, lime mortar hard finish, wood lath	.85
2 coats, hard wall plaster, wood lath.....	.72
3 coats, metal lath and plaster.....	1.25
Keene cement on metal lath.....	1.30
Ceilings with 3/4 hot roll channels metal lath (lathed only).....	.90
Ceilings with 3/4 hot roll channels metal lath plastered.....	1.80
Single partition 3/4 channel lath 1 side (lath only).....	.85

Single partition 3/4 channel lath 2 inches thick plastered.....	\$2.90
4-inch double partition 3/4 channel lath 2 sides (lath only).....	1.70
4-inch double partition 3/4 channel lath 2 sides plastered.....	3.30
Thermax single partition; 1" channels; 2 1/4" overall partition width. Plastered both sides.....	2.50
Thermax double partition; 1" channels; 4 3/4" overall partition width. Plastered both sides.....	3.40
3 coats over 1" Thermax nailed to one side wood studs or joists.....	1.25
3 coats over 1" Thermax suspended to one side wood studs with spring sound isolation clip.....	1.45

Plastering—Exterior—

2 coats cement finish, brick or concrete wall.....	\$1.00
3 coats cement finish, No. 18 gauge wire mesh.....	1.50
Wood lath, \$5.50 to \$6.50 per 1000.....	.19
2.5-lb. metal lath (dipped).....	.21
3.4-lb. metal lath (dipped).....	.22
3.4-lb. metal lath (galvanized).....	.24
3/4-inch hot roll channels, \$72 per ton.....	
Finish plaster, \$18.90 ton; in paper sacks.....	
Dealer's commission, \$1.00 off above quotations, \$13.85 (rebate 10c sack).....	
Lime, f.o.b. warehouse, \$2.25 bbl.; cars, \$2.15.....	
Lime, bulk (ton 2000 lbs.), \$16.00 ton.....	
Wall Board 5 ply, \$50.00 per M.....	
Hydrate Lime, \$19.50 ton.....	
Plasterers Wage Scale.....	\$1.67 per hour
Lathers Wage Scale.....	1.60 per hour
Hod Carriers Wage Scale.....	1.40 per hour
Composition Stucco—\$1.80 to \$2.00 sq. yard (applied).....	

Plumbing—

From \$70.00 per fixture up, according to grade, quantity and runs.

Roofing—

"Standard" tar and gravel, \$6.00 per sq. for 30 sqs. or over.
 Less than 30 sqs. \$6.50 per sq.
 Tile, \$20.00 to \$35.00 per square.
 Redwood Shingles, \$7.50 per square in place.
 Copper, \$16.50 to \$18.00 per sq. in place.
 Cedar Shingles, \$8.00 per sq. in place.
 Re-coat with Gravel, \$3 per sq.
 Asbestos Shingles, \$15 to \$25 per sq. laid.

Slate, from \$25.00 per sq., according to color and thickness.
 Shakes—1x25" resawn \$11.50 per sq.
 1/2x25" resawn 10.50 per sq.
 1/2x25" tapered 10.00 per sq.
 Above prices are for shakes in place.

Sheet Metal—

Windows—Metal, \$1.75 a sq. foot.
 Fire doors (average), including hardware \$1.75 per sq. ft.

Skylights—(not glazed)

Copper, 90c sq. ft. (flat).
 Galvanized iron, 30c sq. ft. (flat).
 Vented hip skylights 60c sq. ft.

Steel—Structural

\$120 ton (erected), this quotation is an average for comparatively small quantities. Light truss work higher. Plain beams and column work in large quantities \$97 to \$105 per ton.

Steel Reinforcing—

\$80.00 to \$120.00 per ton, set.

Stone—

Granite, average, \$6.50 cu. foot in place.
 Sandstone, average Blue, \$4.00, Boise, \$3.00 sq. ft. in place.
 Indiana Limestone, \$2.80 per sq. ft. in place.

Store Fronts—

Copper sash bars for store fronts, corner center and around sides, will average 75c per lineal foot.
 Note—Consult with agents.

Tile—Floor, Wainscot, etc.—(See Dealers)

Asphalt Tile—18c to 28c per sq. ft. installed.

Wall Tile—

Glazed Terra Cotta Wall Units (single faced) laid in place—approximate prices:
 2 x 6 x 12 \$1.00 sq. ft.
 4 x 6 x 12 1.15 sq. ft.
 2 x 8 x 16 1.10 sq. ft.
 4 x 8 x 16 1.30 sq. ft.

Venetian Blinds—

40c per square foot and up. Installation extra.

SAN FRANCISCO BUILDING TRADES WAGE SCALES

All crafts 8 hour day (except as otherwise noted) and 5 day week. Effective as of May 1, 1940.

CRRAFT	Journeyman Mechanics	CRRAFT	Journeyman Mechanics	CRRAFT	Journeyman Mechanics
Asbestos Workers	\$10.00	Millwrights	10.00	\$Dump Truck Drivers, 3 yards	7.50
*Bricklayers	10.50	Mosaic and Terrazzo Workers	8.00	\$Dump Truck Drivers, 4 yards	8.00
*Bricklayers' Hodcarriers	7.50	†Painters	8.75	\$Dump Truck Drivers, 5 yards	8.00
Cabinet Workers (outside)	10.00	Pile Drivers and Wharf Builders	11.20	\$Dump Truck Drivers, 6 yards	8.50
Caisson Workers (Open)	8.80	*Pile Drivers Engineers	12.80	Truck Drivers of Concrete Mixer	
Carpenters	10.00	*Plasterers	10.00	Trucks:	
Cement Finishers	10.00	*Plasterers (Hodcarriers)	8.40	2 yards or less	8.00
Electricians	11.00	Plumbers	11.20	3 yards	8.57
Elevator Constructors	12.00	Roofers	9.68	4 and 5 yards	9.14
Engineers (Portable and Hoisting)	10.00	Sheet Metal Workers	10.00	6 yards	9.71
Glass Workers	9.68	Sprinkler Fitters	11.00	EXPLANATION:	
‡Housesmiths, Ornamental Iron		Steamfitters	11.00	*—6 Hour Day.	
(Shop and Outside)	10.00	Stair Builders	10.00	†—7 Hour Day.	
Housesmiths, Reinf. or Rodmen	10.50	Stone Cutters	9.00	‡—Term "Architectural Iron" no longer used. This craft "Ornamental Ironworker."	
Ironworkers (Bridge and Structural—Engineers)	12.80	*Stone Setters	10.50	\$—Dump Truck Drivers work 7 HOURS ON PUBLIC WORK, 8 HOURS ON PRIVATE WORK; starting time 7:30 A.M.	
Laborers (Building and Common)	6.50	Tile Setters	11.00		
*Lathers	9.60	Welders, Structural Steel Frame on Buildings	12.80		
Marble Setters	10.50	\$Dump Truck Drivers, 2 yards or less	7.00		

MODERN PLASTICS COMPETITION

The Fifth Annual Modern Plastics Competition is now launched on an intensive campaign for plastic entries. Through this medium the latest developments and improvements in plastic materials and the techniques of handling them are made known.

The competition is open, without fee or obligation of any kind, to all companies using plastics for their products, to designers, engineers, molders, laminators, fabricators, raw material suppliers, and machinery and mold manufacturers. Any object or product designed or placed on the market since September 1st, 1939, in which any sort of plastic material is a component part, is eligible for entry. The competition and concurrent display of entries will be held at the offices of Modern Plastics Magazine, Chanin Building, 122 East 42nd Street, New York City. The final deadline for all entries is August 15th.

Because of the startling new innovations effected this past year, especially in the furniture and architectural field, a re-classification and expansion of the various divisions has been made. Entries will be grouped according to the type of application or according to the industry or field in which they are being used.

The new classifications are: 1. Architecture, 2. Business and Office Equipment, 3. Communications, 4. Decorators' Accessories, 5. Furniture, 6. Household, 7. Lighting, 8. Machinery & Appliances (Industrial), 9. Novelties, 10. Scientific, 11. Sporting Goods, Games and Toys, 12. Style and Fashion, 13. Transport, 14. Miscellaneous. There will be three awards of equal standing in each group.

THE GUTENBERG BIBLE

An interesting feature of the printing exhibit at the Fair is a rare copy of the Gutenberg bible, first and most valuable of all printed books, shown by courtesy of Yale University. The treasured volume is one of six perfect copies in the United States, is on paper and is bound in two volumes in early eighteenth century calf, with gilt tooled backs. Copies on vellum are in the Library of Congress and the Huntington Library at San Marino.

The Guttenberg bible is sometimes called the 42-line or Mazarin bible, from its page format and from the fact that the first known copy was discovered in the library of the French cardinal. It contains 1,282 pages, printed in Latin, and many experts declare that in composition, press-work, color illumination and binding its craftsmanship has never been surpassed.

The world's first and greatest printed work is undated and does not indicate the place of publication or the printer.

APPROVE PUBLIC HOUSING

Denoting the interest in public housing on the Pacific Coast, the University of California, in Berkeley, has established a lectureship course under the auspices



California's Hotel Beautiful

—like a country estate
yet in the heart of a throbbing
metropolitan area.
—a matchless view—
comfortable, luxuriously furnished
rooms, excellent cuisine.
—in an atmosphere of quiet
and gracious living.

Rooms, with bath, \$2.50 to \$5.00 per day.

Attractive monthly rates

HOTEL CLAREMONT • BERKELEY

We are proud of our frequent participation in buildings designed by Clarence W. W. Mayhew, Architect.

ALADDIN HEATING CORP.
2222 San Pablo Avenue
OAKLAND, CALIFORNIA

ACOUSTI-CELOTEX

for office-quieting provides . . .

- PAINTABILITY
- PERMANENT LIGHT-REFLECTION
- HIGH EFFICIENCY

Acoustical Engineers & Contractors

WESTERN ASBESTOS CO.

Building Materials *Mechanical Specialties*
SACRAMENTO OAKLAND
SAN FRANCISCO

POMONA TILES

FOR
Bathrooms and Kitchens
in over 60 colors

Warehouses and Display Rooms

135 Tenth St. San Francisco
629-33 North La Brea Ave. Los Angeles
6106 Roosevelt Way Seattle

POMONA TILE MFG. CO.
PLANT — POMONA, CALIF.

STRUCTURAL STEEL

For Class A Buildings,
Bridges, etc.

JUDSON PACIFIC CO.

1200 SEVENTEENTH STREET
SAN FRANCISCO

Plants: San Francisco - Oakland

A Permanent Exposition
of the newest ideas
in home planning
and equipment.



THE BUILDING MATERIAL EXHIBIT

Architects Bldg. • Fifth & Figueroa • Los Angeles • MU-6306

of the Rosenberg Foundation, a California corporation for charitable purposes. Catherine Bauer, special consultant of the USHA, opened the course this spring with a series of lectures to upper division and graduate students and faculty members.

New York State educational institutions are particularly active in the public housing field. Columbia University, New York University and the University of Buffalo gave the subject an important place in their curricula.

Columbia University is offering what is believed to be the first graduate degree in housing offered by an American university. Students in the School of Architecture, beginning in the college year 1940-1941, may work towards the degree of "Master of Science in Planning and Housing." The course, under Carl Feiss, assistant professor of architecture, is open to graduates of accredited schools of architecture or landscape architecture, or of civil, architectural or general engineering.

NEW INSULATING BOARD FOR INTERIORS

Thousands of contractors and builders who specialize in the remodeling of stores, homes and offices are finding that inside resurfacing with Satincote, Insulite's new interior insulating board, makes rooms not only more comfortable but more beautiful.

The new product has other qualities than beauty. The selected wood fibers used in its construction are so interlaced that millions of tiny air cells entrapped within it resist the passage of heat from inside to outside in winter, and from outside to inside in summer. It also has exceptional sound-deadening and light-reflection qualities.

More remarkable still, the new Satincote interior board is very easily washed. Vigorous scrubbing with soap and water does not injure it in any way.

WASHINGTON UNIVERSITY AWARDS

Awards made in the Department of Architecture, University of Washington, at the recent close of the academic year, were as follows: The gold medal of the American Institute of Architects for most meritorious work in design, to Robert J. Massar; second A.I.A. prize for work in design, the book "Mont San Michele and Chartres," to Harvey A. Warren; the Alpha Eho Chi medal for service and merit, to Rolland O. Simpson.

NEW SPOKANE CHAPTER

The new Spokane Chapter, A.I.A., has elected the following officers: President, Harold C. Whitehouse; first vice-president, G. Albin Pehrson; second vice-president, Stanley A. Smith; secretary-treasurer, Edwin J. Peterson; executive committee member-at-large, Henry C. Bertelsen; corresponding secretary, Ogden F. Beeman.

JUNE BUILDING SHOWS INCREASE

Building activity in the territory covered by "Architects' Reports" for June showed a very material increase over May, due to the award of several big Government contracts totaling over \$30,000,000 as against \$6,000,000 the previous month. Contracts for private industrial work, schools and colleges also showed considerable increase.

The current month (July) has started out well with two substantial projects, long contemplated, that have finally reached stages of action. One is the award of a contract to the Clinton Construction Company for a fifteen-story steel and reinforced concrete Appraisers' Store & Immigration building at Sansome and Washington streets, San Francisco, for \$4,000,000, and the other is the announcement by the Bank of America that it will proceed with construction of a twelve-story Class A bank and office building at Pine and Montgomery streets, San Francisco, at a cost of \$2,000,000. Following are the totals under the three main classifications:

Plans in Preparation

Apartments	\$2,000,000
Residences	98,000
City, County & State.....	375,000
Government	330,000
Schools & colleges.....	1,125,319
Hotels, churches & theaters.....	427,000
Office buildings	919,000
Stores & markets.....	15,000
Industrial	40,000

\$ 5,329,319

Projects Out For Bids, But Not Awarded

Apartments	\$ 61,667
Residences	143,000
City, County & State	199,127
Government	4,148,143
Schools & colleges.....	512,028
Churches, theaters, etc.	384,724
Office buildings	100,000
Stores & markets	141,880
Industrial	102,000

\$6,192,569

Contracts Awarded

Apartments	\$ 287,600
Residences	324,110
City, County & State.....	587,952
Government	30,248,907
Schools & colleges.....	1,358,143
Churches, theaters, etc.	588,143
Office buildings	167,870
Stores & markets.....	629,214
Industrial	1,852,529

\$36,044,468

\$47,566,356

A good investment—

is a well designed, well built structure, properly located.

Lindgren & Swinerton, Inc.

have been building substantial buildings for over a half of a century, are still building them and will continue building them for another half a century.

Lindgren & Swinerton, Inc.

Standard Oil Building
San Francisco
619 H Street
Sacramento

605 W. Olympic Boulevard
Los Angeles
1723 Webster Street
Oakland

B. SIMON HARDWARE CO.

800 TO 824 BROADWAY, OAKLAND

Most of the Fine

BUILDERS HARDWARE

in the beautiful Homes

built by

CLARENCE W. W. MAYHEW

Furnished by B. Simon Hardware Co.
Established Since 1900

FRANK J. McCOY HOTELS

SANTA MARIA INN—Santa Maria, California • Geo. A. Thompson, Mgr.

WORLD FAMOUS STOP-OVER, BETWEEN SAN FRANCISCO AND LOS ANGELES

EL ENCANTO HOTEL & VILLAS—Santa Barbara, California • Fred E. Pimentel, Mgr.

AMERICA'S HOTEL BEAUTIFUL, IN A MATCHLESS SETTING ON THE RIVIERA

HARER Gas Furnaces SAVE

many of Clarence W. W. Mayhew's satisfied clients use HARER FURNACES.

•

HARER FURNACE & SUPPLY CO.

829 31st Street • Oakland, Calif.



QUALITY AND DEPENDABLE *Service*

are the factors that influence architects and contractors when selecting lumber and mill work — Quality of merchandise — Integrity and Ability of the firm—Service in physical equipment — Experience and Personnel — All these factors contribute to a speedy and satisfactory completion of construction with minimum of time and expense.

MANUFACTURER OR DEALER IN

Douglas Fir—Redwood—Sugar and Ponderosa Pine — Plywood and Concrete Form Panels — Sash and Doors — Millwork — Insulation — Builders' Hardware.

E. K. WOOD LUMBER CO.

"Goods of the Woods" ©

LOS ANGELES • SAN FRANCISCO • OAKLAND

Paramount
 BY
Paramount
 BUILT-IN FIXTURE COMPANY
 5107 Broadway, Oakland, California
 Phone Piedmont 8100

Many of the beautiful homes designed by Clarence W. W. Mayhew, and illustrated in this issue are equipped with PARAMOUNT kitchen cabinet fixtures.

We manufacture three complete lines: "DELUXE," "MODERNE" and "ECONOMY," also Medicine cabinets, Ironing boards, Phone cabinets, Shoe racks.

Paramount Cabinets are distinctive in design and construction and embody the latest improvements and refinements in their manufacture.

24-HOUR CEMENT SAVES DOLLARS FOR SAN FRANCISCO MERCHANTS



PAVING PLANT AT WORK ON POST STREET,
SAN FRANCISCO

A SAVING of 64 days in concrete hardening time in paving eight blocks of Post Street in downtown San Francisco was recently demonstrated through the use of Golden Gate 24-Hour Portland cement. Merchants whose stores fronted on Post Street realized savings of thousands of dollars, due to the shortened period in which their frontage was blocked.

According to Chas. L. Harney, San Francisco, contractor for the job, heavy working traffic was allowed on the new pavement within 48 hours, the time being set by municipal standard specifications. With ordinary cement it is necessary to wait 10 days. Thus a saving of 8 days per block was effected through the use of 24-Hour cement. Light delivery trucks were allowed on the new pavement in 14 hours and automobile traffic was permitted in 24 hours.

The 24-Hour cement used on this project is manufactured by the Pacific Portland Cement Company in its Redwood City plant. According to J. A. McCarthy, president, his company pioneered early-hardening cement on the Pacific Coast.

Messrs. Hall and Preghoff of San Francisco are the structural engineers of the new U. C. administration building, Berkeley.

*Here's
Better Business
for You*
**BANKING
BY MAIL**

We can help your business by making some of your work easier. With our Bank-by-Mail Service you save time and trouble by handling most details right in your office, store or home, day or night when most convenient. Why not open an account today, by mail?

**CROCKER FIRST
NATIONAL BANK**
OF SAN FRANCISCO

California's Oldest National Bank
Member Federal Deposit Insurance Corporation

**Clinton
Construction Co.**
of California
General
Contractors

923 Folsom Street
San Francisco
SUtter 3440

**JOHN
CASSARETTO**

—Since 1886—And Still Active—

Building Materials

READY MIX CONCRETE
ROCK - SAND - GRAVEL - LIME
CEMENT - PLASTER - MORTAR
METAL LATH - WOOD LATH
STUCCO - WIRE NETTING

Service Unexcelled

Bunkers

Sixth and Channel, San Francisco
Phones: GARfield 3176, GARfield 3177

**CALIFORNIA HOME BUILDING
CONTINUES UPWARD SWING**

California will continue for some time to top all states in residential construction and to maintain its national lead for insured mortgage financing, in the opinion of D. C. McGinness, district director of the Federal Housing Administration in Northern California.

He pointed out that the influx of "Fair in '40" visitors already is under way, and with them are many who came to see the Exposition last year and are returning to establish homes here. This is reflected, he said, through increasing inquiries for information on the Federal Housing plan of home financing.

"Other reasons for these deductions are many," declared the housing director. "In the first place, California is a state in which somebody from almost everywhere hopes some day to live, and eventually to own homes of their own. Thus we have precisely an inexhaustible reservoir from which to draw.

"Considerable publicity has been given by national magazines to the opinion that the California home owner is getting greater value per dollar invested than in most any other locality. By that is meant our construction requirements differ vastly, because we do not have severe weather conditions to contend with. Our even climate here simplifies housing standards, thus construction costs are reduced, and values maintain an even keel."

Mr. McGinness said this appeals particularly to families whose incomes restrict them to small, low-priced homes. He stated that hundreds of attractive five-room small homes, modern and convenient in every detail but lacking some of the refinements of more costly homes, now are being built in Northern California for as little as \$2500 each.

When a modern house of sufficient size to comfortably house an average family can be bought for as little as about \$200 down, and paid for with

MILLWORK

IN MANY OF THE
houses pictured in this issue
and designed by Clarence
W. W. Mayhew

FURNISHED BY

**LANNOM BROS.
MANUFACTURING CO.**

HIGH GRADE MILLWORK
AND INTERIOR FINISH
SASH AND DOORS



Fifth and Magnolia Streets

Oakland, California

Telephone TEmplebar 3663

VAUGHN - G. E. WITT Co.

Manufacturers and Distributors

Pump Governors	Oil Heaters
Safety Pump Governors	Relief Valves
Automatic Gas Regulating Valves	Oil Burner Governors
Gas Burning Equipment	Oil Burners
Vacuum Pump Governors	Oil Pumping Sets
Vacuum Regulating Valves	Oil Valves
Continuous Flow Steam Traps	Oil and Steam Strainers
Thermostats	Duplex Oil Pumps
Reducing Valves	Rotary Oil Pumps
	Boiler Feed Pumps
	Water Heaters
	Boiler Feed-Water Regulators

4224-2B Hollis St., Emeryville, Oakland

**V E R M O N T
M A R B L E
C O M P A N Y**

Producers and Finishers
of

Domestic and Imported
Marbles

San Francisco
Los Angeles
and
Tacoma, Wash.

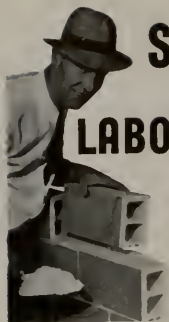

**SAVE $\frac{1}{3}$
ON
LABOR COSTS**

**With Kraftile
Terra Cotta
Wall Units**

They're pre-tiled on one or both sides. Thus a Kraftile Wall Unit partition literally "tiles itself"—reducing labor costs on partitions as much as one-third.

Kraftile Wall Units are in use in laboratories, food plants and other buildings in 21 states, Canada and Hawaii. For further information, write Kraftile Company, Niles, California.

**KRAFTILE TERRA COTTA
WALL UNITS**

**DINWIDDIE
CONSTRUCTION
COMPANY**

BUILDERS

CROCKER BUILDING
SAN FRANCISCO

TILE & LINOLEUM

Specified by

CLARENCE W. W. MAYHEW
for many of the beautiful homes
illustrated in this issue.

Installed by

Superior Tile Co.

4939 Broadway Oakland, Calif.

monthly installments approximating, \$25, home ownership becomes far more attractive than paying rent," he declared. "Under present Federal Housing regulations this not only is possible, but practical, and as a result thousands of families today are buying home equities instead of rent receipts."

BOULDER DAM REVENUES

The demand for Boulder Dam's electric energy and resultant revenues have outstripped all expectations, Commissioner John C. Page, Bureau of Reclamation, has reported to Secretary of the Interior Harold L. Ickes.

Summing up three years of power operations at the world's greatest power plant, revenues from which will be enough to pay for the entire cost of the world's highest dam, the world's largest reservoir, and the power plant, Commissioner Page advised that the gross income was about \$2,000,000 ahead of that anticipated when financial plans for the pioneer among the government's multi-purpose hydro projects were first drawn up.

Income for the present fiscal year is expected to exceed \$4,500,000, bringing power plant revenue received from July 1, 1927 to June 30, 1940, under Boulder's 50-year power contracts, to approximately \$11,300,000.

As a consequence, Mr. Page said, the Bureau of Reclamation is preparing to turn over to the U. S. Treasury another \$1,000,000. This will bring repayments to the Treasury for the present fiscal year from Boulder's power plant to \$3,700,000.

It will bring total Treasury payments from the power plant, since the beginning of operations on October 11, 1936, to the 8-digit figure of \$10,200,000.

Gross income from the plant has shown steady increase as generators of unparalleled size have been installed one after the other to meet the unexpected demand for energy.

The first customer was the City of Los Angeles, to which power was transmitted October 9, 1936. The city celebrated the event with a "Pageant of Light." Huge arc lights on its city

**MULLEN MFG.
COMPANY**

**BANK, STORE AND OFFICE
FIXTURES—CABINET WORK
OF GUARANTEED QUALITY
CHURCH SEATING**

Office and Factory:
60-80 RAUSCH ST., Bet. 7th and 8th Sts.
San Francisco
Telephone UNDERhill 5815

**G. P. W.
JENSEN & SON**

Building Construction

320 Market Street, San Francisco
Phone: GARfield 2444

**Smith
Lumber Company**
WHOLESALE - JOBBING - RETAIL
FACTORY AND BUILDING LUMBER
PLYWOODS - ROOFING

DISTRIBUTING YARDS

San Francisco	Oakland
4th & Channel	19th Ave. & Estuary
MArket 0103	FRuitvale 3174

YOUR INQUIRIES SOLICITED

SISALKRAFT
REG. U. S. PAT. OFF.

**"More than a
building paper"**

THE SISALKRAFT CO.

205 West Wacker Drive
(Canal Station) Chicago, Ill.
55 New Montgomery Street
San Francisco, Calif.

ABBOT A. HANKS, INC.
Engineers & Chemists

INSPECTING — TESTING — CONSULTING
CONCRETE • STEEL • MATERIALS
CHEMICAL AND TESTING
LABORATORIES
• RESEARCH AND INVESTIGATION •

TESTS OF STRUCTURAL MATERIALS
DESIGN OF CONCRETE MIXES
SHOP AND ERECTION INSPECTION OF
STRUCTURES AND EQUIPMENT
INVESTIGATION OF STRUCTURES
AND MATERIALS
TESTS AND INVESTIGATION OF
FOUNDATION SOILS
FIRE RESISTANCE AND INSULATION
TESTS

624 Sacramento Street, San Francisco

**JOSEPH MUSTO
SONS-KEENAN
CO.**

**MARBLE
and ABRASIVES**

ONYX

535 NORTH POINT STREET
SAN FRANCISCO
1801 S. SOTO STREET
LOS ANGELES

**U.S.
PRODUCTS**
VAN ARSDALE-HARRIS CO.

ENGINEERS & CONTRACTORS
ACOUSTICAL TREATMENT
INSULATION
SOUND CONTROL
Fifth and Brannan Streets
San Francisco, Calif.
Telephone GARfield 3600

Division
VAN ARSDALE-HARRIS
LUMBER CO., INC.

**FINE WATER COLORS
AND PAPERS
FOR ARCHITECTURAL
RENDERINGS**

**H. S. CROCKER
COMPANY, Inc.**

720 MISSION STREET
MARKET STREET AT SECOND
SAN FRANCISCO

hall blazed with electricity sent from Boulder, 266 miles away.

Regular service to Los Angeles from the power plant's initial generating unit started two weeks later on October 22. Three more generating units for Los Angeles went into operation as rapidly as possible, on November 14, 1936, December 28, 1936, and March 18, 1937.

The four generating units create power for municipalities in Southern California. The Bureau of Power and Light of Los Angeles operates them for Los Angeles, Pasadena, Burbank and Glendale, California; Las Vegas, Nevada, and other cities.

Boulder now has 10 high-tension transmission lines extending from its power plant to customers hundreds of miles away. Two lines extend to Los Angeles, 266 miles away. Another line goes to Chino, California, 233 miles off. A third goes to San Bernardino, California, 222 miles distant. Other lines go to Hayfield, California; Parker, Arizona; Kingman, Arizona; Needles, California; Pioche, Nevada, and Las Vegas, Nevada, and, of course, Boulder City.

In addition to making available to the southwestern United States large blocks of low-cost electric energy, the gigantic multi-purpose irrigation project built by the Bureau of Reclamation creates other valuable benefits.

The Boulder Canyon Project renders remote the danger from destructive Colorado River floods, provides an invaluable water supply for irrigation and domestic use, and has created an increasingly important recreational center and wildlife refuge.

In submitting his report to the Secretary, Commissioner Page said: "Three years of permanent contract operation of Boulder Dam has conclusively demonstrated that the project is one of the Government's finest investments. It will pay its own way and bring great benefits to the entire Southwest. The Bureau is proud of being its creator."

The sincere service of an architect is the most valuable help a prospective home owner can have. . . The architect who best coordinates the work of manufacturers and craftsmen in the complex homes of today enjoys success.

We congratulate

Mr. Clarence W. W. Mayhew
on the outstanding examples
of residences in this issue.

Kitchen Planning Service

Peerless
Built-In Furniture
Lino-Metal Drainboards
Hard Maple Drainboards
Chrome Leg Furniture
Breakfast nook Equipment

All assure you of quality and modern kitchen.



**PEERLESS BUILT-IN
FIXTURE COMPANY**

2608 San Pablo Avenue
Berkeley, California

**Pacific
Manufacturing
Company**

High Class Interior Finish
Quality Millwork

142 Sansome St. 6820 McKinley Ave.
San Francisco Los Angeles
GARfield 7755 THornwall 4196

1315 Seventh Street, Oakland
GLEncourt 7850

THE MOST COMPLETE LINE
OF STEELS AND STEEL BUILD-
ING MATERIALS MADE BY A
SINGLE PRODUCER



See Sweet's Catalog File or write us for
full information.

Republic Steel Corporation

General Offices: Cleveland, Ohio
Denver, Colo. Continental Oil Bldg.
Los Angeles, Calif. Edison Bldg.
Salt Lake City, Utah Walker Bank Bldg.
San Francisco, Calif. Rialto Bldg.
Seattle, Wash. White-Henry-Stuart Bldg.

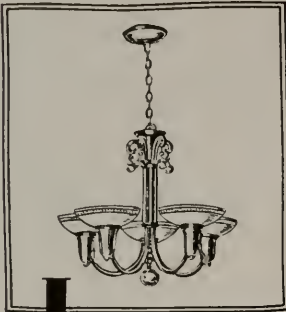

INDIRECT

A fixture to impress your guests with its beauty and your good taste. Your home is only as lovely as its lighting.

So—may we offer the assistance of our "lighting stylists" in selecting the correct fixtures on your limited budget?

INCANDESCENT SUPPLY COMPANY

726 MISSION ST., SAN FRANCISCO

Phone GARfield 1164

Hunter & Hudson

Consulting Engineers

DESIGNERS OF HEATING
AIR CONDITIONING
VENTILATING AND WIRING
SYSTEMS, MECHANICAL
AND ELECTRICAL EQUIP-
MENT OF BUILDINGS



41 SUTTER STREET
ROOM 710

San Francisco California

Robert W. Hunt Company

ENGINEERS

Inspection • Tests • Consultation

Schools and Other Structures
Are Built as Designed

*When Construction Materials are
Inspected at point of Manufacture
and during Erection by*

ROBERT W. HUNT COMPANY

*Cement, Concrete, Chemical, Metallurgical,
X-Ray and Physical Laboratories*

Chicago • New York • Pittsburgh
Los Angeles • All Large Cities
San Francisco, 251 Kearny Street

SCHOOLS FOR LITTLE TOTS

Nursery schools in which small children may be cared for during the day time while their parents are away at work or otherwise engaged, are now being utilized by low income families residing in 40 public low-rent housing projects built under the national slum-clearance program.

According to the results of a survey, the schools, designed to promote physical well-being as well as providing properly supervised recreational and moral training, are sponsored mutually by the tenants and supervised by teachers and instructors furnished by local public and private welfare agencies.

Designed primarily for children under 6 years of age, the nursery facilities, in general, are conducted in social and playground spaces provided as part of the non-dwelling facilities of public housing projects constructed under the USHA program.

In many instances, children of families from throughout the neighborhood join with the children of the tenants in recreational activities.

The principle back of this particular type of social activity is in keeping with the general philosophy of the whole rehousing movement in that the children who formerly lived in the blight and shadows of the slums should be given an opportunity for a better way of living as well as being provided with fit, new, safe and sanitary homes.

DOUBLE GLASS WINDOWS NEXT

Possibilities of reducing heat loss through windows, as much as 50 per cent in some cases, by use of two lights of glass with an air space between them in lieu of one light in each pane, is being investigated by the American Society of Heating and Ventilating Engineers Research Advisory Committee on Air Conditioning Requirements of Glass, of which M. L. Carr, Pittsburgh, Pa., is chairman.

Not only does use of such additional lights cut down heat loss through windows, but condensation and frost on them are greatly reduced.

INCLUDE TREES IN YOUR PLANS

DAVEY, ORIGINATOR OF TREE SURGERY, OFFERS FREE INSPECTION AND ESTIMATE.



SAN FRANCISCO Sutter 3377
Russ Bldg.

FRESNO
Matter Bldg.

LOS ANGELES Tucker 1929
Story Bldg.

Local phones in: Pasadena, Palo Alto,
Oakland, San Rafael, San Mateo

SKILL - KNOWLEDGE -
RESPONSIBILITY

THE TORMEY COMPANY

GENERAL PAINTERS
AND DECORATORS

Phone Underhill 1913

563 FULTON STREET
San Francisco

Donovan Automatic Awning Type Windows

Give 100% natural ventilation
and day-lighting control

UNIVERSAL WINDOW
COMPANY
Berkeley, California

This is due to the fact that the outer light affords a certain amount of protection which raises the temperature of the inner light much higher than that of a single pane. For the same reason, people will feel more comfortable near windows with double lights than near windows with single lights when low out-door temperatures prevail.

ARCHITECTS AND U. S. DEFENSE

A nationwide survey to ascertain how every architect in the United States may most effectively aid in the defense program has been undertaken by the American Institute of Architects.

Questionnaires have been sent to approximately 14,000 architectural firms and offices, requesting each to indicate the extent and character of its practice, its personnel, equipment, and facilities, and the type of work it knows it can best perform. The information will be classified and made available to the Federal Government.

A similar survey is being carried out by the engineering profession in cooperation with the Institute, so that a complete catalogue of the nation's construction resources may be readily accessible.

The Institute's preparedness program, which also involves the selection of competent architects for direct participation in the planning and carrying out of defense measures, is under the direction of a committee on preparedness headed by Stephen F. Voorhees of New York.

An emergency now confronts our nation and those who are guiding its affairs are organizing the national resources to meet that emergency. "It is not enough that existing establishments which contribute to the defense program must be expanded.

"New plants must be created to provide new facilities and new communities built to shelter those who are to operate the new plants and facilities. Construction of all types is contemplated under the defense measures, and that construction must be completed in the shortest possible

ILLUSTRATIONS OF SUPERIOR CONSTRUCTION



CONSOLIDATED Motors Inc. Garage, Phoenix, Arizona
—H. H. Green, Architect. Summerbell Trusses spanning the wall to wall in this 102-ft. wide building, permit the utilization of the entire floor area. Absence of posts is essential in such a building, and the Summerbell Trusses make this possible as well as provide a safe, strong, and dependable roof support.

SUMMERBELL ROOF STRUCTURES
LOS ANGELES • OAKLAND • PHOENIX
TIMBER STRUCTURES, INC., PORTLAND

ROOFS OF WOOD—BUILT TO ENDURE



HERRICK IRON WORKS

STRUCTURAL STEEL
REINFORCING STEEL

18TH AND CAMPBELL STS.
OAKLAND, CALIF.
Phone GLencourt 1767

Independent Iron Works

Structural Steel
Ornamental Iron
Steel Service Stations
Steel Tanks
Standard Steel Mill Buildings
Bridges

821 Pine Street Oakland

FORDERER CORNICER WORKS

Manufacturers of
Hollow Metal Products
Interior Metal Trim
Elevator Fronts and Cabs
Metal Plaster Accessories
Sanitary Metal Base
Metal Cabinets
Flat and Roll Metal Screens
Commercial Refrigerators

269 POTRERO AVE.
San Francisco, Calif.
HEmlock 4100

"AMERICAN MARSH" Redi-Vac Vacuum Heating Pump

Send for
Bulletin 441

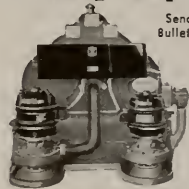

SIMONDS MACHINERY CO.
San Francisco Los Angeles
816 Folsom St. 455 East Fourth St.

**ANDERSON
&
RINGROSE**

General Contractors

320 Market Street, San Francisco
Phone GAfield 2245

BASALITE

CAMBERED
SHINGLE TILE

PERMANENT • FIREPROOF
STORMSAFE • COLORFUL
ECONOMICAL

Manufactured by

Basalt Rock Co., Inc.

NAPA, CALIFORNIA

**Melrose Lumber
& Supply Co.**

LUMBER AND
MILL WORK

46th Ave. and E. 12th St.
Oakland

Phone: FRuitvale 0251



MERCURY PRESS

We Print
The ARCHITECT and
ENGINEER

"A Thing of Beauty
Is a Joy Forever"

942 HOWARD STREET
SAN FRANCISCO

time if the program is to be successful.

"To carry on an emergency construction program of the magnitude of the one contemplated will require the intensified efforts of all branches of the construction and production industries of our nation and the complete cooperation of all its factors. To know exactly what construction resources are quickly available and can be depended on, each factor must survey its resources and report what it has of personnel, equipment, experience and capabilities. From these reports of the ability of organizations and individuals to fit into the national defense program and to render services most promptly and efficiently can be determined.

"The American Institute of Architects has committed the profession of architecture to the nation and to the Federal Government for this emergency. It has guaranteed the full cooperation of the profession as a whole and individually.

"This survey of the architectural profession is being undertaken cooperatively with the engineering professions. The questionnaire is the same for the professions and was prepared by representatives of the engineering professions and the preparedness committee of the Institute. The questionnaire is being issued to engineers by the respective engineering societies that are concerned with construction, such as the civil, mechanical, electrical, hydraulic engineers, etc. All engineering questionnaires are returnable to the Engineering Society in New York, whereas those of the architects are returnable to the Institute in Washington, via the regional representatives of the committee on preparedness.

"Thus there will be two major survey files, one of the architectural profession at the Institute headquarters in Washington, and one of the engineering professions at their headquarters in New York. The architectural files will be open to the engineering profession for inspection, and vice versa, and both files will be available to the Government."

Hundreds of responses already have been received and the replies are being assembled at the national headquarters of the Institute in Washington, D. C., where a complete inventory of architectural facilities, personnel and resources will be placed at the service of the government.

The architects responding have been classified according to their capacities and availability, their regional districts, and alphabetically.

"The Institute has taken this census of the architects and classified them in order that the Federal Government shall have available a dependable list from which it can select those who can serve it best," Mr. Bergstrom has announced. "Those on the list are ready to go to work immediately as firms, individuals, or groups, as will best forward the particular project they are engaged for. If it will be of further aid, we stand ready to advise in the selection of those who are best fitted to plan any particular work, and to form them into groups under able leadership, wherever a group service is indicated."

PETER BRADLEY

Plastering

639 Brannan Street

San Francisco • GAfield 7368

Contractor on John G. Rapp Building,
San Francisco. Clarence W. W. May-
hew, Architect.

Golden Gate Atlas

TRANSIT
**MIX CONCRETE
AND MORTAR**

**PACIFIC COAST
AGGREGATES, Inc.**

16th and Harrison Streets
85 Second Street San Francisco

ARCHITECT
AND
ENGINEER

AUGUST, 1940

CHALLENGE TO MODERN ARCHITECTURE



Hillside Charm • Hearthside Content

ALL-GAS EQUIPMENT COMPLETES HAPPY SOLUTION OF INTERESTING PROBLEMS

This gas-equipped Spanish home for Mr. and Mrs. Harry R. Butler is ideally adapted to its sloping, oak-studded site in Hillsborough, Calif. ☆ With professional skill, architect Leo J. Sharps solved his problem of design and equipment. ☆ Modern forced-air gas heating spreads comfort to every room, circulating warm air in winter, cool air in summer. An automatic gas storage water heater keeps hot water "on tap" 24 hours a day. And note, in photo at left, how the new gas range accents kitchen charm—utility and beauty combined. ☆ Architects, builders, owners agree: All-gas planning is the sure way to make a *house* into a *livable home*.

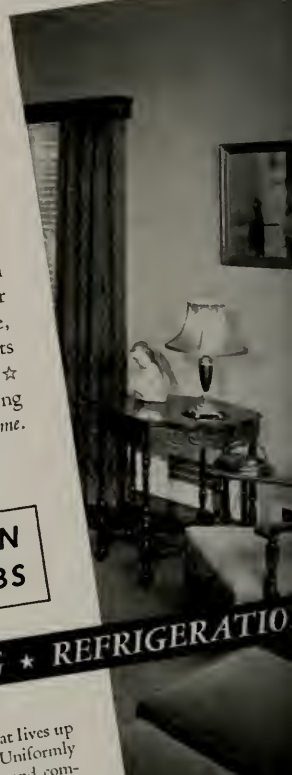
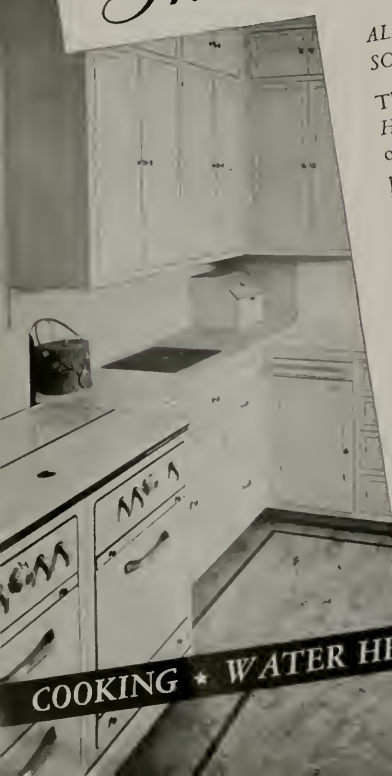

LET **GAS** THE MODERN FUEL DO THE **4** BIG JOBS

COOKING ★ WATER HEATING ★ HOUSE HEATING ★ REFRIGERATION

You'll win lasting gratitude of your feminine clientele by recommending quick, clean, economical gas cooking.

A living room that lives up to its name. Uniformly warm in winter and comfortably cool in summer.

TIME FOR ACTION AGAINST FOREIGN AGGRESSION

EVERY true American wishes to the depth of his heart to avoid war. When Czecho-Slovakia was dismembered and Poland pulverized beneath Hitler's ruthless might, most Americans sympathized with the victims but clung to the fundamental premise that the European war was none of our business and that the Atlantic ocean was sufficient immunity for the Western Hemisphere from invasion.

Then the Nazi tide of steel swept to the north and westward, putting individual freedom to the sword in Denmark, Norway, the Netherlands, Belgium and France.

The advance is still westward—toward the United States.

Thus from voluntary isolation and world turmoil, the position of this country today has changed to that point where we no longer feel ourselves immune from attack—we've reached the stage where the extent of our preparedness may mean the ultimate future of our civilization.

Besides the westward thrusts of the Nazi we face a second danger-aggression by the Japanese.

For more than one hundred years the British and United States Navies have been the first line of defense against European aggression in the Western Hemisphere, and it has been on the might of these forces that the Monroe Doctrine has rested securely. Now Great Britain's back is to the wall and no one knows how long the Royal Navy will continue to be a bulwark against invasion of this hemisphere.

The effectiveness of captured French Naval units in German hands is in question, but their submission undoubtedly placed the seapower of the Nazi-Fascist combination nearer equality with that of Great Britain. The following table shows the naval tonnage of the great powers, as of May 1. Only ships in commission are counted:

United States	1,257,360
Britain	1,461,294
Japan	968,296
France	544,468
Italy	515,900
Germany	281,074

The United States Navy is a superb fighting force, but it is based most of the time in the Pacific. This arrangement was wise as long as Great Britain remained invincible in the Atlantic.

But can we continue to depend on the British Navy as the watchdog of freedom in the Atlantic? The answer emphatically is that we cannot. With the fleet in the Pacific, one well-placed bomb at the Panama Canal could block its passage to the Atlantic for weeks and leave our coasts virtually undefended. Should the fleet be based in the Atlantic, domination of the Pacific would be achieved, almost by default, by the Japanese.

We must meet our own defense needs, which means that the entire Western Hemisphere must cease to invite attack by unpreparedness. Of all of the lessons of this war, one of the most emphatic is that no nation can depend on any other. This does not call for hysteria or panic, but for a cold realization of the present and possible dangers and the united resolve to meet the situation with all of our might and resources.

And that brings us to the point of just how are we going to meet this alarming situation. Even though we had the equipment, which we have not, we still lack trained man power. American industry may be able to take care of mass manufacture of the implements of modern warfare but these manufacturers cannot man tanks, airplanes, anti-aircraft batteries, ships and fortifications.

The situation calls for a vast body of trained men. Raw recruits, however brave, cannot fill the requirements. The only sound and adequate program, to our way of thinking, is selective compulsory military training which appears to be what our Government has in mind. The plan would take care of the great numbers of unemployed; it would give many now on dole an opportunity to earn a respectable living, would create in them a fresh patriotism that inability to get anywhere has somewhat dampened in the last few years. The pity of it is that some such program could not have been adopted years ago—if it had, the present outlook would have been far less alarming.

F. W. J.

ARCHITECT AND ENGINEER

VOLUME 142

AUGUST, 1940

NUMBER 2

SPACE FOR LIVING	6-7
Harry Sanders, Jr.	
A CHALLENGE TO MODERN ARCHITECTURE	19
R. W. Sexton	
HOW PORTLAND HOUSING SHOWS HAVE AIDED ARCHITECTS	25
Roi L. Morin, A.I.A.	
A ROOF OVER THEIR HEADS	29
Harry Sanders, Jr.	
FLUORESCENCE AND LIGHTING NEEDS	33
Nathan H. Graves	
MONOLITHIC REINFORCED CONCRETE FOR ALL CLIMATES	35
Oliver G. Bowen	
PAUL HAYNES PENCIL SKETCHES	37
U. S. DISCOURAGES LEGAL REDRESS FROM ERRING CONTRACTORS	46
W. E. Reynolds	

PLATES AND ILLUSTRATIONS

SAN DIEGO POST OFFICE BUILDING	18
William Templeton Johnson, Architect	
EXAMPLES OF MODERN AND SEMI-MODERN ARCHITECTURE	19-22
PORTLAND, OREGON, HOUSING SHOWS	25-27
WORK OF FARM SECURITY ADMINISTRATION	29-32
PENCIL SKETCHES BY PAUL E. HAYNES	37-43
HOUSE FOR CHARLES H. ACKERSON	44
Wm. Henry Rowe, Architect	

*NEXT MONTH—SCHOOLS AND OTHER BUILDINGS BY
WILLIAM H. HARRISON, ARCHITECT, LOS ANGELES*

(Index to Advertisements—Page 72)

HONORARY EDITORS

Arthur Brown, Jr., Timothy L. Pflueger, Lewis P. Hobart, John J. Donovan, Will G. Corlett, Frederick H. Meyer, Thos. J. Kent, Gordon B. Kaufmann, Ben. H. O'Connor, Michael Goodman, Harry Michelsen.

REGULAR CONTRIBUTING EDITORS

Harris C. Allen, Harry Sanders, Paul H. Hunter, Glenn Stanton, Chas. H. Alden.

EDITOR, FRED'K. W. JONES; ASSISTANT EDITOR, E. N. KIERULFF; CONSULTING AND CONTRIBUTING EDITOR, MARK DANIELS; ADVERTISING MANAGER, R. W. WALKER.

ARCHITECT AND ENGINEER is published on the 15th of the month by The Architect and Engineer, Inc., 68 Post Street, San Francisco. President, K. P. Kierulff; Vice President, Fred'k. W. Jones; Secretary and Business Manager, L. B. Penhorwood.

Entered as second class matter, November 2, 1905, at the Post Office in San Francisco, California, under the Act of March 3, 1897. Subscriptions, United States and Pan America, \$3.00 a year; foreign countries \$5.00 a year; single copy \$.50.

Los Angeles office: Western Pacific Building, Wentworth Green, Manager.

ARCHITECTS REPORTS are published daily from this office and are sponsored by the Northern Section, State Association of California Architects; Vernon S. Yallop, Mgr.

There's a CRANE Heating System for EVERY House You Plan

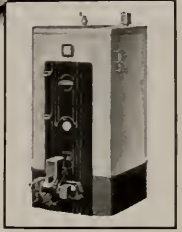

The Conservoil Boiler Burner Unit is a low-cost oil burning heating unit for the small home.

LOW cost cottage or tycoon's mansion—modest bungalow or two-storied residence—no matter what type of house you design there is a Crane heating system exactly suited to that plan.

The Crane line of heating equipment includes boilers designed for coal—for oil—for gas—boiler burner units in various sizes—various capacities of furnaces for any fuel as well as stokers, oil burners, radiators, convectors, winter air conditioners, controls, water specialties, water heaters, valves and fittings.

Because of one source of supply, supervision is simplified when you mention "Heating by Crane" in your specifications.

Because every item carries the name Crane, your clients are assured of a completely unified system—all parts working together for greatest efficiency.



The Crane Oil Burning Furnace—one of the many sizes and types of Crane furnaces for oil or gas consumption.



The Crane No. 10 Boiler can be installed for hand firing of coal and later converted for oil burning or stoker firing.

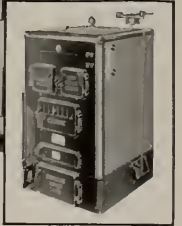

Crane Sectional Boilers are built in sizes suitable for the largest home.



The Basmor Boiler provides the advantage of completely automatic heat with both natural and manufactured gas.



CRANE

CRANE CO., GENERAL OFFICES:
836 S. MICHIGAN AVE., CHICAGO
VALVES • FITTINGS • PIPE
PLUMBING • HEATING • PUMPS

NATION-WIDE SERVICE THROUGH BRANCHES, WHOLESALERS, PLUMBING AND HEATING CONTRACTORS

WITH presentations of documentary and experimental films, a show of color photography contemporary American photography, and a special section devoted to works by living California camera artists, the Pageant of Photography at the Palace of Fine Arts on Treasure Island is one of the most comprehensive exhibitions of photography ever assembled in this country.

For the first time, photography has been given a prominent place in a Fine Arts Show of a great Exposition. San Francisco's internationally known camera artist, Ansel Adams, in conjunction with Tom J. Maloney of "U. S. Camera," has gathered this unique exhibit.

Of particular interest these days is a show of strikingly beautiful pre-war photographs of Paris. These photographs were made by Eugen Atget, who died practically unknown in 1927 at the age of 72. For almost thirty years Atget had been trudging around Paris with an 18 x 24 cm. camera. He made about 1600 plates.

The American photographer, Berenice Abbott, who had become tremendously interested in his work on a previous visit to Paris, spent about a year locating his possessions, which at his death had been unceremoniously carted away. It took another six months to sort out the albums, glass negatives and prints. Bringing them back to the United States on Miss Abbott's return in 1929 required twenty packing cases.

From the Meserve Collection comes a fine group of photographs of Lincoln and the Civil War, by Brady and others of the period.

Another room is devoted to color photography in its many forms. An important display in this room is a marvelous stereoscopic viewing apparatus by Dr. Clarence Kennedy, designed for large Kodachromes and black and white stereoscopic photography.

* * *

FAMOUS PAINTING FROM ENGLAND

"Infant Samuel," one of the most celebrated paintings by the great eighteenth century artists of the English school, Sir Joshua Reynolds, has arrived safely at the 1940 Golden Gate International Exposition, to be displayed in the brilliant Old Masters section at the Palace of Fine Arts.

The painting comes from the famous National Gallery in London, having crossed the hazardous seas. During its voyage it was covered by unusually high insurance, due to the international situation.

"With war torn Europe now virtually closed to American visitors," commented Dr. Heil, Director of the Old Masters section, "the large and impressive array of masterpieces of European art gathered at the Fine Arts Palace gains additional significance. But even here in America one would have to travel thousands of miles up and down the states, visiting museums everywhere and gaining entrance to some of the

most renowned—and inaccessible!—private collections, in order to see all the great art treasures now assembled in the Fine Arts Building."

* * *

RIVERA PRAISES MEXICAN SHOW

"This is the finest exhibit of contemporary Mexican art I have ever seen," Diego Rivera, famous Mexican muralist, commented recently as he interrupted his work on the mural

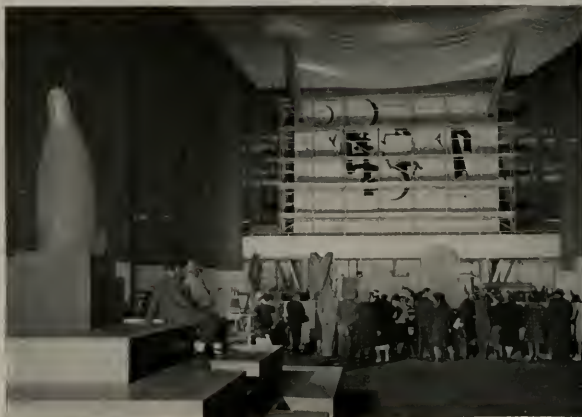

ART IN ACTION PLAZA, PALACE OF FINE ARTS, TREASURE ISLAND. LEFT FOREGROUND, PENGUIN BY BENIAMINO BUFANO, IN BACKGROUND, SCAFFOLD WITH HERMAN VOLZ MOSAIC

painting at the Fine Arts Palace of the Golden Gate International Exposition to study carefully the display of modern Mexican art exhibited in the Fine Arts Building. "It is a strikingly faithful cross section of the various styles and techniques now predominant in my country."

The show, gathered by Thomas Carr Howe, Jr., Director of the California Palace of the Legion of Honor in San Francisco, constitutes the most comprehensive presentation of contemporary Mexican art ever held in the United States. The exhibit comprises 70 oil paintings, 45 water colors and drawings, and 65 prints, representing the work of 56 artists.

The most prominent Mexican artists, such as Orozco, Rivera, Dr. Atl, and Siqueiros, are well represented. However, the show places great emphasis on the works of the younger painters.

* * *

SYMPOSIA IN THE FINE ARTS

A series of symposia in the Fine Arts will be conducted at the University of Pennsylvania on September 16, 17 and 18, during a Bicentennial Conference arranged in commemoration of the 200th anniversary of the University's origin.

Opening the series at 3:40 o'clock on Monday afternoon, September 16, will be a symposium at which the general subject will be "New Light from Old Lamps; Archaeology and the Humanities."

Dr. Leicester B. Holland, Chief of the Division of Fine Arts in the Library of Congress, and Professor of Fine Arts at the University of Pennsylvania, will preside, and the opening paper on "Revelation of the Ancient World" will be delivered by Dr. Carl W. Blegen, Professor of Classical Archaeology and Fellow of the Graduate School of Arts and Sciences, University of Cincinnati.

At a symposium to be held September 17, the general subject will be "The Influence of Social Organization on the Arts."

The final symposium of the series will be devoted to a discussion of "The Development of Metal as a Structural Element in Architecture" and will be held Wednesday afternoon, September 18. Dr. Charles D. Maginnis, past President of the American Institute of Architects, will preside.

* * *

WINNER OF ANNE BREMER PRIZE

William Hesthel of San Francisco won the Anne Bremer Memorial Purchase Prize with his clever, semi-abstract "Amusement Park." The San Francisco Art Association Purchase Prize was given to Karl Kasten, also of San Francisco, for his lively, richly colored "Hillside Homes." Doris Miller Johnson of Berkeley was awarded the Artist's Fund Prize for her watercolor, "I Street Bridge," which is a splendid example of the "Berkeley" technique.

Of the 123 watercolors, pastels and temperas, a large proportion, 56, are from California, outside of San Francisco, while 17 come from other states.

The jury of selection was composed of John Haley, chairman; Ray Boynton, Mallette Dean, Doris Miller Johnson and Florence Tufts. On the jury of awards were John Haley, chairman; Ray Boynton and Florence J. Tufts.

MODERN MATERIALS FOR MORE DISTINCTIVE, MODERN INTERIORS



A RCHITECTS! The impressive board room above is a splendid example of the way in which Nairn Linoleum for floors and walls can help you create more distinctive and individual modern interiors.

Here, Nairn Veltone Linoleum, with one-piece cove base and border, combines with Nairn Wall Linoleum on three walls and a bulletin board of Nairn Cork Carpet on the fourth wall. The result is a room both beautiful and practical. Even the table is covered with Nairn Linoleum—another modern use for this modern material.

In addition to its decorative features, Nairn Linoleum is quietizing and footeasy. Economical, too. Moderate in first cost, inexpensive to maintain. And long life is assured. Under the most severe traffic conditions, Nairn Linoleum has been proven to outlast other types of floors.

When installed by Authorized Contractors, Nairn Linoleum for floors and walls is fully guaranteed to the value of workmanship and materials.

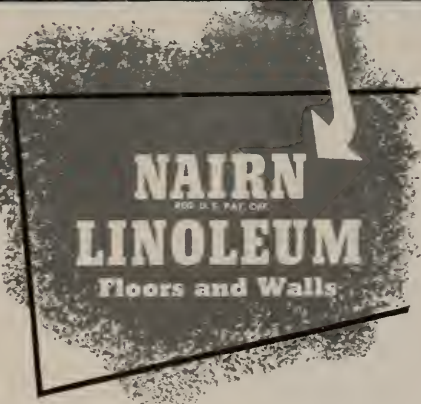

CONGOLEUM-NAIRN INC.
KEARNY, NEW JERSEY

SPACE FOR LIVING

By HARRY SANDERS, Jr.

AN innovation in content and subject matter as well as in display and presentation technique, "Space for Living," the Telesis exhibit currently showing in the South gallery of the San Francisco Museum of Art, is the first exhibition of its kind in the West. More than a recommendation to the populations of the Bay Region, it is a challenge . . . and a challenge which we believe will be far-reaching in the forthcoming development of our homes, our cities—in short, the environment in which we shall live.

For Telesis, in the words of Noah Webster, means: Progress intelligently planned and directed; the attainment of desired ends by the application of intelligent human effort to the means.

With this express purpose in mind, a group of forward-thinking young men and women several months ago began to coordinate their thoughts and desires in respect to their professions—architecture, city and regional planning, landscape architecture and industrial design. They constitute Telesis which invites you to inspect results of research and study concerning our present and our future, regarding "places to work, places for living, places for play and certain services which integrate these and make them operate."

You will find at the Museum of Art a "story" whose continuity swings along. It is a story which deals with every phase of "space for living." It is an analysis of conditions as they exist in non-planned areas compared to those of intelligently-planned regions. Besides the aforementioned "places for work, living and play," it concerns facilities for education, transportation, communication, hospitalization and other allied requirements of man. You will find, too, an exhibition of the work of many of this country's outstanding modern architects and a display of new uses for building materials.

The exhibit opens with a challenge: Is This the Best We Can Do? This challenge portrays out-moded and inadequate facilities for living.

Telesis answers its own challenge with photographs, models, charts and drawings of satisfactory conditions in the various phases of living which it discusses.

MAN WORKS

"Man's working places," to quote Telesis, "are those of Commerce (the office and store), Industry (the factory and shop) and Agriculture. The congestion of



his commercial and industrial areas have had an unwholesome effect on the functioning of his city and on his own personal well-being, and yet we continue to crowd the land. The buildings in which he works are often designed for effect rather than use.

"Since the Agricultural environment, under normal conditions, has the most desirable effect on people, why not practice some degree of decentralization and bring rural benefits to city dwellers? Bring the agricultural greenbelt to the rescue of our cities!"

MAN LIVES

"His living places," continues Telesis, "are the single house, the group house and the apartment. Whether of the low income level or the high income level, he needs his quarters designed adequately for Use, for Circulation and for Orientation. His home must be designed to make efficient use of the land and to bear a proper relationship to his neighbor's home and his community. The Neighborhood Unit and Super-Block treatment will lend economic stability and safer, richer living to his home."

MAN PLAYS

"The congestion and routine of the office, factory and home has brought about increased need for free, open play," the Telesis analysis states. "Recreational needs vary with age groups from children to grown-ups. Certain facilities should be made available at your doorstep, others may be some distance away. There is a definite relationship between the availability of recreational facilities and the well-being of the average citizen."

MAN IS SERVED

"Man's needs are served by communication systems, transportation and traffic facilities, heat, light and power, schools, police and fire protection and by the

CHALLENGE BY TELESIS

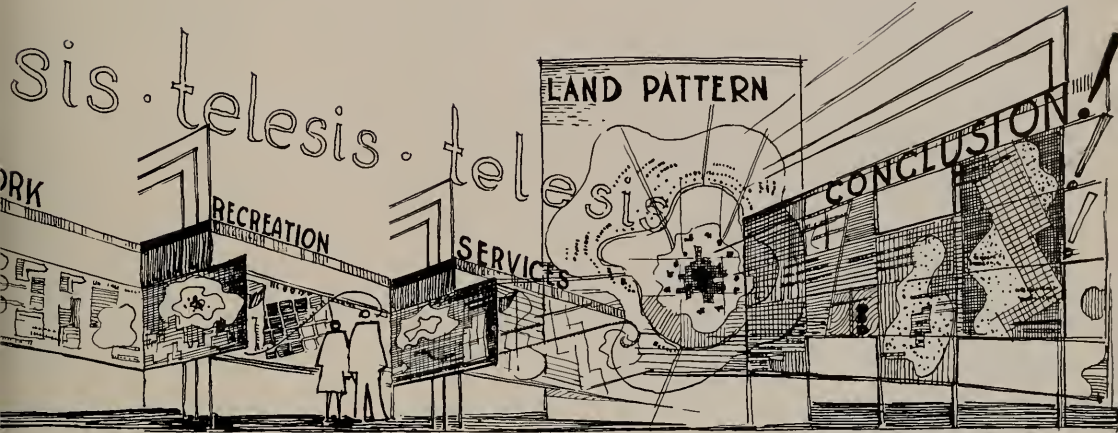

Sketch by John Ekin Dinwiddie

coordination of these by public administrative bodies. The inefficiency and costliness of operating our cities is the result of inadequate planning and coordination of these services."

CONCLUSION

"A lack of planning for any of these parts of man's environment is wasteful enough," Telesis states at the conclusion of the exhibit's story," but a complete lack of integrating all four of them into a Master Plan is destructive of the resources of People and of the Land."

The exhibit points out that these components of our environment should be integrated in the community, the urban region and the national region "through rational planning and through the use of modern building technology."

ARCHITECT'S IMPRESSIONS OF TELESIS SHOW

By MICHAEL GOODMAN

In styling myself as a critic, I cannot better the general expressions of natal felicitations offered by various national big names in honor of the formation of the Telesis group and their exhibit.

The reading of the booklet sold at the show in the War Memorial Museum is in itself a tribute to this energetic group imbued with clear-eyed and youthful vigor and full of untrammelled imagination in learning eternal truths in a changing world.

To dispense with a pleasant formality, I would like to offer my friendly admiration for such men of more mature standing as Walter Landor, Vernon DeMars and Francis McCarthy undoubtedly, for their organized ability and cohesive influence in the process of putting together and embodying of all ideas assimilated in the past few years by the members of the Telesis group.

It would have been disappointing to me had most of the members of this anonymously represented group

not shown a culmination of a growth. While teaching some of them in the past, I hoped that the question mark of their future would become an accent.

Brilliant students as they were, some of them were dissatisfied with academic impositions, which condition fostered eager curiosity and banding for group research. Some of them would have done better at other related professions. They read prodigiously. They would have written their own books in the future had they chosen to pursue the evangelism of their professions.

There is no necessity to discuss expertly the various exhibits displayed, since none of us may be encyclopedic wizards of the modern complex; neither will this space allow such a project. The secret of being tiresome, according to Voltaire, is trying to tell everything. I intend here to report the attitudes of the crowd at the opening. Let it be said that these young people have achieved a union which the older groups of professionals could not effect; besides, thus banded they are selling the idea to amused and indulgent bystanders who eagerly viewed the displays similar to some at the Fair, but much more singled out. The Telesis show, in addition, points an accusing finger at the elders, who, when the social order is in turmoil, find their position becoming exceedingly difficult. It may be true that a green salesman can sell more goods than a blue salesman. Obviously the show was designed as a nicer sort of propaganda.

A diehard professional grouched that "the technique of displays was becoming more important than the subject" and that "the good old days were over when architecture was still the mother of arts and frozen music to boot;" now, according to the cooperative decision of the Telesis group, civic and regional plan-

(Turn to Page 58-D)

Time — The Wrecker

Time has always been man's adversary. Especially does time seem to delight in sweeping along at such a pace that man-made buildings are outmoded in a few brief years, even if they are still sound.

Today living is geared to a faster pace than ever before and time takes its toll in buildings which outlive their modernity and efficiency in an even briefer number of years than before.

No service is more important in modern buildings than the electric service, and no service is so swiftly outgrown. We are told that the electrical age has just commenced and that succeeding years will see tremendously increased use of electricity in homes and every type of commercial building.

The electrical service that goes into your building today is more important to the useful life of that building than ever before. Limited electrical service will throttle the building's useful life and make trouble and expense for the owner.

Include generous electric service in your plans. Then if the owner does not follow your recommendations, you cannot be criticised for failure to provide proper electrical service plans.

NORTHERN CALIFORNIA ELECTRICAL BUREAU

447 SUTTER STREET • SAN FRANCISCO, CALIFORNIA

AQULUX 85

NEW Oil Burning Water Heating Unit

This powerful and compact vertical unit, beautiful in appearance, is designed to supply hot water at minimum cost in the modern home. It can also be used to supply heat and hot water automatically for small homes without the necessity for basement installation. Complete data on this new "package unit" now ready.

Burns No. 3 C. S. G.
fuel or Diesel oil

S. T. JOHNSON CO.

940 ARLINGTON, OAKLAND, CALIF.
401 N. BROAD ST., PHILADELPHIA, PA.

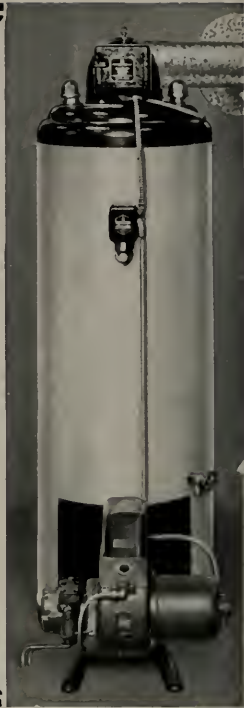

YOU CAN HOLD THE NATURAL BEAUTY OF REDWOOD FOR MANY YEARS!

CABOTS' # 230 Colorless Creosote

WHICH IS A CLEAR REFINED
WOOD PRESERVING CREOSOTE
OIL, CAREFULLY BLENDED
WITH THE NECESSARY
FIXATIVE, PROTECTS AND
PRESERVES WOOD WITHOUT
ALTERING ITS NATURAL COLOR.



GUNN, CARLE & CO.
SAN FRANCISCO
20 Potrero Avenue
UNderhill 5480

Give Your Clients More "Breathing Space"

Broaden and Brighten Homes With Glass

● You know how clients suffer from claustrophobia—feel cooped up—hemmed in by walls, no matter how hard you try to please.

You can avoid this complaint by using glass—generously. With picture or corner windows, or with sparkling mirrors, dusky corners disappear and walls move back! The whole house broadens and brightens—assumes a semblance of bigness and airiness.

In countless other ways, you can make glass *make* homes—homes that people *like to live in*. For instance, few features are so appealing to women as low-cost, full-length door mirrors. They widen entrance halls and bring a cheery note of welcome to guests. In bedrooms and bathrooms the head-to-foot reflections are appreciated by every member of the family. And partitions or doors of shimmering figured glass add beauty, brightness and a pleasing new dimension to rooms.

Talk to your L·O·F glass dealer.



See how spacious areas of glass open up this room—make it bright, airy and cheerful.

You'll find he has a fund of information about glass that will inspire and facilitate your use of this fascinating material. And it's well to keep in mind that for best effects with glass nothing but the *best* will do. You can specify none *better* than L·O·F glass, yet it costs no more. Libbey·Owens·Ford Glass Company, Toledo, Ohio.



Women appreciate the check-up of every detail of appearance that full-length door mirrors provide.

←
Glass makes a gem of this breakfast bar between the dining room and the kitchen. When not in use the doors swing out to form a mirrored panel between the upper and lower cupboards. Upper cupboard doors are glazed with Louvrex decorative glass.



LIBBEY·OWENS·FORD
QUALITY GLASS

HAWS SANITARY DRINKING FOUNTAIN



For Public Buildings



For Industrial
Plants and Schools



For Offices
and Theaters



For Schools



For Gas Stations

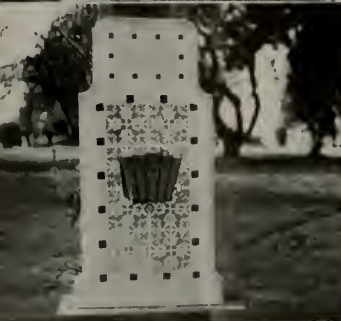

For Playgrounds

HAWS DRINKING FOUNTAINS

*Comply with requirements of the
American Public Health Association*



HAWS DRINKING FAUCET COMP

1808 HARMON STREET • BERKELEY • CALIFORNIA

Agents in the following cities:

New York • Los Angeles • San Francisco • Seattle • Salt Lake City •

"SOMETHING FOR NOTHING"

Editor:

After wading through a copy of "The Civil Engineer," "Building Standards Monthly," "The Explosives Engineer" and "California Safety News," I was pretty well softened up until I came to "something for nothing" by your esteemed associate editor, Mark Daniels, A.I.A., in the December number of **Architect and Engineer**.

For my sake, and that of perhaps several others, would you mind giving us the address of Mr. Daniels' favorite bar? Because I want to ask the Little Man the following question: "Is there more of is than there is of isn't?" In other words, down through the ages, have there been more apples, trees, people and "is" objects than there will be in the future?

And when T.L.M. has really got me foggy, will someone remember to ask him this—"Are there more 'possibles' than there are 'impossibles'?" (Maybe T.L.M. won't haunt Mr. Daniels after that.

Seriously, though, I do have a word to say to the author of "Architect A Good Empire," as extracted from the "Federal Architect."

Granting that a building inspector is about the lowest form of tax-eating algea on the pond, he appreciates the smoothness with which most contractors settle down to Code requirements, and the author of the article surely must have had a peeve on with some "jerry" builder.

Due credit should be given to the building inspector and to correctly drawn codes affecting buildings when properly enforced. Unfortunately we are sometimes confronted with groups trying to break down progressive and economical codes, and the backing of the architectural profession will do much to keep up these standards.

A. L. BRINCKMAN,

FOR WESTERN ARCHITECTS

Editor:

I enjoy very much *The Architect and Engineer*, more so, perhaps because it is a Western magazine for Western architects. The recent issues have all been very interesting and I look forward with anticipation to each issue. The various articles are good and educational. Keep up the good work.

Sincerely yours,

MARTIN RAY YOUNG, JR.,

Mesa, Arizona

Architect.

BOKAY!

Editor:

I have just finished reading the May issue of *Architect and Engineer* and I can't tell you how much pleasure it has given me to think that I know this bird Daniels that you have devoted so much space to. Seriously, this edition to my mind is a fine tribute to Mr. Daniels and the work that he has done here for such a long time.

San Francisco

EUGENE F. KERN.

GRADUAL CONTROL THAT IS G-R-A-D-U-A-L

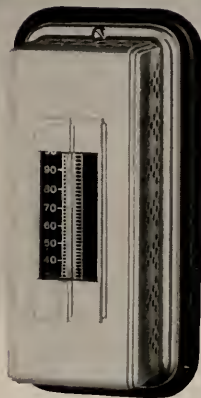

Johnson Room Thermostat with adjustable sensitivity. Eliminates "hunting" and departure from control point.



Johnson "Absolute-positioning" pilot operated Damper Motors with two diaphragms, insuring precise positioning of dampers. No springs.



"Streamline" Modulating Valves, another exclusive Johnson development, with seamless metal diaphragms and unique throttling characteristics.



Johnson "Piston" Damper Motors, affording long-travel at full power, a feature not found in other damper motors. Available with or without pilot mechanism.

JOHNSON PRECISE SYNCHRONIZING

Every device pictured here brings you a new conception of precision, greater flexibility, and increased understanding of what you may expect from Johnson's modern automatic control equipment . . . The Johnson line of pilot operated apparatus, for truly modulated operation by Johnson gradual acting instruments, with adjustable sensitivity, is the very latest "word" in precise synchronizing of control devices. Ask to see a Johnson engineer from a nearby branch office or send for detailed bulletins. Johnson Service Company: Milwaukee, Wis., and direct branches in all principal cities.



"Absolute-positioning" Modulating Valves, with Johnson pilot mechanism and "Streamline" gradual control characteristics. Maximum power for re-positioning at slightest command of controlling instrument.



Insertion and Immersion Thermostats with Johnson's distinctive sensitivity adjustment, calibrated on the job to balance "time-lag" against the capacity of the controlled apparatus.

JOHNSON
Automatic TEMPERATURE AND AIR CONDITIONING *Control*



Clarence W. W. Mayhew, Architect

SUNSET HOUSE THAT 300 WOMEN HELPED TO DESIGN

Equipped with
PITCHER INTERIOR DISAPPEARING DOORS



E. C. Pitcher & Co.

557 Market Street, San Francisco

Phone YUkon 1543

*See our exhibit in the Homes and Gardens Pavilion,
Golden Gate International Exposition*

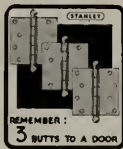
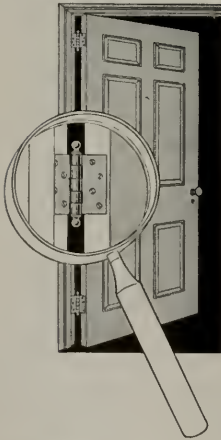

SATISFACTION

calls for the third butt — every time. It holds the door in line, preserves its appearance, keeps the lock working smoothly. Specify *Three Butts To A Door!* The Stanley Works, New Britain, Conn.



*Stanley 241
Standard
of the World
for over
Fifty Years*

STANLEY

TRADE MARK

HARDWARE FOR CAREFREE DOORS



GOLDEN GATE



24 HOUR PORTLAND CEMENT

Pacific Portland Cement Company
Coastwide Service

MAKES FAST CONSTRUCTION SAFE

No Worry for the Architect

—All acid proof drain pipe and fittings shall be ferro-silicon—CORROSIRON—

(Write for above specification)



FEDERAL BUILDING • CIVIC CENTER • SAN FRANCISCO

Artlur Brown, Jr., Architect

CORROSIRON DRAIN LINES and FITTINGS and LABORATORY EQUIPMENT was specified because of its superior resistance to corrosion and wear.

Pacific Foundry Company, Ltd.

NEW YORK • 3100 NINETEENTH ST., SAN FRANCISCO • LOS ANGELES



SPECIFY *Silence*

SPECIFY *Safety*

- There is no reason, now, for installing noisy flush valves or plumbing that will telegraph the roar of rushing water throughout the building. Modern plumbing *can* be quiet—so noiseless, indeed, that the sound of a toilet bowl flushing cannot be heard through a closed door.
- Architects everywhere are specifying Sloan *Quiet-Flush* Valves. Literally thousands of installations have proved that Sloan *Quiet-Flush* Valves reduce the sound of running water to scarcely a murmur. —And they *stay* quiet, too, because no water flows through screens, perforations or obstructions which could clog. The silencing elements in Sloan *Quiet-Flush* Valves are constantly washed clean by the action of the water itself.
- When you specify Sloan *Quiet-Flush* you get more than silence—you get nationally recognized Sloan superiority in the construction of the valve itself. During the past 34 years Sloan valves have proved themselves so economical of water, so resistant to wear, so low in maintenance cost that today more Sloan Flush Valves are specified and installed than all other makes *combined*. The many thousands of *Quiet-Flush* installations throughout the country have again demonstrated that any Sloan product has *Sloan* quality—the unequalled standard by which all other flush valves are judged.

- All water-borne diseases and many intestinal disorders may be transmitted through unprotected plumbing. We all know, too well, the costly (and needless) epidemics of dysentery in hotels, hospitals, schools and other buildings because of water pollution through back-syphonage.
- “Needless” epidemics—because Sloan offers complete, positive protection against back-syphonage for a wide variety of fixtures. Sloan *Quiet-Flush* Valves can be furnished with the V-100-A Vacuum Breaker as an integral part thereof. Specify Sloan *Quiet-Flush* Valves with integral vacuum breaker and give your client positive protection against back-syphonage.
- The Sloan “V-100-B” Vacuum Breaker is an inexpensive device designed to prevent back-syphonage in fixtures having small supplies and low rate of flow. There are scores of places in restaurants, bars, beauty parlors, hotels, hospitals, clubs, laboratories, etc., that need the new Sloan V-100-B Vacuum Breaker for protection against water pollution.
- And in Sloan Vacuum Breakers you naturally find *Sloan* quality. They are not only fully approved by health authorities everywhere, but bear the seal of acceptance of the National Plumbing Laboratory maintained by the National Association of Master Plumbers at the University of Iowa, under the direction of the Dean of the College of Engineering. Protect all danger spots.



SLOAN VALVE COMPANY
4300 WEST LAKE STREET • CHICAGO

SLOAN VALVE COMPANY
4300 WEST LAKE STREET • CHICAGO

SLOAN *Quiet Flush*

SLOAN VACUUM
BREAKERS



SAN DIEGO POST OFFICE BUILDING, SAN DIEGO, CALIFORNIA
WILLIAM TEMPLETON JOHNSON, ARCHITECT

A good example of modern architecture following traditional lines . . . conforming generally to the classic. . . Note absence of the conventional cornice.

A CHALLENGE TO MODERN ARCHITECTURE

By R. W. SEXTON

It is now about fifteen years since so-called "modern" architecture was first introduced into this country, hardly time for a new style in architectural design to be perfected, but time enough it would seem, for us to determine whether modernism has done for American architectural art all that its sponsors claimed it would do.

The modernists who were instrumental in furthering the movement here claimed that architecture as practised in this country during the first quarter of the century was entirely lacking in originality and did not reflect the character of the times. We agreed that this was true, for at that time architectural design was so strongly influenced by the old styles that our houses as well as every other type of building, reflected in their design the character of some past period of European architecture. In those days, style came first, design after, and the result was, as it was bound to be, that our architects were allowed little or no opportunity for original expression.

Only in the design of our very tall buildings, our skyscrapers, was there any evidence of creative ability on the part of American architects. And, strange as it may seem, the setback, which proved to be the inspiration as well as the backbone of American skyscraper design, was brought about by law as a practical means of affording more light and air to the lower floors of those towering structures.

The modernists also emphasized that architects in European countries were already developing a new style which was thoroughly in keeping with the times and that progress in the art in this country demanded that we, too, fall in step with the modern movement.

Seeking some common denominator which might not only serve as a keynote to a new style but would also tend to unify their varied and perhaps divergent ideas, the modernists

hit on the word "functional." The word suggests a principle of architectural composition which is as old as architecture itself and by including it in their doctrine, the modern movement seemed to lose none of its appeal. Encouraging a greater expression of creative genius, which our architects certainly possessed but had had so little opportunity to exercise, and seeking to effect an architecture, based on fundamental principles of composition, that would be peculiar to this country as well as to the twentieth century, the modern movement

THE FIRST "MODERN" HOUSE



This dwelling is at Long Neck, New York, and was designed by Julius Gregory.

NOT A "FREAK" HOUSE



There is nothing radical about this design yet it represents no historic period.



HOWARD JOHNSON'S ICE CREAM SHOP AND RESTAURANT, NEW ROCHELLE, N. Y.
Designed by Joseph Morgan Architectural Department
Note modern and original details to cupola.



PALO ALTO NATIONAL BANK, PALO ALTO, CALIFORNIA
Birge M. Clark and David B. Clark, Architects
Classic in feeling, yet modern in detail.

Photo by Crandall



FIVE TOWERS FROM THE NORTH, CITÉ DE MUETTE, DRANCY, 1934

Outstanding example of modern design for workers' one, two and three-room flats. Each tower is 15 stories and contains 280 flats. There are also 310 flats in long horizontal blocks.

seemed even to point the way to a new and golden era in American architectural art.

Adhering to the best traditions of the country, as exemplified in the work of our forefathers, masters in craftsmanship as well as design, with a wide range of new and intriguing structural and decorative materials to inspire them to original expression, American architects thus approached their problems with a new enthusiasm. The eagerness with which those architects who were not associated with the original group of modernists accepted this new order of things and the ingenuity and freshness which characterized their designs spoke well for the future of architecture in this country. We saw in their compositions how new building products tended to inspire originality in design and how traditional ideas could be adapted to conform to the modern tempo without losing their distinctive American character.

RADICALS AND CONSERVATIVES

With the future course so clearly marked and the efforts of the profession seemingly unified, it soon became evident that there was a cleavage in the ranks. Some leaned to the right,



Courtesy The Modern Flat by F. R. S. York and Fred'k Gibberd
CLOSE UP OF A 15-STORY TOWER



PLACING A VIBRATED CONCRETE WALL UNIT

The steel framework is just strong enough to carry the floors, when in position, but until cased in concrete it is not capable of supporting the load ultimately developed.

others to the left and as a result there was a sharp line drawn between the radicals and conservatives. While the conservatives found it desirable and logical to make use of certain traditional forms, the radicals would have none of the past. They insisted that columns, pilasters, cornices and even pitched roofs could have no place in a modern design.

But this split in the ranks was due not only to the insistence of the radicals that we close our eyes to anything that had been done in the past, whether in this country or abroad, but also to their emphasis on or to their interpretation of the word "functional." Those of us who lean more to the right have been brought up to understand that function as applied to architecture means design based on purpose or use. It means first that a building should be planned to best serve its purpose and that the purpose of a building should be re-

flected in its design. It also means that each element of the design should serve some practical or structural purpose. We might say that function in architectural composition means honesty in design. Thus it was not alone modernism, but that other "ism" of the modernists' creed—functionalism—which caused a rift even in the ranks of the architects themselves.

Let us consider for a minute how this principle of function generally influences design. In the plan of our houses, in the arrangement of the various rooms, in the size of the rooms and in their relationship to each other, we can readily see how the plan of a building is developed to best serve its purpose. In striving, however, to reflect the purpose of the building in its design, the architect is faced with a problem that is not so easily solved nor so readily recognized. But a fascinating problem it is when properly approached. It is here that architecture assumes a certain allegorical turn. For in many cases the architect must select certain characteristics which symbolize the building's purpose and at the same time lend themselves to expression in structural materials, as well as in architectural forms. Thus, for example, a bank stands for security, strength and honesty, qualities which may be expressed in structural forms. It is, however, in the details of the design that the principle of function is most frequently disregarded. This is especially true when an architect must effect a design that conforms generally to some past period of architecture while the building must be constructed according to present-day standards. For example, we sometimes see a building which is of steel frame construction, and yet the surface treatment suggests the character of half-timber architecture. The building, then, appears to be something that it is not and thus it does not conform to the principle of honesty in design.

HOW STYLE IS ATTAINED

The fault may not be that the modernists disagree with this interpretation of function in design, but it certainly appears so when they establish a standard fundamental principle of composition as a means of imparting a distinctive character to a new style in design. For it

is not in **function**, but in the functional **forms** that style is attained. The principle of function is adhered to in all the past styles. But it is the forms that give these old styles their peculiar character. Form is the means, therefore, of lending beauty and interest to structural or functional design. And form means ornament as well as mass. A design may be strictly functional and yet in its forms it may not be beautiful. On the other hand, beauty of form emphasizes rather than detracts from function. The Greeks and Romans devised the orders to lend beauty to function. By fluting the shaft, introducing a moulded base, and a carved cap, the column, which served a very definite purpose in the structure and was thus a strictly functional element or form, was made beautiful and thus lent character to the composition. A door and window trim is another simple illustration. The trim is a purely practical and structural detail, serving to conceal the joint where the door or window frame meets the wall. The trim is often given a moulded form to add interest and beauty to the design. We see then that it is the form that is given such functional elements as a column and the door and window trim that the design attains its style.

But this over-emphasis on function by the modernists has caused them to relegate beauty to a place of secondary importance. And when beauty is not the main objective in architecture, then architecture is no longer an art. In a strictly functional architecture, usefulness replaces beauty as the main objective. Consider an example. You may have in your office or may have seen in some one else's office a table. It is a purely commercial piece of furniture, well suited to its purpose or use, a thoroughly practical piece of furniture. You do not criticize it for it is there to serve some definite purpose. It is a good sized table, severely plain with no ornament. A good example of functional design. But how would that table look in your living room? You may need a table there of that size. But in your home where you are not engrossed in business matters, you expect a piece of furniture like a table to be beautiful as well as practical. Surely the details

of this table need refining to make it appropriate as a piece of living room furniture. It needs a little art, a little beauty, which bare functionalism lacks. In its design, form must be considered and not merely usefulness. And so with "modern" architecture. Although a building must satisfactorily serve its purpose, we also expect it to be beautiful in design.

DISREGARD FOR FUNCTIONALISM

In many of the designs created by the radical-modernists it is evident that they themselves felt that their compositions seemed to be lacking in interest. And in introducing ornament to overcome this bareness, they have shown a strange disregard for or knowledge of this functionalism which they themselves choose to emphasize. And in many of their designs, too, the purpose of the building is not even suggested by symbolism or otherwise. A building that serves as an art museum might just as well be a storage warehouse and a college building might easily be taken for a thousand window bakery.

While we who lean to the right hoped that modernism was the salvation of American architecture, welcoming the opportunity for a greater expression of originality, we were somewhat skeptical at first as we realized that the demand for a change in architectural design seemed to originate with the architects rather than with the people generally. For the public, those who live and work in our buildings, who invest their savings in the construction of these buildings and who pay architects a fee for creating the designs for these buildings, seemed well satisfied with architecture as it was then and for some years had been practised.

In the past a new style in architecture came about so gradually that one was hardly aware of any radical changes in design taking place. The actual date when one style was superseded by another was so indefinite that it has always been our custom to associate the styles with reigning monarchs and kings, although they themselves had nothing to do with originating the style and may not even have known of its existence. Changes in design were brought about in different ways. By the development

of new materials, of new tools for shaping the materials at hand, and to new and improved methods of construction, but also, and to a very great extent, to changing social and economic conditions. But a real change in style was the result of a demand by the people. They recognized that some idea, already advanced, afforded an opportunity to give better expression to their cultural tastes and living standards. But here was a group of architects demanding a change, a "new" style, without anything to offer as to what that style must be except that it must include no forms which were associated with any styles of the past and yet must reflect twentieth century Americanism.

The whole idea now seemed incongruous. Originality needed some other incentive besides "to be different." For this meant forced originality. Originality at its best is spontaneous. Some natural impulse, something within, urges the creative artist to original expression. So with the development of a new style. A new style might be said to be a new generation in art. Its birth, too, must be natural. To cut off its past heritage is to destroy its nationality. A style not born naturally proves to be a miscarriage.

MODERN STYLE HAS FOREIGN BACKGROUND

A change was due, no doubt. There had been murmurings of it for some time. Here and there original ideas were introduced in designs that generally were reminiscent of some past period of architecture and they were enthusiastically welcomed. Then, when the course was set leading to an architecture that would reflect Americanism of today based on traditional ideas originated by our forefathers, the public, recognizing this as the logical road to progress, was quick to give its approval.

But the radicals were not satisfied to follow this normal and logical course. Turning into an unknown road to the left, they looked for some ideal to lead them on. Functionalism welded their ideas to a certain extent but did not make the road any clearer. Perhaps the modernists of Europe held the cue? And so the modern style became an international style.

And now what of the modernists' original claims? They urged originality. No more "copybook" architecture, they said. They prohibited copying the work of the old masters, but today they are copying Europe's modernists whose creed, too, is "to be different." They demanded an American style. But instead of seeking inspiration in the work of our forefathers and adapting their ideas to meet our present-day needs, they now look for inspiration in the work of living European architects who are themselves only experimenting with new forms and new materials in the hope of attaining a "new" style for themselves.

From the moment that modernism assumed an international status, the movement as practised by the radicals in this country was doomed. For thereby its basic appeal—greater originality and truer Americanism—was defeated. Surveys made by various organizations during the last few years give a true indication of the reaction of the public to "modern" architecture. In every case, the Early American style was preferred over the "modern." That there is today a very marked tendency to return to the normal course that leads to progress from which we were diverted by the radicals is evidenced by the fact that this swing to the right is considered to be of sufficient importance to warrant a name. It is already referred to as "classic-modern," a combining form that is at once awkward and anachronistic. And yet it is not its name but rather the ideals for which it stands that should excite our enthusiasm.

Let all the various groups and forces unite, then, with progress in Architectural Art in this country as our goal; not merely the creation of a "new" style, although history, which has the final word in such matters, may decide that the work of our architects of this or of the next generation deserves to be so recognized by posterity. For progress means developing our architecture so that it at once reflects the character of our times and recalls our past heritage. Only in this way can we attain an architecture that is original, individual and honest in design: an architecture that is truly modern and distinctly American of today.

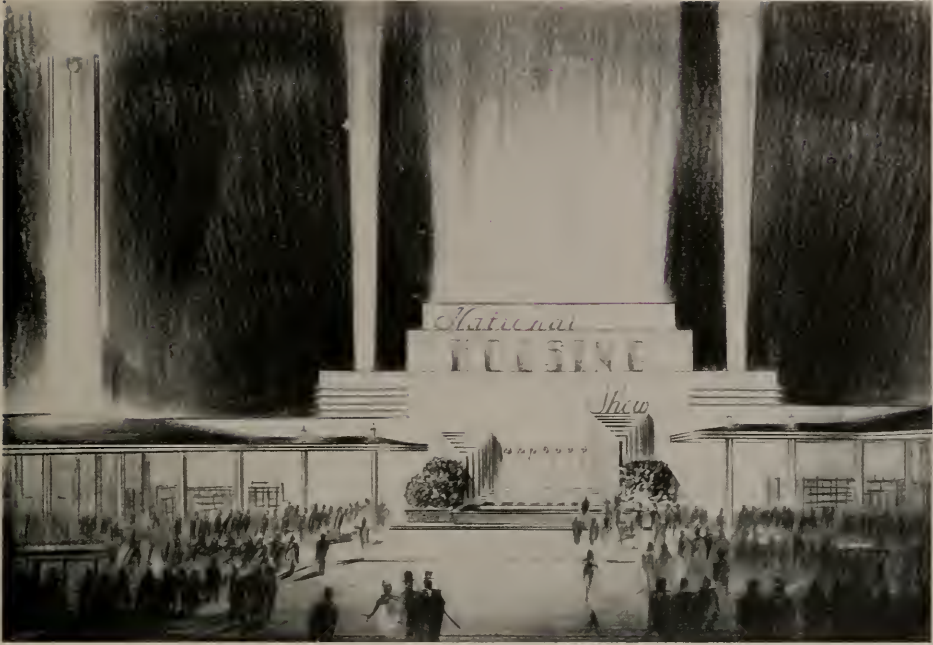

PERSPECTIVE OF FOUNTAIN, 1935 HOUSING SHOW, PORTLAND, OREGON

Roi L. Morin, Architect

HOW PORTLAND HOUSING SHOWS HAVE AIDED ARCHITECTS

By ROI L. MORIN, A. I. A.

ONCE a year every medium-sized American city, either spontaneously or through concerted effort, carries on a campaign to stimulate housing construction—and often these movements are climaxed by a "Housing Show," wherein the entire local building industry is invited to display its wares to the public. These "shows" have become such a well-established business that at least one eastern company is engaged in sponsoring such events, and its representatives travel from city to city promoting and seeking to manage these enterprises.

On several occasions in recent years Portland, Oregon, business men have been approached by these "high-pressure" agents but

after investigation have concluded that such exhibits could be handled by local talent, and through the cooperation of the Oregon Chapter, A.I.A.

Two Housing Shows have been successfully produced in Portland, the first in 1935 and the second in 1939.

Housing shows are usually accompanied by a voluminous amount of newspaper publicity which details the architect's part in planning the layout and buildings and has proven excellent advertising for him. Furthermore, these shows bring the architect into close and friendly cooperation with most of the leading citizens of a community—including the mayor, newspaper editors, leading manufacturers, mer-

HOUSING SHOWS STIMULATE BUILDING ACTIVITY



LEFT—GENERAL SITE PLAN OF OREGON NATIONAL HOUSING SHOW

BELOW—LIVING ROOM, MODEL HOUSE Harold W. Doty and Herman Brookman, Architects
Roi L. Morin, Supervising Architect



MODEL HOUSE, OREGON NATIONAL HOUSING SHOW, PORTLAND, OREGON
Herman Brookman and Harold Doty, Architects

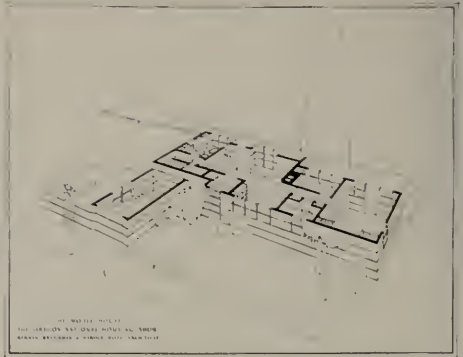



MODEL HOME, 1939 OREGONIAN HOUSING SHOW, PORTLAND, OREGON
Pietro Belluschi, Architect; Roi L. Morin, Architect in Charge

chandisers, realtors and business men throughout the city. At least this was our experience in Portland.

The 1935 Portland "National Housing Show" was instigated by the local FHA office, which advanced a modest sum to be used for promotional purposes in the guise of publicity, and the leading merchant prince of this city, Aaron M. Frank, was elected chairman of a citizens' committee of some 200 bankers, realtors, building material manufacturers and dealers, union labor, etc. An Oregon Chapter committee of three united with this organization and undertook the mechanics of designing and building the show, and the writer, because of previous experiences in stage designing and showmanship, was elected to carry on this work as Supervising Architect, and the general committee underwrote the design and drafting expenses. Harold W. Doty, A.I.A., and Herman Brookman, A.I.A., were commissioned to specially design the Model Home, a job in itself, and the theme of the show.

In accordance with a preliminary Site Plan, approved by the committee, we petitioned the City Council to close the streets for the better part of six city blocks around the Public Auditorium near the downtown business section and in less than a month, with the help of

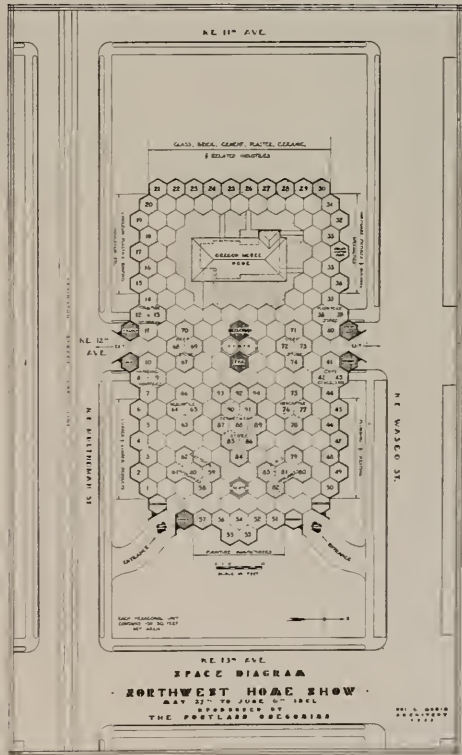

SPACE DIAGRAM, 1939 PORTLAND HOUSING SHOW

300 mechanics, some contributed by the Labor Temple, we built a little street Fair, at a cost of about \$30,000, the auditorium being used for exhibits such as furniture and draperies which could not be displayed in the open. The Model Home, which was raffled off, (necessitated wrecking two slum buildings to make way for same) a large Building Material Pavilion, a Sidewalk Cafe' of the French type, and a treasure chest hunt for gate prizes, formed the attraction highlights. Some 105,000 people (75,000 paid admissions) in 10 days, together with concession rentals, paid back the entire cost of this show, the effect of which stimulated residential construction and repairs not a little.

The 1939 Northwest Home Show was financed and managed by the Portland Oregonian and sponsored by the Portland Realty Board and FHA. Again the Oregon Chapter, A.I.A., was asked to undertake the design and supervision of the show, and again the writer was made architect in charge. Pietro Belluschi, A.I.A., of A. E. Doyle & Associate, was commissioned to execute the Oregon Model Home. This latter show, more modest than the first, was built entirely on two open city blocks, and the parti was predicated on the honeycomb pattern once used by Frank Lloyd Wright. Experience with the former show taught me that in such little "fairs" large open spaces are undesirable and that the public likes to wander through a maze of tortuous circulation leisurely examining exhibits on every hand, finally coming out onto an open plaza where the Model Home was on display in dramatic fashion.

The 1939 show cost about \$18,000 to build and manage, was attended by some 25,000 people, whose admissions, together with newspaper advertising by exhibitors, grossed \$21,-

000, a small net loss to the sponsors, but of considerable value in building up good will among advertisers. As weather conditions prevailing at the time have a considerable bearing on attendance at such open-air exhibits, many observers agreed that inclement weather militated against the success of the 1939 enterprise.

In each case, however, the A.I.A., Chapter and participating architects were showered with reams of publicity, the 1939 show being climaxed by a 100-page tabloid insert in a Sunday edition. The writer is of the opinion that other Chapters will find their time amply repaid by promoting such ventures in their respective localities.

The accompanying pictures give a general idea of the extent and character of these "little fairs" but except for the model homes (which were rather well done) the drawings should not be taken seriously as architecture but rather as "architectural millinery and showmanship." The structures were built of the cheapest materials immediately available on the local market, #3 framing lumber, 1/4" reject plywood, 1" thick asphalt paving, banners, bunting, bright sprayed colors and light tubing. About half of the materials used in the model homes were donated by local dealers but materials for practically all of the remainder of the show had to be bought at current prices.

Both shows were an excitement and a headache as we had but 30 days in each case from the time we were authorized to proceed until the gates were opened to the public, but we feel amply repaid for the time and effort in improving our relations with the leaders of the community.

This is the first of a series of short articles covering the work of the San Francisco office. United States Farm Security Administration. Development of site planning and architectural designs of farm workers' camps in the West will be discussed in later issues of Architect and Engineer.—Editor.



AERIAL VIEW OF THE RECENTLY COMPLETED MIGRATORY LABOR CAMP AT YAKIMA, WASHINGTON

A ROOF OVER THEIR HEADS

By HARRY SANDERS, JR.

TO thousands of farmers and farm workers of the dust, drought and flood areas of the United States, the fertile agricultural valleys of California have long personified "The Promised Land." Until the early 1930's the seasonal crops of the valleys were able to assimilate the majority of the crop followers entering the state, but when hordes of incoming migratory workers and their families surpassed by thousands the required number of agricultural workers there appeared squatter camps where people lived in conditions alarmingly squalid and filthy; there existed in the state a mobile population of an estimated two hundred thousand for whom there were few, if any, provisions for shelter, sanitation or health protec-

One-room shelters (upper right) and concrete tent platforms and trailer-parking lots (foreground) provide temporary living quarters for 342 families at the 130-acre Yakima camp. There are 48 farm workers' homes (left), which rent for approximately eight dollars a month. The community center building and the central utility building are located near the center of the project, and a group of farm buildings may be seen in the distance (upper left).



MODEL OF MULTI-FAMILY UNITS AT THE YUBA CITY, CALIFORNIA, CAMP

Eight of the 14 multi-family units recently completed at Yuba City are shown in this model. The row houses, which provide for six families each, are grouped about a pecan grove, in the center of which is located a sewing room and laundry building. The designers for Farm Security projects have experimented with all types of housing and have found that the row apartments effect an appreciable saving in the layout of utilities—water, gas, electricity and drainage—as well as in road materials.



COMMUNITY CENTER BUILDING, TULARE, CALIFORNIA

This building, which is similar to those at several other projects, contains a large assembly hall and stage, small meeting rooms, a nursery school, and a kitchen.

tion, recreation or schooling. In old tents, dry-goods crates and scraps of tin, many of these unfortunates faced a precarious future.

Following the unprecedented drought of 1934 that threatened to make a virtual Sahara out of the plains states between the Mississippi River and the Rocky Mountains, the problem of housing migrants in the California valleys became one of national concern. It was this situation in California—and a similar one in many other sections of the country—that the Federal Government faced in 1935 when it took first steps to alleviate the problems of the dispossessed farmers and the plight of farm workers as part of the rehabilitation program of the Resettlement Administration.

Owing to its enormous migratory population, California has been a logical place in which to center study and experimentation since the rehabilitation program first was organized. In 1937 the work was taken over by the Farm Security Administration, and since that time a force of architects, engineers and landscape architects in the San Francisco office of the organization has designed model camps and farm communities which provide temporary quarters for some 7200 families and permanent homes for more than 800 families in California, Arizona, Utah, Nevada, Oregon, Washington and Idaho (an estimated 45,000 persons total).

The San Francisco office of the Farm Security Administration, headquarters of District Six which includes the above mentioned states, is under the direction of Herbert P. Hallsteen, district engineer; Vernon De Mars, acting district architect, and Nicholas Cirino, regional engineer. Mr. De Mars is the able successor to the late Burton D. Cairns, who was killed December 15, 1939, in an automobile accident. Mr. Cairns, an authority on low cost housing and community planning, received national recognition for his work in connection with the Farm Security program, and a group of low cost apartments which he and Mr. De Mars designed for the government's Chandler, Arizona, project are included in a forthcoming Swiss publication, "The New Architecture—

Analytical Study of Twenty Examples of Modern Architecture Throughout the World," by Alfred Roth.

Primarily a problem of shelter, the rehabilitation program, after diversified research, soon became one in which economic, social and climatic approaches would play an important part; facilities for improving health and morale, recreational activities, an education for the children of a mobile population—all have influenced the architectural development of the camps. Moreover, a low cost budget necessarily became the influencing factor in combatting this problem so new and so vast.

A migrant farmer or farm hand in the West today finds three types of living quarters available in the camps of the Farm Security Administration:

In localities where only part-time labor is required on farms, orchards and ranches, Short Season Mobile Camps are established on 30 to 40 acres of leased land. During harvesting seasons of the various crops, the camps provide temporary units for 200 families and include such facilities as tent platforms, dressing rooms, bathing and toilet provisions, an assembly tent and laundry, street lighting and a clinic; these units are transported in trailers or trucks. Each family pays ten cents per day for privileges of the camp.

The Permanent Full Season Camp houses approximately 300 families in metal or frame shelters, tent platforms and trailer parking lots, which accommodations also cost ten cents per day. Accessible to each living unit there are a central utility building (containing toilet facilities and a laundry and ironing room) and a community center building for social and recreational gatherings. Each camp includes also a clinic and isolation hospital units. At most of the Full Season Camps there are 40 or 50 small homes which are rented to selected families for \$8.20 per month on a permanent basis. These homes are rented only to families who have been residents in the territory for a year and who can show that their chances for year-round employment are good. Dairy and poultry units are operated by the tenants at several camps,

MULTI-FAMILY HOUSES, CHANDLER FARMS, ARIZONA



These eight-family apartments at Chandler Farms were built of adobe with galvanized iron roofs painted with aluminum paint to reflect sunlight. Careful orientation with respect to the sun and prevailing winds provides sunlight during the winter months, while windows are shaded by wide eaves during the intense summer heat. Canvas flaps on wood frames are used on the second floor openings. Each dwelling unit consists of a living-dining area, kitchen, bath, two bed rooms and ample storage space. Approximate cost: \$1200 per family unit.



COMMUNITY CENTER BUILDING, CASA GRANDE, ARIZONA

This building serves the 60 families on the Casa Grande cooperative farm which is situated on 4200 acres of irrigated land 50 miles southeast of Phoenix. Like the individual homes on the project, it is built of stabilized adobe, a material found to be an excellent insulator in the extreme climate of Arizona. It contains a store, kitchen and assembly room where N.Y.A. and W.P.A. projects provide a nursery school and regular classes in cooking, sewing, music, dramatics and craft work.



FARM WORKER'S HOME, ARVIN, CALIFORNIA

One of 20 adobe houses built on one-acre plots at the Arvin camp. An attempt at lowest possible cost of housing, this one approximated \$800 and contains a combination living room and kitchen, a bath and a sleeping porch.

and nearly every family raises some of its food supply on the plot of ground allotted each dwelling.

In trying to establish the Early American plan of farming as a way of life, the ultimate goal of the F. S. A. calls for the creation of more Full Time Cooperative Farms, on which 40 or 50 families selected from low income brackets farm on land leased from the United States Government. These model farms provide permanent living quarters in individual houses or row apartments, a community center building and the necessary farm buildings and machinery. Participants in these enterprises—and there are several in operation in the West—devote full time to farming and share equally in the income.

FLUORESCENCE AND LIGHTING TRENDS

By NATHAN H. GRAVES

THE subject of fluorescent lighting might be covered by saying that only in late years have scientists adapted to modern use this scientific phenomena, known since the dawn of man.

The practical use of fluorescence is even yet in the formative stage with large concerns spending thousands of dollars in developing new and more efficient light sources. Today we have fluorescent lighting in several forms:

1. The new Mazda F. fluorescent lamps that operate from ballast and are popular for general commercial use.

2. The Cooper Hewitt fluorescent lamp.

3. The Neon type fluorescent lamps that operate either on a hot cathode principle or a high voltage cold cathode for signs. The hot cathode type of fluorescent lighting can be used for interior illumination though I am told that the fluorescent light of the lamp companies is more efficient. The only advantage of the hot cathode is that it can be made in lengths longer than standard lamps and may be bent to fit specific forms.

If the hot cathode type of fluorescent lighting is to be employed, a competent sign company with a good engineering staff should be employed to design a system that will fit the special need. I would recommend to any one using this type of lighting that they have the maintenance crew of the sign company take care of the service; and under no circumstances should the owner attempt to do so.

The Cooper Hewitt type of fluorescent lamps comes at present as a complete unit, made in single and double lamp sizes and supplied with the necessary transformers, ballasts, switches and reflecting equipment. The Cooper Hewitt is primarily an industrial unit as its color characteristics are too blue for practical commercial use. There is no flicker to this fluorescent lighting and it is a pleasant, cool light under which to work.

The Mazda F. fluorescent lamp is a new light source whose possibilities are not yet well

known. It is furnished in four standard lengths, 18", 24", 36" and 48". The 18, 24 and 36 inch lamps may be had in seven colors, daylight, white, gold, blue, green, red and pink. The 48" lamp comes only in daylight and white. These lamps use approximately 10 watts of electricity per lineal foot though in all cases each lamp must have a ballast in the circuit which uses about 20% additional electricity in its operation. The over-all efficiency of this Mazda F. lamp is approximately three times that of an incandescent lamp, it has one-fourth the heat under normal usage and this can be cut to one-tenth, if desired, by properly installing the operating equipment and the shielding of the lamps.

Laboratory tests have shown that under incandescent lighting it is possible for a person to work under 125 foot-candles, while with fluorescent lighting, 600 f. c. and more can be used comfortably. This means that the architect of today can bring sunlight into his clients' buildings, both in color, quality and intensities never before economically practical.

It is difficult to discuss the many technical phases of this type of lighting as each and every installation is an individual problem. The best solution for me is to tell you that the majority of the larger trade outlets and electrical utilities have in their employ members of the Illuminating Engineering Society, who are well qualified to give competent recommendations and advice as to necessary layouts.

One warning—in the majority of cases where fluorescent lighting is used some sort of control medium should keep the direct light from the lamp out of the eyes of those under it.

While attending a recent conference of lighting engineers at Nela Park in Cleveland, Ohio, I saw some of the new fluorescent lamps that are now in the process of development. One point mentioned was that within the next ninety days a new, larger and longer lamp will be introduced, one that will be about five feet

long and which will deliver approximately twice the light of the present four foot lamp, thus again cutting the cost per foot of this type of lighting. At his conference it was also brought out that for the commercial interior at least three watts per square foot of area to be lighted should be installed to make a satisfactory installation and in the case of office lighting, when continuous close work is being done, five watts per sq. ft. should be installed.

So far I have left out fluorescent lighting for the home; the reason is that there may be a disagreeable hum in the ballast equipment. Experiments are being made to eliminate this and I believe that the disadvantage will be overcome. With the use of colored fluorescent lamps it will be possible to produce interiors both striking and beautiful and atmospheres from the gayest to the most restful. The housewife needs only a few extra colored and white lamps to be able to bring the rainbow indoors.

A discussion of fluorescent lighting is not complete without mentioning lighting by ultra violet light and fluorescent paints. There are already more than twenty installations of this

character in the country, the largest of which are in Los Angeles where the decorated walls and ceilings fluoresce to give the desired lighting in the interiors. This is practical only where low intensities are desired but the effects are beautiful. Floor coverings may be had that glow in the black light as well as artificial flowers, plastic materials, glass, wall paper, plaster and paint. To produce this fluorescent effect it is necessary to have an ultra violet generator such as a 100 Watt H-4 mercury lamp with a Corning red violet filter, the necessary transformer and a reflector. The entire cost is only \$30 per unit and when the possibilities are realized this amount is small. Fluorescent paint costs about twenty cents a square foot to apply but lasts indefinitely indoors and may be washed and cleaned as any ordinary painted surface.

For years the Eye Conservation Council of America has recommended levels of intensities of light from 100 to 500 foot-candles for close tasks, and not until the advent of fluorescent light sources has it become economically possible to do this.

MONOLITHIC REINFORCED CONCRETE FOR ALL CLIMATES

By OLIVER G. BOWEN

THE subject of reinforced concrete buildings in Southern California and their desirability as a type of construction for the extremes of climate is often raised. A certain variation in construction methods is called for to meet either extreme heat or a freezing temperature, but a concrete job that is really good in a moderate climate is good in any climate. My recent experience has been mostly in Southern California and this article deals more directly with my observations of the work there with which I have been most intimately connected. In Michigan, Montana and other Northern states, where I have done work from time to time, I have found that the same principles are applicable.

However, it is not necessarily true that a good concrete job in some other sections would be adequate for California. In spite of the mild climate, Old Mother Nature does a little shivering out there now and then and throws things around a bit. To quote the Chamber of Commerce, that is "very unusual," but when it has occurred it has done things to some of the poorer construction that caused the inhabitants to shake in sympathy with Mother Nature.

The consequence of the 1933 Long Beach earthquake has been that California passed laws requiring that buildings be designed to withstand lateral forces as well as the up and down forces. This radical move has produced the slogan "come to California and enjoy the earthquakes."

Both design technique and the quality of construction have improved remarkably since these laws were passed. Engineers found that of necessity they must consider the effects produced by continuity of members, and constructors have had to keep pace with the improved design. Reinforced concrete building construction advanced more rapidly, perhaps, than other types, for the reason that concrete lends

itself readily to the solution of the problem of continuity in design. Architects were sympathetic with the modern trend toward displaying structural work where it had natural beauty of mass and line, instead of covering it up with ornamentation, plaster, or other artificial dressing. All these factors have led to the reputation which California contractors have of building excellent concrete work. The improvement has been due largely to the after effects of the 1933 earthquake.

What makes a good concrete building in any climate? Neglecting the architectural planning and other phases not directly related to the engineering structure, the following definition, I believe, covers the ground pretty thoroughly. A good concrete building is one which will withstand the live loads and other forces to which it is subject without damaging deflections or cracks and with an exceedingly slow rate of deterioration. Costs should also be considered in this definition. Of two structures, identical in size and function, the one with the lower cost is the better. Any money spent on the engineering structure of a building in excess of that necessary to conform with this definition, assuming that all architectural requirements are fulfilled, is money thrown away. In a laudable endeavor to provide for absolute safety, the requirements of some building laws and building officials cause an unjustifiable structural expense. They disregard the fact that the refinements of modern engineering design and the better quality of materials, make it entirely possible to design safely but at less cost. The ultra-conservatives are gradually leaning to the viewpoint of the moderns, and as the super-conservative regulations are modified, more new buildings will be done at less cost to both public and private capital, as well as with a considerable saving of our natural resources.

The next question to ask is how can a good concrete building be produced. The answer to this is not as simple as that to the first question.

* Structural Engineer, Los Angeles. Courtesy Bulletin of Illinois Society of Architects.

My view is that to achieve the desired result, one should have something like the following:

An adequate footing design so settlement will be equal over the entire area of the building.

A structural design which takes into account the quality of materials, the loads to be carried, and the continuity and deflections of each member of the structure.

A design and construction procedure that minimizes the formation of shrinkage cracks.

A mixture, mixing, placing, and curing of the concrete so as to produce the maximum of impermeability.

The approach to the footing problem is first to make a careful study and analysis of the soil or foundation underlying the site. In the case of important structures, it is probably best to have the study made by a soil mechanics expert. The structural engineer should compute the actual load carried by the column, bearing wall, and pier. These loads are usually mostly dead loads, although in the case of heavy warehouses, a portion of the live load should be included. The soil mechanics expert should advise the engineer regarding the effect of the area loading of the entire building, the settlement probabilities of small footings versus large footings, continuous footings versus independent footings, and the effects of underlying soft strata, plastic flow of the soil, seasonal change of water plane, fundamental unit safe bearing values, and other pertinent data. The engineer should evaluate all this and determine from this the type of footings to use to do a satisfactory job most economically.

A great many volumes have been written on the subject of structural engineering design and it is outside the scope of this article to do more than touch on a few highlights. One important point is that engineers are seldom paid enough for their work to afford to produce the best and most economical design for the owner. The two elements, economy and excellency, almost always go hand in hand. Experience has convinced the structural engineering profession that the preparation of several framing schemes, their cost analysis, and the use of modern design methods, instead of using moment coefficients and neglecting carry-overs

into adjacent vertical and horizontal members will save many times the extra design cost in the construction work. The same theme carries straight through the preparation of the structural engineering drawings and specifications, the foundation analysis, the use of high strength, high quality materials, and expert, competent engineering supervision of the construction work.

All these have a very direct bearing on the ultimate quality, cost, and permanency of the work. The design of a good modern concrete structure calls for a great deal more study, and consequent expense, on the part of the structural engineer than the production of a good looking set of drawings designed by the old-fashioned, simple methods. It seems to me that the architects might benefit their own status by helping to educate the owners to the ultimate savings to be accomplished by thorough, modern, engineering service. The engineer wants to do a good job provided the material consideration will permit it.

Probably the most difficult problem of all in the design and construction of any concrete structure is the minimizing of the ultimate formation of cracks. There are a few fundamentals which should be noted. In general, the greater the cement content, the finer the aggregate, and the more mixing water used, the greater will be the volume change. Many other elements enter into the problem. Without professing to be an expert on this subject, I am giving you the results of my observations over a period of years. The fineness of grinding the cements seems to have quite an influence. The coarser grinds, say from a specific surface of 1400 to 1500, seem to produce fewer cracks than cement ground to a fineness of from 2000 to 2200.

Length of time and completeness of curing has its importance. The more thoroughly concrete is cured, the fewer cracks there should be. Alternate wetting and drying seem to shorten the long dimension of a concrete specimen. Therefore, the exposed surfaces should be protected against the infiltration of moisture and the concrete made as dense and impermeable as possible. Thinner members crack more frequently than the thicker ones. Make each pour

(Turn to Page 45.)

PAUL HAYNES PENCIL SKETCHES

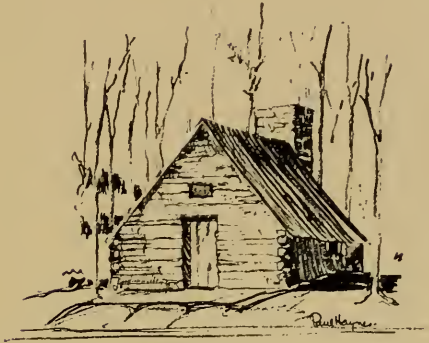

CONTINENTAL ARMY HUT, VALLEY FORGE, 1777-78

ILLUSTRATED on this and the following pages are pencil sketches by Paul E. Haynes, an architect of Los Angeles, and made during a trip through the United States in the summer and fall of 1938 as the first California holder of a Langley Scholarship. These sketches have been selected from a wide variety of subjects which Mr. Haynes found interesting, ranging from a street scene in Boston to a Continental Army hut in Valley Forge.

Mr. Haynes was born and educated in Los Angeles. Upon leaving school he entered the office of A. C. Martin for a period of four years. In 1929 he changed to the office of Myron Hunt and H. C. Chambers, where he has remained as a designer and delineator.

It is unfortunate, Mr. Haynes believes, that the ease and facility of camera recording should have lessened the interest of architects and draftsmen in sketching. He remarks, "Even a quick sketch of a building directs the attention to the design composition, the use of materials, and the structural scheme. Drawing from nature is of great benefit to a delineator in studying the play of light and shade upon materials and shapes, and in developing an appreciation for plant forms and landscape treatments."

In these sketches, Mr. Haynes has sought an honesty of presentation that is truly architectural, free from dramatic effects and artistic licenses. His work is to be noted for the sureness of the drawing and the accuracy of the details, as well as a nice appreciation for composition and contrasting light and dark values. Most of the sketches were drawn in the morning. Occasionally, when time was pressing, a sort of esquisse was made of the composition, materials, and sunlight, then the final drawing prepared in the evening.

While many of the subjects which were sketched are of historic importance, a number of modern buildings were also included. Among these is the Folger Shakespearean Library in Washington, which Mr. Haynes considers one of the finest buildings he saw during the trip. He drove east by way of Chicago and Montreal, traveled down the Atlantic coast and through the South to New Orleans, thence to California.



New Orleans.

SHOP—ROYALE STREET, NEW ORLEANS

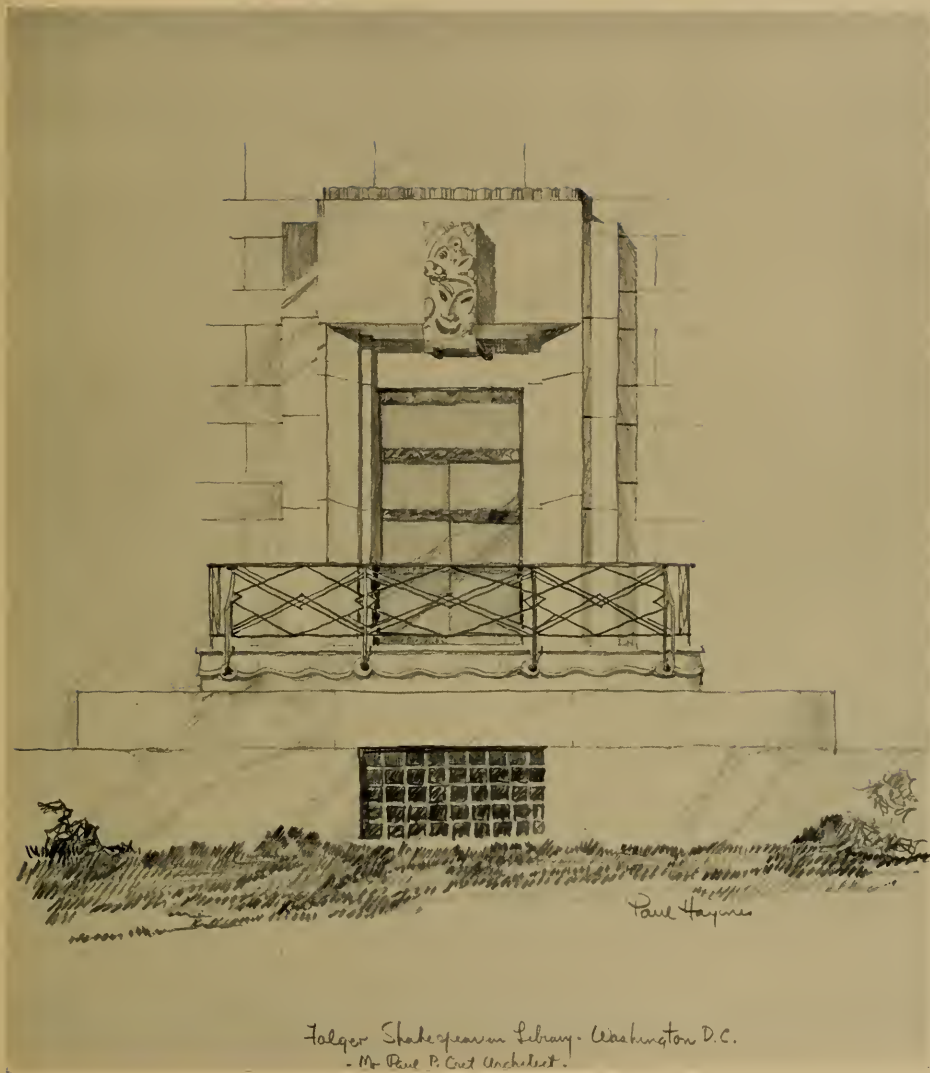

SIDE ENTRANCE, FOLGER LIBRARY, WASHINGTON, D. C.



St. Peter's Church - Phil'da.

SIDE DOORWAY, ST. PETER'S CHURCH, PHILADELPHIA

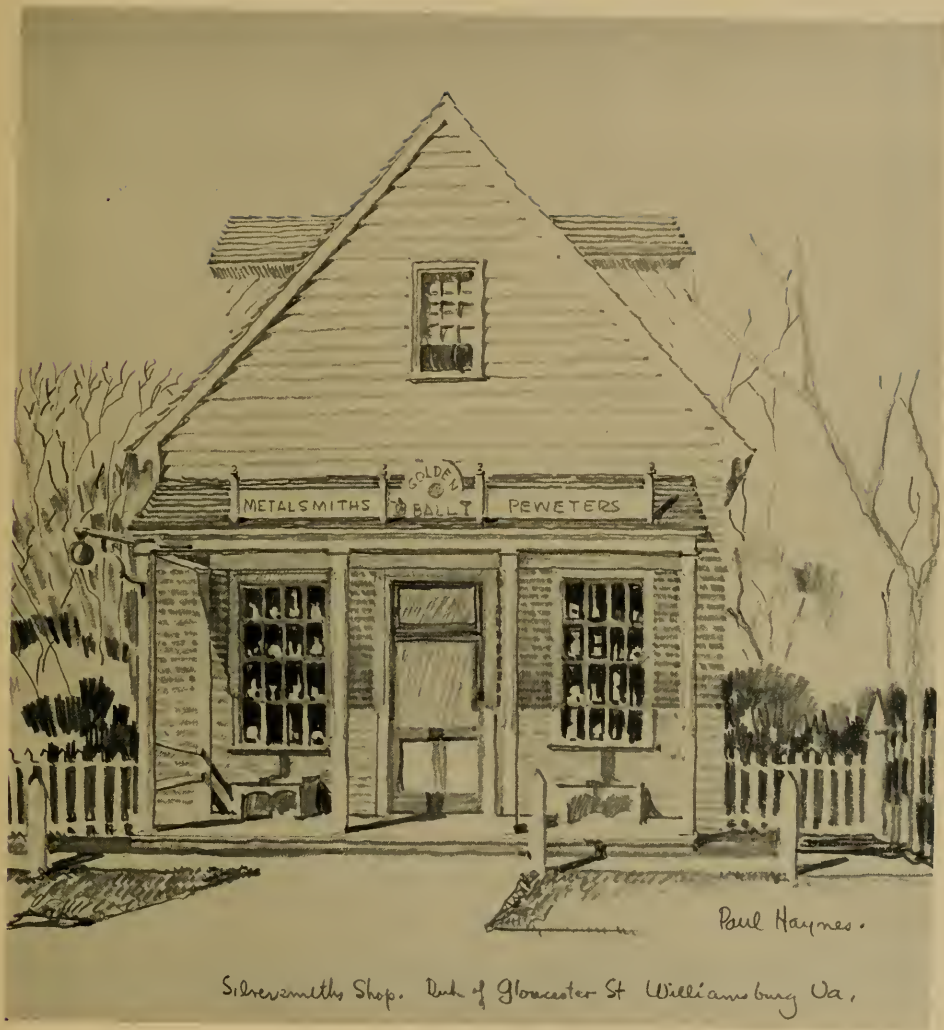

SHOP, DUKE OF GLOUCESTER STREET, WILLIAMSBURG, VA.



BOYLESTON AVENUE FROM THE COMMONS, BOSTON, MASS.



SHOPS, MONTREAL, CANADA

ALL THE THRILLS OF A STORY-BOOK HOUSE



HOUSE FOR CHARLES H. ACKERSON,
BURLINGAME HILLS, CALIFORNIA
William Henry Rowe, Architect



FRONT VIEW AND PLAN



on the work as small as is practicable to permit the margins to contract without restraint. The addition of reinforcing steel does not modify the volume change ratio in the least. It may, however, make the cracks closer together and smaller. Sharp re-entrant angles cause points of high stress, as will be noticed at window corners. Wherever possible put a small fillet at re-entrant corners.

Speed of placing concrete makes a difference. Jobs in which the contractor takes a great pride in his speed record usually show more cracks than those constructed at a more leisurely pace. This is probably due to the fact that in the speed jobs the pour margins are farther apart and have less time to shrink than in the slower jobs.

Heat of hydration plays an important part where sections are heavy. In this case it might be well to use the lower heat cements. For information on this refer to the "Concrete Manual" published by the Bureau of Reclamation.

Disintegration of concrete which is subject to salt air, sea water, or damaging soil waters has been a subject of great controversy. Some claim the disintegration is due to faulty aggregate and others to lack of resistance of the cement used. Frankly, I do not know. In such cases it would be well to use sulphate-resisting cement and the hardest, most durable aggregate obtainable.

The effect of climatic temperature change is to widen the cracks formed by contraction due to setting. One help for this is to insulate the roof above the concrete. It is my opinion that if cracks from contraction due to setting can be prevented, that, except in severe instances, all cracks will be prevented.

How is the most impermeable concrete produced? The answer is to get the concrete in the forms with a minimum of air and water voids. This subject ties up intimately with workability and with the characteristics of the aggregate. From the available aggregates select the one having the lowest absorption from heat, dried to saturation. Since the aggregate occupies most of the volume in the concrete this is important. Consider the sharpness of angularity of the particles. The aggregate

particles most nearly approaching a spherical shape will slide and roll on each other with the least friction. Therefore, it is evident that such an aggregate may be mixed with a minimum of the lubricant water-cement paste.

The grading of the aggregate comes next. Much has been written on this subject and not all authorities agree. Graphs showing particles, plotted against per cent of total aggregate, are available from many sources, but space does not permit of a discussion here. In general, the more angular and flattened the particles, the greater sand to total aggregate ratio should be used for workability. The greater this ratio, the more cement must be used, both to lubricate the mass and to fill the voids and coat the grains. In Los Angeles where we have some hard rounded aggregates, I use about 40% sand to total aggregate ratio. If a durable, impermeable concrete is to be obtained, a 28-day cylinder strength of not less than 3,000 lb. a square inch should be used. This requires a maximum of about six gallons of water to a sack of cement. The amount of this cement-water paste should vary with the kind of work being done, and as stated before, with the character of the aggregate.

If the work is large and massive, I think larger maximum size aggregate should be used, the slump kept down from one inch to three inches, and the concrete placed with a vibrator. If the work is thin and heavily reinforced, smaller aggregate should be used for the top size and the concrete placed with not over a six-inch slump.

The way to proportion a concrete mix is to assemble the aggregates with the proper grading and proportions and then add water-cement paste of predetermined water-cement ratio for strength, until the desired workability is achieved.

For a long time I have felt that a system should be devised whereby each ingredient, factor, and characteristic entering into the making, mixing, and placing of concrete would be given a value so that we could add, subtract, multiply, or divide in accordance with a formula and come out with a numerical answer which would mean the quality of concrete in place.

U.S. DISCOURAGES LEGAL REDRESS FROM ERRING CONTRACTORS

By W. E. REYNOLDS, Commissioner, Federal Public Buildings Administration

CONTRACTS made between the Public Buildings Administration and the contractors provide for redress to the Government in the form of liquidated damages, or termination of the right to proceed and completion by other means, in the event the contractor fails to complete the work within a stipulated time. Legally the Government is protected by such redress. But who wants to resort to redress with its accompanying penalties? Certainly not the Public Buildings Administration. I leave it to you what the contractor desires.—Such action contributes nothing as to achievement.

It is not representative of understanding or cooperation; it is not a fulfillment of the contractor's promise on which the Public Buildings Administration relies to fulfill its promises to its clients and for which these clients have no recourse except to adjust their own plans to meet such failures. It certainly is not a moral achievement, and the Public Buildings Administration expects of contractors their full efforts to complete their contracts within the time, and at a fair profit to themselves.

Some years ago there were two buildings under construction, separated only by a city street. The one contractor had his work well planned and was continually looking ahead. One morning he entered the Construction Engineer's office and said, "In about two weeks we are going to be in serious difficulty with the deep foundations at the northeast corner of the site. My engineer is working on it now, is making a drawing and will have it ready for discussion tomorrow afternoon." The difficulty was due to latent conditions only partly covered by the contract. With such advance warning a proper procedure was worked out, at small added cost, and with no delay to the general contract.

On the other building neither the contractor nor his superintendent ever saw a difficulty until

they were absolutely confronted by it. Advance planning was impossible and delays were frequent.

When the Public Buildings Administration issues a solicitation of bids in which time is the essence of the contract, it must expect of the intending bidders an understanding and a will to cooperate in executing the performance required, rather than to resort to the inclusion in their bids of liquidated damages for delays, with a view of deliberately thwarting the purpose on which the time is based.

In a recent instance the Public Buildings Administration fixed the time for installation of certain laboratory equipment which it had every assurance could be furnished and installed within the period fixed. The successful bidder failed to deliver the equipment until 60 days after the time allotted. The assessment of liquidated damages was a poor substitute for the inconvenience and loss to the Government, in that the laboratory technicians had to rearrange the assembly of their personnel, the beginning of certain research problems, the plans for the coordination and cooperation of their laboratory activities with other agencies, not only in the Government interests but for the health of American citizens.

LEGAL REDRESS CARRIES MANY PENALTIES

Recently a contractor for one of our Post Office buildings almost abandoned work after the project was 75% complete, and delayed the completion months beyond the contract time. The string of events that followed illustrates wherein legal redress is again a poor substitute for understanding and cooperation. Relying on the covenants made by the Public Buildings Administration with the contractor, the Post Office, in temporary quarters, arranged for cancellation of its lease but could not give it up; the lessor of these quarters had arranged for leasing to a commercial concern and was unable to deliver; this concern had to look elsewhere for obtaining satisfactory quar-

* Excerpts from an address before the 21st Convention of Associated Contractors of America.

ters and, in the end, the lessor of the temporary quarters found himself with vacated quarters and no tenant, whereas, if the contractor had cooperated in completing the building on time, the lessor of the temporary quarters would have found himself with a tenant on a long term basis. Obviously, redress provided by the contract could not, and did not, cover the economic waste.

The Public Buildings Administration expects contractors to effect completion of the minor defects and omissions remaining after buildings are occupied with as much energy as they exerted in reaching the occupancy stage. Aside from the benefits that accrue to the Government there are benefits of importance to the contractors. The Comptroller General of the United States has ruled that the responsibility, for the building as a whole, against damages from sources other than those done by Government occupancy, remains with the contractor until the last item (no matter how minor) of work is performed.

Citation of two rulings of the Comptroller General should awaken all contractors.

In 1936 an explosion of gas in the Post Office building at Glendive, Montana, wrecked the structure to the extent of approximately \$20,000. The cause of this explosion had its derivation in an outside source. The contractor had not been paid in full but had completed every item of work, and the paper work of making final settlement was in the last stages of adjudication. In this case the Comptroller General ruled that the contractor's responsibility had passed to the Government and the contractor was not held for the damages.

In the year 1937, when the Ohio River was at its great flood stage, the contractor for the Post Office building in Portsmouth, Ohio, had failed to complete the installation by about \$10.00 value of material. Notwithstanding the building had been occupied by the Government approximately six months, the Comptroller General held that the contractor had not fully completed the work and that the responsibility for damages by the high water to the building remained with him, and required that he pay approximately \$14,000 for the repair work necessary to restore the damages

done by the flood. Continued efforts on the part of the contractor have not succeeded in overruling this decision.

PERSONAL COOPERATION OF CONTRACTOR EXPECTED

We expect a personal cooperation on the part of the contractor with the officials of our office. The members of our organization are constantly trained to take a personal interest in every contract and contractor.

Experience has fully demonstrated that when a contractor appears in our office with a briefcase full of troubles and he has set down in a chair across the desk from one of our officials, the troubles soon are dissolved in agreements that flow readily from a better understanding of the position of both parties.

The Public Buildings Administration is not in position to compensate any contractor for the expense of making such a visit but certainly the cost to the contractor must be well worth while where correspondence does not satisfactorily reach a solution of problems.

Now for a few of the common troubles that exasperate parties on both sides of the contract and frequently delay progress and cause costly interruption to contractor's schedules.

We expect submission of samples in accordance with the instructions issued. Frequently contractors either do not understand the purpose of the design; permit sub-contractors to forward samples not in accordance with the requirements, or support illogical samples from material dealers who submitted low bids in the hope their materials would be approved.

We expect contractors to coordinate shop drawings made by different sub-contractors. Occurrences are very frequent in which such coordination is entirely missing and bring about delays in the schedule of work.

We expect contractors to check sub-contractors' estimates for changes in order to avoid delays in handling such proposals. Duplication of cost in proposals is very frequent, mostly due to misunderstanding.

We expect contractors to establish friendly relations in the locality in which the project is being built. The Public Buildings Administration is frequently judged by the conduct of the contractor. If he leaves a lot of unpaid bills, a

multitude of grievances, a number of disgruntled employees, it is a reflection on the Public Buildings Administration rather than on the contractor and results very frequently in this office being pestered with demands that the contractor pay such bills and satisfy the grudges of disgruntled employees.

The completed structure will be a visible contact between its citizens and the Federal Government, a visible evidence of Federal expenditure, generally the only example of Federal building construction. It is, therefore, important that the building should represent to the community good value for the money expended, good and suitable materials, good workmanship, and to the largest extent practicable, the use of competent local labor so that members of the community may point with pride to the work of their own hands.

We expect contractors to use separate letters for separate subjects on the same job. This is for the purpose of expediting decision through the large organization of many component parts of the Public Buildings Administration.

We expect contractors to submit samples, shop drawings, proposals for changes promptly in lieu of waiting until the very last minute and then wiring for expedition and claiming delays on account of the ensuing interruption to their progress schedule.

We expect contractors to pay sub-contractors, materials men and labor promptly. There is a constant flood of mail through the office protesting against non-payment of bills and demanding the Government undertake to force immediate settlements.

We expect the contractors in making their back-charges to sub-contractors and material men to explain the reason for such back-charges. There is no reason for the Public Buildings Administration to be interested in back-charges of any type, but we are being forced constantly to answer voluminous correspondence regarding these matters.

We expect contractors to place competent superintendents in charge of their work; not to employ inexperienced men because they can get them at low salaries and then depend on the Government's construction engineer to pull

them through. It is not the business of the Government inspector to direct the contractor's handling of his work and who, though quite frequently a good inspector, is not equipped for administration functions.

May I emphasize here that this expectation of cooperation on the part of the contractor is not a one-sided affair. The Public Buildings Administration extends to the contractor a like cooperation to the limit permitted by the mandates under which it must operate.

MODERN BUILDINGS

The 1930's in Retrospect

AS history has told us that the Egyptians built pyramids and the Romans produced great networks of highways to alleviate conditions of unemployment and depression, to forthcoming historians the Public Works Administration of the 1930's probably will symbolize the United States greatest era of public building.

Of the 26,474 structures of one kind or another financed by the Federal Government between 1933 and 1939, some 620 projects were selected as the best examples of the various types of buildings constructed for inclusion in "Public Buildings," recent publication by C. W. Short and R. Stanley-Brown. Printed by the United States Government Printing Office, the 688 page volume contains photographs, plans and accompanying descriptions of the selected projects and constitutes a valuable reference to sectional design and building trends. The book illustrates almost every type of building that came under the scope of the P.W.A. and includes both projects built by the Federal Government and those built by private owners with money loaned by the government.

Of the varied projects shown in "Public Buildings" it is evident that traditional design predominates in Federal work of the East, South and West, while a strong trend toward modern design is to be noted in the middle western states.

In the private work, however, there is evidence of a growing interest in modern architecture in all sections of the country; yet the

modern work is far out-numbered by examples of Colonial and Georgian architecture along the Atlantic Coast, throughout the South and in the Northwest; by Mission Spanish trends in California, and, most unfortunately, by several examples of a pseudo cliff-dweller Navajo adobe style in New Mexico. Again the tradition-free Middle West leads the modern field, but this time it is accompanied by California.

Despite the presence of many worthwhile buildings of both traditional and modern design, "Public Buildings" illustrates too many examples of traditional work that is sadly inferior to its architectural ancestors, and so much of the modern work appears to be struggling for originality through the bonds of a Twentieth Century Classicism. The authors describe the architectural indecisiveness of this transitional period as follows:

"Architecture, like all art, is never static but is undergoing a continual process of change. This change is due not only to the developments of new needs, new materials and new methods of construction but also to the desire, inherent in successive generations of man, to produce something better and different from that accomplished by the preceding generations. . . . This desire for change, however, is offset and balanced to a great extent by an equally human desire to preserve tradition.

"Today architecture in the United States is passing through a period of transition from eclectic design to something new and different," continue Messrs. Short and Stanley-Brown, "thus creating a condition which has much in common with that which existed in Italy in the fifteenth century when the architecture of the Middle Ages was changing to that of the Renaissance. Today, as then, changes in the character and style of architectural design occur slowly and constitute an evolution rather than a revolution."

Referring to the P.W.A. projects of the West Coast, the authors praise the work generally from a standpoint of design and of planning. Mention is made of "the great advance made in the use of concrete as a finishing

EDITOR'S NOTE—Since Mr. Sanders' excellent review was written there has developed a storm of criticism of the publishers for failing to give credit to many of the private architects who were identified with buildings illustrated. The matter has been brought to the attention of the A.I.A., for the purpose of preventing, if possible, a repetition of the oversight in future publications of this nature.

material" and credit is given the "Field Bill" enacted in the California State Legislature for protective requirements against seismic disturbances—and hence for the abolition of all types of veneer construction, projecting cornices and loose ornamental features.

Most of the Pacific Coast projects come under the following classifications:

Federal and state buildings, for the most part, adhere rather rigidly to the rules of planning established by the Beaux Arts school and at the same time display a flexible adaption of Classic exteriors; however, most "Classic-Modern" projects of the West bear fewer earmarks of the "modernistic" than do similar buildings in other sections of the country.

Most of the local government buildings of the smaller cities and towns in California uphold the traditional Spanish Mission type of architecture but boast plans suited to modern needs.

The outstanding examples of modern architecture and a few good examples of traditional work are to be found in the grade school and college buildings of the coast. It is generally conceded that the West leads school architecture of the country.

Certainly no phase of architecture illustrated in "Public Buildings" advanced in the 1930's more than did the utilitarian type of buildings, such as sewage and garbage disposal plants and water supply systems. In former times these projects were considered necessary evils and were invariably ugly; in the past few years they have become structures of great aesthetic merit without succumbing to the Hollywood false front of the 1920's.—H. S.

CONSTRUCTION INDUSTRY AT FAIR

As a mark of appreciation of the part played by the construction industry in the original building and in the second year run of the Golden Gate International Exposition, the Exposition directorate has named August 22nd to 24th as Construction Industries Days in honor of the industry.

PROMOTION FOR C. L. BADLEY

Charles L. Badley, Northern California architectural representative for the Celotex Corporation, has been appointed Western manager of acoustical sales for the Acoustical Division of the Celotex Corporation, with headquarters in San Francisco.

COPPER PANEL HEATING

Although the subject of "Panel" or "Radiant" heating has been widely discussed, this form of heating having been introduced in England a number of years ago, its practical application in California is very recent and, what is more important, very successful. The first copper panel heating job on the Pacific Coast, as far as is known, was installed in an Oakland home by Robert Bruen, Oakland heating contractor.

Figure 1 illustrates a still more recent application of panel heating. It was designed by Mr. Bruen for a five-room bungalow in Berkeley, an ordinary house of frame construction, one story, stucco exterior, worth about \$5,000. The photograph, incidentally, looks at the ceiling from the floor. The copper tubes are embedded directly in the conventional plastered ceiling.



**GAS-FIRED PANEL HEATING EQUIPMENT
INSTALLED IN CEILING**

In this ceiling are several panels, consisting of quarter-inch copper tubing bent in coils and covered with metal lath. The metal lath has been formed (channeled) to fit the round of the tubing, and has been metallically bonded to the tubing by immersing in a tinning bath. This feature is important to prevent undue expansion which would crack the plaster. Panels are fastened to the ceiling joists and are then plastered with the conventional two coats of plaster in the same manner as the surrounding ceiling and walls—the plaster job is performed just as though there were no coils there. Above each coil is an insulating blanket, two inches thick, consisting of mineral wool pads, enclosed in heavy paper. These are sealed at the edges to pre-

vent any air movement through the plaster into the attic space above.

This installation will be operated from the automatic gas water heater which supplies domestic hot water to the faucets, no special hot water piping being necessary in the house, as a connection can be made for each hot water faucet at the closest heating panel, and without causing the panel to heat up, as the hot water being drawn will by-pass the panel. The water heater must, of course, be of proper capacity to



**GAS-FIRED PANEL HEATING EQUIPMENT
INSTALLED IN FLOOR**

handle both the hot water and the heating. With economical natural gas fuel and perfected automatic gas water heaters, this presents no problem in this territory.

In laboratory tests one of these panels was found to come up to heating temperature (100 to 120°F.) within nine minutes after circulation was started; that is, the entire plaster mass of the whole panel reached the temperature indicated. With panel heating you do not have to wait for the air in a room to warm up before attaining a state of bodily comfort. As soon as the panel itself is warm, and delivering radiant heat to the occupants of the room, immediately the occupant is comfortable.

Figure 2 illustrates another type of panel heating, also operated from an automatic gas water heater, and installed in the floor. The coils are laid in a circular arrangement. Asphalt coat was laid between the coils to fill in, and tile floor laid over the top. This is in the Piedmont residence of Mr. H. H. Eggleston, a two-story, 12-room house.

With natural gas-fired automatic water heating, the fuel savings to be effected by panel heating will be revealing to home owners and builders. It is impossible to estimate definitely what these savings will be, but in Europe, where this type of heating has been used for thirty or more years, they claim operating costs 40% to 60% lower than with either warm air or radiator heating systems. Whether or not these claims are accurate, the fuel savings are considerable.

PLASTICS AND ARCHITECTURE

Recently the popular press has given us an increasing number of feature articles on applied science. Of the "gee whiz" variety, they tell of super-stockings spun from a laboratory synthesis of air, coal, and a pinch of salt. And we learn that milk from Italian goats is being transmuted into a warm, wooly fabric; that German industry, cut off from the East Indies, is content with a homemade rubber substitute. These, like rayon, cellophane, bakelite, and scores of such materials, are among our modern synthetic plastics. They are plastic in the sense that they are nonmetallic, capable of being formed and molded at some stage of their careers—synthetic in that they are "made" rather than "found." Although originally devised as substitute materials, plastics, being made by man to his own specifications, are usually superior to their prototypes when, indeed, such exist. Celluloid was originally devised as a substitute for ivory, yet one can hardly call the subsequent cellulosic compounds in clear, flexible cellophane, or brilliantly colored molding form, imitative of ivory, glass, or any other older material.

Since the beginning of time, man has made use of plastics to caulk his ships, to glue his furniture, to create ornament. A partial list of the natural plastics includes: amber, paraffins, tar, bitumens and asphalts, rubber, resin, glue, gelatine, waxes, casein, copals, shellac. Most of these materials will always remain in use for reasons of cost, availability, or special aptitude. Shellac compounds, which have a very high resistance to electricity and carbonization, will always find use as an insulant; casein plastics, now derived from protein sources other than milk (soybean and corn), will continue in use as a base for novelties and buttons. Both casein and shellac have high hygroscopicity (sensitivity to moisture) and, being more natural than not, do not fairly come under the heading of modern plastics. It can be said that plastics are synthetic in the same sense that music is a synthesis of sounds, and stainless steel a synthesis of elementary minerals.

As has been remarked, the layman has read about these materials. Besides his literary acquaintances, he and his wife have an appreciation and respect for plastics based upon intimate use. His wife has daily proof of the beauty, variety of application, and myriad qualities of these materials. Their highly polished surfaces insulate her knife and pot handles; they transparently enclose her market purchases, provide tough but handsome housings and bodies for her household mechanical equipment.

Plastics have come to play a brilliant and ubiquitous role in industry and in that special corner of industry which interests us—building. More cautious than many others, the building industry has found itself stirring affected by these materials. Just as plastics revolutionized electrical and automotive manufacture, so, it

would appear, are they likely to influence building. Architects have known of plastic electrical parts and decorative laminates for a decade or so. They have specified cellulose lacquers and plastic-covered coast seats. Some plastic hardware (generally of dubious design) has been available these past ten years. But quite recent years have turned the parade of incoming plastics into a real blitzkrieg. Whereas one or two basic plastics were available about ten years ago, there are actually scores of them today—all with varying qualities, characteristics, and applications. Before the World War, an architect's interest in plastics was limited to his transparent drawing instruments; today he wants to know everything about these materials that are making a ramifying advance into every branch of "materia architectura."

At the beginning, a general survey of the complex plastics field is discouraging. Even architects who took school courses in chemistry are mildly baffled by a new argot comprising such astonishing combinations as "methacrylate," "cellulose acetate," "butyrate," and "vinyl chloride." These and similar laboratory-born words and phrases twist the tongue and paint no mental image. Nor when manufacturers rechristen them is the situation improved. Brushing aside this barrier of cold, prickly words, we find the materials themselves—rich in color, simple in use, pleasant to touch. They are materials that a Frenchman would call "sympathetic," having a humanity about them shared only by wood and leather.

All plastics, whether liquid or solid, water clear or opaque, black or brilliant hued, hard or soft—all are classified under one of two headings, "thermoplastic" (heat-softening), and "thermosetting" (heat-hardening). Beyond this it is dangerous to generalize.—Morris Sanders in *Architectural Record*.

OREGON TO HAVE PLYWOOD PLANT

Oregon Plywood Corporation has been incorporated for \$250,000 for the purpose of constructing a modern plywood plant at Sweet Home, Oregon.

This new corporation has acquired a site of approximately thirty-five acres, including a log pond capable of storing five million feet of logs and exclusive water rights, insuring adequate water supply at all times for storage and other purposes.

Officers of the corporation include Franklin A. Hofheins, president; Robert F. Hofheins, treasurer, and Earl W. Leshar, secretary.

In commenting on the organization of the new company, Franklin A. Hofheins said:

"The plant will have an annual capacity of approximately 50,000,000 feet and will be one of the most modern and finest equipped plywood plants on the Pacific Coast.

END COLOR MONOTONY IN HOMES

Color monotony in homes, shops, theaters, and churches is combatted economically by a marble tile which may be used for fronts and entrances, vestibules, bathrooms, mantel facings, floors and many other building purposes, according to a bulletin of the Producers' Council, edited by the Structural Service Department of the American Institute of Architects.

Combining tile effect with the individuality of marble, the marble tile is effective for new work or for enhancing the beauty of an old home and bringing life to a dingy city front, it is pointed out. It is genuine marble, one-half inch thick, cut to standard sizes, and grooved on the back like glazed tile. It can be set like clay tile and is priced between ordinary wall tile and faience.

* * *

Structural glass with a "suede-finish," a soft unobtrusive surface finish of less brilliance and more restrained reflectivity, is described as giving "striking effect" in period interiors, store fronts, bathrooms and kitchens, building lobbies, and similar applications. It is available in white, black, gray, ivory, jade, beige, forest green, orange, wine, and Rembrandt blue.

"The soft, velvety surface of extraordinary richness is obtained by special treatment of the glass under the polishing machines," it is explained. "Its texture so diffuses the light that reflectometer readings show the actual glare reduced by approximately 45 to 75 per cent, depending upon the color involved. Yet in softening the reflectivity of the surface, the reflections are not blurred or distorted in any way.

"Cleanability was a primary consideration in the development of the suede-finish structural glass. It can be washed with entire satisfaction. If it has been soiled by grease, mastic, or other hard-to-remove materials, it can first be cleaned with an oil-free gasoline, and then, if necessary, with a solution made from one pint of household ammonia to ten quarts of water.

"A special purpose glass, suede finish rounds out and extends the design and decorative possibilities inherent in structural glass for modern uses."

* * *

A new type of synthetic rosin emulsion paint hides completely in one coat and dries in one hour to a smooth flat finish free from brush marks, it is reported. It has high light reflection qualities, making its use desirable where the saving of light is important, and is recommended for painting interior surfaces of plaster, concrete, hollow-tile, cinder-block, wallboard, and acoustic surfaces and exterior surfaces such as stucco, concrete and cement.

The difficulties experienced in painting walls that are fire-checked, patched, or have heat cracks are overcome by a combination of white pigments and oil size which is said to assure an even non-porous priming coat.

FHA BUILDINGS IN BRAWLEY 'QUAKE

The importance of proper construction as a protection for life and property was forcibly demonstrated in the Imperial Valley earthquake disaster of May 18.

In its study of various types of construction, stability and resistance to unusual strain, the Northern California district office of the Federal Housing Administration has compiled a comprehensive file on the havoc left in the path of the temblor. Authors of the reports contend that they found "an undisputable demonstration of the benefits derived from proper types of construction, due to the application of FHA standards and requirements."

They reported many houses completely wrecked. The severe shock shifted foundations, porch supports were gone, chimneys down, and roof lines so badly swayed that the houses must be razed. Immediately adjacent, however, were substantially constructed houses, built in accordance with Federal Housing requirements and inspection, which suffered no damage whatever. Even chimneys were standing, because they were properly reinforced.

Reporting on his observations, E. A. Walsh, Chief Underwriter in the San Diego office of the Federal Housing Administration, writes:

"It is not boasting to state that every individual or group whom I contacted during the three days' intensive work in the Imperial Valley were high in their praise for FHA construction standards and requirements.

"On this inspection trip I saw, personally, more than 200 houses on which we have insured loans. I talked with many of the occupants of these houses, and they were high in their praise of better housing standards, particularly when they were witnesses to the severe losses and casualties of their neighbors, who were less fortunate in regard to the types of construction used."

Another tribute to sound construction is contained in a report to the Director of Professional and Vocational Standards, written jointly by Assistant Secretary Calahan, of the California State Board of Civil Engineers, and Deputy Registrar Bowdle, of the State Contractors License Bureau. They found:

"In Brawley the resistance to earthquake by newly constructed residences, as compared to that exhibited by older types, was amazing. We are reliably advised that not one chimney was thrown off an FHA job, whereas a ruined chimney was the rule, rather than the exception, elsewhere.

"A very large percentage of older homes in Brawley were twisted off their foundations, with consequent interior and exterior damage. As to FHA jobs, inspectors reported that most, and possibly all, suffered no injury, not even plaster cracks."

ARCHITECTS' BULLETIN

Issued For

THE STATE ASSOCIATION OF CALIFORNIA ARCHITECTS

Northern Section

STATE ASSOCIATION MEMBER
OF THE
AMERICAN INSTITUTE OF ARCHITECTS

Editor
Harris C. Allen

Address all communications for publication
in the Bulletin to the Editor (Harris C.
Allen) 557 Market Street, Room 218, San
Francisco, California.

STATE ASSOCIATION OFFICERS

President.....Ernest E. Weihe, San Francisco
Vice-Pres.....Merrill W. Baird, Glendale
Secretary.....Robert H. Orr, Los Angeles
Treasurer.....Mario Ciampi, San Francisco

Regional Director—Southern Section

Gordon B. Kaufmann, Los Angeles

Regional Director—Northern Section

Harry M. Michelsen, San Francisco

Executive Board—Northern Section

Officers

President.....Ernest E. Weihe, San Francisco
V-Pres.....Frederick H. Reimers, San Francisco
Secretary.....Vincent Raney, San Francisco
Treasurer.....Mario Ciampi, San Francisco

Directors

Harold H. Weeks and Wayne Hertzka
(for one year)

Harry J. Devine and William C. Ambrose

Executive Board—Southern Section

Officers

President.....Merrill W. Baird, Glendale
Vice-Pres.....Winsor Soule, Santa Barbara
Secretary.....Robert H. Orr, Los Angeles
Treasurer.....Sylvanus B. Marston, Los Angeles

Directors

A. M. Edelman, George D. Riddle
(for one year)

Sam W. Hammill and Ben H. O'Connor
(for two years)

Northern Section Advisory Council

San Francisco District:

Frederick H. Reimers (President)

J. K. Ballantine, Jr. (Secretary)

Harris C. Allen

Dodge A. Riedy

Ernest E. Weihe

Mario J. Ciampi

Conrad T. Kett

Roland I. Stringham

Wm. H. Knowles

Vincent Raney

North Bay:

J. C. Felciano

Lower San Joaquin:

H. G. Bissell

Santa Clara

Chester Root

San Mateo:

Clyde Trudell

Upper Sacramento:

Casebolt Dakin

Sacramento:

Alfred Eichler

Upper San Joaquin:

David Horn

Monterey Bay:

Robert Stanton

Palo Alto:

Birge M. Clark

Marin:

Jas Bertenshaw

East Bay:

Irwin Johnson

Jas. H. Anderson

Ralph N. Kerr

Berkeley:

Gwynn Officer

Redwood Empire:

F. T. Georgeson

Lassen:

Ralph Taylor

Unification

SINCE the 1940 A.I.A. Convention adopted the amendments to its Constitution which were proposed in order to improve and strengthen unification of our profession in the United States, the movement is proceeding with an accelerated pace. Several more State Associations have decided to join the Institute. The following comments are quoted from the Bulletin of the Illinois Society of Architects:

"The recent meetings at Louisville indicate the trend of thought among the leaders of our profession and, if interpreted correctly, can be stated as a general agreement that one strong professional organization representing the architects of the United States as a whole is essential to the existence of the profession, and that the American Institute of Architects, already representing a majority of the organized portion of the profession, and whose object was stated in its constitution and by-laws 'to organize and unite in fellowship the architects of the United States of America' must and will adapt itself to such an extent as to properly and equitably represent the entire body of architects on a national scope, guiding not only aesthetically but economically as well. It is further agreed that this national body should be so administered as to permit full autonomy of local affairs to the State groups, such as the currently functioning State Associations which, in turn, may or may not be further subdivided as conditions require.

"There is still evidence of prejudices both on the part of certain 'Institute' men, as well as 'non-Institute' men, as to the desirability of the American Institute of Architects being the national body around which this unification program is to be centered. It is believed that considerable progress has been made in overcoming this unjustifiable attitude. As opposed to this position, there are perhaps an equal number of both 'Institute' and 'non-Institute' men who feel that the American Institute of Architects is not going as far nor as rapidly as it should in meeting the State Association demands or requirements.

"Summarizing the present status of the consolidation of interests in the architectural profession, in a national form, it may be said that unification rather than affiliation is the watchword. The Institute, as at present constituted, will gradually adapt itself to prevailing conditions, and will ultimately represent all reputable architects through local associations or chapters, which will be autonomous within their own geographical limits, and will be non-competitive with one another. Let us all strive to hasten this result, for then only will the profession of architecture receive its due recognition and respect."

PUBLIC RELATIONS

Members have received a letter in regard to the proposed radio program for public information. Architects are now presented with an opportunity for definite and speedy action to correct a condition long recognized and deplored, but which seemed too big and difficult to tackle.

Our Southern Section, with the boundless ambition and courage now associated with the very name of Southern California, refused to recognize

this handicap, and raised a fund by general subscription to start an experiment—to see if Goliath was really such an invulnerable giant that little David could not find a mark for his slingshot of facts and figures. "Mirabile dictu," the old blockhead was dented, and the Philistines retreated—to a sufficient extent that a second three-months campaign has been contracted for before the first is yet finished.

In the history of our Association, the Northern and Southern Sections have alternated in proposing new objectives or activities, and have not always agreed. But while sometimes differing over details, the two sections have carried on our major policies shoulder to shoulder and it has brought us all closer. The profession is very much stronger than it was twelve years ago. Our thanks are due, not only for this encouraging example, but for the opportunity to profit by the thought and labor that went into their broadcasting programs, which will make the work of our northern committees easier in preparing programs for listeners in this area.

To indicate the nature of this radio publicity, we reprint from the Southwest Builder and Contractor the highlights of a typical broadcast:

"Radio Broadcast Bulletin No. 5, KNX every Sunday, 10:00 to 10:15 a.m., June 3, 1940.

"We have tried to bring out the reasons for the many destructive practices followed in the building of homes by speculative builders during the past two broadcasts. We have done this not in a spirit of derision and tearing down, but with a real thought of constructive criticism with the solution to correct those evils given—namely, use the men really trained for this work—the architects.

"The architect is not a super man of heroic proportions, he is only the trained man, the man TRAINED for his work, which is designing and supervising the construction of homes and other buildings. That's the main difference between architects and others engaged in the construction of homes today.

"In last week's bulletin we discussed in detail the requirements and standards the architect MUST meet and live up to before he can even legally call himself an architect and practice the oldest of the arts in the State of California.

"Now what should be included in the plans and specifications required for your homes? What details should be clearly indicated? Remember the contractor figures ONLY the items shown on the plans and described in the specifications! Let us discuss the MINIMUM requirements for a complete set of plans and specifications for your home. You will note this item in your 'Check list of an Architect's Services' under Section No. 4.

"After the approval of preliminary sketches by the owner, the architect prepares what is known as the complete working drawings and specifications. These should and will contain the following minimum requirements if prepared by a registered architect in the State of California.

a. Plot Plan.

1. Legal description of property.
2. Street address.
3. Grades, present and finished.
4. Drainage.
5. Utilities.
6. Legal requirements—set back lines, easements, etc.

b. Structural Work.

1. Complete dimension on all plans, sections and detail.
2. Sufficient information to indicate all structural framing, walls, piers, bracing, etc.
3. At least four elevations and at least one section of any building.
4. Chimney and fireplace details.
5. Reinforced concrete and steel details.
6. Stairways.

c. Plans and Details.

1. Either complete window and door schedules or sufficient scale drawings to accurately show the size, type and materials required for all doors and windows.
2. To show operation of all doors, windows and other movable equipment.
3. Scale details, including details of all kitchen cabinets, both in elevation and section, and all special cabinet work; linen cases, cupboards, etc., sufficiently complete for the accurate estimating of the work.

d. Mechanical Equipment.

1. To show general runs and location of plumbing lines, vent stacks, cleanouts, etc.
2. Gas, electric, and water service meters, shut-offs, panel boards, motors, drains, etc.
3. Heating and ventilating equipment, furnaces, ducts, radiators, vents and motors.
4. Special structural framing in order to accommodate all mechanical equipment.

e. Specifications.

1. To definitely specify all materials in detail as to kind, quality, and workmanship.

"Each of the above sections and items could be used in a special bulletin, but suffice it to say they cover a COMPLETE set of plans and specifications. Compare these requirements with any set of plans and specifications.

"If you have any questions on the material in these bulletins write to the State Association of California Architects, Southern Section, Suite 212—3757 Wilshire Boulevard, Los Angeles, and they will be promptly answered without charge.

"AN ARCHITECT IS THE ONLY MAN ACTUALLY TRAINED FOR HIS JOB—LISTEN TO KNX EVERY SUNDAY, 10:00 to 10:15 A.M.

"A complete set of Radio Broadcast Bulletins may be had by applying at the State Association Office, 3757 Wilshire Boulevard."

CARPENTER APPRENTICES

Bill Hague of the A G C reports that on June 13, sixty apprentices were graduated as carpenters. Each was given a certificate of his qualification as a trained carpenter, signed by Hague as chairman of the Joint Apprentice Committee and by Alexander Watchman, president of the Building Trades Council, secretary of the committee. Some 600 carpenters were present and Bill says a finer, cleaner looking lot of young men never received diplomas. This work is important, and should be officially recognized by our own Association, for the old haphazard and inadequate method of training apprentices was often an obstacle to the work of the architect.

AGC DIRECTORS

In scanning the Central California "Chapter News" one cannot but be impressed by the list of officers. When one considers the stunning array of manly pulchritude here assembled,

With the Architects

CHURCH ARCHITECTURAL GUILD

The Church Architectural Guild of America is the somewhat elongated title of a new organization which came into being at the recent meeting of the North American Conference on Church Architecture and Allied Arts. Officers elected June 21 were: Honorary president, Ralph Adams Cram, Boston; president, Harry L. Walker, New York; vice-presidents, Philip Frohman, Washington, and Carleton M. Winslow, Los Angeles; secretary, Paul Maynard, 419 Fourth Ave., New York; treasurer, Harry Warren, New York.

CENTERVILLE GRAMMAR SCHOOL

Plans have been completed in the office of Birge M. and David Clark of Palo Alto for a \$65,000 classroom and auditorium for the Centerville Grammar School District. Bids have been taken and contracts awarded. Construction will be frame and stucco, composition roof, steel sash, maple floors, oil burner and steam heat.

MORTUARY BUILDING

Anthony J. Horstmann, 101 Post Street, San Francisco, is preparing working drawings for a \$60,000 mortuary building to be built at 10th Avenue and Geary Street, San Francisco, for McAvoy and O'Hara. There will be a chapel, office room, garage and four-room apartment on the second floor. Plans will go out for bids early in September.

BERKELEY STORE BUILDING

F. W. Woolworth Company will have a new building to take care of its growing Berkeley business. Plans have been completed by Stafford L. Jory, Phelan Building, San Francisco, for a \$60,000 plant on Ashby Avenue to cover ground area 85X110 with steel frame, concrete walls and considerable tile work.

one wonders if these contractors expect to win their contracts by sheer charm and beauty—like Apollo or Adonis? Consider Fred Early and Dick Walberg—Bill Tait and Bill Lyons and Bill Hague—John Cahill and Harry Hilp and George Williams—how can art-loving architects resist such an aggregation of Phidian Physiognomy? There is no need to look farther for candidates to fill the role of "Mr. California."

President Weihe has appointed a Committee on Arrangements for the annual convention to be held at Del Monte in October, consisting of Edward H. Maher of San Francisco, chairman; George P. Simmonds of Hayward, and Robert Stanton of Del Monte.

OREGON STATE BOARD

Francis Jacobberger, architect of Portland, has been elected president of the Oregon State Board of Architect Examiners, succeeding Kenneth C. Legge who will serve as vice-president during the coming year.

Margaret G. Fritsch is secretary and Glenn Stanton treasurer.

The following have been appointed by the Governor to serve on the board: Fred Aandahl, Kenneth Legge, Glenn Stanton and Francis Jacobberger, all of Portland and Frank Clark of Medford.

Architects recently presented with certificates of registration in the State of Oregon included Harry M. Newman, Carl U. Collins, George Whittier, Roscoe H. Logan and Keith Maguire of Portland, in addition to Clarence L. Smith of Salem.

BANK CONTRACT AWARDED

Bank of America has awarded Cahill Bros. the contract to erect its new office building at Pine and Montgomery Streets, San Francisco, from plans by the company's engineering department. Approximately \$2,000,000 will be expended on the 14-story structure.

ADDITION TO RENO HOTEL

A \$50,000 addition is planned to the El Cortez Hotel, Reno, from plans by L. A. Ferris of that city. Construction will be of steel and concrete. There will be six stories with provision for 50 additional rooms and baths.

MEDICO-DENTAL BUILDING

From plans by Douglas D. Stone, 381 Bush Street, San Francisco, a two-story reinforced concrete and frame medico-dental building will be constructed in Vallejo by the Metropolitan Company, Inc. The cost of the improvements is estimated at \$55,000. Bids are in and under advisement.

GIFT TO TACOMA SOCIETY

Frederick Heath, Jr., son of Frederick Heath, member of the architectural firm of Heath, Gove & Bell, Puget Sound National Bank Building, Tacoma, Wash., has presented his collection of beautiful colored pictures of New England brick work to the Tacoma Society of Architects.

GOLF TOURNEY

The Washington State Chapter, A.I.A., held its annual golf tournament at the University Golf Course July 24. Competition was keen for the Clay Products Co. trophy held by C. J. Brady during the past year. Dinner at the Edmond Meany Hotel ended a most enjoyable day.

MODERNIZED PRODUCTS

Brief Notes on New Materials and Equipment in the Building Industry.

422. TOILET DEVICE

The Sani-Toil Sales Corporation has issued literature on a new toilet device which promises to revolutionize toilet installations. It is already being placed in service stations and other public convenience depots. It is a system of forced ventilation. Send for the booklets by using the coupon below.

423. STOPS LEAKS

An old friend, Flexrock, has just sent us the data on a new, active ingredient which makes "Flexitite" of the utmost value to the plant engineer. As a method of stopping leaks, Flexitite, with this new element added, is the long-sought-for answer against leakage in dams, irrigation systems, retaining walls, tanks and reservoirs. Send for your copy.

424. FIREPLACE CURTAIN

A fireplace curtain which is quite an innovation, is the object of a booklet issued by Colonial Shops. The device will fit any fireplace and can be installed with a minimum of effort. The same company also has a line of fireplace fixtures which are distinctive and attractive.

425. AWNING TYPE WINDOWS

Universal Window Company have put out complete details and specifications for Awning Type Windows, better known as the Donovan Windows, the invention and part of the life work of one of the Pacific Coast's most prominent architects. Send for these details by using the coupon.

426. HOSPITAL SIGNALS

One of the important installations of today in our modern American life is that of an efficient signal system in hospitals, where speed and accuracy in calling members of the staff is of primary importance. A new booklet put out by the Connecticut Telephone and Electric Corporation gives all the details of such a system, with illustrations of equipment and wiring.

427. WINDOW UNITS

Anderson Corporation have two interesting booklets giving facts concerning complete window units for all

types of residences, from attic to basement, combining beauty with utility. Profusely illustrated, these booklets are most attractive.

428. TIME SAVER

"Drafto," a handy, time-saving tool for engineers and architects, manufactured by the Drafto Company, is being given considerable publicity these days. The details are found in a broadside issued by the company, which gives specifications and directions for use. Send for a copy; use the coupon.

429. FLOOR COVERS

American Tile and Rubber Company have a new booklet illustrating the various types of floor coverings manufactured by this company. Illustrated in color, this is an extremely handsome booklet. Some very rich and colorful designs are included.

430. ALL-GAS HOME

A new booklet issued by Servel-Electrolux and entitled "Let Me Tell You About My Modern ALL-GAS Home," has some very interesting features which will be of interest to home owners and builders. Send for a copy by using the coupon below; it is there for your convenience.

431. FURNACE HEAT

Payne Furnace and Supply Company have a new broadside just out which is a part of their latest advertising campaign. It tells a most convincing story and is rather unique in its form—opening out into a full-sized sheet of brilliant red and black type. The latest furnace heating news is contained in this interesting folder.

432. SUN SCREENS

A very attractive booklet issued by the Ingersoll Steel and Disc Division of the Borg-Warner Corporation has for its subject matter data on the reduction of solar load through windows, by the use of Ingersoll "Koolshade" sun screens. There has been made here a careful statistical compilation of daylight hours and effects of the sun's rays through various types of windows. Send for a copy; the coupon will assure you of having this data sent direct.

433. HOT WATER TANKS

Porcelain Steels have a new booklet which illustrates their "Porcel-Clad" hot water tanks, porcelain enameled inside and out. These tanks are stated by their makers to be "as clean as a china cup."

434. SAFETY TREADS

A complete set of specifications enclosed in a durable cover has been issued by Wooster Products. These are for the line of Wooster safety treads, thresholds, saddles and sills. This company makes a great many metal products for use in the building industry. Send for a copy of the specifications.

435. HEAT COILS

Fedders Manufacturing Company have a new booklet which gives tables and complete details on their Type K heating coils. Included also are blue print scale drawings of complete installations. Send for your copy by using the coupon.

FREE FOR THE ASKING

Check items on coupon, paste on letter head or postal card, and mail to Architect and Engineer.

Architect and Engineer
68 Post Street
San Francisco, Calif.

Please send me literature on the following items as checked below. This places me under no obligation.

422	<input type="checkbox"/>	429	<input type="checkbox"/>
423	<input type="checkbox"/>	430	<input type="checkbox"/>
424	<input type="checkbox"/>	431	<input type="checkbox"/>
425	<input type="checkbox"/>	432	<input type="checkbox"/>
426	<input type="checkbox"/>	433	<input type="checkbox"/>
427	<input type="checkbox"/>	434	<input type="checkbox"/>
428	<input type="checkbox"/>	435	<input type="checkbox"/>

My Name.....
Name of Company.....
Street.....
City..... State.....

Estimator's Guide

Giving Cost of Building Materials, Wage Scale, Etc.

Amounts given are figuring prices and are made up from average quotations furnished by material houses to San Francisco contractors. 3% Sales Tax on all materials but not labor.

All prices and wages quoted are for San Francisco and the Bay District. There may be slight fluctuation of prices in the interior and southern part of the state. Freight cartage, at least, must be added in figuring country work.

Bond—1/2% amount of contract.

Brickwork—

Common, \$40 to \$45 per 1000 laid, (according to class of work).
 Face, \$90 to \$100 per 1000 laid, (according to class of work).
 Brick Steps, using pressed brick, \$1.00 lin. ft.
 Brick Veneer on frame buildings, \$0.70 sq. ft.
 Common f.o.b. cars, \$14.00 at yard. Cartage extra.
 Face, f.o.b. cars, \$45.00 to \$50.00 per 1000, carload lots.

HOLLOW TILE FIREPROOFING (f.o.b. job)

3x12x12 in. \$ 84.00 per M
 4x12x12 in. 94.50 per M
 6x12x12 in. 126.00 per M

Building Paper—

1 ply per 1000 ft. roll \$3.50
 2 ply per 1000 ft. roll 5.00
 3 ply per 1000 ft. roll 6.25
 Sisalkraft, 500 ft. roll 5.00
 Sash cord com. No. 7 \$1.20 per 100 ft.
 Sash cord com. No. 8 1.50 per 100 ft.
 Sash cord spot No. 7 1.90 per 100 ft.
 Sash cord spot No. 8 2.25 per 100 ft.
 Sash weights cast iron, \$50.00 ton.
 Nails, \$3.50 base.
 Sash weights, \$45 per ton.

Concrete Aggregates—

Gravel (all sizes) \$1.45 per ton at bunker; delivered to any point in S. F. County \$1.85.

	Bunker	Delivered
Top sand	\$1.45	\$1.85
Concrete mix	1.45	1.85
Crushed rock, 3/4 to 3/4	1.60	2.00
Crushed rock, 3/4 to 1 1/2	1.60	2.00
Roofing gravel	1.60	2.00
City gravel	1.45	1.85
River sand	1.50	1.90

Delivered bank sand—\$1.00 per cubic yard at bunker or delivered.

SAND—

	Bunker	Delivered
River sand	\$1.50	\$1.90
Lepis (Nos. 2 & 4)	2.00	2.40
Olympia Nos. 1 & 2	1.80	2.20
Healdsburg plaster sand	\$1.80 and \$2.20	
Del Monte white	50c	per sack

CEMENT (all brands, common, cloth sacks) \$2.72 per bbl. f.o.b. car; deliv. \$2.70 per bbl., carload lots; less than carload lots, warehouse or deliv., 80c per sack. (Less 10c per sack returned, 2% 10th Prox.)

Common cement (all brands, paper sacks) carload lots \$2.52 per bbl. f.o.b. car; delivered, \$2.70; less than carloads delivered, 75c per sack. Discount on cloth sacks, 10c per sack. Cash discount on carload lots, 10c a barrel, 10th Prox.; cash discount less than carload lots, 2%.

Atlas White } 1 to 100 sacks, \$2.00 sack,
 Calaveras White } warehouse or delivery;
 Medusa White }

Forms, Labors average \$40.00 per M.
 Average cost of concrete in place, exclusive of forms, 35c per cu. ft.; with forms, 60c.
 4-inch concrete basement floor 12 1/2c to 14c per sq. ft.
 Rat-proofing 7 1/2c
 Concrete Steps \$1.25 per lin. ft.

Dampproofing and Waterproofing—

Two-coat work, 20c per yard.
 Membrane waterproofing—4 layers of saturated felt, \$4.50 per square.
 Hot coating work, \$1.80 per square.
 Medusa Waterproofing, 15c per lb., San Francisco Warehouse.
 Tricocel waterproofing.
 (See representative.)

Electric Wiring—\$12.00 to \$15.00 per outlet for conduit work (including switches).
 Knob and tube average \$3.50 per outlet.

Elevators—

Prices vary according to capacity, speed and type. Consult elevator companies. Average cost of installing an automatic elevator in four-story building, \$2800; direct automatic, about \$2700.

Excavation—

Sand, 60 cents; clay or shale \$1 per yard.
 Teams, \$12.00 per day.
 Trucks, \$22 to \$27.50 per day.

Above figures are an average without water. Steam shovel work in large quantities, less; hard material, such as rock, will run considerably more.

Fire Escapes—

Ten-foot galvanized iron balcony, with stairs, \$115 installed on new buildings; \$140 on old buildings.

Floors—

Composition Floors—22c to 40c per sq. ft. In large quantities, 16c per sq. ft. laid.
Mosaic Floors—80c per sq. ft.
Duraflex Floor—23c to 30c sq. ft.
Rubber Tile—50c to 75c per sq. ft.
Terazzo Floors—45c to 60c per sq. ft.
Terazzo Steps—\$1.60 lin. ft.

Hardwood Flooring (delivered to building)—

	1 1/2x2 1/4"	1 3/8x2"	3/4x2"
Clr. Qtd. Oak	\$144.00 M	\$122.00 M	\$141.00 M
Sel. Qtd. Oak	118.00 M	101.00 M	114.00 M
Clr. Pla. Oak	120.00 M	102.00 M	115.00 M
Sel. Pla. Oak	113.00 M	92.00 M	107.00 M
Clr. Maple	125.00 M	113.00 M	

Wage—Floor layers, \$10.00.
 Note—Above quotations are all board measure except last column which is sq. ft.

Glass (consult with manufacturers)—

Double strength window glass, 20c per square foot.
 Plate 75c per square foot (unglazed) in place, \$1.00.
 Art, \$1.00 up per square foot.
 Wire (for skylights), 40c per sq. foot.
 Obscure glass, 30c to 50c square foot.
 Glass bricks, \$2.40 per sq. ft., in place.
 Note—If not stipulated add extra for setting.

Heating—

Average, \$1.90 per sq. ft. of radiation according to conditions.
 Warm air (gravity) average \$48 per register-fer.
 Forced air, average \$68 per register.

Iron—Cost of ornamental iron, cast iron, etc., depends on designs.

Lumber (prices delivered to bldg. site).

No. 1 common	\$30.00 per M
No. 2 common	28.00 per M
Select O. P. common	35.00 per M
2x4 No. 3 form lumber	22.00 per M
1x4 No. 2 flooring VG	58.00 per M
1x4 No. 3 flooring VG	51.00 per M
1x6 No. 2 flooring VG	70.00 per M
1 1/4x4 and 6, No. 2 flooring	70.00 per M

Slash grain—

1x4 No. 2 flooring	\$45.00 per M
1x4 No. 3 flooring	42.00 per M
No. 1 common run T. & G.	33.00 per M
Lath	5.50 per M

Shingles (add cartage to price quoted)—

Redwood, No. 1	\$1.10 per bble.
Redwood, No. 2	1.00 per bble.
Red Cedar	1.10 per bble.

Plywood—Douglas Fir (ad cartage)—

"Plycord" sheathing (unsanded)	
5/16" 3-ply and 48"x96"	\$32.50 per M
"Plywell" (walboard grade)—	
1/4" 3-ply 48"x96"	\$37.50 per M
"Plyform" (concrete form grade)—	
3/8" 5-ply 48"x96"	\$110.00 per M
Exterior Plywood Siding—	
7/16" 5-ply Fir	\$ 90.00 per M
Redwood (Rustic)	85.00 per M

Millwork—Standard.

O. P. \$85.00 per 1000. R. W., \$100.00 per 1000 (delivered).
 Double hung box window frames, average with trim, \$6.50 and up, each.
 Doors, including trim (single panel, 1 3/4 in. Oregon pine) \$8.00 and up, each.
 Doors, including trim (five panel, 1 3/8 in. Oregon pine) \$6.00 each.
 Screen doors, \$3.50 each.
 Patent screen windows, 25c a sq. ft.
 Cases for kitchen pantries seven ft. high per lineal ft., \$8.00 each.
 Dining room cases, \$8.00 per lineal foot. Rough and finish about 75c per sq. ft.
 Labor—Rough carpentry, warehouse heavy framing (average), \$17.50 per M.
 For smaller work average, \$35.00 to \$45.00 per 1000.

Marble—(See Dealers)

Painting—

Two-coat work	per yard	42c
Three-coat work	per yard	60c
Cold water painting	per yard	10c
Whitewashing	per yard	4c
Turpentine, 65c per gal., in 5 gal. cans, and 55c per gal. in drums.		
Raw Linseed Oil—95c gal. in light drums.		
Boiled Linseed Oil—98c gal. in drums and \$1.08 in 5 gal. cans.		

White Lead in oil

	Per Lb.	
1 ton lots, 100 lbs. net weight.....		113/4c
500 lbs. and less than 1 ton.....		12c
Less than 500 lb. lots.....		121/2c

Red Lead and litharge

1 ton lots, 100 lbs. net weight.....		113/4c
500 lbs. and less than 1 ton.....		12c
Less than 500 lb. lots.....		121/2c

Red Lead in oil

1 ton lots, 100 lbs. net weight.....		123/4c
500 lbs. and less than 1 ton.....		13c
Less than 500 lb. lots.....		131/2c

Note—Accessibility and conditions cause some variance in costs.

Patent Chimneys—

6-inch	\$1.25 lineal foot
8-inch	1.75 lineal foot
10-inch	2.25 lineal foot
12-inch	3.00 lineal foot

Plastering—Interior—

	Yard	
1 coat, brown mortar only, wood lath		\$0.50
2 coats, lime mortar hard finish, wood lath85
2 coats, hard wall plaster, wood lath.....		.72
3 coats, metal lath and plaster.....		1.25
Kesene cement on metal lath.....		1.30
Ceilings with 3/4 hot roll channels metal lath (lathed only).....		.90
Ceilings with 3/4 hot roll channels metal lath plastered.....		1.80
Single partition 3/4 channel lath 1 side (lath only).....		.85

Single partition 3/4 channel lath 2 inches thick plastered	\$2.90
4-inch double partition 3/4 channel lath 2 sides (lath only).....	1.70
4-inch double partition 3/4 channel lath 2 sides plastered	3.30
Thermax single partition; 1" channels; 2 1/4" overall partition width. Plastered both sides	2.50
Thermax double partition; 1" channels; 4 3/4" overall partition width. Plastered both sides	3.40
3 coats over 1" Thermax nailed to one side wood studs or joists.....	1.25
3 coats over 1" Thermax suspended to one side wood studs with spring sound isolation clip	1.45

Plastering—Exterior—

	Yard	
2 coats cement finish, brick or concrete wall		\$1.00
3 coats cement finish, No. 18 gauge wire mesh		1.50
Wood lath, \$5.50 to \$6.50 per 1000.....		
2.5-lb. metal lath (dipped)19	
2.5-lb. metal lath (galvanized)21	
3.4-lb. metal lath (dipped)22	
3.4-lb. metal lath (galvanized)24	
3/4-inch hot roll channels, \$72 per ton.		
Finish plaster, \$18.90 ton; in paper sacks.		
Dealer's commission, \$1.00 off above quotations. \$13.85 (rebate 10c sack).		
Lime, f.o.b. warehouse, \$2.25 bbl; cars, \$2.15		
Lime, bulk (ton 2000 lbs.), \$16.00 ton.		
Wall Board 5 ply, \$50.00 per M.		
Hydrate Lime, \$19.50 ton.		
Plasterers Wage Scale.....	\$1.67 per hour	
Lathers Wage Scale.....	1.60 per hour	
Mod Carriers Wage Scale.....	1.40 per hour	
Composition Stucco—\$1.80 to \$2.00 sq. yard (applied).		

Plumbing—

From \$70.00 per fixture up, according to grade, quantity and runs.

Roofing—

"Standard" tar and gravel, \$6.00 per sq. for 30 sqs. or over.
 Less than 30 sqs. \$6.50 per sq.
 Tile, \$20.00 to \$35.00 per square.
 Redwood Shingles, \$7.50 per square in place.
 Copper, \$16.50 to \$18.00 per sq. in place.
 Cedar Shingles, \$8.00 per sq. in place.
 Re-coat with Gravel, \$3 per sq.
 Asbestos Shingles, \$15 to \$25 per sq. laid.

Slate, from \$25.00 per sq., according to color and thickness.
 Shakes—1x25" resawn \$11.50 per sq.
 1/2x25" resawn 10.50 per sq.
 1/2x25" tapered 10.00 per sq.
 Above prices are for shakes in place.

Sheet Metal—

Windows—Metal, \$1.75 a sq. foot.
 Fire doors (average), including hardware \$1.75 per sq. ft.

Skylights—(not glazed)

Copper, 90c sq. ft. (flat).
 Galvanized iron, 30c sq. ft. (flat).
 Vented hip skylights 60c sq. ft.

Steel—Structural

\$120 ton (erected), this quotation is an average for comparatively small quantities. Light truss work higher. Plain beams and column work in large quantities \$97 to \$105 per ton.

Steel Reinforcing—

\$80.00 to \$120.00 per ton, set.

Stone—

Granite, average, \$6.50 cu. foot in place.
 Sandstone, average Blue, \$4.00, Boise, \$3.00 sq. ft. in place.
 Indiana Limestone, \$2.80 per sq. ft. in place.

Store Fronts—

Copper sash bars for store fronts, corner center and around sides, will average 75c per lineal foot.
 Note—Consult with agents.

Tile—Floor, Wainscot, etc.—(See Dealers)

Asphalt Tile—18c to 28c per sq. ft. installed.

Wall Tile—

Glazed Terra Cotta Wall Units (single faced) laid in place—approximate prices:
 2 x 6 x 12..... \$1.00 sq. ft.
 4 x 6 x 12..... 1.15 sq. ft.
 2 x 8 x 16..... 1.10 sq. ft.
 4 x 8 x 16..... 1.30 sq. ft.

Venetian Blinds—

40c per square foot and up. Installation extra.

SAN FRANCISCO BUILDING TRADES WAGE SCALES

All crafts 8 hour day (except as otherwise noted) and 5 day week. Effective as of May 1, 1940.

CRAFT	Journeyman Mechanics
Asbestos Workers	\$10.00
*Bricklayers	10.50
*Bricklayers' Hodcarriers	7.50
Cabinet Workers (outside)	10.00
Caisson Workers (Open)	8.80
Carpenters	10.00
Cement Finishers	10.00
Electricians	11.00
Elevator Constructors	12.00
Engineers (Portable and Hoisting)	10.00
Glass Workers	9.68
†Housmiths, Ornamental Iron (Shop and Outside)	10.00
Housmiths, Reinf. or Rodmen.....	10.50
Ironworkers (Bridge and Structural—Engineers)	12.80
Laborers (Building and Common)	6.50
*Lathers	9.60
Marble Setters	10.50

CRAFT	Journeyman Mechanics
Millwrights	10.00
Mosaic and Terazzo Workers	8.00
†Painters	8.75
Pile Drivers and Wharf Builders	11.20
Pile Drivers Engineers	12.80
*Plasterers	10.00
*Plasterers (Hodcarriers)	8.40
Plumbers	11.20
Roofers	9.68
Sheet Metal Workers	10.00
Sprinkler Fitters	11.00
Steamfitters	11.00
Stein Builders	10.00
Stone Cutters	9.00
*Stone Setters	10.50
Tile Setters	11.00
Welders, Structural Steel Frame on Buildings	12.80
§Dump Truck Drivers, 2 yards or less	7.00

CRAFT	Journeyman Mechanics
§Dump Truck Drivers, 3 yards	7.50
§Dump Truck Drivers, 4 yards	8.00
§Dump Truck Drivers, 5 yards	8.00
§Dump Truck Drivers, 6 yards	8.50
Truck Drivers of Concrete Mixer Trucks:	
2 yards or less	8.00
3 yards	8.57
4 and 5 yards	9.14
6 yards	9.71

EXPLANATION:
 *—6 Hour Day.
 †—7 Hour Day.
 ‡—Term "Architectural Iron" no longer used. This craft "Ornamental Ironworker."
 §—Dump Truck Drivers work 7 HOURS ON PUBLIC WORK, 8 HOURS ON PRIVATE WORK; starting time 7:30 A.M.

U. S. CORPS OF ENGINEERS AND RECLAMATION BUREAU

By JOHN C. PAGE

FOR the construction of its public works on waterways the United States has two well-established agencies, the Corps of Engineers of the United States Army and the Bureau of Reclamation of the Department of the Interior.

The history and the responsibilities of the Corps of Engineers are known. It will suffice for me to say that the Corps for decades prior to the organization of the Bureau of Reclamation was at work in its field of river and harbor improvement. The Bureau of Reclamation was organized in 1902 to build irrigation projects in the arid and semiarid western public land states. The primary objective of the program was and is to create new homes and new opportunities for American families, and new wealth for the states and the Nation. From the outset the settlers on the new lands have been required to pay for the cost of construction of the irrigation works which serve them. It has also been recognized from the first that there are general public benefits resulting from the development of the new lands and new communities.

In the Reclamation Act, now 38 years old, it was stated that the settlers should repay the cost of construction of the irrigation works—this being set up as a measure of their benefits—and that no interest should be charged on the money—this being set up as the measure of public benefits.

The Bureau of Reclamation itself has determined in advance of construction which projects are worthy. No project has been considered feasible that would place on the farmers of the new land a burden in excess of that which they could be expected to repay without undue hardship.

There has never been a variation of this rule, that the project should pay out the cost of construction, except when other considerations have entered and have been given specific recognition by the Congress.

Since its beginning the Bureau of Reclamation has built 160 dams, ranging in size and importance from small diversion structures on the one hand to Grand Coulee and Boulder Dams on the other. The water stored and diverted by these structures has been applied to desert lands to create more than 52,500 farms and to provide homes in towns and on farms for more than 900,000 people.

Wars have been fought abroad over areas of less importance to mankind than these colonies, which we have made for ourselves through the expenditure in peaceful construction of a little more than \$300,000,000, of which about \$60,000,000 already has been

returned to the Treasury through construction repayments. The significance of the reclamation projects in our national economic life can be indicated by citing one fact, that each year these farms which previously were desert turn into commercial channels something over \$100,000,000 of new wealth.

When Federal reclamation first entered the picture 38 years ago, the positions of the Bureau of Reclamation and the Corps of Engineers, generally speaking, were as far apart as the rivers in the West were long. In other words, we were working to irrigate lands on the upper reaches and the minor tributaries, while the Army engineers were working on the lower reaches and the main streams for improvement of navigation.

The progressive development of the West has brought us closer together. Now we find that we have worked downstream and they have worked upstream until in some instances our interests overlap at some midpoint of many of the great western rivers.

What were the influences which sent the Bureau of Reclamation down the rivers, and which sent the Corps of Engineers up the rivers? They are all rooted in the growth of the West, the very growth which was stimulated by the work of the Army engineers and that of the Bureau of Reclamation. Development of new communities created additional navigation needs and additional requirements for control of floods. Exhaustion of surplus waters in the smaller streams through increased irrigation, made it necessary for the cities and the farmers of the West to look to the larger rivers for their new irrigation supplies.

It was by a natural evolution process that both the Army engineers and the Bureau of Reclamation turned a few years ago to the multiple-purpose project and to consideration of broader water conservation principles to avoid wasteful duplication of effort or head-on collision. It is also proper that we should now cooperate to eliminate friction.

The approaches to problems by the two agencies are different. We came down from the mountains and they came up from the sea, but the two organizations have arranged by mutual and mutually binding agreement to attack these problems at the same time and with the same arms.

The agreement is a little broader than this statement might indicate, since the flood control studies of the Department of Agriculture also are involved, and therefore the Bureau of Agriculture Engineering is included as the third party. The National Resources Planning Board is our clearing house and has certain responsibilities for coordination of the work. Here, however, the principal interest is in cooperative methods of the investigating agencies.

An address delivered before the National Rivers and Harbors Congress at Washington, D.C.

Each of these agencies notifies the others when an investigation of a proposed multiple-purpose project is to be instituted; each advises the others if they have any direct responsibility in a project another is studying; and all exchange data and information. The investigational work is divided, each doing that part for which it is best qualified. The reports are jointly viewed while still in tentative form.

Like boatmen coming from opposite shores and meeting in the middle of a river, the Army engineers and the Bureau of Reclamation, for example, can exchange information, reach certain conclusions with respect to the river, its character, and its usefulness, without either of them having to row clear across. The boatmen could, if they had confidence in the others' judgment, meet half way and be satisfied. The Corps of Engineers and the Bureau of Reclamation are meeting half way.

Obviously this does not eliminate entirely the possibility of a divergence of views. It is not necessary nor desirable that it should. The laws and regulations governing each of us are different. The primary emphasis, for example, in the work of the Bureau of Reclamation and in that of the Corps of Engineers is on different objectives.

It gives me pleasure, however, to be able to say that in the investigations and reports on multiple-purpose projects, the Corps of Engineers and the Bureau of Reclamation have cooperated and do cooperate, and that as a result there is virtually no waste of effort. We are usually in accord on the method of developing the river, on the benefits, on the engineering features, and on the costs of the construction. The men of these agencies are trained and expert in different fields, and the people of the West and the United States are better served by mutual cooperation.

I have the greatest faith in the judgment and conclusions of the experts of the Bureau of Reclamation in calculations of the potential irrigation and power uses of a given river or of a given structure, but for navigation I believe the experts of the Corps of Engineers have the highest qualifications.

The question might be asked, "Well, then, who builds and operates the multiple-purpose project you jointly plan?"

The President recently gave the best answer when he said that the dominating interest should govern.

Let us assume, as I believe you will agree to do, that either the Corps of Engineers or the Bureau of Reclamation can build a dam and a power plant with equal efficiency, then a multiple-purpose dam of major irrigation benefits should be constructed by the Bureau of Reclamation, and a similar dam with major navigation benefits, for example, should be built by the Corps of Engineers. On the Columbia River there are two large multiple-purpose dams. Grand Coulee Dam, which will serve to irrigate 1,200,000 acres and incidentally generate a large block of power, improve navigation, and

reduce flood peaks, among other things, is being built by the Bureau of Reclamation. Bonneville Dam, farther downstream, is a major aid to navigation, and incidentally it generates a large block of power. It was constructed by the Corps of Engineers.

It has been a pleasure to work with the Corps of Engineers. I can foresee that there will likely be many more occasions for us to cooperate in the future than there have been in the past. I look forward to these opportunities with pleasant anticipation.

"THE STORY OF A BATHROOM"

Of interest to architects and the building industry in general is the display of model bathrooms, as created by Congoleum-Nairn, Inc., to be shown in San Francisco this month.

Here may be seen the outmoded bathroom of yesterday, complete in every detail with old-time fixtures, painted, plaster walls; dingy and unattractive. In contrast are two complete modernizations of this same bathroom showing Nairn linoleum for walls and floors, modern appointments, practical design, and the effective use of color—working a miracle of transformation at reasonable cost.

The old bathroom and the luxury, modernized room are exact replicas of an actual job completed under the direction of the Nairn Bureau of Decoration. The Nairn luxury bathroom was created from an actual home; the installation being made in a private residence, without basic structural changes in the original room. Similar improvements of lasting beauty and convenience are available for any bathroom. The second modernized room illustrates the same possibilities for modernization, at considerably less cost, by the use of plainer fixtures and the elimination of certain luxury appointments.

Congoleum-Nairn has produced an instructive brochure, entitled "The Story of a Bathroom," as told in Nairn linoleum; describing in detail the modern methods available for modernization of existing fine homes. Copies may be obtained from Congoleum-Nairn direct or from either of the two sponsors of the San Francisco exhibit of these model rooms.

Conklin Bros. are sponsoring the initial exhibit, which will be held on the ground floor of the Rialto Building, Mission and New Montgomery Streets, August 19 to 24. The following week, August 24 to 31, the same display will be set up in the Sterling Furniture Company store, 1049 Market Street, San Francisco.

OVER STATION KSFO

"The Architect Speaks" is the intriguing title to a series of radio broadcasts by the Northern Section of the State Association of California Architects, over KSFO, Sunday afternoons from 3:45 to 4:00 p. m. The first broadcast was given August 4 and went over big. Norman K. Blanchard, chairman of public relations, is in charge of the programs.

Industrial Building New Field for Architectural Practice

Architects are turning to industrial building design, a vast and comparatively untapped field, according to Frederick G. Frost, president of the New York Chapter of the American Institute of Architects. "Rehousing" industry, Mr. Frost declares, is rapidly becoming a major interest of both architects and engineers.

Industrial building has been too long overlooked by architects as a whole, Mr. Frost finds. With business at higher levels, new plants will be needed to replace those which have become obsolete or inadequate, he says.

"Designing for industry is now a basic sphere of architectural practice," Mr. Frost explains. "America is predominantly an industrial nation, and before the architect can hope to employ his training in the designing of homes for either the employer or the worker he must contribute his share toward 'rehousing' industry in efficient, economical structures. Only by helping industry can the architect help himself.

"The architect must be responsive to changing conditions, and must move with the progress in other fields. In his concentration on low-cost housing programs, for example, there is a tendency for the architect to ignore the fact that improperly designed industrial areas are one of the principal causes of the slum-breeding blighted zones.

"Virtually every city in the nation is currently faced with the problem of industrial centers which are eyesores and a hindrance to civic development. The architect can make a significant and valuable contribution to society by assisting in the construction of practical yet attractive buildings for industry.

"With the disappearance of prejudices long held, architects and engineers are now collaborating more closely. Both professional groups are becoming conscious of the necessity for coordinated service. This viewpoint is proving an important factor in opening the industrial field to the architect.

"The greatest savings in building are accomplished through the combined efforts of the architect and the engineer. The architect achieves economy of space and design, while the consulting engineer contributes special knowledge of such factors as structural air conditioning, heating, plumbing, and electrical work. When the technical knowledge of the engineer is incorporated by the architect into the construction plan, a building satisfactory in form and function results."

Designing for industry should be but one facet of the architect's effort to keep pace with public needs, Mr. Frost points out.

"The architect, for instance, must not be satisfied with present day slum clearance housing," he warns. Who can predict how long it will be before today's

projects will seem obsolete. While they are a tremendous improvement over the tenement, the architect must be mindful that in 25 years or more the results of the current slum clearance program may seem just as inadequate as the tenement does today.

"Sweeping changes in living conditions have taken place. The city private house has practically vanished. City dwellers prefer an apartment, where domestic services are cut to the minimum and where other problems are simplified, particularly if a home in the country is also maintained.

"The homes of the middle classes reflect new standards of beauty, comfort, and convenience. Kitchens in their equipment now resemble the butler's pantry of a former generation, with the addition of modern gas ranges and mechanical refrigerators. The bathrooms must have the tubs built in and the latest gadgets must be installed. Dining rooms are much smaller, often shrinking to simple alcoves off living rooms. Advances in heating and ventilation have contributed notably to this metamorphosis."

A NEW ART MEDIUM

Ten tons of stainless steel—the first piece of heroic sculpture ever cast in this new art medium—has arrived in New York and is being assembled for installation over the main entrance of the Associated Press Building in Rockefeller Center. Designed by Isamu Noguchi, 35-year-old Japanese-American artist and winner of the national competition for the Associated Press Building plaque, the huge panel is the largest metal bas relief ever cast.

Designed as a symbol of "News," the panel depicts in bold and simple lines the heads and torsos of five men. Four of them are working with the swift tools of modern journalism—the teletype, wirephoto, camera and telephone, while the fifth one carries the pad and pencil—trademark of all reporters.

MEDALS FOR BETTER APARTMENT HOUSES

The Apartment House Medal of the New York Chapter of the American Institute of Architects is to be awarded this year for the first time since 1933, it is announced by Frederic G. Frost, president of the Chapter. Buildings constructed between January 1, 1933 and October 1, 1938, in the five boroughs of New York City are eligible, irrespective of cost, income-group to be housed, or method of financing.

The scope of the award has been broadened to include low-rental and high-rental apartments, and housing groups. A medal will be given in each classification, providing the building is found to have sufficient merit.

A 3 DIMENSIONAL IDEA



THIS exhibit of the University of California at Treasure Island is attracting interest and speculation, according to Wm. C. Norton, executive manager of the University's mammoth space in the Hall of Science. The display is one of the large group submitted by the various departments of the University. Purely visual and not too taxing on the jaded nerves of the passing public, Mr. Norton explained, the exhibit is recognizable in its component parts—a three-dimensional representation of a policy of education. The following statement which accompanies the exhibit is printed below with the courtesy of its author, Michael Goodman, architect and member of the faculty of the School of Architecture, University of California.

. . . This one, O Socrates,
shall contemplate eternal Beauty
and disregard the kind of Beauty
which is beautiful in this time
and not in that other time. . . .
—Plato.

Architectural schools, not strictly vocational in nature, should endeavor through their teaching to reveal the Eternal Varieties rather than to follow the vogue of the day.

They must do more than impart mere facts. They must instruct in their application. And they must interpret their significance. They must strive to fuse the Analytical with the Intuitive.

The illuminated set exhibited by the School of Architecture is a three-dimensional representation of this idea through the use of recognizable symbols.

The Analytical Head contemplates Eternal Beauty in the fascinating form of the Spiral, as revealed between two definite limits

in its upward movement, knowing that to understand whither we are bound, we must first understand whence we came.

The Background responds in the same ascending movement representing Architecture from the Mastaba on the lower right, through the Medieval spires to the Megalopolis of tomorrow faintly in constructive outline along the left-hand border.

ARCHITECT'S IMPRESSIONS

(Continued from Page 7)

ning coordinates all. The same evening, I ventured to settle an argument to the effect that chronologically, they, the Telesis, are after the Cizek school, the Bauhaus, the Mars show and the Tecton; and politically somewhere between New Deal and pre-Munich. This was proven by the fact that there was an emphasis on leisure and reclining posture which became a fixed "position" in Europe before Munich.

"The montage is too preoccupied," opined a displayman; a pleasantly extraverted lawyer cheered that "some humor is done too seriously."

I had a nervous thought that the expertly suggested studies in civic planning were not compatible with, and when, the military mind will take precedent. Russian researches in war planning rendered some western ideas questionable and their originators unhappy at their failure.

With all my best wishes I hope that the Telesis group shall initiate the next step—the study of the urgent present.

By the way, are there any jobs for those of the Telesis group who are out of work?

END SHOWER TROUBLES



STAINLESS METAL PRODUCTS — OAKLAND
481 25th St. Templebar 7774

LeBRUN SCHOLARSHIP AWARD

James W. Breed, Richmond, Va., has been adjudged this year's winner in the LeBrun Scholarship competition, conducted by the New York Chapter, A.I.A. This award of \$1,400 will go for six months of travel and study of architecture in a country to be designated later by the jury.

Mr. Breed is 20 years old, a University of Pennsylvania architectural graduate, and since 1935 has been chief designer in the office of Baskerville & Son, Richmond architects.

His scheme calls for demolishing old piers adjoining New York's Battery Park, razing of the elevated railway structure on Broadway, and the widening and prolongation of that street to the water's edge.

BRUNNER SCHOLARSHIP

The award of the 1940 Arnold W. Brunner Scholarship of the New York Chapter, A.I.A., to Truman J. Mathews, of Santa Fe, New Mexico, has been announced.

The New York Chapter's Committee on Education agreed unanimously that Mathews' proposed study of the architecture of Southwestern United States was "outstanding in its promise of a valuable contribution to the study of past and present American building."

ARCHITECTS ENTERTAINED

Members of the Washington State Chapter, A.I.A., were entertained June 22 by Tacoma members of the Chapter and the Tacoma Society of Architects. Earl Dugan of Sutton, Whitney & Dugan, was chairman of the committee in charge.

Highlights of the day included a trip to the Narrows Bridge, an inspection of new buildings at Western State Hospital, Ft. Steilacoom, a tour of the historical spots nearby and a visit to McChord Field.

THEATER ADDITION

A. A. Cantin, San Francisco, architect for the State Theater Circuit, has completed plans for an addition to the State Theater in Willows, Glenn County. There will also be considerable interior and exterior remodeling work.

DRIVE-IN MARKET

Safeway Stores, Inc., have had plans prepared by Kaj Theill, structural engineer, 580 Market Street, San Francisco, for a one-story and drive-in market building on Divisadero, near Market Street, San Francisco, at a cost of \$16,000.

PERSONAL

Albert D. Taylor, landscape architect of Cleveland, Ohio, was honored recently at the 71st commencement exercises of Oregon State College, receiving the degree of Doctor of Science.



California's Hotel Beautiful

—like a country estate
yet in the heart of a throbbing
metropolitan area.
—a matchless view—
comfortable, luxuriously furnished
rooms, excellent cuisine.
—in an atmosphere of quiet
and gracious living.

Rooms, with bath, \$2.50 to \$5.00 per day.

Attractive monthly rates

HOTEL CLAREMONT • BERKELEY



The "Belle" of this Beach Is a HOUSE . . . !



Major prize-winner in a recent nationwide All-Gas Builders Competition, this modern home overlooking the sea at Lagunita, California, reflects wise planning and good taste throughout. Equipped with economical, dependable **PAYNE GRAVITY FURNACES**. ☆ There is a reliable **PAYNE**-engineered unit for any heating assignment. Wise architects throughout the West specify **PAYNEHEAT** — a name that clients know . . . and respect.



Bellows residence, Lagunita
(Laguna Beach), California.
Aubrey St. Clair, Architect;
Smith Construction Company,
Builders.

PAYNEHEAT *Payne* FURNACE & SUPPLY CO., INC.

BEVERLY HILLS • CALIFORNIA

ACOUSTI-CELOTEX

for office-quieting provides . . .

- PAINTABILITY
- PERMANENT LIGHT-REFLECTION
- HIGH EFFICIENCY

Acoustical Engineers & Contractors

WESTERN ASBESTOS CO.

Building Materials *Mechanical Specialties*
S A C R A M E N T O O A K L A N D
S A N F R A N C I S C O

POMONA TILES

FOR
Bathrooms and Kitchens
in over 60 colors

Warehouses and Display Rooms

135 Tenth St. San Francisco
629-33 North La Brea Ave. Los Angeles
6106 Roosevelt Way Seattle

POMONA TILE MFG. CO.
PLANT — POMONA, CALIF.

STRUCTURAL STEEL

For Class A Buildings,
Bridges, etc.

JUDSON PACIFIC CO.

1200 SEVENTEENTH STREET
SAN FRANCISCO

Plants: San Francisco - Oakland

A Permanent Exposition
of the newest ideas
in home planning
and equipment.



THE BUILDING MATERIAL EXHIBIT

Architeoto Bldg. • Fifth & Figueroa • Los Angeles • MU-6306

THE ARCHITECT AND U. S. PREPAREDNESS

Organization of all architects, engineers and contractors into self-reliant units to prepare for the construction of plants, shops, factories, garages, hospitals, barracks, administration buildings, airports, and workers' houses necessary for national defense was proposed by William Lescaze, architect of New York, in lectures on "Contemporary Architecture" at the Columbia University summer session.

Mobilization of the experts in the building industry is just as necessary to meet a national emergency as the drafting of specialists to build tanks, airplanes and guns, according to Mr. Lescaze, designer of the Aviation Building and the Swiss Pavilion at the New York World's Fair. What we need now, he added, are new methods of planning, new methods of design, new methods of construction, with greater speed and greater economy.

"Just as in 1939, it became quite clear and certain that the technique which had won the war of 1914-1918 would not be the technique which would win the present war, so it is becoming increasingly clear that only sheer folly or stupidity would suggest that we continue thinking and building today in the architectural terms of the nineteenth century," continued Mr. Lescaze, who is a member of the executive committee of the New York Chapter of the American Institute of Architects.

"In many places—official, political and military circles, in the minds of a large part of the public—the functions and services of architecture are not understood. Many people still hold to a nineteenth century notion. They still think that one should not bother calling an architect in unless it is a matter of looks, or decoration; unless it is a building of marble and granite. And now they say that what we need are purely useful structures, purely temporary. So really, we can not afford to have architects.

"I say we can not afford not to enlist all of our experts. We can not afford not to ensure that in each field in each area, the right people be put to do the right job. As a matter of fact, some architects have not waited until 1940 to rediscover and restate what their true functions, their real services are. During the last twenty years, these men have perfected a technique, a method, which is ready now to serve their fellow men intelligently and economically. That method for planned and efficient construction is modern architecture.

"Today, in the midst of one of the gravest world crises, one need not be a master of military tactics to acknowledge the fact that experts and more especially organizations of experts are winning this war and that the lack of experts is losing it. It has been said that 100,000 specialists could have saved France last June.

"It is clear that more than ever before our thoughts of the future imply necessarily our thinking of the present, and that in our thoughts of the present comes first of all our anxiety to contribute to national defense.

"What are we in the United States going to do about our experts, our specialists? Already much has been published about the surveys of resources and of needs undertaken. These must be done. One must begin at the beginning, find out what is on hand, estimate what goal is to be reached, and from this knowledge determine those steps which must be taken now in order to develop, increase and transform what there is into what there must be.

"I must emphasize the fact that expenditures for mass production of engines, of guns, of planes, are not things about which the special experts of the building industry could advise us. But they could on construction, on buildings."

ROOF TRUSS SERVICE

Pacific Timber Fabricators announces the establishment of a complete roof truss service, including engineering assistance, manufacture and erection.

Arch-rib truss and trussless types, ring-connected designs, cellular roof structures and laminated glued ribs will be offered and built.

The organization contains practical and technical men of experience in all departments, while equipment includes large lumber stocks, dry kilns, complete milling and woodworking machinery, fabricating unit, trucks, carriers and erection equipment.

General timber fabrication for all industrial uses is now available in prefabricated, kiln dried Douglas fir.

Pacific Timber Fabricators have executive and engineering headquarters at 4621 Tidewater Avenue, Oakland. Chas. R. Wilson, well known to the building industry, is identified with the firm which is a subsidiary of the Gorman Lumber Company and Pacific Tank and Pipe Company.

TO STUDY CORROSION PROBLEMS

Several short lengths of pipe made from different materials and arranged in series are being installed in a number of large New York office buildings for the purpose of studying corrosion problems, according to A. R. Mumford, chairman of the American Society of Heating and Ventilating Engineers Research Committee on Corrosion.

Test specimens will be located in the returns of systems supplied with steam from a central district heating source and from individual boiler plants. Action of the return condensate from the heating system on the corrosion of the several pipe materials are to be observed over a long period and will be reported by the committee at various times.

A good investment—
 is a well designed, well built structure, properly located.

Lindgren & Swinerton, Inc.
 have been building substantial buildings for over a half of a century, are still building them and will continue building them for another half a century.

Lindgren & Swinerton, Inc.
 Standard Oil Building 605 W. Olympic Boulevard
 San Francisco Los Angeles
 619 H Street 1723 Webster Street
 Sacramento Oakland

FRANK J. McCOY HOTELS

SANTA MARIA INN—Santa Maria, California • Geo. A. Thompson, Mgr.
 WORLD FAMOUS STOP-OVER, BETWEEN SAN FRANCISCO AND LOS ANGELES

EL ENCANTO HOTEL & VILLAS—Santa Barbara, California • Fred E. Pimentel, Mgr.
 AMERICA'S HOTEL BEAUTIFUL, IN A MATCHLESS SETTING ON THE RIVIERA



MR. ARCHITECT:
8 Good Reasons why you should specify FRANTZ "Over-the-top" Garage Door Equipment

Simple and easy to install, the FRANTZ "Over-the-top" set has many advantages over the pivot or counter balanced types. They include:

- 1 Low headroom. Requiring only two inches of clearance above the door header.
- 2 The door—when open—does not project beyond the header, is entirely within the building.
- 3 A reduction in ceiling height in garage construction. As much as 12 to 16 inches.
- 4 The elimination of side wall projections leaving both side walls free and clear. Does not interfere with the location of side door entrances, window opening, shelving or cupboard.
- 5 Elimination of posts, often necessary in multiple garage door installation when using pivot type sets.
- 6 No projections. The garage is entirely free as the hardware is applied on the edge of the door and door jamb.
- 7 Steel "weather-strips" a part of the equipment makes a more complete and "finished" job, makes the door weather tight.
- 8 FRANTZ "Over-the-top" door equipment needs no weights, chains, pulleys or cables.

FRANTZ *Over-the-Top* Door Equipment

Write for name of authorized distributor and installation service in your territory.

FRANTZ SALES COMPANY
 ROOM 627-420 S. SAN PEDRO ST., LOS ANGELES
 LOS ANGELES, CALIFORNIA

SAN FRANCISCO, CALIF. PORTLAND, OREGON
 OFFICE OFFICE
 200 DAVIS STREET 131 S. W. 4TH AVENUE



QUALITY AND DEPENDABLE *Service*

are the factors that influence architects and contractors when selecting lumber and mill work — Quality of merchandise — Integrity and Ability of the firm—Service in physical equipment — Experience and Personnel — All these factors contribute to a speedy and satisfactory completion of construction with minimum of time and expense.

MANUFACTURER OR DEALER IN

Douglas Fir—Redwood—Sugar and Ponderosa Pine — Plywood and Concrete Form Panels — Sash and Doors — Millwork — Insulation — Builders' Hardware.

E. K. WOOD LUMBER CO.

"Goods of the Woods" ©

LOS ANGELES • SAN FRANCISCO • OAKLAND

BAXCO

CHROMATED ZINC CHLORIDE



PRESSURE TREATED LUMBER
● **PROTECTS AGAINST DECAY**
AND TERMITE ATTACK

Specify it in your home
Available through Lumber Dealers

LOS ANGELES
601 W. 5th Street
Phone Michigan 6294

SAN FRANCISCO
333 Montgomery Street
Phone DOuglas 3883

J. H. Baxter & Co.

AGENTS FOR WEST COAST WOOD PRESERVING CO. SEATTLE, WASH.

DIEGO RIVERA AT WORK

DELIGHTED to be back in San Francisco where he did his first frescos in the United States exactly ten years ago, Diego Rivera, the Mexican muralist, started to work last month on his huge mural at the Palace of Fine Arts on Treasure Island.

A daylight studio has been specially constructed for Rivera behind a huge scaffold erected in the central section of the Fine Arts building, where he will paint his great fresco as part of the public art demonstrations sponsored by the Fine Arts Palace.

The mural will be Rivera's contribution to a closer friendship between his county and ours. The theme is a powerful plea for the Pan-American idea. "The need of a union between the American countries of the North and the South," Rivera said, "is a question of life and death. My mural will picture the fusion between the great past of the Latin American lands, as it is deeply rooted in the soil, and the high mechanical developments of the United States today."

The design of Rivera's fresco will balance the old pyramids of Mexico against streamlined skyscraper cities of the United States, including a vista of San Francisco. Likewise, the legendary serpent of the Indian mythology will be contrasted with a sinuous belt conveyor. In the center will be a dominant figure, half machine, half Aztec sculpture. It will symbolize the great mechanical and technological achievements of 20th century America, together with the mythological Goddess of Life who represents the vigor and fertility of the ancient Mexican civilization.

After its completion, the mural, which is twenty-two feet high and forty feet wide, will find its permanent place in the library of the new Junior College of San Francisco. The mural will be the center section of a wall decoration of 250 feet which Rivera hopes to finish after he has painted the central part at the Exposition.

SCHOLARSHIP WINNERS DISAPPOINTED

George Kotchik and Rollin Boles, architectural students of Portland who were granted a European travel scholarship last spring by the Oregon Chapter, A. I. A. were forced to cut short their scholarship tour by war conditions across the Atlantic Ocean.

RETAIN FOUNDER'S NAME

Reorganization of the architectural firm of Edwin J. Ivey, Inc., 1314 E. John St., Seattle, has been effected under the name of the founder, the late Edwin John Ivey. Miss Elizabeth Ayer is president of the new corporation and Harry Broman is secretary.

James H. Garrett, architect, announces the removal of his offices to 672 South Lafayette Place, Los Angeles.



You don't have to bring your business to us to enjoy the facilities of this old, metropolitan bank. Rather, we take our services to you—by mail—no matter where your business is located. Our Bank-by-Mail Service will save your time; perhaps money, too. Why not open an account today, by mail?

CROCKER FIRST NATIONAL BANK
OF SAN FRANCISCO

California's Oldest National Bank
Member Federal Deposit Insurance Corporation

Clinton Construction Co.
of California
General Contractors

923 Folsom Street
San Francisco
SUtter 3440

JOHN CASSARETTO

—Since 1886—And Still Active—

Building Materials

READY MIX CONCRETE
ROCK - SAND - GRAVEL - LIME
CEMENT - PLASTER - MORTAR
METAL LATH - WOOD LATH
STUCCO - WIRE NETTING

Service Unexcelled

Bunkers
Sixth and Channel, San Francisco
Phones: GARfield 3176, GARfield 3177

APPRENTICE TRAINING

By ARCHIE J. MOONEY

In 1939, under provisions of newly enacted State legislation approved by Governor Olson, California undertook a broad program of preparing the young people of the State for their place in the present-day industrial set-up. Today more than 4,500 youths of California are "earning while learning" in the State's apprentice training program. They are working under 80 agreements, made within the industries by joint committees of employers and employees, and a total of 1,300 have been indentured. Eventually it is expected to have 500 such agreements, bringing the advantages of proper trade training and regulated employment to many more thousands of young people of our State.

The program recognizes these facts:

That in certain trades skilled workmen are disappearing.

That the prospective apprentice, a young man or young woman anxious to study a life-work, has a right to expect a well ordered and properly balanced program of education and training; protection as a learner rather than as a laborer, fair wages and impartial supervision by a public agency.

That the employer wants an adequate supply of competent workmen; assurance that the apprentice will remain with him for the duration of his apprenticeship; opportunity to participate in selection of learners and protection against chiselers within the industry.

That labor wants protection against glutting of the market by unskilled and cheap workers, and an active part in governing the number of learners coming into a trade and adequate protection for the apprentices.

That the public wants to get its money's worth whenever a skilled mechanic is employed, and most important of all, it wants a progressive program dedicated to and established for the advancement and best interests of our future citizenry.

Federal-State cooperation for a bona fide apprentice program was promulgated by President Roosevelt in 1934 in connection with NIRA. The program was revived with passage

NEW JOBS AHEAD for architects

People are writing Kraftile by the hundreds for new ideas in kitchen and bathroom planning. Many of these prospects have commissioned no architect as yet. If you are interested in establishing contacts with such prospective builders, write for information on Kraftile's "New Jobs Ahead" plan. Address C. W. Kraft, Kraftile Kilns, Niles, Calif.

VAUGHN - G. E. WITT Co.

Manufacturers and Distributors

Pump Governors	Oil Heaters
Safety Pump Governors	Relief Valves
Automatic Gas Regulating Valves	Oil Burner Governors
Gas Burning Equipment	Oil Burners
Vacuum Pump Governors	Oil Pumping Sets
Vacuum Regulating Valves	Oil Valves
Continuous Flow Steam Traps	Oil and Steam Strainers
Thermostats	Duplex Oil Pumps
Reducing Valves	Rotary Oil Pumps
	Boiler Feed Pumps
	Water Heaters
	Boiler Feed-Water Regulators

4224-28 Hollis St., Emeryville, Oakland

VERMONT MARBLE COMPANY

Producers and Finishers of

Domestic and Imported Marbles

San Francisco
Los Angeles
and
Tacoma, Wash.



WOMEN go into raptures over this new Wesix "Perfect Thirty-Six" electric bathroom heater. Its instant, head-to-foot heat, they exclaim, "is simply marvelous!" You will like it because it *fits perfectly into 42-inch wainscots*. For details write Dept. 206, Wesix Electric Heater Co., 390-1st St., San Francisco.

WESIX

*World's Largest Manufacturers of
Major Electric Heaters*

**DINWIDDIE
CONSTRUCTION
COMPANY**

•

BUILDERS

•

CROCKER BUILDING
SAN FRANCISCO

HIGH GRADE MILLWORK
AND INTERIOR FINISH
SASH AND DOORS

**LANNOM BROS.
MFG. CO.**

FIFTH AND MAGNOLIA STREETS
OAKLAND, CALIFORNIA
Telephone: TEmpleber 3663

of the Fitzgerald Act in 1937, making the Federal Apprenticeship Committee a permanent part of the Department of Labor and authorized to cooperate with State governments.

The California Shelley-Maloney Apprentice Labor Standards Act was passed and signed by Governor Olson in 1939. It repealed statutes that had been on the books since 1860 and which were modeled after the old English laws.

Activities are supervised by the California Apprenticeship Council. The director of the Department of Industrial Relations is Administrator of Apprenticeship.

Joint apprenticeship committees are operating in the following trades: Carpentry, mill and cabinet, floor laying, electrical, plumbing, steam fitting, painting and decorating, brick laying, tile laying, lathing, plastering and aircraft.

Labor standards are worked out through local and state joint apprenticeship committees upon which there is equal representation from employer and employee organizations with a representative of the School Department acting in an advisory capacity.

The initial impulse to participate in the program comes from within the industry to the Administrator. Either employer or employee group may take the initiative, and it then is asked to contact the other group. Each group sends the Administrator the names and addresses of its representatives.

In so far as possible, industry is given the widest possible range of self-government—this means to both employers and employees.

When the selections are approved by the Administrator, they constitute a bona fide apprentice training committee under the law. A representative of the schools then is invited to participate.

The joint committee negotiates wages, hours and working conditions for apprentices to be brought in. The agreement must be ratified by the Administrator, and it then is incorporated in the laws of the State.

The State is cooperating in every way with the public schools, trade

**MULLEN MFG.
COMPANY**

**BANK, STORE AND OFFICE
FIXTURES—CABINET WORK
OF GUARANTEED QUALITY
CHURCH SEATING**

Office and Factory:
60-80 RAUSCH ST., Bet. 7th and 8th Sts.
San Francisco
Telephone UNDERhill 5815

**G. P. W.
JENSEN & SON**

Building Construction

320 Market Street, San Francisco
Phone: GARfield 2444

Smith

Lumber Company

WHOLESALE - JOBBING - RETAIL
FACTORY AND BUILDING LUMBER
PLYWOODS - ROOFING

DISTRIBUTING YARDS

San Francisco	Oakland
•	19th Ave. &
4th & Channel	Estuary
MARKet 0103	FRuitvale 3174

YOUR INQUIRIES SOLICITED

SISALKRAFT

REG. U. S. PAT. OFF.

**"More than a
building paper"**

THE SISALKRAFT CO.

205 West Wacker Drive
(Canal Station) Chicago, Ill.
55 New Montgomery Street
San Francisco, Calif.

ABBOT A. HANKS, INC.
Engineers & Chemists

INSPECTING — TESTING — CONSULTING
CONCRETE • STEEL • MATERIALS
CHEMICAL AND TESTING
LABORATORIES
• RESEARCH AND INVESTIGATION •

TESTS OF STRUCTURAL MATERIALS
DESIGN OF CONCRETE MIXES
SHOP AND ERECTION INSPECTION OF
STRUCTURES AND EQUIPMENT
INVESTIGATION OF STRUCTURES
AND MATERIALS
TESTS AND INVESTIGATION OF
FOUNDATION SOILS
FIRE RESISTANCE AND INSULATION
TESTS

624 Sacramento Street, San Francisco

**JOSEPH MUSTO
SONS-KEENAN
CO.**

**MARBLE
and ABRASIVES**

ONYX

535 NORTH POINT STREET
SAN FRANCISCO
1801 S. SOTO STREET
LOS ANGELES



PRODUCTS

VAN ARSDALE-HARRIS CO.
ENGINEERS & CONTRACTORS

ACOUSTICAL TREATMENT
INSULATION
SOUND CONTROL

Fifth and Brannan Streets
San Francisco, Calif.

Telephone GArlfield 3600

Division

VAN ARSDALE-HARRIS
LUMBER CO., INC.

**FINE WATER COLORS
AND PAPERS
FOR ARCHITECTURAL
RENDERINGS**

**H. S. CROCKER
COMPANY, Inc.**

720 MISSION STREET
MARKET STREET AT SECOND
SAN FRANCISCO

unions and employers, the State Department of Education and the State Department of Employment. The apprenticeship program is not intended as an agency for employment and does not function to secure jobs.

Standards provide that all apprentices must attend schools at least 144 hours a year.

The Apprenticeship Council has no jurisdiction over the educational features of an apprentice training program, but without those features the program could not accomplish its full purpose. Education is equally as important as labor standards, and a full course of apprentice training must have both.

The California Apprenticeship Council, the governing body of the program, sets up minimums and maximums of wages and hours and establishes standards for working conditions, the transfer of apprentices from the jobs and, if necessary, from employer to employer.

In the trades in which committees are functioning on a statewide basis, these committees determine the hours necessary for an apprentice to learn the particular trade, the various processes that make up the full complement of the trade, the percentage of the journeymen's wages the apprentice should receive in each step-up period, and any other matters that should or could be of statewide significance without interfering with the autonomy of the local joint committees.

One of the very important functions of the committees is the regulation of the number of apprentices—that is, the number of young people who are to be trained to depend on a given trade for their support.

Standard agreements provide for a ratio between the number of journeymen employed and the number of learners to be trained.

It is the duty of the committees also, to ascertain the actual needs of the industries, and as far as is possible, to forecast future needs with a view to curtailing over- and under-supplies of craftsmen.

"The term 'apprentice' . . . means a person at least 16 years of age who

SANI-TOIL

New ODORLESS toilet ventilator. Through a direct system of forced ventilation, all repugnant odors are quickly dispelled into the open air—outside the building.

Completely Automatic. It operates only when in use, or can be run continuously. Entirely noiseless. Motor and fan are a complete unit, and can be located anywhere for easy access.

Architects—write for details and cost figures.

*Territories open
for dealers*

Sani-Toil
SALES CORPORATION

576 Stockton Avenue, San Jose, Calif.



**Pacific
Manufacturing
Company**

High Class Interior Finish
Quality Millwork

142 Sansome St. 6820 McKintley Ave.
San Francisco Los Angeles
GARfield 7755 THornwall 4196

1315 Seventh Street, Oakland
GLEncourt 7850

THE MOST COMPLETE LINE
OF STEELS AND STEEL BUILD-
ING MATERIALS MADE BY A
SINGLE PRODUCER



See Sweet's Catalog File or write us for
full information.

Republic Steel Corporation
General Offices: Cleveland, Ohio

Denver, Colo. . . . Continental Oil Bldg.
Los Angeles, Calif. . . . Edison Bldg.
Salt Lake City, Utah . . . Walker Bank Bldg.
San Francisco, Calif. . . . Rialto Bldg.
Seattle, Wash. . . . White-Henry-Stuart Bldg.



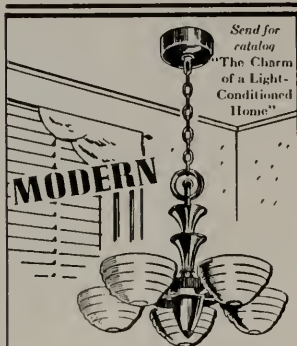

No furnishings you can buy for so little will give you as much long term satisfaction as a new Lightolier fixture.

**INCANDESCENT
SUPPLY COMPANY**
726 MISSION STREET, SAN FRANCISCO

Phone GARfield 1164

Hunter & Hudson

Consulting Engineers
DESIGNERS OF HEATING
AIR CONDITIONING
VENTILATING AND WIRING
SYSTEMS, MECHANICAL
AND ELECTRICAL EQUIP-
MENT OF BUILDINGS

41 SUTTER STREET
ROOM 710
San Francisco California

Robert W. Hunt Company

ENGINEERS

Inspection • Tests • Consultation
Schools and Other Structures
Are Built as Designed

*When Construction Materials are
Inspected at point of Manufacture
and during Erection by*

ROBERT W. HUNT COMPANY

*Cement, Concrete, Chemical, Metallurgical,
X-Ray and Physical Laboratories*

Chicago - New York - Pittsburgh
Los Angeles - All Large Cities
San Francisco, 251 Kearny Street

has entered into a written agreement . . . with an employer or his agent, an association of employers, or an organization of employees, or a joint committee representing both . . . for reasonably continuous employment for such person and for his participation in an approved program of training through employment and through education in related and supplemental subjects."

The apprentice who meets the requirements of his training is given a certificate that is a self-sufficient guarantee to any employer anywhere that the bearer is a competent workman in his trade.

THE HOUSE OF IDEAS

The House of Ideas is the name of a new model home now open for public inspection at Rockefeller Center, New York.

Jointly sponsored by the California Redwood Association and Colliers' Magazine, the House of Ideas is built on the terrace of the International Building, adjoining the Rockefeller Home Center offices. It is designed by Edward D. Stone, architect, and is constructed of natural finished redwood.

Plans are being made for visitors at the rate of 200,000 per month as Fair going crowds visit the display.

Of particular interest to lumber dealers is the fact that little or no use of specially detailed materials has been made in the house. All are standard redwood yard items almost universally carried in stock.

The estimated cost of reproducing the house in a suburban locality is \$7,500.

LARGE SCALE HOUSING

A new advanced course in housing and site planning of large scale projects will be offered this fall by the New York University School of Architecture and Allied Arts to meet the needs of advanced design students, architects, engineers and draftsmen, according to Dean E. Raymond Bos-sange.

William F. R. Ballard, chief architect of the Queensbridge Housing Project and associated with many

INCLUDE TREES IN YOUR PLANS

DAVEY, ORIGINATOR OF TREE SUR-
GERY, OFFERS FREE INSPECTION
AND ESTIMATE.



SAN FRANCISCO
Russ Bldg. SUtter 3377

FRESNO
Mattei Bldg.

LOS ANGELES
Story Bldg. TUCKer 1929

Local phones in: Pasadena, Palo Alto,
Oakland, San Rafael, San Mateo

SKILL - KNOWLEDGE -
RESPONSIBILITY

THE TORMEY COMPANY

GENERAL PAINTERS
AND DECORATORS

Phone UNDERhill 1913

563 FULTON STREET
San Francisco

Donovan Automatic Awning Type Windows

Give 100% natural ventilation
and day-lighting control

UNIVERSAL WINDOW
COMPANY

Berkeley, California

other large scale projects, will conduct the program with the assistance of Carol Aronovici, also widely known in the field of community housing and planning.

Lectures will cover site selection and planning, economic factors in housing, distribution of space for public and private use, essentials of tenant selection, legal restrictions and standards, and other factors in large scale planning.

The program, in addition to the lectures, will include design assignments in which the students will be required to develop a housing project in harmony with social, economic and aesthetic considerations. Scholars who have had no technical training will be permitted to collaborate with trained students. Technical experts of engineering, construction and management will be on hand to consult with the students.

ARTISTS WIN PRIZES

Choosing from the comprehensive exhibit of contemporary California art now on display in the Fine Arts Palace on Treasure Island, a jury of art experts have recently selected prize winning paintings.

The jury was composed of Thomas Carr Howe, Jr., director of the California Palace of the Legion of Honor; Reginald Poland, director of the San Diego Fine Arts Gallery; Dr. Grace L. McCann Morley, director of the San Francisco Museum of Art; and Margit Varga, art editor of Life Magazine. Five oil paintings, five watercolors and five prints were awarded prizes totaling \$1,500.

In the group of oil paintings, the first prize of \$400 was given to Phil Dike of Los Angeles for his night landscape, "Smudging." Tom Craig, also of Los Angeles, won the second prize of \$200 with his sensitive, subtly painted "Savannah Waterfront." The third prize for oil painting (\$100) went to Eugene Ivanoff of San Francisco for his dynamic, intense picture "After Grapes of Wrath."

The first honorable mention, carrying a cash prize of \$50, was awarded to John Langley Howard of San Francisco for "Down by the Gas

ILLUSTRATIONS OF SUPERIOR CONSTRUCTION



THE Austin Company. Engineers and Builders of the
 Famous National Broadcasting Studios in Radio City, Hollywood, specified and used Summerbell Trusses on all six studios. They obtained many advantages, a few of which are: A Fair Price, Correct Design, Cooperative service, Experienced Construction, and lower fire insurance rates on the entire building and its contents.

SUMMERBELL ROOF STRUCTURES
 LOS ANGELES • OAKLAND • PHOENIX
 TIMBER STRUCTURES, INC., PORTLAND

ROOFS OF WOOD—BUILT TO ENDURE



HERRICK IRON WORKS

STRUCTURAL STEEL
 REINFORCING STEEL

18TH AND CAMPBELL STS.
 OAKLAND, CALIF.
 Phone GLencourt 1747

Independent Iron Works

Structural Steel
 Ornamental Iron
 Steel Service Stations
 Steel Tanks
 Standard Steel Mill Buildings
 Bridges

821 Pine Street Oakland

FORDERER CORNICHE WORKS

Manufacturers of

Hollow Metal Products
 Interior Metal Trim
 Elevator Fronts and Cabs
 Metal Plaster Accessories
 Sanitary Metal Base
 Metal Cabinets
 Flat and Roll Metal Screens
 Commercial Refrigerators

269 POTRERO AVE.
 San Francisco, Calif.
 HEMlock 4100

"AMERICAN MARSH" Redi-Vac Vacuum Heating Pump

Send for Bulletin 441



SIMONDS MACHINERY CO.
 San Francisco Los Angeles
 816 Folsom St. 455 East Fourth St.

ANDERSON & RINGROSE

General Contractors

320 Market Street, San Francisco
Phone GARfield 2245

BASALITE

CAMBERED
SHINGLE TILE

PERMANENT • FIREPROOF
STORMSAFE • COLORFUL
ECONOMICAL

Manufactured by

Basalt Rock Co., Inc.

NAPA, CALIFORNIA

Melrose Lumber & Supply Co.

LUMBER AND
MILL WORK

46th Ave. and E. 12th St.
Oakland

Phone: FRUITvale 0251



MERCURY PRESS

We Print
The ARCHITECT and
ENGINEER

"A Thing of Beauty
Is a Joy Forever"

942 HOWARD STREET
SAN FRANCISCO

Tanks," while William A. Gaw of Berkeley received the second honorable mention (\$50) for his still life, "Dahlia's."

In the watercolor group, Phil Paradise of Los Angeles won the first prize of \$200 for his "Orchard." Second prize of \$100 went to Victor De Wilde, San Francisco, for "In March." "Celebrating Independence," by Leo Blair of Los Angeles, was awarded third prize of \$75. The two honorable mentions (carrying \$30 cash prizes) for watercolors were awarded to Dong Kingman and Harley Melzian, both of San Francisco, for their "Riverboat" and "Hallowe'en at Sleepy Eye," respectively.

Victor Arnautoff of San Francisco carried off the first prize (\$100) in the group of prints with his lithograph, "Cotton Pickers." The second prize of \$75 went to Mallette Dean, San Francisco, for his linoleum cut, "Richardson's Bay." The San Francisco artist, E. Holland Johnson, won the third prize (\$50) with a dry point, "Stone Steps." The two honorable mentions, of \$20 each, went to Julius Pommer, San Francisco, for his aquatint, "B Street, Virginia City;" and to Charles Surendorf of San Francisco for his line engraving, "Tahitian Fishermen."

STEADILY IMPROVING

The Editor:

The writer wishes to express his appreciation of your magazine. Although he has been a constant reader of Architect and Engineer for several years, it was not until recently that the privileged receipt of personal copies was accorded him.

The subject matter has been steadily improving in presentation and interest. For all this, many thanks.

Sincerely,

ROBERT J. EVANS, Architect.
Berkeley, July 30, 1940.

STOCKTON ARCHITECT MOVES

Joseph Losekann, architect, announces the removal of his office in Stockton from Madison Street to 31 South Sutter Street. Building literature and samples should go to Mr. Losekann's new address.

ALLEN STRUCTURAL PORCELAIN PANS

The ultimate in porcelain enamel construction.

Details and specifications
now available.

FRANK ALLEN

Ferro-Porcelain Construction
320 MARKET ST., SAN FRANCISCO

ALADDIN Heating Corp.

Specializing in
QUALITY HEATING
EQUIPMENT

2222 San Pablo Avenue
Oakland
TWInoaks 1022

Golden Gate Atlas

TRANSIT
MIX CONCRETE
AND MORTAR

PACIFIC COAST
AGGREGATES, Inc.

16th and Harrison Streets
85 Second Street San Francisco

CIVIL SERVICE FOR ENGINEERS

The U. S. Civil Service Commission will hold competitive examinations August 29 and September 3 for civil engineer, with salaries ranging from \$2,600 to \$4,000 a year, subject to a deduction of 3.5 per cent toward a retirement annuity. Applications may be obtained at the U. S. Civil Service Office, Federal Office Building, San Francisco.

ARCHITECT
AND
ENGINEER

SEPTEMBER, 1940

ANNUAL CONVENTION STATE ASSOCIATION OF CALIFORNIA ARCHITECTS OCTOBER 10-12



DOORS OF ALUMINUM WITH THE DURABLE ALUMILITE FINISH

AS A PIONEER in the fabrication and finishing of non-ferrous metals for architectural purposes, The Kawneer Company offers unrivaled ability to produce fine doors and entrances, windows and store fronts, in both standard and special types.

You benefit, for instance, because Kawneer maintains in its own plant at Niles, Michigan, adequate equipment for producing the beautiful and durable Alumilite Finish — the most complete and modern equipment of this sort in the building industry.

*The Alumilite Finish, an electro-chemical process, beautifies and hardens the surface of the aluminum itself. It assures greater protec-

tion against abrasion and atmospheric conditions. The original beauty of doors, windows and store fronts of aluminum can easily be maintained — important developments such as the new K. Z. S. Aluminum Facing are made possible.

See SWEET'S or write THE KAWNEER COMPANY, BERKELEY, CALIF., for data on any Kawneer product in which you are interested.

Illustration shows entrance for U. C. Press Building, Berkeley, California, Masten & Hurd, Architects. Standard doors with stiles on 1-1/2" wide are now available — for maximum visibility.

KAWNEER MAINTAINS THE MOST COMPLETE EQUIPMENT IN THE BUILDING INDUSTRY

RUNNING FIRE

by
MARK DANIELS, A.I.A.

The Glorious Profession

I knocked at the door and stepped in without announcement. Jerry was pounding away at his typewriter. "Hard at the old specs, Jerry?" I asked. "What specs?" he said. "Some new hotel, skyscraper, or maybe a U. S. H. A. How should I know," I replied.

"Oh, I'd forgotten." Jerry said. "That's Tim Pflueger stuff. What do you think of this?" and he read: "Down the dusty corridors of memory Sally pursued the fading visions of her past." "Pretty hot, I think."

"That should come in the section of General Conditions, shouldn't it?" I ventured. He seemed a little screwy, to say the least.

"Well I sold one to 'Puking Pulp' last week that wasn't half so good. Got \$30 for it."

"But Jerry," I said, "I have seen some of the most beautiful plans and read some of the most perfect specifications turned out in this country in years, out of your office. Have you abandoned your profession?"

"What profession?" said Jerry.

★ ★ ★

Compromise

Some years ago this column ran an item yeapt "No Compromise." That was a tribute to Honore de Balzac. I believe, and not an admission of irrefutable principle. Balzac would not compromise with his ideals in the matter of individual taste. He waited until he could afford the exact chair he wanted and sat on a box until he got it.

All that is very admirable and worthy in the individual instance. But, if one's ideal is mass progress and if such progress is attainable only through compromise, then compromise should be made. Perhaps a half loaf is not better than none, but I can see no way to help the great mass of people of the world except through continual compromise between what they should have and what they want.

The type of architect that gives his clients just what they want saves himself the double labor of study and search for the best solution and the time necessary to teach clients something about good design. He may, and often does,

give them a well built structure but it usually is a sorry thing to look at.

There are other architects who insist upon doing things only as they see them. It must be their way or no way. Perhaps they are right, but they often wind up in the no way group. We all know them, if for no other reason than by the number of projects that are abandoned.

It seems to me that a little compromise is the sane way out. It is better to accomplish a little advance each time than to drop all work because it is not exactly what we want.

★ ★ ★

The Search

"A little of the ambrosia," I called to the O'Brien. "That is not literally correct," interrupted the voice of the Little Man at my left, continuing, as I set down my old fashion, "Ambrosia was the food of the gods; nectar was their drink. Both their food and their drink were said to make them immortal, but subsequent developments point to the nectar as the life benefactor. On the sun bathed slopes of Olympus they produced the nectar of immortality and for thousands of years since, man has been searching for that mountain side. He has thought at times that he has found it. At Fecamp in Normandy the followers of St. Benedict of Nursia thought they had found it. The Carthusian Monks believed the distilled nettles from the warm slopes of the Alps defined the spot. The terraced banks of the Rhine, the valley of the Moselle came in for their turn, but no one found that mountain side. They couldn't find it because they didn't look in Kentucky."

I looked down for my old fashion. I am sure the Little Man was satisfied. It was nectar from Kentucky.

★ ★ ★

Independence

There is great need for the independent thinker, the columnist. There is very particular need for one who will collate and interpret the great mass of news items that now fill page after page of the dailies to an extent that precludes the possibility of digesting, or even reading them in less than an eight

hour day.

But there is a type of columnist who has wormed into the group of independent thinkers. His only merit is that by reading his paragraphs you can learn exactly what his publisher thinks.

★ ★ ★

Launched

The State Association of California Architects is at last on its way with a radio presentation of the sad situation of architects in Northern California. As was pointed out in a recent issue, Los Angeles has been broadcasting to the people of the South the importance of architects and architecture. On Sunday the 4th of August a program was started over KSFO at 3:45 p.m. under the title of "The Architect Speaks."

I hope that this program may be more generally received than are articles that contain illustrations, for generally the architect searches through the magazine for a picture of his own structure and tosses the journal away minus a page or two, after finding it. Of course they can turn off the radio but it is doubtful if anyone would do so after hearing the start of this program.

The first issue of "The Architect Speaks," was one of the best of its kind I have heard. Obviously the effort was largely to take mystery out of the profession of the architect. It was a straightforward, well illustrated talk based largely upon the idea of hearing a woman thinking aloud over her architectural problems. If you didn't hear Sunday's first program, don't fail to listen in on the first Sunday you can at 3:45 p.m. over KSFO. If you did hear it, my admonitions are unnecessary because you will listen anyhow.

★ ★ ★

Recession

I sipped the Old Fashioned in a tired way. There was a lot of noise and bustle. One man was arguing whether or not the District of Columbia was one of the forty-eight states, and The Little Man patted me sorrowfully on the shoulder. "A depression," he remarked, "is a cumulative reaction to business retrogressions and regressions."

I looked startled and The Little

(Turn to Page 64)

ARCHITECT AND ENGINEER

VOLUME 142

SEPTEMBER, 1940

NUMBER 3

ARTICLES

JUNIOR SCORES CHAPTER MEETINGS	11
RECENT WORK OF WILLIAM H. HARRISON, A. I. A. Paul R. Hunter	19
LOU HENRY HOOVER SCHOOL, WHITTIER	24
MOST IMPORTANT RECENT DEVELOPMENT IN REINFORCED CONCRETE J. E. Jellick	41
MORE ABOUT FLUORESCENT LIGHTING	45
THE ARCHITECT SPEAKS Harris C. Allen, A. I. A.	47
PRESIDENT REPORTS GOOD YEAR FOR STATE ASSOCIATION Ernest E. Weihe	52

PLATES

LEHIGH AIRPORTS COMPETITION	33-35
STAGE IN KINDERGARTEN OF LOU HENRY HOOVER SCHOOL, WHITTIER (with detail)	36-37
RESIDENCE OF DR. AND MRS. HARRY J. SCHOTT, BRENTWOOD HEIGHTS, LOS ANGELES (with fireplace detail)	38-39

ARCHITECTURE

RECENT WORK OF WILLIAM H. HARRISON, A. I. A.	16-40
--	-------

ENGINEERING

LABORATORY SPECIMENS OF RECENT DEVELOPMENTS IN CONCRETE	41-44
CONCRETE GRID FORM HOUSE	51

NEXT MONTH

ARCHITECTURAL TRENDS IN PORTLAND, OREGON Roi L. Morin, Guest Editor	
--	--

(Index to Advertisements—Page 72)

HONORARY EDITORS

Arthur Brown, Jr., Timothy L. Pfeueger, Lewis P. Hobart, John J. Donovan, Will G. Corlett, Frederick H. Meyer, Thos. J. Kent, Gordon B. Kaufmann, Ben. H. O'Connor, Michael Goodman, Harry Michelsen.

REGULAR CONTRIBUTING EDITORS

Harris C. Allen, Harry Sanders, Paul R. Hunter, Glenn Stanton, Roi L. Morin, Chas. H. Alden.

EDITOR, FRED'K. W. JONES; ASSISTANT EDITOR, E. N. KIERULFF; CONSULTING AND CONTRIBUTING EDITOR, MARK DANIELS; ADVERTISING MANAGER, R. W. WALKER.

ARCHITECT AND ENGINEER is published on the 15th of the month by The Architect and Engineer, Inc., 68 Post Street, San Francisco. President, K. P. Kierulff; Vice President, Fred'k. W. Jones; Secretary and Business Manager, L. B. Penhorwood.

Entered as second class matter, November 2, 1905, at the Post Office in San Francisco, California, under the Act of March 3, 1897. Subscriptions, United States and Pan America, \$3.00 a year; foreign countries \$5.00 a year; single copy \$.50.

Los Angeles office: Western Pacific Building, Wentworth Green, Manager.

ARCHITECTS REPORTS are published daily from this office and are sponsored by the Northern Section, State Association of California Architects; Vernon S. Yallop, Mgr.

Owners Wanting Safe Home Investment

WILL THANK YOU FOR SPECIFYING
CELOTEX GUARANTEED INSULATION



W. C. Tackett, Inc., Builders, Chicago Herman Brunt, Architect

Celotex Vapor-seal Sheathing and Lath Delights Owners With Lifetime Insulation, Fuel Savings, Low Net Cost

MOST home owners have a fairly definite idea of *what they want*. Few of them are familiar with all the features *they should have* in a new home—to give it needed structural strength and year-round comfort—to make it economical to heat—to make it easily salable in case resale becomes necessary, *thus protecting their investment*.

They look to you for guidance on the points which are unfamiliar to them. For instance, most owners today know they want insulation. But in many cases it is

left to you to recommend *the most serviceable, the most economical* insulation for sidewalls and top-floor ceilings.

By specifying Celotex Guaranteed Insulation, you will earn their everlasting thanks. Because Celotex Vapor-seal Sheathing and Vapor-seal Lath provide needed structural strength and continuous fuel savings—because these products are permanently protected against termites and dry rot by the exclusive, patented Ferox Process—and because they are *guaranteed in writing for the life of the*

*building!** Yet, with all these advantages, Celotex Guaranteed Insulation is *economical*—because it replaces other needed materials!

CELOTEX SPURS BUILDING

Celotex national advertising now tells your clients: "NOW IS THE TIME TO BUILD! It is a hedge against inflation • Financing is easy • Interest rates are low • Material costs are low • Labor is plentiful!"

*When issued, applies only within Continental United States

THE CELOTEX CORPORATION
919 N. Michigan Ave., Chicago, Ill.

AE 9-40

Please send complete information about Celotex Guaranteed Insulation.

Name

Address

City

County State

CELOTEX

REG. U. S. PAT. OFF.

BUILDING PRODUCTS

INSULATING SHEATHING, LATH, INTERIOR FINISHES
ASPHALT SHINGLES, SIDING, ROLL ROOFING
HARD BOARDS • ROCK WOOL BLANKETS, BATTS
GYPSUM PLASTERS, LATH, WALL BOARDS

Sales Distributors Throughout the World

CALIFORNIA ARCHITECTS CONVENE AT DEL MONTE NEXT MONTH

A RECORD breaking attendance is expected at the twelfth annual convention of the State Association of California Architects at Del Monte October 10-12. A varied program of interesting topics has been arranged, coupled with entertainment galore. The tentative program follows:

Thursday, October 10th:

9:30 A.M.—Joint meeting of the State Boards of Architectural Examiners and Executive Board.

12:30 P.M.—Luncheon—Registration.

2:00 P.M.—First Business Session

- (a) Old Business, Committee Reports
- (b) Public Relations—A detailed report of the activities of this Committee
- (c) Telesis Group Report by a member of the Group as to its program and activities.

7:00 P.M.—Dinner—no program.

8:00 P.M.—Special Session which will be conducted by the Southern Section. At this time they will present a record of its activities as well as an interesting program covering their findings and accomplishments in the professional field.

Friday, October 11th:

9:30 A.M.—Second Business Session

- (a) Professional Relations—Committee Report with a short paper on background of the profession with outside groups—followed by discussion.
- (b) Legislation — Committee Report with a short paper on the history in the State of past and present legislation effecting the profession—followed by discussion.
- (c) Material Standards—A short paper on this subject proposing a basis on which the profession could build in order to better obtain positive data on building materials—followed by discussion.
- (d) Federal Housing Administration—a short paper on the Act and the resultant Administration, giving its History, Policy and other pertinent matters of interest—followed by discussion.

1:00 P.M.—Luncheon—no program.

2:00 P.M.—Third Business Session

- (a) Earthquakes—a paper on this subject by a great speaker distinguished for his scientific knowledge in this field with a short paper on the history of all legislation

effecting the profession as a result of this subject—to be followed by discussion.

- (b) United States Housing Administration—(1) A paper on the Act and the workings, power and program of the Administration. (2) Planning—A paper on the planning requirements and Standards of the Administration as it effects local authorities and architects retained by them. (3) Management—A paper setting forth the problems of management of projects planned and built under the Act and already occupied. (4) Defense Housing—A paper on this, the newest program of the Administration setting forth the workings of this program and its effect on the profession. (5) Discussion of the U. S. Housing Administration.

- (c) National Defense. A paper on this complicated subject setting forth the local programs of the Army and Navy with emphasis on that phase of dealing with private practice—followed by discussion.

7:30 P.M.—Cocktail Party—Delegates and wives.

9:00 P.M.—Dinner Dance—Delegates and wives and guests. For this we have a Private Banquet room that will at the end of our entertainment program become a part of the famed Bali Room where the regular Hotel dinner dance will be in progress. We will be entertained by the Hotel group as well as by our own. Wear your dinner jacket, sport clothes or what you will.

Saturday, October 12th:

9:30 A.M.—Fourth Business Session

Unfinished Business
Resolutions
Installation of Officers
Adjournment.

Saturday afternoon—Golf Tournament sponsored by the Producers Council on Del Monte's famed course.

Saturday Barbecue—

1:00 P.M.—For those who won't be golfing and for the wives of those who do, we are planning an old fashioned Spanish barbecue at the deserted Indian village in Del Monte Forest—A short

drive from the Hotel. This will be prepared for us by the Del Monte Hotel staff. The setting is the best and it will get us out of doors for the afternoon for the best of food and drink. We can play games—the good old softball baseball game you haven't played for years is great sport. And you'll be free to do as you please.

Tours—Everyone should visit the sights obtainable only in this glorious area. We want you to see historic adobes and monuments of Monterey, the 17-mile drive—Point Lobos—The Big Sur country if you choose—and there will be a great deal of construction at nearby Camp Ord for a touch of the busman's holiday.

Saturday night—The Golf Dinner in conjunction with the Producers Council for delegates and their wives. There as a golfer you'll get that trophy you didn't expect.

The detailed agenda is in process of composition and will be given to you at the Convention.

MAGAZINE HAS PUNCH

A prominent Los Angeles architect writes under date of August 11:

"Your issues on Dinwiddie and Mayhew have given the magazine a lot of punch lately. That is the sort of thing most of the younger chaps are interested in. Why don't you also get these men to write about the philosophy underlying their approach? But it's got to be better than the froth some of the profession put out. I certainly think you are on the right track with these special issues, and I believe it is well to stress a sectional consciousness in the development of our architecture.

"We're all interested to see what you are about to spring in the August issue."

CORRECTION

Editor:

I note on page 62 of the August issue of Architect and Engineer, that Messrs. George Kotchik and Rollin Boles were granted traveling scholarships "by the Oregon Chapter, A. I. A."

This is in error. The Scholarships granted were the "Ion Lewis Scholarships in Architecture." These scholarships are given from interest earned from a gift of the late Ion Lewis, prominent Portland architect, to the University of Oregon. The awards are made by a committee technically appointed by the State Board of Higher Education. The members of this committee are at present all members of the Oregon Chapter.

Yours very truly,

ELLIS LAWRENCE

Portland, Oregon, Aug. 19, 1940

More "NEW JOBS AHEAD"

all over the West

—thanks to CRANE-KRAFTILE 6 x 9's exhibit
at the World's Fair



Crane-Kraftile model bathroom installation in Construction Industries Building. Kraftile, the only tile exhibited on Treasure Island, also has displays or installations in the Hostess House of the National Garden Show and in the Alameda-Contra Costa Counties Building.



Kraftile Company is a member of the Producers' Council, Inc., the national organization of manufacturers of quality materials.

HUNDREDS of families have gone home from Treasure Island quite unhappy with their dingy, "old-fashioned" kitchens and bathrooms!

And no wonder! Once a home-owner, or prospective home-owner, views the modern beauty — the more "open feeling" of rooms tiled in big, handsome Kraftile 6 x 9's — he or she is spoiled for any other kind of wall.

The CRANE-KRAFTILE 6x9's installation has kindled the desire

of thousands of home-lovers for such new and truly different bathrooms and kitchens.

Inquiries that come to Kraftile as a result of this exhibit, together with inquiries from Kraftile advertising in other media, are incorporated in Kraftile's "New Jobs Ahead" program.

This plan not only *creates* the desire to build or remodel — it helps dealers, architects and builders *land the order*. For complete details, fill out the coupon.

Mail Today

KRAFTILE COMPANY
Niles, California
Please send me information on your "New Jobs Ahead" program of cooperation with architects.

Name _____

Address _____

City _____ State _____

MASTER KRAFTILE 6 x 9'S

"DATED" HOUSES

A house is old when it fails to provide convenience and comfort to those living in it. A house with a score or more of useful years behind it may yet be young, and one built yesterday may not be modern.

The electrical age is here, and electrical convenience is becoming increasingly important in the home. Antiquated lighting or an insufficient number of convenience outlets definitely place a house in the "pre-electrical" age.

The house which provides for the convenient use of appliances will remain modern indefinitely. The house in which few outlets are available, requiring unsightly and dangerous extension cords run under rugs or festooned around the room, is unnecessarily out of date.

Guard against premature obsolescence of the homes you design by including adequate electrical specifications.

NORTHERN CALIFORNIA ELECTRICAL BUREAU

447 Sutter Street

San Francisco

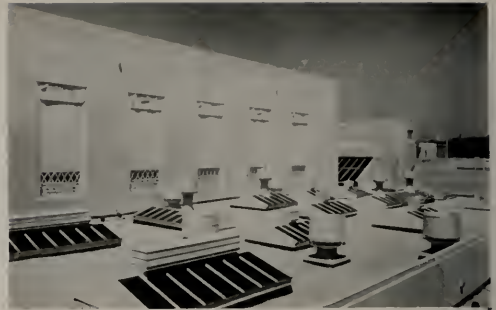

*Whittier Union High School,
Wm. H. Harrison, Architect,
Robertson Streamline Ventilators & Skylights*

CONGRATULATIONS TO "Bill" Harrison

Our thanks for his confidence in our products

H. H. Robertson Co.

691 Mills Bldg.,
San Francisco

816 W. Fifth St.,
Los Angeles

*Cellular Steel for floors and roofs,
Skylights and specially glass structures,
Robertson Protected Metal Roofing.*

PIONEERS? YES!!

In the memorable days of
1906 - 1907

our predecessors
WOODS & HUDDART

were the first to install STEEL REINFORCING BARS in SAN FRANCISCO'S substantial new buildings. As their successors, maintaining most of the original staff, we have continued to serve the building industry ever since, adding new building specialties from year to year.



GUNN, CARLE & CO.

(Incorporated Jan. 2, 1919)

20 Potrero Avenue
SAN FRANCISCO

Give us a call — Phone UNderhill 5480

As Modern as Today's News!

Salt Lake City Tribune-Telegram completes new U·S·S Stainless Front



CLOSE-UP of the entrance, showing detail of the U·S·S Stainless Steel doors. At the left, stainless strips are attractively combined with frosted glass panels. Architects: Ware and McClenahan; fabricator: A. & F. A. Hulbert Sheet Metal Works, Salt Lake City.

INTERIOR WORKMANSHIP is exemplified by this doorway leading from foyer to business office. All trim shown here, except for door handles, is U·S·S Stainless Steel. Note the stainless strips in the ceiling.

HERE is a building front that clearly looks its part. Even if it weren't labeled "Tribune-Telegram Building" you'd have every reason to suspect that it housed a modern newspaper publishing plant. Here, U·S·S Stainless Steel and glass are combined to produce a front suggestive of speed, accuracy, and permanence. A modern plant for a modern newspaper.

It's another example of the way U·S·S Stainless Steel, strategically combined with other recognized architectural materials, achieves effects that are strikingly appropriate, and at the same time dignified and attractive. In the hands of a clever

architect, U·S·S Stainless Steel is far more than "just another bright metal." It is a clean, fresh, lively material; strong, easy to fabricate, free of rust. Architects and builders are finding every day that it offers new opportunities to produce exactly the desired effect in modern buildings.

Remind your clients that U·S·S Stainless Steel is as practical as it is beautiful . . . that it is as immune to weather as glass . . . that it needs only ordinary washing to keep it looking new. Our nearest district sales office will gladly recommend local fabricators, skilled in making U·S·S Stainless Steel building fronts and architectural trim at moderate cost.

CLEAN, CRISP LINES executed in polished U·S·S Stainless Steel, give this front an appearance peculiarly appropriate to the modern newspaper. The large block letters are also of this rust-free material, as are the awning covers and sign work on the fur shop next door.

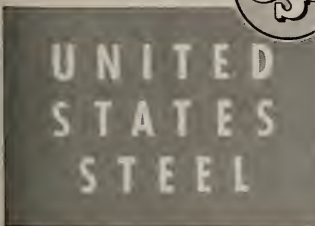

U·S·S STAINLESS STEEL

COLUMBIA STEEL COMPANY, *San Francisco*
AMERICAN STEEL & WIRE COMPANY, *Cleveland, Chicago and New York*
CARNEGIE-ILLINOIS STEEL CORPORATION, *Pittsburgh and Chicago*
NATIONAL TUBE COMPANY, *Pittsburgh*

Scully Steel Products Company, *Chicago, Warehouse Distributors*
United States Steel Export Company, *New York*

UNDISTURBED!

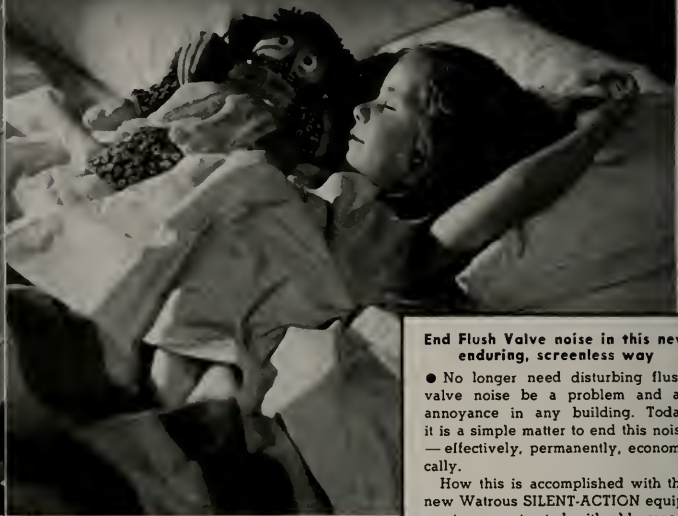

YOUNGSTERS as well as Oldsters are jumpy these days. Things that wouldn't have bothered them at all a generation ago now result in all kinds of peculiar reactions. That explains the thorough study being given to noise elimination in modern building layout.

The new Watrous SILENT-ACTION Flush Valve makes available for the first time a Flush Valve that is not only remarkably silent in operation, but one that will remain silent as the years go by. It remains silent because—for the first time in the history of the industry—it has solved the problem of eliminating flush valve noise without the use of screens, shot, mufflers or other elements which readily become clogged.

Tests made by a nationally-known research laboratory (name on request) show that Watrous SILENT-ACTION eliminates an average of 88.5% of ordinary flush valve noise energy. You cannot specify a quieter flush valve!

Before you select the flush valves for apartments, hospitals, hotels and other buildings where noise reduction is an important part of modern design, get complete details on Watrous Silent-Action Flush Valves.



You will find complete specification details in Catalog 54, Section 27 of Sweet's Catalog File. We shall also be pleased to mail you a copy of an interesting bulletin "A Scientific Method of Silencing Flush Valves."

THE IMPERIAL BRASS MFG. CO., 1237 W. Harrison St., Chicago, Ill.

Watrous

SILENT-ACTION Flush Valves

THEY PAY FOR THEMSELVES IN THE WATER THEY SAVE

End Flush Valve noise in this new enduring, screenless way

● No longer need disturbing flush valve noise be a problem and an annoyance in any building. Today it is a simple matter to end this noise—effectively, permanently, economically.

How this is accomplished with the new Watrous SILENT-ACTION equipment—as contrasted with old screen-type silencing methods—is told in the two descriptions below.

THE OLD WAY

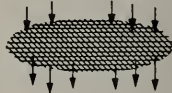

● The old method of silencing flush valves is to pass part or all of the water going to the valve through one or more screens. (Perforated discs or shot pellets also used). The trouble with this method—as the screen on your kitchen faucet will quickly show you—is that screens become clogged and must be cleaned or replaced at frequent intervals.

Also, clogging makes necessary frequent adjustment of the shut-off to keep the valve working properly.

THE WATROUS WAY



● The new method of silencing used in Watrous SILENT-ACTION Flush Valves, is to pass the water between two surfaces having a large number of corrugations or roughened surfaces.

Note there is nothing in this unit which requires replacement and there is ample space for dirt and scale to pass through. As a result, silent operation stays silent and there is no need for frequent adjustment or renewal of parts.

AN INSURANCE POLICY THAT *Costs You Nothing*

Satisfaction INSURANCE

The use of Sloan Flush Valves insures you **plus** values of satisfaction not obtainable elsewhere, **for only with Sloan** can you enjoy the benefits of 34 years **specialized** flush valve experience.

SAFETY. Only Sloan Flush Valves provide back-syphonage insurance through a nationally approved, **integral** vacuum breaker.

ENDURANCE. Hundreds of thousands of Sloan Flush Valves still in service after 25 or more years assure you of **enduring** satisfaction.

LOW UPKEEP. The name Sloan insures you low cost upkeep. Records of large installations show $\frac{1}{8}$ c to $1\frac{1}{8}$ c per valve, **per year.**

WATER SAVINGS. Here is an insured benefit backed by countless records. The original "can't-be-held-open" to waste water feature, plus **simple, accurate adjustment** that "stays put" are the reasons why.

QUIETNESS. The satisfaction of completely quiet operation is assured you by the use of Sloan *Quiet-Flush* Valves.

COST:
**ONLY YOUR INSISTENCE ON THE
NAME "SLOAN"**

The National Plumbing Laboratory is at the University of Iowa Institute of Hydraulic Research, under the direction of the dean of the College of Engineering.

V-100-B
Vacuum Breaker for
all fixtures with
small piping

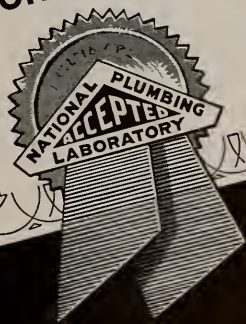

STAR
Leads the world in sales

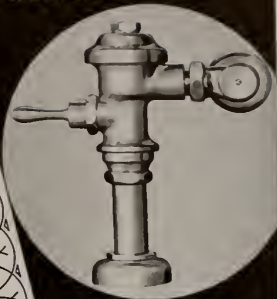
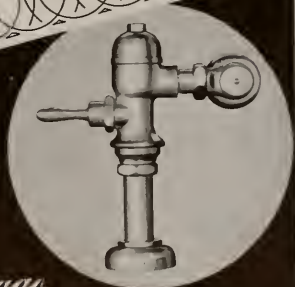

ROYAL
Outstanding for 34 years



V-100-A
Vacuum Breaker for
any make of flush
valve

SLOAN VALVE COMPANY. *Chicago*

Whatever the job... *Consider Redwood*

"South of the Golden Gate" . . . Room designed by Harwell Hamilton Harris and Carl Anderson, collaborator, in the "America at Home" exhibit at the New York World's Fair. Vertical - panelled walls and woodwork are of Redwood treated with only a transparent finish.



Warmth, Cheer, Beauty radiate from REDWOOD paneling . . .

for Redwood reflects the glory and color of sunshine. You may have Redwood as pale as sunrise, as coral as twilight, as rose-tinted as sunset . . . each with beautiful grain and adaptable to a variety of effective finishes. For interior panels Redwood is a wood to live with and enjoy through the years.

And of course Redwood has long demonstrated, to

thousands of architects and millions of home owners its practical values of durability and economy for exteriors as well as interiors.

For complete information on building and styling with Redwood write California Redwood Association, 405 Montgomery St., San Francisco; 5th and Figueroa, Los Angeles.

JUNIOR SCORES CHAPTER MEETINGS

A Junior member of Southern California Chapter, A.I.A., has written an open letter to the Chapter Bulletin, outlinging his views of the value of Junior membership in the organization and asking a few pertinent questions he thinks should be answered. To quote:

"We as Juniors have had only six to twelve months membership in the group. We have not had the opportunity to meet individually with the Executive Committee. We have not been privileged to serve on committees. We have never been to an A.I.A. Convention. Considering our inexperience, please be tolerant of our opinions.

"We do know one thing, however, better than anyone else: The position of the young man in Architecture. As young men in Architecture we have read the aims of The Institute. With these we can have no dispute. Only on the methods used to obtain the results can we debate. For this first article we would like to discuss the Chapter meetings.

"With the aims of The Institute in mind—Junior has attended the last eight meetings. The young man is aware of at least a dozen problems that seem to need intensive study and action. To Junior it seems that The Institute is the group to shoulder these problems. Because we have not heard much discussion of these things at meetings, Junior's conclusion is that the members' attitude is one of three things:

"1. The profession is on top of the world and no business is necessary at meetings.

"2. The members are tired of the old problems which never get solved and so disperse with business.

"3. Nobody cares because the profession is going to the dogs anyway and no amount of activity can save it.

"However, Junior does not wish to believe this is the case.

"When he asks 'Why no business in meetings?' he gets the answer, 'We do all our business in committees.' If our major work must be done in committees, let's keep the committees active and call for more frequent reports. We all know how much time these things take out of our day and how difficult it is to get a group together. It seems the young man might be given more of the work to do, principally because he has more time.

"No criticism is of value without a suggested solution. Junior suggests the following plan, which is, of course, wide open for further ideas: Reserve at least part of the meeting time for business about the profession of Architecture in general, and what The Institute can do in particular. We all like to hear about how the Museum is progressing. We like to visit schools and have free dinners. We like to dress up and give honorary memberships. We like to play baseball. But we would like to hear more about Architecture.

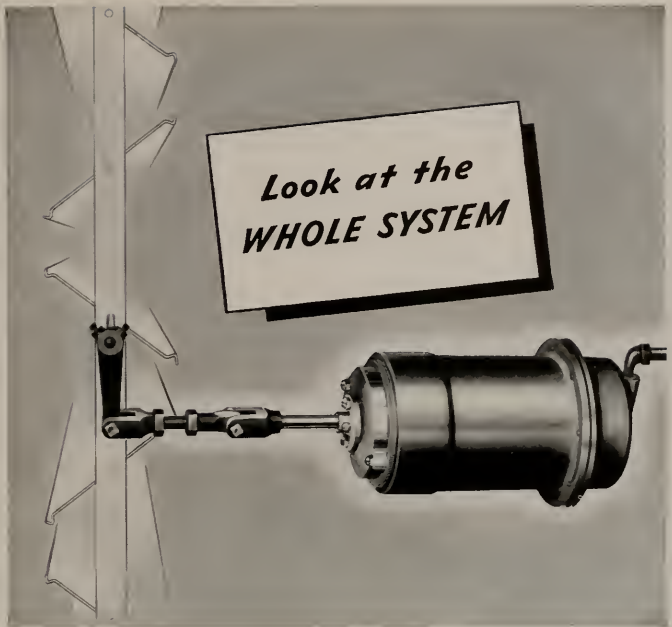

JOHNSON'S "LONG TRAVEL" DAMPER MOTORS improve the entire automatic control installation

Johnson "Piston Type" Damper Motors are a new departure in units for moving dampers. This unique device, emphatically not just another valve operator adapted to other service, is engineered especially to perform the particular work of controlling dampers gradually. Designed from that viewpoint and tested in actual service, these Johnson "long-travel" motors improve the whole automatic control installation. More power! More movement! Greater simplicity! G-R-A-D-U-A-L control!

These devices satisfy another of the definite requirements of the air conditioning and process control industries. They furnish one more evidence of the ingenious development and unique design which characterize modern Johnson temperature control systems...Send for Bulletin D-251 which describes Johnson Piston Type Damper Motors or Bulletin D-261 which includes the Johnson Pilot Mechanism, where exact repositioning is required.

JOHNSON CONTROL IS THE "BRAIN" OF THE AIR CONDITIONING SYSTEM

JOHNSON

Automatic TEMPERATURE AND AIR CONDITIONING Control

JOHNSON SERVICE COMPANY, MILWAUKEE, WIS. & BRANCHES IN PRINCIPAL CITIES



The "long travel" feature of JOHNSON Piston Type Damper Motors is desirable where gradual positioning of automatically controlled dampers is required.



Direct connection between motor and damper means maximum power. Ordinary damper motors require levers, appreciably reducing the useful operating force.



Pilot mechanism, not illustrated, is optional. Smooth gradual operation, independent of friction, air velocities, and other variations.



Another important member of the distinctive line of JOHNSON devices for gradual control that is G-R-A-D-U-A-L. Similar to JOHNSON "Streamline" valves.

AQULUX 85

NEW Oil Burning
Water Heating Unit

This powerful and compact vertical unit, beautiful in appearance, is designed to supply hot water at minimum cost in the modern home. It can also be used to supply heat and hot water automatically for small homes without the necessity for basement installation. Complete data on this new "package unit" now ready.

Burns No. 3 C. S. G.
fuel or Diesel oil

S. T. JOHNSON CO.

940 ARLINGTON, OAKLAND, CALIF.
401 N. BROAD ST., PHILADELPHIA, PA.

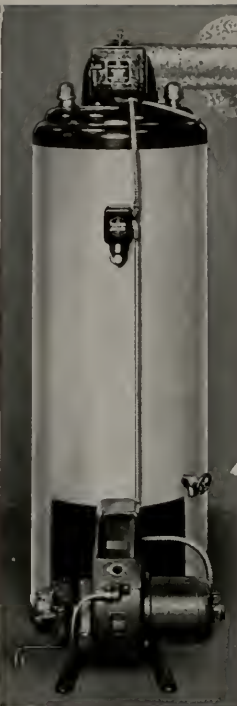

SUPERIOR FIREPLACE

*CIRCULATES WARM AIR
to all corners and adjoining rooms*

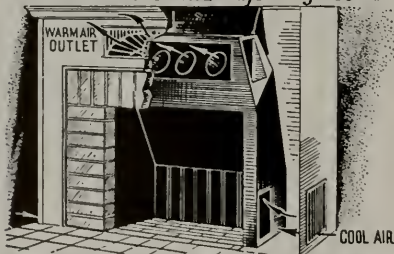

A COMPLETE FORM

(from hearth to flue)

AROUND WHICH IT IS EASY TO BUILD

A new or remodel present fireplace.
—cut fuel bills—correct smoke troubles.
Thousands in use in all climates.

Healthful—because it ventilates, circulates and evenly
distributes warm air.
Write for Superior Fireplace Literature

Manufactured by the Pioneers of the Industry—

SUPERIOR FIREPLACE COMPANY

1046 South Olive Street

Los Angeles, California

Seal THE DAMPNESS OUTSIDE



with



PACIFIC PORTLAND CEMENT COMPANY
COASTWIDE SERVICE

Recommended

Good plumbing and heating contractors recommend the BILTWEEL Gas Furnace because it has been consistently good business for them to do so. It is good business for the architect too, not only to recommend, but to specify BILTWEEL. Expertly designed and constructed for safety, economy and life-long dependability. Models and sizes for every purpose.



Our literature explains 16 points of superiority of the BILTWEEL AIR CONDITIONING FURNACE.

Fraser & Johnston Co.
725 POTRERO AVE.
SAN FRANCISCO

Manufacturers of
BILTWEEL
and
TORIDAIRE
GAS FURNACES

HERMOSA TILE *presents*

DURA-GLAZE

for **FLOORS**
and
DRAINBOARDS



New in
BEAUTY
TEXTURE
DURABILITY
ECONOMY

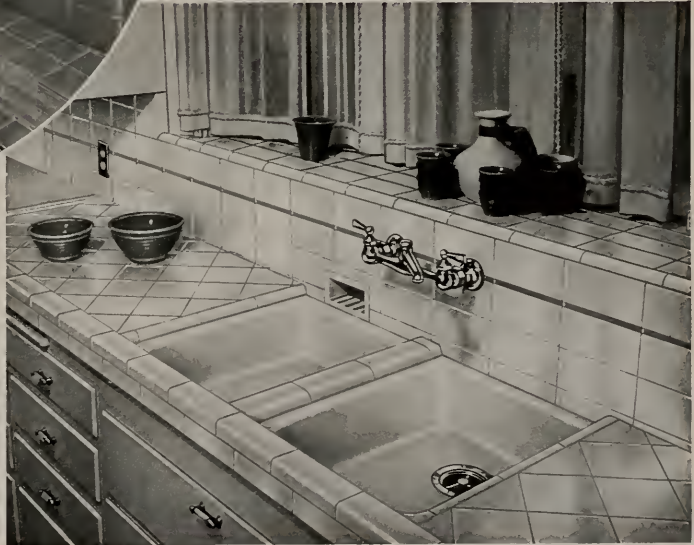

There are no known "successful" substitutes for TILE...HERMOSA TILE (70 colors soft matts brilliant gloss glazes) COST JUST ONE-HALF the PRICE of ELEVEN YEARS AGO. The like glaze on DURA-GLAZE Floor Tile (6 colors) has been developed for the hardest of wear . . . offering easy and economical maintenance (no waxing polishing or shining). You are cordially invited to visit our show rooms.

LADDING, McBEAN & CO.

LOS ANGELES • SAN FRANCISCO • SEATTLE • PORTLAND • SPOKANE • DALLAS • DENVER • HONOLULU, T. H.

IT'S CERAMIC VENEER



East Portland Branch, The
First National Bank of
Portland, Oregon.

Architects: Barrett & Logan.
Material: Ceramic Veneer.

The brilliant new beauty of N. Clark & Sons' Ceramic Veneer is lasting and pleasing. It lends itself admirably to functional design. Those who use it specify it again and again. So it works with the owners and the designers of this building, for N. Clark & Sons' Ceramic Veneer is now being used on another new branch of the First National Bank of Portland, situated at East Eighty-Second and Foster Road.



N · C L A R K A N D S O N S

116 Natoma Street • San Francisco

LOS ANGELES • SALT LAKE CITY • PORTLAND

PRODUCERS OF QUALITY ARCHITECTURAL CLAY PRODUCTS

Proof

SEE HOW
REVOLUTIONARY NEW

FULLER FLORCOTE SYSTEM

STOOD THE TEST ON
SAN FRANCISCO'S
1939 WORLD'S FAIR FLOORS!

Just look at the difference! At the left, a section of floor in the Homes & Gardens Building at the close of the Fair — one portion (bottom) treated with Fuller Florcote, the other portion (top), untreated.

What amazing protection! The reason? This new penetrating-type Fuller varnish hardens wood fibres, seals surface pores, becomes part of the wood itself. And what a cinch to maintain—easy, economical!

Ask about Florcote! For help in working out a thrifty answer to any painting problem, call on the Fuller Service Department.

*Made by W. P. Fuller & Co.,
the West's largest paint
manufacturers.*

UNTREATED

TREATED WITH
FLORCOTE

**FULLER
PAINTS**
they last

*The ferry ramp could "take it"
—thanks to Fuller Varnishes.*



*Protected by Fuller Floor Preservative
Varnish, floors of the Fine Arts Palace
still gleamed on the last day of the Fair.*



Photo by Clyde Stoughton

MAIN ENTRANCE FACADE TO AUDITORIUM, WHITTIER UNION HIGH SCHOOL,
WHITTIER, CALIFORNIA
WILLIAM H. HARRISON, ARCHITECT

RECENT WORK OF WILLIAM H. HARRISON, A. I. A.

By PAUL R. HUNTER

DURING the past two decades architecture in the United States has been undergoing profound changes. These changes have nothing in common with the desire for mere variety in design or for the substitution of one historical style for another, although they have been made possible by the realization on the part of the architect and the public that it is not necessary for the structure of a building to be cloaked in a traditional style in order to have beauty and significance. The demands made upon the buildings of today are bringing into being a contemporary architecture that is in keeping with developments in transportation and the sciences.

Many of the aims and objectives of contemporary architecture are to be found in the work of William H. Harrison of Los Angeles, which is illustrated in this issue of *Architect and Engineer*. The imaginative solution of a new and unexplored field of planning brought national recognition to Mr. Harrison in 1929, when, in association with A. C. Zimmerman, he was co-winner of the \$5,000 first prize in a competition for the design of a modern municipal airport, sponsored by the Lehigh Portland Cement Company. The winning design, unanimously selected by the jury, was commended "for the very logical organization of its units, for the excellent conception of the relative scale of its members, and for its splendid architectural development."

This competition provided the means and stimulus for Mr. Harrison to enter upon independent practice. A graduate of Cornell University, he received office training in New York, Philadelphia, and Indianapolis, then came to California in 1927. In Los Angeles he gained local experience in the offices of Allison & Allison, Robert Farquhar, Gordon Kaufmann, and Roland Coate.

Among his first commissions were some minor alterations in a bank. As the studies progressed, additional alterations were considered, until finally a two story structure and basement on the same site was planned and built. This building, the Whittier National Trust & Savings Bank, is a good example of Mr. Harrison's work: the masses are simple, with accents of sculptural detail and contrasts of materials, colors, and finishes.

In Whittier are also to be found a number of new and rehabilitated school buildings. Among these is the high school auditorium, a very large and completely equipped assembly building. While modern in treatment, this building has a symmetry and rhythm reminiscent of classical architecture. In the Hoover school the design has been arranged about a concave sculptural frieze above the entrance doors.

Mr. Harrison's residential work is transitional in feeling, drawing much inspiration from Colonial and Early California precedents. His houses have the simplicity, directness and charm that is characteristic of the best houses of this region.



PERSPECTIVE OF AUDITORIUM, WHITTIER UNION HIGH SCHOOL, WHITTIER
 William H. Harrison, Architect

Rendering by R. M. Kennedy

AUDITORIUM, WHITTIER UNION HIGH SCHOOL

THE auditorium of the Whittier Union High School has a capacity of approximately 2500 seats and provides facilities for assemblies, concerts, motion pictures, lectures, and civic affairs.

The building is of structural steel and reinforced concrete. The exterior is of sand colored Cementone brush coating. Along the front and the entrance recesses is a wainscot of the rich rose colored Oriental Vermont marble. The marquees are faced with extruded Muntz metal in a fluted pattern. Soft green wrought iron gates are placed at each of the five entrances.

Heat, ventilation, and light are furnished to the building without windows or skylights, except in the corridors. The shape of the audi-

torium itself has been determined by acoustical considerations. Alternate bands of hardwall plaster and acoustical tile on the walls serve to break up the sound waves. The ceiling has been called a structure of light. At either side of the proscenium arch are decorative organ panels cut in plywood.

One of the outstanding pieces of equipment is the stereophonic public address system, which by means of two loud speakers gives movement and perspective to sound.

The consultants for the building, assisting Mr. Harrison were: Dr. Vern O. Knudsen for acoustics; Ralph E. Phillips for mechanical engineering, and Paul E. Jeffers for structural engineering.

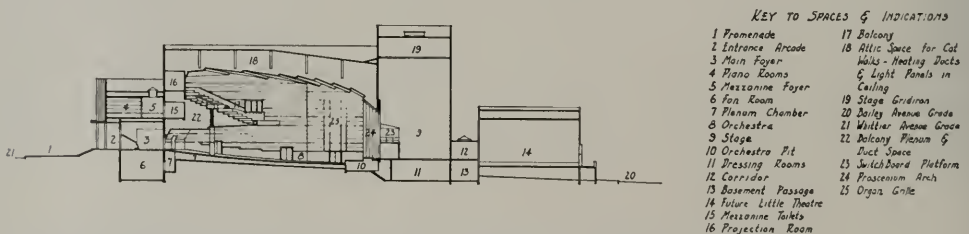

SECTION AND KEY, UNION HIGH SCHOOL AUDITORIUM, WHITTIER, CALIFORNIA

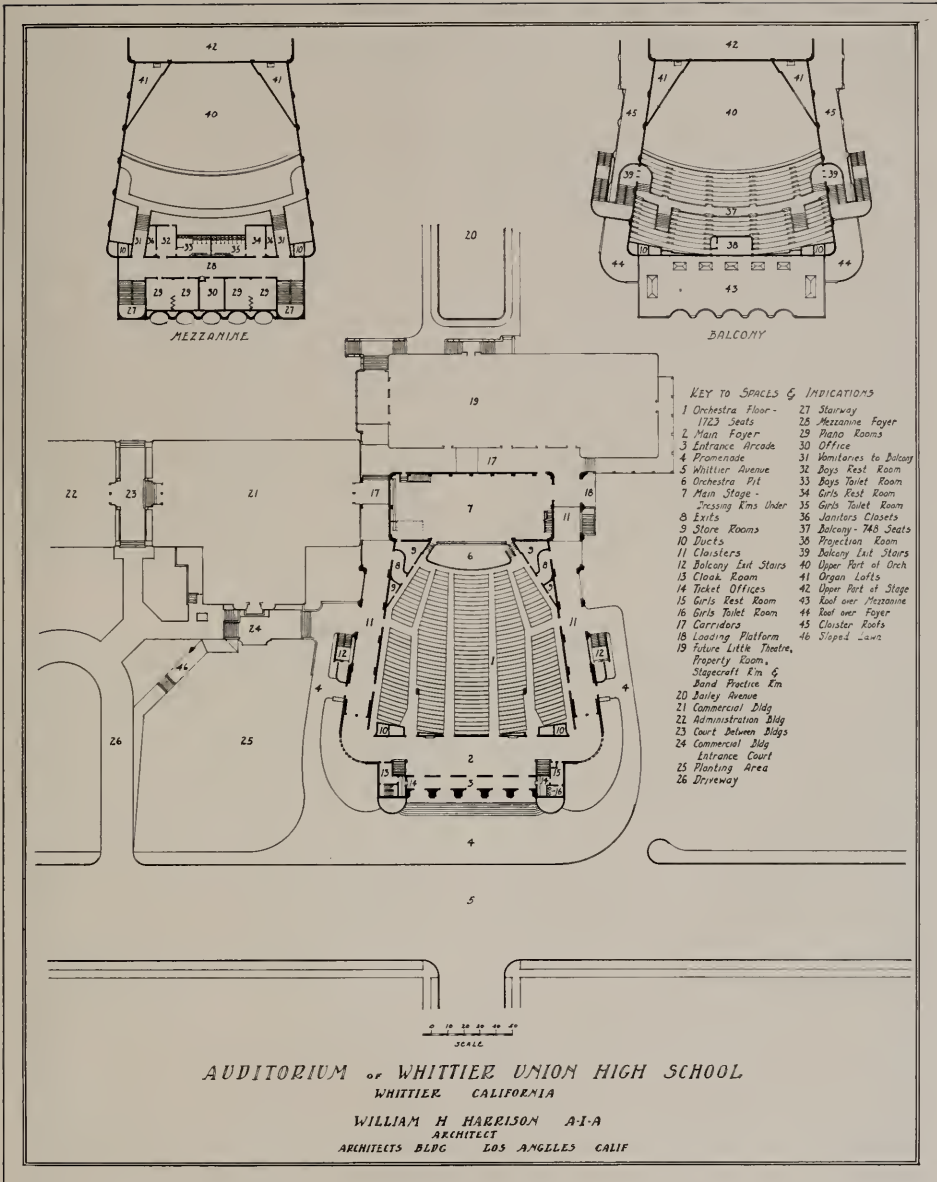

PLANS, AUDITORIUM, WHITTIER UNION HIGH SCHOOL

WHITTIER UNION HIGH SCHOOL AUDITORIUM



DETAIL OF ORGAN GRILLE



DISPLAY CASE—Walnut trim, Lacewood paneling



AUDITORIUM STAGE, PROSCENIUM ARCH AND ORGAN GRILLES

The Auditorium will seat 2500 persons and is equipped for concerts, stage plays, motion pictures, conventions and lectures.

Auditorium from Swimming Pool Stadium, showing Stage Loft and Rear Elevation of Commerce Building. Boys' and Girls' Dressing Room Buildings are adjacent to Swimming Pool.

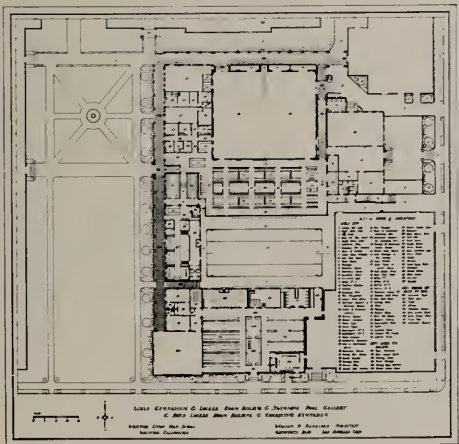

PLAN OF GIRLS' GYMNASIUM AND BOYS' DRESSING ROOM BUILDING



DETAIL OF BALCONY EXIT STAIRWAY



Cloister connecting Commerce and Administration Buildings, Whittier Union High School. Second floor bridge forms horizontal exits between the two structures. Commerce Building has been redesigned, reconstructed and strengthened. Exterior walls are 4" Gunitite.

Physical Education Buildings shown below are of reinforced concrete, including roof slabs. Gymnasium spans are of steel trusses. Exterior walls finished with a "Cement One" brush coating.

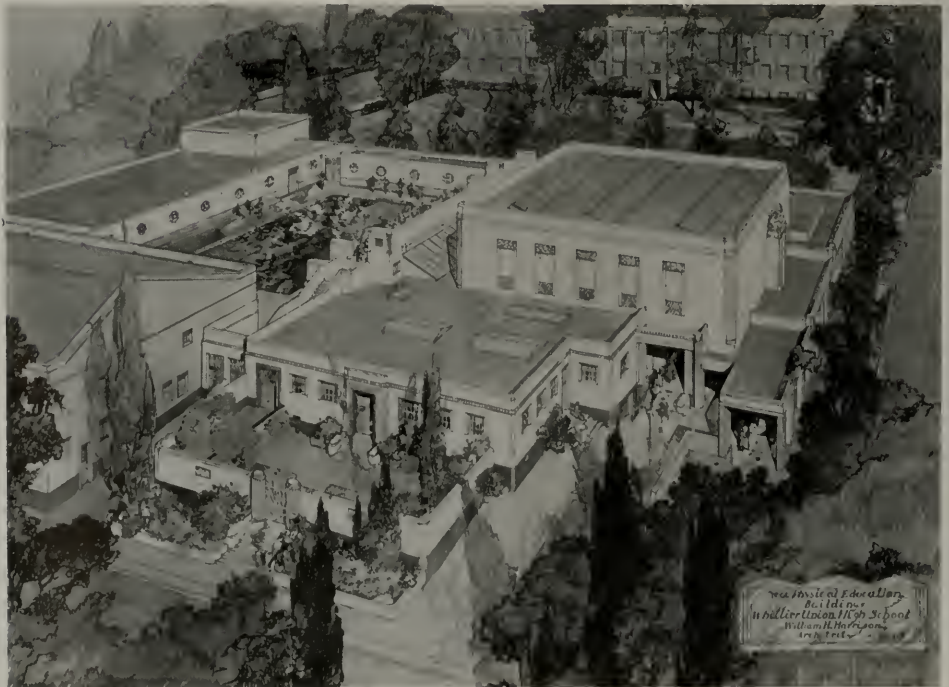

AERIAL PERSPECTIVE OF GIRLS' PHYSICAL EDUCATION BUILDINGS, WHITTIER
 William H. Harrison, Architect

Rendering by R. M. Kennedy



Photo by Clyde Stoughton

FRONT ELEVATION, ADMINISTRATION BUILDING, WHITTIER UNION HIGH SCHOOL

The Administration Building, like the Commerce Building, was redesigned, reconstructed and strengthened.

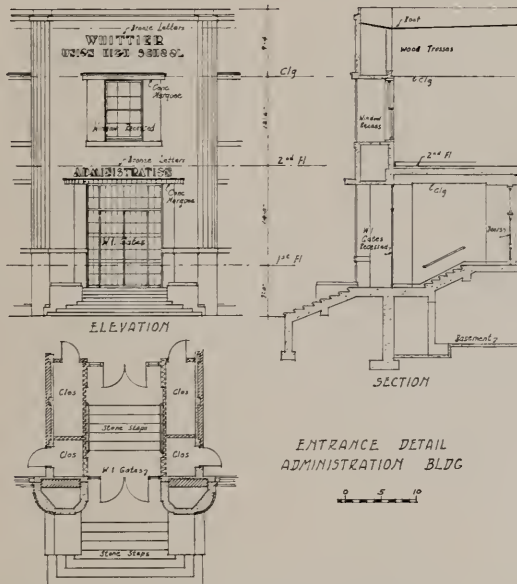

ENTRANCE DETAIL, ADMINISTRATION BUILDING, WHITTIER U. H. S.
William H. Harrison, Architect



Landscape Architect—George Kern

FRONT ELEVATION OF LOU HENRY HOOVER ELEMENTARY SCHOOL, WHITTIER

LOU HENRY HOOVER SCHOOL, WHITTIER, CALIFORNIA

THE design objectives of the Lou Henry Hoover School are well set forth by Will E. Wiley, Superintendent of the Whittier City Schools, who has written in the School Board Journal:

"Several circumstances combined to give special emphasis to the demand for beauty in this school. The trustees felt that the new building should reflect the ideals of beauty and livableness found in the homes surrounding it. The school stands on rising ground and faces directly down a tree-lined avenue. The future extension of the building will create a balance on this axis. To these considerations was added the fact that the new school was to be named for a most gracious woman who received part of her early training in the Whittier schools."

In plan the building is only one classroom thick, the rooms being served by a covered terrace. The free, experience type of training

used may easily be extended out-of-doors. At the rear is a small amphitheater accommodating 200 children on wooden benches.

Over the entrance door is a 7 foot high 27 foot long bas relief panel designed by B. Mako, representing the various phases of present day educational activity in Southern California. By means of a full size waste mould the figures were made an integral part of this reinforced concrete building. Plywood forms were used inside and out; the exterior has a Cemelith brush coat, the interior oil paint. Another feature of the exterior is the use of curves at the corners of the building.

The rooms are unusual in having a glass area of more than 25 per cent of the floor area, and in addition six indirect lighting fixtures. The kindergarten, with its delightful aquarium and pleasant fireplace, is also used for meetings of the Parent-Teachers Association.

Close up of main entrance, Lou Henry Hoover School, Whittier, California.



Panel over entrance made by waste mould process in concrete. Designed and sculptured by B. Mako.

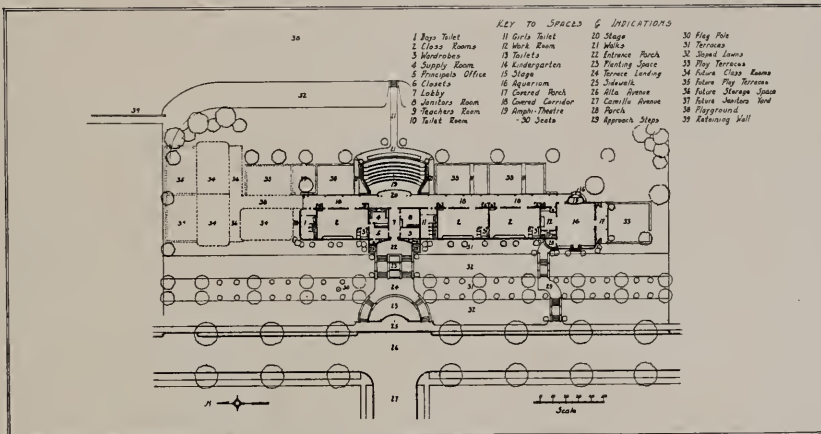

PLAN, LOU HENRY HOOVER ELEMENTARY SCHOOL, WHITTIER, CALIFORNIA
William H. Harrison, Architect





WHITTIER NATIONAL TRUST & SAVINGS BANK BUILDING, WHITTIER, CALIFORNIA
 William H. Harrison, Architect

Officers' space and mezzanine, Whittier National Trust & Savings Bank Building, Whittier, California

OPPOSITE PAGE, Upper left—Rear view of Lou Henry Hoover School, showing covered terrace and amphitheater

Lower left—Kindergarten





DENTAL OFFICE BUILDING FOR DR. HAROLD STONE, LA HABRA, CALIFORNIA
 William H. Harrison, Architect

All operating rooms have North light, and all rooms are arranged around a central business office and nurses' station.

- Key*
- | | |
|----------------------------|--------------------|
| 1 Business Office | 10 Business Files |
| 2 Reception Room | 11 Closets |
| 3 Retiring Room | 12 Passage |
| 4 Toilet | 13 Operatory No. 2 |
| 5 Office-Private | 14 Laboratory |
| 6 Rear Entrance | 15 Operatory No. 1 |
| 7 Air Comp. & Water Heater | 16 Walk |
| 8 Hygienist | 17 Parking Area |
| 9 Wash Room | 18 Sidewalk |

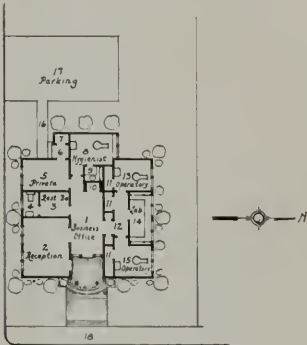

Dental Offices

PLANS, DENTAL OFFICE BUILDING
 FOR DR. HAROLD STONE, LA HABRA,
 CALIFORNIA

William H. Harrison, Architect



PERSPECTIVE, BUILDING FOR WHITTIER ART ASSOCIATION,
WHITTIER, CALIFORNIA

William H. Harrison, Architect

Building is frame construction with redwood siding, shingle roof, 24" Royals, hardwood floors.

PLAN, BUILDING FOR WHITTIER
ART ASSOCIATION, WHITTIER,
CALIFORNIA

William H. Harrison, Architect

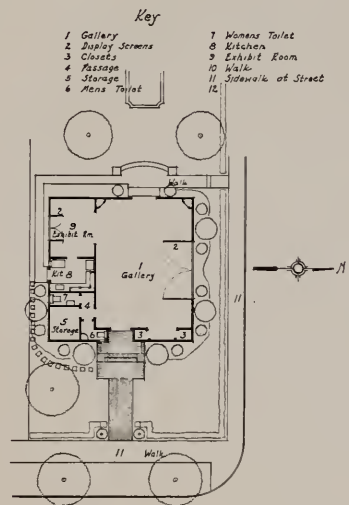



Landscape Architect—Ruth Shellhorn

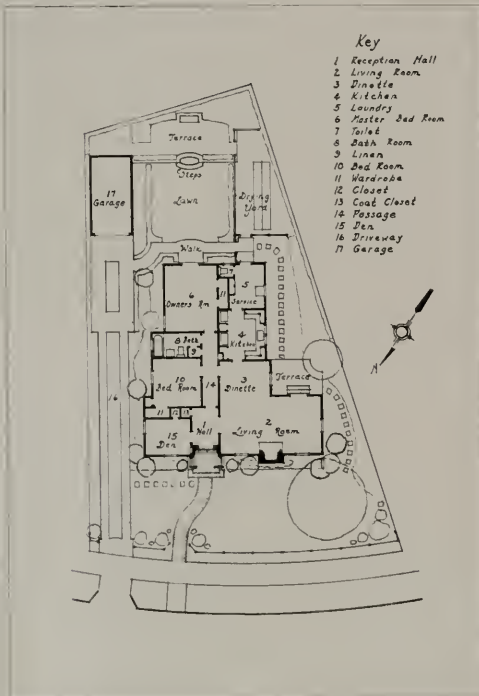

RESIDENCE FOR MR. AND MRS.
ROBERT W. MYERS, WHITTIER, CALIFORNIA

William H. Harrison, Architect

The style of architecture has a suggestion of French influence.



Landscape Architect—Ruth Shellhorn

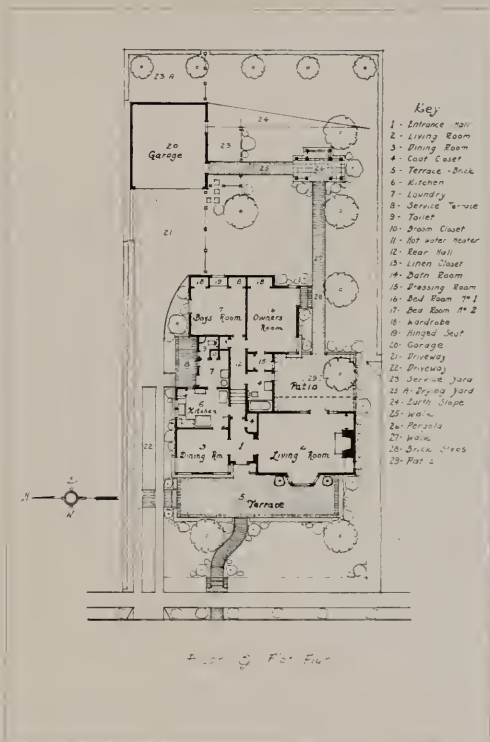

RESIDENCE OF MR. AND MRS.
LESLIE H. CROCKER, WHITTIER, CALIFORNIA

William H. Harrison, Architect

The modern feeling is evidenced here in horizontal and vertical lines of entrance and bay.



Landscape Architect—Esther Williams

RESIDENCE FOR MR. AND MRS. A. H. BRANNON, EAST WHITTIER, CALIFORNIA

William H. Harrison, Architect



Exterior front walls of this house and the adjoining terrace are of 5" stone veneer. Walls elsewhere are wood frame and plaster. The problem was to design a one story ranch house in an orange grove with open vistas of the mountains to the North and Eucalyptus trees to the East, reserving the intimacy of the orange trees for patio activities.

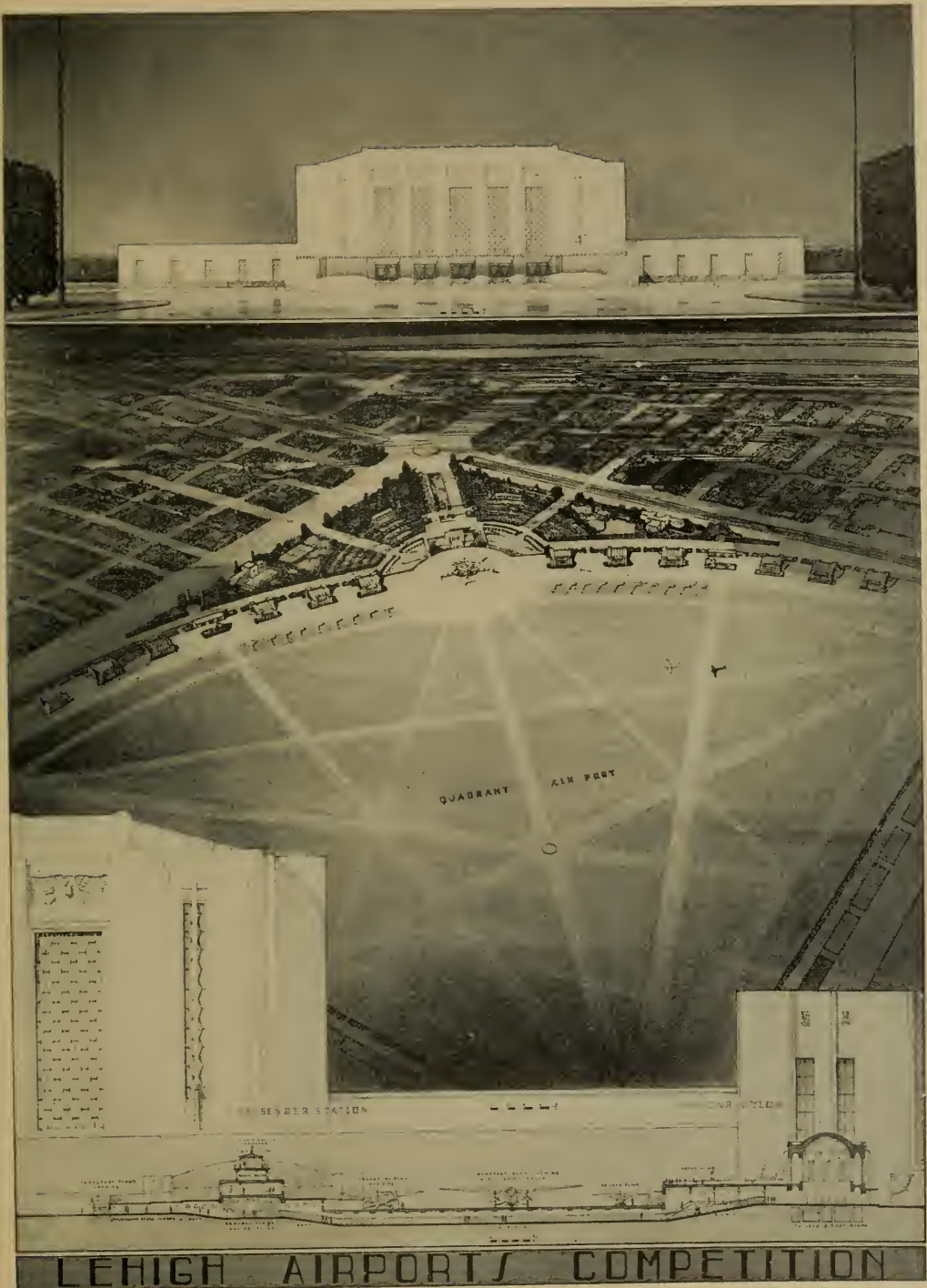

LEHIGH AIRPORTS COMPETITION

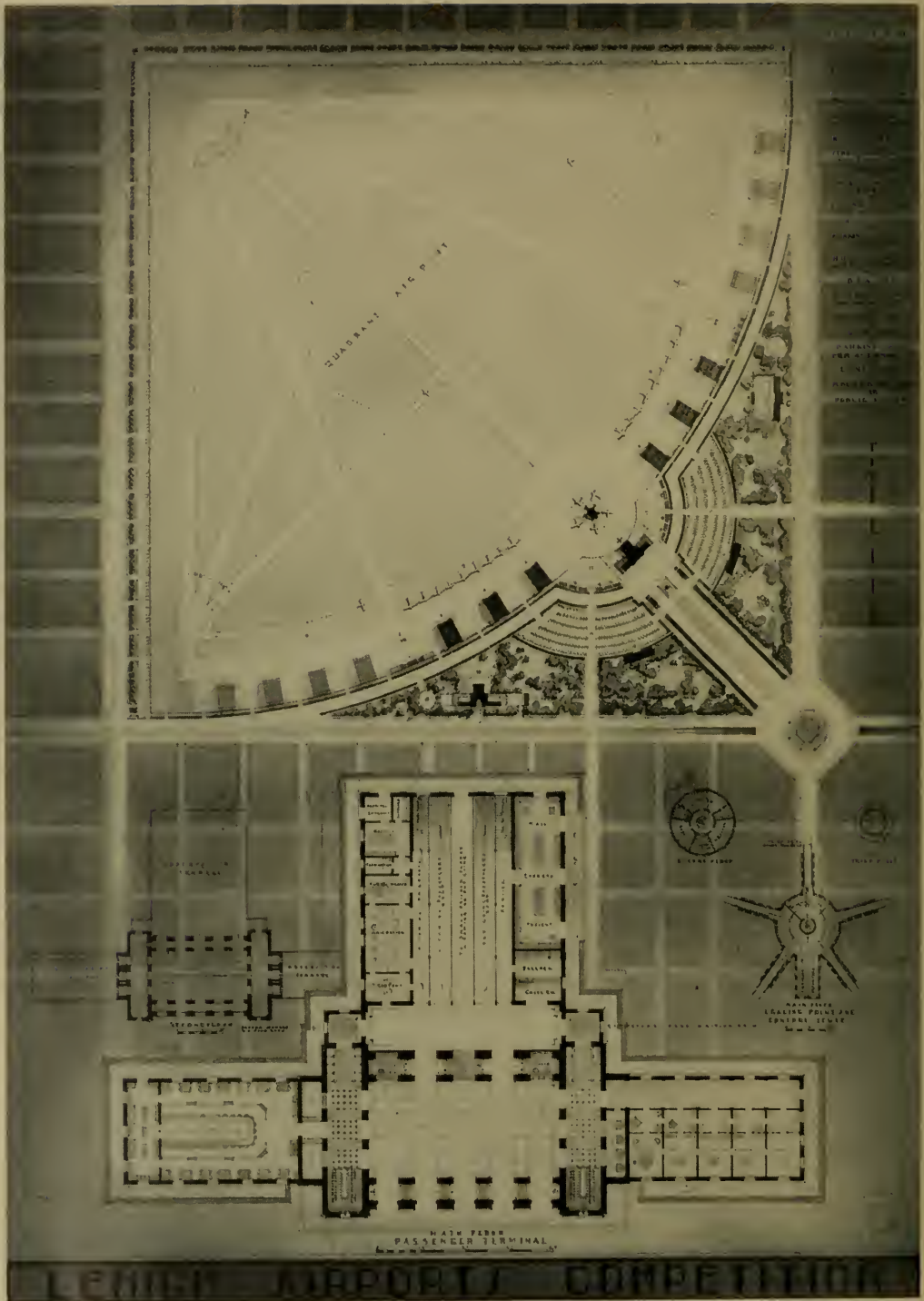



HANGAR PYLON, LEHIGH AIRPORTS COMPETITION

Mr. Harrison, together with Mr. Zimmerman, received the \$5,000 First Award in this competition

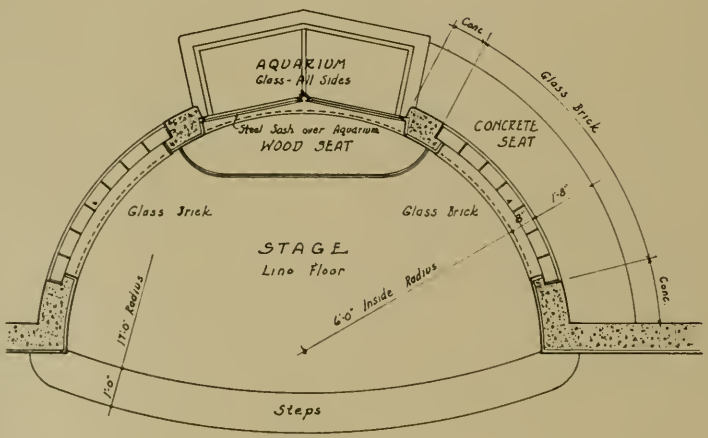
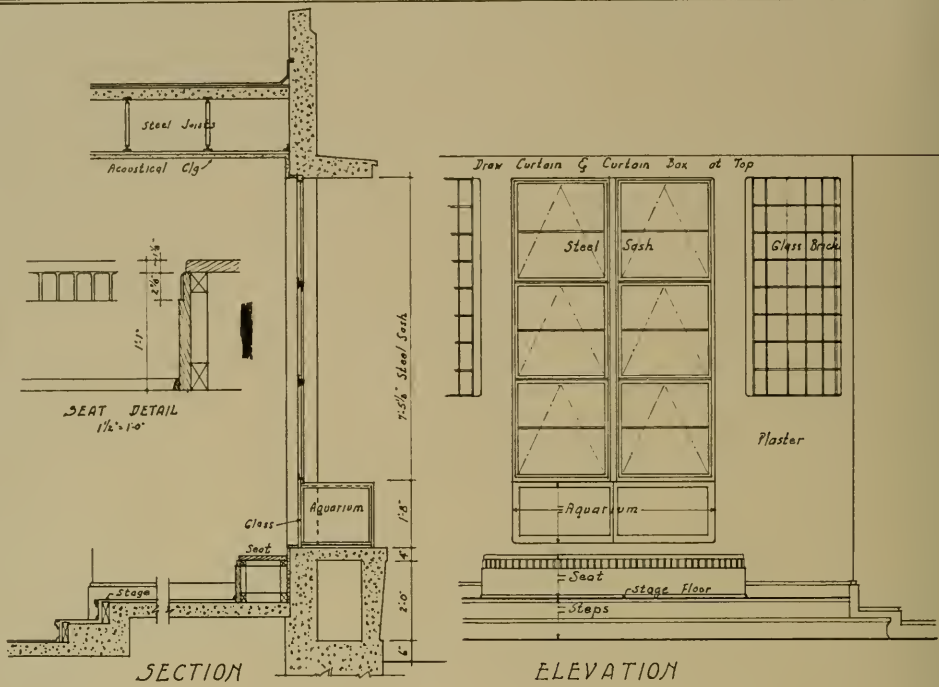

DETAIL of KINDERGARTEN STAGE & AQUARIUM
1 1/2" x 1-0"

William H. Harrison - Architect



STAGE IN KINDERGARTEN OF LOU HENRY HOOVER SCHOOL, WHITTIER

The room is made convertible so it may be used for P.T.A. meetings and small community gatherings

RESIDENCE FOR MR. A. H. BRANNON, WHITTIER, CALIFORNIA

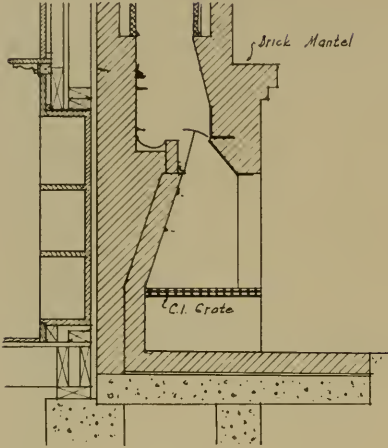

SECTION

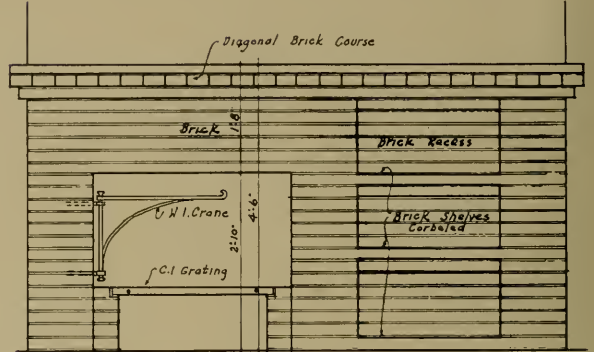

ELEVATION

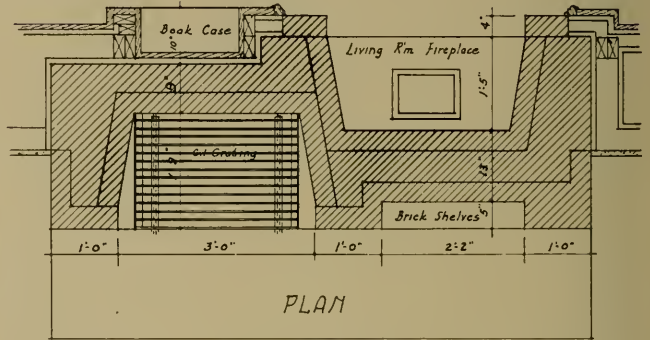

PLAN



LIVING PORCH WITH DETAILS, ELEVATION,
SECTION AND PLAN OF OUT-DOOR FIREPLACE

William H. Harrison, Architect



FRONT ELEVATION, RESIDENCE OF DR. AND MRS. HARRY J. SCHOTT,
LOS ANGELES, CALIFORNIA

William H. Harrison, Architect

Photo by Clyde Stoughton



RESIDENCE OF MR. AND MRS.
WILLIAM H. HARRISON, WHITTIER,
CALIFORNIA

Features of the Harrison home include the multi-use of space to fit an oddly shaped lot, convertible laundry (with inclosed tray and washing machine) used as serving pantry for breakfast terrace; built-in wardrobes, card table space, bookcases, etc.

MOST IMPORTANT RECENT DEVELOPMENT IN CONCRETE

By J. E. JELICK, Manager Portland Cement Information Bureau, San Francisco

FOR the past two years the concrete laboratory of the Denver office of the Bureau of Reclamation has carried on extensive research in an effort to develop a means of eliminating the excess water and entrained air that normally is found close to the surface of formed concrete. Prior to this investigation, the improvements to concrete construction were largely confined to studies of mixes, slump, consistency, vibration, form coatings and curing.

The principle that extraction of water from fresh concrete improves many of its qualities has been understood for a long time. For many years use has been made of this principle in the manufacture of ornamental concrete castings through the use of sand molds. A method was patented that had for its purpose densifying the surface of concrete floors by extracting part of the water through absorption. In this method a large sheet of burlap is spread over the freshly struck topping. On this burlap is spread to a depth of one inch a mixture of dry sand and cement. This mixture, which is highly absorptive, is allowed to remain on the surface until, in the judgment of the operator, sufficient water has been taken up (usually about 20 minutes). The burlap sheet is lifted vertically and removed from the surface just treated. The

mixture of damp sand and cement is then dumped into the mixer to be used as topping for the next section of the floor and the cycle repeated. This method of placing floor topping is claimed by the patentee to offer several advantages, among which are densification of the mixture through a reduction in the water cement ratio and a drying up or stiffening of the topping which permits earlier floating or troweling. It will be readily appreciated that this method is applicable only to horizontal surfaces or those having moderate slopes.

The patented vacuum process is another method of increasing the density and strength of concrete through a reduction of the water cement ratio after the concrete is placed. In this method a suction mat is generally placed in contact with the fresh concrete. Hoses connected to this mat lead to a vacuum pump which is used to create a near vacuum under the mat. The atmospheric pressure then helps to compact and force the excess water out of the concrete. The vacuum process, due to the addition of atmospheric pressure, is effective to a much greater depth than absorptive forms. This method is especially adapted to treatment of horizontal surfaces or those having slight slopes. The application of the vacuum process



Surface voids disclosed by stoning the surface of a laboratory specimen cast under a sloping wood form. These voids are often hidden by a thin film of cement and fine sand; do not show up when forms are stripped in ordinary field operations.

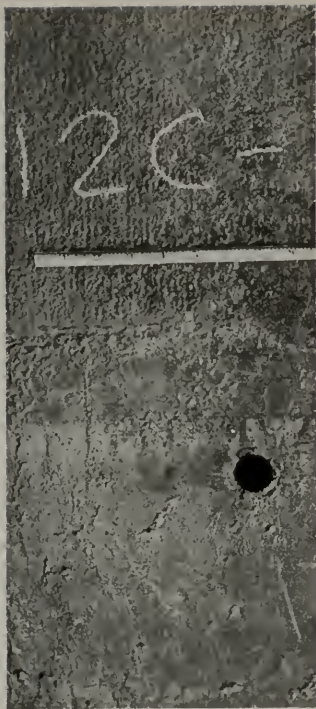

Field demonstration showing surface texture of concrete placed at Grand Coulee Dam test against absorptive lined forms at the top, as compared with concrete placed against wood forms, below.

to vertical faces or to steep slopes, while possible, is more difficult.

EARLY USES OF FORM LINING

The use of insulative board form lining in California antedates its use by the U. S. Bureau of Reclamation by several years. It was used in the construction of the California Fruit Growers Exchange in 1935. From an article by A. R. Walker of Walker and Eisen, architects, describing the construction of the California Fruit Growers Exchange, the following is quoted:

"The interior of the structure hardly offers material for comment other than the apparently successful experiment of using Celotex board for forming panels and stiles in the entrance lobby and foyer ceilings and walls. These forms were impregnated with a heavy filler of oil and the unusual texture developed a surface, after stripping, which did not require plaster and which has proven most interesting in the final finish. Plywood was used in forming the beam and panel ceilings in the Board Room, which will receive color decoration directly on the concrete."

An interesting application was in the entrance lobby, where a very large painting on canvas was framed by a wide concrete border formed by the rough sides of Celotex. Adjoining and contrasting with this was a surface cast against the smooth side of the Celotex.

A more recent application was in the construction of the Los Angeles Union Passenger Terminal. From a description of this construction the following is quoted: "Soft textured concrete walls were produced with Celotex-lined forms by a technique developed largely on this project." Close-up views of the texture accompanying the descriptive article referred to above indicate a beautiful soft texture free from visible surface voids. The Celotex used for lining of forms on the Los Angeles Union Passenger Terminal was given a thin brush coat of boiled linseed oil at least forty-eight hours before use.

It should be noted here that in the use of Celotex on both the Fruit Growers Exchange and the Los Angeles Union Passenger Terminal, the lining was oiled, which in all probability greatly reduced absorption of water, although absence of voids on the surfaces indicates that the forms did allow escape of some water and air.

It appears evident that prior to investigations carried out by the U. S. Bureau of Reclamation on absorptive form lining, this method was used solely to produce a pleasing texture and no attention was given to the possibility of improving the structure of the concrete at the surface. In fact, precautions were taken to prevent absorption because of the fear that the Celotex (a sugar cane fiber product) might, upon becoming partially saturated, permit a sugar solution to come in contact with the concrete surface, thereby inhibiting hardening. Later investigations indicate such fears were not justified. Extensive experimental studies carried out by the U. S. Bureau of Reclamation prove that the absorptive form lining free of oil or any other waterproofing media can be used with very little tendency toward sticking.

The Bureau's investigations were not undertaken with the idea of improving the texture of the concrete from an esthetic standpoint, but primarily to eliminate surface voids which af-

fect ed attrition on dam spillways. Their studies had not progressed far until attention was attracted to numerous other improvements in the quality of the concrete, resulting from the absorption of air and water by the porous fiber and pulp boards used as lining.

An abrasive test showed that slabs three inches thick cast in absorptive lined forms had much higher resistance than did the same concrete cast in wood forms.

In freezing and thawing tests 3x12x12-inch slabs cast in absorptive lined forms went through 100 cycles with no loss in weight, while the same concrete cast in wood forms showed 37 per cent loss after being subjected to only 60 cycles of freezing and thawing. A loss of 25 per cent is considered complete failure.

Similar slabs were placed outside on a window sill and each day their surfaces, while hot from the sun, had ice water poured upon them. The slab cast in wood forms showed extensive crazing, while the one cast in absorptive lined forms showed practically none.

Two slabs, one cast in wood forms, the other cast in absorptive lined forms, were sawed in two and the internal structure examined. The absorptive cast specimen appeared to be much denser, showed fewer voids, and less tendency to ravel under the saw. While improvement in quality appeared to extend to the center of the slab thickness a distance of 1½ inch from the face, the first quarter of an inch from the surface was exceptionally dense.

The densification of the surface of the concrete through absorptive form lining provides a simple method of improving many qualities of formed concrete that have not heretofore been available. This applies especially to concrete having faces vertical or nearly so.

ADVANTAGES OF ABSORPTIVE FORMS

For a basement wall cast in absorptive lined forms, much greater resistance to water passage would be expected than if the same concrete was cast in ordinary wood forms. Such concrete should also show greater resistance to alkali and most other forms of chemical attack.

Resistance to weathering is an important attribute of concrete cast in absorptive lined forms. Reduction in crazing is another highly gratifying characteristic.

The development of absorptive form lining that will produce numerous new textures free from all surface voids does not seem unreasonable, as a number of different textures are now available in existing boards that meet, or nearly meet, the specifications of the U. S. Bureau of Reclamation.

An order for 240,000 square feet of absorptive form lining has already been placed by the U. S. Bureau of Reclamation for use on the powerhouse of the Parker Dam in Arizona.

An order for 150,000 square feet of absorptive form lining is expected to be placed soon for use in the construction of the Friant Dam in California.

Included in the specifications for the absorptive lining are the following:

"The form lining shall be capable, through its absorptive capacity, of eliminating, to the extent hereinafter specified, voids, pits, and other common defects from the vertical surface of concrete placed against it. The form lining shall be highly absorptive to air and water and shall possess surface characteristics such as will result in a satisfactory surface texture of the hardened concrete and the minimum amount of sticking upon removal of the forms. The lining shall be readily adaptable to cutting, fitting, and any other operation necessary in connection with its use. The lining itself and any coating or treatment employed in its manufacture, shall be such as will not create discoloration or interfere with the normal chemical reactions of the cement in the concrete.

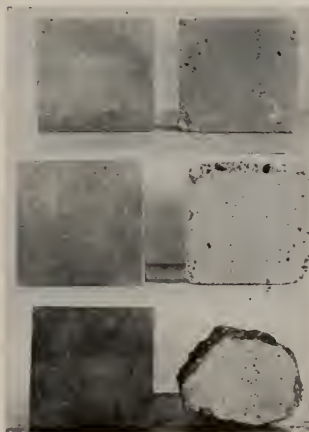

Durability resulting from absorptive lining on the forms of test specimens, subjected to freezing and thawing cycles. The specimen poured against ordinary wood forms (right) is shown after 10, 30 and 60 cycles resulting in 37% loss, while the block cast against absorptive forms (left) showed no loss in weight after similar treatment.

"The lining shall have sufficient resistance when wet and backed by a rigid wood form to withstand the pressure exerted by fresh concrete having a 4-in. slump and placed to a depth of 12 ft. without becoming deformed to such an extent as to mar the appearance of the finished concrete surface."

It does not seem unreasonable to expect that absorptive form lining will come into general use within the next few years and many engineers of wide experience believe it to be one of the most important developments in the placing of formed concrete since vibration was discovered.

Experiments carried out thus far have been on the basis of one use only of the form lining. There is, however, a distinct possibility that a form lining may be developed that can be used two or more times, which would provide a material saving in cost.

FORM LINING AND RELATIVE COST

Most of the Bureau's experiments have been conducted with boards of from one-fourth to one-half inch in thickness, the lower thickness being for boards of harder texture, while the softer textured boards were, in general, approximately one-half inch in thickness. These boards have considerable resistance to bending so that the form backing would not, on many types of work, have to be so tight or free from knot-holes and other defects as would be necessary if no absorptive lining were used. By using a lower grade of lumber some saving in the cost of backing might be effected that

would partially offset the additional cost of the absorptive form lining.

The absorptive form lining as now used undoubtedly produces an increase in the cost of forming. Since the cost of forming is generally a function of the contact surface area, it is readily seen that the cost for thin sections will increase the cost of concrete per cubic yard to a much greater extent than would be the case on heavier sections.

However, the extra cost of forming may in some cases result in a lower cost per cubic yard of concrete, since in most instances structures that would be stoned or ground would not require such treatment if absorptive forming was used. Suitable decorative effects could often be obtained by painting the interior surfaces of absorptive formed concrete in lieu of the conventional plaster coat, thereby effecting a considerable saving.

The introduction of vibration favorably affected many of the desirable qualities of concrete, but did not unfavorably affect one characteristic of the formed concrete, namely: formation of water and air voids on the formed surfaces. Vibration increased their size and number. These voids not only gave an unsightly appearance to the surface of formed concrete placed by vibration, but in some instances were the starting points of serious damage, especially on spillway surfaces subjected to high velocities. The absorptive form lining almost completely eliminates this objectionable feature so prevalent in formed vibrated surfaces. So far as is known, the absorptive form lining improves every desirable characteristic of concrete.

SUMMARY

In summarizing, it can be said that the advantages of absorptive form lining seem to be so great that any small additional cost should not hinder its adoption on all work where appearance, reduced absorption, lessened friction in hydraulic structures, greater resistance to abrasion, weathering and resistance to chemical attack are important factors.

It is also highly probable that continued research and the ingenuity of manufacturers will materially reduce the cost spread between the wood form and the absorptive lined form.

Glazing reduced by the use of absorptive lining, demonstrated in a test of laboratory specimens exposed to direct sun and daily dosed with ice water. Absorptive form specimen on the right and wood form on the left.

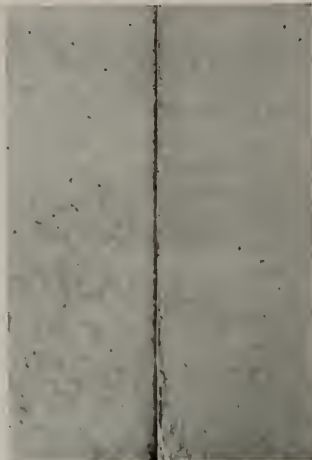

FLUORESCENT lighting for offices may be experimental, but it is an experiment that more and more people are trying out for themselves with more than merely promising results. Some of the insiders are saying that no new office building will be erected that is not air-conditioned and fluorescent lighted. You can take that or leave it—but fluorescent lighting, without much argument, is a development to be reckoned with in any future planning. Interest in the subject gives rise to many questions and the purpose of this memorandum is to supply some of the answers.

Dispensing with definitions and getting right to the subject, the principal advantages of fluorescent lighting are:

- (1) It is new, different, "modern."
- (2) It consumes less current (about 50 per cent).
- (3) It radiates less heat (only 25 per cent as much).
- (4) Lamps last longer, cutting labor costs for replacements.
- (5) Better quality of light, available in a variety of tones and colors.

The rated life is about three times as long (2000 vs. 750 hours) and it remains to be seen whether in actual performance the new lamp may not exceed expectations.

Against this impressive array of advantages, any one of which might be enough to insure wide usage, there is, of course, the element of cost. It should also be noted that for satisfactory results, you must have alternating current—a limitation, but hardly a disadvantage.

Classified as disadvantages are the following:

- (1) First costs are higher—and must be "amortized" to arrive at a proper basis of comparison.
- (2) Replacement costs (lamps) are also higher this being offset in part by longer life.

- (3) Less suitable for indirect illumination (for which there is, in fact, less need), but well adapted to semi-direct.
- (4) Limitations as to style of fixture, still in the development stage.
- (5) The obsolescence factor—having in mind that equipment installed today may be quickly outmoded by new models coming along.

The advantages are definite and permanent, and will probably be enhanced as fluorescent lighting comes into more general use—as it may do very rapidly. The disadvantages will undoubtedly diminish; costs will come down as production goes up; standardization will bring stability; and the resourcefulness of designers will find ways to adapt the new type of fixture to the special requirements of office layout and harmonious architectural effect.

Weighing drawbacks against incentives:

- (1) You can justify fluorescent lighting on a performance basis when you want—
 - (a) Light that is cool—a consideration where air conditioning is a factor.
 - (b) Daylight illumination—which has specialized use in shops.
 - (c) Lots of color—and it's really "produced"; heretofore, color has only been effected by the process of subtraction.
 - (d) Plenty of light—say, 50-foot candles—and that's where popular demand seems to be heading.
- (2) You can justify fluorescent lighting on a cost basis when you can amortize the initial expenditure, spreading it over a period—five or six years, perhaps—within which the saving in current will be sufficient to repay the investment.
- (3) It should be noted, however—
 - (a) That this depends on what you pay for current.
 - (b) When average cost gets into the lower brackets—two cents or less per KWH—there is little immediate saving to apply on amortization of fixtures.

Editor's Note: Because of the wide interest in Fluorescent Lighting, this article, giving the results of a special study of the subject by the National Association of Building Owners and Managers, is published as a supplement to Mr. Miller's excellent article in the August issue of *Architect & Engineer*.

(c) But assuming that the cost may be higher, there are still many features to recommend it, including such intangibles as distinction, advertising value, etc., not otherwise catalogued, plus the value of stepping out in front.

The first cost is quite an item; it may run eight to twenty times as much as ordinary equipment; and the cheaper your current, the more difficult the amortization becomes.

A working principle that has acquired some acceptance is that a foot candle, laid down on your desk, will cost about the same, whether fluorescent or incandescent lighting is used, over the period in which the installation costs are being written off. At the end of that time, the real saving will start, unless perchance, the improvements which have been effected make your equipment obsolete, in which event you may want to start over again. That's a chance you have to take!

Lamps come in lengths of four feet (40 watts), three feet (30 watts), two feet (20 watts), and one and one-half feet (15 watts). For practical purposes, the four-foot lamp is the one to consider; it's more economical. The reason for that is that each lamp must have an auxiliary device—you might call it a "starter"—to overcome the initial resistance; and this takes some current. The longer the lamp, the smaller proportion of extra wattage consumed.

The four-foot lamp until March 1 cost \$2.70; the three and two-foot lamps \$1.90; the one and one-half foot lamp \$1.15. They now cost about 15 per cent less because the demand has resulted in expansion of production schedules and reduction in manufacturing costs.

Two four-foot lamps, costing \$5.40 at the old prices will give out 4,000 lumens (units of light) assuming that the fixture is 100 per cent efficient. A 200-watt incandescent lamp, costing 30 cents, will give out 3,680 lumens, same assumption. The two fluorescents will consume 80 watts and, allowing 20 watts for the auxiliary equipment, will take 100 watts in all—as compared with the 200-watt consumption of the incandescent lamp.

The fluorescent lamps are placed in pairs to overcome what is called the stroboscopic effect—in plain English, flicker.

Carrying the mathematics further, the fluor-

escent two lamps in 2000 hours (roughly one year's normal service) will consume 200 kilowatt hours; the incandescent lamp requires two replacements and consumes 400 kilowatts.

Making adjustment for prevailing discounts on the purchase of both types of lamp, and also for the larger lumen out-put of the fluorescents, the saving of fluorescent illumination is 93 cents at a two cent rate; \$3.28 at a 3 cent rate; and \$5.63 at a 5 cent rate. With the recent reduction in lamp costs the saving will be \$1.62 at the 2 cent rate; \$3.97 at the 3 cent rate; and \$6.32 at the 4 cent rate.

If the fluorescent fixture costs \$40, and the incandescent fixture \$10, you can figure readily enough how many years it will take to write the difference off.

When it comes to fixtures, the problem is to adapt a much larger lamp to one's established ideas of proportion. Obviously, a four-foot tube, lighted the full length, requires different treatment from an incandescent bulb where the light proceeds from a very small filament.

The first attempts may have left something to be desired. Fixture makers rush in with all sorts of ideas. But gradually, as improved design emerges, the fluorescent lamp is becoming more adaptable to everyday use, particularly in the case of larger space units where high intensity—say 50-foot candles at desk level—is what you want.

The more conventional type of fixture is suspended from the ceiling, emitting direct illumination from below and indirect from above.

A less conventional type is recessed in the ceiling itself—"coffers" they call them—consisting of a series of lamp lanes flush with the ceiling, providing bands instead of spots of light to which we are accustomed. In the case of new construction, this would not be difficult to provide for. As a remodeling proposition, the result can be accomplished through the use of a drop ceiling which may provide for acoustical treatment at the same time.

The cost of fixtures is approximately \$5.00 per foot of lamp. That is to say, the two 4-foot lamps used in our previous illustration will give you a fixture cost of around \$40.00 which might compare, let us say, with a \$10 cost for an incandescent fixture.

THE ARCHITECT SPEAKS

(A brief account of the first four radio broadcasts sponsored by The State Association of California Architects, Northern Section, August 4, 11, 18 and 25, 1940.)

In a typical office now being equipped with fluorescent lighting, the equipment cost of installation and auxiliary equipment will approximate \$2,200, as against an estimated \$400 expenditure for a conventional (incandescent) installation. It is expected that this additional investment will be absorbed through savings in current and labor costs in four or five years. The producers have it figured that a fair amortization rate for a fluorescent installation is two per cent a month and this, as they work it out, will not only write off the original cost but will cover interest charges as well.

Members who have been experimenting with fluorescent lighting bring out some additional points, such as—

That improvements have been so rapid that one of these fixtures purchased today may become obsolete in a very short time; the benefits, however, being such that this obsolescence feature can, to a large extent, be ignored.

That a building selling electricity to tenants will find its unit cost going up, due to the fact that the tenants use less KWH, while the demand portion of the electric bill remains the same. It would take a considerable amount of fluorescent lighting, one member points out, before the monthly demand charge would be reduced.

In labor costs for replacements, the fluorescent lamp has distinct advantages due to longer life. In New York the average cost of replacing a 10-cent bulb in the subway is said to be 47 cents; we can't prove that, but it sounds plausible. In the Chicago subway, now under construction, fluorescent lighting is being given serious consideration.

Fluorescent lighting has been accepted by some owners as being especially effective for corridor and lobby illumination where continuous lighting is required. Less servicing is one important factor; more light and better utilization, combined with attractive appearance, are other factors.

The fluorescent lamp is the "glamour" product of the lighting industry; novelty—quite apart from efficiency and quality—has a psychological dollar-and-cents value. In the modernization of an existing building, or the construction of one, this distinctive factor merits serious consideration.

IN the first broadcast, introducing the Architect, the Announcer stated that at their Station, KSFO, they met almost all kinds of people and nearly all types of ideas, but they never before had met an Architect, and were vague about them. In their minds was a good deal of mystery about what the Architect is and how he works.

The Architect responded by saying that there is no mystery about architecture; it is familiar to all, but always new; people have lived in houses since before recorded history. He touched on historical highlights—the Egyptian Pyramids, the Parthenon, the Colosseum, the Cathedrals, the Renaissance, and our own Colonial and Mission periods. He described architecture as the art and science of building, something people have always known and lived with—to be thought of simply as Houses; sheltered space for living, work, play.

Houses are good or bad; planned to benefit from every natural advantage of site, arranged for comfort and convenience and happiness, honestly constructed, appropriate to the neighborhood; or, drab and cheerless, inappropriate to the surroundings, scrambled together by speculators from stock plans with false front and fancy trimmings, solely for profit on the purchase price.

The voice of a woman, day-dreaming, was heard expressing her desire for a nice house and garden, her discontent with rented quarters. She has looked at houses for sale, but those she likes are too expensive; she had been told that an Architect was an expensive luxury, only possible for rich people's mansions.

The Architect answered this dream voice, telling of his long, special training in ways to save money, advising about methods of building-finance, as a real friend to his client; of his only charge—a modest fee for services, no profit on real estate, materials or labor. He explained his status like that of a physician or lawyer, schooled and trained for his job, licensed by the State after a rigid examination, bound by a code of professional ethics; also that an Architect's services were not a luxury

but a necessity for protecting his client's interests and securing the maximum values in an investment which might well be the largest in a lifetime.

Next a young family was described by the Announcer—Tom, Helen and Tommy, Jr. Tom is in business with steady moderate salary, sick of paying rent for seven years with nothing to show but receipts. They want a house of their own to suit their needs and wishes and income, with a simple garden, a place they can feel to be Home.

First, Tom calls on the Architect, uncertain and suspicious. He gets interested in the photographs around the reception and drafting rooms (his own hobby is amateur photography) and likes especially some views of a small house built for a young family like his own. But he thinks it looks too high-priced. The Architect says that is because it has architectural character, not because it is costly, and tells the story of the house and his relationship with its owners, a process of establishing mutual confidence and satisfaction.

Then Tom brings his wife, Helen, to the office; on their way, passing rows of houses "no worse than what we're paying rent for," but Tom sees them in a new light.

Greetings over, the Architect tells Helen what his wife said before their own daughter came—"Architects are like baby-doctors. A woman wants to ask somebody all sorts of fool questions that are bothering her, and she realizes the baby-doctor is the right man, and when people start to build a home, an Architect's the same way."

So Tom and Helen tell what their income and their savings are, and what they pay for rent, and they find they can safely build the kind of home they supposed they could not afford, on a Government-protected single long-term loan, for a ten per cent down payment of the total cost, including lot, and with a smaller monthly

installment than their present rent. They begin to talk about plans, but are told the next step is to find a good neighborhood, near a good school and a shopping center, with adequate transportation facilities, sure of ample sunshine and a pleasant outlook, and taking due consideration of soil, drainage, water supply and other utilities, sewerage, street work, zoning and space restrictions, fire protection, and general future probabilities. Tom says, "You certainly do have to know a lot about lots."

It is decided that they go bargain hunting for good lots, and pick out five or six that interest them; and the Architect promises to inspect the various sites and give his advice accordingly.

Waiting to hear from Tom and Helen about the lots, the Architect tells the Announcer more about his job and about the complications involved in building any house, even a small one, which is even harder to design than a large one, with more money and land available. He describes the ready-made house and the stock plan, some of their weak points and concealed extra costs—both being intended for the "average family" when there is no such animal.

He hopes Tom and Helen can find a satisfactory lot so that he can start studying a plan to meet all the different problems of site, space requirements, budget and personality.

Each broadcast ended with an invitation to write "The Architect" in care of the station, asking any questions concerning building or remodeling—home, store, factory, ranch house, cabin, apartment house—giving type of building and approximate budget; and offering to send the name and address of an architect in the vicinity who specializes in that type—all with absolutely no obligation.

A mimeographed bulletin covering high lights of the broadcast will be sent free on request.

For better built-ins and finer walls always specify **PLYPANEL** THE CABINET GRADE OF DOUGLAS FIR PLYWOOD

These photographs of "The House in the Sun" show the amazing possibilities of Plypanel!



- Both the living room (left) and the dining room walls (above) are 3/8" Plypanel installed vertically and lightly stained. The ceilings are 1/4" Plywall. "The House in the Sun" was designed by Sumner Spaulding and built by Kersey Kinsey as a demonstration home in North Hollywood, California. It was furnished by Bullock's.

There is a grade and thickness of Plypanel for every need!

Plypanel is the grade of Douglas Fir Plywood made for cabinetwork, built-ins, substantial walls, fine paneling, furniture and similar uses where the finest appearance is desired.

Plypanel comes in three classifications: (1) Good 2 Sides (G2S) in which each face is a single veneer of 100% heartwood, free from defects. This type should be used for the highest quality interior work where both sides of the panel will be exposed to view and natural or light stain finishes used. (2) Good 1 Side (G1S) which has a good face and a sound back. This is the type to use for high quality walls and cabinets where only one side is exposed to view. (3) Sound 2 Sides (So. 2S) in which each face may be made up of one or more pieces of veneer, well-joined and reasonably matched for color and grain at joints. Each face of this type is equivalent in quality to face of the Plywall (wallboard) grade.

Plypanel is made in a variety of thicknesses and sizes. It conforms to strict requirements of U. S. Commercial Standard CS45-38 and is edge-branded with a distinctive Plypanel "grade trade-mark" to make specification and identification easy.



PLYPANEL D. F. P. A.

- The "Grade Trade-mark" above is stamped on the edge of every genuine Plypanel. For further information about Plypanel, consult Sweet's catalog or write Douglas Fir Plywood Assn., Tacoma Building, Tacoma, Wash., for free literature.

- The built-ins are naturally Plypanel. 3/8" Plywall was used for the ceiling and as a wall base for enameled hardboard.



**SPECIFY DOUGLAS FIR PLYWOOD
BY THESE "GRADE TRADE-MARKS"**

PLYPANEL D.F.P.A.

EXT.-D.F.P.A.



**DOUGLAS FIR
PLYWOOD**
Real Lumber
**MADE LARGER, LIGHTER
SPLIT-PROOF
STRONGER**



GARDEN WALL (BUILT OF CONCRETE GRID FORMS), NATIONAL GARDEN SHOW, GOLDEN GATE INTERNATIONAL EXPOSITION

BERKELEY FIRM OFFERS NEW METHOD OF CONCRETE CONSTRUCTION

WHEN anything genuinely new or different is offered the building industry the first question asked is "How about the cost?" When you induce a man (in this case we will say architect) to specify or use something new which is a substitute for something he has been accustomed to using with satisfactory results, he expects that substitute to be not only better but cheaper . . . otherwise he's content to let well enough alone. Which leads us to the subject matter of this article . . . something new, something better,

something more economical . . . Concrete Grid Forms for building construction.

The Concrete Grid Form is the assembly of two-ply wood panels in which there are a series of openings. The panels are assembled in one unit or cabinet by placing metal sleeves through the openings, which serve as cross-ties and spacers. These sleeves are adjusted to construct a wall from 3 to 8 inches thick. Reinforcing steel is placed within the form as required; the concrete is then poured. The apertures in the grid



DETAILS OF CIRCULAR GRID FORM ASSEMBLY



VIEW OF OFFICE SHOWING WALL TEXTURE

wall provide dead-air spaces for 54 per cent of the wall area. The insulating value of the wall may also be greatly increased by the use of light-weight aggregate in the concrete pour. This has further advantage of reducing weight by 33 per cent. Nails may be driven in as in wood. This gives ease of nailing in attaching stucco netting for plaster finish, door casements, cabinet work, etc. The door and window frames are set in the concrete grid form cabinet. The concrete is poured into the forms on the site. Their extreme simplicity, rigidity and ease of handling contribute even more to the economy of the method than does the saving of 40 to 50 per cent of the volume of concrete. There is also a saving of dead-weight of about 32 per cent with gains in economy, strength and durability.

The lattice design forms an architectural motif that architects will appreciate. Where used in partitions the design gives increased light to otherwise poorly lighted rooms. When filled with glass brick or sheet glass on both sides it gives insulation and diffused light.

Experts who have studied this new form of concrete construction describe it as a "NEW TOOL to increase better building." Its possibilities for low cost, good looking, fireproof homes are recognized. The house illustrated here is a typical example. Concrete for this four-and-one-half room dwelling was poured in just 12 hours, including sidewalls, partitions and roof. By the old method it would have taken at least 21 hours. Grid forms may be used for almost any type and modern of building. They are particularly adaptable to modern design.

Stressing upon some of its advantages, George A. Scott, head of the company that is handling Concrete Grid Forms, says:

"This concrete grid can be used in many ways. If it should be the frame of a residence or building you can cover the exterior with stucco and the interior with plaster, or other surfacing material as desired, in the same manner as you would cover a wood frame structure. As the openings are of a size to take standard brick, hollow tile (cement or clay), or can be closed with stabilized earth or adobe brick, wire mesh or sheet metal, or left open, walls built with this method will meet most every requirement. If the structure is to be a store or market building, a theatre or industrial building, warehouse, garage or shop, these openings can be closed with screen netting, glass or glass brick, clear opaque or in color. One can have the advantages of the artistry of the design in addition to any color effect desired, all at minimum cost.

"Any size form may be specified but the sizes generally used have round openings 9 inches in diameter and square openings 8 1/4 inches. Walls erected with these forms are, with proper reinforcing steel, practically indestructible and resistive to fire, earthquake and other hazards. Forms are set and the concrete is poured on location. All these factors contribute to a speedy and satisfactory completion of construction with a minimum of time and expense.

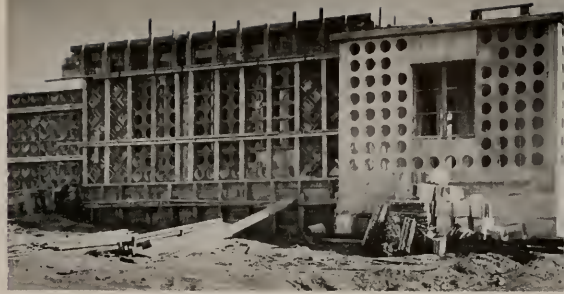

HOUSE FOR G. M. PIPER, WALNUT CREEK

On the right forms have been removed, leaving concrete framing ready for finish; left—Forms in place ready for pouring.



House completed; note pleasing architectural motif.



Patio view, showing interesting treatment of diamond "Grid Forms."

**PRESIDENT REPORTS GOOD YEAR
FOR THE STATE ASSOCIATION**

IN anticipation of the annual meeting of the State Association of California Architects at Del Monte next month, Ernest E. Weihe, president, has prepared the following resumé of 1940 accomplishments, sprinkled with words of optimism:

"The year 1939-40 has been a continuation of the general association practice as developed over the last ten or twelve years. A campaign of publicizing the architect was inaugurated by the Southern Section in the early part of the current year. The architect was put on the air. A radio broadcast program was conceived, written and produced over a Los Angeles network on Sunday mornings. The results in the way of inquiries and building prospects were very encouraging, especially in the residential field, and the broadcasts were made a regular weekly practice. The cost of the broadcasts was paid from special contributions by members of the Association. An impartial system of extending leads to individual architects was devised and considerable work is actually under construction as a result.

"The Northern Section of the Association, through its Public Relations Committee, followed the lead of the Southern Section and went on the air over a San Francisco network on the first Sunday in August and at present writing five broadcasts have been made. The cost of these broadcasts was paid from special subscriptions from architects of the Northern Section. The results in the way of leads is comparable to those of the Southern Section and while it is too soon to point to any buildings actually under way, the indications are encouraging.

"The various committees have been active. The Northern Section Legislative Committee has done especially good work in regard to the revision of the San Francisco professional license law.

"Delegates from both the Northern and Southern Sections to the A.I.A. National Convention at Louisville in May took active part in the debate on Institute amendments concerning unification of the State Associations with the Institute.

"Arrangements for joining with the Chapters of the A.I.A. in plans for the National Convention of the Institute to be held in California in 1941 are being formulated. The Convention committee for the Association Convention to be held at Del Monte in October is preparing an interesting business agenda as well as a social program. All members are urged to attend and participate in the discussions, especially in publicity matters. The Committee on Public Relations has some interesting matters to disclose.

"As President I wish to thank the membership for its co-operation and its response to the plans undertaken by the Executive Board. We have tried to make the past year a successful one for the profession and



ERNEST E. WEIHE
President State Association of California Architects

credit for any influence that the Association has had on affairs is due to its committeemen."

SOUTHERN CALIFORNIA CHAPTER

The sylvan setting of the Flintridge Riding Club proved a stimulating environment to the philosophically minded at the August meeting of S. C. C.

As usual, at gatherings of this type, no definite conclusions were reached, but it is just this sort of earnest consideration which keeps one sane and steadies our sense of perspective.

The summer meeting last year at the Trout Club has been referred to many times, comments a writer in the Chapter Bulletin for August. He continues: "It is good for us to stop and think once in a while and ask ourselves where we are going and why. Our solution of daily problems should have a theory behind it. We should all try to develop a definite philosophy whether we hold to the teachings of Chris Wren or F. L. Wright. Questions, particularly embarrassing questions, are good for the soul. Is my work up to a decent standard? Am I keeping pace with new developments? Which way am I going? Have I improved the quality of my work in the past few years?"

The social season, architecturally speaking, got under way with the Chapter meeting on September 10, held at the Clark Hotel.

Reports on the Institute Convention in Louisville last May were read by the following delegates: Pierpont Davis, William H. Harrison, Samuel E. Lundeen, Charles O. Matcham and Sylvanus B. Marston.

Also up for discussion was the proposed changes to the Chapter by-laws.

ARCHITECTS' BULLETIN

Issued For

THE STATE ASSOCIATION OF CALIFORNIA ARCHITECTS

Northern Section

STATE ASSOCIATION MEMBER
OF THE
AMERICAN INSTITUTE OF ARCHITECTS

Editor
Harris C. Allen

Address all communications for publication in the Bulletin to the Editor (Harris C. Allen) 557 Market Street, Room 218, San Francisco, California.

STATE ASSOCIATION OFFICERS

President.....Ernest E. Weihe, San Francisco
Vice-Pres.....Merrill W. Baird, Glendale
Secretary.....Robert H. Orr, Los Angeles
Treasurer.....Mario Ciampi, San Francisco

Regional Director—Southern Section
Gordon B. Kaufmann, Los Angeles

Regional Director—Northern Section
Harry M. Michelsen, San Francisco

Executive Board—Northern Section
Officers

President.....Ernest E. Weihe, San Francisco
V-Pres.....Frederick H. Reimers, Santa Barbara
Secretary.....Vincent Raney, San Francisco
Treasurer.....Mario Ciampi, San Francisco

Directors

Harold H. Weeks and Wayne Hertzka
(for one year)

Harry J. Davine and William C. Ambrose

Executive Board—Southern Section
Officers

President.....Merrill W. Baird, Glendale
Vice-Pres.....Winsor Soule, Santa Barbara
Secretary.....Robert H. Orr, Los Angeles
Treasurer... Sylvanus B. Marston, Los Angeles

Directors

A. M. Edelman, George D. Riddle
(for one year)

Sam W. Hammill and Ban H. O'Connor
(for two years)

Northern Section Advisory Council

San Francisco District:

Frederick H. Reimers (President)
J. K. Ballantine, Jr. (Secretary)
Harris C. Allen
Dodge A. Riedy
Ernest E. Weihe
Mario J. Ciampi
Conrad T. Kett
Roland I. Stringham
Wm. H. Knowles
Vincent Raney

North Bay:

J. C. Felciano

Lower San Joaquin:
H. G. Bissell

Santa Clara
Chaster Root

San Mateo:
Clyde Trudell

Upper Sacramento:
Casebolt Dakin

Sacramento:
Alfred Eichler

Upper San Joaquin:
David Horn

Monterey Bay:

Robert Stanton

Palo Alto:

Birga M. Clark

Marin:

Jas Bertenshaw

East Bay:

Irwin Johnson

Jas. H. Anderson

Ralph N. Kerr

Berkeley:

Gwynn Officer

Redwood Empire:

F. T. Georgeson

Lassen:

Ralph Taylor

Section Meeting

THE Northern Section Pre-Convention meeting was held in San Francisco August 15th with a fairly large attendance. It was devoted mainly to discussion of convention features, and the Radio Broadcast program which started August 3rd. For this architectural speaking out in public, there was universal praise and a hearty vote of approval. Several members expressed a wish that copies of the script might be available to architects, and the suggestion was made that a nominal charge be made to cover costs of printing and postage such as the ten cent charge for reports of the "Town Meeting of the Air." This will be considered.

The convention committee offered a tentative program for informative addresses and forums in addition to the business and social features. After many points of view were presented, the general consensus of opinion was that subjects of interest and information to the profession would be desirable, which were not readily available in regular practice, and which would not be tedious or "boring." It was recognized that the leading-string stage of the Association is well past, and that the important objective of better acquaintance among representatives of our far-flung profession is so well advanced now that the essential unity of the Association is assured. Therefore, the annual convention is naturally the place and time for considering subjects of general—and new—professional interest, in order to make attendance especially worth while.

In this period of transition, of change and development of new ideas as to design and construction, of new materials and methods, there is no dearth of topics suitable for consideration at such a gathering of architects.

The element of social enjoyment cannot be overlooked, for the friendships formed and cemented through our conventions have contributed vitally to the increasing solidarity of the Association through its twelve years of life. We surely could not get along now without the presence of our ladies—and the suggestion has been made that a Women's Auxiliary be organized along the lines of the Medical Association, and others, which have proved to be practical and helpful.

1940 CONVENTION

The tentative dates set for the Del Monte Convention are October 10th to 12th. Appointments were approved by the Executive Board as follows:

Reception and Registration—

Harold Weeks

Frederick Reimers

Harry Michelsen

Entertainment—

C. Jefferson Sly

Resolutions—

Wayne Hertzka

Finances—

Mario Ciampi

Golf—

Lester Hurd

Ladies—

Miss Elizabeth Boyter

Mrs. H. M. Michelsen.

The California Society of Architectural Draftsmen, and the San Francisco group of craftsmen entitled "Telesis" have been invited to attend.

UNIFICATION

The following excerpt from an AIA report is quoted from the "Octagon":

"The Board of Directors recognizes the splendid progress that is being made through the work of The Institute Committee on State Organization and commends the committee for its consistent efforts in forwarding the unification movement.

"There are now 19 out of 25 existing state associations affiliated or in the process of affiliation with The Institute. This progress has demonstrated that the unification of the profession presents a complex problem, involving certain questions as to the determination of proper procedures which, when followed, will lead to unanimity of agreement and action on the part of members of The Institute.

"In order that all of the elements of this problem and all of the varying views may be considered in the unification program, it is the recommendation of The Board that a new committee be created by the incoming Board, to be known as the 'Committee on Unification of the Profession,' which committee will be charged with the responsibility of continuing the development of the unification program, giving careful consideration to those problems which have arisen in the course of progress up to the present time and which will be more closely associated with progress from now on.

"To this end it is thought that any committee which may be appointed by the incoming Board to carry on the work of unification shall be guided by instructions issued by The Board or by The Executive Committee. Their studies should determine which states are prepared for state organization, and the chapters of a state should be consulted as to the need or desirability of a statewide organization before such organization is promoted."

ARCHITECTS' REGISTRATION

The 1939 and ninth report of the State Board of Examiners of Registration of Architects in Kentucky, contained the following several paragraphs which we believe worth printing for the benefit of our readers:

"The Court of Appeals of Kentucky has recently handed down a decision of far-reaching importance to the profession of architecture and the building industry at large.

"Kentucky's highest Court has ruled that: 'No one but a registered architect can collect fees for architectural services; no one but a registered architect can sign a valid contract for such services; and even if a non-registered person has plans prepared by a registered architect he can not deliver them to a client and have any valid grounds to collect fees for architectural services or sign a valid contract therefor.'"

The important latter part of this decision is perhaps the first time this point has been decided in any case directly connected with the profession of architecture.

The initial parts of the decision follow the general conclusions of all State and National Supreme Courts, upon the basis of which the Kentucky Board has continually cautioned both clients and potential offenders.

SAN FRANCISCO LICENSE FEE

Fred Reimers, President of the San Francisco Society of Architects, reports that the proposed License Fee legislation (for revenue) has finally failed of passage and architects are relieved of this burden—for which they would have received no return in protection or regulation.

REVIEWS OF NEW BOOKS

By E. N. KIERULFF

"**Graven Image,**" by John Farleigh; The Macmillan Company, 60 Fifth Avenue, New York; price, \$3.75.

This is one of those cases when one asks the question, "When is a text book not a text book?" and receives the answer. That answer will be most obvious to all who read this fascinating book. The author is an artist. His work is known through his illustrations found in Bernard Shaw's "Black Girl in Search of God," and in some of the works of D. H. Lawrence. In this present book Mr. Farleigh has undertaken to write an informative text book and a charming autobiography and has accomplished both admirably. The book should have a great appeal to the general reader and to the student of art.

"**Modern Architectural Design,**" by Howard Robertson; Chemical Publishing Company, 148 Lafayette Street, New York; price, \$6.00.

This is a companion book to the author's "Principles of Architectural Composition." In this case he treats of the detail aspects of design, especially from the standpoint of modern movement; a sane and stimulating analysis of the current problems of architectural design, accompanied by many illustrations.

"**Shop Fronts,**" by Frederick Chatterton; Chemical Publishing Company, 148 Lafayette Street, New York; price, \$4.25.

The author is an English architectural writer of ability who has to his credit as living contributions to the profession such books as "English Architecture at a Glance" and "Houses, Cottages and Bungalows." Was editor of "Specification" and, lastly, wrote "Who's Who in Architecture." "Shop Fronts" presents one of today's vital problems which the modern architect is called upon to solve. That is the combination of a high standard of design with the practical needs of his client. The book demonstrates the results attained in England and abroad and provides suggestions of widely differing character and requirements.

With the Architects

OAKLAND RESIDENCE

Clarence W. W. Mayhew, 71 Montgomery Street, San Francisco, has completed working drawings for a two story frame and brick veneer residence of seven rooms and two baths, for Dr. Sciutto, in Claremont Pines, Oakland. The improvements will cost \$12,500.

The same architect has completed plans for remodeling the home of an unnamed client at 2330 Jackson Street, San Francisco.

ADDITION TO FIRE HOUSE

From plans by E. Keith Narbett of Richmond a contract has been let for a one story addition to the Walnut Creek fire station. Basalite blocks will be used in the wall construction.

The same architect has awarded an \$18,000 contract for a Basalite auto sales and service building at 25th and Macdonald Avenue, Richmond.

HANGAR AND OFFICE BUILDING

The office of W. D. Peugh, 333 Montgomery Street, San Francisco, is at work on plans for a hangar and office building for the City of San Francisco and which will be leased to the United Air Lines. The two structures will be located at Mills Field, San Mateo County, and will be constructed of steel, corrugated iron and wood frame. The estimated cost is \$350,000.

CONCORD SHOP BUILDING

The office of Harold H. Weeks in San Francisco is preparing preliminary plans for a one story reinforced concrete shop building at Concord for the Mt. Diablo Union High School District. The improvement will cost \$28,000. Bids for a music building at Antioch have been rejected.

PALO ALTO SCHOOL ADDITION

A \$50,000 addition to the Ravenswood Grammar School at Palo Alto is to be built from plans by Dole F. Thomson, 179 Lincoln Avenue, Palo Alto. There will be four class rooms, library and cafeteria. Construction will be one story frame, with plywood exterior.

HERBERT GOODPASTOR BUSY

New work in the office of Herbert Goodpastor, Mitau Building, Sacramento, includes a \$15,000 drive-in market at Grass Valley; addition to the Alta Grammar School, near Auburn, Placer County; and a \$7,000 residence at Walnut Grove.

COURT HOUSE ANNEX

Preliminary drawings are in progress for a one story reinforced concrete annex to the San Mateo County court house at Redwood City. W. H. Toepke, Call Building, San Francisco, is the architect.

PERSONALS

Edwin N. Snyder, architect of Berkeley, is building at Carmel and plans to make his home there at a later date. He recently sold his attractive Berkeley home.

* * *

B. H. Todd resumed his architectural practice as associate with William G. Brust, 732 Republic Building, Seattle, Wash.

* * *

Messrs. John Graham of Graham and Painter, Dexter Horton Building, and B. Marcus Priteca, Palyomar Building, Seattle, have been selected as the architectural board to prepare plans for 200 low-cost dwellings at the Sand Point Naval Air Station.

* * *

Alfred W. Rea and Charles E. Garstang have moved from 215 West Sixth Street to 227 Bradbury Building, Third Street and Broadway, Los Angeles.

* * *

Howard Schroder has reopened an office at 1221 Glendon Avenue, West Los Angeles, and will be pleased to receive catalogs, trade literature and building material samples.

* * *

Charles E. Perry has resumed the practice of architecture with offices at 514 Marin Street, Vallejo. Manufacturers' catalogs and data are desired.

BECOMES SOCIETY MEMBER

Lester Lee Jones, an architect who recently arrived from Denver, Colorado, and started the practice of his profession in Seattle, has been admitted to membership in the Washington State Society of Architects. Mr. Jones is a former chairman of the Colorado State Board of Architect Examiners.

SAN MATEO DWELLINGS

J. K. Ballantine, Jr., 137 Harlan Place, Los Angeles, has completed drawings for two speculative houses to be built in San Mateo at an estimated cost of \$5,000 each.

HIGH SCHOOL BUILDING

Plans have been completed and bids taken for the construction of an \$85,000 ten-class-room building at Clarksburg, Yolo County. Construction will be frame and brick veneer.

RESIDENCE AND MUSIC STUDIO

Birge M. and David Clark of Palo Alto have working plans in progress for a \$12,000 music studio at Atherton and plans have been completed by the same architects for a \$7,500 residence for Mrs. Margaret C. Hoover in Palo Alto.

MODERNIZED PRODUCTS

Brief Notes on New Materials and Equipment in the Building Industry.

436. SHOVELS

Shovel Supply Company has issued a brochure depicting several pieces of their new equipment. These items of machinery for road, pavement and park work are time and money savers to the general contractor who specializes in city street work or highway repair. Send for a copy. Use the coupon below.

437. ELECTRICAL EQUIPMENT

Western Electric Company has a booklet called "Pick-Ups" devoted to some of its newest electrical equipment. Excellent illustrations and an interesting text make an attractive display.

438. COPPER AND BRASS

Revere Copper and Brass Company's latest booklet, "The House You Live In," is one of the likeliest booklets we have seen in some time. The illustrations are worthy of an even better setting. The book sets forth uses of this company's brass and copper products. Send for a copy.

439. ANOTHER BOOKLET

The same company have another issue this month—a broadside giving a full list of all their products, and quite a formidable list it is. There are sure to be things which will be of interest to the members of the profession in this excellent reference sheet. The coupon will bring you a copy post haste.

440. GLASS

Pittsburgh Plate Glass Company have a brand new booklet which tells the story of the products of this company, one of the leading glass and paint manufacturers in the nation. The booklet is quite complete and has illustrations to relieve the text.

441. PAINT

Bedard and Morency Mill Company are illustrating their Chemical and Ceramic fireproof and water-proof paint in a small broadside giving the important facts and directions for the application of a truly remarkable paint. Send for this interesting literature.

442. SOUND-PROOFING

The Celotex Corporation's "Quiet Forum," the diminutive magazine which this company has been issuing, is an interesting number. In it can be found details concerning the sound-proofing put out by Celotex. The coupon will bring you a copy.

443. SHELVING

The General Fireproofing Company has a new folder which has for a title the rather interesting "Make Today's Shelving Fit Tomorrow's Product." This should prove to be a piece of literature worth filing for reference.

444. VALVES

McDonnell & Miller Company have issued a condensed catalogue and price list. Here will be found also pertinent data relative to this company's products—valves, water level controls and like equipment. Send for a copy by using the coupon below.

445. WATCHMAN'S KEY

Dudley Lock Corporation announces a new product in a simple broadside. It is "Tour Key System," designed for the night watchman in making his nightly rounds of inspection. This new product is fully described in the broadside.

446. OIL BURNER

A low pressure oil burner for fully enclosed jobs is illustrated in a broadside put out by the Hart Oil Burner Corporation. We have this coupon for your convenience in obtaining detailed information.

447. CARPET BINDING

The Wheeler-Kight & Gainey Advertising Agency are distributing a news release for a client on a carpet binding. It is designed to hold the ends of runners flat and is a new departure in carpet binding. The coupon will bring you this literature.

448. PROTRACTOR RULE

The new Hahn Protractor Rule is an item of interest to members of the profession. This new instrument has many points which will make it worthy of consideration. Details are being distributed by the agency for the company—Kennedy & Company—advertising.



REG. U. S. PAT. OFF.

**"More than a
building paper"**

THE SISALKRAFT CO.
205 West Wacker Drive
(Canal Station) Chicago, Ill.
55 New Montgomery Street
San Francisco, Calif.

FREE FOR THE ASKING

Check items on coupon, paste on letter head or postal card, and mail to Architect and Engineer.

Architect and Engineer 68 Post Street San Francisco, Calif.	
Please send me literature on the following items as checked below. This request places me under no obligation.	
436 <input type="checkbox"/>	442 <input type="checkbox"/>
437 <input type="checkbox"/>	443 <input type="checkbox"/>
438 <input type="checkbox"/>	444 <input type="checkbox"/>
439 <input type="checkbox"/>	445 <input type="checkbox"/>
440 <input type="checkbox"/>	446 <input type="checkbox"/>
441 <input type="checkbox"/>	447 <input type="checkbox"/>
448 <input type="checkbox"/>	
My Name.....	
Name of Company.....	
Street.....	
City..... State.....	

Estimator's Guide

Giving Cost of Building Materials, Wage Scale, Etc.

Amounts given are figuring prices and are made up from average quotations furnished by material houses to San Francisco contractors. 3% Sales Tax on all materials but not labor.

All prices and wages quoted are for San Francisco and the Bay District. There may be slight fluctuation of prices in the interior and southern part of the state. Freight cartage, at least, must be added in figuring country work.

Bond—1 1/2% amount of contract.

Brickwork—

Common, \$40 to \$45 per 1000 laid, (according to class of work).
 Face, \$90 to \$100 per 1000 laid, (according to class of work).
 Brick Steps, using pressed brick, \$1.00 lin. ft.
 Brick Veneer on frame buildings, \$0.70 sq. ft.
 Common f.o.b. cars, \$14.00 at yard. Cartage extra.
 Face, f.o.b. cars, \$45.00 to \$50.00 per 1000, carload lots.

HOLLOW TILE FIREPROOFING (f.o.b. job)

3x12x12 in. \$ 84.00 per M
 4x12x12 in. 94.50 per M
 6x12x12 in. 126.00 per M

Building Paper—

1 ply per 1000 ft. roll \$3.50
 2 ply per 1000 ft. roll 5.00
 3 ply per 1000 ft. roll 6.25
 Sphalerite, 500 ft. roll 5.00
 Sash cord com. No. 7 \$1.20 per 100 ft
 Sash cord com. No. 8 1.50 per 100 ft
 Sash cord spot No. 7 1.90 per 100 ft
 Sash cord spot No. 8 2.25 per 100 ft
 Sash weights cast iron, \$50.00 ton.
 Nails, \$3.50 base.
 Sash weights, \$45 per ton.

Concrete Aggregates—

Gravel (all sizes) \$1.45 per ton at bunker; delivered to any point in S. F. County \$1.85.

	Bunker	Delivered
Top sand	\$1.45	\$1.85
Concrete mix	1.45	1.85
Crushed rock, 3/4 to 3/4	1.60	2.00
Crushed rock, 3/4 to 1 1/2	1.60	2.00
Roofing gravel	1.60	2.00
City gravel	1.45	1.85
River sand	1.50	1.90

 Delivered bank sand—\$1.00 per cubic yard at bunker or delivered.

SAND—

	Bunker	Delivered
River sand	\$1.50	\$1.90
Lapis (Nos. 2 & 4)	2.00	2.40
Olympia Nos. 1 & 2	1.80	2.20
Healdsburg plaster sand	\$1.80 and \$2.20	
Del Monte white	30c	per sack

CEMENT (all brands, common, cloth sacks) \$2.72 per bbl. f.o.b. car; deliv. \$2.90 per bbl., carload lots; less than carload lots, warehouse or deliv. 80c per sack. (Less 10c per sack returned, 2% 10th Prox.)

Common cement (all brands, paper sacks) carload lots \$2.52 per bbl. f.o.b. car; delivered, \$2.70; less than carload delivered, 75c per sack. Discount on cloth sacks, 10c per sack. Cash discount on carload lots, 10c a barrel, 10th Prox.; cash discount less than carload lots, 2%.

Atlas White } 1 to 100 sacks, \$2.00 sack,
 Calaveras White } warehouse or delivery;
 Medusa White }

Forms, Labors average \$40.00 per M.
 Average cost of concrete in place, exclusive of forms, 35c per cu. ft.; with forms, 60c.
 4-inch concrete basement floor 12 1/2c to 14c per sq. ft.
 Rat-proofing 7 1/2c
 Concrete Steps \$1.25 per lin. ft.

Dampproofing and Waterproofing—

Two-coat work, 20c per yard.
 Membrane waterproofing—4 layers of saturated felt, \$4.50 per square.
 Hot coating work, \$1.80 per square.
 Medusa Waterproofing, 15c per lb., San Francisco Warehouse.
 Tricocel waterproofing.
 (See representative.)

Electric Wiring—\$12.00 to \$15.00 per outlet for conduit work (including switches). Knob and tube average \$3.50 per outlet.

Elevators—

Prices vary according to capacity, speed and type. Consult elevator companies. Average cost of installing an automatic elevator in four-story building, \$2800; direct automatic, about \$2700.

Excavation—

Sand, 60 cents; clay or shale \$1 per yard. Teams, \$12.00 per day.
 Trucks, \$22 to \$27.50 per day.
 Above figures are an average without water. Steam shovel work in large quantities, less; hard material, such as rock, will run considerably more.

Fire Escapes—

Ten-foot galvanized iron balcony, with stairs, \$115 installed on new buildings; \$140 on old buildings.

Floors—

Composition Floors—22c to 40c per sq. ft. In large quantities, 16c per sq. ft. laid.
Mosaic Floors—80c per sq. ft.
Duraflex Floor—23c to 30c sq. ft.
Rubber Tile—50c to 75c per sq. ft.
Terazzo Floors—45c to 60c per sq. ft.
Terazzo Steps—\$1.60 lin. ft.

Hardwood Flooring (delivered to building)—

	1 1/2x2 1/4" T&G	3/4x2" T&G	3/4x2" Sq. Ed.
Cir. Qtd. Oak	\$144.00 M	\$122.00 M	\$141.00 M
Sel. Qtd. Oak	118.00 M	101.00 M	114.00 M
Cir. Pla. Oak	120.00 M	102.00 M	115.00 M
Sel. Pla. Oak	113.00 M	92.00 M	107.00 M
Cir. Maple	125.00 M	113.00 M	

 Wage—Floor layers, \$10.00.
 Note—Above quotations are all board measure except last column which is sq. ft.

Glass (consult with manufacturers)—

Double strength window glass, 20c per square foot.
 Plate 75c per square foot (unglazed) in place, \$1.00.
 Art, \$1.00 up per square foot.
 Wire (for skylights), 40c per sq. foot.
 Obscure glass, 30c to 50c square foot.
 Glass bricks, \$2.40 per sq. ft., in place.
 Note—If not stipulated add extra for setting.

Heating—

Average, \$1.90 per sq. ft. of radiation, according to conditions.
 Warm air (gravity) average \$48 per register.
 Forced air, average \$68 per register.

Iron—Cost of ornamental iron, cast iron, etc., depends on designs.

Lumber (prices delivered to bldg. site).

No. 1 common	\$30.00 per M
No. 2 common	28.00 per M
Select O. P. common	35.00 per M
2x4 No. 3 form lumber	22.00 per M
1x4 No. 2 flooring VG	58.00 per M
1x4 No. 3 flooring VG	51.00 per M
1x6 No. 2 flooring VG	70.00 per M
1 1/2x4 and 6, No. 2 flooring	70.00 per M

Slash grain—

1x4 No. 2 flooring	\$45.00 per M
1x4 No. 3 flooring	42.00 per M
No. 1 common run T. & G.	33.00 per M

Lath 5.50 per M
 Shingles (add cartage to price quoted)—
 Redwood, No. 1 \$1.10 per bble.
 Red Cedar 1.10 per bble.

Plywood—Douglas Fir (ad cartage)—

"Plyscord" sheathing (unsanded)
 5/16" 3-ply 48"x96" \$32.50 per M
 "Plywall" (wallboard grade)—
 1/4" 3-ply 48"x96" \$37.50 per M
 "Plyform" (concrete form grade)—
 5/8" 5-ply 48"x96" \$110.00 per M
 Exterior Plywood Siding—
 7/16" 5-ply Fir \$9.00 per M
 Redwood (Rustic) 8.90 per M

Millwork—Standard.

O. P. \$85.00 per 1000. R. W., \$100.00 per 1000 (delivered).
 Double hung box window frames, average with trim, \$6.50 and up, each.
 Doors, including trim (single panel, 1 3/4 in. Oregon pine) \$8.00 and up, each.
 Doors, including trim (five panel, 1 3/8 in. Oregon pine) \$6.00 each.
 Screen doors, \$3.50 each.
 Patent screen windows, 25c e sq. ft.
 Cases for kitchen pantries seven ft. high per lineal ft., \$8.00 each.
 Dining room cases, \$8.00 per lineal foot. Rough and finish about 75c per sq. ft.
 Labor—Rough carpentry, warehouse heavy framing (average), \$17.50 per M.
 For smaller work average, \$35.00 to \$45.00 per 1000.

Merble—(See Dealers)

Painting—

Two-coat work	per yard	42c
Three-coat work	per yard	60c
Cold water painting.....	per yard	10c
Whitewashing	per yard	4c
Turpentine, 65c per gal., in 5 gal. cans. and 55c per gal. in drums.		
Raw Linseed Oil—95c gal. in light drums.		
Boiled Linseed Oil—98c gal. in drums and \$1.08 in 5 gal. cans.		

White Lead in oil

	Per Lb.	
1 ton lots, 100 lbs. net weight.....	113/4c	
500 lbs. and less than 1 ton.....	12c	
Less than 500 lb. lots.....	12/2c	

Red Lead and litharge

1 ton lots, 100 lbs. net weight.....	113/4c
500 lbs. and less than 1 ton.....	12c
Less than 500 lb. lots.....	12/2c

Red Lead in oil

1 ton lots, 100 lbs. net weight.....	123/4c
500 lbs. and less than 1 ton.....	13c
Less than 500 lb. lots.....	13/2c

Note—Accessibility and conditions cause some variance in costs.

Patent Chimneys—

6-inch	\$1.25 lineal foot
8-inch	1.75 lineal foot
10-inch	2.25 lineal foot
12-inch	3.00 lineal foot

Plastering—Interior—

	Yard
1 coat, brown mortar only, wood lath	\$0.50
2 coats, lime mortar hard finish, wood lath	.85
2 coats, hard wall plaster, wood lath.....	.72
3 coats, metal lath and plaster.....	1.25
Keene cement on metal lath.....	1.30
Ceilings with 3/4 hot roll channels metal lath (lathed only).....	.90
Ceilings with 3/4 hot roll channels metal lath plastered.....	1.80
Single partition 3/4 channel lath 1 side (lath only).....	.85
Single partition 3/4 channel lath 2 inches thick plastered.....	\$2.90
4-inch double partition 3/4 channel lath 2 sides (lath only).....	1.70

4-inch double partition 3/4 channel lath 2 sides plastered.....	3.30
Thermax single partition; 1" channels; 2 1/4" overall partition width. Plastered both sides.....	2.50
Thermax double partition; 1" channels; 4 1/2" overall partition width. Plastered both sides.....	3.40
3 coats over 1" Thermax nailed to one side wood studs or joists.....	1.25
3 coats over 1" Thermax suspended to one side wood studs with spring sound isolation clip.....	1.45

Plastering—Exterior—

	Yard
2 coats cement finish, brick or concrete wall.....	\$1.00
3 coats cement finish, No. 18 gauge wire mesh.....	1.50
Wood lath; \$5.50 to \$6.50 per 1000.....	
2.5-lb. metal lath (dipped).....	.19
2.5-lb. metal lath (galvanized).....	.21
3.4-lb. metal lath (dipped).....	.22
3.4-lb. metal lath (galvanized).....	.24
3/4-inch hot roll channels, \$2 per ton.....	
Finish plaster, \$18.90 ton; in paper sacks. Dealer's commission, \$1.00 off above quotations. \$13.85 (rebate 10c sack).	
Lime, 1-cb. warehouse, \$2.25 bbl.; cars, \$2.15	
Lime, bulk (ton 2000 lbs.), \$16.00 ton.	
Wall Board 5 ply, \$50.00 per M.	
Hydrate Lime, \$19.50 ton.	
Plasterers Wage Scale.....	\$1.67 per hour
Lathers' Wage Scale.....	1.60 per hour
Hod Carriers Wage Scale.....	1.40 per hour

Composition Stucco—\$1.80 to \$2.00 sq. yard (lathless).

Plumbing—

From \$70.00 per fixture up, according to grade quantity and runs.

Roofing—

"Standard" tar and gravel, \$6.00 per sq. for 30 sqs. or over.	
Less than 30 sqs. \$6.50 per sq.	
Tile, \$20.00 to \$35.00 per square.	
Redwood Shingles, \$7.50 per square in place.	
Cooper, \$16.50 to \$18.00 per sq. in place.	
5/2 #1-16" Cedar Shingles, 4 1/2" Exposure.....	8.00 Square
5/8 x 16" — #1 Cedar Shingles, 5" Exposure.....	9.00 Square
4/2 #1-24" Royal Shingles, 7 1/2" Exposure.....	9.50 Square
Re-coat with Gravel, \$3 per sq.	
Asbestos Shingles, \$15 to \$25 per sq. laid.	

Slate from \$25.00 per sq., according to color and thickness.	
1/2 x 25" Resawn Cedar Shakes, 10" Exposure.....	10.50
3/4 x 25" Resawn Cedar Shakes, 10" Exposure.....	11.50
1 x 25" Resawn Cedar Shakes, 10" Exposure.....	12.50

Above prices are for shakes in place.

Sheet Metal—

Windows—Metal, \$1.75 a sq. foot. Fire doors (average), including hardware \$1.75 per sq. ft.

Skylights—(not glazed)

Copper, 90c sq. ft. (flat). Galvanized iron, 30c sq. ft. (flat). Vented hip skylights 60c sq. ft.

Steel—Structural

\$120 ton (erected), this quotation is an average for comparatively small quantities. Light truss work higher. Plain beams and column work in large quantities \$97 to \$105 per ton.

Steel Reinforcing—

\$80.00 to \$120.00 per ton, set.

Stone—

Granite, average, \$6.50 cu. foot in place Sandstone, average Blue, \$4.00, Boise \$3.00 sq. ft. in place. Indiana Limestone, \$2.80 per sq. ft. in place.

Store Fronts—

Copper sash bars for store fronts, corner center and around sides, will average 75c per lineal foot. Note—Consult with agents.

Tile—Floor, Wainscot, etc.— (See Dealers)

Asphalt Tile—18c to 28c per sq. ft. installed.

Wall Tile—

Glazed Terra Cotta Wall Units (single faced) laid in place—approximate prices: 2 x 6 x 12..... \$1.00 so. ft. 4 x 6 x 12..... 1.15 so. ft. 2 x 8 x 16..... 1.10 sq. ft. 4 x 8 x 16..... 1.30 so. ft.

Venetian Blinds—

40c per square foot and up. Installation extra.

SAN FRANCISCO BUILDING TRADES WAGE SCALES

All crafts 8 hour day (except as otherwise noted) and 5 day week. Effective as of May 1, 1940.

CRAFT	Journeymen Mechanics	CRAFT	Journeymen Mechanics	CRAFT	Journeymen Mechanics
Asbestos Workers	\$10.00	Millwrights	10.00	\$Dump Truck Drivers, 3 yards	7.50
*Bricklayers	10.50	Mosaic and Terrazzo Workers	8.00	\$Dump Truck Drivers, 4 yards	8.00
*Bricklayers' Hodcarriers	7.50	†Painters	8.75	\$Dump Truck Drivers, 5 yards	8.00
Cabinet Workers (outside)	10.00	Pile Drivers and Wharf Builders	11.20	\$Dump Truck Drivers, 6 yards	8.50
Caisson Workers (Open)	8.80	Pile Drivers Engineers	12.80	Truck Drivers of Concrete Mixer	
Carpenters	10.00	*Plasterers	10.00	Trucks:	
Cement Finishers	10.00	*Plasterers (Hodcarriers)	8.40	2 yards or less	8.00
Electricians	11.00	Plumbers	11.20	3 yards	8.57
Elevator Constructors	12.00	Roofers	9.68	4 and 5 yards	9.14
Engineers (Portable and Hoisting)	10.00	Sheet Metal Workers	10.00	6 yards	9.71
Glass Workers	9.68	Sprinkler Fitters	11.00		
‡Housesmiths, Ornamental Iron (Shop and Outside)	10.00	Steamfitters	11.00		
Housesmiths, Reinf. or Rodmen	10.50	Stair Builders	11.00		
Ironworkers (Bridge and Structural—Engineers)	12.80	Stone Cutters	9.00		
Laborers (Building and Common)	6.50	*Stone Setters	10.50		
*Lathers	9.60	Tile Setters	11.00		
Marble Setters	10.50	Welders, Structural Steel Frame on Buildings	12.80		
		\$Dump Truck Drivers, 2 yards or less	7.00		

EXPLANATION:

*—6 Hour Day.
 †—7 Hour Day.
 ‡—Term "Architectural Iron" no longer used. This craft "Ornamental Ironworker."
 \$—Dump Truck Drivers work 7 HOURS ON PUBLIC WORK, 8 HOURS ON PRIVATE WORK; starting time 7:30 A.M.

J. HARRY BLOHME

J. Harry Blohme, who practiced many years in San Francisco as junior member of the firm of Ward and Blohme (Clarence R. Ward) died suddenly of a heart attack in the railroad station at Reno, August 15. He had gone to Nevada in connection with a commission to design a new gymnasium at the State University.

Mr. Blohme at one time was a frequent entrant in architectural competitions which brought him wide recognition. His private commissions included the Dreamland Rink in San Francisco, the Stanford University Chapel, Alaska Commercial Building and the Machinery Building at the 1915 World's Fair.

Mr. Blohme was a Fellow of the American Institute of Architects and a former member of the California State Board of Architectural Examiners.

SILAS R. BURNS

Silas Reese Burns, for 33 years a resident of Southern California and for more than 25 years partner in the architectural firm of Hunt & Burns, of Los Angeles, died at his home, 400 E. Hermosa Drive, San Gabriel, August 10.

Associated with the late Sumner Hunt he was architect for many important structures in Los Angeles and vicinity, including the southwest Museum, Children's Hospital, administration building of Scripps College at Pomona, Los Angeles and Wilshire Country Clubs, Automobile Club of Southern California and a number of Los Angeles school buildings.



*Maharajah's Mansion
or Caretaker's Cottage*

**SPECIFY PAYNE - ENGINEERED
EQUIPMENT FOR EVERY HOUSE
HEATING PROBLEM**



In the Santa Ana home of the Maharajah of Indore are combined the richest of furnishings with the finest of construction and equipment, including fully automatic, vented, PAYNE gas-fired furnaces. ★ While PAYNE-HEAT is specified for many fine homes, there are sizes and styles for any house, any budget. ★ If you haven't reviewed the PAYNE lineup of reliable furnaces lately, write us for convenient file of heating information.

PAYNEHEAT *Payne* FURNACE
& SUPPLY CO., INC.
BEVERLY HILLS • CALIFORNIA

No Worry for the Architect

*"—All acid proof drain pipe and fittings
shall be ferro-silicon—CORROSIRON—"*

(Write for above specification)



FEDERAL BUILDING • CIVIC CENTER • SAN FRANCISCO

Arthur Brown, Jr., Architect

CORROSIRON DRAIN LINES and FITTINGS
and LABORATORY EQUIPMENT was specified because of its superior resistance to corrosion and wear.

Pacific Foundry Company, Ltd.

NEW YORK • 3100 NINETEENTH ST., SAN FRANCISCO • LOS ANGELES



California's Hotel Beautiful

—like a country estate
yet in the heart of a throbbing
metropolitan area.
—a matchless view—
comfortable, luxuriously furnished
rooms, excellent cuisine.
—in an atmosphere of quiet
and gracious living.

Rooms, with bath, \$2.50 to \$5.00 per day.

Attractive monthly rates

HOTEL CLAREMONT • BERKELEY

ACOUSTI-CELOTEX

for office-quieting provides . . .

- PAINTABILITY
- PERMANENT LIGHT-REFLECTION
- HIGH EFFICIENCY

Acoustical Engineers & Contractors

WESTERN ASBESTOS CO.
Building Materials *Mechanical Specialties*
SACRAMENTO OAKLAND
SAN FRANCISCO

POMONA TILES

FOR
Bathrooms and Kitchens
in over 60 colors

Warehouses and Display Rooms

135 Tenth St. San Francisco
629-33 North La Brea Ave. Los Angeles
6106 Roosevelt Way Seattle

POMONA TILE MFG. CO.
PLANT — POMONA, CALIF.

STRUCTURAL STEEL

For Class A Buildings,
Bridges, etc.

JUDSON PACIFIC CO.

1200 SEVENTEENTH STREET
SAN FRANCISCO

Plants: San Francisco - Oakland

A Permanent Exposition
of the newest ideas
in home planning
and equipment.



THE BUILDING MATERIAL EXHIBIT

Architects Bldg. • Fifth & Figueroa • Los Angeles • MU-6306

SOUND CONTROL

By E. E. SHEEHY*

In the analysis of accoustical conditions in an auditorium and other areas where there is an accoustical problem, there are two main considerations.

1. Is the interior properly shaped or designed for the distribution of sound?
2. What provision has been made for the absorption of sound energy by employing a sound-absorbing material?

Most auditoriums and rooms of a miscellaneous nature which might be utilized for restaurants, banks, offices, or even the selling floor of a retail store, are so shaped that sound is well distributed in them. Curved surfaces have a focusing action on sound, and are not desirable, because if the concentrations come at or near the floor line sharp echoes are the result. When possible, curves should be avoided unless special attention is given to cover these areas with a sound-absorbing material. In auditoriums or lecture rooms, special attention should be given to the individual need of these areas and this can be accurately computed with the proper engineering formulas, from the drawings or in the actual areas by using accepted test equipment.

When a sound is made in a room, the sound waves spread rapidly in all directions and strike interior surfaces. If the surfaces are hard and have no ability to absorb sound, the waves are almost totally reflected. The ordinary plaster surfaces absorb only 3 per cent of the sound energy at each impact and the other 97 per cent is reflected. Sound travels at the rate of 1120 feet per second and striking these hard, non-sound-absorbing surfaces, is reflected and magnified to many times its original intensity. It is evident that the reflections will continue back and forth between interior surfaces for a large number of times before enough energy is lost to make the sound inaudible.

The accumulations of these continued reflections is what is termed "reverberation." The effect of reverberation is to prolong in a room the sound, after the actual source of sound has stopped. If the reverberation in a room is excessive, the trail of sound following one syllable of speech or tone of music will not die out before the next is uttered, or originated. The result is obvious. There is a confusion of sounds in which nothing appears clear and distinct and audition is difficult and tiresome.

This long reverberation period, perhaps coupled with a high noise level due to conversation, moving of chairs, desks, and the use of noisy equipment, will cause fatigue. Employees working under such conditions tire quickly and become nervous and many times customer difficulty may be traced directly to irritations caused by confusion resulting directly from annoying sounds. A quiet business room not only reduces errors to a minimum, but increases efficiency and eliminates

* The Harold E. Shugart Company, Acoustical Engineers, Los Angeles.

the necessity for repetition of conversation.

Actual tests by the Aetna Life Insurance Company of Hartford, Connecticut, proved conclusively that the use of sound-absorbing tile in the ceilings of their general offices resulted in the following facts:

1. Increased Workers' Efficiency judged by earnings 8.8%
2. Reduction of Errors—
 - Typists 29%
 - Machine Operators 52%
3. Reduction of Turnover 47%
4. Reduction of Absence 37½%

An easy demonstration of how effectively a good sound-absorbing material may absorb accumulated reflections can be demonstrated by striking an empty glass and noticing the prolonged ring; then go through the maneuvers by holding the glass, and it is obvious that there is only a dull thud. It might be said that noise is distorted, or snubbed, very similar to the action of a golf ball thrown against a hard surface, immediately it bounces, whereas if this ball were bounced against a pillow or mattress, there would be practically no bounce. This could be interpreted as the action of sound against sound-absorbing material, which snubs or absorbs these reflections and prevents their accumulation, which in turn would build up to a high reverberation time or noise level.

As there are many acoustical materials on the market, the buyer should carefully consider their source and the practical solution that they may offer to his individual problems through continued use over a period of years. There are accepted standards for comparing these materials and reliable acoustical engineering and contracting companies who are equipped to not only make the proper acoustical engineering survey, but the actual installation of the material as well.

SAN MATEO COUNTY FIESTA

Featuring a \$50,000 "bouquet" of prize blooms, California's floral beauty goes on parade in the Tenth Annual San Mateo County Fiesta to be held at Bay Meadows, San Mateo, September 19th to 22nd, inclusive.

Professional and amateur floral exhibitors will compete for more than \$20,000 in prize money, and over 3000 entries, including prize agricultural and domestic science displays, are scheduled.

VALLEJO LOW COST HOUSING

Bids will be called for shortly for the construction of 600 low cost housing units for the Navy Department on a 28 acre plot near Vallejo. The project includes 50 two story row houses, each dwelling to have a living room, kitchen and bath and either one, two or three bedrooms. Walls and second floor slab will be monolithic concrete. The first floor slabs will be pre-cast. Albert F. Roller, First National Bank Building, San Francisco, is architect of the \$2,400,000 project.

A good investment—

is a well designed, well built structure, properly located.

Lindgren & Swinerton, Inc.

have been building substantial buildings for over a half of a century, are still building them and will continue building them for another half a century.

Lindgren & Swinerton, Inc.

Standard Oil Building San Francisco 619 H Street Sacramento	605 W. Olympic Boulevard Los Angeles 1723 Webster Street Oakland
--	---

**ASBESTOS CURTAIN—STAGE
DRAPERIES AND RIGGING**

For
WHITTIER UNION HIGH SCHOOL

Furnished and Installed by

**R. L. GROSH & SONS
SCENIC STUDIOS**

4114 Sunset Boulevard
Hollywood, California

*More Than The Modern Economical
Method of Concrete Construction*

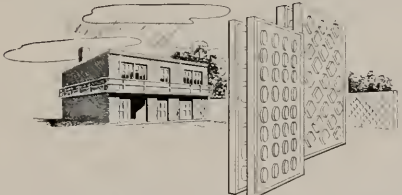

CONCRETE GRID FORMS
(TOMORROW'S WAY TO BUILD TODAY)

... is the **NEW TOOL** to increase better building

CONCRETE Grid Forms build Scott Security Homes and buildings of reinforced concrete which are quickly and easily assembled and poured in place.

Concrete Grid Forms offer Framing Methods, scuring fire-resistant, earthquake and termite proof concrete structures of every kind, providing many economies.

Request your architect, engineer, builder, or contractor to investigate our method before proceeding. Write, telephone or wire for full particulars.

CONCRETE GRID FORMS

3075 Telegraph Avenue Phone: ASberry 7270
Berkeley, California

GEORGE A. SCOTT
The Modern Economical Method of Concrete Construction



QUALITY AND DEPENDABLE *Service*

are the factors that influence architects and contractors when selecting lumber and mill work — Quality of merchandise — Integrity and Ability of the firm—Service in physical equipment — Experience and Personnel — All these factors contribute to a speedy and satisfactory completion of construction with minimum of time and expense.

MANUFACTURER OR DEALER IN

Douglas Fir—Redwood—Sugar and Ponderosa Pine — Plywood and Concrete Form Panels — Sash and Doors — Millwork — Insulation — Builders' Hardware.

E. K. WOOD LUMBER CO.

"Goods of the Woods" ©

LOS ANGELES • SAN FRANCISCO • OAKLAND



PRESSURE TREATED LUMBER ● PROTECTS AGAINST DECAY AND TERMITE ATTACK

*Specify it in your home
Available through Lumber Dealers*

LOS ANGELES
601 W. 5th Street
Phone Michigan 6294

SAN FRANCISCO
333 Montgomery Street
Phone DOuglas 3883

J. H. Baxter & Co.

AGENTS FOR WEST COAST WOOD PRESERVING CO., SEATTLE, WASH.

TIME AND FIRE ALARM SIGNALS

An essential of every large educational institution is an absolute coordination of time throughout the whole plant. In the old group of buildings at the Whittier Union High School was a miscellaneous collection of room clocks of various ages, types and kinds of manufacture, driven by an International master clock over twenty years old. This system operated fairly well, but not with the precision and dependability of modern equipment. It was therefore decided to replace the old clocks with the latest hourly-supervised type.

The system was laid out by Chauncy Mauk, of Ralph Phillips' office, in cooperation with engineers of the International Business Machines Corporation. It now consists of a complete coordinated system of room clocks and signals, kept in positive agreement to a fraction of a second by an ingenious device on the master clock which forces every unit on the system to agree with it at all times. Any room clocks which are "late" are caused to speed up until they are at the correct time; or if the room clocks for some possible reason are fast, they are forced to wait until the correct time "catches up" with them. The master clock itself is a highly accurate instrument which is regulated so closely that it never varies from true time more than a few seconds per month. The school therefore has a time standard which closely approximates the government signals at all times.

Every school must by law have a fire alarm signal system of some sort. The usual type sets the alarm gongs ringing as soon as one of the small red alarm stations is broken. Difficulty had been experienced by the Whittier officials in the past by student pranksters who turned in false alarms, causing no small amount of confusion and lost time.

A special "double supervised, selective code, presignal" system was worked out by International engineers to offset the pranksters. In operation, if a box is pulled, an alarm bell rings in the school offices, a red light flashes, and a small arrow points to a tag giving the location of the station from which the alarm was sent. As a double check on the location, the box sends its own coded ring on the alarm bell, which can be checked against a handy list in case the arrow fails in its duty through possible wire damage from an actual fire. The school office at once telephones a specified teacher near the alarm box which has been pulled. This teacher investigates the situation. If there has been a false alarm, nothing is done except to report the fact to the office. However, if there is an actual fire, the teacher inserts a special key in the alarm box, and the corridor fire gongs at once empty the buildings. As a precaution against possible trouble in the complicated system, the main fire alarm panel maintains a watch over all of its network of wires, and will at once flash a red light and sound an audible signal in the school office if a break occurs, thus insuring proper operation of the alarm system at all times.

DAYLIGHTING AND VENTILATION

In the Whittier Union High School, the H. H. Robertson Company supervised and provided the equipment for all daylighting and ventilation of the gymnasium and swimming pool gallery through the medium of Robertson skylights and ventilators.

Various types of Robertson ventilators were used depending on application. They were the new rectangular streamliner type, round gravity units and combination gravity and power ventilators with fans integral with the ventilation.

The Robertson puttyless skylights were glazed with 1/4" wire Coolite glass in order to reduce heat transmission and glare, a new type of "frameless" sawtooth construction, as developed by the H. H. Robertson Company, incorporating the use of their cellular steel and puttyless sash construction. The replacement of a network of intricate framing as used in conventional frames in the underside of the sawtooth by the exposed cells of the Robertson Unit, provided a neat and economical roof and ceiling.

Two H. H. Robertson Company stage ventilators or smoke exhausters were installed over the auditorium stage complying with Underwriters' requirements.

DONOVAN

AUTOMATIC AWNING TYPE

W I N D O W S

Specified and used in Girls Gymnasium Unit,
Whittier High School • Wm. H. Harrison, Architect

Donovan Windows give
100% Natural Ventilation
and Day Lighting Control

UNIVERSAL WINDOW COMPANY

Berkeley, California

LANSING

STEREOPHONIC

"Sound where you see it"

*An explanation of this
revolutionary public ad-
dress system will be found
in this issue as installed
in the Whittier Union
High School Auditorium.*



*Manufacturers of high
quality talking picture
and public address equip-
ment, installed in theatres,
motion picture studios,
public and civic auditori-
ums as well as stadia
throughout the world.*

LANSING MANUFACTURING CO.

Western Electric Licensees

Northern Distributor
UNITED THEATRE SUPPLY CO.
128 Golden Gate Avenue,
San Francisco, California

6900 McKinley Avenue • Los Angeles, California

Southern Distributor
BRECK PHOTOPLAY SUPPLY CO.
1969 S. Vermont Avenue,
Los Angeles, California

CONSULTING SOUND ENGINEERS

RUNNING FIRE

(Continued from Page One)

Man waved his cane at the O'Brien and myself, and with a net result of two drinks. "We have," he continued, "an innumerable set and series of statistics, indices and accounts purporting to describe recessions and accessions in business production through the medium of price changes for the past hundred and fifty years. Beyond that we are statistically and informationally ignorant. Periods of business peaks and bottoms may be noted, but with no degree of accuracy. And it is my personal opinion that a good part of the difficulty is due to accountants. This breed has inhabited the earth for many years. The first printed book appeared in the fifteenth century and was written by Pacioli, and ever after that we have been blessed with double entry bookkeeping. If we didn't know whether we were making or losing money, there wouldn't be any boom or fall; and a natural corollary of this knowledge is the practice of accounting. During the middle ages we undoubtedly didn't know how much we made or lost and so there was no depression. But accounting is older—it dates back to the gods of Rome and probably to the gods of Greece, Petronius in the days of Nero wrote of casting accounts and auditors.

"The gods were happy, though; Jove didn't have an auditor to tell him he had spent more thunderbolts in June than he did in May; Hebe didn't have a cost accountant to tell her that ambrosia had risen in price and she would have to water it; Apollo didn't have an efficiency engineer to tell him that chasing Daphne interrupted the operation of his chariot; and now Bacchus has become a financial organization that rides to hounds in depression and recession."

I started to ask the meaning of this last but noticed that the Little Man was trying to climb his cane which he had hung over the bar rail—the two old Fashioneds were gone.

★ ★ ★

Bird Diary

A. M.

- 5:00 —Waked up.
- 5:00½—Fresh air smelled good. Guess head too far under wing. Seemed stuffy. Have to watch that.
- 5:01 —Neck stiff. Must remember to try left wing to-night.
- 5:01½—Had breakfast.
- 5:02 —Sang a song.
- 5:02½—Sang another song.
- 5:03 —Preened a bit.
- 5:03½—Cramps. Ate too much breakfast. Oh, well—
- 5:04 —Tried a new song. Not so hot.



WOMEN go into raptures over this new Wesix "Perfect Thirty-Six" electric bathroom heater. Its instant, head-to-foot heat, they exclaim, "is simply marvelous!" You will like it because it fits perfectly into 42-inch wainscots. For details write Dept. 206, Wesix Electric Heater Co., 390-1st St., San Francisco.

WESIX

World's Largest Manufacturers of Major Electric Heaters

DINWIDDIE CONSTRUCTION COMPANY • BUILDERS •

CROCKER BUILDING
SAN FRANCISCO

HIGH GRADE MILLWORK
AND INTERIOR FINISH
SASH AND DOORS

LANNOM BROS. MFG. CO.

FIFTH AND MAGNOLIA STREETS
OAKLAND, CALIFORNIA
Telephone: TEmplesbar 3663

Pitcher DOOR SYSTEM

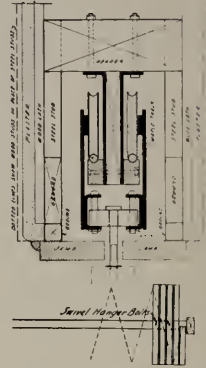

Includes Closet Doors, Interior Disappearing Doors, Exterior French and Screen Doors, Tandem Doors for Wide Openings, Sliding Partitions, Folding Doors, Garage Doors. Send for Details.

E. C. Pitcher Co.

557 Market St., San Francisco
Phone YUkon 1543

Smith

Lumber Company

WHOLESALE - JOBBING - RETAIL
FACTORY AND BUILDING LUMBER
PLYWOODS - ROOFING

DISTRIBUTING YARDS

San Francisco	Oakland
•	19th Ave. &
4th & Channel	Estuary
MArket 0103	FRuitvale 3174

YOUR INQUIRIES SOLICITED

- 5:04½—Pekked the old oil sack.
- 5:05 —Feel O. K. again.
- 5:05½—Preened. Three feathers came out. Guess I'm going to be bald.
- 5:06 —Took a crack at cattle bone. Can't give it much. Good for the old beak, though.
- 5:06½—Had lunch.
- 5:07 —Took a nap.
- 5:07½—Tried the swing. Makes you want to sing.
- 5:08 —New song going better.
- 5:08½—Took a bath. May seem late but can't bathe too soon after eating.

ARCHITECT AND ENGINEER

