

PERIODICAL DEPT.



X

BOOK No.

ACCESSION

*720.5 Ar24 154 546647

NOT TO BE TAKEN FROM THE LIBRARY

FORM 2637 - 6M - 10 - 41

Q



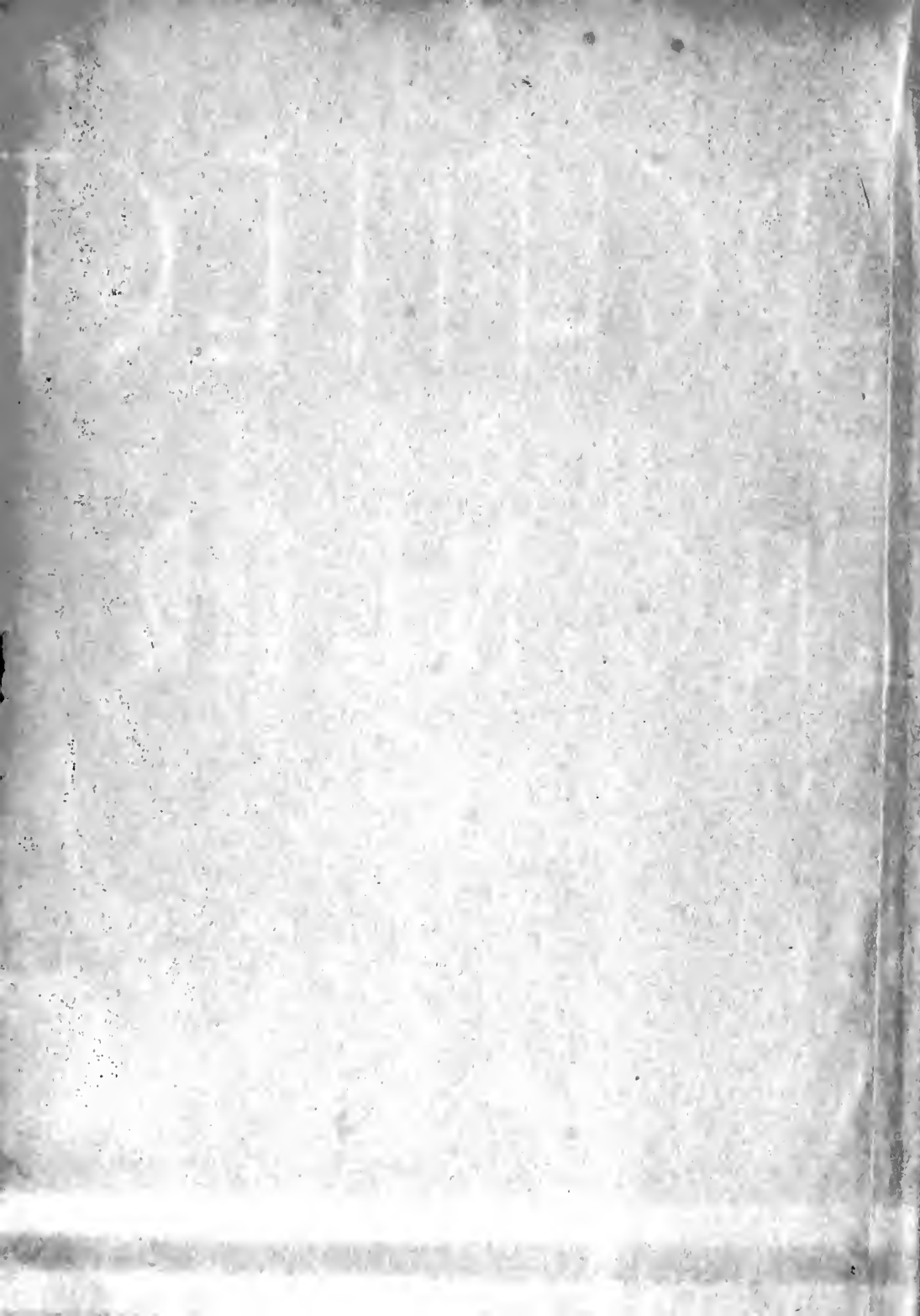

ARCHITECT

AND

ENGINEER

TO HIT 'EM H-A-R-D-E-R

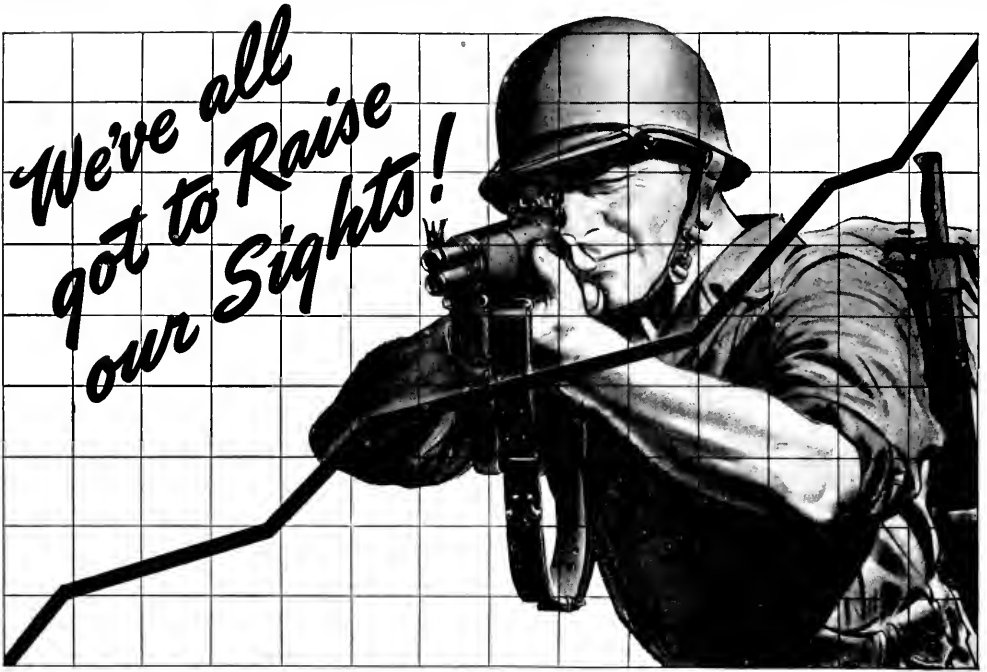

THE year 1943 promises to be the grimmest, hardest year this country has ever faced. Every effort, and every dollar of national income not absolutely needed for existence, should go into war work and War Bonds.

In the Pay Roll Savings Plan, America finds a potent weapon for the winning of the war—and one of the soundest guarantees of the preservation of the American way of life!

Today about 30,000,000 wage earners, in 175,000 plants, are buying War Bonds at the rate of nearly half a billion dollars a month. *Great as this sum is, it is not enough!* For the more dollars made available now, the fewer the lives laid down on the bloody roads to Berlin and Tokio!

You've undoubtedly got a Pay Roll Savings Plan in your own plant. But how long is it since you last checked up on its progress? *If it now shows only about 10% of the gross payroll going into War Bonds, it needs jacking up!*

This is a *continuing* effort—and it needs *continual* at-

ention and *continual* stimulation to get fullest results.

You can well afford to give this matter your close personal attention! The actual case histories of thousands of plants prove that the successful working out of a Pay Roll Savings Plan gives labor and management a common interest that almost inevitably results in better mutual understanding and better labor relations.

Minor misunderstandings and wage disputes become fewer. Production usually increases, and company spirit soars. And it goes without saying that workers with substantial savings are usually far more satisfied and more dependable.

And one thing more, these War Bonds are not only going to help win the war, they are also going to do much to close the dangerous inflationary gap, and help prevent post-war depression. The time and effort *you* now put in selling War Bonds and teaching your workers to save, rather than to spend, will be richly repaid many times over—now and when the war is won.

You've done your bit  **Now do your best!**

This space is a contribution to victory today and sound business tomorrow by Architect and Engineer

ARCHITECT AND ENGINEER

JULY, 1943

Vol. 154 No. 1

x720.5
Ar 24 ¹⁵⁴/₅₄₆₆₄₇

FRED W. JONES
Editor

MARK DANIELS
Associate Editor

HOWARD MOISE
Post-War Planning

E. N. KIERULFF*
Ass't Editor

COVER DESIGN: Wayne S. Hertzka-Michael Goodman

PHOTOGRAPHY: Adkins (Housing Projects)

CONTENTS

Running Fire	3
Mark Daniels, A.I.A.	
News and Comment on Art	4
Paintings of Jen Schreuder	6
Douglas MacAgy	
Millions for War Housing	17
Fred'k W. Jones	
Engineers Plan Pacific Air Terminal	29
Unique Design for Two-in-One Airport	32
Home Building After the War	37
Wilson Compton	
English Tavern at Santa Maria Inn	40
What Would Happen Were the War to End Tomorrow?	41
Architects' Bulletin—The Impending Crisis	43
William C. Ambrose, A.I.A.	
Producers' Council Page	45

Illustrations

Sacramento Airport Housing Project	16-19
Wm. W. Wurster and Charles F. Dean, Architects	
Permanent Family Apartment Units, Richmond	32
Will G. Corlett and Arthur W. Anderson, Architects and Engineers	
4,000-Unit War Housing Project, Richmond	20-23
Prefabricated Houses for War Workers, Chabot Acres, Vallejo	25
Wm. W. Wurster and Franklin and Kump, Architects	
Apartments for Federal Public Housing Authority, Alameda	27
Francis E. Lloyd, Carl F. Gromme and Hervey Parke Clark, Architects	
Proposed Trans-Pacific Air Base	28
Donald R. Werren Co., Engineers	
Proposed Airport at Keehi Lagoon, Honolulu	32
Hart Wood, Architect; Alfred Preis, Associated Architect	

ARCHITECT AND ENGINEER (Established 1905) is published on the 15th of the month by The Architect and Engineer, Inc., 68 Post Street, San Francisco. President, K. P. Kierulff; Vice-President, Fred'k W. Jones; Secretary-Treasurer and Manager, L. B. Penhorwood; Advertising Manager, V. E. Atkinson, Jr.

Entered as second class matter, November 2, 1905, at the Post Office in San Francisco, California, under the Act of March 3, 1879. Subscriptions, United States and Pan America, \$3.00 a year; \$5.00 two years; foreign countries \$5.00 a year; single copy 50c. ARCHITECTS' REPORTS are published daily from this office, Vernon S. Yallop, Mgr.

NEXT MONTH

THE LATE exposition at Treasure Island is having its influence on recent industrial architecture. An office building at Sunnyvale, for the Sunnyvale Packing Company, is an illustration in point. It is a three-story structure, built of redwood and equipped with fluorescent lighting. Wurster is the architect. You'll like the pictures.

The city of Burbank, California, after five years agitation for a new City Hall, has finally realized its hopes and has moved into its new home, planned to meet present and future needs of a fast growing community. The structural features are reinforced concrete with some unusually interesting ornamental details, sculptured panels cast in waste moulds and mural paintings of historical significance in the entrance hallway and council chamber.

For those interested in post-war plans, George Pampel of the I. F. Laucks Company will contribute an article on "Planned Housing for the Future."

Development in modern aircraft as it interests the structural engineer will be discussed by Howard D. Eberhart, assistant professor of civil engineering at the University of California. He will cite some of the structural problems of aircraft design. Albert C. Ballastus, formerly chief engineer of the North American Aircraft, Inc., will discuss some of the significant developments that are taking place in aircraft manufacture and which are expected to lead to larger, heavier and faster planes in the future.

*In Military Service—Lieut., U. S. N. R.



MODEL No. 9H—Pedestal type unit with two enameled iron bowls, equipped with self-closing valves. Fountains can be installed to face same direction.



MODEL No. 6G2

—Pedestal type with single vitreous china fountain bowl with protecting cowl. Anti-squirt, angle stream drinking fountain head and self-closing stream control valve.



MODEL No. 8—Wall type with enameled iron drinking fountain bowl. Has shielded anti-squirt angle stream drinking fountain head and self-closing valve.



SERVE INDUSTRY WITH HAWS

DRINKING FOUNTAINS and FAUCETS

The comforts and conveniences for workers in war equipment industrial plants are vital features for capacity production. Satisfied workers will produce. Healthful, safe drinking water, available at all times, is important to the workers' satisfaction. HAWS catalog shows a complete line of wall and pedestal type fountains and electric water coolers. The HAWS angle stream, anti-squirt drinking fountain head assures complete drinking sanitation. **Specify HAWS for drinking water equipment!**

HAWS DRINKING FAUCET COMPANY

1808 HARMON STREET • BERKELEY, 3 • CALIFORNIA

Agents in the following cities:

Chicago • Los Angeles • San Francisco • Seattle • Salt Lake City • Portland
New Orleans • Houston • Atlanta • Philadelphia • Worcester, Mass.

RUNNING FIRE — by MARK DANIELS

• *WHAT IS A PREFABRICATED HOUSE?*

There seems to be a great deal of misunderstanding of the meaning of prefabrication, and, until it is defined and thoroughly understood, a clear picture of the part it is to play in the next few decades will be difficult to develop.

Intrinsic or fundamental prefabrication is not new. In fact, it is probably as old as the ax or the saw and dates from the first purchase of a piece of worked structural wood that a man took home to use in place of the piece he would otherwise have to work up himself. From the beginning of building we have been employing the principal of prefabrication until today a very large proportion of all our structures are prefabricated.

Our doors and windows, many floors, furniture, fixtures and even the bricks in our walls are all prefabricated. So, the question is not whether a house is prefabricated or not, but how much of it is? We might say "my house has prefabricated windows, doors, partitions and roof but the rest was done on the job." A strictly prefabricated house would be one in which everything was prefabricated but the foundations and, probably, insofar as is practical, that is what we are coming to.

And why not? What is wrong with the system? We started out having every timber made by hand, every element of the structure, and have grown to ordering our mill work, fixtures and furniture made elsewhere.

As time goes on the amount and variety of these will increase with the only limit established by practicability and individual taste.

There are many advantages to be reaped from this expansion of the field and extent of prefabrication, not the least of which is the elimination of non-uniform workmanship on the part of individual craftsmen. Quality will undoubtedly become more and more the hall-mark of those prefabricators who stay in business and if they prove their superiority we may yet see a small but entirely prefabricated house set on a prepared foundation.

• *POST WAR ARCHITECTURE*

Perhaps our Joseph Hudnut, Dean of the Harvard School of Design, is right in saying that the future world will pursue its thought "in halls unshadowed by majestic towers," that, "Great Tudor, Colonial and Etalicanate homes will be used only as refuges for superannuated policemen." Mebbe so, mebbe so, but I do not believe that the end of this war, or the next, that we claim is not to come, will usher in a time when there will be no big shots who must have great homes—not if I know my merchant princes.

• *POST WAR REWARDS*

We are taught that we should be good not for the hope of reward but because it is the right thing to do. By the same token I suppose we

should do right not for the purpose of avoiding punishment. Never-the-less many people work hard for mere applause and pay rent to avoid eviction. So, we may be excused for indulging in a few pleasant speculations on possible post war rewards.

Of course, we are fighting this war for freedom and we shall win it and the liberation of mankind, but when the inescapable rewards are passed out we may be permitted a slight chuckle when post war construction materials eliminate certain union labor, such as the plumber and his assistant, when plastic pipes and other bathroom accessories have been introduced.

• *OTHER FIELDS*

For those who find no solace in the repeated predictions of the architects who see a rosy future of the possibilities in foreign countries. Perhaps the added feature of a bit of travel may be all that is needed to perk up their imaginations.

Foremost of the countries who need and lack the services of architects and engineers is China. The Chinese not only need new structures to replace those destroyed by war but they are an ancient people developing for them, a new civilization. They are quick to recognize improvements and courageous enough to install them. Contrary to a general misconception they excel in mechanics and craftsmen.

But it must not be assumed that they will take on anything that is advocated by high-powered salesmanship. They have been through all that sort of thing during the past three thousand years. The low arch open spandrel bridge at Ch'iao Hsin, first and still the most beautiful of its type in the world, built nearly a thousand years before the first similar type in Europe, is a mute testimonial to the progressive Chinese mind.

You will not find it necessary to speak 40 or 50 Chinese dialects but you will find that you must know your work, particularly in architecture and engineering, to do as well in China.

• *ALBERT KAHN'S GIFT*

Void of literary or verbal pyrotechnics, the announcement of Albert Kahn's gift to the Architects of America, through the American Institute of Architects, boils down to just what Mr. Kahn intended it to be—a good, practical method of rewarding merit.

The paucity of such gifts is a sad commentary on the architectural profession, for if the profession does not carry sufficient remuneration to allow more than one or two in a generation to make such bequests we had better not urge others to join it. On the other hand, if the money made is sufficient to justify more such gifts it looks as if some of our better situated practitioners are out of that class of the philanthropically inclined.

Although neither of these conditions is entirely true, Mr. Kahn is the first in recent times to step forth with anything like this fine, thoughtful and helpful gesture.

NEWS AND COMMENT ON ART

UNUSUALLY GOOD COLLECTION OF PAINTINGS AT LINCOLN PARK PALACE

Three exhibitions at the California Palace of the Legion of Honor, Lincoln Park, San Francisco, are the center of much public interest this month. The showing includes "Watercolors," by Rex Brandt;

"Paintings," consisting of 20 pastels of flowers, landscapes and portraits, a delightful exhibition by the gifted San Francisco artist, Helen Salz, and "Tobacconist's Figures and Stop Signs." The latter, from the Index of American Design, Metropolitan Museum, New York, includes 50 watercolor drawings, a varied selection of carved and painted figures and signs, including cigar-store Indians, tavern signs of the 18th and early 19th Century, and shop signs for the butcher, the barber, the carpenter.

The Rex Brandt exhibition has been called "an exciting show," because it reveals a "young artist sensitive to the main currents of American thought." As an outstanding member of the group of younger California painters, and one of those who especially has made a strong bid for national prominence, Brandt paints the everyday, intimate subjects of characteristic American life, with a strong emphasis on natural surroundings. First exhibiting in 1933 at the old Riverside County Fair, Brandt came into national prominence with his series on the Metropolitan Aqueduct, published in Fortune magazine.

Other July showings at the Palace of the Legion of Honor include Bronzes by Arthur Putnam, gift of Mrs. Alma Spreckels Awl, from the Museum's permanent collection; "Prints from Children's

Blocks" in the Children's Museum, and an exhibition entitled "Road to Victory": a procession of photographs of the nation at war, which was originally assembled for the Museum of Modern Art, New York, by Lieutenant-Commander Edward Steichen, U.S.N.R. It was held in New York for four months during the summer and drew more than 103,000 visitors. The present tour was made possible by the United States Government Office of War Information. After leaving San Francisco, it will be shown in Portland, Oregon, and thence will return East.

AUGUST ATTRACTIONS AT DE YOUNG'S SELF-PORTRAITS BY AMERICAN ARTISTS

The big show of the year at De Young's comes next month—an exhibition of self-portraits by American artists. The show promises to be a major exhibition of works by leading contemporary painters and cartoonists who have responded with interest to the "Meet the Artist" program planned by Dr. Walter Heil.

Popular interest in seeing others as they see themselves is expected to make the exhibition a welcome opportunity for San Franciscans to become acquainted, through these self-portraits, with many outstanding artists creating the American art of today.

ALBERT M. BENDER GRANTS-IN-AID ARE AWARDED BY ART ASSOCIATION JURY

The San Francisco Art Association has announced this year's winners of the Albert M. Bender grants-in-aid. Only residents of the San Francisco Bay area were eligible and the jury named Clay Spohn



AMUSEMENT PARK
by COPELAND C. BURG

San Francisco Art Association
Purchase Prize, 1943, Water Color Annual

IN AN EVER CHANGING WORLD

of 2507 Jones Street, San Francisco, winner of the award in art for his paintings of "Modern Engines of War," and Rosalie Moore, 3038 Fulton Street, winner of the award in Literature for her "Modern Verse."

NOTES FROM THE SAN FRANCISCO ART ASSOCIATION

The San Francisco Art Association announces September 22 through October 17 as the dates for its annual exhibition of painting and sculpture. Besides the usual prizes for outstanding exhibits an additional prize has been established by Miss Julia Klumpkey, in memory of her sister, Anna Elizabeth Klumpkey. This prize, which is for \$250, is to be awarded for the first time this year, and every year hereafter, for an outstanding oil portrait or figure painting. The award may be made to any exhibiting artist.

At the seventh annual water color exhibition of the Association, the following prizes were awarded: The San Francisco Art Association Purchase Prize, to George Alois Laisner for his gouache "Ricochets," and the Artists' Fund Prize, to Copeland C. Burg for his casein painting "Amusement Park."

Dorothy W. Liebes, Director of the Association, is directing the arts and skills project of the American Red Cross.

AMERICAN INDIAN WATERCOLORS FEATURED THIS MONTH AT DE YOUNG MUSEUM

During July the De Young Museum featured an interesting exhibit of American Indian paintings representative of recent work done by the tribes of the Southwest. These paintings, done in the flat pure color traditional in the art of these peoples are notable for their bold color and graceful design in which rhythm, repetition, symmetry and symbolism are employed in the conventionalizing of motifs from nature and in the depiction of native customs and ceremonies. Indian art of today is characterized as it has been in the past by the decorative quality of its design.

The exhibition material from the Riverside Museum, New York, is augmented by related works loaned by Mrs. Charles de Young Elkus and Mrs. William Denman, whose collections of Indian art include many excellent examples.

Mrs. M. C. Sloss has collected over a period of years many works of art based on the "Mother and Child" theme. Part of her large collection is being shown at the De Young this month. It is composed of Staffordshire figurines and Currier and Ives prints presenting the subject as it was treated in the Victorian period.

WINNING SOAP SCULPTORS NAMED IN PROCTER & GAMBLE COMPETITION

Winners of \$1,120 cash prizes in the 19th annual national competition for small sculptures in Ivory soap, for the Procter & Gamble prizes, were:

First prize in the Junior Class, for children under 15 years of age, awarded to Ruthy Brown, of La Mesa, California, for the piece entitled "Horse and Boy." Gioconda Oresti, of 316 Belonda Street,

Pittsburgh, Pa., won the \$100 first prize in the Senior Class, for those over 15 and under 21, with her carving "Symphony in Soap." Winner of first prize of \$150 in the Advanced Amateur Class, for those over 21, was "The Toy," by Mabel V. Mustonen, of 18449 Gruebner Avenue, Detroit, Michigan.

MRS. ALMA SPRECKELS ROSEKRANS SUCCEEDS PAUL SHOUP AS TRUSTEE

The Board of Trustees of the California Palace of the Legion of Honor have announced the election of Mrs. Alma Spreckels Rosekrans as trustee.

Mrs. Rosekrans, who is the daughter of the late Adolph B. Spreckels and his wife, Alma de Bretteville Spreckels, donors of the Palace of the Legion of Honor to the city of San Francisco in 1924, fills a vacancy on the board through the resignation of Paul Shoup, now a resident of Southern California.

(Turn to Next Page)

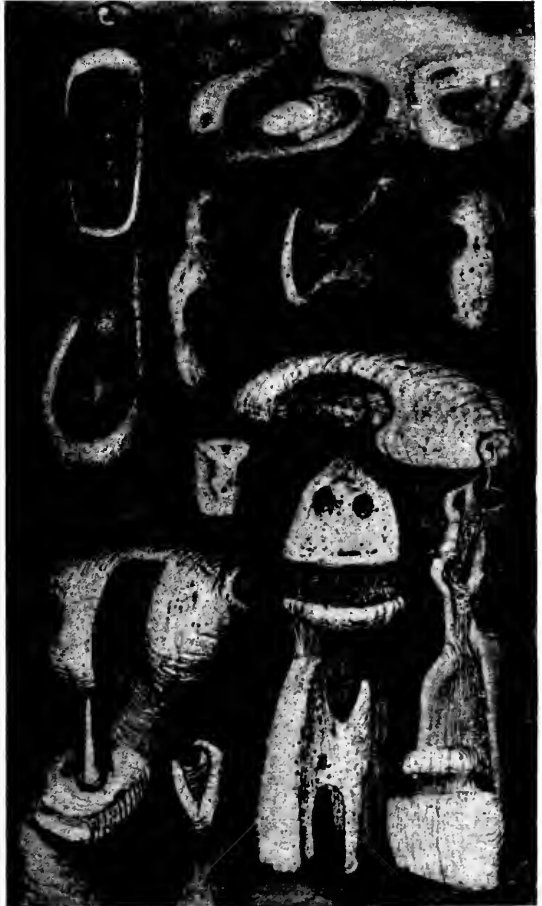

DRAWING BY HENRY MOORE

San Francisco Museum of Art

PAINTINGS OF JAN SCHREUDER. EXPRESSIONIST

By Douglas MacAgy

"Cubism, Dadaism, Futurism, Impressionism and the rest have nothing in common with our German people. For all these notions are neither old, nor are they modern; they are simply the artificial stammering of people whom God has denied the boon of genuine artistic talent and given instead the gift of prating and deception. . ."

Continuing, the speaker had observed artists "who, as a matter of principle, see, or as they would perhaps say, experience meadows blue, the sky green, and clouds sulphur yellow. I do not wish to enter into an argument as to whether the gentlemen in question really do see and experience things in this way or not but I wish, in the name of the German people, to forbid such lamentable unfortunates, who plainly suffer from defective sight, to try and talk the world about them into accepting the results of their false observation as reality, or to represent them to it as 'art.'"

A dictatorship of taste is not new in the history of occidental art. By means of his academies Louis XIV was able to exercise a fairly effective control of what would be countenanced in the arts. But the means of Louis' control took the form of economic security and social prestige. If an artist was willing to sacrifice such favors of the court he was not prevented from further work. It was Hitler who placed the artists whose work he disliked beyond the pale of the law. His statements quoted above proscribe a whole epoch of art.

We know very well that his censorship was addressed not only to the international movements of Cubism, Impressionism, and the rest, but also to movements of this age which were peculiar to the Germanic peoples. These movements, known best by the far too inclusive term Expressionism, make up a substantial body of the creative work of this century. And that, of course, was the point. It represents a vital creative spirit which is by nature experimental, and by result wayward. While Expressionism was the form of modern art in Germany, and contains many elements which distinguish it, certain aspects of it appeared in common with contemporary movements in other parts of the world. Of these the most profound is its restless vitality, its adventurous search for form.

Sometimes this search took a similar path to those which were being travelled, for example, by artists in Paris. One such way was directed toward the exotic. Men like Max Pechstein and Otto Muller found material for their art in the South Seas. Jan Schreuder finds his in Ecuador.

Schreuder is not a German, but a Hollander. Yet his work, as the rather large exhibition of his paintings recently exhibited at the San Francisco Museum of Art showed, falls well within the Expressionist tradition. In the presence of his work it is easy to think of Pechstein, Muller, Nolde, even Munch, Gauguin and Van Gogh.

Pechstein belongs, of course, to a generation younger than that of Gauguin and Van Gogh, and his work shows a change of attitude. On the other hand Schreuder, who is twenty-three years the junior of Pechstein, keeps close to the tradition of

his immediate senior. In his work one finds the crude and vigorous brushwork, the figures which fill the canvas, the vague backgrounds stirred by the shapes of the figures like the wake of a ship, which we associate with early Expressionism.

It is a strenuous and moody art. While it is sombre, it has nothing of the quiet gloom of much nineteenth century Romanticism. Like Van Gogh's, the lines in Schreuder's canvases are massed into thickets that move through space in swirls and diagonals. But Van Gogh's rhythms are quicker, more energetic and at times strident. Schreuder's passages are slow and heavy. It is as if the odds against motion were high, but by sheer will they were forced to yield. The directions which these movements take have more ample scope than in Van Gogh. Contours of limbs and bodies expand into great arcs that surge through the picture space. The gigantic character of the figures is matched by the physical energy which each mighty stroke of the brush seems to have consumed.

Schreuder works within a close range of color, and within extremely simple and close ranges of value at each end of the scale. The most predominant hues used are dark browns and purples of earth, yet within these the painter achieves a variety of remarkable subtlety in the face of the apparent crudeness of its handling. A good deal of this comes of an awareness of color in relation to space. The same hue rendered opaque in one place and transparent in another not only contributes to variety in the color composition but makes for a movement and a location in space. Much of the drama which at first sight is associated with color, actually comes from strong contrasts of light against dark. But even here the effects of value are intensified by the glow and the gleam of color. The large dark areas glow whereas the sudden rifts of light gleam. In this Schreuder is a master indeed, and makes an original contribution to his tradition.

Jan Schreuder has lived in various parts of Latin America since 1926. Most of that time has been spent in painting landscape and native life in the Ecuadorian sierra and Guatemala. He has impressed many painters in Ecuador with his style. Recently the San Francisco Museum exhibited the works of Oswaldo Guayasamin Calero, a native of Ecuador. It would seem that Guayasamin has fallen under Expressionist influence. He too paints huge canvases in ribbons of thick paint. He too paints enormous figures in dramatic contrasts of light and dark. But as yet his essays on such a grand scale lack the conviction of Schreuder's.

Guayasamin is a very young man, and, as Lincoln Kirstein and Rene d'Harnoncourt have stated, he is a gifted artist. That his work does not bear the mark of maturity to be found in Schreuder is neither here nor there. What is of significance is that he feels the strength and character of the Expressionist tradition in his personal interpretations of his own people and his own land. This is significant because such art is a profound manifestation of the temperamental desires of a people, and also because artists of Ecuador are turning for expression towards a form of art which has been publicly denounced by Hitler.

War Housing Projects Built by Robert McCarthy Co.

Sub-Contractors and Material Houses Listed

Type of Work	Contractor's Name	Address	Page
Cement Walks	General Floors Co.	Los Angeles	12
Grading and Filling	E. P. Linqvist & Bro.	Berkeley	11
Lumber	Moore & Garlick	Sacramento	10
Lathing and Plastering	Lee Merrill	Redwood City	9
Insulation and Sheathing	Kazon, Inc.	San Anselmo	8
Insulation Material	Gunn, Carle Co.	San Francisco	2nd Cover
Gypsum Board	John Bennion	San Francisco	8
Interior Electrical Work	B. J. Doherty	San Francisco	10
Painting	Eddy Paint Co.	Porterville	8
Floor Covering	Kenyon Bros.	San Francisco	10
Plumbing and Heating	Lohman Bros.	Berkeley	8
Stairs	J. di Cristina & Son	San Francisco	11
Roofing	Roofing Surface & Supply Co.	San Anselmo	10
Stucco	California Stucco Co.	San Francisco	9
Landscaping	Leonard Coates Nursery Co., Inc.	San Jose	11
Heating	Atlas Heating and Ventilating Co.	San Francisco-Oakland	10

INDEX TO REGULAR ADVERTISERS

*Indicates alternate months

ALADDIN Heating Corporation.....	56	JENSEN & Son, G. P. W.....	56
AMERICAN Rubber Mfg. Co.....	53	JOHNSON Company, S. T.....	*
ANDERSON & Ringrose.....	54	JUDSON Pacific Company.....	50
BASALT Rock Company.....	51	KRAFTILE Company.....	12
BAXTER & Company, J. H.....	14	McCARTHY Co., Robert.....	*
BILTMORE Hotel.....	*	MULLEN Mfg. Co.....	55
CASSARETTO, John.....	54	NORTHERN California Electrical Bureau.....	15
CELOTEX Corp.....	Back Cover	PACIFIC Coast Gas Association.....	11
CLARK, N., & Son.....	*	PACIFIC Foundry Company, Ltd.....	14
CLINTON Construction Company.....	50	PACIFIC Manufacturing Company.....	52
COATES, Leonard, Nurseries.....	11	PACIFIC Paint and Varnish Company.....	44
COLUMBIA Steel Company.....	*	PACIFIC Portland Cement Company.....	53
CROCKER First National Bank.....	55	PARAMOUNT Built-In Fixture Company.....	11
CROCKER, H. S., Company, Inc.....	51	REPUBLIC Steel Corporation.....	52
DINWIDDIE Construction Company.....	54	SANTA Maria Inn.....	52
EL ENCANTO Hotel.....	52	SALL Mountain Company.....	15
FORDERER Cornice Works.....	50	SCOTT Company.....	56
FULLER, W. P., Co.....	13	SIMONDS Machinery Company.....	52
GUNN, Carle & Company.....	2d Cover	SISALKRAFT Company.....	51
HANKS, Inc., Abbot A.....	56	STANLEY Works, The.....	12
HAWS Drinking Faucet Company.....	2	TORMEY Company, The.....	55
HERRICK Iron Works.....	54	U. S. STEEL Company.....	*
HOGAN Lumber Company.....	50	VERMONT Marble Company.....	51
HUNT, Robert W., Company.....	55	WAR Bonds.....	3rd Cover
HUNTER, Thos. B.....	55	WASHINGTON-Eljer Company.....	45
IMPERIAL Brass Mfg. Co.....	*	WESTERN Asbestos Company.....	14
INCANDESCENT Supply Co.....	54	WOOD, E. K., Company.....	14
INDEPENDENT Iron Company.....	54		

IT'S EDDY PAINTING

ON ALL THE 4,000 UNITS,
U.S. MARITIME WAR APART-
MENT HOUSING PROJECT,
RICHMOND, CALIFORNIA.

Main office, 228 West Putnam Ave., Porterville
Branches at 51 and Potrero, Richmond, Cali-
fornia, and Phoenix, Arizona

EDDY PAINT CO.
STATE WIDE

GENERAL PAINT CONTRACTORS

SHEATHING INSULATION FLOORING

installed on Richmond War Housing
projects (Robert McCarthy Co.,
General Contractors).



KAZON Incorporated
Contractors : Floors and Insulation

169 Oak Avenue
SAN ANSELMO, CALIF.
Phone San Anselmo 4363-W

*Richmond's latest war housing
projects —*

- (1) 4000 Apartment Units
- (2) 1900 Apartment Units

Robert McCarthy Co., Builders



Fibre and Wall Board Installation

(Interior and Exterior)—by

JOHN BENNION

2643 SAN BRUNO AVENUE

RAndolph 2998 San Francisco

Residence Phone DElaware 3065

IT'S McCARTHY AGAIN —

building 4,000 more housing units at
Richmond, California

**PLUMBING, HEATING AND
UTILITIES BY
LOHMAN BROS.**

NO LEAKS
SINCE
1892

**Sanitary Plumbing
and Heating . . . Au-
tomatic Fire Sprink-
ler Systems . . . Air
Conditioning.**

LOHMAN BROS.

Home Office
1449 So. San Pedro St.
Los Angeles

Branch Office
1296 San Pablo Ave.
Berkeley

U. S. MARITIME COMMISSION 4,000 UNIT WAR
APARTMENT PROJECT, RICHMOND, CALIF.

ROBERT McCARTHY CO., GENERAL CONTRACTORS



Photo shows typical family units

All exterior wall areas and boiler rooms plastered with
PLASTITE ASBESTOS CEMENT

Exterior plastering, interior lathing and plastering and exterior cement
painting by

LEE MERRILL

Plastering Contractor

L. N. Johnson, Supt.

P. O. Box 63, Redwood City

CALIFORNIA STUCCO PRODUCTS CO.

San Francisco and Oakland

Manufacturers of

California Stucco Waterproofed Hydraulic Cement Paint

Plastite Asbestos Cement

Interior Stucco

Exterior Stucco

Tile Grout

**INTERIOR ELECTRIC WORK
AND FIXTURES**



War Housing Projects at
Richmond, Vallejo and
Sacramento, by

B. J. DOHERTY CO.

Electrical Contractors

1725 Church Street

San Francisco Misson 2624

MILL WORK

**ON SACRAMENTO AND
RICHMOND
WAR HOUSING PROJECTS**

Robert McCarthy Co.
General Contractors

by

MOORE & GARLICK

1716 Alhambra Blvd.
SACRAMENTO, CALIF.

All kinds of Mill and Cabinet Work

War workers occupying the 4,000 units of apartment housing (now being completed by Robert McCarthy Co. at Richmond) will enjoy the warmth of good heating this winter.

**WARM AIR HEATING
SHEET METAL
FLUES**

Furnished and Installed by

**ATLAS HEATING AND
VENTILATING CO., LTD.**

557 Fourth Street, San Francisco
1451 Thirty-second Street, Oakland

FLOOR COVERINGS

for 4,000-unit

WAR HOUSING PROJECT
Richmond, California

Being Installed by

KENYON BROS.

825 Valencia Street
San Francisco

QUALITY ROOFING

on the 4,000-unit Apartment Housing Project for U. S. Maritime Commission, Richmond, California.

ROOFING SERVICE & SUPPLY CO.

D. H. Myers, Manager
201 Red Hill Avenue, San Anselmo

Better Stairs for War Housing



Typical Stair Entrance, 4,000 Apartment Housing Unit, Richmond

SOME OF OUR RECENT
CONTRACTS FOR
ROBERT MCCARTHY CO.

General Contractors

4000 units, U. S. Maritime
Commission, Richmond
1900 units, U. S. Maritime
Commission, Richmond
1000 houses, Chabot Acres, Vallejo
Miscellaneous Army buildings,
Presidio of San Francisco

Manufactured and Installed by

J. di CRISTINA & SON
STAIR BUILDERS

3150 - 18th Street

• Phone HEmlack 8111

• San Francisco

GRADING and FILLING

4,000 WAR APARTMENT
UNITS (Zone B) at
RICHMOND, completed
in record time by

E. P. Lindquist & Bro.

1329 Albina Avenue
Berkeley, California
Phone ASHberry 5119

LANDSCAPING and PLANTING



Richmond 4000
Family Units
Apartment Hous-
ing Project for
U. S. Maritime
Commission, by

**LEONARD COATES
NURSERIES, INC.**

Ray D. Hartman, President-Manager

SAN JOSE, CALIFORNIA

DRAFTing CLASSIFICATION

3-H

*...will help to
win the Peace*

Just a draftsman's pencil. But through it, *ideas* flow constantly onto paper . . . ideas for architectural innovations; better building materials; new construction methods; finer, more efficient gas appliances. ★ You, the architects and builders, and we of the gas industry have provided many aids to better living through the medium of "3-H" in the hands of designers and engineers. *And, together, we shall give America many more . . .* thus helping to "win the peace" for millions of families who look forward to home ownership in a land of free enterprise and individual opportunity.

THE PACIFIC COAST
GAS ASSOCIATION

SERVING THE WEST — IN WAR AND PEACE

GAS FUEL

KEEPING PACE WITH
ROBERT McCARTHY CO.,

U. S. MARITIME
HOUSING PROJECT,
RICHMOND, CALIF.

30 Miles of Sidewalks

Installed by

General Floor Co.

5152 Highland Avenue, Los Angeles

110 E. 42nd Street, New York, N. Y.

PARAMOUNT Built-In Fixtures

USED IN MANY OF
THE BETTER WAR
HOUSING PROJECTS
ARE DESIGNED TO IN-
SURE MAXIMUM EFFI-
CIENCY AT MINIMUM
COST

*PARAMOUNT FIXTURES are
recognized by architects and
builders for their distinctive appear-
ance and superior workmanship.*

Paramount
Cabinets
BY
Paramount
BUILT-IN FIXTURE COMPANY
5107 Broadway, Oakland, California
Phone PLedmont 8100

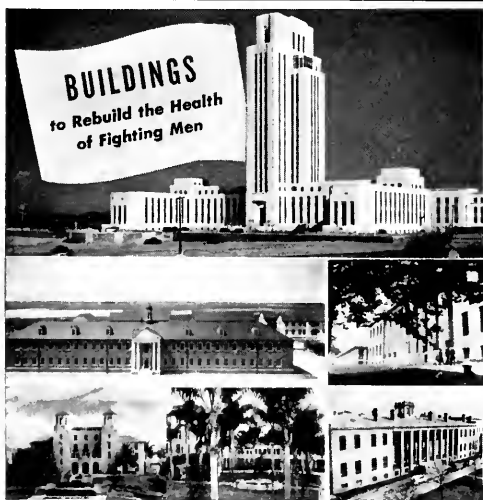

To provide proper hospital facilities in every military area, much new construction has been necessary, and scores of great medical centers now stand ready to serve, with more being built.

The hardware for doors, windows, cabinets in these vast projects runs into millions of units, much of

it made by Stanley.

The "F" flag we proudly fly is convincing evidence that Stanley workers are doing well this job of supplying hardware for these buildings, as well as producing many new items of war materiel. The Stanley Works, New Britain, Connecticut.

1843 **STANLEY** 1943

STANLEY
HARDWARE

BUILD NOW WITH KRAFTILE!

Look at these 9 big advantages
Kraftile Wall Units offer:

1. Priority-free!
2. Non-critical material!
3. Immediate delivery!
4. No limit on quantity!
5. Kraftile Wall Units replace steel and other gone-for-the-duration materials in load-bearing walls and partitions. These units have 10 times the State-required stress resistance.
6. Kraftile Wall Unit partitions go up in about one-third the time it takes for ordinary frame construction. One craft can handle the whole job.
7. No finishing required—these wall units come pre-tiled on one or both sides.
8. Upkeep cost ended. Kraftile Wall Units are scratchproof, waterproof, fireproof, stain-proof, can take the heaviest abuse.
9. Costs are surprisingly low.



For more information,
phone or write today to

KRAFTILE
NILES, CALIFORNIA

USE "Pennvernion" . . .
NOT JUST "WINDOW GLASS"

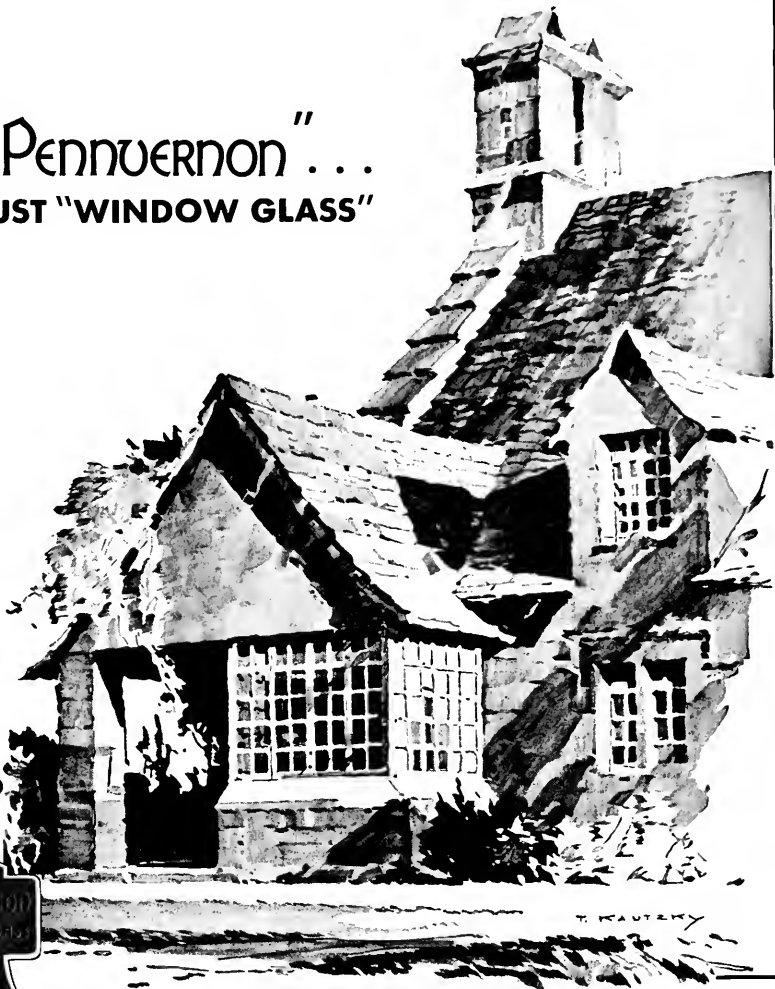

A GOOD window glass should be pleasing to look *through*, and pleasing to look *at*. Pennvernion Window Glass is both . . . to an unusually high degree. Its transparency permits clear, satisfying vision. And its reflective, brilliant surfaces insure greater exterior beauty in buildings with Pennvernion windows.

DISTRIBUTED BY

W • P • FULLER & CO.

BRANCHES AND DEALERS THROUGHOUT THE WEST

Quiet

... for offices,
schools, banks, hospitals,
radio stations, with . . .

CELOTEX
ACOUSTICAL MATERIALS

High sound absorption . . . easily
cleaned...paintable...low in cost!

WESTERN ASBESTOS CO.

Acoustical Engineers and Contractors
SAN FRANCISCO • OAKLAND • SACRAMENTO



QUALITY AND DEPENDABLE
Service

are the factors that influence architects and contractors when selecting lumber and mill work — Quality of merchandise — Integrity and Ability of the firm—Service in physical equipment — Experience and Personnel — All these factors contribute to a speedy and satisfactory completion of construction with minimum of time and expense.

MANUFACTURER OR DEALER IN

Douglas Fir—Redwood—Sugar and Ponderosa Pine — Plywood and Concrete Form Panels — Sash and Doors — Millwork — Insulation — Builders' Hardware.

E. K. WOOD LUMBER CO.

"Goods of the Woods" ©
LOS ANGELES • SAN FRANCISCO • OAKLAND

BAXCO

CHROMATED ZINC CHLORIDE

CZC

PRESSURE TREATED LUMBER

● **PROTECTS AGAINST DECAY
AND TERMITE ATTACK**

Specify it in your home
Available through Lumber Dealers

LOS ANGELES
601 W. 5th Street
Phone Michigan 6294

SAN FRANCISCO
333 Montgomery Street
Phone DOuglas 3883

J. H. Baxter & Co.

AGENTS FOR WEST COAST WOOD PRESERVING CO., SEATTLE, WASH.

CORROSIRON

U. S. REGISTERED TRADE MARK

an acid resisting alloy for

**Pumps • Valves • Chemical
Coatings • Drain Pipe & Fittings**

ARCHITECTS AND ENGINEERS
ENGAGED IN WAR HOUSING
AND POST-WAR PLANNING MAY
CONSULT OUR ENGINEERING

DEPARTMENT WITHOUT

OBLIGATION



PACIFIC FOUNDRY COMPANY LTD.
Engineers and Metallurgists

3100 - 19th Street
SAN FRANCISCO

NEW YORK

SAN FRANCISCO

LOS ANGELES

THE "LIVEABILITY" FACTOR IN A HOME

Homemakers today, forced by war conditions to do their own housework, are learning more than ever the value of electrical service in the home.

They are learning, too, the mistakes that were made in the wiring of their present homes—the awkward placing of switches and outlets — the inadequate wiring, resulting in blown fuses and inefficient operation of outlets.

People living in rented quarters blame the shortsighted policy of the owner in neglecting to provide proper electrical service. But those living in homes they have had built are, sometimes unfairly, blaming the architects.

Planning of future homes will put the electrical service at the top of the list of important considerations. Whatever else the architect's plans call for, the electrical service will be the key to the liveability of that home.

Study the new developments in the electrical world today. When you start blueprinting for the new homes of the electrical era, you will need all possible background in knowledge of modern electrical practice.

NORTHERN CALIFORNIA ELECTRICAL BUREAU

1355 Market Street
San Francisco



SAL-MO SUPPLY DUCT

PREFABRICATED
AND
PACKAGED

A Partially Completed Duct. Metal was Used Only for Hangers and Fittings.



A Typical Installation of Sal-Mo Supply Duct In a Defense Housing Project.

SAL-MO Supply Duct is the non-metallic material for constructing supply and return ducts for Warm Air Heating, Ventilating and Air Conditioning Systems. Its use permits many installations that would otherwise be impossible because of the Government rulings restricting the use of metals.

Sal-Mo Supply Duct is prefabricated and packaged in cartons at the factory. It is quickly installed saving many hours in erecting time. It also reduces shipping, trucking and storing costs to a minimum.

Ducts constructed of Sal-Mo Supply Duct are tight, quiet, and insulated. Low conductivity rate assures efficient operation in both heating and cooling systems. Smooth interior surfaces give low friction loss. Air tight construction prevents heat loss.

APPROVED AND LISTED by Underwriters Laboratories, Inc.

Sal-Mo Supply Duct is tested for Fire Hazard Classification; Inflammability; Fire Retardant Classification; Fire Spread; Moisture Absorption. It has a "K" Factor of 0.294 B. T. U. Available in 26 sizes for domestic and industrial installation, and in flat sheets.

*Sall Mountain Company also manufactures
Asbestos Paper, Millboard, Pipe Tape, Pipe
Coverings and many other Insulation Materials*

SALL MOUNTAIN COMPANY

176 W. Adams St. Dept. A Chicago



**THREE VIEWS OF HOUSING PROJECT FOR U. S. AIRPORT EMPLOYEES,
SACRAMENTO, CALIFORNIA**

There are 332 prefabricated units designed and built as permanent dwellings for Sacramento airport employees. Architects, William W. Wurster and Charles F. Dean.

MILLIONS FOR WAR HOUSING

Robert McCarthy's rise from a carpenter to one of Nation's outstanding contractors.

by FRED'K W. JONES



ROBERT McCARTHY
has war contracts that
total millions

THIS story was not written to laud the achievements of the architect. Not that the work illustrated is void of architectural interest, albeit the buildings are of a more or less standard type of design. One could not hope to find much beauty in the average war dormitory or apartment building. For speed and economy there must be mass production, and mass production means simplification of design. Certain provisions must be observed, as for example, flat roofs and wide cornices, features that lend a monotonous sameness to most government housing projects. So when these peremptory "musts" have been taken care of there's not much left for the architect to do.

We were reviewing in our mind the many different housing projects that have been described in this and other publications the past two or three years, wondering if any interesting angles had been overlooked. There were the San Francisco, Oakland, and Los Angeles projects started before the war and intended as slum clearance betterments for the low income group. Some of these municipally financed endeavors are today helping materially to relieve a housing congestion in critical areas, although they were not originally intended to serve that purpose. Other projects described have included those handled by the FPHA, which are models of well planned and improved community dwellings.

TED JOHANN'S
Project manager pointing to
McCarthy's achievements



While we were ruminating our 'phone jingled. A subscriber wished to know why we never give the contractor a "break." Meaning what? we asked. "Well," he replied, "I have in mind at least one contractor in San Francisco who is doing a whale of a job building houses for war workers. He has completed enough houses to shelter the population of a fair-sized city, and soon he will have doubled that number. For ten years before the war his biggest contracts were small town postoffices. Today this builder—his name is Robert McCarthy—is completing the largest single contract awarded by the Government for war apartments in the nation. The project is for the U. S. Maritime Commission, located in Richmond, and consists of 4,000 family units and 74 utility buildings. The approximate cost is more than \$6,000,000."

332 Prefabricated Dwellings

Learning that this was only one of many large housing jobs successfully handled by this man McCarthy, we decided his work justified a better than average review of his achievements. So we are, in this issue, illustrating six of his more important housing contracts:

VALLEJO (a) Carquinez Heights, 700 prefabricated units; (b) Chabot Acres, 1,000 prefabricated units.

SACRAMENTO: 332 prefabricated units.

RICHMOND: (a) 1,800 permanent apartment units; (b) 4,000 apartment units; different design but similar type of construction.

ALAMEDA: 500 housing units, different design but somewhat the same type of construction as Richmond.

The last job which the McCarthy organization has been working on is at Richmond and scheduled to be completed the current month, 120 days after breaking ground for the initial unit. The first of these buildings was occupied May 17. Since then additional structures have been completed almost daily.

\$13,000,000 RICHMOND PROJECT DESCRIBED

It was to meet the need for additional housing facilities near Henry J. Kaiser's shipyards at Richmond that a plan was evolved whereby, instead of selecting a new site and carrying out thereon a mass housing project, the additional facilities required were dispersed throughout a conveniently located existing residential district. This program was adopted when it was found that in this district, within walking distance of the yards, were enough vacant lots which could be condemned as separate sites for permanent, two-story apartment buildings of nine- and thirteen-apartment-size to provide a total of 6,000 apartments. Funds made available for carrying out this project total \$13,000,000.

The buildings are all 38 feet wide; and the length is 84 feet for eight apartments and 108 feet for twelve apartments. The policy was to design and construct to a standard and a quality in materials and appearance that will not cause any depreciation in the value of adjoining property.

More views of the Sacramento Housing Project. Houses are occupied by employees of near-by airport. All shown on this page are single 4-room dwellings with open garage space.



at Sacramento Federal Airport

Prior to initiation of this project, temporary housing facilities, intended for use during war expansion only, had already been built in selected "sites." In contrast, this project in the residential district provides permanent housing that will continue to be attractive to peace-time shipyard workers after the war. This is in accord with the plan of the U. S. Maritime Commission to continue the building of ships of greater speed that will be needed for world trade after the war.

McCarthy devised a program to suit this particular job. There was advantage in starting work where streets were paved and all utilities were in; there was disadvantage in having to work close to occupied residential property with a minimum of space for materials and equipment. To compensate for the lack of storage space, plans were laid for extensive precutting of lumber and deliveries of just the right quantities of materials of exactly the right size only a few hours in advance of the time they would be needed. In this way stockpiles of materials and mill setups at the site were reduced to a minimum.

At convenient central locations special mills were set up for (1) precutting and prefabricating material for wall sections, (b) assembling warm-air heating ducts of plywood, (3) making redwood eaves troughs and downspouts and (4) cutting molding, glazing window sashes and putting on the first paint coat on door frames, sashes, etc.

The saws and small cutting mills were located long in advance of the first erection operations. While foundations were still being laid out, batteries of saws precut lumber to standard sizes, then stockpiled ready for delivery to special crews at the site.

Of the 169 buildings in the McCarthy contract, 97 were laid out for thirteen apartments and 72 for nine apartments. Whether of nine- or thirteen-unit size, all structures have the same general plan, being long, narrow buildings with each apartment extending transversely across the structure. This arrange-



Row of two-story apartment buildings at Sacramento is shown at the top of the page. The two center pictures are 4-room single dwellings of the two-floor type. Community building on the right.



4,000-UNIT RICHMOND HOUSING PROJECT

From top down: (1) Nailing 1x8-in. pine boards over which were laid heavy tar paper, then linalum; (2) Prefabrication of warm-air heating ducts; (3) Stockpiles of heating ducts ready for delivery to each building; (4) The usual roof construction was used. However, all pieces were mill cut, trucked to the building and erected.

ment gives each apartment a 12x18-foot living room with a folding dining table in an alcove and a centrally located kitchen and bathroom on opposite sides of a passageway leading from living room to bedroom. Living room and bedroom have windows. At each end of the building a "lean-to" roof provides a second bedroom for the end apartment. The laundry includes double trays, ironing boards, etc., and the furnace room has a warming furnace and an automatic water heater serving the entire building.

CHABOT ACRES DRAWS NATIONAL INTEREST

This would not be a complete story of Robert McCarthy's achievements if we neglected to tell of his success as builder of the William Wurster prefabricated houses at Chabot Acres, and of which there are 1,000, all built to government specifications down to the minutest detail. The architect left nothing to the builder's imagination. From electrical outlets and their quality, to glass mirrors built into the bathroom walls, the specifications were plain as daylight. It is said that some of the carpenters even joked about the exacting number of nails that were required to go into a prefabricated section.

Soon after starting the Chabot Acres project McCarthy got himself into print by turning out sections for a complete home in 19 1-5 minutes. Allowing an additional 15 minutes for erection, he was building homes at the average rate of one every 34 minutes.

Mr. McCarthy predicts that out of the Chabot Acres project will develop an honest-to-goodness postwar housing plan with prefabricated houses built to suit the most discriminating owner. In fact, preliminary plans are already under way for prefabricated homes designed along ultra modern lines with exteriors to please the builder. On page 24 is shown a suggestion for a summer home developed by William Wilson Wurster in response to many requests to the McCarthy organization for a design and plan of a prefabricated house.

In this design, notice that the floor plans are crossed with squares. Three of these

4,000-UNIT RICHMOND HOUSING PROJECT

At right is a close-up showing removable wooden scaffold hooked into window openings. Fireproof gypsum board is nailed over tar paper which, in turn, is covered with California stucco.



Left is another view showing outside finishing of buildings with stock piles of gypsum board on ground ready for erection. Crews specializing in this type of work are moved from building to building to facilitate speed.



THREE OF 285 FOURTEEN-APARTMENT BUILDINGS AT RICHMOND, ALL OF WHICH WILL BE COMPLETED THIS MONTH—A 4,000-UNIT PROJECT FOR THE U. S. MARITIME COMMISSION



**TYPE OF PERMANENT APARTMENT UNITS FIRST TO BE BUILT IN RICHMOND
BY THE ROBERT McCARTHY COMPANY FOR U. S. MARITIME COMMISSION**



**A THIRTEEN-APARTMENT BUILDING, OF WHICH THERE ARE 6,000 UNITS DESIGNED BY
WILL G. CORLETT AND ARTHUR W. ANDERSON, ARCHITECTS AND ENGINEERS**



**McCarthy-built barracks for housing alien evacuees at
Tanforan Race Track. 170 barracks were built in 7 days
against a time limit of 15 days.**



**View shows prefabricated house erection in Vallejo with
one roof section on the ground ready to be placed on the
building.**



**LATE PHOTO SHOWING LARGE GROUP OF THE 4,000-UNIT RICHMOND PROJECT
ONLY THE PAVING REMAINS TO BE LAID**



**DETAIL OF 14-APARTMENT BUILDING OF THE 4,000-UNIT PROJECT,
RICHMOND, CALIFORNIA**

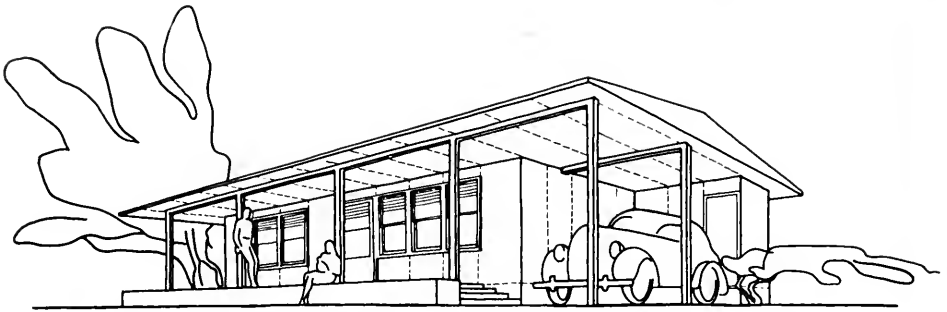

The HOME of the FUTURE— Pre-fabricated?

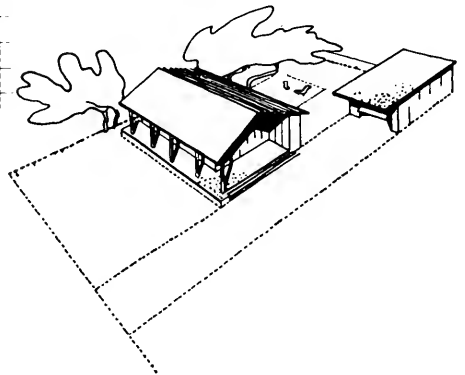
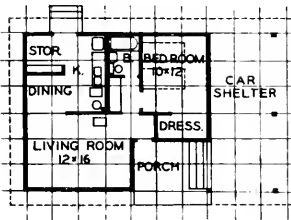
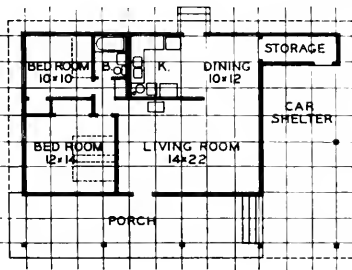

The first of a series of homes planned for individuals, prefabricated to save money and to assure sound construction. Drawing shows how standard sections can be used. The upper floor plan shows a large living room. Each floor section is made up of three of the squares shown on the plans and measures 4x12 feet. Both floor plans were adapted from the Chabot Acres government homes. Wm. W. Wurster, architect.



GROUP OF PREFABRICATED HOUSES, CHABOT ACRES, VALLEJO, CALIFORNIA

Altogether, the Robert McCarthy Company built 1,700 of these prefabricated dwellings and at the time of completion, summer of 1942, the buildings were said to offer the most livability per dollar of cost.



ANOTHER VIEW OF CHABOT ACRES PREFABRICATED HOUSES

William W. Wurster, architect of buildings, and Franklin and Kump, architects of site plans.

squares make up one prefabricated floor section of 4x12 feet. As long as an architect plans in floor sections of 4x12 feet he can design a home of any size, with rooms of any size, made up of a given number of these standard units. Wall sections, likewise, are built to follow these standard floor sections.

The method of building this summer home would be not unlike the process followed at Chabot Acres. The floor stringers are cut to exact length right to the fraction of an inch. Then they are placed on a table which is equipped with metal jigs that hold the stringers in position. There is not even a slim chance that the stringers can be knocked out of "plum" while being nailed. In this way each floor section is square and of the exact size. When the stringers are firmly nailed, the tongue-and-groove flooring is toe-nailed to the stringers.

First-grade lumber only is used, assuring that such standard sections are of the finest materials. Wall sections, likewise, are built in a similar manner and are complete with electric wiring between the walls where required, windows and doors cut out, casements added and even small holes are cut for light switch receptacles. Now in the future, should one order such a home, these prefabricated parts will simply be loaded onto a truck and carted to the building site for erection. Any exterior finish or style is possible at little added expense.

HOW McCARTHY GOT HIS START

In conclusion the reader is probably asking himself how this man McCarthy happened to get into the contracting business.

According to the builder's own story he got his start while working as a carpenter for a man who didn't care to be told how to save time and labor on his jobs. Because this young carpenter persisted in offering advice he was fired. Ambitious and unafraid of work, McCarthy started in for himself. The first job he figured was a \$5,000 home. He got the con-

tract, built the house and made a few dollars. The next eight years were tough going. Then one day he was given an opportunity to figure a government postoffice. That marked the beginning of a successful association with Uncle Sam. Following completion of a \$100,000 postoffice he was asked to figure some army work. Successful in bidding, he was called in by the commanding officer for his instructions.

"This job," bawled the colonel, "must be completed in 90 days or else . . ."

The contract called for the erection of a 54-room office building of reinforced concrete, complete with heating, wiring and plumbing. At that time 90 days were considered fast for such a job, but McCarthy assured the commandant he could meet the requirements. And he did. In just 29 days the completed building was turned over to the army!

Other government jobs followed, on the Coast and in Alaska and when the war clouds began to gather and housing needs became urgent McCarthy was in demand. No project was too big for the six-foot contractor.



FLOYD B. COMSTOCK
Technical Director for Housing Authority
of the City of Alameda.



500 APARTMENT UNITS FOR THE FEDERAL PUBLIC HOUSING AUTHORITY, ALAMEDA

Upper picture shows interior court, Contractor McCarthy in the foreground. . . . Below is a view of the first 100 apartment units completed.

In the space in the left center of the middle picture provision has been made for an office and community building. The 500 units will be managed upon completion by Curtis Anderson, director of the Housing Authority, City of Alameda. Architects of this project were Francis E. Lloyd, Carl F. Gromme and Hervey Parke Clark.

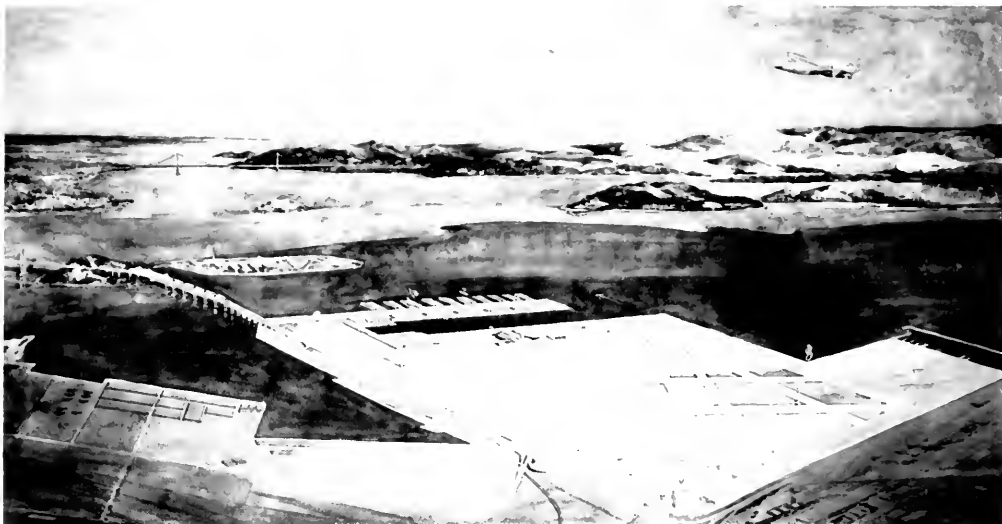

PROPOSED TRANS-PACIFIC AIR BASE, EAST SHORE OF SAN FRANCISCO BAY

Donald R. Warren Co., Engineers

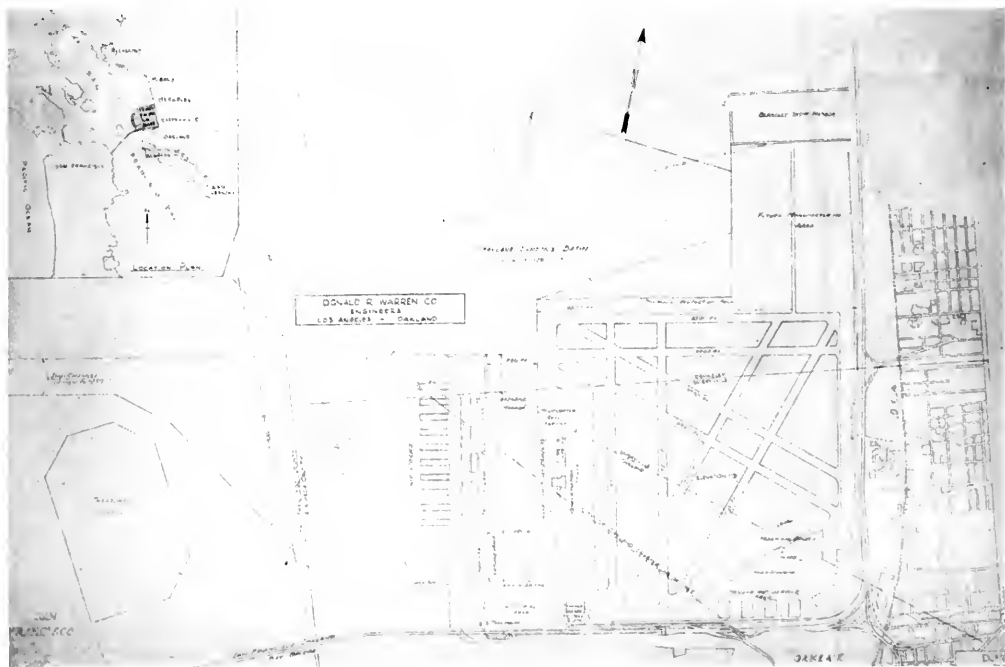

PLANS, TRANS-PACIFIC AIR BASE, SAN FRANCISCO BAY

ENGINEERS PLAN PACIFIC AIR TERMINAL

Huge air base to accommodate every type of flying craft proposed for east shore of San Francisco Bay. . . . A sixty million dollar post-war project.

In the March issue of *Architect and Engineer*, under the title of "Wings Over Architecture," H. G. Maas discussed the future of aviation and its probable effect on architecture, prophesying changes in the design of buildings and the erection of structures that would provide convenient landings for inter-urban passenger and cargo traffic. Naturally there are those with less vision who disagree with this writer, although they believe the end of the war will see vastly increased use of the plane. Some 250,000 men are being trained in this war to fly airplanes. It's natural to assume that in peace time many of them will still want to fly.

Before the war this country had a maximum number of 352 airplanes in the entire air transport industry. A lot of noise for a very few planes, one expert has commented. That our plane production facilities after the war are going to be taxed to the utmost, is the prediction of another expert who visualises the building of thousands of new planes for passenger and cargo needs. To convert our military planes into commercial planes would be disastrous, in the opinion of experts. Aside from using the motors from these planes, new bodies and equipment will be needed and this means the conversion of many manufacturing plants into peacetime airplane factories. According to William A. Patterson, president of the United Air Lines, the transport plane industry will be needing 5250 planes after the war, a tremendous development when one considers that the prewar volume was only 350.

As to possible changes in the lay-out of our cities, the location and construction of buildings, etc., Mr. Patterson made this statement in a round table broadcast, sponsored by the University of Chicago, and released over the National Network:

"Our cities will have to be rebuilt. I grant you that a great city like New York, or Chicago,

or San Francisco, or Paris or London cannot be rebuilt so easily. On the other hand, the small town, which for economic reasons is bound to become an international airport, is going to have a flying field which will be the center of community activities—just as the old city square was in medieval times. This airport will be the heart of the city, with hotels and business offices around it. That's where the life of the town will be concentrated.

"The public's use of the helicopter must not be overlooked. Some people say that within a few years we're going to land on our office buildings and possibly take an elevator down to our floor."

To this assertion Waldemar Kaempffert, science editor of the *New York Times*, opines:

"And why not? That's not a wild-eyed dream to me. I see no reason why the top floors of a properly constructed office building should not be given over to housing the helicopters. You could fly off to work in the morning from your home and back yard and land on the roof of your office building; and from that roof back to your home in the evening."

CLOSE IN AIR BASE FOR S. F.

At least the end of the war is going to see unparalleled activity in airport construction with airports built much closer into our business districts than at present. And this leads us to a description of a proposed new air base to serve the San Francisco-Oakland metropolitan area, offering a centrally located west coast terminus for trans-Pacific and western hemisphere air lines. The Bay region airports are handling passengers at the rate of 1000 per day and it has been estimated that in normal times the volume will be twenty-five times that number.

Location of the proposed new air base is north of the San Francisco-Oakland Bay Bridge, on the east side of the bay. It would be within ten minutes of the downtown districts of San

Francisco and Oakland, 35 minutes nearer than now, to these metropolitan city centers.

The Trans-Pacific air base is being sponsored by a non-profit, non-political organization known as the Metropolitan Developers, formed for the scientific analysis of problems of local metropolitan concern, and has no connection with the Parr Terminal project bordering Emeryville and Berkeley. The group includes Major-General Walter Sweeney, Attorney Ray C. Hackley, Jr., Major Ernie Smith, and Engineer Donald R. Warren.

The total cost of the development is estimated at \$60,000,000. In addition to a Class 4-A airport, with eight runways, varying in length from 8,500 ft. to 10,000 ft., the project includes a base for seaplanes, ten docks for ocean-going vessels, facilities for servicing lighter-than-air-craft, and provision for a helicopter taxi service to nearby population centers. This class of airport design will accommodate the heaviest and largest of planes. An extensive manufacturing area has also been provided for in the filled area.

To be of commercial value the complete development need not be made all at the same time. For \$35,000,000 the area could be completely filled in, four of the runways and a dock constructed with rail and building facilities, and hangars and important buildings erected. Further expansion could then be made as needed.

HUGE FILL OFF OAKLAND WATERFRONT

The 3200-acre fill will require 88,000,000 cubic yards of material, which will be obtained by dredging in the seaplane harbor, ship turning basin and channel. The fill will extend northerly as far as the present Berkeley Yacht Harbor, and the abandoned Berkeley pier will be removed to give a larger seaplane harbor. Treasure Island, built of dredged material as a site for the Golden Gate International Exposition, and now used as a Navy seaplane base, embraced an area of a little over 400 acres.

The fill would be placed to an elevation of plus 13 ft. above mean low water, while the seaplane harbor will be dredged to a depth of

25 ft. and the ship harbor to a 35 ft. depth.

Ten docks, each 200 x 800 ft. with a slip space of 250 ft. between, are provided for in the ultimate plan. The turning basin is to be 6250 ft. wide at the docks, tapering to a 1000 ft. channel north of Treasure Island.

A rock face around the fill will be required for protection against tidal action. This rock will be quarried from nearby sources. Quay walls on the dock front will be a part of the harbor development.

A large area on the north has been reserved for a future manufacturing expansion. This area is designed for those industries requiring close proximity to such an airport for testing purposes, rapid transportation, etc.

The seaplane harbor is to be 1500 x 6800 ft. to allow adequate space for taxiing and take-off for the huge seaplane transports. It is located on the seaward side of the development, but is protected from rough water by the dock structures.

Commercial facilities only will be provided, since private planes would hinder the efficient use of such a great shipping center. Smaller airports in the vicinity will be entirely adequate to accommodate private planes.

The plans have been prepared so that there will be no interference with existing traffic in the region. One overpass structure will be required over the Bay bridge east approach for the eastbound traffic from the base, to eliminate a traffic crossing. Traffic from San Francisco will leave the bridge west of the present toll plaza, and double back under the bridge. All other lanes of traffic to and from the base can be handled by direct feeder lanes together with extra acceleration lanes.

PROVISION FOR HELICOPTER TAXIS

A service road entirely bordering the fill is planned. Next to this will be hard-standing areas for taxiways and parking aprons. The eight runways, each 250 ft. wide, are arranged to accommodate a large traffic volume regardless of the direction of existing air currents. There will be two runways north and south and two east and west, each 8500 ft. long. One of the two pairs of diagonal runways will be 9500 ft. and the other 10,000 ft. long.

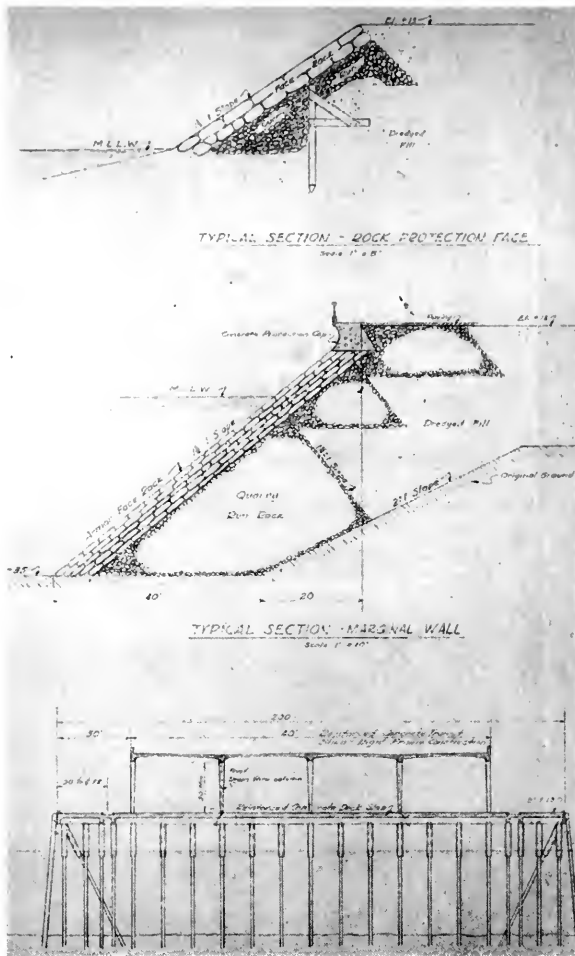

TYPICAL SECTIONS, PROPOSED TRANS-PACIFIC AIR BASE

On the south side of the air base will be located the hangars for the planes. Toward the west will be repair shops and fuel service areas.

Looking toward the not-too-distant future, a provision is made in the plans for a helicopter taxi service to serve the air base. This additional space will be made available north of the administration building and adjacent to the seaplane harbor. On the opposite, or south-east side, mooring masts will be available for lighter-than-air craft.

Railroad facilities can easily be provided into the base, since both the Santa Fe and

Southern Pacific railroads have lines paralleling the east shore of the bay.

An administration building of the most modern design is contemplated, to cost approximately \$2,000,000. It will embody features enabling express and mail to be handled with the greatest efficiency. Passenger traffic will be expedited by a curved system of ramps whereby passengers can walk directly to their plane without setting foot on the airfield.

Preliminary plans for the project have been prepared in the engineering offices of Donald R. Warren Co., to which we are indebted for information embodied in this article.—F. W. J.

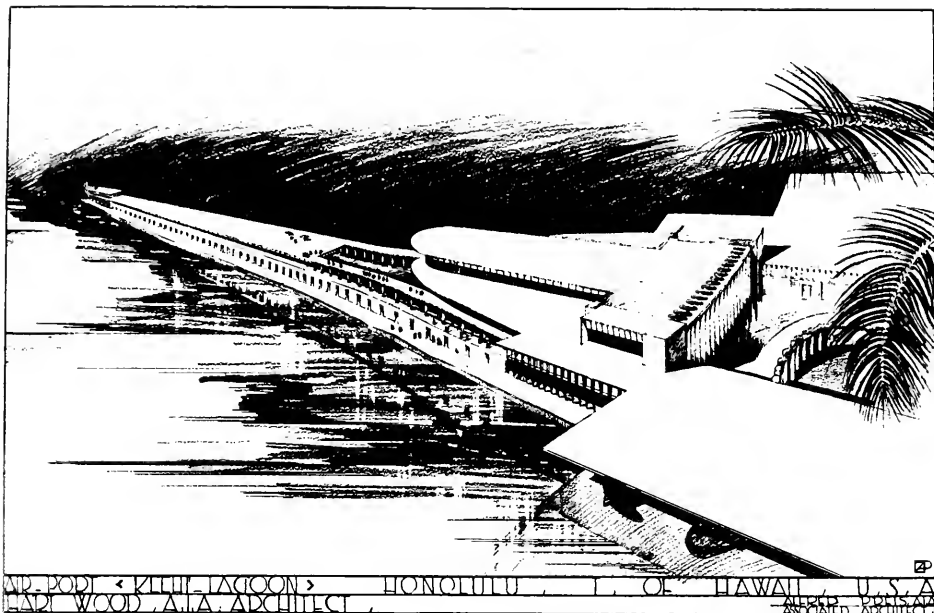

PROPOSED AIRPORT AT KEEHI LAGOON, HONOLULU, T. H. OF HAWAII, U. S. A.
 HART WOOD, ARCHITECT; ALFRED PREIS, ASSOCIATED ARCHITECT

PROPOSED AIRPORT AT KEEHI LAGOON, HONOLULU, T. H.
 Hart Wood, Architect; Alfred Preis, Associated Architect.

UNIQUE DESIGN FOR TWO-IN-ONE AIRPORT

From distant Honolulu comes an announcement from the office of Hart Wood, architect, of postwar plans for an airport of unique design—unique because it combines two airports of major size in one project, both functioning through one building and both handling local, domestic and foreign traffic.

Construction of the Keehi Lagoon Airport is scheduled to start immediately after the war, according to Mr. Wood, who laments the scarcity of up-to-date material on the subject of airport terminals, due, he thinks, to the phenomenal development of aeronautics and air transport, coupled with a marked uncertainty in regard to future developments. For example, he writes that in answer to a questionnaire regarding plane sizes, etc., one factory gave 70 feet as the possible height of tail fin. This,

if it materializes, may necessitate a radical change in hangar design. Projected plane sizes vary considerably.

Again, Mr. Wood points out, there is uncertainty about the proper accommodations for docking, loading, etc., of sea planes. Also the development of land planes, particularly the freight carriers, will surely be such as to require the invention, or at least development, of facilities and accommodations for loading and unloading to meet new conditions.

Referring to the plans it will be noted that the scheme permits of (a) introducing vehicular traffic into the middle of an airfield, even though the field consists of a combined land and seaplane unit; (b) is capable of almost unlimited expansion.

The scale of these reproductions is very

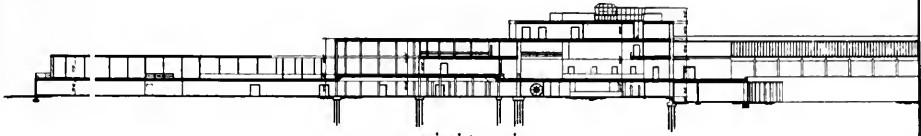

LONGITUDINAL SECTION .



LOADING - PLATFORM FOR SEA - PLANES .

PASSANGER - CONCOURSE .

LOADING - PLATFORM FOR LAND - PLANES .

SECTIONS THROUGH BUILDING .

SCALE - 1/8" = 1'-0"

KIHEE - LAGOON - AIR - PORT .
HONOLULU - I. OF HAWAII .

ARCHITECT HARRY WOOD, A.I.A.
ASSOCIATED ARCHITECT ALFRED PERLS, A.I.A.

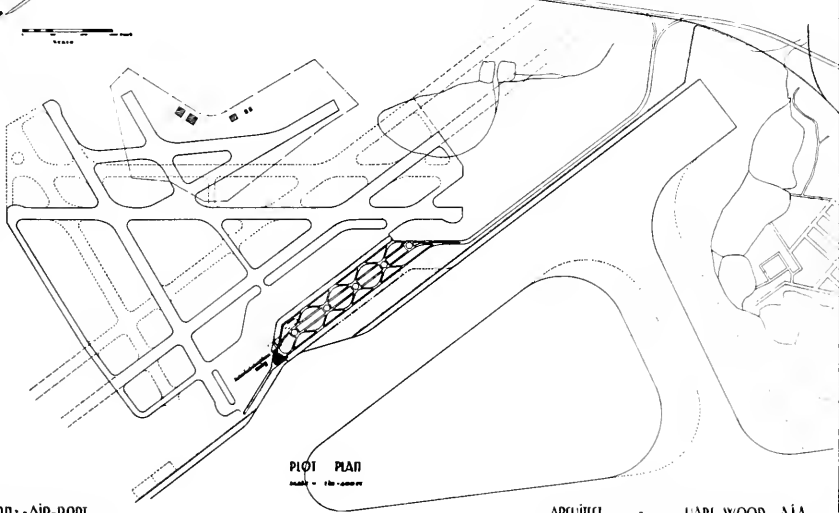
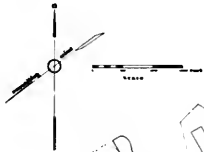

PLOT PLAN
SCALE - 1/8" = 1'-0"

KIHEE - LAGOON - AIR - PORT .
HONOLULU - I. OF HAWAII .

ARCHITECT HARRY WOOD, A.I.A.
ASSOCIATED ARCHITECT ALFRED PERLS, A.I.A.

close to 50 feet to one inch, a correction apparently overlooked in making the reproductions.

The control tower shown on the perspective to be at the end of the passenger concourse has been moved to the top of the main building, although future expansion needs may require that it be moved back again.

While accommodations for airline companies are provided on the third floor it is planned that in the future such accommodations may be in the arms of the Y extending out in front of the building.

THE PLANE OF TOMORROW

Since the war began statesmen, business men and just "planners," recognizing the dislocation of the normal economy that has been caused by the war, have been busy evolving plans that will soften the change-over from war to peace.

Many of the plans have been extremely visionary. And their accompanying publicity has been such that the people, instead of being enlightened have been confused. The post war plan of Chicago and Southern Air Lines for a Polar Great Circle Air Route that will connect the East Indies with the West Indies, has a really definite aspect, although it must be admitted it smacks of bold pioneering comparable to that of the early explorers and navigators.

What we may expect of the aviation industry after the war may be gathered from the following views of President Carleton Putnam of the Chicago and Southern Air Lines:

"Twice in modern times new kinds of transportation have re-shaped the world. First there was the steamboat which made every navigable river a highway of commerce and quickened trade on the oceans. The hey-day of the steamboat was a prosperous and romantic era. On the seas steamships tied nations closer together, stimulated the exchange and production of goods and went far to build mighty nations.

"Next the railroad appeared, shortening land distances and opening the interiors of continents to development. It moved people inland from coasts and rivers where the steam-

boat was centering population and built cities far from any water route.

"Now comes the airplane, which is making enormous progress in speed and carrying capacity under the stimulus of the war. Undoubtedly this swifter means of transport is blue printing another series of far-reaching changes.

"Freight planes carrying more valuable sort of goods will ply the air routes, opening wider opportunities for business and manufacturers.

"Architects of tomorrow would draw air routes in straight lines, but only those that tap important trade centers and fuel depots are likely to become commercial possibilities."

What all of this will mean to the Pacific Coast, only time can tell. But certainly the after-war development of flying will bring new opportunities to our State and nation. Several cities in the Midwest have already started programs to secure facilities to accommodate international air travel and cargo. Many cities, because of the extent of federal war-time expenditure for airports, have so much that would be needed that it would be tragic indeed if they allowed this advantage to disappear because of lack of interest.

Chicago and Southern's recent application to the Civil Aeronautics Board to operate a post-war trans-Alaskan air service from Chicago to Singapore and Batavia, establishes the shortest proposed route between the East Indies and the West Indies. This is a dramatic step in presenting the practical side in which the plane of post-war days will change things.

In a recent speech delivered before the American Society of Planning Officials in New York City, Bror Dahlberg, President of the Celotex Corporation, predicted that "Cities and suburbs of the post-war era will be planned and built along aerial highways, instead of being dependent upon earthbound transportation as in the past. The suburbanite who now dashes breathlessly to catch the 5:15 train for home at night will find his future counterpart in the man hurrying to catch an aerial bus or to take off for home in his own private helicopter. Cities may be spread over a radius of 75 or 100 miles.

LARGE SCALE POST-WAR PLANNING

Old concepts of city planning must be discarded after the war, declares a report of the Committee on Post-War Reconstruction of the American Institute of Architects, which held its seventy-fifth annual meeting in Cincinnati, May 26 to 28.

"Americans will not be able to afford to have their ways of living and working hampered by city patterns that have outlived their usefulness," says the committee, of which Dean Walter R. MacCornack of Massachusetts Institute of Technology is chairman. "The nation is beginning to realize that large-scale design and large-scale rebuilding must be employed to bring the depreciated and decaying central areas of our cities up to a modern state of efficiency.

"Large-scale replanning in America does not mean planning by a dictator who knows how to give the people what is good for them. Planning in America means fundamentally the establishing of harmonious relationships between the individual and the community of which he is a part. Democratic planning means individual initiative attuned to the responsiveness of the group.

"It seems apparent that any comprehensive scheme for replanning and redevelopment must recognize the necessity for changing the point of view in planning from the basis of the individual property to the basis of the locality and to planning for groups of properties and groups of buildings, instead of for the individual building and the individual plot."

The advent of the automobile, the creation of good roads and express highways, it is pointed out, have accelerated the revolution in our concepts of the use of land—urban, suburban, and rural.

"Improvements in transportation during the past forty years, the report continues, "have stimulated two distinct trends: (a) concentration and intensive use of land at strategic points in the city; (b) a movement for decen-

tralization and dispersion. These trends have produced over-concentration and congestion surrounded by rings of neglected and decaying properties.

"All types of cities have experienced some phase of these trends, and in all types of cities and towns will be found the neglected and blighted areas close to the business centers. In addition, all cities where growth has taken place have witnessed a rapid growth around the perimeter, often unregulated and frequently of a type which creates blight and many difficult problems occasioned by the transfer of land from rural and agricultural uses into suburban residential or industrial uses.

"Unregulated urban growth has created economic and financial problems which demand attention. A cause which has contributed to the chaotic growth has been the fact that the development of real estate has proceeded almost entirely on the basis of the development of single plots of property for individual ownership. Only in rare cases has effective planning been done on a group or locality basis.

"Expert opinion is now pretty well agreed that growth by small units, unrelated to the larger whole of district, neighborhood, and the city, is responsible for the present condition of great areas of blighted properties which are found in nearly all American cities."

Owners of property, the committee holds, must realize that they cannot plan their own properties without recognizing their relation to other properties. "Movement of pedestrians and vehicles within the city depends on plans made by the incorporated municipality," the report adds. "It is the established task of the municipality to maintain the streets and public services that are needed.

"Originally, cities took over and maintained as streets such paths and rights of way as the public found it necessary to utilize, or such street areas as the property owners found it

convenient to turn over to the city for public communication. In early stages of development, most communities establish relationships as a result of habit or instinct.

"In our great modern cities, these services are so intricate that their details must be worked out by experts long in advance. Projects for water supply, sewers, rapid transit, have become an important part of the municipal task. In some cities the distribution of gas and electricity is a municipal service, although in most cases gas, electricity, telephone and telegraph communication, and often rapid transit, are services performed by public utility companies under charter from the city.

"Until recently the common councils or governing bodies in American cities have been responsible for the establishment and maintenance of the public services. As the complications of cities have increased, it has been found necessary to create professional planning commissions composed of trained technicians.

"To these commissions have fallen not only the responsibility for planning for the expansion and growth of modern cities, but the even more delicate responsibility for replanning the older sections of the cities to provide the improved facilities needed for modern life. We have learned that there is more to this than working out procedures for street widenings.

"Although a struggle was necessary to prove the need for city planning commissions, their usefulness is now generally accepted.

"Actually, the master plan made by the commission is the pattern within which the public and private interests must operate. It establishes the framework; others must act to fill in the details which concern them.

"There is tendency, nevertheless, on the part of some, especially owners of property, to feel that all needed planning is the responsibility of the official city planning commission. Where the size of a municipality is great, it should be obvious that to do a complete job of planning, including the replanning and reconstruction of whole areas of private properties, would require a staff so large as to be unwieldy and destructive to initiate.

"It is accordingly becoming evident that in order to maintain initiative and in order to provide for the details of the city plan, some technique must be developed which will permit local groups of property owners and the local citizenry to undertake the task of analysis of their own districts, with which they are familiar, and enable them to suggest plans to their planning commission for the redevelopment of these localities.

"This is necessary, on the one hand, to bring all neighborhoods into conformity with modern standards of life, and on the other hand, to restore them as useful parts of the city as a whole. The city planning commission can then coordinate these district plans into a pattern for the matured city plan."

CHINA'S PLANS FOR POST-WAR STANDARDIZATION

The reconstruction of war-torn nations "will be a task unprecedented in the annals of mankind," but China will be faced with an even more burdensome problem than that of other countries, the Chinese Institute of Engineers in America points out in a Forum on Post-War Industrialization of China, just published. In addition to the rehabilitation work, China "must further seek to raise herself far above the industrially backward position she occupied before the outbreak of the war."

The engineers who are members of the Chinese Institute are now in the United States studying industry here and working on plans for the industrial development of China. They have just started publication of a technical journal, the first number of which features the Forum on Post-War Industrialization, with industrial standardization as one of the important subjects under discussion. The publication will introduce Chinese technical developments to American readers and bring American technical information to engineers in China.

One of the problems of greatest interest in connection with the industrialization of China is the adoption of industrial standards, declares T. Y. Lu, author of the section on Industrial Standardization. Standards for the things China is going to manufacture or to buy must be defined not after the war but right now, he states. "The writer's bitter experiences in the past in supplying the spare parts for vehicles used both on rails and on highways in China make him realize how important and urgent the problem of standardization is."

HOME BUILDING AFTER THE WAR

By WILSON COMPTON*

A Man whose chores include reading everything which postwar planners write, told me recently that he thought he was wasting his time. "All that these forward-lookers do," he said, "is rewrite each other." That, of course, is not quite true, although it does have a germ of fact. Economists, who in good faith are looking for facts and not for proof, do find much the same basic prospects. But a sharp cleavage splits postwar thinking into two distinct channels. On the right is the postwar planning designed to restore our enterprise to its creative strength through freedom of private initiative. To the left is the prospecting for continuing, expanding, and intensifying government controls and government ownership in our national economy.

In the popular mind great wars are followed eventually by great depressions. Usually they have been. But most economists say and I think most of them believe that this is not necessary. Wars in fact are usually followed immediately by booms, and what is done in the boom is more likely to determine what will happen in the depression,—or possibly even whether there will be a depression. The Brookings Institute has made an interesting analysis of economic developments following previous wars about as follows:

1. A few months of business hesitancy;
2. A year or more of active business;
3. A period of trade and financial downward readjustment; and
4. Finally a considerable period of general activity.

This in itself is not a terrifying pattern.

BUILDING "CYCLE"

The building industry has been particularly sensitive to the ups and downs which the Brookings report summarizes. It has always been "cycle" conscious. By its scars we know that it flies high and falls low. Everyone knows that a pentup demand for new domestic construction will be ripe for another "cycle" as soon as

the war ends. Everyone knows too, or at least strongly suspects, that we will have to help rehabilitate other nations. The war may be "over" by degrees, but before it ends a large part of the plant and equipment for production, transportation, trade, public utilities and public services in many sections of many counties will have been destroyed. We hope it will not happen here. No one can be sure. We assume it will not. Probably it will be our facilities for production which largely will be expected to "replace" and "restore." Whether this reserve of demand, both domestic and foreign, will mean another exaggerated cycle of building inflation and deflation depends in part on what the Government does and in part on what we do.

In March, Secretary of the Treasury Morgenthau reported that even then there were 50 million war bond buyers, and 25 million in payroll savings. This is potential and, after the war, will be immediately available purchasing power. Government may be expected, under pressure, to make it and keep it liquid. Keeping war bonds in sideboard or sock or safety deposit box will not then be "patriotic."

It may take as long to restock the stores as it took to restore the stocks two years ago. Perhaps six months or longer—a year maybe. But how about a house! Can a home be built forthwith? The home-building industry isn't so mechanized. It does not have to re-tool so much. There will be building tradesmen eager for jobs. A dwelling requires much the same kind of materials as a barracks or a warehouse. The spending rush might convert a postwar replacement into a speculative prelude to another inflation. Construction business under such conditions can be "good,"—so good that its pay might turn out to be fool's gold. Uncontrolled inflation can impede a war; also it can wreck a peace.

The recent nation-wide survey by the United States Chamber of Commerce indicates that over 1,000,000 families plan to build or buy new homes within six months after the war. In-

*Secretary and manager, National Lumber Manufacturers' Corporation.

tended prices range from 33 per cent by owners who expect to pay \$3000 or less to 7 per cent who say they will pay \$10,000 or more for dwellings. Half of the million-odd expectant purchasers plan to pay less than \$5000. Home and farm building repairs and improvements planned for the same half year total an additional 6 billion dollars; and these potential owners have the money or expect to have the money with which to do it.

POSTWAR HOUSING

We are so accustomed in late years to the use of ciphers in our national budget that it is difficult to realize what 11 billion dollars for housing may mean in our national economy. A year ago the Department of Commerce estimated the dollar volume of transactions in each major division of American business in the first postwar year necessary to maintain the national production, at a level of \$132 billion, a figure which it estimated would be the amount of "gross national expenditure" in 1943. For construction the goal, it said, must be \$10.2 billion; for residential construction alone, \$5.2 billion. The Chamber of Commerce survey shows intention already of record of that much expenditure for new residential construction for the first six months, and enough rehabilitation expenditure to bring the six-months total to twice the year's entire quota.

Perhaps the exigencies and uncertainties of war-end will sweat down these impressive intentions. Even so, housing demand will remain enormous. Many estimates have been made public. The National Resources Board estimates that the number of new houses which the country will require will run from 900,000 to 1,200,000 a year for the decade after the war. Estimates of the Department of Commerce and the Committee for Economic Development are not much different. National Lumber Manufacturers Association statisticians have estimated, under reasonably favorable attainable conditions, "a million homes a year for ten years," mostly at costs less than \$5,000.

The United States now has about 37,000,000 dwellings. Of these a fifth "or something over 7,000,000," says the National Resources Board, "are ripe for replacement." That estimate may, I think, be on the high side. But there may be

little doubt that the Board is correct in its estimate that "nearly half of our existing housing is badly in need of repair or lacking in equipment * * * essential to health and convenience," or that at least \$10,000,000 urban dwellings need "major rehabilitation." This, of course, is secondary construction. But it is part of the building prospect.

LOW COST SMALL HOMES

On what price ranges will the housing demand be focused? What will the postwar house look like? Will it plunge existing dwellings into obsolescence? Will prefabrication substantially occupy the residence construction field? Will new materials displace old ones or merely improve them? Will the technological advances in wood-working, encouraged by war uses, dominate the home building industry? Such are the questions which are asked lumber industry statisticians and engineers every day.

In the widest open new home market is the forty per cent of American families with the so-called "lower incomes." Generally heretofore they have not been able to own their homes. Nearly always they have had inferior housing. But financially and comparatively they are faring better now than is any other group. In 1940, 42 per cent of the privately financed single-family houses built in the United States were financed on FHA-insured loans. By 1941, 13,000,000 families were living in dwellings built, purchased, or improved with the aid of such loans. Without FHA insured mortgage financing most of these houses probably would not have been built. In 1940 more than half,—56.8 per cent—of the new houses built for owner occupancy on FHA insured loans was by families with incomes of less than \$2500; 28.5 per cent with family incomes of less than \$2000. After the war there will be millions of such families with more money than homes.

Financing vogues are, of course, only one of the limitations upon the realization of the potential housing market. Arbitrary building codes, extravagant zoning, restrictive labor rules, and the esthetic lag of public tastes, will retard the conversion of any blueprint into practice. But that is no reason for not having a blueprint. People are said to be generally sensitive to the so-called "House of Tomor-

row." Many of the putative postwar house ideas sketched in popular print seem to be mostly for propaganda. They seem for the most part to have been designed neither by householders, architects, engineers, builders, nor by persons who know what kind of houses people will buy,—but by functionalists gone to extremes. They remind one of the "battleship of the future" pictured by a sketch artist recently in a national magazine. Naval designers saw it and laughed. The vessel was so weighted with armaments and armor that it would not float. Or the "automobile of the future" sketched in another magazine which, automotive engineers pointed out, would fry anyone who tried to ride in it.

HOUSING ECONOMICS

The postwar house will be compact; will have fewer rooms. The rooms will be functionally more convenient. They will not be revolutionary in design. People who have or can find the money will, by great preference, build single-family dwellings. Three out of four houses built in 1940 had a garage; and one in five had a two-car garage. But the proportion of houses without garages was increasing, and the proportion with multi-car garages was decreasing year by year. More people were buying homes before cars.

Many suppliers of building materials and equipment will prefabricate or preassemble parts which the builder can incorporate at substantial job savings; kitchens complete with standing equipment; bathrooms containing fixtures, and plumbing ready to button up, like mill-made doors and windows; recreation porches which can be attached or detached.

Factory produced panels, including movable interior walls, so that one room may be converted into two, or several rooms into one, are obvious prospects; as are floor section assemblies and prefabricated wall units for exteriors. It will be no more difficult to fit them into structures of distinctive dimensions and design than it is now to fit individual boards,—perhaps not as difficult; and it may mean substantial savings.

We will see less promiscuous use of the hammer and the saw on the job. Gradually, we will use fewer nails and more glue. We may likely

see wood-built houses without shrinkage or warping, water-proof, resin-bonded, with many laminated parts, and fire resistant. Wood airplane bodies, like the British Mosquito fighter-bomber, declared by our allies to be the most durable plane used in this war, are already showing the way to do this.

The problem in the postwar years, however, is more than to provide homes which more people can afford to buy. It is also to provide its share of the national employment necessary to maintain the peace which may have been won by war. The Committee for Economic Development tells us that, in peacetime goods and services, when war is over, in order to provide a needed 25 per cent expansion in employment, American industry must produce 35 per cent more than it produced in 1940.

If, after the war, as I believe, we shall need new homes a million a year for ten years, the lumber industry can do its part, and it expects to. In number the home building needs will be greater than in 1940, by 60 per cent. The average house will be smaller. Improved engineering will reduce by 20 per cent the amount of lumber necessary to build a house. The lumber itself will be more largely refined, fabricated, treated and assembled. It will provide more labor in the mills and factories. It will require less labor on the job. This probably will mean a volume of lumber and timber products in home building nearly one-third more than in 1940 and at least a comparable increase in employment in the woods and in the mills.

The war has forced lumber into many uses, both old and new. It has speeded the conversion of wood from a simple carpentry to a modern engineering material and lumber from a timber-using to also a timber-growing industry. Also it has accelerated the development of new metals, alloys, compositions and plastics which after the war will seek a permanent place in construction uses. The competition between materials, I anticipate, will be more severe than ever. Lumber will lose some of the uses multiplied during the past few years,—but not all. In its various forms, both old and new, it will, I think, continue to provide the backbone of an expanding home building industry.



INTERIOR OF TAVERN, LOOKING TOWARD BAR, SANTA MARIA, CALIFORNIA
Designed by Cheesewright, Mason & Company.

ENGLISH TAVERN AT SANTA MARIA INN

Reminiscent of the old English tavern, the new tap room illustrated here, is one of the more recent improvements completed at Frank McCoy's Santa Maria Inn. It dominates a one-story frame and stucco building, which has been erected at the north end of the Inn, and is accessible from the main lobby, as well as from the street. Design and erection of the tavern was supervised by Cheesewright, Mason & Company of Beverly Hills.

The tap room covers an approximate area of 900 square feet with bar extending the full

length of one side of the room, and a huge stone fireplace directly opposite. Plank floors, half timber ceiling, worm-eaten chestnut wood, waxed and treated to give it mellowness, lantern lights, rare English prints, and mildewed copper utensils, all make for an atmosphere reminiscent of the late sixteenth and early seventeenth centuries.

An interesting feature of the tap room lighting is the original lamp used by the early California gold miners in Sutro Tunnel.

WHAT WOULD HAPPEN WERE THE WAR TO END TOMORROW

Before you say you cannot answer this one, stop a moment to consider some significant findings of the U. S. Chamber of Commerce's latest Post-war Consumer Survey, just released.

First, look at the results from the standpoint of your competition.

2,590,000 families intend to buy automobiles—an immediate post-war market of \$2,331,000,000.

The major household appliance immediate sales potential is \$860,185,000—with:

- 1,715,000 families buying mechanical refrigerators,
- 1,260,000 families buying washing machines,
- 1,435,000 families buying stoves,
- 1,050,000 families buying vacuum cleaners,
- 1,330,000 families buying radios,
- 525,000 families buying sewing machines,
- 1,015,000 families buying electric irons,
- 385,000 families buying electric kitchen mixers.

The immediate post-war market for home furnishings will be approximately \$709,905,000—with:

- 1,365,000 families buying living room furniture,
- 735,000 families buying dining room furniture,
- 1,260,000 families buying bedroom furniture,
- 1,610,000 families buying rugs and carpets,
- 1,435,000 families buying linoleum.

A \$5,000,000,000 post-war home building boom is in sight, with 1,015,000 families intending to build or buy a new home within six months after the war is over.

- 33 per cent say they will spend \$3,000 or less,
- 26 per cent say they will spend \$3,001 to \$5,000,
- 24 per cent say they will spend \$5,001 to \$10,000,
- 10 per cent are not certain how much they will spend,
- 7 per cent say they will spend more than \$10,000.

Never mind the exact price figures—it's the percentages in low (59 per cent), medium (24 per cent) and high (17 per cent) brackets that count, let prices be what they may after the war.

Thirty-four per cent of all home owners in America say they would almost certainly make some sort of improvements or repairs in their properties within six months.

- 2,670,000 will paint exteriors,
- 1,150,000 will re-roof,
- 1,040,000 will redecorate,
- 592,000 will modernize kitchens,
- 512,000 will add rooms,
- 496,000 will add bathrooms,
- 464,000 will add porches,
- 416,000 will install new heating,
- 416,000 will improve bathrooms,
- 272,000 will make repairs,
- 240,000 will install new plumbing,
- 144,000 will refinish floors,
- 96,000 will remodel outside,
- 48,000 will finish attic or basement,
- 1,400,000 will do miscellaneous jobs.

Fifty-eight per cent of owning farmers would make farm improvements.

- 452,000 will add service buildings,
- 386,000 will repair barns,
- 338,000 will repair service buildings,
- 266,000 will add new barns,
- 161,000 will make other repairs,
- 147,000 will repair tenant homes,
- 105,000 will paint buildings,
- 87,000 will build new tenant houses,
- 2,800,000 will make miscellaneous improvements.

Thirty per cent of the 13 per cent of families who own property other than that on which they live will improve such property.

Expenditures likely to be made for home improvements are reported as follows:

- 28 per cent to spend \$100 or less,
- 18 per cent to spend \$101 to \$200,
- 14 per cent to spend \$201 to \$300,
- 20 per cent to spend \$301 to \$500,
- 6 per cent to spend \$501 to \$750,
- 6 per cent to spend \$751 to \$1,000,
- 3 per cent to spend \$1,001 to \$1,500,
- 2 per cent to spend \$1,501 to \$2,000,
- 3 per cent to spend more than \$2,000.

This all means an immediate post-war home and farm improvement market potential of \$6,000,000,000.

Many details are given in the survey on saving habits and other indices of post-war purchasing power, but they all add up to one important fact. People who intend to spend these sums will, by and large, have what it takes when the war is over. Incidentally, only one person in five is saving with a specific post-war purchase in mind.

ARCHITECTURE NOT A DECADENT PROFESSION

Writing to Harlan Thomas of Seattle, Regional Director, Western Mountain District, A.I.A., A. W. McIver, President of the Mountain Chapter, A.I.A., says:

"I have a chip on my shoulder and I might as well get it off now. I have been reading in the A.I.A. Bulletins from Washington, D. C., the "Washington Situation" in the Octagon, and articles in the architectural magazines with no satisfaction and with some concern. It seems that, from these articles, architecture as a profession is in a sad plight and must soon fade out of the picture. To all of this I do not subscribe. At last comes a ray of hope in the "Message from the President" in the January Octagon, except that he did not make it strong enough. I refer to his sixth paragraph. If we keep moaning and groaning it won't take the public long to think that we really are sick and are in dire need of a period of convalescence. I do not look forward to that period.

"I hear so often of the old bugaboo about the engineers being the chosen people and that nobody wants

the architects. If that be true, and I doubt it, whose fault is it? It would mean that somewhere we have fallen down. Having taken a combined course in civil engineering and architecture and having practiced in both fields, perhaps I view the situation in a different light. The government has treated the architect with some degree of fairness in keeping the word 'architect' before the public and in giving the major projects of the war program to architects. The firms doing professional work are known as architect-engineers, even if the work is strictly engineering. The contracts themselves are known as architect-engineer contracts and all the documents are signed as such. The important and complicated projects have all been under the direction of architects. I have recently looked over the plans of the Pentagon at Washington and fully realize the handicaps under which it was designed. Still, I duck when I have questions thrown at me relative to its merits. The chance of a grand solution to such an important building was muffed, and sad to say the tenant, being the War Department, is the boss at the moment. Architecture certainly didn't gain anything in its building. Are we sure we have lived up to our opportunities?

"As you know, I have until recently been connected with the Corps of Engineers, doing special work with architect-engineers. I came to know many architects from all over the country. The great majority of them were splendid and fully realized the problem. Some were still living in the 'good old days,' with flares of temperament, demanding comfortable quarters and offices, and with utter disregard for procedure, speed, substitution of materials, standardization, etc., and some had a distinct loathing for their presence on the projects. Unfortunately, these few cried longer and louder than the rest and created a bad impression on those in charge. Others stayed at home and practiced wishful thinking. Any architect who has the right to use the word after his name can find gainful occupation in the war program. Maybe it won't be in the sanctum of his own office and perhaps he won't be the boss, but at least he can earn a comfortable living. Who wants more under these conditions?

"Those who cry that architecture is a decadent profession are 100 per cent wrong. It isn't possible for one generation to have such an ill effect on the oldest of the arts. As an art and a science it is the symbol of life, as we understand life, and the forerunner of culture. Out of the embers of this holocaust will come a new culture tried by fire and fasting. The wounds have been too deep for civilization to regain its balance and poise without a specialist. Such a specialist must needs be an architect. His training entitles him to the task. The profession should take stock of itself, broaden its field of knowledge, feel the surge of the new freedom of life itself, and then take its rightful place and lead—not just go along."

"I realize that the average architect does not have the opportunity to perform the grand opus. Some of us

haven't the background, the education, the vision nor the will, but we can all adhere to the eternal fitness of things. The profession as a whole can slowly blend from a palette of politics, economics, religion, science and art an understandable picture of life. I believe this is possible.

"Now that the chip is gone and I have delivered my diatribe, I must apologize for its length and disconnected thoughts.

"Allow me to report to you that the Montana Chapter is scattered to the four winds, doing its bit in the war program. There are only four architects left in the State. Most are on a salary basis and getting by in good order, and they all report of the splendid opportunity it has been to learn new methods and new ideas. We, as a Chapter, look forward to a profitable post-war era."

PRIORITY ON LIGHTING INSTALLATIONS

Engineers, architects and building consultants are advised by the Conservation Division of the War Production Board to check all lighting specifications for construction or conversion projects which are now being drawn up, to make sure that they comply with the policy outlined in the "Design Guide for Interior Electric Lighting and Wiring of Wartime Construction."

Prepared by the Conservation Division, the Guide, although not an official order or directive of WPB, presents the conservation policy followed by WPB when considering applications for priority assistance to obtain fixtures and other materials required in lighting installations.

Use of critical materials in lighting installations has for some time been controlled by WPB limitation orders. Limitation Order L-78 controls the production of fluorescent lighting fixtures, in some cases calling for non-critical substitutes for the critical materials formerly used, and in others reducing the amount which may be used in production. An over-all saving of 70 per cent of the steel content in fluorescent lighting fixtures resulted from these restrictions.

Incandescent, fluorescent and other electrical discharge lamps were standardized under the terms of Limitation Orders L-28 and L-28-a.

The Guide, which covers the end use of various types of lighting installations, is a major step in the over-all conservation program to conserve critical materials in electric lighting installations without the sacrifice of effective seeing conditions.

In all instances before completing designs for lighting installations, the Guide should be consulted. Deviations from the policy outlined in the Guide may cause delay or possible denial of priority assistance when applications are reviewed by WPB analysts.

Copies of the Guide may be obtained upon request from the WPB Conservation Division, 11th and H Streets, N. W., Washington 1, D. C.

ARCHITECTS' BULLETIN

Issued For

THE STATE ASSOCIATION OF CALIFORNIA ARCHITECTS

Northern Section

STATE ASSOCIATION MEMBER
OF THE
AMERICAN INSTITUTE OF ARCHITECTS

Editor
William C. Ambrose

Address all communication for publication in the Bulletin to W. C. Ambrose, 369 Pine Street, San Francisco, California. Office of the Northern Section, 369 Pine Street, San Francisco.

STATE ASSOCIATION OFFICERS

Pres.....Norman K. Blanchard, San Francisco
Vice-Pres.....Walter R. Hagedohm, Los Angeles
Sec'y.....Rowland H. Crawford, Beverly Hills
Treasurer.....David H. Horn, Fresno

Regional Director—Southern Section
Gordon B. Kaufmann

Regional Director—Northern Section
Henry H. Gutterson

Executive Board—Northern Section

Pres.....Norman K. Blanchard, San Francisco
Vice-Pres.....Russell G. de Lappe, Modesto
Secretary.....Hervey P. Clark, San Francisco
Treasurer.....David H. Horn, Fresno

Board of Directors

Frederick H. Reimers, Francis Ward, Malcolm D. Reynolds, John S. Bolles, Andrew T. Hass, Henry H. Gutterson, Vincent G. Raney, Alfred C. Williams.

Northern Section Advisory Council

San Francisco District #1:
Clarence W. Mayhew, President
Elizabeth Boyter Henry Collins
Francis Chinn Edmund de Martini
Rudolph Igaz Mark Daniels
Charles W. Masten Vincent G. Raney
Noble Newsom
East Bay District #2:
Theo N. Thompson, Chairman
A. C. Williams
Loy Chamberlain
Berkeley District #3:
Gwynn Officer, Berkeley
North Bay District #4:
William F. Herbert, Santa Rosa
Marin District #5:
John S. Bolles, Ross
Lower San Joaquin District #6:
Russell G. de Lappe, Modesto
Upper San Joaquin District #7:
David H. Horn, Fresno
Santa Clara District #8:
Gifford E. Sobey, San Jose
Palo Alto District #9:
William F. Hempel, Palo Alto
San Mateo District #10
Leo J. Sharps, Burlingame
Sacramento District #11:
Herbert E. Goodpastor, Sacramento
Upper Sacramento District #12:
Clarence C. Dakin, Redding
Lassen District #13:
Ralph D. Taylor, Susanville
Monterey District #14:
Thomas B. Mulvin, Del Monte
Redwood Empire District #15:
F. T. Georgeson, Eureka

THE IMPENDING CRISIS

Some few years before the first shots crashed at Fort Sumpter, a book was published in this country outlining the struggle already taking place and warning of the Civil War. The title of the book was "The Impending Crisis."

Borrowing from the words of those days, we are now engaged in a great war, in addition to our world war. We shall have to decide soon after the close of our world war whether this country can long endure in its tradition of free enterprise, or whether "the State" shall direct all of our activities. This impending crisis has been hastened by the necessary assumption of strong authority by the national government in order to successfully prosecute the war.

Ordinarily our process of government is an adjunct of, and is financially supported by the people of the country who follow such paths as they please. There are only occasional "stop" signals installed by government in order to protect the weak from the strong. Through depression and war, our various governments have gone a considerable distance in the direction of assuming the ability to conduct all business, with a consequent squeeze on the opportunities of the individual, and with the increased burden on private business of the support of an enlarged governmental structure. Unless the trend is halted, the inevitable next steps are for private enterprise to be unable to support the too heavy governmental structure, and for government to take over.

No group of Americans has experienced the trend of events more vividly than has the architectural profession. Its members have seen the great assumptions of power by the huge offices set up, first in the Treasury Department in Washington, then in the various "Authorities," "Services," "Bureaus," and "Administrations" of the national government and in the "Departments of Public Works," in the "Engineering Bureaus," "Departments," etc., of the states, counties, and cities, and in local "Authorities."

The postwar planning now in progress will, if not redirected, accentuate the pattern, which, for the architect, indicates: "Work for the government, or starve!" The recently enacted Senate Bill 807, for instance, which creates a State Economic Planning Commission, will be directed by a board of office holders. It is more than human to expect a board of that composition to surrender any considerable part of the power conferred upon it, and to expect its members to call upon private enterprise to carry out the work placed under their jurisdiction.

The Remedy

Recent events have made clear that it is not impossible to halt the trend toward bureaucratic control. We have, fortunately in most cases, reserved to the delegates in our councils and congresses the right of levying taxes and of making appropriations of money. Our delegates are immediately responsive to the votes, and therefore, to the will of the people. But the congress-

men and council members must be told what the will of the people is. There are always job holders who have the time and the interest to tell legislators why their departments should have more money and why they should be enlarged. The citizens in private business must take the time and take the interest to make themselves and their ideas known to their elected representatives. If the citizens do not, then there will be no private business.

If the architects want to survive, they must individually and collectively, make personal contact with their legislators, national, state, and local, a part of their business routine. They must impress upon those legislators the viewpoint of the architect as a factor of private industry and as representative of a large section of the voting population. Meetings with legislators at times of crisis are not enough. The government is the most powerful client in the country. It must be kept on the beam. And the beam must be started in the right direction in the minds of the elected law makers in each individual city, county, congressional district and state. We must control our public servants, or our public servants will control us. The choice is up to us. The crisis impends.

State Planning and Housing

That the subjects of planning and housing are buzzing around in the minds of the elected representatives of the people of California is shown by a resumé of the bills introduced on those subjects at the recent session of the state legislature.

The record shows that of the fifteen measures on planning which were introduced, three, only, became law. These were AB 306 establishing a postwar reconstruction fund, S. R. 459 which eliminates planning commissions from acting as advisory boards on the making of site plans for subdivisions, and S. B. 807 which repealed the State Planning Act and established a State Economic Planning Commission.

On the subject of housing, ten bills were introduced. The one measure emerging from the legislative mill and receiving the governor's signature was SB 37, which permits local control of Federal war housing through housing authorities.

Not one of the six bills introduced relating to state shore line development became law.

CHARLES H. CHENEY

Charles H. Cheney, architect and city planner, died the past month at his home in Palos Verdes, a beautiful residence community which he himself helped to

lay out some years ago. For a number of years Mr. Cheney practiced architecture in San Francisco although he spent most of his time in city planning work here and in the east. He was author of several excellent articles on city planning and was considered by the profession an authority on the subject. His work was shown in Architect and Engineer on a number of occasions. He was a member of San Francisco Chapter, A.I.A., and later joined the Southern California Chapter, which has contributed to a shelf of books on architecture and city planning established in his memory at the Palos Verdes public library. Mr. Cheney is survived by two brothers, one a noted sculptor and the other, Dr. Marshall Cheney of Berkeley.

MR. HAYS' RETIREMENT

The recent retirement of William C. Hays from the faculty of the University of California, School of Architecture, noted in the Architect's Bulletin last month, marked the close of a long and useful service as a teacher of architecture dating back to 1904. The banquet given him by 150 of his colleagues and friends, was a fitting tribute, indeed, to his outstanding record as a pedagogue, architect and writer.

Not the least of his literary efforts were the series of editorial comments which he wrote regularly some years ago for Architect and Engineer, and later his summaries of the work of the late John Galen Howard with whom he was at one time associated as junior partner.

Mr. Hays was the architect for Giannini Hall on the Berkeley Campus and has been supervising architect for the Davis Campus since 1918. He is also supervising architect for the University Medical Center in San Francisco.

Other structures for which Mr. Hays was architect include the First Presbyterian Church of Oakland, the Oakland Y. M. C. A., and the First Presbyterian Church of San Francisco.

After the San Francisco fire in 1906, Mr. Hays, with John Galen Howard and the late John D. Galloway supervised much of the reconstruction of the destroyed city. Mr. Hays was also one of the architects for the Alaska Yukon Pacific Exposition in Seattle in 1907.

Mr. Hays is a Fellow of the American Institute of Architects, a charter member of the Beaux Arts Institute of Design, a member of the Society of Beaux Arts Architects and the American Academy of Rome. He also holds memberships in Delta Sigma Chi, Tau Sigma Delta, T-Square of Philadelphia and Bohemian Club of San Francisco.

PACIFIC PAINT & VARNISH CO.

A Paint or Varnish Product for Every Purpose

SAN FRANCISCO
Sales Office

BERKELEY
Factory

LOS ANGELES
Sales Office

PRODUCERS' COUNCIL PAGE



Northern California Chapter

The National Organization of Manufacturers of Quality Building Materials and Equipment
Affiliated with the AMERICAN INSTITUTE OF ARCHITECTS



ROBERT B. TELFER
He's an early bird

When Robert Brown Telfer was serving with the Canadian Army in World War I, Mary Pickford was the pin-up girl. After four long years of soldiering, Bob left his British birthplace and migrated to Canada. A little later he moved to the States where he joined the Wayland Company. When that organization merged

with the Western Asbestos Company—(the right place for Bob's red-hot abilities)—he was named to represent Western Asbestos among architects and engineers, and in all general activities. Bob is married and lives so high up on San Francisco's Twin Peaks that he watches the sun rise half an hour before the rest of the city sees it. Bob ably handles the job of Program Committee Chairman.

Bob Telfer will preside over the next regular chapter meeting of the Council, August 2, at noon, at the Palace Hotel. It's sure to be packed with interest. Council members participating will give short talks on their firms and products. Present will be J. Wilson Peelle of the Peelle Co., and the Dahlstrom Metallic Door Co., and Norman Brown, representing Bell & Gossett. Both these new members will discuss the war production phases of their firm's activities.

Prexy Gets a Bid! The Building Industry Conference Board invited our prexy, Chuck Kraft, to address their July 14th meeting . . . Prexy Chuck points out that the Producers' Council doesn't claim for itself top role in the scheme of things, but has a plan worked out for participation in the swell job being done by the Committee for Economic Development, National Association of Manufacturers and the United States Chamber of Commerce.

Our job, as laid out by the Postwar Planning Committee of the Producers' Council, is to act as a representative cross-section of the entire building products manufacturing industry, to give a picture of those

phases of the postwar state of the industry that will interest all building products manufacturers.

Trade Associations are plenty important in such a picture! The Producers' Council would give them the job of coordinating their programs with the complete industry program. Because we know how important concerted action in the building industry is to put this plan over with a bang, the Producers' Council has dropped the dues of Trade Association members to a puny \$100 yearly, as well as inviting non-member groups to march right along with us on this.

You Won't Need a Crystal Ball to realize how important the Trade Associations are in our scheme of things. The new president of the Producers' Council, Inc., is Douglas Whitlock, general counsel for the Structural Clay Products Institute.

Throw Away Your Tin Cup! At the joint annual meeting of the AIA and the Producers' Council in Cincinnati, AIA Vice-President Walter R. MacCormack said it was about time to "take our tin cup and get out of Washington." This idea was seconded by everyone there. There'll be lots less Government in business after the war, if we stop running to Washington with our problems and for our finances. When we start standing on our own number 12's, things will be much better all around!

Thinking in Private! All our fancy planning won't be worth the powder to blow it to Tokyo if the member companies fail to make definite plans as to what they're going to do after V-Day—or more practically, any day previous when our war work is completed. The individual company is the unit to take action on problems involving reconversion, reemployment and the reintroduction of peace-time products on the world market.

Program Powwows! A series of meetings to work the program out at the top were held last month by the Executive Committee and Postwar Steering Committee in Washington, D. C., meeting with top Government officials and later with a group from the U. S. C. of C.

U. S. C. of C. Beckons! At the invitation of the U. S. Chamber of Commerce Construction Department Committee, the Producers' Council presented our postwar program to the entire committee which has members in all branches of the construction industry.

USE QUALITY PRODUCTS . . . CONSULT AN ARCHITECT

SAN FRANCISCO ARCHITECTURAL CLUB

Architectural Club members gathered at the Trocadero Restaurant in San Francisco, Wednesday evening, July 7, for their pre-meeting dinner. Immediately afterwards they journeyed to the club rooms at the Builders' Exchange, 666 Mission Street, for their regular monthly meeting.

The new treasurer, John Wasley, and directors, John Arndt and Hans Schickele, were officially installed.

John Webb of the Telesis Group gave an interesting talk on the purpose and functions of that organization.

Refreshments were served following adjournment.

SOUTHERN CALIFORNIA CHAPTER

Southern California Chapter members, at their June 15 meeting, heard interesting convention reports by the Chapter's delegates; also a report on the National Planning and Housing officials' meeting by Sumner Spaulding. Among those attending the Cincinnati convention was General Henry Newton, a Chapter member, who made the trip from his headquarters in a B-25 bomber. Southern California Chapter was further recognized when Member Van Marston was raised to fellowship—one of fifteen so honored.

New members were introduced as follows: Walter R. Hagedohn, Richard C. Farrell and J. Duncan Forsyth.

ENGINEERS AND ARCHITECTS ASSOCIATION

Members of the Engineers and Architects Association of Los Angeles enjoyed a talk on "France—Fallen But Not Defeated," by Miss Kathleen Lovelock at its June 24 dinner meeting. Miss Lovelock was a professor at the University of Caen and when the invasion came she fled by bicycle but twelve miles ahead of the German army. In her talk she recounted many exciting incidents which marked her escape to America.

Another feature of the June dinner was a talk on metals by Durand Beam.

The Association has a new treasurer, Wendell S. Thompson, who is also auditor for the Western District, U. S. Army Air Corps.

NEW SALES MANAGER

J. A. McCarthy, president of Pacific Portland Cement Company, has announced the appointment of J. E. Jellick as sales manager. Mr. Jellick was formerly manager of the Portland Cement Information Bureau in San Francisco. Prior to that he was district engineer of the Los Angeles and San Francisco offices of the Portland Cement Association, and for three years was manager of the Pacific Coast offices of the Association.

Mr. Jellick is a registered civil engineer. He served with the Los Angeles County Road Department and the Wyoming State Highway Department.

N. Y. TIMES PRAISES "BUTTERFLY MAP"

Some years ago while practicing the profession of architecture, B. J. S. Cahill, retired, and now residing in Alameda, designed a map of the globe which he appropriately titled "Cahill's Butterfly Map of the World." Since Pearl Harbor and the advent of this second world war the map has come into great demand and public interest has reached the stage where leading newspapers of the country are devoting columns of space to describing the invention. Recently the New York Times printed a lengthy article by its science editor, Waldemar Kaempffert, describing the Cahill map as "the best of all by far." The Times writer gives eight reasons why the Cahill map is superior. In connection with the subject it is interesting to note that Wendell Willkie in his new book refers to one world and not two hemispheres, exactly as the butterfly map showed 30 years ago.

SHIP NAMED AFTER NOTED ARCHITECT

Named after the late Stanford White, distinguished New York architect, another 10,500-ton Liberty ship was launched at the California Shipbuilding Yards at Wilmington, April 3. White was a member of the firm of McKim, Mead and White, architects of Madison Square Garden, Columbia University Library, and the New York University group.

PHOTOSTAT, BLUEPRINT OPERATORS SOUGHT FOR FEDERAL REPLACEMENTS

To have readily available photostat and blueprint operators to replace those being inducted into armed services, the United States Civil Service Commission is accepting applications for Federal employment from persons with appropriate experience or training. Women are being placed.

Positions are in Washington, D. C. only and pay \$1,752 a year, including overtime pay for the present 48-hour week. At least 3 months' experience or 80 hours' training in photostat or blueprint work are required. Those receiving training in such work may apply and receive provisional appointments prior to completion of the course.

There are no age limits. No written test is required. Full information and application form 60 are available at first- and second-class post offices, Civil Service regional offices, or the Commission in Washington, D. C. Applications should be sent to the Commission's Washington office, and will be accepted until the needs of the service are met.

Persons using their highest skills in war work should not apply. Appointments to Federal positions are made in conformance with War Manpower Commission policies and stabilization and controlled hiring plans.

Estimator's Guide

Giving Cost of Building Materials, Wage Scale, Etc.

Amounts given are figuring prices and are made up from average quotations furnished by material houses to San Francisco contractors. 3% Sales Tax on all materials but not labor.

All prices and wages quoted are for San Francisco and the Bay District. There may be slight fluctuation of prices in the interior and southern part of the state. Freight cartage, at least, must be added in figuring country work.

Bond—1½% amount of contract.
Government work ¾%.

Brickwork—

Common, \$43 to \$45 per 1000 laid, (according to class of work).
Face, \$125 to \$150 per 1000 laid, (according to class of work).
Brick Steps, using pressed brick, \$1.50 lin. ft.
Brick Veneer on frame buildings, \$1.10 sq. ft.
Common f.o.b. cars, \$16.00 a yard. Cartage extra, \$2.50 per 1000.
Face, f.o.b. cars, \$55.00 to \$80.00 per 1000, carload lots.

Building Paper—

1 ply per 1000 ft. roll.....	\$3.50
2 ply per 1000 ft. roll.....	5.00
3 ply per 1000 ft. roll.....	6.25
Brownstn. Standard, 500 ft. roll.....	5.00
Sisalcraft, 500 ft. roll.....	5.00
Sash cord com. No. 7.....	\$1.20 per 100 ft.
Sash cord com. No. 9.....	1.50 per 100 ft.
Sash cord spot No. 7.....	1.90 per 100 ft.
Sash cord spot No. 8.....	2.25 per 100 ft.
Sash weights, cast iron, \$50.00 ton.	
Nails, \$3.50 base.	
Sash weights, \$45.00 per ton.	

Concrete Aggregates—

GRAVEL (all sizes) \$1.95 per ton at bunker; delivered, \$2.50. All quotations less 10% to contractors.

	Bunker	Delivered
Top sand.....	\$1.90	\$2.50
Concrete mix.....	1.90	2.45
Crushed rock, ¼ to ¾.....	1.90	2.50
Crushed rock, ¾ to 1½.....	1.90	2.50
Roofing gravel.....	2.25	2.80
River sand.....	2.25	2.70

SAND—

	Bunker	Delivered
River sand.....	\$2.50	\$2.70
Lapis (Nos. 2 & 4).....	.85	3.15
Olympia Nos. 1 & 2.....	2.85	3.10
Del Monte white.....	.84c	per sack

Common cement (all brands, paper sacks) carload lots \$2.42 per bbl, f.o.b. car; delivered \$2.60.

Cash discount on carload lots, 10c a barrel, 10th Prox.

Atlas White	}	1 to 100 sacks, \$2.70 sack, warehouse or delivery; \$7.65 bbl. carload lots.
Calaveras White		
Medusa White		

Forms, Labors average \$40.00 per M.
Average cost of concrete in place, exclusive of forms, 35c per cu. ft.; with forms, 60c.
4-inch concrete basement floor.....12½c to 14c per sq. ft.
Rat-proofing.....7½c
Concrete Steps.....\$1.25 per lin. ft.

Dampproofing and Waterproofing—

Two-coat work, 20c to 30c per yard.
Membrane waterproofing—4 layers of saturated felt, \$4.50 per square.
Hot coating work, \$2.00 per square.
Medusa Waterproofing, 15c per lb., San Francisco Warehouse.
Tricocel waterproofing.
(See representative.)

Electric Wiring—\$12.00 to \$15.00 per outlet for conduit work (including switches).
Knob and tube average \$3.00 per outlet. (Available only for priority work.)

Elevators—

Prices vary according to capacity, speed and type. Consult elevator companies. Average cost of installing a slow speed automatic passenger elevator in small four story apartment building, including entrance doors, about \$6500.00.

Excavation—

Sand, 60 cents; clay or shale \$1 per yard.
Teams, \$12.00 per day.
Trucks, \$22 to \$27.50 per day.
Above figures are an average without water. Steam shovel work in large quantities, less; hard material, such as rock, will run considerably more.

Fire Escapes—

Ten-foot galvanized iron balcony, with stairs, \$150 installed on new buildings; \$160 on old buildings.

Floors—

Composition Floors—22c to 40c per sq. ft.
In large quantities, 18c per sq. ft. laid.
Mosaic Floors—80c per sq. ft.
Duraflex Floor—23c to 30c sq. ft.
Rubber Tile—50c to 75c per sq. ft.
Terazzo Floors—45c to 60c per sq. ft.
Terazzo Steps—\$1.60 lin. ft.

Hardwood Flooring (delivered to building)—

	1½" x 2¼" T.G.	3¼" x 2" T.G.	3½" x 2" Sq. Ed.
Clr. Qtd. Oak.....	\$144.00 M	\$122.00 M	\$141.00 M
Sel. Qtd. Oak.....	118.00 M	101.00 M	114.00 M
Clr. Pla. Oak.....	120.00 M	102.00 M	115.00 M
Sel. Pla. Oak.....	113.00 M	92.00 M	107.00 M
Clr. Maple.....	125.00 M	113.00 M	

Wage—Floor layers, \$12.00.
Note—Above quotations are all board measure except last column which is sq. ft.

Glass (consult with manufacturers)—

Double strength window glass, 20c per square foot.
Plate 80c per square foot (unglazed) in place, \$1.00.
Art, \$1.00 up per square foot.
Wire (for skylights), glazed, 40c per sq. foot.
Obscure glass, 30c to 50c square foot.
Glass bricks, \$2.50 per sq. ft. in place.
Note—if not stipulated add extra for setting.

Heating—

Average, \$1.9c per sq. ft. of radiation, according to conditions.
Warm air (gravity) average \$48 per register.
Forced air, average \$68 per register.

Iron—Cost of ornamental iron, cast iron, etc., depends on designs.

Lumber (prices delivered to bldg. site)—

No. 1 common.....	\$45.00 per M
No. 2 common.....	43.00 per M
Select O. P. Common.....	48.00 per M
1x4 No. 2 flooring VG.....	80.00 per M
1x4 No. 3 flooring VG.....	75.00 per M
1x6 No. 2 flooring VG.....	90.00 per M
1¼x4 No. 2 flooring.....	85.00 per M

Slash grain—

1x4 No. 2 flooring.....	\$45.00 per M
1x4 No. 3 flooring.....	62.00 per M
No. 1 common run T. & G.....	50.00 per M
Lath.....	7.50 per M

Shingles (add cartage to price quoted)—
Redwood, No. 1.....\$1.20 per bdle.
Redwood, No. 2.....1.00 per bdle.
Red Cedar.....1.40 per bdle.

Plywood—Douglas Fir (add cartage)

"Plyscord" sheathing (unsanded)
¾" 3-ply and 48"x96".....\$39.75 per M
"Plywall" (wallboard grade).....
¼" 3-ply 48"x96".....\$43.70 per M
"Plyform" (concrete form grade).....
¾" 5-ply 48"x96".....\$117.30 per M
Exterior Plywood Siding.....\$132.00 per M
¾" 5-ply Fir.....
Redwood (Rustic) 1½" x 8" clear heart.....\$95.00 per M
\$5 less per M for A grade.

Millwork—Standard.

O. P. \$100 per 1000. R. W. rustic \$100.00 per 1000 (delivered).
Double hung box window frames, average with trim, \$6.50 and up, each.
Complete door unit, \$10.00.
Screen doors, \$3.50 each.
Patent screen windows, 25c a sq. ft.
Cases for kitchen pantries seven ft. high, per lineal ft., \$8.00 each.
Dining room cases, \$8.00 per lineal foot.
Rough and finish about 75c per sq. ft.
Labor—Rough carpentry, warehouse heavy framing (average), \$17.50 per M.
For smaller work average, \$35.00 to \$45.00 per 1000.

Marble—(See Dealers)

Painting—

Two-coat work.....	per yard 50c
Three-coat work.....	per yard 70c
Cold water painting.....	per yard 10c
Whitewashing.....	per yard 4c

Turpentine, \$1.08 per gal., in 5 gal. cans, and 95c per gal. in drums.
Raw Linseed Oil—\$1.32 gal. in light drums.
Boiled Linseed Oil—\$1.35 gal. in drums and \$1.48 in 5 gal. cans.

White Lead in oil Per Lb.
1 ton lots, 100 lbs. net weight.....11 1/2 c
500 lbs. and less than 1 ton.....12 1/4 c
Less than 500 lb. lots.....12 3/4 c

Red Lead and litharge
1 ton lots, 100 lbs. net weight.....11 1/2 c
500 lbs. and less than 1 ton.....12 1/4 c
Less than 500 lb. lots.....12 3/4 c

Red Lead in oil
1 ton lots, 100 lbs. net weight.....12 1/2 c
500 lbs. and less than 1 ton.....13 1/4 c
Less than 500 lb. lots.....13 3/4 c
Note—Accessibility and conditions cause some variance in costs.

Patent Chimneys—
6-inch.....\$1.25 lineal foot
8-inch.....1.50 lineal foot
10-inch.....2.25 lineal foot
12-inch.....3.00 lineal foot

Plaster
Neat wall, per ton delivered in S. F. in paper bags, \$17.60.

Plastering—Interior— Yard
1 coat, brown mortar only, wood lath.....\$0.70
2 coats, lime molar hard finish, wood lath......90
2 coats, hard wall plaster, wood lath......80
3 coats, metal lath and plaster.....1.50
Keene cement on metal lath.....1.60
Ceilings with 3/4 hot roll channels metal lath (lath only).....1.10
Ceilings with 3/4 hot roll channels metal lath plastered.....2.00
Single partition 3/4 channel lath 1 side (lath only).....1.10
Single partition 3/4 channel lath 2 inches thick plastered.....\$2.90
4-inch double partition 3/4 channel lath 2 sides (lath only).....2.00
4-inch double partition 3/4 channel lath 2 sides plastered.....1.61
Thermax single partition; 1" channels; 2 1/4" overall partition width. Plastered both sides.....3.00
Thermax double partition; 1" channels; 3/4" overall partition width. Plastered both sides.....4.00

3 coats over 1" Thermax nailed to one side wood studs or joists.....1.50
3 coats over 1" Thermax suspended to one side wood studs with spring sound isolation clip.....1.75

Plastering—Exterior— Yard
2 coats cement finish, brick or concrete.....1.00
3 coats cement finish, No. 18 gauge wire mesh.....1.75
Wood lath, \$5.50 to \$6.50 per 1000 (not available).....
2.5-lb. metal lath (dipped) (not available).....19
2.5-lb. metal lath (galvanized) (not avail.).....21
3.4-lb. metal lath (dipped) (not available).....22
3.4-lb. metal lath (galvanized) (not avail.).....24
3/4-inch hot roll channel, \$72 per ton.....
Finish plaster, \$18.90 ton; in paper sacks. Dealer's commission, \$1.00 off above quotations. \$13.85 (rebate 10c sack).
Lime, f.o.b. warehouse, \$22.55 bbl.; cars, \$21.15. Bulk (ton 2000 lbs.), \$16.00 ton.
Wall board 5 ply, \$50.00 per M.
Hydrate Lime, \$26.00 ton.
Plasterers Wage Scale.....\$1.75 per hour
Lathers Wage Scale.....1.75 per hour
Hod Carriers Wage Scale.....1.50 per hour
Composition Stucco—\$1.80 to \$2.00 sq. yard (applied).

Plumbing—
From \$100.00 per fixture up, according to grade, quantity and runs.

Roofing—
"Standard" tar and gravel, \$7.00 per sq. for 30 sqs. or over.
Less than 30 sqs. \$7.50 per sq.
Tile, \$20.00 to \$35.00 per square.
Redwood Shingles, \$7.50 per square in place.
Copper, \$16.50 to \$18.00 per sq. in place.
5/2 #1-16" Cedar Shingles, 8.00 Square
4 1/2" Exposure.....
5/8 x 16" #1 Cedar Shingles, 9.00 Square
4/2 #1-24" Royal Shingles, 9.50 Square
7/2" Exposure.....
Re-coat with Gravel, \$3 per sq.
Asbestos Shingles, \$15 to \$25 per sq. laid.
Slate, from \$25.00 per sq., according to color and thickness.
1/2 x 25" Resawn Cedar Shakes, 10" Exposure.....10.50
3/4 x 25" Resawn Cedar Shakes, 10" Exposure.....11.50

1 x 25" Resawn Cedar Shakes, 10" Exposure.....12.50
Above prices are for shakes in place.

Sheet Metal—
Windows—Metal, \$1.75 a sq. ft.
Fire doors (average), including hardware, \$1.75 per sq. ft.

Skylights—(not glazed)
Copper, 90c sq. ft. (flat).
Galvanized iron, 40c sq. ft. (flat).
Vented hip skylights 60c sq. ft.

Steel—Structural (None available except for defense work)
\$150 ton (erected), this quotation is an average for comparatively small quantities. Light truss work higher. Plain beams and column work in large quantities \$140 per ton.

Steel Reinforcing (None available except for defense work).
\$150 to \$200 per ton, set.

Stone—
Granite, average, \$6.50 cu. foot in place.
Sandstone, average Blue, \$4.00. Boise, \$3.00 sq. ft. in place.
Indiana Limestone, \$2.80 per sq. ft. in place.

Store Fronts—
Copper sash bars for store fronts, corner center and around sides, will average \$1.00 per lineal foot.
Note—Consult with agents.

Tile—Floor, Wainscot, etc. — (See Dealers)
Asphalt Tile—18c to 28c per sq. ft. installed.

Wall Tile—
Glazed Terra Cotta Wall Units (single faced) laid in place—approximate prices:
2 x 6 x 12.....\$1.00 sq. ft.
4 x 6 x 12.....1.15 sq. ft.
2 x 8 x 16.....1.10 sq. ft.
4 x 8 x 16.....1.30 sq. ft.

Venetian Blinds—
40c per square foot and up. Installation extra.

Windows—Steel
Factory type sash 30c ft.
Ventilators for steel sash \$5.00 each.

1943 BUILDING TRADES WAGE SCALES FOR NORTHERN CALIFORNIA

All crafts, except plasterers, are now working 8 hours a day. Plasterers' time is 6 hours.

CRAFT	San Francisco	Alameda	Fresno	Marin	Sacramento	San Jose	San Mateo	Vallejo	Stockton
ASBESTOS WORKERS	\$1.50	\$1.25	\$1.25	\$1.37 1/2	\$1.12 1/2	\$1.25	\$1.25	\$1.25	\$1.25
BRICKLAYERS	1.80	1.87 1/2	1.40	1.50	1.37 1/2	2.00	1.87 1/2	1.87 1/2	2.00
BRICKLAYERS' HODCARRIERS	1.40	1.40	1.05	1.40	1.40	1.40	1.40	1.40	1.40
CARPENTERS	1.43	1.43	1.25	1.43	1.43	1.43	1.43	1.43	1.43
CEMENT FINISHERS	1.37 1/2	1.37 1/2	1.25	1.25	1.25	1.50	1.25	1.25	1.43
ELECTRICIANS	1.50	1.50	1.50	1.37 1/2	1.50	1.50	1.50	1.50	1.37 1/2
ELEVATOR CONSTRUCTORS	1.61	1.54	1.54	1.61	1.61	1.50	1.50	1.50	1.50
ENGINEERS: Material Hoist	1.50	1.37 1/2	1.25	1.50	1.37 1/2	1.62 1/2	1.37 1/2	1.37 1/2	1.25
Piledriver	1.75	1.60	1.60	1.75	1.75	1.75	1.62 1/2	1.75	1.60
Structural Steel	1.75	1.60	1.60	1.75	1.75	1.75	1.60	1.60	1.60
GLASS WORKERS: Ornamental	1.25	1.25	1.12 1/2	1.12 1/2	1.21	1.25	1.25	1.25	1.25
IRON WORKERS: Ornamental	1.50	1.31 1/4	1.37 1/2	1.31 1/4	1.37 1/2	1.31 1/4	1.25	1.31 1/4	1.31 1/4
Reinf. Rodmen	1.50	1.31 1/4	1.31 1/4	1.31 1/4	1.31 1/4	1.31 1/4	1.31 1/4	1.31 1/4	1.25
Structural	1.75	1.60	1.60	1.60	1.60	1.75	1.50	1.60	1.37 1/2
LABORERS: Building	.85	.87 1/2	.82 1/2	.81 1/4	.85	.81 1/4	.81 1/4	.81 1/4	.80
Concrete	.87 1/2	.93 3/4	.90	.81 1/4	.92 1/2	.85	.90	.90	.90
LATHERS	1.75	1.75	1.50	1.75	1.60	1.75	1.75	1.50	1.50
MARBLE SETTERS	1.43 3/4	1.25	1.25	1.31 1/4	1.37 1/2	1.25	1.31 1/4	1.31 1/4	1.31 1/4
MOSAIC & TERRAZZO	1.00	1.25	1.12 1/2	1.12 1/2	1.15-8/8	1.12 1/2	1.12 1/2	1.12 1/2	1.12 1/2
PAINTERS	1.37 1/2	1.50	1.28-4/7	1.37 1/2	1.25	1.35-5/7	1.42-4/7	1.50	1.25
PILEDRIVERS	1.47	1.40	1.40	1.50	1.40	1.47	1.40	1.40	1.40
PLASTERERS	1.66-2/3	1.66-2/3	1.75	1.66-2/3	1.75	2.00	2.00	1.75	1.83-1/3
PLASTERERS' HODCARRIERS	1.50	1.45	1.40	1.40	1.18 3/4	1.35	1.75	1.40	1.40
PLUMBERS	1.52 1/2	1.50	1.53-1/8	1.50	1.56 1/4	1.62 1/2	1.50	1.50	1.37 1/2
ROOFERS	1.37 1/2	1.37 1/2	1.12 1/2	1.25	1.25	1.37 1/2	1.25	1.25	1.25
SHEET METAL WORKERS	1.37 1/2	1.37 1/2	1.43 3/4	1.37 1/2	1.50	1.50	1.37 1/2	1.25	1.37 1/2
SPRINKLER FITTERS	1.50	1.37 1/2	1.25	1.25	1.62 1/2	1.62 1/2	1.50	1.50	1.50
STEAMFITTERS	1.50	1.50	1.53 1/4	1.50	1.56 1/4	1.62 1/2	1.50	1.50	1.50
STONESETTERS (Masons)	1.50	1.75	1.75	1.75	1.75	1.75	1.50	1.50	1.50
TILESETTERS	1.50	1.37 1/2	1.37 1/2	1.37 1/2	1.37 1/2	1.50	1.50	1.37 1/2	1.37 1/2

Prepared and compiled by

CENTRAL CALIFORNIA CHAPTER, ASSOCIATED GENERAL CONTRACTORS OF AMERICA

with the assistance and cooperation of secretaries of General Contractors Associations and Builders Exchanges of Northern California.

WHAT WILL HAPPEN TO OUR WAR PLANTS AFTER THE WAR?

By LADISLAS SEGOE, Planning Consultant

It has been estimated that the industrial growth of the United States during the past few years, to meet the demands of the war has been at least as great as would have likely occurred in twenty years to meet peacetime needs. What is to become of the many huge new plants that have been built all over the country as well as those that have been converted to war needs after the war?

One thing is certain, we like to believe: few of them should be needed to turn out implements of war. Most of them will be converted or reconverted to produce what the people of our country and other countries will need and want.

Some of the war plants we just built will likely replace obsolete or inefficient older plants of the same concern or an industry already established in the community. Other new plants may be taken over by an industry from outside the community or one making an entirely new product. Some may be reconverted to produce something or other quite different from what they made prior to conversion to war production.

The sum total of these conversions, reconversions and industrial shifts, attendant upon the changeover from a war to a peace economy, is likely to change materially the industrial make-up of our cities and industrial areas. Should the shaping of the resulting industrial structure—the soundness and stability or the weakness and vulnerability that will result and determine for many years to come the welfare of the community as well as of the industries—be left to chance? Or is there something we could and ought to do for both the community and industry to profit from these changes?

My thesis is that by intelligent planning and with the collaboration of all concerned,—industry, labor, government and the public, all of whom have much to gain by the success of the attempt,—we could direct this change in each community guided by selective programs of industrial development, so as to cure or at least ameliorate many of the baneful consequences of a haphazard, catch as catch can industrial development in the past.

More specifically, the ends sought by such programs of selective development would be these: (1) a fuller and more effective use of labor resources and through this the maximizing of the family annual income; (2) the reduction to a minimum of seasonal and cyclical unemployment; (3) increased industrial efficiency through integration among industries; (4) the reduction of vulnerability to technological changes and to depressions; and (5) a better balance between the cost to the community of services to its industries and the income of

the community from its industries.

In the past the community and industry have typically approached the mutual problem of industrial location without intelligent attention to the factors involved. On its part, the community has considered industrial enterprise, both actual and prospective, on a quantitative rather than a qualitative basis, and has sought to attract and has even subsidized industries with little understanding of their effects on the community. These policies it has pursued blindly, ordinarily through private or semi-public agencies, inadequately equipped in training, experience, and financial support to collect and interpret the facts necessary for sound judgment. On its part, industry has sought natural advantages, without references to its probable effects on the industries already established or on the community, and has at times sold out to the highest bidders. In either case, it has often found itself caught in an unfavorable local industrial structure.

The results of a poorly balanced community industrial pattern are as readily appraised as they are uniformly undesirable. From the point of view of the community, such a structure works havoc on public finances, upsets the public services, complicates social problems manifold, and throws the whole economic and industrial front out of joint. On the worker, the effects are equally unfortunate. He suffers from unemployment which does not make full use of his skill and experience or which is irregular and unstable, and from lower wages than he is capable of earning. The net result is that he is forced to accept a lower standard of living than would otherwise be his, to rely upon the community for indirect subsidization and on the State for direct support, and ultimately to face partial or complete dependence. The effects on industry are largely complementary to those experienced by the community and the worker. The consequence of an inefficient community and a discontented body of workers is that an industry, which suffers from such handicaps, is thrown into competition, which it cannot meet, with plants which are more favorably located. Such competition ultimately must lead to removal or ruin.

It is hardly to be doubted that these ills, whether suffered by the community, by the worker, or by industry, flow in large part from a condition of unbalance both within industry itself and between industry and the community. The facts that plants relocate with less and less frequency and that the national industrial pattern becomes less flexible with the passing of time are common knowledge. At the same time there is a definite, long-pent-up tendency toward industrial relocation which is likely to find expression after the war. There are also important technological advances underway

From an address before the Affiliate Council of the Engineering Society of Detroit.

HOGAN LUMBER CO.

Wholesale and Retail

LUMBER

MILL WORK • SASH & DOORS

Office, Mill, Yard and Docks

SECOND AND ALICE STREETS • OAKLAND, CALIF.

Telephone GLencourt 6861

CLINTON CONSTRUCTION CO. OF CALIFORNIA

General Contractors

923 FOLSOM STREET • SAN FRANCISCO

SUTter 3440

FORDERER CORNICE WORKS

Manufacturers of

Hollow Metal Products • Interior Metal Trim

Elevator Fronts and Cabs

Metal Plaster Accessories • Sanitary Metal Base

Flat and Roll Metal Screens

Metal Cabinets • Commercial Refrigerators

269 POTRERO AVE.

SAN FRANCISCO, CALIF.

HEMLOCK 4100

STRUCTURAL STEEL

**For Class A Buildings,
Bridges, etc.**

JUDSON PACIFIC CO.

1200 SEVENTEENTH STREET

SAN FRANCISCO

Plants: San Francisco - Oakland

which will tend to release industries from established processes and locations. Finally, there are indications that both community and industry are awakening to the importance of an intelligent articulation of the two. Both appear to be constantly more intent on searching out and appraising the fundamental factors involved in the rational location of industry. In these trends lie the making of a more effective industrial pattern. Before proposals can be made to harmonize them, however, some underlying forces must be observed and some important problems recognized.

The significant forces and factors which underlie any effort to articulate more closely the community and its industries are many and diverse. Only the more significant may be observed.

(1) The trend toward larger units of manufacture, merchandising, and direction is important. These larger units, with their centralized and non-resident control, reduce the direct and indirect support of industry to the community. Coincidentally, industries are rationalizing their operations; and, when necessary, their plants, equipment, market practices, personnel, and locations are being adjusted to meet new industrial requirements.

(2) Technological changes in industry constantly alter the values of labor skills and so affect materially labor requirements. In particular may be noted the development of synthetic products, whose effects on the prevailing industrial structure, as regards both labor and location, need hardly be emphasized.

(3) To the extent to which industry is decentralizing and to the degree to which the industrial structure is becoming more mature, extremely important underlying factors are seen.

(4) In the past, water and rail routes and rates have been controlling factors in establishing industrial enterprises and the communities dependent upon them. The development in recent years of rapid and more flexible transportation forms tends to modify the old dependence on rail and water, and, consequently, the industrial pattern and the communities which grow therefrom.

(5) Government supervision of rail routes and rates has had important effects, both beneficial and bad, on industrial location, as have also government regulation of wages, hours of labor, and distributing practices.

(6) An extremely significant, if indirect, factor is seen in the slowing down of population growth. This would not be classified as primarily an industrial trend, but its importance for industry, especially in accentuating service rather than volume as the true goal, will be readily apparent.

(7) Other underlying forces and factors, each important in its own right, are found in the respective attitudes of government officials, the public, industry and labor, the exploitation of the nation's natural resources following the settling of the frontiers, the railroads' desire for tonnage, the realtor's desire for turnover, the banks' desire for new accounts, and pro-

motional agencies' desire for achievement.

Limitations of time do not permit a detailed examination of the effects of each of these factors on the national industrial pattern and on the industrial structure of communities. To enumerate them, however, is to suggest the manifold influences which have entered into the development of the present nondescript industrial structure of communities and its relationship to such communities.

The building of a sounder local industrial structure involves a two-fold task: (1) integrating and articulating the industries of the community among themselves; and (2) improving the relationships between industries and the community.

The first major problem underlying the accomplishment of these tasks is that of convincing all parties concerned that there actually is a job to do, and that it can be done. Industry itself may dislike the suggestion that it should aim to improve the total industrial complex of the community and the community-industry relationships. Local officialdom may be loathe to take action, either from lack of authority or from simple inertia. The public may not be favorable to the program. The first problem then is that of educating and winning over opinion, industrial, official, and public.

A second major problem is that of devising methods and instruments for the selection of industry by both constructive restraint and intelligent promotion after the proper support, public and private, has been built up for the program. Here are involved questions of principles, procedures and techniques in devising the selective program, as well as the form, methods, functions and powers of the agency to be created.

A third important problem is found when a community is part of a large industrial area, and so is limited in the effectiveness of the action which it may take alone. In such a case, there seems to be no satisfactory alternative to regional action.

The technical problems which must be faced by any agency for industrial synchronization, whether on a community or on a regional basis, are legion. From the joint point of view of both community and a particular industry, there must be considered in such an effort, with reference to the local industrial structure, such matters as (1) the public services required by the industry and the ability of the community to furnish them; (2) the labor demands of the industry and the ability of the community (a) to furnish the labor required or (b) to absorb with mutual advantage new labor to be brought in; (3) the wage scale of the industry in question in its effect on the community and on other industries; and (4) the probable success of the new industry and its ability to bear a fair share of community costs and burdens over a long period of time. In sum, the problem is that of articulating industry internally and adjusting more closely to the community and its various industries, which are the joint ends toward which all forces are to be turned.

Fine Water Colors and Papers For Architectural Renderings

H. S. CROCKER COMPANY, Inc.

720 MISSION STREET
Market Street at Second • San Francisco

BASALITE

CAMBERED SHINGLE TILE

PERMANENT • FIREPROOF • STORM-
SAFE • COLORFUL • ECONOMICAL

Manufactured by
BASALT ROCK CO., INC.
NAPA, CALIFORNIA

SISALKRAFT

REG. U. S. PAT. OFF.

"More than a building paper"

THE SISALKRAFT CO.

205 West Wacker Drive
Chicago, Ill.

55 New Montgomery Street
San Francisco, Calif.

VERMONT MARBLE COMPANY

Producers and Finishers
of
Domestic and Imported Marbles

Write for new pamphlet describing our
Marble Toilets and Showers
San Francisco and Los Angeles
San Francisco phone: SUtter 6747

**The Most Complete Line of
STEELS and BUILDING MATERIALS
Made by a Single Producer**



See Sweet's Catalog File or write us for full information.

REPUBLIC STEEL CORPORATION

GENERAL OFFICES: CLEVELAND, OHIO

DENVER, COLORADO CONTINENTAL OIL BUILDING
LOS ANGELES, CALIFORNIA EDISON BUILDING
SALT LAKE CITY, UTAH WALKER BANK BUILDING
SAN FRANCISCO, CALIFORNIA RIALTO BUILDING
SEATTLE, WASH. WHITE-HENRY-STUART BUILDING

**PACIFIC
MANUFACTURING CO.**

HIGH CLASS INTERIOR FINISH
QUALITY MILLWORK

142 SANSOME ST., SAN FRANCISCO
GARfield 7755

6820 MCKINLEY AVE., LOS ANGELES
THornwall 4196

BUILDERS EXCHANGE, OAKLAND

**"AMERICAN MARSH"
Redi-Vac Vacuum Heating Pump**



Send for Bulletin 441

SIMONDS MACHINERY CO.

San Francisco
816 Folsom St.

Los Angeles
455 East Fourth St.

SANTA MARIA INN SANTA MARIA CALIFORNIA



On the Coast Highway between Los Angeles and San Francisco

**OVER NIGHT
or
JUST A MEAL**

FRANK J. McCOY
Owner

EL ENCANTO HOTEL SANTA BARBARA

On the Riviera, above the Old Mission

Frank J. McCoy, Owner

Fred F. Pimental, Manager

Recommendations

1. As a part of the official city or regional planning agency, a council for industrial articulation should be established in each industrial community or region, with representation from industry, labor, the professions and other interested private enterprises. Typical of the semi-public and private agencies to be represented are the Chamber of Commerce, the Retail Credit Men's Association, the Association of Manufacturers, organized labor, etc.

2. This council should be charged with the responsibility for planning and effectuating a program designed to bring about a condition of industrial balance.

3. It should be financed through contributions by industry, labor, and appropriations by government.

4. The local council should be authorized to retain such staff, full-time, part-time, and consulting, as may be required for the proper discharge of its duties.

5. Whatever information or data the council may require should be made available by the industries, labor, government agencies and others.

6. On the basis of such data, the local industrial council should develop a statement of the points of industrial strength and weakness of the community or region, so that (1) established industries may see what is required for industrial balance, and (2) prospective enterprises may be weighed and may weigh themselves in the light of local conditions.

7. A prospective new enterprise should be investigated with reference to (1) its place in industry, (2) its history in its present location, and (3) the effects which a change in location might have upon the industrial structure of the community, the present location, and the enterprise in question.

8. A prospective new enterprise should be investigated especially with an eye to all possible effects which its coming might have upon the community.

9. The information prepared by the local industrial council should be made available to all interested parties on authoritative request.

IDEAS ON STANDARDS—FOR THE ARMY

The Army wants ideas on standards—and on many other problems. Bridges, camouflage, construction, photography, printing, roads, safety, sanitation, and specifications are only a few. The Engineer School at Fort Belvoir, Virginia, is asking for suggestions from soldiers, from sailors, or from civilians.

A suggestion system, now more than a year old, has been set up by the School, and all suggestions which might be helpful to the Army Corps of Engineers are welcomed. To date 11 per cent of the suggestions have been approved and put to use. No useful idea is too small to report, the School declares. Every suggestion is copied and submitted to the critics without any indication of its source. Each suggestion is treated on its own merits.

Subjects of importance to the Corps of Engineers

and on which ideas are particularly invited are: Bridges; camouflage; construction; design; drafting; equipment; logistics; machines; maintenance; maps; materials; methods; packing; photography; power; printing; publications; rigging; roads; safety; sanitation; specifications; standards; storage; strategy; surveying; tactics; traffic; training; transportation; water.

Send your suggestions on these subjects to the Engineer School, Fort Belvoir, Virginia.

U. S. STEEL CORPORATION PROSPEROUS

Remarks of Irving S. Olds, Chairman of the Board of Directors of United States Steel Corporation of which Columbia Steel Company of Pittsburg, California, is a subsidiary, indicate continued prosperity for the Corporation with a large percentage of production centered in meeting Government needs in the prosecution of the war. As a prelude to his talk Mr. Olds paid tribute to two men who served the Corporation over many years and who have passed on since the last annual meeting of the stockholders: J. P. Morgan and James A. Farrell, both Directors and members of the Finance Committee.

Since the last annual meeting of stockholders, United States Steel Corporation has sought to do everything within its power, in cooperation with the Government, to aid in bringing about the winning of the war through maximum production of its products. The story of the wartime activities of the Corporation during 1942 is told in the forty-first Annual Report of the Corporation.

United States Steel's production of rolled and finished steel during 1942 was again in excess of the rated capacity of the Corporation. Ingot production was close to rated capacity.

Since the commencement of the national emergency, more than 70,000 employees have left the United States Steel family to join the Army, Navy and their auxiliary forces. The average number of employees during 1942 was 335,866, the highest on record for any year. The payroll for these employees (\$738,444,009) was more than twelve times the amount of the total preferred and common dividends paid in 1942. The total compensation of all executives receiving \$10,000 or more a year during 1942 represented less than one per cent of the total payroll for that year.

DAILY NEWS PHOTOGRAPHS ARCHITECTS

The San Francisco News published a two column group picture of architects engaged in a discussion of post-war city development. A good likeness of Michael Goodman (except that he appeared to be in need of a shave); also excellent pictures of William J. Bane, architect of Seattle, and Frederick Confer, Berkeley architect. Goodman was captioned as "chief doctor of city ills." The trouble with cities, Professor Goodman contends, is that they are a medieval structure for modern living.

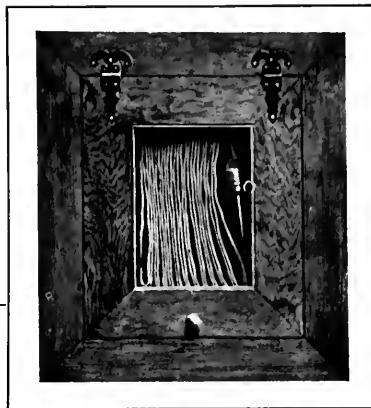

Set flush to the wall, simple in design, and with any finish desired, these

Lightning Hose Rack Cabinets

... enable architects to make fire hose unobtrusive, yet easy to reach in emergencies. . . . For details, write:

The

AMERICAN RUBBER

Factory and General Offices: **Manufacturing Co.**

PARK AVENUE AND WATTS STREET, OAKLAND, CALIF.

TEAMWORK for SECURITY

GOLDEN GATE • OLD MISSION
PORTLAND CEMENT PORTLAND CEMENT

MILCOR
METAL LATH PRODUCTS

EMPIRE
GYPSUM PLASTER

STANDARD
GYPSUM PLASTER

PACIFIC
PORTLAND CEMENT COMPANY

FOR SOUND CONSTRUCTION

REMILLARD-DANDINI Co.

**Brick and
Masonry Products**

*

633 BRYANT ST., SAN FRANCISCO
569 THIRD ST., OAKLAND

JOHN CASSARETTO

—Since 1886—And Still Active—

Building Materials

READY MIX CONCRETE
ROCK - SAND - GRAVEL - LIME
CEMENT - PLASTER - MORTAR
METAL LATH - WOOD LATH
STUCCO - WIRE NETTING

Service Unexcelled

Bunkers
Sixth and Channel, San Francisco
Phones: GARfield 3176, GARfield 3177



HERRICK IRON WORKS

**STRUCTURAL STEEL
REINFORCING STEEL**

18TH AND CAMPBELL STS.
OAKLAND, CALIF.
Phone GLencourt 1767

DINWIDDIE CONSTRUCTION COMPANY

•
BUILDERS
•

CROCKER BUILDING
SAN FRANCISCO

STEEL WAREHOUSE SECTION

Following sixty days of pre-testing, the first "Steel Warehouse Section" in American war production has been acclaimed an outstanding success by the War Production Board regional office. The new service has set up records for expediting material deliveries of steel products to war plants in the San Francisco Bay area.

Established on April 1, 1943, as a national proving ground for speeding up the delivery of more than 20,000 separate items in Class A steel products in the 30 steel warehouses in this area, the new WPB operation—a wartime "Steel Bank"—has set the pace for other units of this type, now being considered for other production cities throughout the nation.

"The cooperation of war plants and steel warehouses with the WPB Steel Warehouse section has been responsible for the handling of more than 1250 inquiries involving approximately 6,000,000 pounds of various steel items in its first two months of service operations," declared Harry H. Fair, WPB Regional Director.

Here is an example of the SWS operation:

"Hello—WPB Steel Warehouse Section—this is the Blank war plant calling—we need 1000 feet of 2½ inch cold rolled bar steel at once. Our warehouses are out of this steel product—and we must have delivery today to keep the night swing shift rolling."

"Okay—just a minute (time lapse for reference to card inventory of 20,000 Class A steel items). Hello—we have two warehouses carrying that steel—Here they are—John Doe Metals Company, phone number—etc., etc.—call them immediately and you should get delivery before the swing shift goes on."

This simple, two-way telephone operation of the SWS service, according to George Broughton, manager, involves the maintenance of a perpetual 24-hour inventory made by checking the stocks of the thirty major steel warehouses in the San Francisco-Oakland and East Bay in-

INCANDESCENT SUPPLY COMPANY

6 4 7

**MISSION STREET
SAN FRANCISCO**

Lighting Fixtures and
Lamps, Fireplace Furnishings, Pictures and
Mirrors, Electrical Supplies and Marine Fixtures.

**Oakland - Fresno
Los Angeles**

Independent Iron Works

Structural Steel
Ornamental Iron
Steel Service Stations
Steel Tanks
Standard Steel Mill Buildings
Bridges

821 Pine Street

Oakland

ANDERSON & RINGROSE

General Contractors

320 Market Street, San Francisco
Phone GARfield 2245

MULLEN MFG. COMPANY

BANK, STORE AND OFFICE
FIXTURES—CABINET WORK
OF GUARANTEED QUALITY
CHURCH SEATING

Office and Factory:
40-80 RAUSCH ST., Bet. 7th and 8th Sts.
San Francisco
Telephone UNderhill 5815

THE TORMEY COMPANY

GENERAL PAINTERS
AND DECORATORS

Phone UNderhill 1913

563 FULTON STREET
San Francisco

Phone GARfield 1164

Thomas B. Hunter

Consulting Engineer

DESIGNER OF HEATING
AIR CONDITIONING
VENTILATING AND WIRING
SYSTEMS, MECHANICAL
AND ELECTRICAL EQUIP-
MENT OF BUILDINGS

41 SUTTER STREET
ROOM 710
San Francisco California

Robert W. Hunt Company

ENGINEERS

Inspection - Tests - Consultation

Schools and Other Structures
Are Built as Designed

When Construction Materials are
inspected at point of Manufacture
and during Erection by

ROBERT W. HUNT COMPANY

Cement, Concrete, Chemical, Metallurgical,
X-Ray and Physical Laboratories

Chicago - New York - Pittsburgh
Los Angeles - All Large Cities
San Francisco, 251 Kearny Street

dustrial areas. All plants are required to check their normal warehouse sources of supply before applying to the WPB section for assistance.

"BILLBOARD IMMUNITY" BILL

After a careful study of the California Roadside Council's report on Senate Bill 714, the statements of County Planning Commissions regarding the bad effect it would have in their counties, and the manner in which it had been lobbied through the Legislature, Governor Warren has acted in the public interest by nullifying the bill.

The "Billboard Immunity" Bill, introduced for the billboard interests by Senator Powers, of Eagleville, would have given general outdoor advertising special privileges not enjoyed by any other business, and would have deprived counties of the right to protect the good appearance of their rural roadsides by county zoning against signs and billboards in many rural areas.

This was the third unsuccessful attempt to foist this type of legislation upon the State of California. Taking advantage of the public's preoccupation with the war, it was introduced as a "sneak bill" containing innocuous provisions which were completely rewritten as an "amendment" and jammed through the Senate before effective opposition could be organized. In spite of hastily summoned opposition by the California Roadside Council, County Planning Commissions, Boards of Supervisors and others, the bill passed the Assembly by one vote.

Thereupon, the CRC went into action to inform the Governor of the bad features of the proposal, and to bring to his attention the widespread opposition to its enactment. Splendid support was received from county officials, cooperating organizations and CRC members throughout the state, who sent letters and telegrams urging the Governor to veto the measure.

4-ACRE BLACKOUT PLANT

Opening of a new four-acre blackout plant on the East Coast to speed

USE
Mailway
Banking

**SUNDAYS OR
HOLIDAYS**

Don't wait for "the bank to open."
With our Mailway service, and special envelopes and passbook, do your banking with us by mail at your nearest mailbox. More and more people are opening Mailway accounts because they can do their banking when most convenient. Open a Mailway account today... checking or savings, business or personal.

Write for information

**CROCKER FIRST
NATIONAL BANK**
OF SAN FRANCISCO
California's Oldest National Bank

Member Federal Deposit Insurance Corporation
ONE MONTGOMERY STREET

production of special type radio equipment for the army has been announced by Walter Evans, vice-president in charge of Westinghouse Radio Division.

Designed to conserve critical materials, the new plant used 1,554,000 board feet of lumber, at an estimated saving of 1920 tons of steel. It required the use of more than one acre of pressed wood panels in place of window glass. Westinghouse will operate the factory for the Defense Plant Corporation.

The plant area is divided into two main sections, one for assembly of parts, the other for machining and fabricating. An innovation is the handling of interior traffic, which flows next to the side walls, leaving the remaining areas clear. Lighting and ventilation are carefully controlled in the building which contains nearly two miles of tubular fluorescent lamps to simulate daylight working conditions. Huge electric fans, effecting a complete change of air every 15 minutes, provide ventilation.

A L A D D I N

Heating Corp.

Specializing in

**QUALITY HEATING
EQUIPMENT**

2222 San Pablo Avenue

OAKLAND

TWInoaks 1022

ABBOT A. HANKS, INC. Engineers & Chemists

INSPECTING — TESTING — CONSULTING
CONCRETE • STEEL • MATERIALS
CHEMICAL AND TESTING
LABORATORIES

• RESEARCH AND INVESTIGATION •

TESTS OF STRUCTURAL MATERIALS
DESIGN OF CONCRETE MIXES
SHOP AND ERECTION INSPECTION OF
STRUCTURES AND EQUIPMENT
INVESTIGATION OF STRUCTURES
AND MATERIALS
TESTS AND INVESTIGATION OF
FOUNDATION SOILS
FIRE RESISTANCE AND INSULATION
TESTS

624 Sacramento Street, San Francisco

G. P. W. JENSEN & SON

Building Construction

3211 Market Street, San Francisco

Phone: GARfield 2444

Scott Company

HEATING - - PLUMBING - - TILE



243 MINNA STREET

SAN FRANCISCO

INDUSTRY ANALYSTS WANTED

More and more critical positions in the Government service are being vacated by men drawn into the armed services. Qualified persons must be recruited to replace these men. There is a particular need now for persons who have had executive experience in business or industry to do work in connection with the extension of the rationing program in various commodity fields.

Persons are desired who have had executive experience (involving analysis in business or industry as distributors or manufacturers of such commodities as foods, textiles, metals, consumer goods, or industrial equipment. Specialization may have been in sales management, factory management, procurement, market analysis, traffic management, or expediting of production.

Men are needed to make analyses with regard to distribution and production; to analyze the needs for and the supply of critical materials, consumer goods, and industrial commodities; to survey the availability of productive capacity, materials, or commodities, and the possibilities of substitution; to work out, after consulting with government agencies and business organizations, balances between requirements and supply.

The positions pay from \$2433 to \$7128; however, few appointments will be made to positions paying \$5228 and over. There are no age limits for this examination and no written tests. Persons now using their highest skills in war work should not apply. Appointments in Federal positions are made in accordance with War Manpower Commission policies and employment stabilization plans.

FLUORESCENT LIGHTING

From distant, war-mobilized Australia comes an interesting bulletin "Wartime Lighting," issued by the Commonwealth Department of Labour and National Service, in which cold-cathode fluorescent lighting is dealt with extensively. "Electric discharge lamps will light the future because they produce cool light for about one-third of the electricity

consumption of incandescent lamps of the same light output," states this bulletin. Photographs made in Australian plants show the effectiveness of cold-cathode. The bulletin recommends the placement of the cold-cathode light source about 4 feet above the task, and places great stress on the cool operation as well as the shadowless and glareless nature of such illumination.

CURE FOR ABSENTEEISM

Despite the fact that Los Angeles housing accommodations are lowest in the city's history, according to a recent report of David Barry, Jr., Office of Price Administration, rent control officer, there are 2,500 new low-rent homes for war workers now ready for occupancy. Nicola Giulii, chairman of the City Housing Authority, has stated.

These homes are made available through the final completion of Aliso Village, 802-unit development at 1401 East First Street; Wm. Mead Homes, 1300 Cardinal, a project of 449 apartments; Wilmington Hall, 3,000-room hotel for men, in Wilmington, and Channel Heights Homes, 600-family project in San Pedro. With the exception of Channel Homes, the projects are partially occupied.

Giulii points out that construction of the modern war worker rental homes near essential industries has alleviated the acute housing shortage to some extent and because of the careful planning for community services, the projects are also helping to relieve absenteeism in certain war industries.

A. F. MATTOCK CO.

Builders



212 CLARA STREET

SAN FRANCISCO

ARCHITECT AND ENGINEER



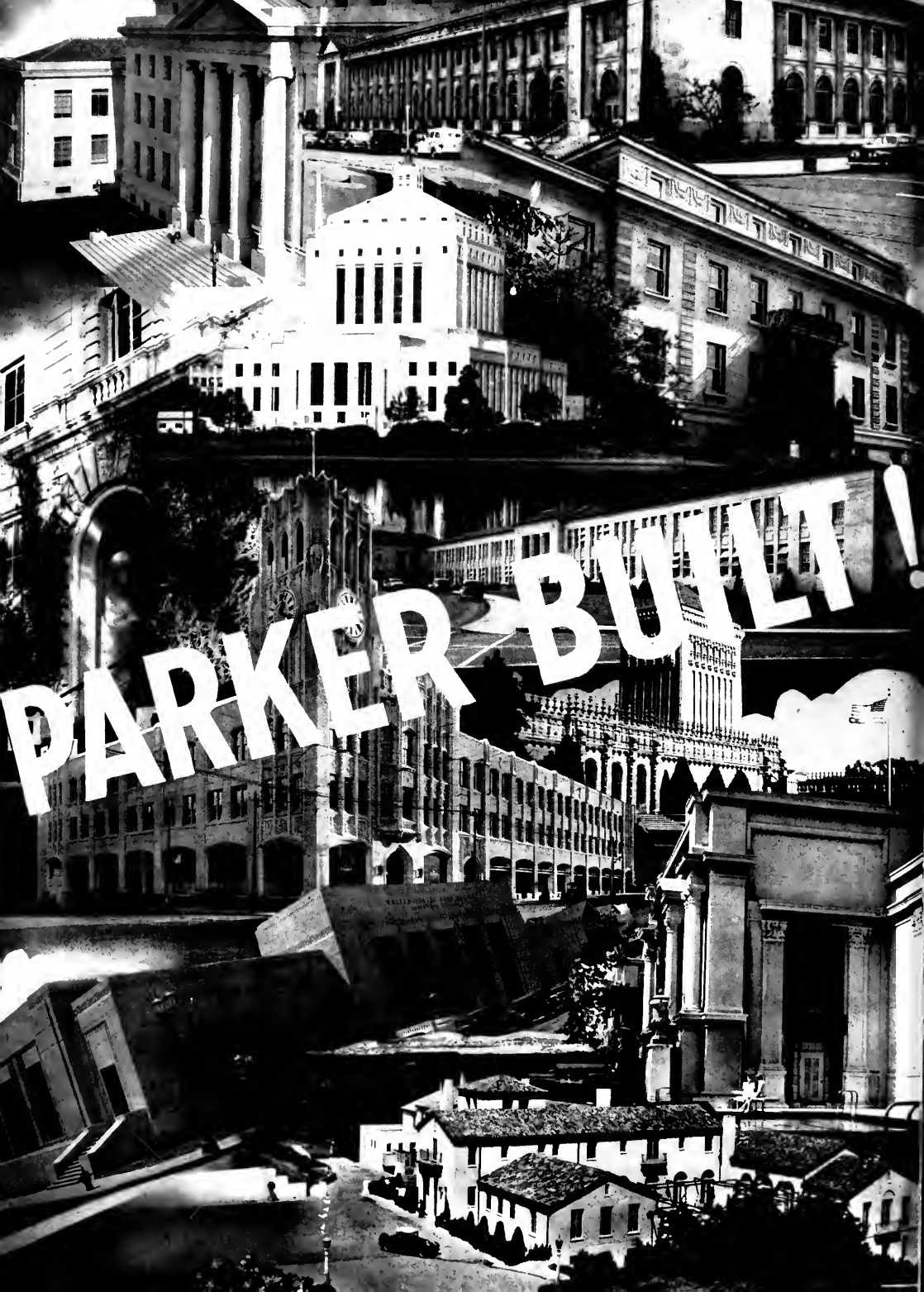

PARKER BUILT!

ARCHITECT AND ENGINEER

AUGUST, 1943

Vol. 154 No. 2

FRED W. JONES
Editor

MARK DANIELS
Associate Editor

HOWARD MOISE
Post-War Planning

E. N. KIERULFF*
Ass't Editor

COVER PICTURES:

Left to right: Sunnyvale Cannery Office Building; Lincoln School, Redlands, California.

PHOTOGRAPHY:

Roger Sturtevant: Sunnyvale Office Building; Luckhaus Studio: John Adams Junior High School, Santa Monica, California.

CONTENTS

Running Fire	3
Mark Daniels, A.I.A.	
News and Comment on Art	4-7
Henry Moore, English Sculptor	4
Douglas MacAgy	
Office Building for the Schuckl Canning Company	13
Burbank City Hall	18
Planned Housing for the Future	24
George Pampel	
Post-War Aviation	29
A. C. Ballaseyus	
Post-War Gymnasium and Open Type School	33
Architect' Bulletin	37-38
The Snake Swallows Itself	37
Wm. C. Ambrose, A.I.A.	
Producers' Council	39

Illustrations

Office Building for the Schuckl Canning Company	12-17
William W. Wurster, Architect	
Burbank City Hall	18-25
William Allen and W. George Lutzi, Architects	
Post-War Gymnasium and Schools	33-36
Marsh, Smith & Powell, Architects	

ARCHITECT AND ENGINEER (Established 1905) is published on the 15th of the month by The Architect and Engineer, Inc., 68 Post Street, San Francisco. President, K. P. Kierulff; Vice-President, Fred'k W. Jones; Secretary-Treasurer and Manager, L. B. Penhorwood; Advertising Manager, V. E. Atkinson, Jr.
Los Angeles Office: 403 W. 8th Street, Robert W. Walker, Manager.

Entered as second class matter, November 2, 1905, at the Post Office in San Francisco, California, under the Act of March 3, 1879. Subscriptions, United States and Pan America, \$3.00 a year; \$5.00 two years; foreign countries \$5.00 a year; single copy 50c. ARCHITECTS' REPORTS are published daily from this office, Vernon S. Yallop, Mgr.

NEXT MONTH

PROBABLY no municipal housing authority in the nation has carried through a more extensive program than Los Angeles. Besides ten permanent developments the Authority there is managing five temporary war housing projects, with a combined population of some 27,000 people.

The story of the tough problems that faced the Authority from the beginning to the end of the construction period is told by Harrison Stephens, who has compiled a fund of interesting and informative statistics for Architect and Engineer readers. A number of heretofore unpublished pictures of the several projects will accompany Mr. Stephen's article.

San Francisco's downtown traffic congestion grows worse as the city's population increases, due to war time influx of workers. A possible solution to relieve this congestion is offered by the Donald R. Warren Company, engineers, who have designed an "El-Way" to circle the downtown area within a radius of one-half mile from the intersection of Kearny and Post Streets. The El-Way consists of a six-lane divided highway forming a loop about the heart of the city's business district. Drawings show the proposed course of the El-Way and give details of the type of construction.

Some architectural uses for West Coast hemlock are enumerated in an interesting discussion of this native lumber by R. T. Titus of the West Coast Lumbermen's Association.



HAWS
Model No. 8G6
Semi-automatic Stream Controlled

A help on the Job...



because fresh drinking water helps the people who make the materials with which our fighting men use to win the war. HAWS Drinking Fountains and Faucets provide a constant supply of fresh and healthful drinking water. The HAWS angle stream fountain head affords complete sanitation. Architects who plan for industry must plan for healthful working conditions too! Specify HAWS Drinking Fountains and Faucets for the comfort, convenience and satisfaction of the industrial worker. There is a style or design for every particular requirement. Consult our catalog!

HAWS DRINKING FAUCET COMPANY

1808 HARMON STREET • BERKELEY, 3 • CALIFORNIA

Agents in the following cities:

Chicago • Los Angeles • San Francisco • Seattle • Salt Lake City • Portland
New Orleans • Houston • Atlanta • Philadelphia • Worcester, Mass.

RUNNING FIRE — by MARK DANIELS

• THE ENGINEER AND ARCHITECT

For the past seventy-five years a gap has been widening between the engineer and the architect. Time there was when the titles were interchangeable and all but synonymous, but specialization has driven in a wedge that has resulted in an all but complete divorce. Leonardo Da Vinci was an engineer, an architect and an artist, yet his attainments in any one of his professions did not detract from the fame in the others.

The history of the doctor and the surgeon is more or less parallel with that of the engineer and the architect, although their common ancestor, the Midwife, may have a tendency to hold them together, for a surgeon is still a doctor, or should be. Nevertheless, specialization here also is "making little ones out of the big ones" for we are now getting the eye doctor, the heart doctor and even the corn doctor where once we had the general practitioner who did everything.

The basic training of the medical doctor bears about the same relation to that of the surgeon as does that of the engineer to that of the architect or vice versa. It is that of learning to think logically along certain scientific lines. There is no difference in the method of thought learned in architectural training and the method learned in engineering training. The addition of other factors in subsequent experience or further training causes the ultimate divergence in practice.

This subject has been discussed at great length and in a clear, masterly manner in a recent book by Theodore J. Hoover and John C. L. Fish, entitled "The Engineering Profession," published by the Stanford University Press and the Oxford University Press in 1941. It is one of the best and most convincingly presented works of a profound subject I have read in recent years and is well worth the while of any architect or engineer.

"The marvelous advance of the nineteenth century science opened the doors to the practical application of the vast fields of knowledge, and it became impossible for one man to master more than a few departments of the rapidly growing technology," and "These problems are of design, of research, etc., and are common to all the engineering fields . . ." the authors state early in the book. They might well have added "and architecture." The book includes excellent treatises on the engineer's method of attack, analysis and conclusion.

We are prone to think of all forms of engineering as either structural or mechanical but problems in enameled metals, plastics, paints, hardware and innumerable other elements of construction are calling for the development of a type of engineer and architect where they were once left to the "general practitioner."

But get the book. This is not meant to be a review, nor can it be. At least, you will be convinced that there is only the thin line of aesthetics dividing engineering from architecture and that there is no reason why the qualifications for both cannot be under one brain pan. They have been.

• GRATIFYING

It is not good form to pat one's own back, even if it were possible, but it is difficult to refrain from a little crowing.

In last month's issue, in this column, space was devoted to what is becoming a bit overdone, the "House of Tomorrow." In that issue I contended that prefabrication was not new and that we have been doing it on one scale or another in house construction for many centuries. Now come greater minds to say that they have the same opinion.

Mr. Arthur H. Hood, of the Johns-Manville Corporation, in the July issue of "Western Building," devotes a fine article to an effort to present the "House of Tomorrow" in a realistic light, and does so, at least I think he does so in the light of last month's RUNNING FIRE. He says, "As a matter of fact there is nothing new about the trend to prefabrication. This has been going on ever since houses were built of earth and logs. Sawn lumber and bricks were the first prefabrication and this process has been going on centuries, and it will continue to do so . . ."

Mr. Kenneth K. Stowell, Editor in Chief of "Architectural Record," states in the first page of editorial content in the July issue that "The house-of-the-future will perform the same functions as the house-of-the-past and the house-of-the-present. The functions will be to provide shelter, privacy and comfort for each member of the family, and for the family as a whole."

While Mr. Stowell's article was not confined so closely to the subject of prefabrication, by inference one is justified in considering the two articles in the same light. Or am I exercising poetic license?

• CENSORSHIP IN REVERSE

The office of censorship inaugurated a radical change in the censorship of publications. Without going into details of the methods, the basic idea was to let the censoring be done by the publishers, having the particular publication examined only once by the nearest censorship office for all, instead of having it reviewed by every station which might receive it before it enters the mail stream. The former procedure slowed up deliveries and often resulted in condemnation of publications, due to differences in opinion at the different stations as to what should be passed. It was calculated that this would be a great help to the publishers, which it actually has been. It was really censorship in reverse.

But a few publishers have said, "Well, we'll think it over." They are the type who, if they were paid off in coin instead of cheque, would bite the coin before signing the receipt. Perhaps they are justified, in the light of the number of hat-pins they have found in the bouquets they have received from other departments of the government.

(Turn to Page 7)

NEWS AND COMMENT ON ART

HENRY MOORE, ENGLISH SCULPTOR

by Douglas MacAgy

Until recently, contemporary English art was so little known in this country that when we thought of it at all, the conspicuous figure was Augustus John. Indeed, even John's fame on this side of the Atlantic is probably due less to a knowledge of his painting than to Aldous Huxley's celebrated characterization. Yet that interesting painter, if he still commands the attention of London society, belongs to the past in spirit. His personality has provided us with perhaps the last flare from the darkening embers of the British tradition of portraiture.

English art of contemporary spirit first appeared during the Great War. At that time certain youthful artists, including Paul Nash and Edward Wadsworth, were busy painting "war records" for the Government. The Imperial War Museum in London, in which the products of this activity were placed, also contains official portraits and retrospective paintings by John, Orpen, Bone and Lavery. In this Museum the periods meet, the old and the new.

Henry Moore, who served in the army during the Great War, did not begin his art studies until after he was demobilized. Before long his interests led him in a direction which has coincided at certain points with the development of artists such as Nash and Wadsworth. There have been occasions when his efforts were explicitly linked with theirs, but the association was formed because they held some views in common and it was convenient to present them to the public in concert.

Like his fellows, Henry Moore stands apart from the conventional line of English art. But he is a sculptor, and because the traditions of sculpture have been less open to change than those of painting, he is not so dependent on the old line as his colleagues who paint. Even since the Renaissance, painting has been so various that it is possible for the most advanced modern painter to make use of some pictorial contribution of the period. He might find something in Vermeer, or Chardin, or Courbet, which will give him a notion of how to go on with his own work. But a sculptor like Moore cannot expect much help from any statue which was carved in Europe during the same period. At points which are held by Moore to be most significant, Renaissance sculpture takes an opposite stand to his. On the other hand, in common with certain continental sculptors, he holds a brief for primitive and medieval carvings.

Primitive, medieval, and Renaissance sculptors were concerned with the representation of familiar things, of animals and people. What sets Renaissance sculpture apart from the others is the fact that representation takes the form of imitation. Stone is shaped and textured to look like a person, although it is sometimes modified to conform with a classical ideal of human appearance. But stone is a hard and concentrated substance; it should not, from Moore's point of view, be disguised to look like human flesh. In shape and texture, the

peculiar characteristics of stone are lost or falsified in the process of imitation.

Many modern sculptors resent the notion that shape is an abstraction which might be imposed on any material. They believe that shape grows out of the properties of the stuff that composes it. Moore makes much of his studies of natural objects, of shells, bones and pebbles. "Shells," he writes, "show Nature's hard but hollow form and have a wonderful completeness of single shape." On the other hand, "bones have a marvelous structural strength and hard tenseness of form, subtle transition of one shape into the next and great variety in section."

His profound admiration, even affection, for natural properties of things is partly responsible for Moore's claims against sculpture in the Renaissance tradition. In the transformation of rock to apparent flesh, the rock is, in effect, destroyed. But if this were his sole concern, he would probably leave his pieces of stone and wood in their natural state. A gash from his chisel might very well spoil Nature's handiwork. Other concerns motivate the carving. Like some Gothic and primitive sculptors, he tries to make a representation which will retain the character of the material out of which it is carved.

"Each carving I make takes on in my mind a human, or occasionally animal, character and personality, and this personality controls its design and formal qualities, and makes me satisfied or dissatisfied with the work as it develops." This anthropomorphism, or zoomorphism, is often not specific. Shaped by Moore a stone is not just granite, just a woman, or just a cat. Resemblance to particular things is seldom easy to trace. His shapes are ambiguous and general in their reference to familiar things. Often they look more like human figures than anything else, but even this resemblance is compromised by more or less drastic shifts from normal human proportions. These shifts lead the mind into other considerations, other spheres of experience than those suggested by the shape of a man or woman. At this point one stands at the brink of conscious and unconscious memories and desires. The sculpture gains meaning as its shapes and textures touch off clusters of associated meanings in this inestimable store of experience. In Moore's words, the meaning of a shape "depends on countless associations of man's history. For example, rounded forms convey an idea of fruitfulness, maturity, probably because the earth, women's breasts, and most fruits are rounded, and these shapes are important because they have this background in our habits of perception." Combine such associations with the sense of timeless erosion, of weather-worn, Nature-worn stone, and you will be close to the world of Henry Moore.

But his sculpture does more than act as a kind of magnet for memories. It is more than a meeting place for recollected thoughts and feelings. The act of recollection which it causes, often disquieting and obscure, is not an idle process. The very spontaneity of the effect discounts reverie and

AN EVER CHANGING WORLD

suggests a response to an active, if unknown, need in one's personality. It is this dynamic character of a cryptic action which allies Moore with Surrealist tenets. He is, of course, perfectly aware of the similarity between his procedure and Surrealist theory, but he himself takes a broader stand. "All good art," he has said, "contains both abstract and surrealist elements, just as it has contained both classical and romantic elements—order and surprise, intellect and imagination, conscious and unconscious. Both sides of the artist's personality must play their part."

Sometimes he begins drawing without any particular plan in mind, simply to make lines and tones and colors without a conscious aim, but there always comes a time when some part of the result takes on a conscious meaning, and when this occurs he proceeds with conscious purpose and control. It should be added that even this rational development is marked by occasional breaks in procedure that reason cannot account for.

Moore makes drawings for many reasons. Sometimes he fills page after page with amorphous blurs around which he draws a variety of contours as if he were probing stone with a chisel. In this manner he is able, on occasion, to generate an idea for sculpture, or perhaps to sort out some

ideas before he attacks the stone directly. Or else, because carving is a slow process when compared with drawing, he uses drawing as an outlet for ideas which cannot be realized in sculpture for want of time. Drawing is also useful to him when he wishes to investigate the characteristics of natural form. The lineaments of human figures, bones, shells, and pebbles are a familiar sight in his portfolios. In 1940 he made a series of drawings of people in London air raid shelters which seem to have been done as ends in themselves.

About twelve years ago Moore made illusionistic drawings of solid objects in light and shadow. Soon he began to feel that this method was acting as a substitute for sculpture, that it was weakening his desire to carve. Around 1935 he drew in flat tones and line, without resource to light and shade. In effect, these drawings are almost two-dimensional, but to Moore they are schematic representations of shapes conceived in the third dimension. By virtue of this style, the drawing retained its suggestive power, without being cut-and-dried as in the former method. Now, however, perhaps because the original sense of finality which he found there has been overcome, he has resumed the practice of drawing solid shapes in light and shadow.

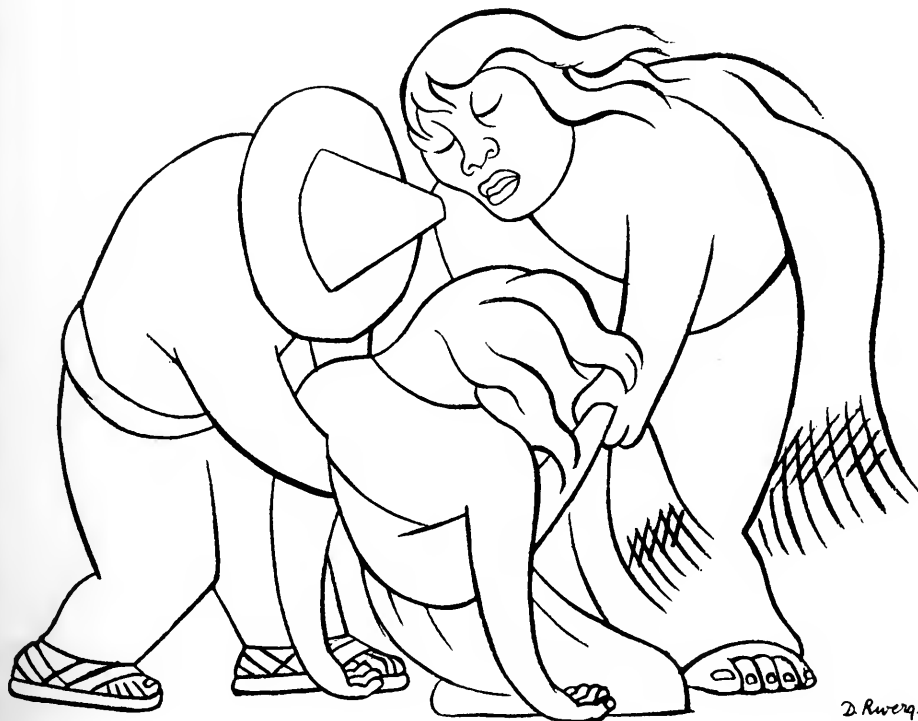

Diego Rivera, 26

"THE DRUNKEN WOMAN," by Diego Rivera

San Francisco Museum of Art

Like all good sculptors, Henry Moore is sensitive to the impressive effects of size, both actual and imaginary. Some objects, as at Stonehenge, are awe-inspiring by their actual bulk. Others might be small in actuality, but may strike the imagination as colossi. Modern sculptors often make deliberate efforts to accomplish this impression of great imaginary scale in their works of even moderate size. Modern painters, on the other hand, are hardly conscious of this effect. Yet it is at least equally possible in painting. In fact a painting is less affected by actual size than a sculpture, and is likely to retain its own imaginary scale more easily. Moore's drawings possess this imaginary power of dominating scale. Certain other artists, notably Michelangelo, have been able to achieve the effect on paper, but at present Moore stands almost alone in this achievement.

Some of his drawings, among those recently shown at the San Francisco Museum of Art, include figures placed within a definite setting. In others the shapes are placed one above the other, interlocking or in private compartments of shadow, until they cover the paper. Here the shapes loom from a pervasive chiaroscuro which provides a common atmosphere within the pictorial space, while the pitted surface of the paper screens in the objects from the front. The shapes themselves sometimes look like pebbles or bones, their sockets veiled in shadow with "the mysterious fascination," as Moore once wrote, "of caves in hill-sides and cliffs." Now they resolve themselves into anthropomorphic figures, rather like Picasso's anatomical studies of about 1933; again a shape may remind one of the bony masks of the white monkey carved by the natives of the French Sudan. The latest drawings are devoted to more positively recognizable features. The figures, bandaged in their drapery, are reminiscent not only of his past sculptures, but of the huddled forms which Moore drew in the limbo of the shelters during the raids of 1940.

"MEET THE ARTIST" AT THE DE YOUNG MEMORIAL MUSEUM

Major event at the De Young Museum during the current month is the self-portrait show of American artists. Despite great difficulties entailed in collecting so comprehensive an exhibition, including most of this country's major painters and cartoonists, the list of "celebrities" represented in this unique show, reads like a prize-winning art roster of pre-war days. John Stewart Curry, Reginald Marsh, Paul Cadmus, Thomas Benton, John Carroll, Lyonel Feininger, Henry Varrum Poor, Robert Brackman, The Soyers, Leon Kroll, Morris Kanter, George Grosz and Henry Mattson are among the familiar faces.

A self-portrait show, on the face of it, (no pun intended) might be a rather dull affair if the artists were to confine themselves to the accepted meaning of the term. But this, luckily, has by no means occurred in the current show. Of the almost 200 works assembled, the vast majority of artists have either managed to find an original approach to the self-portrait or have individualized the conventional one. For instance: the paint-

ing by Guy Pene du Bois who invites the spectator to discover him in "The Crowd" as his "self-portrait" is fittingly entitled. What happens when a landscape painter does a self-portrait is shown in Constance C. Richardson's oil in which high upon a green hill is the tiny figure of the artist before her easel. Peppino Mangravite amuses himself (and us) by standing before an unfinished canvas out of which dance four female figures carrying him all his worldly comforts: his newspaper, slippers, pipe and glass of "vino"; the artist himself is holding a pomegranate, the fruit of life, in his left hand.

Another thing which makes this self-portrait show a unique one of its type is that when invitations were extended, each artist was asked to contribute not only a single self-portrait, but two, so that the public might have a seldom-realized opportunity to see for themselves the progress a particular artist may have made during the course of his career. Nowhere is this progress more strikingly seen than in the three sets of "duos" by Robert Philipp, Benjamin Kopman and Fred Nagler. Not only are those paintings tremendously interesting as separate studies, but also as comparisons in the changing styles of three painters who started with an almost common technique and who today represent totally different schools of art. The range in time is from about 1910 when each artist, fresh from art school, donned his black velvet beret and took himself extremely seriously in the rich, dark tones reminiscent of the old masters. Today we find Philipp painting in a gay, semi-impressionistic manner, Kopman borrowing from the school of German Expressionism and Nagler developing his own smooth realistic style. This chosen group is just one of the many "foods for thought" which visitors will want to digest.

CONTEMPORARY AMERICAN PAINTINGS AT DE YOUNG G. G. PARK MUSEUM

At the De Young Museum is an excellent exhibition of contemporary American works, an interesting companion show to the large self-portrait exhibit now showing. It is the group of one hundred paintings—oils, watercolors, gouaches and pastels—belonging to the University of Arizona which was recently previewed at the Metropolitan Museum of Art. The history of this collection, though recent, is extremely notable because it inaugurates a new trend in the "business" of art collecting. The donor of the entire group, a former philatelist who prefers to remain anonymous, long felt that the acquiring of fine art need not necessarily be either a strictly personal affair—or an expensive one. Selling his stamp collection, he has obtained enough money during the past few years to build up a remarkable representation of living American art which, chosen with the aid of qualified art directors, teachers, etc., is now a permanent part of the Arizona Gallery of Modern American Painting.

Concerning the collection itself, although works were purchased on merit alone regardless of the name or fame of their creators, it is natural that the "John Henry's" of many of the country's leading artists should appear. For instance, oils by Arnold Blanch, Edward Hopper, John Sloan, Joe

Jones and Doris Lee and watercolors by Charles Burchfield, Adolph Dehn, Peggy Bacon and Walt Kuhn, to name only a few, form an important part of the show.

The self-portrait show of contemporary Americans, "Meet the Artist," and the painters whose works will be found in both exhibits, include Isabel Bishop, David Burliuk, Waldo Pierce, John Stewart Curry, Raphael Soyer (who, incidently, contributes a self-portrait to each show), George Grosz, Joseph de Martini, Doris Rosenthal, Philip Evergood, William Gropper, Reginald Marsh, Yasuo Kuniyoshi and Robert Philipp. So after having seen the artist as he sees himself in one gallery, it is a novel experience to find in another a recent landscape, still life or abstraction done by the same hand.

EGYPTIAN ARCHITECTURE SHOWN AT LEGION OF HONOR PALACE

Now showing at the California Palace, Legion of Honor, San Francisco, is an exhibition of Egyptian photographs consisting of some 25 enlargements made by Professor Hamman and his son. The photographs were taken during an expedition to Egypt in the spring of 1937. The first group shows the land and the people of the Nile Valley. The architecture is represented in the second group, showing some of the famous buildings of ancient Egypt, the pyramids, the best-known temples, mortuary chapels and tombs.

The remaining group give a short survey of Egyptian sculpture, painting, and workmanship, having been chosen chiefly in regard to the subjects depicted. The reliefs and paintings show scenes of public and family life in Egypt thousands of years ago, while the chairs and vase from the tomb of Tut-ench-Amun give us an impression of the unique skill of these early craftsmen, and the statues include many well known representatives of Egyptian history.

MODERN VERSE WINS MRS. MOORE THE ALBERT BENDER GRANT-IN-AID

Mrs. Rosaline Moore, a Berkeley housewife, has been awarded the Albert Bender Grant-in-Aid for her contributions to literature. The poems were first printed in *The New Yorker* and later one of them, "Catalogue," was reprinted in Louis Untermeyer's "Stars to Steer By." The award was made by a jury of eminent litterateurs appointed by the San Francisco Art Association. The verses follow:

WHAT FUN TO BE, ETC.

(First Printed in *The New Yorker*)

What fun to be Picasso and landscape an oh so
Formal torso! What fun to be Picasso!

What fun to be Gris and—seated vis-a-vis—
Draw, quarter, and cube some noted portraitee,
Put a fluttering nose, an eye in the midst of him,
Interlocking jaws, and a double chin
(One, that is, that besides coming out goes in).
A tie, and limbs with a synonym!

What fun to be Braque, to shock, to paint bric-a-brac
Like bottles and guitars that say A B C!
Or Klee. What fun to be Klee, Gris, Picasso, or Braque!

CATALOGUE

(Printed in *The New Yorker*; Reprinted in *Stars to Steer By*)

Cats sleep fat and walk thin.
Cats, when they sleep, slump;
When they wake, stretch and begin
Over, pulling their ribs in.
Cats walk thin.

Cats wait in a lump,
Jump in a streak.
Cats, when they jump, are sleek
As a grape slipping its skin—
They have technique.
Oh, cats don't creak.
They sneak.

Cats sleep fat.
They spread out comfort underneath them
Like a good mat,
As if they picked the place
And then sat:
You walk around one
As if he were the city hall
After that.

If male,
A cat is apt to sing on a major scale;
This concert is for everybody, this
Is wholesale.
For a baton he wields a tail.

(He is also found,
When happy to resound
With an enclosed and private sound.)

A cat condenses.
He pulls in his tail to go under bridges,
And himself to go under fences.
Cats fit
In any size box or kit,
And if a large pumpkin grew under one,
He could arch over it.

When everybody else is just ready to go out,
The cat is just ready to come in.
He's not where he's been.
Cats sleep fat and walk thin.

RUNNING FIRE

(Continued from Page 3)

• OVERDONE

Those who are expecting a burst of new and miraculous inventions, materials and devices to swamp us with secrets of comfort, ease of operation and economy of living after the war, had best prepare for disappointment. We have gone too far with the siren songs of plastics, one way glass, electronics, radar, and yes, vitamins. Some of these developments will be liberated to develop after the war but it will take time. Some will go ahead with speed and will meet with immediate success. Many will not turn out to be what was expected and will give way to other and newer discoveries. But I fear that some of the best will be fought bitterly from the beginning.

For example, prefabrication already is in the preliminary struggle with labor. Good, bad or indifferent, labor feels that prefabrication is going to cut in on labor's field. It is like the struggle that the cotton gin, the steam engine and similar inventions went through. And as to plastics, wait until the plumbers learn that both the rough and finish plumbing can be installed in a bathroom within an hour, without a helper! The Tunisian campaign will be nothing!

Doing the **WAR** JOBS



When labor is scarce and building hurried, call on Cabot's Shingle Stains for your war jobs. These stains are quickly and easily applied. They give maximum protection at minimum cost. And they do not peel or blister even when used on unseasoned lumber or before the building has dried out.

Booklet color card free



GUNN, CARLE & CO.

20 POTRERO AVE.
SAN FRANCISCO
Underhill 5480

GET PEACETIME QUALITY

in Wartime Construction

★ ★ WITH KRAFTILE ★ ★

**No Priority • Immediate Delivery
End Building Bottlenecks**

Here are 5 big reasons why KRAFTILE CLAY PRODUCTS can be used to replace steel and other critical materials on *any* heavy construction job.

1. When it's built with KRAFTILE it's built to last; no upkeep cost.
2. KRAFTILE is waterproof, fireproof, stainproof, verminproof and scratchproof.
3. There's no quantity limitation on non-critical KRAFTILE Clay Products.
4. KRAFTILE saves up to one-half the time on interior walls... surfacing is unnecessary, since KRAFTILE WALL UNITS come pre-tiled one side, or both.
5. You can erect KRAFTILE installations in one-third the time required for old-fashioned frame construction. Only one craft is necessary for an entire job when you use KRAFTILE.



For more information,
phone or write today to

KRAFTILE
NILES, CALIFORNIA

Hot baths for Uncle Sam's Army and Navy

from

AQLUX Heavy Duty WATER HEATERS



Hot water builds military morale, Uncle Sam is supplying it as generously as possible at American camps and posts throughout the world. It is a matter of pride to us that Johnson-built Aqlux Water Heaters have been chosen for so many of these government installations.

The exceptional performance and fuel-economy of Aqlux Heaters was a determining factor in their selection. Government procurement officers were guided by the 80% Efficiency Rating.

The rapid recovery and the low operating costs we have achieved in these un-jacketed, insulated, ungalvanized wartime models.

Though virtually all of our capacity is being devoted to these government orders, we are endeavoring whenever possible, to take care of the needs of essential private industries.

If you have a water-heating or oil-burner problem, we will gladly help you with all the manufacturing facilities and engineering experience at our disposal.

S. T. Johnson Co., 940 Arlington Ave., Oakland, Calif.,
and 401 No. Broad St., Philadelphia, Pa.

S. T. JOHNSON CO.

40 years of engineering and building for Oil Burning Equipment

RAYMOND

CONCRETE PILE

COMPANY

816 W. 5th St.
LOS ANGELES

PILING CONTRACTORS

for the new
**BURBANK
CITY HALL**

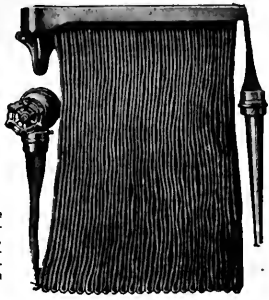

Lightning Hose Rack, Plate 2, supported from wall, steel girder, wooden or concrete column. Carries linen hose.

Big Fires Grow from Small Beginnings

Buildings properly equipped with fire hose, made easily available by Lightning Hose Racks, are far safer from destructive fires.

The AMERICAN RUBBER

Factory and General Offices: **Manufacturing Co.**
Park Avenue and Watts Street, Oakland, 8, California

TEAMWORK for SECURITY

GOLDEN GATE • OLD MISSION
PORTLAND CEMENT PORTLAND CEMENT

MILCOR
METAL LATH PRODUCTS

EMPIRE STANDARD
GYPSUM PLASTER GYPSUM PLASTER

PACIFIC
PORTLAND CEMENT COMPANY

FOR SOUND CONSTRUCTION

Index to Advertisers

*Indicates Alternate Months

A	
ALADDIN Heating Corp.	47
AMERICAN Rubber Mfg. Co.	9
ANDERSON & Ringrose	46
B	
BASALT Rock Company	43
BAXTER & Company, J. H.	10
C	
CASSARETTO, John	48
CELOTEX Corp.	*
CLARK, N., & Son	46
CLINTON Construction Company	45
COATES, Leonard, Nurseries	48
COLUMBIA Steel Company	Back Cover
CROCKER First National Bank	47
D	
DINWIDDIE Construction Company	46
E	
EL ENCANTO Hotel	44
F	
FORDERER Cornice Works	45
FULLER, W. P., Co.	*
G	
GUNN, Carle & Company	8
H	
HANKS, Inc., Abbot A.	46
HAWS Drinking Faucet Company	2
HERRICK Iron Works	46
HOGAN Lumber Company	45
HUNT, Robert W., Company	47
HUNTER, Thos. B.	47
I	
IMPERIAL Brass Mfg. Co.	*
INCANDESCENT Supply Co.	46
INDEPENDENT Iron Company	46
J	
JENSEN & Son, G. P. W.	48
JOHNSON Company, S. T.	8
JUDSON Pacific Company	45
K	
KRAFTLE Company	8
M	
MULLEN Mfg. Co.	47
N	
NORTHERN California Electrical Bureau	11
P	
PACIFIC Coast Gas Association	*
PACIFIC Foundry Company, Ltd.	10
PACIFIC Manufacturing Company	44
PACIFIC Paint and Varnish Company	38
PACIFIC Portland Cement Company	9
PARAMOUNT Built-In Fixture Company	*
PARKER, K. E.	Second Cover
R	
RAYMOND Concrete Pile Co.	8
REPUBLIC Steel Corporation	44
S	
SALL Mountain Company	11
SCOTT Company	48
SIMONDS Machinery Company	44
SISALKRAFT Company	43
STANLEY Works, The	*
T	
TORMEY Company, The	47
U	
U. S. STEEL Company	Back Cover
V	
VERMONT Marble Company	43
W	
WASHINGTON-Eljer Company	10
WESTERN Asbestos Company	*
WOOD, E. K., Company	10



FOR YOUR "AFTER - THE - WAR" HOMES

Of course, there will be new designs for plumbing fixtures in that exciting "after-the-war" building era that lies ahead — new comforts, new beauty, new safety and new economy.

You will want these fixtures in your "homes of tomorrow." But in addition, you will demand that behind these new designs are the sterling values that can be built-in only by long years of specialized experience in correct design and quality manufacture.

The WASHINGTON-ELJER trademark is your assurance—now and in the future—of the satisfying unity of up-to-the-minute design and old-fashioned dependable quality.

WASHINGTON-ELJER CO.

4100 S ALAMEDA ST.
LOS ANGELES, CALIF.



QUALITY PLUMBING
FIXTURES SINCE 1896



QUALITY AND DEPENDABLE *Service*

are the factors that influence architects and contractors when selecting lumber and mill work — Quality of merchandise — Integrity and Ability of the firm—Service in physical equipment — Experience and Personnel — All these factors contribute to a speedy and satisfactory completion of construction with minimum of time and expense.

MANUFACTURER OR DEALER IN

Douglas Fir—Redwood—Sugar and Ponderosa Pine — Plywood and Concrete Form Panels — Sash and Doors — Millwork — Insulation — Builders' Hardware.

E. K. WOOD LUMBER CO.

"Goods of the Woods" ©
LOS ANGELES • SAN FRANCISCO • OAKLAND

BAXCO

CHROMATED ZINC CHLORIDE

GLC

PRESSURE TREATED LUMBER ● PROTECTS AGAINST DECAY AND TERMITE ATTACK

*Specify it in your home
Available through Lumber Dealers*

LOS ANGELES	SAN FRANCISCO
601 W. 5th Street	333 Montgomery Street
Phone Michigan 6294	Phone DOuglas 3883

J. H. Baxter & Co.

AGENTS FOR WEST COAST WOOD PRESERVING CO., SEATTLE WASH

CORROSIRON

U. S. REGISTERED TRADE MARK

an acid resisting alloy for
**Pumps • Valves • Chemical
Coatings • Drain Pipe & Fittings**

ARCHITECTS AND ENGINEERS
ENGAGED IN WAR HOUSING
AND POST-WAR PLANNING MAY
CONSULT OUR ENGINEERING
DEPARTMENT WITHOUT
OBLIGATION



PACIFIC FOUNDRY COMPANY LTD.
Engineers and Metallurgists

3100 - 19th Street
SAN FRANCISCO

NEW YORK SAN FRANCISCO LOS ANGELES

WHAT HE CAN'T SEE MAY HURT HIM

Fall school opening is a critical time for your child's eyes. It marks the beginning of a long period of close application to severe seeing tasks. Your child's eyes can suffer irreparable damage in these next months.

Days are increasingly shorter and more often over-cast — more hours when electric light is needed even for ordinary activities. For reading and studying, abundant, good quality artificial light is a necessity that cannot be overlooked without serious consequences.

School authorities recognize this need for good light and provide suitable light for every child. But they have no jurisdiction over a child's home environment. Home study is required of every child and unless parents provide proper study conditions at home, the child is under a severe handicap that is bound to reflect in his grades and in the well-being of his eyes.

Check your child's study desk now. See that the lamp has the right size inside frosted bulb—100 to 500 watts is the average for study lamps. Check the shade—it should be wide at the bottom, open at the top, and white-lined. See that no glare is present at the child's eye level.

For more detailed information about modern lighting, send for the free booklet offered below.

NORTHERN CALIFORNIA ELECTRICAL BUREAU

Electricity is vital to war production. Even though it is not rationed, use it carefully and without waste.

Northern California Electrical Bureau
1355 Market St., Dept. M-843
San Francisco, Calif.

Please send me your free booklet on Home Lighting.

Name.....

Street.....

City..... State.....

SAL-MO SUPPLY DUCT

PREFABRICATED
AND
PACKAGED

A Partially Completed Duct. Metal was Used Only for Hangers and Fittings.



A Typical Installation of Sal-Mo Supply Duct in a War Housing Project.

SAL-MO Supply Duct is the non-metallic material for constructing supply and return ducts for Warm Air Heating, Ventilating and Air Conditioning Systems. Its use permits many installations that would otherwise be impossible because of the Government rulings restricting the use of metals.

Sal-Mo Supply Duct is prefabricated and packaged in cartons at the factory. It is quickly installed saving many hours in erecting time. It also reduces shipping, trucking and storing costs to a minimum.

Ducts constructed of Sal-Mo Supply Duct are tight, quiet, and insulated. Low conductivity rate assures efficient operation in both heating and cooling systems. Smooth interior surfaces give low friction loss. Air tight construction prevents heat loss.

APPROVED AND LISTED by Underwriters Laboratories, Inc.

Sal-Mo Supply Duct is tested for Fire Hazard Classification: Inflammability; Fire Retardant Classification; Fire Spread; Moisture Absorption. Available in 26 sizes for domestic and industrial installation, and in flat sheets.

*Sall Mountain Company also manufactures
Asbestos Paper, Millboard, Pipe Joint Tape, Pipe
Coverings and many other Insulation Materials*

SALL MOUNTAIN COMPANY

176 W. Adams St. Dept. A Chicago

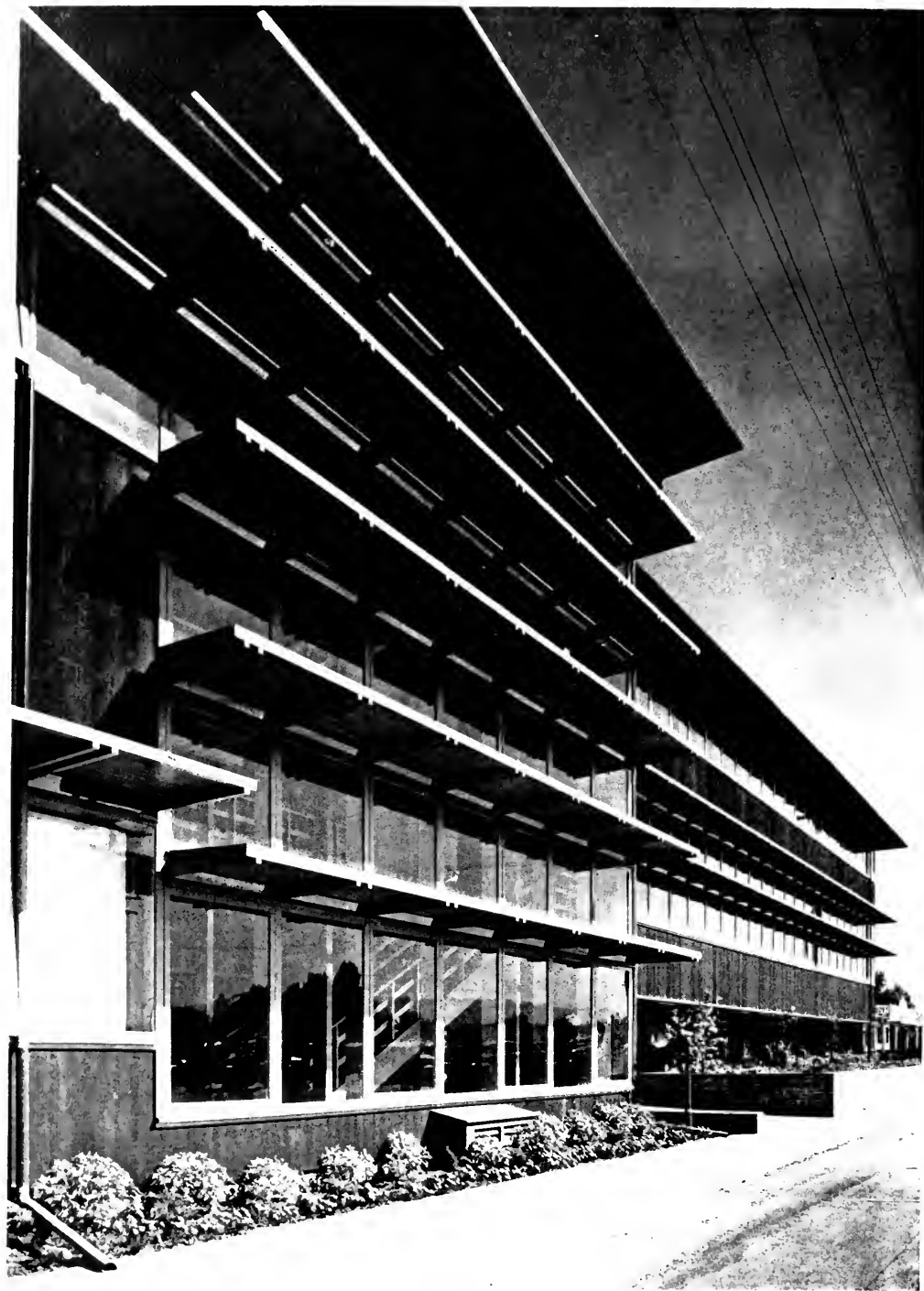

OFFICE BUILDING FOR THE SHUCKL CANNING COMPANY, SUNNYVALE, CALIFORNIA
William W. Wurster, Architect



WEST SIDE OF BUILDING. NOTE LONG CORAL COLORED AWNINGS

OFFICE BUILDING FOR THE SCHUCKL CANNING CO.

William W. Wurster has realized an ambition. He has had his work illustrated in detail in an architectural magazine of national circulation. The July Forum, in its new condensed form, with thinner paper and narrow marginal space, devotes 21 pages to Wurster designed buildings, including several projects shown in recent issues of *Architect and Engineer*. When a magazine like the Forum will publish some 40 or more pictures of a San Francisco architect's work there must be a good reason. And that reason, we assume, is that his work has merit.

Modestly, Wurster passes on much of the credit for his success to his associates, a staff of capable young men, numbering 40, who have worked with him at one time or another since 1938. Ten of the forty are today in the armed service. Wurster, himself, taking advantage of the lull in architecture, is engaged in post-graduate work at Harvard. Only three of his original staff are practicing in his San Francisco office. The others are scattered hither and yon.

One of Wurster's recent buildings which the Forum illustrates and which *Architect and Engineer* also pictures this month by courtesy of the owner, who supplied the photographs, is the office building at Sunnyvale of the Schuckl Canning Company. Completed in recent months, the building has attracted attention because of its departure from the more or less stereotyped style and arrangement of similar type structures. The building is constructed largely of redwood with all floors of the mill construction type, furred below for heating ducts and above for electric conduits.

The architecture is contemporary, the plan functional, with offices for local operation on



**MAIN STAIRWAY WHICH CONSTITUTES THE SOLE DECORATIVE FEATURE
OF THE INTERIOR**

The stairs have oak treads and Douglas fir stringers.



Steel columns and beams support this parking area at street level of main building. Company executives use space for parking, convenient in inclement weather.

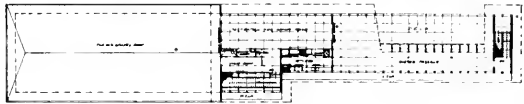

the first floor, executive work shifted from San Francisco, placed on the second floor, cafeteria, kitchen and women's rest room on the third floor.

Part of the building is completely open at the street level, this space being used by the company executives for parking. Steel columns and beams are used in this area.

Unusually wide wood awnings painted a coral color protect working space from the sun while the general color scheme of the exterior surfaces is a dark brown. The redwood interior boarding is treated with a lacquer finish, keeping the wood to its natural color. Acoustic tile ceilings provide insulation against noise. Fluorescent lighting is used throughout.

The ultimate plan provides for a cafeteria unit for the cannery workers near-by and a nursery school for their children.

Thomas D. Church was the landscape architect, A. V. Saph, Jr., structural engineer and Aladdin Heating Corp. heating engineers.

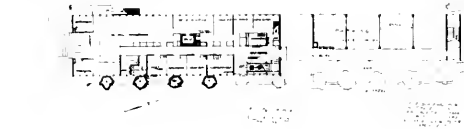
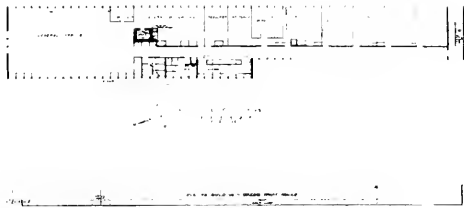

DISPENSARY PLAN

PLANS



ABOVE—OFFICE SECTION. BELOW—PORCH CAFETERIA





ABOVE—RECREATION. BELOW—SUN-DECK

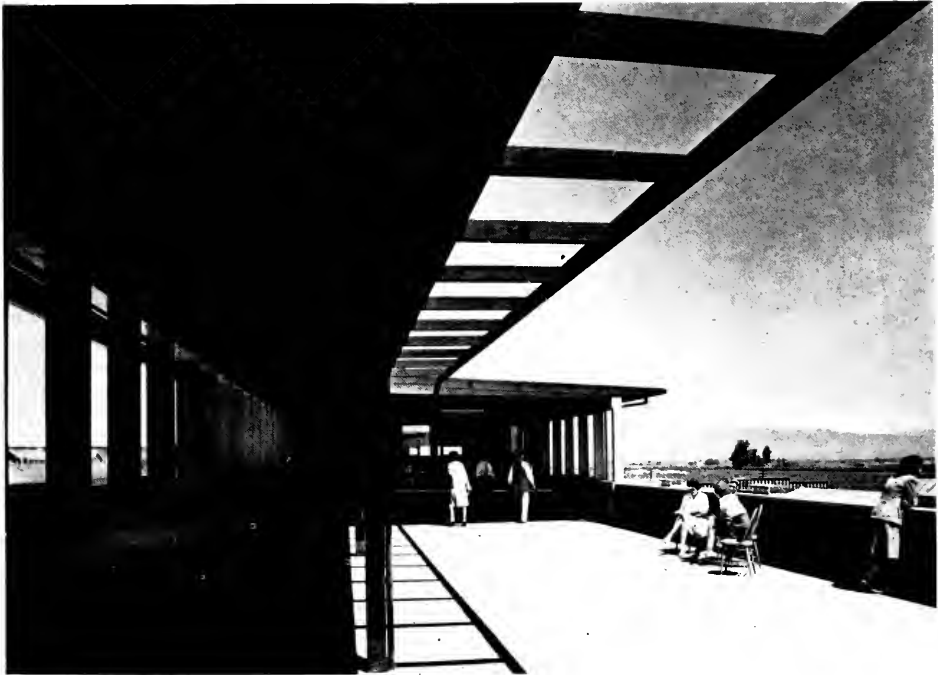



CITY HALL, BURBANK, CALIFORNIA

William Allen and W. George Lutzi, Architects

Illustrations courtesy Southwest Builder and Contractor.

BURBANK CITY HALL



Detail of fountain in front of main entrance.

Planned to meet future as well as immediate needs in one of Southern California's liveliest war workers communities, the City of Burbank has moved into its new home—technically known as the City Hall—culminating five years of diligent planning. Starting as a W.P.A. project, construction was completed by the city with its own funds when the Works Progress Administration was terminated by President Roosevelt.

The new building stands on the site of a former school house just above San Fernando Road, principal traffic artery through the city. Of modern design, functional in its treatment, the reinforced concrete structure is dominated by a central tower, equivalent to three and one-half stories, and flanked on each side by two and one story wings. From

the front entrance to the roof of the tower a vertical panel with recessed cast concrete grill gives the exterior a decorative note and at the same time provides light and impressiveness to the main lobby and grand stair hall.

All exterior surfaces are plain cement except the sculptured panels over the front windows of the two one-story wings. Vertical lines are accentuated in the treatment of the window openings with horizontal lines in the walls of the high basement. The set-back top of the tower has a low pitched roof covered with glazed shingle tiles.

Decorative features of the interior include mural paintings by Hugo Ballin, all allegorical presentations of historical events, political, social and economic progress.

An emergency hospital with operating room and wards for men and women, city jail, garage and Civilian Defense Center are in the basement while the first floor houses the police headquarters, municipal court room and offices of the city clerk, city treasurer, building inspector and superintendent of streets. Most of these offices are finished in paneled oak, except the court room which has walnut panelling and asphalt tile floor.

The entrance lobby has a marble floor and wainscot, lucite glass ornaments and bronze rail and indirect lighting. Corridors on the



Upper right—Burbank City Hall. Grand stairway showing mural painting by Hugo Ballin above landing.

Right—Main lobby, looking toward entrance and showing cast concrete grill inset with glass, which contributes both light and beauty to the grand stair hall.



Council Chamber with wood paneled walls and symbolical mural aver rastrum.

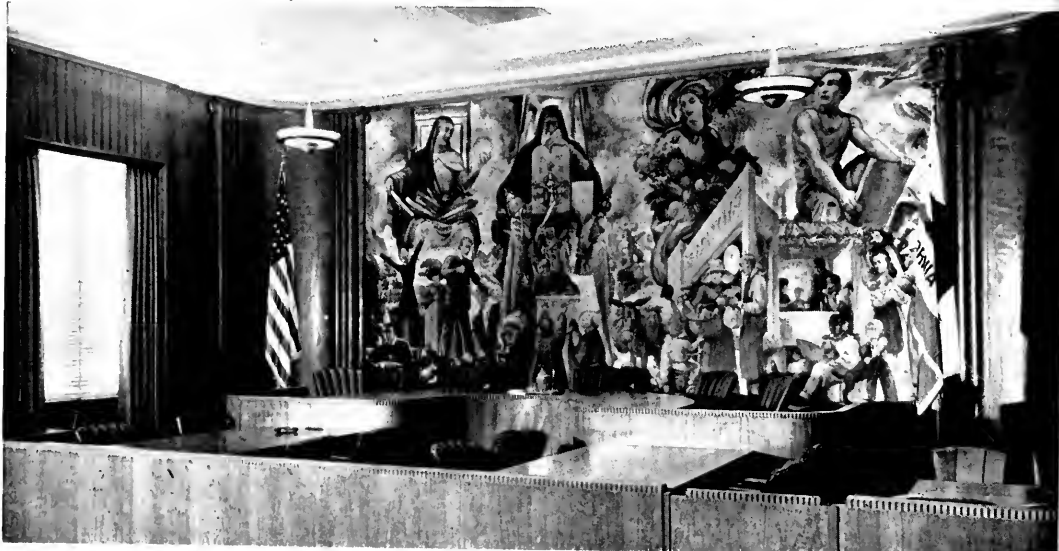

Detail of mural in Council Chamber—"The Four Freedoms,"
by Hugo Ballin.



first floor also have marble floors and wainscot. Tennessee marble is used for the floors and Montana rose travertine wainscot. Ceilings throughout on the first and second floors are acoustic plaster.

On the second floor are the council chamber and administrative offices. The former has teakwood panelling and built-in rails and tables. Subject of the large mural painting in the chamber is "The Four Freedoms." The council conference rooms have walnut panelling and asphalt tile floors.

The mayor's office has walnut panelled walls and carpeted floor while the office of the city manager has teakwood panelled walls and carpeted floor. The rooms have indirect lighting.

All lavatories, both private and public, have full tiled walls and floors.

Heating and refrigerating equipment is housed in the tower.

The structural design of the building is standard concrete. Due to an alluvial soil deposit on the site the foundation problem was thoroughly explored and to provide adequate support it was decided to drive bearing piles for all walls and piers. A total of 256 piles were driven, ranging from 18-foot to 30-foot penetration.

William Allen and W. George Lutz of Los Angeles were the architects.

Cost of the building, including furniture, was \$409,000.

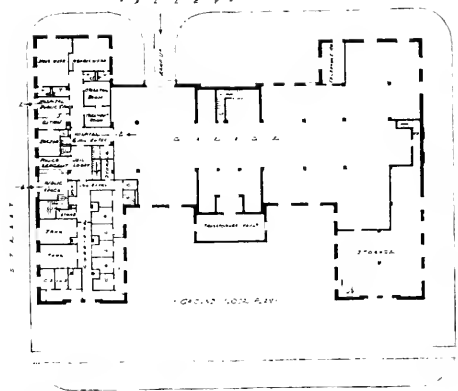
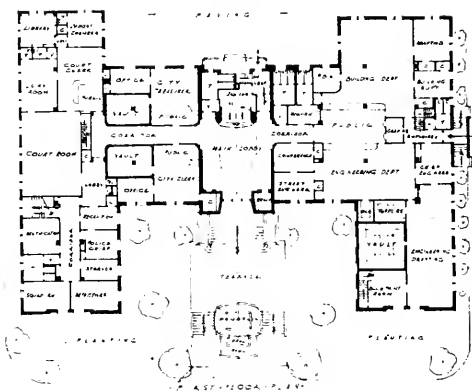
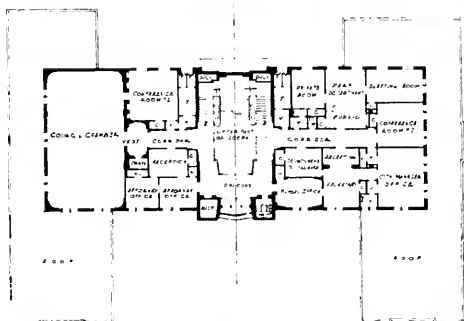



MAYOR'S OFFICE WITH TEAKWOOD PANELLED WALLS



COURTROOM WITH WALNUT PANELLED WALLS AND MURAL OVER JUDGE'S BENCH. FLOOR IS ASPHALT TILE.



RECEPTION ROOM, TEAKWOOD PANELLING, LINOLEUM FLOOR COVERING



OFFICE OF CITY MANAGER. HERE AGAIN THE INTERIOR FINISH IS TEAKWOOD

PLANNED HOUSING

by GEORGE PAMPEL*

WHEN WE Americans are done with this war we are going to have some new concepts about our lives.

How we live, what we should get out of life, our ambitions, our standards . . . all these will have had some serious appraisal during the terrific stresses of war. Torrid days in fox-holes, nights on freezing patrols, hours and even months in camp or hospital, and reflection about lost buddies, are causing much fundamental thinking among our young men at war. This same thinking is also going on among the folks at home, whose hopes and fears rest with these service men.

OLD IDEAS
MUST GO
INTO THE
DISCARD

It is inevitable, therefore, that some old ideas, some old prejudices and habits which have had nothing to recommend them but their age, are going to be rejected . . . despite the rather ridiculous special-interest advertisements that have some soldiers imploring us now, "don't change a thing."

Every intelligent person knows there is going to be change, that there is going to be progress in the post-war world, much, if not all of it both approved and initiated by the men now at the battlefronts.

For instance, among many other things, Americans are going to go after something better to live in. Shelter is not enough. Americans want a place to **live**, not a place in which to be "housed."

NO
HAPHAZARD
PLANNING
SAY EXPERTS

This desire presents planners—technological, social, political, and economic—with tremendous opportunities, responsibilities, and challenges.

Whether America gets what it desires depends solely on how well the planners plan, how well they co-ordinate their work and primarily, of course, whether they are going to get the opportunity of planning. For we aren't going to solve the fundamental problems of providing America with the satisfactory living accommodations that it is possible to achieve merely by accident, or through a free-for-all melee of conflicting interests.

First of all, I believe that we will have to reject the idea of a proprietary interest in housing by any special factors. The housing of 130 million Americans is not the private domain of 23,000 building material dealers or 120,000 contractors . . . or the building material manufacturers, the financing houses, the real estate men, or even the architect and engineer professionals. Because it is **the people's** problem, to be solved in behalf of the people, first and foremost.

WASTEFUL
COMPETITION
SHOULD BE
AVOIDED

Second, and it is a corollary of the first, the best results are not going to be obtained by a chaos of embittered, expensive, wasteful competition involving these factors and sub-divisions thereof . . . where, theoretically, "the best man wins," but where the public inevitably loses.

Required is an overall strategy, the basic concept of which is true service to the millions to be housed, a strategy that can realize the dreams and the needs of the people, and which can integrate the contributions of all parties and reward them in just measure for their work. It is a big job, the biggest single post-war job America will have. It calls for the same kind of courage,

* Advertising Manager, I. F. Loucks, Inc.

OR THE FUTURE

patriotism, unity and devotion to an ideal of which we have shown ourselves capable in girding for war. Certainly this peacetime undertaking to provide man security, serenity, dignity, peace and comfort is just as worthy of our best talents and best thinking as our service to war. Indeed it is civilization's natural complement to war; total housing should follow total war. In terms of cost, the money spent by our country to date to rid the world of fascist oppressors would provide a brand new \$5000.00 home for every family in America!

Does this requirement of overall strategy presuppose governmental control of the activity?

No, it needn't . . . although I don't feel that we people should allow propagandists to render us panic-stricken with the thought of our government . . . which would be, after all, only ourselves acting together in our own behalf in a tremendous undertaking.

But there are other facilities, local and community boards and housing authorities, which can serve as a coalition factor. If such is the will of the people . . . only when private agencies find themselves unable to solve this problem alone need government facilities be made use of, and then only to the extent of co-ordinating the factors in the building field, setting standards, and perhaps in giving the necessary backbone to the financing.

Private enterprise . . . the manufacturers, the distributing structure, the contractor firms . . . all, under controls of the people whom they are serving primarily, would have the opportunity to prosper under such circumstances, much as they have done in building ships, tanks, planes and armament for us all today. Only if they do not take the opportunity would other methods of doing the job have to be found.

This presentation here is not another plan for a post-war housing set-up; the only point I have attempted to establish is that the people's housing needs must be regarded as paramount, that they can not be considered a by-product of the scramble by individuals or individual factors for the post-war housing market, no matter what these factors or their spokesmen say. No group has a mortgage on the future housing requirements of America.

What kind of housing would "planned housing" be?

Perhaps many envision row upon row of barracks-like structures, oppressively uniform and uninviting . . . or minimum housing such as the government was forced to build for war workers in the face of material shortages . . . or some of the sorry results of blitz-induced speed, or necessarily unfavorable location, or simply bad planning. That this kind of housing is necessarily and always planned (or government) housing is an idea that has been promoted and carefully nurtured by those who feel that they themselves would get more of the market if "planning" were left out and they were allowed a free hand.

**TOTAL
HOUSING
SHOULD
FOLLOW
TOTAL WAR**

**LIMITATIONS
ON
GOVERN-
MENT AID**

**"PLANNED
HOUSING"—
WHAT WILL
IT BE?"**



Because every step in the building and erection of this home was planned to the nth degree before a piece of lumber was cut, it goes up as easily as a house of cards. This is one of the houses in a 1000-unit project at Bremerton, Wash., which has been prefabricated in the factory, transported by truck to site, where it is easily erected by workmen in a few hours' time.



Modern methods of home construction are the result of planning by architects to facilitate erection and to make a better-built and more livable home for post-war living. Here the wall sections in a flat-bed jig are receiving glue applied by workman from a glue gun. Construction with glue not only makes stronger walls, but saves tons of nails which would ordinarily be used.



This is more evidence of planning on the technological front, to expedite delivery of houses to the consumer, as well as keep down costs of post-war homes. The model prefabrication plant shown here is so arranged that entire houses may be prefabricated at one time. In the foreground wall frames are being nailed together in the first step after the proper lengths have been cut. Wall is then glued to studding, progresses to delivery end of the plant where a complete building—roof, ceiling, wall and floor sections are loaded onto a single truck, transported to site to be erected.

Architects today, for one group, know differently. And while they have not approved in every respect all of our country's planned housing projects, they have themselves seen to it that much fine coordinated, intelligent, useful work has been done. They literally have proved again on a large scale the value of planning. The professional's service is based on planning, after all, rather than improvisation or rule-of-thumb, or anarchy.

It doesn't take much of a prophet to say that the post-war house, technologically, is going to be a considerable step ahead of our so-called "modern" house today.

The planners of the research laboratory have been storing up many pleasant surprises for the post-war building market.

MANY NEW AMAZING PRODUCTS

Electronics promise many new things for the easier, safer, more efficient operation of the coming homes. Architects will be given many new amazing products—plastics, plywood, new glasses, new metals and alloys, better paints, preservatives—with which they will be able to achieve better design, easier maintenance, greater comfort and lower costs in the house of the future. New principles of air conditioning and heating, new techniques of building, including prefabrication, offer immense possibilities for better and more economical living. Entirely new concepts of what a home should be: bringing in the outdoors, houses of adaptability to changing requirements in a family from hour to hour or year to year, suburban living with better transportation opportunities—all of these challenge the imagination of every architect, as they have already stirred up the dreams of Americans working for the end of the war.

The selection and the integration of the materials and the techniques of the post-war period will be the responsibility of the architect.

Additionally, he will be called upon to build into the whole housing scheme a community atmosphere, for while much of the new building will be individual houses, a far greater and increasing amount of the new building will be done in large scale projects, a study of housing tendencies reveals. This means the plan-

ning of facilities other than the home unit: recreation centers, shops, schools, gymnasiums, hospitals, libraries, etc. It means also the proper layout of traffic controls.

This brings up the problem of the availability of new housing. Who is going to get the new houses? We are solving in the laboratories and in the architects' offices the technological problems of post-war housing. The "distribution" of these houses is another, and perhaps more difficult problem: an economic problem.

An unprecedented capacity for producing building materials, a backlog of savings, and the accumulated obsolescence of war years, along with the tremendous purchasing power in the hands of the people (presuming that we will not suffer or permit ourselves to suffer a complete economic collapse after the war's end) gives indication of a building market as great, if not greater than any year since the all-time peak of 1928. Various estimates average between 1,000,000 and 1,600,000 houses each year for ten years. It is expected that 75% of these will necessarily fall in the "under \$5000" class.

It is in this regard that the economic and social planners will have to help.

HOUSING NOT A PUBLIC WORKS PROJECT

Housing should not be looked upon as a public works project concerned only with relief measures, taking up slacks in post-war unemployment, or merely as a continuation of a program of economic rehabilitation. Housing for all classes of people should be on the agenda.

The temporary housing of the war period, said to be overhanging the market, should not be considered a serious factor. Plans of the government include the complete demolition of these duration type housing projects. The materials will be salvaged but will not seriously affect the new building market as they will, no doubt, be used in rural areas or in rehabilitation of destroyed areas abroad. This naturally calls for controls from the top so that the public interest is protected in all instances.

The proper utilization of all building factors, the proper acceptance of the new

materials and techniques will be a special obligation of the manufacturer and the advertiser. A tremendous job of bringing the information properly to the attention of the post-war home owner and to the architect is going to be required. The fact that everybody would be working within the perimeter of a plan does not set any arbitrary limits on these legitimate functions of the progressive manufacturer. In fact, it enlarges his opportunities and makes his future more secure, it would seem.

In all events, I think the necessity for overall planning is well recognized by responsible parties looking to the future building market. However, unless those who believe in and understand the importance of planning, insist on it, and demand it, they will be inundated soon by those who are already, before war's end, out to fasten their special interests on the post-war market.

Architects who are planners by profession can well take the lead in seeing that planning is to be done, and thereby serve not only the nation but themselves.

POST-WAR HOUSING—THREE WAVES

Everybody writes on post-war housing. Now comes Richard E. Saunders in *Nation's Business* for July telling us how this building urge will come by waves.

First wave will come in the higher price field. People will be content with a 1939 model plus refinements the building industry has contrived in the intervening years. Volume will be something like 1,000,000 houses.

Second wave, for demobilized servicemen, will consist almost entirely of newly formed families. The second wave will not reach its crest until several years after the war. Statisticians are stumped as to number of houses required. He thinks the demand will fall short of 1,000,000 units. "The packaged house—the new product prefabricators are getting ready to put on the market—may be particularly attractive to him. He won't be in a hurry."

Third wave, home of the future. The building industry must develop a product that it can merchandise in competition with new automobiles. This means shooting toward lower costs as well as innovations in design.

Glass wool will be much more widely used for insulation. It is constantly being made lighter and is now available in a form weighing only a half-pound per cubic foot. A four-inch layer of glass wool has the heat insulating value of a fourteen-foot concrete wall, it is claimed.

The U. S. Army has let a contract for a new type portable shelter completely transportable by air. Exterior surface is of impregnated cotton fabric on laminated wood frame. Cross section is a parabolic arch 8½ feet high, 16 feet wide. Erected in multiples of 8 feet, the only metal used is the hardware.—*Monthly Bulletin, Illinois Society of Architects.*

THE 57 LAMPS OF ARCHITECTURE

By John L. Skinner

When I decided to build me a house
I felt just a little afraid
That plan and design
Were not quite in my line
So I sought architectural aid.
And I said, "Give me, pray,
Something quite *récherché*
For I am tired of hanging my hat
In an early Victorian, pre-Montessorian
Old two-by-fourian flat."

The Architect puffed on his period pipe
As he sat in his Renaissance chair,
And he gave me a smile in the pure Gothic style
Though he spoke with a Romanesque air.
Said he, "If your taste is not wholly debased
The best you are certain to find
Is the early Colonial,
Nearly Baronial,
George Washingtonian kind."

I thanked him politely and paid him his fee
But friends and acquaintances cried,
"That stuff you should shun,
It hasn't been done
Since Benjamin Harrison died."
And they sent me direct to a new Architect
Who argued with logic compelling
For a Gropius-Raus mit'em
Let's go Bauhaus wit'em
Hud-nuts to you and them-dwelling.
My downfall had started,
I groped in a maze of traces, transitions and trends,
As I labored anew over prints that were blue
With the aid of my numerous friends.
But I don't knit my brow
Over building plans now
For all my money is spent
And my home's an Arcadian,
Second Crusadian,
G. I. first aidian tent.

POST-WAR AVIATION

by A. C. BALLASEYUS

At a recent meeting of the Structural Engineers Association of Northern California, some interesting opinions were voiced concerning present and future developments in modern aircraft and their effect upon the structural engineer.

One of the speakers was Albert C. Ballaseyus, Supervising Research Engineer, National Defense Research Committee Project, University of California. Readers will find some enlightening facts in Mr. Ballaseyus' discussion of significant developments taking place in aircraft manufacture.

Also contributing to the general topic of the meeting was Howard D. Eberhart, Associate Professor of Civil Engineering at the University of California, who spoke on "Structural Problems of Aircraft Design."

It is the opinion of some engineers that the structural design of the modern airplane may have an important bearing upon the engineering conception of the skyscraper of tomorrow.

The subject of "Post-War Aviation" is one that must be approached with circumspection, for notwithstanding the frequently astounding predictions made by various experts as to the shape of things to come, it is impossible to trace its expected step-by-step development. The pattern will be conditioned by many circumstances not now discernible.

The length of time necessary to make the cargo-carrying airplane an important competitor to the other forms of transportation would seem to be as dependent upon politics, economics and sound business promotion as it is upon technical advances. Granting that we are upon the threshold of a large expansion of the air transport of passengers and other valuable cargo, the utilization of the freight-carrying airplane upon a large scale is primarily dependent upon the rate structure set-up, the provision of airports and service facilities, and the availability or not of subsidies. Similarly, the technical problems of the light privately owned airplane may be said to have been solved by the helicopter; but it is probable that the real mass production and use of such a vehicle will develop concurrently with a shift of population away from the large cities.

There are some factors, however, which can be discussed in a reasonably sound man-



A. C. BALLASEYUS

ner. The war itself will have a great effect upon post-war aviation in many respects. Two of these effects which are often discussed are the anticipated presence of many thousands of bombers and transports, available for civilian use after the war; and the technical advances in aircraft design and production brought on by the pressure of war.

It may be thought that the availability of large numbers of military aircraft which can be used for or converted into cargo-carriers presents attractive possibilities. Converted military transports will have possibilities, providing that obsolescence has not made their operating cost too high. The low cost at which these aircraft may be available may not be very important from the standpoint of their economic use, for it has been shown that with airplanes of the present design ton-mile costs are much more dependent upon operating than initial costs. This matter of economic operating costs will rule out the converted bomber for use on an efficiently operated air-transport line. Any efficient airplane must be designed for the job it has to do. The bomber airplane is designed for a very specialized cargo-carrying function—that of hauling highly concentrated load over long distances at high speed. The percentage of commer-

cial express or freight that could be economically carried by a machine so expensive to operate is minute; furthermore, a more efficient machine for cargo transport can be designed, as the structural requirements for the military airplane are considerably more severe, and therefore the structural weight is higher than for a comparable civil machine. It is to be hoped that the availability of these aircraft at the end of the war will not subject the air transport operators to the type of wild-cat competition that afflicted the trucking industry some years ago.

THE PLANE AS A UTILITARIAN VEHICLE

Before considering the effect of technical advances brought on by the war upon the possible increased commercial utility of the airplane, it will be well to consider the present status of the airplane as a utilitarian vehicle. The airplane suffers when compared with the train, truck or steamship as a load carrier; where steamship freight charges are as low as one-half cent per ton-mile, and where l.c.l. railroad freight charges average about four cents per ton-mile, no competent authority has yet claimed air-freight charges of less than fifteen to twenty-five cents per ton-mile as a possibility. That possible costs for air-freight do not show a greater spread as compared to competitive services is a tribute to the design genius of the aircraft engineer, for fundarier. The efficiency of a carrier may be expressed by its lift/drag ratio, or the ratio of its weight to the force required to move it. On this basis alone, and disregarding the effect of speed, which is of secondary importance for most freight carriage, the lift/drag ratio of an efficient airplane may be 20/1; that of the railway train 100/1, and that of the steamship 500/1. Therefore, with the present principles, the airplane can be considered for use as a commercial transport vehicle when cost is of no apparent consequence, as in war; or where the capital cost of other transport agencies would be excessive, as in large parts of South America; or for the carriage of goods and people where time is of value.

The aircraft designers and operators can

be expected to battle aggressively for a larger share of the express and freight transport business. It is to be expected that the operators will be able to gradually reduce their costs through the use of more efficient airplanes and more scientific operating methods.

Of the various possibilities that present themselves for the reduction of transport airplane ton-mile operating costs, it is doubtful that any reduction in cost can be obtained through a reduction of initial or aircraft sales prices. Although it may be assumed that the great productive capacity available after the war will allow aircraft to be manufactured at considerably lower prices than were possible before the war, such an assumption is illusory, for the cost of the commercial transport was about \$10 per pound before the war, and the cost of the present military airplanes is of the same order. Due to the exigencies of design changes, the industry even now cannot be on a mass production basis, and it certainly cannot be so when the demand will be less. One month's production of the present aircraft industry can supply airplanes enough to take care of many times any possible demand for commercial transports. In any case, by present standards, initial cost will be a secondary consideration. Almost any initial price can be paid if flight efficiency is obtained, for particularly at long ranges the influence of the amount of fuel required upon useful load is of prime importance. Various estimates have been made as to the importance to the operator of reduction in fuel weight or airplane weight required for a given flight distance; these estimates range from \$250 to \$2000 per pound increase in revenue for the life of the airplane, for each pound saved.

The possibilities of size, as such, seems to have a fascination for some who predict on matters aeronautical; possibly on the basis of the exploded theory that the bigger must be better. Present opinion indicates that there are no insuperable difficulties standing in the way of the building of so-called giant airplanes, if some agency will finance them. That any appreciable reduction in ton-mile

operating cost can be gained by increasing size, however, has yet to be proven.

Other avenues which may lead to an increase in the load-carrying ability or decreased operating cost of the airplane are being constantly explored, for aeronautical war research has a direct bearing upon the future civil airplane. Among these studies relating to engineering improvement are those concerning materials, aerodynamics, structures and power plants.

WAR DEMANDS DEVELOP NEW MATERIALS

The necessities of war and substitution have had a healthy effect upon the American aircraft designer and structural engineer, as it has again been proven that materials other than the strong aluminum alloys can be successfully used in airplanes. The presently available materials—strong aluminum and magnesium alloys, the various steels, and plastic bonded plywoods, can all be used satisfactorily for most purposes. No one of these materials has any great advantage over the others technically. The present limiting factor in aircraft structural design is usually not tensile or compressive strength, but resistance to buckling and local instability, which are functions of the modulus of elasticity of the material. In this respect aircraft structural design presents different problems from those to which most structural engineers are accustomed. These problems have been well covered in a paper on aircraft materials and testing by Mr. L. B. Tuckerman of the Bureau of Standards which was published in the A.S.T.M. Proceedings for 1935. His conclusions are still correct, and indicate that any appreciable decrease in aircraft structural weight, with corresponding increase in useful load, is dependent upon the availability of materials having higher modulus/density ratios than any now available. So, the prospect of decreasing ton-mile costs through decrease of airplane structural weight is considerably dependent upon future metallurgical, materials and structural research, although a shift in interest from high perform-

ance to useful load ratio should have beneficial results.

A consideration of the lift/drag ratio previously mentioned shows that an improvement in this ratio can be obtained by decreasing drag for a given lift, and this is the direction in which most aerodynamic research has been pointed. The reduction of drag, however, is in the same category as the present efforts to improve the efficiency of the aircraft gasoline engine; in either case painstaking work is required to gain a small percentage improvement. A large gain in efficiency of aircraft as load carriers waits upon new principles of flight or propulsion, and as to these, the possibilities are interesting, but probability of realization remote.

These remarks with regard to greater commercial utilization of the airplane may seem to be pessimistic, but are not meant to be so except as may be necessary to deflate some of the glamour with which this subject has been surrounded. It is reiterated that the utilization of the commercial airplane involves complex political and economic factors as well as those of an engineering nature, and it is upon these first two factors that government agencies, the operators and manufacturers could well spend intensive effort. The common citizen should not be misled into believing that great numbers of transport aircraft can be economically self-supporting in the near future, and he should be informed that the building up of the great airways systems necessary for this country's post-war leadership will continue to be a matter of public support

"FROM PYRAMIDS TO PENTHOUSE"— INSTRUCTIVE COURSE AT LEGION PALACE

The California Palace of the Legion of Honor announces a new course, "From Pyramids to Penthouse," every Wednesday from 10:30 a.m. until 12 noon for 11 consecutive weeks. Admission is free.

The first half hour of the course is given by Dr. Jermayne MacAgy, who will trace architecture from the early Egyptian times to the present day. The next hour is devoted to the history of furniture design, from ancient times to the present, conducted by Miss Elizabeth Wisner. The lectures will be illustrated with slides. To anyone interested in furniture from the point of interior decoration as well as to the scholar, these lectures will furnish valuable background information.

The opinions expressed herein are the writer's own, but acknowledgment is made for use of some of the technical data contained in the published work of Messrs. W. W. Davies, R. D. Kelly, W. C. Mentzer and Hal E. Nourse of United Air Lines Transport Corporation, and Mr. Carlos Wood of the Douglas Aircraft Company.

WILL THE ENGINEER REPLACE THE ARCHITECT?

Editorial in the *Federal Architect*

This period is a low ebb for architecture. Architecture has gone into a sleeping-beauty coma. Its fair face is there; its lovely form is there. But if it breathes it is not apparent. If its heart beats, it is a still throb.

The long arm of the War Production Board has withheld priorities for civilian construction, justly, in view of the emergency. The same long arm has restricted materials for government construction.

And so that great responsibility of the profession, the providing of beautiful forms from gracious materials, is for the time inoperative. The other great responsibility of the profession, the efficient and effective planning and arrangement of buildings and groups of buildings is reduced in volume, existing only in government work.

There now comes the question, how can the profession recover? It cannot recover without inspired personnel. It is an inspirational profession, depending for progress upon continuing manifestations of genius.

Can those architectural geniuses who have gone into the armed forces, who have joined the ranks of civilian Federal employees, who have devoted their talents to private endeavors unconnected with architecture—can they return after the emergency, don the East Windsor tie, the Michael Angelian halo, the purple smock and at once awake the sleeping beauty?

Or will the engineer be there first? Will the public listen to the engineer's testimony that the architect is no longer a planner but just a beauty-doctor, a knitter of a pretty shirt to cover inspired engineering structures?

There has been the public talk of recent months that engineering has increased in responsibility, what with new and complicated methods of structural support, with involved designs for air-conditioning, with fluorescent lights, high-speed elevators, controlled heating, telephones, dictaphones and the like. At

the same time, the talk goes on, the architecture has decreased in responsibility, following the abolition of Corinthian columns, heavily modelled ornament, highly wrought metals: following the decision to make architecture the expression of structure and mechanical arrangements.

The engineers probably feel that, if architecture is merely the expression of their art, rather than an uplifted thing which their art is to support and implement, engineers might do their own expressing.

Perhaps they might hire men skilled in architecture to be draftsmen for them. But if the major part of the building is engineering, say they, and if the major part of architecture is the expressing of engineering, then architecture as architecture has ceased to be.

The engineers are entitled to this point of view. If they do not understand that architecture is a profession that aims to create a finished product of beauty and studied utility, they have to be excused for thinking that all any project need actually be is strongly built, well-heated, efficiently lighted, carefully piped; and there is perfection.

How are architects going to knock out that idea? How are they going to set up again the precious fact that this generation and the next do not stand on the street corner, and exclaim, as they look breathlessly at a building. "What factor of safety! What wet bulb readings! What foot-candles! What thermostats! What annunciator systems!"

If it is good architecture the public's breathlessness is due to a conviction of inner beauty which they do not wish to understand. It is the conviction that they are looking at something beautiful and heart-warming.

How are architects going to convince the world again that only they can design such works of genius?

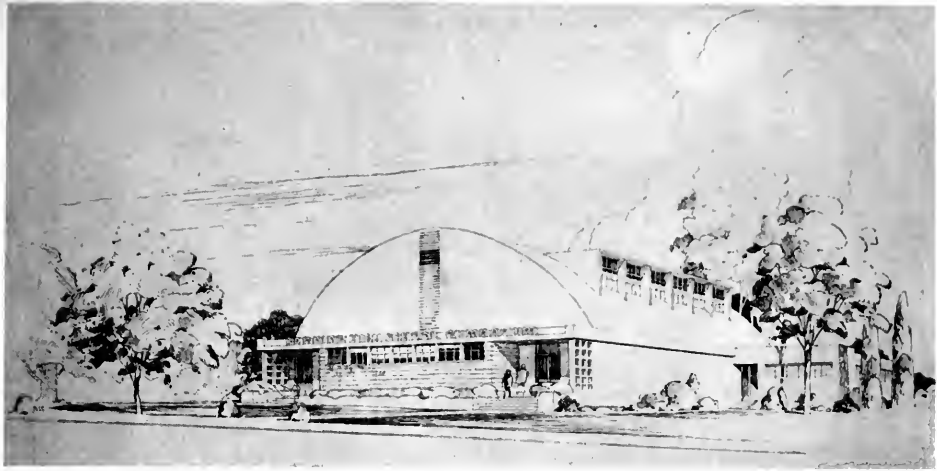

1—A POST-WAR GYMNASIUM

2—Open Type School Near Aircraft Factory

This post-war gymnasium (see cut above), now being designed in the office of Marsh, Smith & Powell, Los Angeles, will be ready for construction after the war when critical materials become available. The building will be built of reinforced concrete.

Designed with Lamella ceiling, tie rods are eliminated by the low massive concrete side-walls and by the use of underfloor ties. Protection from direct rays of the sun on the playing floor is had by means of specially designed dormers in the ceiling. The building is for the Banning High School and besides serving as a gymnasium may be appropriately used for community dances and social functions.

The Lincoln School at Redlands was completed in 1941 as a W.P.A. project, consisting of nine classrooms, kindergarten, library and administrative offices.

The high percentage of Latin Americans attending this school gave opportunity for a colorful building. Exterior stucco is a neutral gray with eaves trim a deep blue-green. The windows are a warm olive, doors a purple brown. The ceiling of the shelter is blue with circular steel columns painted a light magenta.

The tradition of an annual



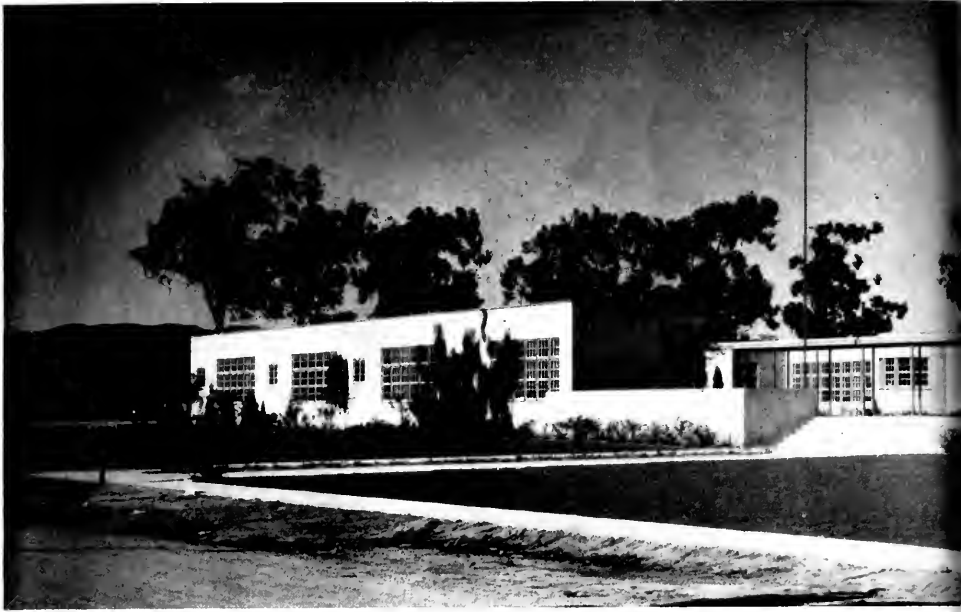

View from street. Buildings occupy an area 203 feet in depth by 419 feet in length. The set-back from street curb is approximately 80 feet.

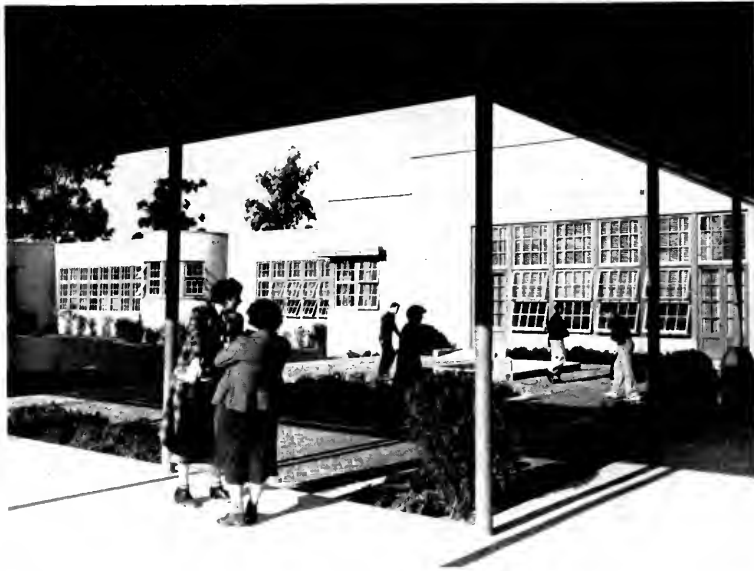

Because of its close proximity to the Douglas Aircraft factory, frequent additions to this school have been made in recent months. The building is an excellent example of the California open-type school, arranged around patios with open corridors supported on slender steel columns.



**VIEWS OF THE JOHN ADAMS JUNIOR HIGH SCHOOL
MONICA, CALIFORNIA**
SMITH & POWELL, Architects



Small reflecting pool as seen from the administration offices.



Wide open corridors and generous lawn space with tropical planting, create a cheerful atmosphere for the students attending the John Adams Junior High School, Santa Monica, California.

circus at this school, which has been carried on for many years, gave meaning to the carved stucco decoration over the kindergarten entrance. (Cut on front cover.)

The John Adams Junior High School in Santa Monica, due to the close proximity to the Douglas Aircraft factory, has been enlarged several times subsequent to its initial construction.

The original building was one of the first of the California open type school plans, arranged around patios with open corridors supported on slender steel columns and plain, simple masses for the various plan elements.

Because of simple form, an unusual and carefully studied color scheme was used on the building which is attracting considerable attention.

The building is designed around two patios, the northernmost one flanked by the administration unit at the entrance, the library, art department, mathematics, foreign language and social studies class rooms. The southern patio is surrounded by commercial department, domestic science, school cafeteria and general science wings.

Opening out from the administrative offices is a paved brick terrace arranged around decorative planning spaces and a small reflecting pool.

The overall dimensions of the building are 203 feet in depth by 419 feet in length. A generous lawn in front of the building gives it a setting, the set-back being approximately 80 feet to the main line of the structure.

ARCHITECTS' BULLETIN

Issued For

THE STATE ASSOCIATION OF CALIFORNIA ARCHITECTS

Northern Section

STATE ASSOCIATION MEMBER
OF THE
AMERICAN INSTITUTE OF ARCHITECTS

Editor
William C. Ambrose

Address all communication for publication in
this Bulletin to W. C. Ambrose, 369 Pine
Street, San Francisco, California. Office of
the Northern Section, 369 Pine Street, San
Francisco.

STATE ASSOCIATION OFFICERS

President.....Norman K. Blanchard, San Francisco
Vice-President.....Walter R. Hagedorn, Los Angeles
Secretary.....Harvey P. Clark, San Francisco
Treasurer.....David H. Horn, Fresno

Regional Director—Southern Section
Gordon B. Kaufmann

Regional Director—Northern Section
Henry H. Gutterson

Executive Board—Northern Section

President.....Norman K. Blanchard, San Francisco
Vice-President.....Russell G. de Lappe, Modesto
Secretary.....Harvey P. Clark, San Francisco
Treasurer.....David H. Horn, Fresno

Board of Directors

Chairman.....Derrick H. Reimers, Francis Ward, Malcol
Vice-Chairman.....D. Reynolds, John S. Bolles, Andrew T.
Secretary.....Hass, Henry H. Gutterson, Vincent G.
Treasurer.....Raney, Alfred C. Williams.

Northern Section Advisory Council

San Francisco District #1:
Clarence W. Mayhew, President
Elizabeth Boyter Henry Collins
Francis Chinn Edmund de Martini
Rudolph Igaz Mark Daniels
Charles W. Masten Vincent G. Raney
Noble Newsom
San Francisco Bay District #2:
Theo N. Thompson, Chairman
A. C. Williams
Loy Chamberlain
San Francisco Bay District #3:
Gwynn Officer, Berkeley
San Francisco Bay District #4:
William F. Herbert, Santa Rosa
San Francisco Bay District #5:
John S. Bolles, Ross
San Joaquin District #6:
Russell G. de Lappe, Modesto
San Joaquin District #7:
David H. Horn, Fresno
Santa Clara District #8:
Gifford E. Sobey, San Jose
San Joaquin District #9:
William F. Hempel, Palo Alto
San Joaquin District #10:
Leo J. Sharps, Burlingame
Sacramento District #11:
Herbert E. Goodpastor, Sacramento
Sacramento District #12:
Clarence C. Dakin, Redding
Sacramento District #13:
Ralph D. Taylor, Susanville
Sacramento District #14:
Thomas B. Mulvin, Del Monte
Sacramento District #15:
F. T. Georgeson, Eureka

THE SNAKE SWALLOWS ITSELF

Reminiscent of the days (1924-1929) when architects prepared nicely typed prospectus sheets on proposed apartment houses and hotels, is an article in the July issue of Harpers Magazine. Bernard B. Smith is the author, and the piece is prettied up by a little black and white sketch of Mount Vernon as a head piece.

Those able and willing to remember back before the New Deal will recall that, in the tooting twenties, the office air was full of land value, building cost, financing expense, rental-per-room, occupancy, loan value, equity, taxes, operating expense, etc., all adding up to a net return on the investment of twenty two per cent—or the set-up had to be done all over again. That was partly an aftermath of the first world war, when all was to go up and never come down. The "gravity" of the situation was not recognized.

The second world war is not yet finished as this is being written, but, though history does not repeat, some old times are being plagiarized. In his Harpers article Mr. Smith flirts around with the charms of mass production and better things for better living through plastics, but his serious attention is reserved for a scheme for housing which makes the familiar story of the cat fur farm on the remote island seem a little childish. In short, his proposal is that district organizations be formed in which all agree to build new houses under commitments to tear down said houses after twenty years. By using the tear-down formula he proves that with the addition of only eighty-two cents a month to the present F.H.A. scale of payments for a \$5,000.00 house, funds will be available at the end of the twenty years for the replacement of the \$5,000.00 house, which has been designed to just last out the twenty, and to build a spanking new house. Might we assume that the new house would be, perhaps, mass tailored to meet the mold of the man of the hour, and that the leopard could not change his spots for another twenty years?

The build-for-twenty-years idea has been expounded locally by one of our most prominent California architects, but we had not seen the financial justification before. Just how one designs a house which will last for twenty years, and thereby save twenty per cent in first cost, and which will not last thirty years is perhaps a fit subject for another article. We would like to see it. And how one saves the foundation of the outmoded house for the construction of the modern-plus-twenty-years house also intrigues us.

For the architects of twenty years practice there is a nostalgic charm to Mr. Smith's article. To the newcomers to practice it is, perhaps, an indication of the post-war pencil sharpening in store for them. At any rate, it is lots of fun. Read it. But we wonder if the Mt. Vernon picture was appropriate.

Hertzka

When last heard of, Wayne S. Hertzka, past president of the State Association of California Architects, was in North Africa in the Engineers Corps and had been advanced in rank from Captain to Major. William Knowles, his former partner in the architectural firm of Hertzka and Knowles, has been engaged in war work in the southwest section of the United States.

Masten

From the other side of the world comes news that Charles M. Masten of the firm of Masten and Hurd, Architects, of San Francisco is a Major in the Corps of Engineers and is building a railway somewhere in China. A good architect is a good man, wherever he may be.

Hurd

Colonel Lester W. Hurd was in San Francisco the first part of the month. His job as Chief of the Construction Division Chemical Warfare Service, makes the whole United States a part of his beat. Though the great era of plant construction for all kinds of war industries has passed the emergency stage, the California friends of Colonel Hurd know that where he is there is action.

Steilberg

Walter T. Steilberg, architect, was back in San Francisco recently to attend the marriage of his daughter. For the past sixteen months Mr. Steilberg has been a civilian employee of the Government doing construction work in Alaska. Much of his time was spent on Kodiak Island. In spite of the weather which makes the average stay of employees on contract work in that region only forty-five days, our hardy architect is going back for more. Pioneering is in his blood, whether it be in new forms of construction or in battling the fog and wind of the Aleutians.

DORMITORY FOR SERVICE MEN

Robert McCarthy, war housing contractor whose record of achievement was featured in the July issue of *Architect and Engineer*, and which brought forth much favorable comment, recently built in one day a dormitory for service men in the San Francisco Civic Center. The ultimate scheme calls for a total of six units to cost approximately \$6,000 a unit. Eventually there would be accommodations for 700 service men.

ENGINEERS CONSOLIDATE OFFICES

The Donald R. Warren Company announce consolidation of its two Oakland offices by moving the Eighteenth Street office to the 10th floor of the Syn-

dicate Building, 1440 Broadway, where a large force of engineers is engaged under James M. Fox on an extensive alloy steel expansion program for the Kaiser Company. The Warren Company is in full charge of the structural design of the Kaiser Company's Fontana plant.

ENGINEERS IN ARMED SERVICE

The following members of the Structural Engineers Association of Southern California are serving with the U. S. Armed Forces:

Name	Rank	Stationed
BEANFIELD, R. McC.	Major, C of E	Tucson, Arizona
BENIOFF, Ben.	Lieut.-Col., C of E	Salt Lake City, Utah
BULLOCK, Virgil W.	Major, C of E	Honolulu, T. H.
BUTZ, D. C.	Captain, C of E	Honolulu, T. H.
COMBS, T. C.	Lieut.-Col., C of E	Camp Claiborne, Louisiana
DERRICK, C. J.	Capt., AF	Kingman, Arizona
EVANS, E. A.	Brigadier-General, CA	Miami, Florida
GREENLEE, William D.	Lieut.-Col., C of E	San Francisco
IRVIN, Leslie A.	First Lieut., CA	Ft. Winfield Scott, Calif.
KADOW, R. J.	Capt., C of E	Costa Rica
SHIELD, JOHN E.	Major, C of E	Ft. Leonard Wood, Mo.
SHUGART, Donald F.	Col., AF	North Carolina
WILSON, Win E.	Major, AF	Washington, D. C.

NAVY

DeSWARTE, C. G.	Lieut.-Comdr., CEC	Williamsburg, Va.
DICKEY, Walter Linnaes	Lieut., CEC	Alameda, Calif.
GRADY, Hamilton Gamble	Lieut., CEC	Williamsburg, Va.
HERD, Charles M.	Lt.-Comdr., CEC-V (S)	Hueneme, Calif.
JOHNSON, Irving Laurence	Lt.-Comdr., CEC	Honolulu, T.H.
KING, Harold Y.	Lieut., CEC	Williamsburg, Va.
OMSTED, Harald	Lieut.-Comdr., CEC	Norfolk, Va.
SAUER, Arthur A.	Lieut.-Comdr., CEC	Seattle, Wash.
WRIGHT, William T.	Lt.-Comdr., CEC-V (S)	San Diego, Calif.

MARINES

FOX, William J.	Col., AF	Solomons
DOUGLAS, Donald	First Lieut.	Camp Elliott, Calif.

GORDON B. KAUFMANN & ASSOCIATES

Gordon B. Kaufmann, architect of Los Angeles, now serving his country as lieutenant-colonel in the Army, is keeping his Southern California office intact by a reorganization of the firm, taking in his associates as co-partners. These men are J. Harry Hall, production chief; Robert E. Backus, architect, specifications and materials; Henry L. Eggers, architect and designer and Laurence J. Waller, structural engineer, the latter a recent arrival from Washington where he was chief structural engineer of the Pentagon Building. Gordon B. Kaufmann and Associates have offices at 627 South Carondelet Street, Los Angeles.

PACIFIC PAINT & VARNISH CO.

A Paint or Varnish Product for Every Purpose

SAN FRANCISCO
Sales Office

BERKELEY
Factory

LOS ANGELES
Sales Office

PRODUCERS' COUNCIL PAGE

Northern California Chapter

The National Organization of Manufacturers of Quality Building Materials and Equipment
Affiliated with the AMERICAN INSTITUTE OF ARCHITECTS



Charles J. Nicholas

Charles J. Nicholas this year holds down the responsible job of heading up this Chapter's Fellowship Committee. This means that Nick not only takes all the blame for the all-important "Xmas Jinks," but also holds the job of passing out the introductions and gladdening the guests at our monthly get-togethers. Nick's a San Francisco native son of 1902 vin-

tage, and the number of responsibilities that he can handle at one and the same time is enough to make you gasp. Besides the job outlined above, Nick is presently Program Chairman of the American Society of Military Engineers, a member of the Trade Development Committee of the San Francisco Chamber of Commerce, Past-President of the West Portal Lions Club and ambassador-at-large from Crane Co. to northern California. Right now Nick is wrapped up in the post-war situation, with an eye to the northern California market. Nick confidently predicts a business boom after Hitler and Hirohito become past-tense, and bases his prediction on several thorough studies of the post-war problem.

And we're inclined to agree with Nick. Certainly the amazing resourcefulness exhibited by our member friends in adapting themselves to war-time conditions goes a long way toward inspiring confidence in the post-war outlook. Such members who have not only succeeded in maintaining their organizations, but have rendered valuable services under most difficult conditions, should certainly be able to take the problems of post-war re-conversion in their stride.

The above thoughts were inspired after taking in our last meeting, and giving an ear to the interesting talks by Lou Saylor of Vermont Marble and Hal Heakin of Pacific Foundry, representing International Nickel Company.

Ten Points cover the ambitious program for the year 1943-44, as announced by the Producers' Council, Inc. In essence, these plans cover continued active support to the War Program, plans to expand the Council as

a stronger central organization for the entire building-products manufacturing industry, cooperation of all branches of the construction industry, and acceleration of post-war preparations. In specific detail, here are the 10 points—

1. To continue active Washington office. To give all possible aid to war construction, war production and re-conversion.
2. To stimulate local Council Chapters to greatest usefulness during the war and in the post-war era.
3. To continue publication of the Technical Bulletin on a flexible schedule adapted to changing conditions.
4. To utilize the assistance of the Council's Advisory Board to the utmost.
5. To collaborate with the American Institute of Architects on the program outlined by the special committee, and expand relationships with other groups in the industry, such as engineers, contractors, home builders, dealers, etc.
6. To promote dimensional coordination and modular products. To encourage acceptance of proposed American Standard (ASA A62).
7. To broaden the activities of the Market Analysis Committee with respect both to present and post-war markets.
8. To accelerate the Council's post-war studies. To be prepared to propose industry programs for maximum employment and quality construction, regardless of whether the war ends quickly or is prolonged.
9. To broaden the base of the Council . . . of manufacturers and trade groups for a still stronger central organization for the manufacturing wing of the industry.
10. To take the lead in bringing about cooperation of all branches of the construction industry on common problems.

Chuck Kraft of Kraftile comes in for new responsibilities, having been appointed Liaison Officer for northern and southern California, Washington state and Denver. This good news means that western chapters are going to have a closer tie-in with the Board of Directors. Chuck has also been appointed to the Membership Committee and the Technical Cooperation Committee of the National Council.

USE QUALITY PRODUCTS



CONSULT AN ARCHITECT

Big Plans for our September meeting are on the boards of Program Chairman Bob Telfer's program-design shop. This meeting will lay emphasis on the Council's No. 1 project for '43-'44—"Push Post-War Planning." A meeting on this topic, besides being timely, holds plenty of promise of worthwhile developments. Because of our unique position in the building industry, the Council rightly recognizes its opportunity to coordinate its many ramifications.

Details aren't definite at this writing, but the outline looks plenty interesting. We're referring to the plan for Producers' Council members to listen to post-war thoughts of architects, engineers and others. Look for further details as to date, place and speakers in the program announcement—you'll get yours in the mail shortly.

Look Under "P" in your Auto-Dex and you'll discover these words—"Producers' Council Roster—See Last Page—Directory." Now flip the indicator to "XYZ," lift the next page—and there it is. Tell your **Architect and Engineer** friends about it—and let's not forget it ourselves.

SOUTHERN CALIFORNIA CHAPTER

The July 13th meeting of Southern California Chapter, A.I.A., was featured by an informative talk on "The Post-War Construction Program for Los Angeles County," by Gordon L. McDonough, chairman of the Board of Supervisors of Los Angeles County. The meeting was sponsored by Chairman John C. Austin's two committees, "Public Works" and "The Architect and Governmental Relations."

The following new Junior Associates were elected to membership at the business meeting which preceded the evening's highlights: Dan C. Cherrier, Gerald Henry Bense, Tom F. Merchant, Alfred John Luthi, Basil G. Pantages, Miles G. Swanson, Allan S. Hartshorn.

This month's meeting was held jointly with the Producers' Council with "Prefabrication" the main topic of discussion.

ARCHITECTS STILL MOVING AROUND

William Clement Ambrose has moved from 224 Kearny Street to 369 Pine Street, San Francisco.

Birge M. Clark changes his mailing address from Post Office Box 205, Palo Alto, to 310 University Avenue, same city.

W. D. Coates, Jr., has moved from the Rowell Building, Fresno, to 411 Mason Building, same city.

John H. Devitt from 279 Fourteenth Avenue to 2539 Clay Street, San Francisco.

Vernon DeMars from 1195½ Euclid Avenue, Berkeley, to 4533 32nd Street, North, Arlington, Va.

Charles DuBois from 1766 Neale Street, San Diego,

to 2342½ South Beverly Glen Boulevard, West Los Angeles.

John I. Easterly from Route 2, Box 41, Healdsburg, to 2419 McGee Avenue, Berkeley.

Robert Halley, Jr., from 625 Broadway, San Diego, to Spreckels Building, Suite 602, same city.

Charles H. Franklin from 1505 Francisco Street, San Francisco, to 2645 Chestnut Street, same city.

Samuel Heiman from 605 Market Street, San Francisco, to 68 Post Street, same city.

Hunt & Chalmers from 408 South Spring Street, to 816 West Fifth Street, Los Angeles.

Albert R. Hunter, Jr., from 1604 Capistrano Avenue, Berkeley, to 5809 Mendoza Avenue, Oakland.

Edgar B. Hurt from 711 Arbor Drive, San Leandro, to 841 47th Avenue, San Francisco.

John Hudspeth from 1145 Grizzly Peak Boulevard, Berkeley, to 391 Fairmount Avenue, Oakland.

John T. Jacobsen from 1414 Textile Tower, Seattle, Wash., to 719 Second Street, same city.

Oscar G. Joseph from 2606 Wilshire Boulevard, Los Angeles, to 101 South Rockingham, same city.

S. Graham Latta from 113 East Los Feliz Boulevard, Glendale, to 1824 Rosita, same city.

Marshall R. Lawson from 424 South Broadway to 205 North Alexandria, Los Angeles.

Carl C. McElvy from 3464 East Seventh Street, to 5151 Ellenwood Drive, Los Angeles.

William G. Merchant from 406 Russ Building, San Francisco, to 57 Post Street, Room 804, same city.

William Mooser from 244 Kearny Street, to 251 Kearny Street, Suite 310, San Francisco.

Harrison J. Overturf from 410 Orpheum Theater Building, Seattle, Wash., to 7350 51st, N. E., same city.

F. L. Roerhig from 1136 North Hill Avenue, Pasadena, to 339 West Palm Avenue, Menrovia.

Palmer Sabin from 3305 Wilshire Boulevard, Room 9, Los Angeles, to 1130 Shenandoah Road, Pasadena.

Monroe D. Sandell from 4645 East Talmadge Drive, San Diego, to 1545 North Las Palmas Avenue, Los Angeles.

Wilton Smith from 109th Street and Jasper Avenue, Edmonton, Alberta, Canada, to 155 Sansome Street, San Francisco.

Whitney R. Smith from 5805 Estelle, San Diego, to 1468 North Chester Street, Pasadena.

S. E. Sonnichsen from 663 Paramount Bldg., 644 Lucas Avenue, Los Angeles, to 114 West North Avenue, Baltimore, Md.

Eugene Weston, Jr., from 502 Architects' Building, Los Angeles, to 5112 Oakwood, LaCanada, Calif.

G. Stanley Wilson from Mission Inn Building, 3616 Main Street, Riverside, to 4681 Sixth Street, same city.

David H. Horn from 564 Market Street, San Francisco, to the Claremont Hotel, Berkeley.

Estimator's Guide

Giving Cost of Building Materials, Wage Scale, Etc.

Amounts given are figuring prices and are made up from average quotations furnished by material houses to San Francisco contractors. 3% Sales Tax on all materials but not labor.

All prices and wages quoted are for San Francisco and the Bay District. There may be slight fluctuation of prices in the interior and southern part of the state. Freight charge, at least, must be added in figuring country work.

Bond—1 1/2% amount of contract.
Government work 3/4%.

Brickwork—

Common, \$43 to \$45 per 1000 laid, (according to class of work).
Face, \$125 to \$150 per 1000 laid, (according to class of work).
Brick Steps, using pressed brick, \$1.50 lin. ft.
Brick Veneer on frame buildings, \$1.10 sq. ft.
Common f.o.b. cars, \$16.00 a yard. Cartage extra, \$2.50 per 1000.
Face, f.o.b. cars, \$55.00 to \$80.00 per 1000, carload lots.

Building Paper—

1 ply per 1000 ft. roll	\$3.50
2 ply per 1000 ft. roll	5.00
3 ply per 1000 ft. roll	6.25
Brownskin, Standard, 500 ft. roll	5.00
Sisal-kraft, 500 ft. roll	5.00
Sash cord com. No. 7	\$1.20 per 100 ft.
Sash cord com. No. 8	1.50 per 100 ft.
Sash cord spot No. 7	1.90 per 100 ft.
Sash cord spot No. 8	2.25 per 100 ft.
Sash weights, cast iron, \$50.00 ton.	
Nails, \$3.50 base.	
Sash weights, \$45.00 per ton.	

Concrete Aggregates—

GRAVEL (all sizes) \$1.95 per ton at bunker; delivered, \$2.50. All quotations less 10% to contractors.

	Bunker	Delivered
Top sand	\$1.90	\$2.50
Concrete rock, 1/4 to 3/4	1.90	2.45
Crushed rock, 3/4 to 1 1/2	1.90	2.50
Roofing gravel	2.25	2.80
River sand	2.25	2.70

SAND—	Bunker	Delivered
River sand	\$2.25	\$2.70
Lapis (Nos. 2 & 4)	2.85	3.15
Olympia Nos. 1 & 2	2.85	3.10
Del Monte white		84c per sack

Common cement (all brands, paper sacks) carload lots \$2.42 per bbl. f.o.b. car; delivered \$2.60.

Cash discount on carload lots, 10c a barrel, 10th Prox.

Atlas White	1 to 100 sacks, \$2.70 sack, warehouse or delivery; \$7.65 bbl. carload lots.
Calaveras White	
Medusa White	

Forms, Lebers average \$40.00 per M.
Average cost of concrete in place, exclusive of forms, 35c per cu. ft.; with forms, 60c.
4-inch concrete basement floor 12 1/2c to 14c per sq. ft.
Ret-roofing 7 1/2c
Concrete Steps \$1.25 per lin. ft.

Dampproofing and Waterproofing—

Two-coat work, 20c to 30c per yard.
Membrane waterproofing—4 layers of saturated felt, \$4.50 per square.
Hot coating work, \$2.00 per square.
Madusa Waterproofing, 15c per lb., San Francisco Warehouse.
Tricoel waterproofing.
(See representative.)

Electric Wiring—\$12.00 to \$15.00 per outlet for conduit work (including switches).
Knob and tube average \$3.00 per outlet. (Available only for priority work.)

Elevators—

Prices very according to capacity, speed and type. Consult elevator companies. Average cost of installing a slow speed automatic passenger elevator in small four story apartment building, including entrance doors, about \$6500.00.

Excavation—

Send, 60 cents; clay or shale \$1 per yard. Teams, \$12.00 per day.
Trucks, \$22 to \$27.50 per day.
Above figures are an average without water. Steam shovel work in large quantities, less; hard material, such as rock, will run considerably more.

Fire Escapes—

Ten-foot galvanized iron balcony, with stairs, \$150 installed on new buildings; \$160 on old buildings.

Floors—

Composition Floors—22c to 40c per sq. ft.
In large quantities, 18c per sq. ft. laid.
Mosaic Floors—80c per sq. ft.
Duraflex Floor—23c to 30c sq. ft.
Rubber Tile—50c to 75c per sq. ft.
Terazzo Floors—45c to 60c per sq. ft.
Terazzo Steps—\$1.60 lin. ft.

Hardwood Flooring (delivered to building)—

	1 1/2" x 4"	3/4" x 2"	3/4" x 2"
	1 & G	1 & G	So. Ed.
Clr. Qtd. Oak	\$144.00 M	\$122.00 M	\$141.00 M
Sel. Qtd. Oak	118.00 M	101.00 M	114.00 M
Clr. Fla. Oak	120.00 M	102.00 M	115.00 M
Sel. Fla. Oak	113.00 M	92.00 M	107.00 M
Clr. Maple	125.00 M	113.00 M	

Wage—Floor layers, \$12.00.
Note—Above quotations are all board measure except last column which is sq. ft.

Glass (consult with manufacturers)—

Double strength window glass, 20c per square foot.
Plate 80c per square foot (unglazed) in place, \$1.00.
Art, \$1.00 up per square foot.
Wire (for skylights), glazed, 40c per sq. foot.
Obscure glass, 30c to 50c square foot.
Glass bricks, \$2.50 per sq. ft. in place.
Note—if not stipulated add extra for setting.

Heating—

Average, \$1.9C per sq. ft. of radiation, according to conditions.
Worm air (gravity) average \$48 per register.
Forced air, average \$68 per register.

Iron—Cost of ornamental iron, cast iron, etc., depends on designs.

Lumber (prices delivered to bldg. site)—

No. 1 common	\$45.00 per M
No. 2 common	43.00 per M
Select O. P. Common	48.00 per M
1x4 No. 2 flooring VG	80.00 per M
1x4 No. 3 flooring VG	75.00 per M
1x6 No. 2 flooring VG	90.00 per M
1 1/4" No. 2 flooring	85.00 per M

Slash grain—

1x4 No. 2 flooring	\$65.00 per M
1x4 No. 3 flooring	62.00 per M
No. 1 common run T. & G.	50.00 per M
Lath	7.50 per M

Shingles (add cartage to price quoted)—

Redwood, No. 1	\$1.20 per bdle.
Redwood, No. 2	1.00 per bdls.
Red Cedar	1.40 per bdle.

Plywood—Douglas Fir (add cartage)—

"Plyscord" sheathing (unsanded)
1/2" 3-ply and 48"x96" \$39.75 per M
"Firwall" (wallboard grade) \$43.70 per M
1/4" 3-ply 48"x96" \$117.30 per M
"Plyform" (concrete form grade) \$117.30 per M
3/8" 5-ply 48"x96" \$117.30 per M
Exterior Plywood Siding—
1/2" 5-ply Fir \$132.00 per M
Redwood (Rustic) 1/8" clear heart. \$ 95.00 per M
\$ 5 less per M for A grade.

Millwork—Standard.

O. P. \$100 per 1000. R. W. rustic \$100.00 per 1000 (delivered).
Double hung box window frames, average with trim, \$6.50 and up, each.
Complete door unit, \$10.00.
Screen doors, \$3.50 each.
Patent screen windows, 25c e sq. ft.
Cases for kitchen pantries seven ft. high, per lineal ft., \$8.00 each.
Dining room cases, \$8.00 per lineal foot.
Rough end finish about 75c per sq. ft.
Labor—Rough carpentry, warehouse heavy framing (average), \$17.50 per M.
For smaller work average, \$35.00 to \$45.00 per 1000.

Merble—(See Dealers)

Painting—

Two-coat work	per yard 50c
Three-coat work	per yard 70c
Cold water painting	per yard 10c
Whitewashing	per yard 4c

Turquoise, \$1.08 per gal., in 5 gal. cans, and 95c per gal. in drums.
 Raw Linseed Oil—\$1.32 gal. in light drums.
 Boiled Linseed Oil—\$1.35 gal. in drums and \$1.48 in 5 gal. cans.

White Lead in oil

Per Lb.
 1 ton lots, 100 lbs. net weight.....117/2c
 500 lbs. and less than 1 ton.....121/4c
 Less than 500 lb. lots.....123/4c

Red Lead and litharge

1 ton lots, 100 lbs. net weight.....111/2c
 500 lbs. and less than 1 ton.....121/4c
 Less than 500 lb. lots.....123/4c

Red Lead in oil

1 ton lots, 100 lbs. net weight.....121/2c
 500 lbs. and less than 1 ton.....131/4c
 Less than 500 lb. lots.....133/4c
 Note—Accessibility and conditions cause some variance in costs.

Patent Chimneys—

6-inch\$1.25 lineal foot
 8-inch1.50 lineal foot
 10-inch2.25 lineal foot
 12-inch3.00 lineal foot

Plaster
 Neat wall, per ton delivered in 2 1/2 in. paper bags, \$17.60.

Plastering—Interior—

Yard
 1 coat, brown mortar only, wood lath.....\$0.70
 2 coats, lime mortar hard finish, wood lath......90
 2 coats, hard wall plaster, wood lath......80
 3 coats, metal lath and plaster.....1.50
 Keene cement on metal lath.....1.60
 Ceilings with 3/4 hot roll channels metal lath (lathed only).....1.10
 Ceilings with 3/4 hot roll channels metal lath plastered.....2.00
 Single partition 3/4 channel lath 1 side (lath only).....1.10
 Single partition 3/4 channel lath 2 inches thick plastered.....\$2.90
 4 inch double partition 3/4 channel lath 2 sides (lath only).....2.00
 4-inch double partition 3/4 channel lath 2 sides plastered.....3.50
 Thermax single partition; 1" channels; 2 1/2" overall partition width. Plastered both sides.....3.00
 Thermax double partition; 1" channels; 4 1/2" overall partition width. Plastered both sides.....4.00

3 coats over 1" Thermax nailed to one side wood studs or joists.....1.50
 3 coats over 1" Thermax suspended to one side wood studs with spring sound insulation clip.....1.75

Plastering—Exterior— Yard
 2 coats cement finish, brick or concrete wall.....\$1.00
 3 coats cement finish, No. 18 gauge wire mesh.....1.75
 Wood lath, \$6.50 to \$6.50 per 1000 (not available)......19
 2 1/2-lb. metal lath (dipped) (not available)......21
 3 1/2-lb. metal lath (dipped) (not available)......22
 4-lb. metal lath (galvanized) (not avail.)......24
 3/4-inch hot roll channels, \$72 per ton.....
 Finish plaster, \$18.90 ton in paper sacks.
 Dealer's commission, \$1.00 off above quotations.
 \$13.85 (rebate 10c sack).
 Lime, l.o.b. warehouse \$2.25 bbl.; cars, \$2.15
 Lime, bulk (ton 2000 lbs.), \$16.00 ton.
 Wall Board 5 cly. \$50.00 per M.
 Hydrate Lime, \$25.00 ton.
 Plasterers Wage Scale.....\$1.75 per hour
 Finishers Wage Scale.....1.75 per hour
 Hod Carriers Wage Scale.....1.50 per hour
 Composition Stucco—\$1.80 to \$2.00 sq. yard (applied).

Plumbing—
 From \$100.00 per fixture up, according to grade, quantity and runs.

Roofing—
 "Standard" tar and gravel, \$7.00 per sq. for 30 sqs. or over.
 Less than 30 sqs. \$7.50 per sq.
 Tile, \$20.00 to \$35.00 per square.
 Redwood Shingles, \$7.50 per square in place.
 Copper, \$16.50 to \$18.00 per sq. in place.
 5/2 # 1-16" Cedar Shingles.....8.00 Square
 4 1/2" Exposure.....
 5/8 x 16" # 1 Cedar Shingles, 5" Exposure.....9.00 Square
 4/2 # 1-24" Royal Shingles.....9.50 Square
 7 1/2" Exposure.....
 Re-coat with Gravel, \$3 per sq.
 Asbestos Shingles, \$15 to \$25 per sq. laid.
 Slate, from \$25.00 per sq., according to color and thickness.
 1/2 x 25" Resawn Cedar Shakes, 10" Exposure.....10.50
 3/4 x 25" Resawn Cedar Shakes, 10" Exposure.....11.50

1 x 25" Resawn Cedar Shakes, 10" Exposure.....12.50
 Above prices are for shakes in place.

Sheet Metal—
 Windows—Metal, \$1.75 a sq. ft.
 Fire doors (average), including hardware \$1.75 per sq. ft.

Skylights—(not glazed)
 Copper, 90c sq. ft. (flat).
 Galvanized iron, 40c sq. ft. (flat).
 Vented hip skylights 60c sq. ft.

Steel—Structural (None available except for defense work)
 \$150 ton (erected), this quotation is an average for comparatively small quantities. Light truss work higher. Plain beams and column work in large quantities \$140 per ton.

Steel Reinforcing (None available except for defense work).
 \$150 to \$200 per ton, set.

Stone—
 Granite, average, \$6.50 cu. foot in place.
 Sandstone, average Blue, \$4.00. Boise, \$3.00 sq. ft. in place.
 Indiana Limestone, \$2.80 per sq. ft. in place.

Store Fronts—
 Copper sash bars for store fronts, corner, center and around sides, will average \$1.00 per lineal foot.
 Note—Consult with agents.

Tile—Floor, Weinscott, etc. — [See Dealers]
 Asphalt Tile—18c to 28c per sq. ft. installed.

Wall Tile—
 Glazed Terra Cotta Wall Units (single faced) laid in place—approximate prices:
 2 x 6 x 12.....\$1.00 sq. ft.
 4 x 6 x 12.....1.15 sq. ft.
 2 x 8 x 16.....1.10 sq. ft.
 4 x 8 x 16.....1.30 sq. ft.

Venetian Blinds—
 40c per square foot and up. Installation extra.

Windows—Steel
 Factory type sash 30c ft.
 Ventilators for steel sash \$5.00 each.

1943 BUILDING TRADES WAGE SCALES FOR NORTHERN CALIFORNIA
 All crafts, except plasterers, are now working 8 hours a day. Plasterers' time is 6 hours.

CRAFT	San Francisco	Alameda	Fresno	Marin	Sacramento	San Jose	San Mateo	Vallejo	Stockton
ASBESTOS WORKERS	\$1.50	\$1.25	\$1.25	\$1.37 1/2	\$1.12 1/2	\$1.25	\$1.25	\$1.25	\$1.25
BRICKLAYERS	1.87 1/2	1.87 1/2	1.50	1.87 1/2	2.00	2.00	1.87 1/2	1.87 1/2	2.00
BRICKLAYERS' HODCARRIERS	1.40	1.40	1.05	1.40	1.40	1.40	1.40	1.40	1.40
CARPENTERS	1.43	1.43	1.25	1.43	1.43	1.43	1.43	1.43	1.43
CEMENT FINISHERS	1.37 1/2	1.37 1/2	1.25	1.25	1.25	1.50	1.25	1.25	1.25
ELECTRICIANS	1.70	1.50	1.50	1.37 1/2	1.50	1.50	1.50	1.50	1.37 1/2
ELEVATOR CONSTRUCTORS	1.61	1.56	1.50	1.61	1.61	1.50	1.50	1.56	1.50
ENGINEERS: Material Hoist	1.50	1.37 1/2	1.25	1.50	1.37 1/2	1.62 1/2	1.37 1/2	1.37 1/2	1.25
Piledriver	1.75	1.60	1.40	1.75	1.75	1.75	1.62 1/2	1.75	1.75
Structural Steel	1.75	1.60	1.40	1.75	1.75	1.75	1.60	1.60	1.60
GLASS WORKERS	1.25	1.25	1.12 1/2	1.25	1.12 1/2	1.21	1.25	1.25	1.25
IRONWORKERS: Ornamental	1.50	1.31 1/4	1.37 1/2	1.31 1/4	1.37 1/2	1.31 1/4	1.25	1.31 1/4	1.25
Reinf. Rodmen	1.50	1.31 1/4	1.31 1/4	1.31 1/4	1.31 1/4	1.60	1.50	1.31 1/4	1.25
LABORERS: Building	.85	.87 1/2	.82 1/2	.81 1/4	.85	.81 1/4	.81 1/4	.81 1/4	.80
Concrete	.87 1/2	.93 3/4	.90	.81 1/4	.92 1/2	.85	.85	.90	.90
LATHERS	1.75	1.75	1.50	1.75	1.60	1.75	1.75	1.50	1.50
MARBLE SETTERS	1.43 3/4	1.25	1.25	1.31 1/4	1.37 1/2	1.25	1.31 1/4	1.25	1.25
MOOSAIC & TERRAZZO	1.00	1.25	1.12 1/2	1.12 1/2	1.15-5/8	1.12 1/2	1.12 1/2	1.12 1/2	1.12 1/2
PAINTERS	1.37 1/2	1.50	1.28-4/7	1.37 1/2	1.25	1.35-5/7	1.42-6/7	1.50	1.25
PILEDRIVERS	1.47	1.40	1.40	1.50	1.40	1.47	1.40	1.40	1.40
PLASTERERS	1.66-2/3	1.66-2/3	1.75	1.66-2/3	1.75	2.00	2.00	1.75	1.83-1/3
PLASTERERS' HODCARRIERS	1.50	1.45	1.40	1.40	1.18 1/4	1.35	1.75	1.40	1.50
PLUMBERS	1.70	1.50	1.53-1/8	1.50	1.56 1/4	1.62 1/2	1.50	1.50	1.37 1/2
ROOFERS	1.37 1/2	1.37 1/2	1.12 1/2	1.25	1.25	1.37 1/2	1.25	1.25	1.25
SHEET METAL WORKERS	1.50	1.37 1/2	1.43 3/4	1.50	1.53 1/2	1.50	1.37 1/2	1.25	1.37 1/2
SPRINKLER FITTERS	1.50	1.37 1/2	1.25	1.25	1.25	1.62 1/2	1.50	1.50	1.50
STEAMFITTERS	1.50	1.50	1.53 1/4	1.50	1.56 1/4	1.62 1/2	1.50	1.50	1.50
STONESETTERS (Masons)	1.50	1.75	1.50	1.75	1.75	1.50	1.75	1.75	1.50
TILESETTERS	1.50	1.37 1/2	1.37 1/2	1.37 1/2	1.37 1/2	1.50	1.50	1.37 1/2	1.50

Prepared and compiled by
 CENTRAL CALIFORNIA CHAPTER, ASSOCIATED GENERAL CONTRACTORS OF AMERICA
 with the assistance and cooperation of secretaries of General Contractors Associations and Builders Exchanges of Northern California.

DETROIT STEEL LOOKS AHEAD

If the 55,000,000 jobs that will be needed after Victory are to materialize quickly after the war ends, planning must be done now, and there are things Mr. John Q. Citizen can do to be of practical help. That is the theme of an unusual series of ads now being inserted in national consumer publications by Detroit Steel Products Co., makers of Fenestra steel windows and other building products.

Because this industry is in peace time the No. 1 industrial employer, it must take the lead in having jobs ready soon after the war, not years after, for the boys who are fighting the war through for us, and for the millions of production soldiers, now busy in war plants on work that will end soon after "V-day," the advertising points out.

Huge structures of steel and masonry do not spring up over-night. . . . Schools, hospitals, apartments and hotels, commercial buildings and stores must take form, first, on the drawing board of an architect . . . then land must be acquired, authorizations secured, financing worked out. A start must be made . . . months or years before jobs result.

"What can you do about it?" ask the Fenestra firm's ads. "Why, as a business man or citizen, call the need for planning now to the attention of your local school and hospital boards, your factory executives, your local and state planning and governing bodies. Urge them to use available facilities of architects, engineers, contractors, builders and realtors for forward planning now. Get going on plans for your future home, store or apartment building. Then, we'll have actual construction under way, and millions of jobs in the building industry soon after the war, not two, three or five years after."

While the company's officials are giving constructive thought to forward planning, production facilities of Detroit Steel Products Company are devoted 100% to war production.

LOUIS M. UPTON, ARCHITECT

Louis M. Upton, 64, passed away in a Berkeley hospital July 16 following a brief illness.

Many fine homes in San Francisco and the Bay Area built during the last twenty years were designed by Mr. Upton. His more recent work had been as a member of the architectural staff of the Federal Housing Administration in San Francisco. Mr. Upton was a member of Northern California Chapter, A.I.A., and Oakland Masonic Lodge.

FRANK P. ALLEN

Frank P. Allen, 63, architect and structural engineer with offices at 314 South Alexandria Street, Los Angeles, met with a fatal accident by being hit by a heavy mortorized lumber carrier at the California Shipbuilding Corporation yards in Los Angeles early

BASALITE

CAMBERED SHINGLE TILE

PERMANENT • FIREPROOF • STORM-SAFE • COLORFUL • ECONOMICAL

Manufactured by

BASALT ROCK CO., INC.

NAPA, CALIFORNIA

SISALKRAFT

REG. U. S. PAT. OFF.

"More than a building paper"

THE SISALKRAFT CO.

205 West Wacker Drive
Chicago, Ill.

55 New Montgomery Street
San Francisco, Calif.

VERMONT MARBLE COMPANY

Producers and Finishers
of
Domestic and Imported Marbles

Write for new pamphlet describing our
Marble Toilets and Showers

San Francisco and Los Angeles
San Francisco phone: SUTTER 6747

Fine Water Colors and Papers
For Architectural Renderings

H. S. CROCKER COMPANY, Inc.

720 MISSION STREET
Market Street at Second • San Francisco

**The Most Complete Line of
STEELS and BUILDING MATERIALS
Made by a Single Producer**



See Sweet's Catalog File or write us for
full information.

REPUBLIC STEEL CORPORATION

GENERAL OFFICES: CLEVELAND, OHIO

DENVER, COLORADO CONTINENTAL OIL BUILDING
LOS ANGELES, CALIFORNIA EDISON BUILDING
SALT LAKE CITY, UTAH WALKER BANK BUILDING
SAN FRANCISCO, CALIFORNIA RIALTO BUILDING
SEATTLE, WASH. WHITE-HENRY-STUART BUILDING

**PACIFIC
MANUFACTURING CO.**

HIGH CLASS INTERIOR FINISH
QUALITY MILLWORK

142 SANSOME ST., SAN FRANCISCO
GARfield 7755

6820 MCKINLEY AVE., LOS ANGELES
THornwall 4196

BUILDERS EXCHANGE, OAKLAND

**"AMERICAN MARSH"
Redi-Vac Vacuum Heating Pump**

Send for
Bulletin 441



SIMONDS MACHINERY CO.

San Francisco
816 Folsom St.

Los Angeles
455 East Fourth St.

SANTA MARIA INN SANTA MARIA CALIFORNIA



On the Coast Highway
between Los Angeles
and San Francisco

**OVER NIGHT
or
JUST A MEAL**

FRANK J. McCOY
Owner

EL ENCANTO HOTEL SANTA BARBARA

On the Riviera, above the Old Mission

Frank J. McCoy, Owner

Fred F. Pimental, Manager

last month. Mr. Allen was a construction expert and during World War I supervised the building of wooden ships for the U. S. Maritime Commission.

As architect and works director of the Lewis & Clark Exposition at Portland, Oregon, and the Alaskan-Yukon Exposition in Seattle he made a reputation which led to his appointment to a similar post for the World's Fair at San Diego in 1935-1936. One of the features of the San Diego Exposition was the reinforced concrete bridge in the park which he designed and the construction of which he supervised.

Mr. Allen was architect for the Park Manor and the Maryland apartment hotels in San Diego and the Savoy, Perry and Waldorf hotels and the Crary Building in Seattle, Wash.

PROGRESS IN ILLUMINATION

In an interesting discussion of electrical illumination in a recent number of the magazine Light, Ward Harrison, director, Nela Park Engineering Department of the General Electric Company, says, among many other things:

In 1913, five footcandles of general illumination was unusual and was looked upon as a goal. At that time a 100-watt vacuum tungsten lamp cost eighty cents and gave about 900 lumens. Today the 100-watt fluorescent lamp gives 4200 lumens or nearly five times as much. The cost of current averages less than half of what it did in 1913, so that one may easily secure ten times as much light for the same money.

To prognosticate the future thirty years hence, one might conclude that 500 footcandles of artificial illumination would be as common then as five was in 1913 or fifty in 1943. He ventures the conclusion that the cost of lighting in 1973 will be one-tenth of what it is now.

When you have something that is 80 per cent inefficient, as our best light source which today is the fluorescent lamp, there is still the chance to improve in the ratio of five to one. This presupposes that in the future a radically new light source will be discovered or invented.

Came the gas-filled lamp. The gas-filled lamp eventually became double the efficiency of the vacuum type. He looks for continued improvements in fluorescent lamps from the standpoint of the candlepower maintenance.

The two natural obstacles to adequate artificial illumination have always been glare and heat. The fluorescent lamp bids fair almost to eliminate the heat. In 1913 they very well knew that glare was a detriment and we talked about it then in those same generalities that litter up our lighting literature today.

SEPTEMBER L. H. EVENTS

The California Palace of the Legion of Honor, San Francisco, has announced the following schedule of exhibitions and special events for September:

Boxing, Wrestling and Prize Fighting in Art—Opening Sept. 3.
Watercolors by Chee Chin S. Cheung Lee—Opening Sept. 1.
Cargoes, Inc.—A selection of modern textile and decorative arts—Opening Sept. 1.

Watercolors by William Ross Cameron—Opening Sept. 2.
Soldiers of Production—Opening Sept. 3. Emblems of Unity and Freedom—Closing Sept. 15.

Figureheads and Carvings From American Clipper Ships—Opening Sept. 16.

Paintings: From the Collection of Gordon Blanding—Through Oct. 11.

Motion Picture Series—Admission Free. Each Saturday at 2:30 p.m.

Sept. 4—"Jane Eyre" with Virginia Bruce, Colin Clive.

Sept. 11—"Carnival in Flanders"—A romantic comedy.

Sept. 18—"Great Guy" with James Cagney.

Sept. 25—Shirley Temple Revival Series:

"Dora's Dunking Doughnuts."

"Managed Money."

"Merrily Yours."

Radio Broadcasts

Art Review—By Miss Elizabeth Wisner, Sunday, Sept. 19, at 6 p.m., Station KJBS.

FAVORS OUTSIDE SUB-CONTRACTORS

Contractors in the San Francisco Bay area, who have backlogs of \$5,000,000 in war orders, have been asked by the Government to shift part of their work to sections of the country which have an adequate labor supply.

The Associated Press reported from Washington the army, navy, War Production Board and Maritime Commission have sent a joint letter to all large contractors in this area asking them to spread their work through sub-contractors to less critical labor areas.

ARTHUR F. ROUSSEAU

Arthur F. Rousseau, architect, died at Stanford Hospital, San Francisco, August 5, following a lingering illness. Mr. Rousseau last practiced architecture with his brother, Oliver, now in the contracting business, as Rousseau and Rousseau. The firm designed and built many of the larger apartment houses in San Francisco and Oakland.

ANNOUNCEMENT

From 1424 North Kings Road, Hollywood, comes an interesting announcement that Victor Gruenbaum has recently become a citizen of the United States. At the same time he has shortened and simplified his name to Victor Gruen. In the future the firm name will be Gruen & Krummeck, designers.

Position Wanted—Broad business experience in labor, service, personnel and labor relations. University graduate, member of leading technical organizations, Producers' Council, Rotary and other business groups. Thorough knowledge Pacific Coast industry and interesting acquaintance with architects, engineers and professional men. At present employed by leading Pacific Coast organization, stymied due to financial control and therefore resigning. For personal interview, please write **Engineer, c/o Architect & Engineer, 68 Post Street, San Francisco.**

HOGAN LUMBER CO.

Wholesale and Retail

LUMBER

MILL WORK • SASH & DOORS

Office, Mill, Yard and Docks

SECOND AND ALICE STREETS • OAKLAND, CALIF.

Telephone Glencourt 6861

CLINTON CONSTRUCTION CO. OF CALIFORNIA

General Contractors

923 FOLSOM STREET • SAN FRANCISCO

SUtter 3440

FORDERER CORNICE WORKS

Manufacturers of

Hollow Metal Products • Interior Metal Trim

Elevator Fronts and Cabs

Metal Plaster Accessories • Sanitary Metal Base

Flat and Roll Metal Screens

Metal Cabinets • Commercial Refrigerators

269 POTRERO AVE.

SAN FRANCISCO, CALIF.

HEMLOCK 4100

STRUCTURAL STEEL

For Class A Buildings,
Bridges, etc.

JUDSON PACIFIC CO.

1200 SEVENTEENTH STREET
SAN FRANCISCO

Plants: San Francisco - Oakland

N. CLARK AND SONS

Manufacturers of
Quality
Architectural
Clay Products

During this stage of the war, our principal energy is to manufacture products required by the various war agencies. We still can supply some pre-war materials for civilian needs.



401 PACIFIC AVENUE
ALAMEDA, CALIFORNIA

San Francisco • Los Angeles
Salt Lake City • Portland

TRENDS IN ELECTRONICS

By A. C. Monteith*

Electronics is a much used and much abused term. In the strictest sense of the word, "electronics" is that which has to do with the action of electrons—such a general definition sweeps into its arms heat, light, magnetism, and electricity. The control of the electron has been the job of the electrical industry since its inception. When radio came along with the vacuum tube in which electrons are not confined inside copper wires but pass out into confined space, we had a new and more restricted definition of electronics. Gradually, the term "electronics" was generally applied to all devices in which electrons do their work in space and not within solid matter like copper. On this basis electronics has become a full fledged tool of industry.

There has been much discussion of electronics of late, and there is some tendency to speak of electronics as a servant of the future. Probably \$500,000,000 worth of business has been done in the industrial field in the last three years, excluding radio and Radar. This makes it a "big business" even today. Electronics is growing fast. The only caution for the future is to be sure it does not move so fast that we will be swept off our feet in making use of it. Let's not use electronics just because of its popularity at the moment. Let's appraise each application and compare it with the time-tried mechanical methods. If it wins out in such a comparison, let's give it every opportunity. Electronics is a going business, and if we keep the application on a sound basis there is no question about the future of electronics in industry.

A large portion of this business has been a direct result of the war, and this has given engineers an opportunity to try new ideas. Also, it has provided a sufficient volume to produce a variety of electronic devices which has helped interpret the potential usefulness of electronics.

*Manager, Industry Engineering Dept., Westinghouse Electric and Manufacturing Company, East Pittsburgh, Pa.

INCANDESCENT SUPPLY COMPANY

647

MISSION STREET
SAN FRANCISCO

Lighting Fixtures and
Lamps, Fireplace Furnishings, Pictures and Mirrors, Electrical Supplies and Marine Fixtures.

Oakland - Fresno
Los Angeles



HERRICK IRON WORKS

STRUCTURAL STEEL
REINFORCING STEEL

18TH AND CAMPBELL STS.
OAKLAND, CALIF.
Phone GLencourt 1767

ABBOT A. HANKS, INC. Engineers & Chemists

INSPECTING — TESTING — CONSULTING
CONCRETE • STEEL • MATERIALS
CHEMICAL AND TESTING
LABORATORIES

• RESEARCH AND INVESTIGATION •

TESTS OF STRUCTURAL MATERIALS
DESIGN OF CONCRETE MIXES
SHOP AND ERECTION INSPECTION OF
STRUCTURES AND EQUIPMENT
INVESTIGATION OF STRUCTURES
AND MATERIALS
TESTS AND INVESTIGATION OF
FOUNDATION SOILS
FIRE RESISTANCE AND INSULATION
TESTS

624 Sacramento Street, San Francisco

Independent Iron Works

Structural Steel
Ornamental Iron
Steel Service Stations
Steel Tanks
Standard Steel Mill Buildings
Bridges

821 Pine Street

Oakland

ANDERSON & RINGROSE

General Contractors

320 Market Street, San Francisco
Phone GARfield 2245

MULLEN MFG. COMPANY

BANK, STORE AND OFFICE
FIXTURES—CABINET WORK
OF GUARANTEED QUALITY
CHURCH SEATING

Office and Factory:
40-80 RAUSCH ST., Bet. 7th and 8th Sts.
San Francisco
Telephone UNDERhill 5815

THE TORMEY COMPANY

GENERAL PAINTERS
AND DECORATORS

Phone UNDERhill 1913

563 FULTON STREET
San Francisco

Phone GARfield 1164

Thomas B. Hunter

Consulting Engineer

DESIGNER OF HEATING
AIR CONDITIONING
VENTILATING AND WIRING
SYSTEMS, MECHANICAL
AND ELECTRICAL EQUIP-
MENT OF BUILDINGS

or

41 SUTTER STREET
ROOM 710

San Francisco California

Robert W. Hunt Company

ENGINEERS

Inspection - Tests - Consultation

Schools and Other Structures
Are Built as Designed

When Construction Materials are
Inspected at point of Manufacture
and during Erection by

ROBERT W. HUNT COMPANY

Cement, Concrete, Chemical, Metallurgical,
X-Ray and Physical Laboratories

Chicago - New York - Pittsburgh
Los Angeles - All Large Cities
San Francisco, 251 Kearny Street

ORGANIZATION

To make sure that we as a company use this new tool to best advantage and keep our feet on the ground, a central electronics group has just been established in the Industry Engineering Department at East Pittsburgh. Westinghouse has some twenty organizations, each complete in itself, building specific products like motors, transformers, and lamps. But users are not interested in individual products as such, but rather the production of aircraft, rubber, metals, etc. Our Industry Engineers work with all the different industries to integrate our products into engineering systems that best meet production needs. There are a number of these specialized groups in Industry Engineering serving the various industries such as marine, metal working, general mills, petroleum and chemical, central station, aviation and mining.

The new group of electronics engineers are consultants to guide all of these Industry Engineers when analyzing specific industry applications. In this manner careful consideration will be given electronic methods as compared with established mechanical means. Thus, the best method will be used. This way we will keep electronics on a good, sound basis compared to the tried and proven mechanical way of doing things.

TREND

This new organization is essentially tailored to match some broad electronic trends we have observed in industry. For example, for a long time many industries hesitated to accept the electronic way of doing things. Recently, however, many have shown signs of greatly increased interest; and once electronics has proven itself on the job, they become staunch supporters. So there will probably be a pyramiding effect. This has already happened with the ignitron; its activity having reached the level of factory built-and-tested units, similar to that long used for such things as metal clad switchgear.

Since improved tubes have often proved to be the key to major electronic advances, there is a marked

USE
Mailway
Banking

**FOR BUSINESS AND
PERSONAL ACCOUNTS**

Merchants, professional people, office workers . . . all types find our Mailway service the most convenient way of banking. They make deposits any time, night or day, Sundays or holidays. Our special Mailway envelopes and passbook assure quick and safe service.

Open a Mailway account by mail

**CROCKER FIRST
NATIONAL BANK**
OF SAN FRANCISCO
California's First National Bank

Member Federal Deposit Insurance Corporation
ONE MONTGOMERY STREET

OFFICE BUILDING FOR SCHUCKL CANNING CO., SUNNYVALE

WM. W. WURSTER
ARCHITECT

**We are proud of
our participation
in the successful
completion of this
outstanding project**

* * *

**ALADDIN
HEATING CORP.**

2222 SAN PABLO AVE.

Oakland, California

LANDSCAPING and PLANTING



Richmond 4000
Family Units
Apartment Hous-
ing Project for
U. S. Maritime
Commission, by

LEONARD COATES NURSERIES, INC.

Ray D. Hartman, President-Manager

SAN JOSE, CALIFORNIA

G. P. W. JENSEN & SON

Building Construction

320 Market Street, San Francisco

Phone: GARfield 2444

JOHN CASSARETTO

—Since 1886—And Still Active—

Building Materials

READY MIX CONCRETE
ROCK - SAND - GRAVEL - LIME
CEMENT - PLASTER - MORTAR
METAL LATH - WOOD LATH
STUCCO - WIRE NETTING

Service Unexcelled

Bunkers

Sixth and Channel, San Francisco
Phones: GARfield 3176, GARfield 3177

trend by research groups to concentrate on improved tube characteristics. The outlook appears encouraging.

Another striking note is the increasing desire of schools and industry to find out how electronics work. Several months ago Westinghouse felt this as a definite impact and immediately started plans to produce an educational movie and a special ABC booklet on electronics. This general seeking of knowledge may well turn out to be the most significant trend of this present electronic era.

The more people understand about electronics, the more they will put it to work properly, and the greater will be its usefulness to industry.

CITY PLAN

The Editor: In the June issue of your magazine there appeared an article about the city plan that I had on exhibit in the San Francisco Museum. I should appreciate your forwarding me 4-6 copies of said number.

It may interest you to know that besides the wide national publicity that the plan has received, I have just recently been asked to send material covering the plan to Edinburgh, Scotland, for an exhibition to be held there and sponsored by the Edinburgh Architectural Association.

Very truly yours,

C. B. TROEDSSON.

524 Cornell Drive,
Burbank, Calif.

CANCEL ALL CONVENTIONS

Joseph B. Eastman, director of the Office of Defense Transportation, recently renewed his request for cancellation of conventions and similar group meetings.

Convention travel, Mr. Eastman said, is interfering with military and essential war business travel. He asserted that the passenger transportation problem was now so serious that even those organizations whose conventions would be devoted to matters closely concerned with the war might contribute more to the war effort by canceling their meetings.

C. OF C. PLANS "WORK PILE"

To form a cushion for the transitory period of the post-war era, the San Francisco Chamber of Commerce is organizing a "work pile" which may be drawn upon by business and industry in the northern California area. To date, about 70 committees have been formed and more are to be organized to carry on the work.

The task of each committee will be to determine as closely as possible the present and future status of the industry or business it represents and build a prospect list of those who will need various facilities or services when the war is over. This will automatically create a prospect and market list for all those who participate.

The committees obtain their information from a report form on which the individual business units answer the following questions:

1. Are you planning now for post-war business, and does your plan call for immediate action at the close of hostilities?
2. What immediate reemployment will be possible? List occupations and numbers needed.
3. What immediate remodeling will you do? Give approximate cost of: (a) Front or exterior improve-

ARCHITECT

AND

ENGINEER

SEPTEMBER 1943





ROBERT MCCARTHY

Your WAR BONDS built this Vital Shipyard Housing—

The Robert McCarthy Co. Methods Save Time and Money

The Robert McCarthy Company, general contractors, recently finished 4,000 apartment units in Richmond.

Part of your War Bond purchases go for this necessary program. Rentals will reimburse the Government.

Completed in record time, this 4,000-unit job in Richmond for the U. S. Maritime Commission also showed a two-fold saving in money—the Robert McCarthy Company's low bid saved money and their saving of time will shorten the war and thereby save additional money in the end.

The Robert McCarthy Company, San Francisco, is an organization of specialized ability in the construction field, having at its command all the necessary modern equipment for the successful completion of all types of construction.

Other McCarthy jobs:

During the last two years, the Robert McCarthy Company has built about \$20,000,000 worth of war housing—all completed properly at low cost, plus speed. The jobs include 1,700 prefabricated housing units in Vallejo, 332 permanent prefabricated units in Sacramento, 5,800 apartment units in Richmond, 500 in Alameda, housing along the Alcan Highway, and special jobs for the Army.

A few of the recently-completed 4,000 apartment units in Richmond sponsored by the U. S. Maritime Commission.



ARCHITECT AND ENGINEER

SEPTEMBER, 1943

Vol. 154 No. 3

FRED W. JONES
Editor

MARK DANIELS
Associate Editor

HOWARD MOISE
Post-War Planning

E. N. KIERULFF*
Ass't Editor
*In the Service

COVER PICTURE: Channel Heights Apartments.

PHOTOGRAPHY: Julius Shulman (Los Angeles Housing).
A. L. Adkins (War Dormitories, San Francisco Civic Center).

CONTENTS

Running Fire	3
Mark Daniels, A.I.A.	
News and Comment on Art	4-5
What's on Your Mind?	7
Los Angeles Completes Five Lanham Act Projects	13
Harrison Stephens	
If Architect Loses His Public Will Engineer Replace Him?	25
El-Way to Relieve San Francisco Traffic Congestion	27
Frederick Hamilton	
Some Architectural Uses for West Coast Hemlock	29
R. T. Titus	
Heating Executive Denounces Post-War Ballyhoo	33
House a Day—Record Building Achievement of Robert McCarthy	34
What San Francisco Architects Are Doing	36
Architects' Bulletin	37
W. C. Ambrose	
Producers' Council Page	39

Illustrations

Los Angeles Temporary War Housing	12-25
Wilmington Hall	
Channel Heights	
Baning Homes	
Narmont Terrace	
Dana Strand Village	
El-Way for San Francisco	27-28
Donald R. Warren Co., Engineers	
Pictures Showing Uses of West Coast Hemlock	29-32
War Dormitories, San Francisco Civic Center	34-35

ARCHITECT AND ENGINEER (Established 1905) is published on the 15th of the month by The Architect and Engineer, Inc., 68 Post Street, San Francisco. President, K. P. Kierulff; Vice-President, Fred'k W. Jones; Secretary-Treasurer and Manager, L. B. Penhorwood; Advertising Manager, V. E. Atkinson, Jr.

Los Angeles Office: 403 W. 8th Street, Robert W. Walker, Manager.

Entered as second class matter, November 2, 1905, at the Post Office in San Francisco, California, under the Act of March 3, 1879. Subscriptions, United States and Pan America, \$3.00 a year; \$5.00 two years; foreign countries \$5.00 a year; single copy 50c. ARCHITECTS' REPORTS are published daily from this office, Vernon S. Yallop, Mgr.

NEXT MONTH

ONE MILLION houses a year for the next ten years following the War, is predicted by experts and probably is not a bad guess. Using this prediction as a background, certain publicity connections are spreading stories of building material developments that are far from authentic, leading a gullible public to believe that the building industry is headed for a revolutionary period. No, there will be no radical changes in building methods and materials, at least not for a year or two following the advent of peace. There will be minor developments, however, with prefabrication in the fore. Progress in glass uses and replacement of certain metal accessories with plastics are a certainty.

One well informed in the plastic field will give you the true facts about the plastic industry, dispelling some of the flights of fancy of the misinformed whose ballyhoo runs from a pent house on top of every garage with a plastic blonde domiciled in every room, to the heating of homes by captive heat waves.

"Plastics for the Architect" by Henry O. Belleville, authentically presents the discernible limitations within which the designer may hope to count on plastic in projecting buildings of the future. While rumor has it that an all-plastic house has been exhibited in Europe, no attempt is made by the author of next month's article to forecast as likely the prospect that these laboratory creations are to be built on a mass production scale in this country.

Ingenious

JOHNNY DOUGHBOY GOES MODERN EVEN IN SOLOMON JUNGLE CAMP!

Modern Fountain in Jungle



A strange sight in the midst of a Solomons jungle camp in the South Pacific is this modern drinking fountain, supplied with water by gravity and pipe lines from nearby hills.



Illustrated is the HAWS Model 8L Drinking Fountain. This type fountain is offering fresh, healthful drinking water to millions of our fighting men and women all over the world. HAWS lists eight models of Cantonment Type Drinking Fountains along with the complete line of sanitary drinking fountains and faucets.

HAWS DRINKING FAUCET COMPANY

1808 HARMON STREET · BERKELEY 3 · CALIFORNIA

Agents in the following cities:

Chicago · Los Angeles · San Francisco · Seattle · Salt Lake City · Portland
New Orleans · Newark, N. J. · Houston · Atlanta · Philadelphia · Worcester, Mass.

RUNNING FIRE — by MARK DANIELS

SAUCE FOR THE GOOSE

One of the major precepts of the American form of government is that there shall be no class legislation. If a law is passed that may help one class of people shall be of a form that shall apply to all classes. If it helps bald headed people it must be fair to those of flowing manes. If a law is passed that is aimed to aid the farmers it should be so framed that, if possible, it might help the urban dwellers also. Of course, we know that this is not done but we like to boast about it.

Lately we have inaugurated a procedure which, if it is not a law it is to become a practice, is designed to help the farmer immeasurably, and the more I think of it and how its benefits could be extended to help people in other walks of life, the better it looks to me. It is the pronounced determination of the President and Congress to purchase farm products at a cost that will produce a profit to the farmer and to sell these products to the consumer at a greatly reduced price, thus enabling the consumer to put more of his earnings into bonds and at the same time pay the farmer a fair sum for his product.

Now, why not apply this practice to the product of the Architect? Let the government buy the plans from the Architect at a price that will net him a small profit and sell them to the client at a figure that will enable him to buy still more bonds. Obviously the government's time old prejudice against paying the Architect any fee that would include a profit will be a stumbling block, but it was done for the farmer and if it's sauce for the goose why not make a little for the gander?

• FROM WORSE TO WORST

There is an old legend, or tale, about three huge dogs, each of which was larger than the other. The impossibility is amusing yet it gives an impression of great size.

Well, recently I went over a book on architecture (so called) entitled, "How to Plan a House," published by the American Technical Society in 1942, and it brought to mind the tale of the three dogs for, from the standpoint of design, each house illustrated was uglier than the other.

• A PLETHORA OF MATERIAL

Don't let the infinite number of new products for the "Post War House" scare you. Time and again I have heard that people were postponing the work of planning the house they were going to build, when building materials were again allocated to civilian use, because these materials would be so different from those used in the past.

No doubt certain new materials will influence details of construction, such as the use of plastic pipes, radiant heat, and the like, but the attic will still be somewhere near the roof and the basement will remain in the vicinity of the ground; that is if the crack-

pot don't succeed in persuading their clients to hang their houses from telegraph poles. Planning the house will still be a problem in P-L-A-N-N-I-N-G for each individual builder of his home, unless he cannot decide whether to cook in the bedroom, the bathtub or the kitchen.

• THE OCR

That is the Office of Civilian Requirements, a new branch of the WPB, which is the War Production Board, which in turn is a branch of the—let it go at that. Anyhow, the OCR is destined to be a very busy office; that is if the government can be taught to see that civilians must be kept alive if the army is to be kept fighting. It is equally apparent that a major problem confronting the OCR will be to determine the merits of the innumerable contentions with which they will be confronted that certain civilian requirements are essential, but there are some of us sufficiently optimistic to hope that we civilians will be allowed to live, eat and build shelters to sleep under while we earn enough to pay the salaries of the OCR.

• CONFIDENCE

An article in a recent issue of a New Zealand journal carried the caption, "What English Women Want." That caption showed an editor's confidence in an author's stuff.

Some time ago I read a notice of a lecture to be given by a man of the cloth entitled, "Is Life Worth Living?" a title which carried the same feeling of confidence. I did not go to the lecture nor read the article, so of course, I can't be expected to know what English (or any other) women want or whether life is worth living.

• A PROBLEM FOR THE UNIONS

If the planners of the kitchens in the post-war houses go to the extremes advocated by the ultra modern architect, union labor will be confronted with the problem of whether to request the modern plumber to take out a card as cook or demand that cooks must also hold cards in a plumbers' union.

• DREAMING AND PLANNING

We see in print the oft repeated statement that "Dreaming is not Planning." Perhaps that is true in most instances but planning is often dreaming, or at least involves dreaming that is, dreaming in the sense of forming clear mental images. Considered in that light dreaming may not be planning but good planning always involves dreaming.

• STATE CONVENTION

After some deliberation it has been decided to hold a convention as usual of the State Association of California Architects. The exact date is to be determined, probably late in October at Los Angeles.

NEWS AND COMMENT ON ART

"MEET THE ARTIST"—A SELF PORTRAIT SHOW AT M. H. DE YOUNG MUSEUM

The big self-portrait show of living American artists which San Francisco's de Young Museum offers as its main attraction for 1943 is now on view. "Meet the Artist" is the exhibit that invites you to see the artist—and the cartoonist—as he sees himself, whether it be through rose-colored glasses, stark realism, or the ego-destroying method, the caricature.

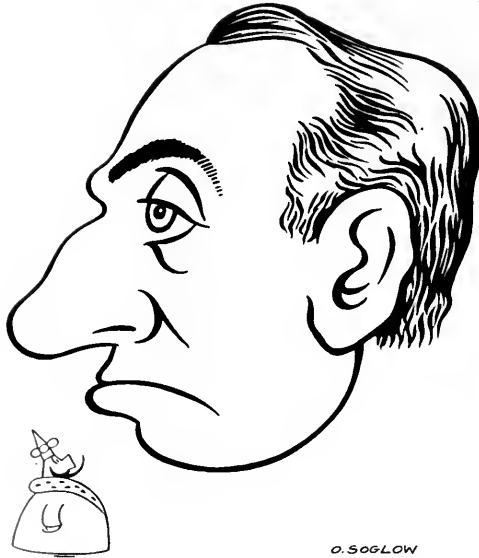

Self-portrait of Cartoonist Otto Saglow whose comic strips may be seen in their original form at the "Meet the Artist" exhibition, M. H. de Young Museum, San Francisco.

Though the idea of the self-portrait is as old as painting itself, the notion of assembling likenesses of the leading living artists of a nation—and including in that category not established painters alone, but some of the most original creative talent, that of the cartoonist and comic stripper—this type of exhibition is decidedly unique. Not only a cross-section of the country's art is given (for in spite of war difficulties, there are very few illustrious names missing from the roll), but a study in styles and techniques is shown as well. For each artist was "restricted" by one consideration—his subject. From then on he was on his own to improve upon the product itself, or to ridicule the work of mother nature as the spirit moved. Many mediums, many techniques, many different approaches—but one model: the artist himself.

Lest the painter stray too far from his subject, a photograph that "does not lie" is displayed alongside his work. The visitor therefore sees the artist both as he sees himself and as the camera sees him.

NEW SATURDAY AND SUNDAY MOVIE PROGRAM AT S. F. MUSEUM

A new Saturday and Sunday free program of instructional movies, mostly in color and with sound, on various aspects and activities of our world today, was inaugurated at the San Francisco Museum of Art on Saturday, September 11.

Travel pictures, industries and occupations directly or indirectly concerned with art, art processes and the like will be included in the programs. The opening session is devoted to Latin America with the showing of three especially distinguished and varied films on South America in general, Venezuela and Mexico. For variety each program will include one of the classic animated short cartoons of the past—a field in which the movies have been exceptionally successful in developing an expressive art form typical of their technique, and a five minute consideration of some contemporary related art problems.

This addition to the Museum's work with movies to a wider audience of different interests represents a consistent and logical extension of its interest in and use of visual media. The programs have been carefully selected on the basis of quality and will offer through the fall season a considerable variety in travel fare and contemporary experience. There is no charge to the public, and the documentary movies are presented as a contribution to public instruction as a service to the children and adults of the community.

"ART" AND PHOTOS BY MEN IN SERVICE AT DE YOUNG MUSEUM

Now showing at the de Young Museum, Golden Gate Park, San Francisco, is the much-discussed and publicized exhibition about men in the armed service. Featured by Life Magazine, CBS and Associated Press and circulated by Publicity Features, Inc., the show is called Life in the Service and contains both "art" and photos by men in the armed forces. Under the first heading come pastels, watercolors, pen and ink sketches and oils—all drawings from life in the barracks, aboard ship, at mess—and under fire.

The exhibit is in nature of a contest, over six hundred men submitting from thirty-three states. The works shown have been selected from the lot by a jury of critics.

REALISTS AND MAGIC REALISTS OF TODAY—AMERICANS 1943, EXHIBIT

Concluded September 19 at the San Francisco Museum of Art, following a popular showing, Americans 1943; comprised a small but helpful section of Americans of the 19th Century, especially Rachaele Peale, George Caleb Bingham, and William Harnett, whose depiction of reality is so intense that it approaches illusion or vivid storytelling illustration. Both types of realistic painting has appealed to the American public. In its pioneer naivete it first learned to exclaim over the incredible gift of representing exactly three dimensions on a flat surface—a feat that never fails even today to evoke admiration from a percentage of

AN EVER CHANGING WORLD

gallery visitors. Illustration, of course, has always had its place in the art of all periods. It came strongly into its own in the American tradition of Blakelock, Eakins, Homer, John Sloan, Thomas Benton, etc. Both traditions, exemplified by artists of power, have yielded works of merit, and this is especially true in the relatively recently developed art of our own country, a land of material problems and somewhat factual-minded conquerors of a wilderness.

NOTES FROM "ART DIGEST"

Our wide-awake Paul Williamson, Chairman of the Board of the California Chapter, in a recent communication with a well known "Home" magazine, makes the following pertinent suggestion to planning engineers for homes of tomorrow:

I. That wall space be provided for the proper display of pictures. Original oil, watercolor, or prints. II. Do not break wall space by electric light brackets. Visualize pictures by selection of owner as the decorative motif. Place wall brackets at edge of windows and doors, or corners, this to include indirect illumination. III. The fad to eliminate pictures has passed as an amateur decorator's scheme to cover up his lack of knowledge of what was good in the arts. Today American artists are producing in oils, watercolors, etc., good pictures to fit the purse of the average home owner. Anyone can own originals now. Today's best decorators "build a room" around an outstanding picture. This adds to America's culture.

Let's hope the builders of "Homes of Tomorrow" will heed this advice.

* * *

Dean Cornwell, best known in Los Angeles for his murals in the Public Library, is now in that city to complete the fifth in his series of paintings of American Medical Pioneers. The canvas will depict William Proctor, Jr., of Philadelphia, who placed pharmacy on an ethical basis.

* * *

Your Pacific Coast correspondent was once present at a luncheon of the art section of the Commonwealth Club of California, at which Abel Warshawsky was the guest of honor. The chairman, Mr. Henley, asked Warshawsky, "Who has the largest collection of your paintings?"

"I have," replied the artist. "I have a complete collection."—Clifford Gessler.

* * *

PREVIEWS

Recent previews that attracted goodly crowds were the exhibition of "Boxing and Wrestling in Art," Thursday afternoon, September 2nd, at the California Palace of the Legion of Honor, and the exhibition "Meet the Artist," Thursday afternoon, August 26th, at the M. H. deYoung Memorial Museum. Guests were treated to buffet refreshments at both affairs.



"SOLILOQUY, 1940"

Oil on composition board,

by Louis Guglielmi

—at San Francisco

Museum of Art

So that the employees and associates of
THE K. E. PARKER CO.
*May know that their efforts are appreciated
 by the Naval Authorities in Washington,
 we are proud to publish the following telegram:*

<small>OF SERVICE</small> <small>a full-rate or Cable less its de- creaser is in- for a suitable above or pre- e address.</small>	<h1>WESTERN UNION</h1>	1230	<small>SYMBOLS</small> DL = Day Letter NT = Overnight Telegram LC = Deferred Cable MLT = Cable Night Letter Ship Radiogram
	<small>A. N. WILLIAMS PRESIDENT</small>	<small>NEWCOMB DARLTON CHAIRMAN OF THE BOARD</small>	<small>J. C. WELLS PRES. VIC. PRESIDENT</small>
	<small>see above in the date line on telegrams and day letters is STANDARD TIME at point of origin. Time of receipt is STANDARD TIME at point of destination.</small>		
	WB25 LG=WASHINGTON DC 31 426P TO THE MEN AND WOMEN OF K E PARKER CO= 135 SOUTH PARK SFRAN=		

IT SHOULD BE A SOURCE OF GREAT SATISFACTION TO YOU TO BE ENGAGED IN THE IMPORTANT WORK OF BUILDING THE OAK KNOLL NAVAL HOSPITAL AT OAKLAND CALIFORNIA WHICH WILL PROVIDE VITAL FACILITIES FOR THE TREATMENT OF OUR WOUNDED WAR VETERANS. ANOTHER ACHIEVEMENT TO YOUR CREDIT WAS THE GENERAL CONSTRUCTION WORK YOU DID FOR THE AUXILIARY AIR STATION AT MONTEREY WHERE FLYING CADETS ARE BEING TRAINED TO TAKE UP THE FIGHT AGAINST THE ENEMY IN THE SKIES. THE BUREAU TAKES THIS OPPORTUNITY TO THANK YOU FOR THESE FINE CONTRIBUTIONS TO THE WAR EFFORT=
 BEN MOREEL REAR ADMIRAL (CEC) USN
 CHIEF OF THE BUREAU OF YARDS & DOCKS

WHAT'S ON YOUR MIND?

Letters to the Editor

POST-WAR AUDITORIUM

Editor,
Architect and Engineer:

The editor of "Architectural Forum" has suggested your name as a possible source of information and data which I might use as Chairman of one of our Citizens' Post-war Planning Committees at Brantford, Ontario.

One of the projects is a memorial auditorium capable of seating between four and five thousand people, heated, air-conditioned, with removable ice surface, acoustically suitable for concerts and designed so that the exterior would be a fitting memorial to those members of the community who will, by their sacrifices, make Peace a reality.

We have no preconceived ideas as to what the building should look like, how much property it should occupy, what it would cost and what the possibilities of its becoming a self liquidating project would be after it is built.

What I would like to know is, if in your files you would have information as to where similar auditoria are located in the United States, so that we can write the municipalities concerned and secure particulars as outlined above.

Brantford is the fifth manufacturing city in Ontario, with a population of 35,000 and is in the center of a highly productive agricultural county, and has absolutely no facilities for large public gatherings of any kind.

One of our ideas also, is that we may be able to construct a swimming pool adjacent to the community auditorium, using the basement level of this building for locker and shower facilities, and we have already the moral and financial support of our six service clubs in this undertaking.

While we all realize that the most important thing at the moment is to keep our eye on the ball as far as winning the war is concerned, we do not feel it out of place to be doing some thinking and some planning toward the type of city we would like to have after the war, and we hope that you will be able to help us in suggesting the source or sources of information we require.

Yours very truly,

E. M. PRITCHARD, Chairman,
Recreation & Recreation Projects,
Post-War Planning Committee.

The names of several outstanding municipal and memorial auditoriums in California were furnished Mr. Pritchard, together with the names of the architects of these buildings.—Ed.

THE LATE HENRY H. MEYERS

Editor,
Architect and Engineer:

Several weeks ago, I received several extra copies of the June issue of the Architect and Engineer in which you published the very fine obituary on my father, Henry H. Meyers.

I want to thank you for these additional copies and at this time to tell you how very much we appreciated your splendid article.

Father was always so interested in your magazine and felt it to be one of the most valuable publications of its kind in that it deals mostly with western problems. We have quite a complete file for many years back and he often referred especially to the page giving cost data.

Although Mr. Meyers retired in 1936, he continued to lead a very active life in his many interests and kept in touch with all things of architectural and engineering interest.

Thank you again for your kind thought.

Yours very truly,
MILDRED MEYERS.

Alameda, August 15, 1943.

ROBERT MCCARTHY'S HOUSING JOB

Editor,
Architect and Engineer:

The July issue of Architect and Engineer is a wonderful issue of worthwhile information with good photographs throughout. Congratulations!

Mr. McCarthy is very much pleased with the way you handled the story about his vast war-housing jobs.

Best of wishes,
A. L. ADKINS.

San Francisco, July 27, 1943.

That Robert McCarthy's housing jobs are attracting national interest, is apparent from information that has come to us that Architectural Forum will shortly feature some of his work.—Ed.

SQUARE FOOT COST DATA

Editor Architect & Engineer:

Would it be possible in one of the forthcoming magazines for your staff to gather data and publish the square foot cost data of various types of buildings.

I refer to frame one story, two story, brick, concrete and the brick veneer type of house.

I use your Estimator's Guide published each month but would appreciate seeing in your magazine the cost data of typical houses of this area.

Yours very truly,
IRA JACOBS.

San Francisco, Sept. 2, 1943.



**"I don't know when
this house can be built
—but I do know it
will be ALL-GAS"**

Pre-war experience guides post-war planning. ★ Gas cooking, heating, hot water service and refrigeration have met every test of convenience, cleanliness, speed, dependability and economy. ★ Now, gas appliances—temporarily irreplaceable—are proving their *durability* as never before. ★ Architects and builders may be assured that the gas industry will keep pace with their own progress in design and features—that tomorrow's all-gas homes, too, will convert clients into friends.

THE PACIFIC COAST
GAS ASSOCIATION

☆ **GAS FUEL**
SERVING THE WEST—IN WAR AND PEACE

Doing the WAR JOBS



When labor is scarce and building hurried, call on Cabot's Shingle Stains for your war jobs. These stains are quickly and easily applied. They give maximum protection at minimum cost. And they do not peel or blister even when used on unseasoned lumber or before the building has dried out.

Booklet color card free



GUNN, CARLE & CO.

20 POTRERO AVE.
SAN FRANCISCO
Underhill 5480

GET PEACETIME QUALITY in Wartime Construction

★ ★ WITH KRAFTILE ★ ★

**No Priority • Immediate Delivery
End Building Bottlenecks**

Here are 5 big reasons why KRAFTILE CLAY PRODUCTS can be used to replace steel and other critical materials on any heavy construction job.

1. When it's built with KRAFTILE it's built to last; no upkeep cost.
2. KRAFTILE is waterproof, fireproof, stainproof, verminproof and scratchproof.
3. There's no quantity limitation on non-critical KRAFTILE Clay Products.
4. KRAFTILE saves up to one-half the time on interior walls... surfacing is unnecessary, since KRAFTILE WALL UNITS come pre-tiled one side, or both.
5. You can erect KRAFTILE installations in one-third the time required for old-fashioned frame construction. Only one craft is necessary for an entire job when you use KRAFTILE.

For more information,
phone or write today to

KRAFTILE
NILES, CALIFORNIA

TOUGH GOING FOR WHITE COLLARITES

The incomes of more than 20,000,000 persons who depend on fixed low wages, pensions or allotments, or meager checks from governmental units, are shrinking with every rise in the cost of living, the Office of War Information said today.

Nine million are dependents of men now serving in the armed forces of the United States.

Nearly 2,200,000 are aged persons on State public assistance rolls.

Another million are disabled veterans drawing pensions or disability compensation, or the widows and dependent children of veterans.

Retired and disabled firemen, policemen, state and municipal employees totalling 158,000 are receiving pensions or retirement pay.

Dependent children receiving aid through Federal and State welfare funds number 739,000.

Fifty-three thousand are blind.

About 700,000 retired workers, widows and young children receive social insurance payments under the Old Age and Survivors Insurance program of the Social Security Board.

More than 400,000 persons are drawing annuities for which they had put away their savings for many years.

Not all of these people, of course, depend entirely on the government or insurance checks coming to them monthly, but the payments they receive are fixed and do not rise with the rising costs of living. Each check will purchase fewer necessities if prices continue upward. So will the dollars of 6,000,000 others—teachers, public employees such as firemen, policemen, nurses in state and city hospitals; municipal, county, township and state employees, and workers on Federal government rolls.

The 9,300,000 men in America's armed forces, each receiving non-elastic dollars, are among those who, when on furlough for instance, would feel the immediate pinch of every upward twist of the inflation spiral.

STRUCTURAL ENGINEERS FALL MEETING

Structural Engineers of Northern California held their initial fall meeting at the Engineers Club in San Francisco the evening of September 7. Following dinner the members participated in an interesting discussion of "The Design, Fabrication and Erection of the Rainbow Bridge at Niagara Falls," interspersed with interesting motion pictures. Speaker of the evening was E. L. Durkee of the Shipbuilding Division, Bethlehem Steel Company of Alameda, who was resident engineer in charge of erection of the Rainbow bridge, world's largest fixed arch, having a span of 950 feet—center to center of concrete skewback, and a rise of 150 feet at the crown.

*Architects
...Engineers*

**In these days of re-
formulations**, due to raw
material shortages and priori-
ties, it's more important than
ever to seek reliable counsel
and use only dependable prod-
ucts. Fuller research has long
been preparing for today's
emergency needs. Our tech-
nicians will gladly help you.

**"CALL
FULLER"
ON ALL YOUR PAINT PROBLEMS**



Index to Advertisers'

*Indicates Alternate Months

A	
ALADDIN Heating Corp.	*
AMERICAN Rubber Mfg. Co.	33
ANDERSON & Ringrose	46
B	
BASALT Rock Company	43
BAXTER & Company, J. H.	10
C	
CASSARETTO, John	48
CELOTEX Corp.	*
CLARK, N., & Son	*
CLINTON Construction Company	45
COATES, Leonard, Nurseries	46
COLUMBIA Steel Company	*
CROCKER First National Bank	47
D	
DINWIDDIE Construction Company	48
E	
EL ENCANTO Hotel	44
F	
FORDERER Cornice Works	45
FULLER, W. P., Co.	9
G	
GUNN, Carle & Company	8
H	
HANKS, Inc., Abbot A.	46
HAWS Drinking Faucet Company	2
HERRICK Iron Works	46
HOGAN Lumber Company	45
HUNT, Robert W., Company	47
HUNTER, Thos. B.	47
I	
IMPERIAL Brass Mfg. Co.	*
INCANDESCENT Supply Co.	46
INDEPENDENT Iron Works	46
J	
JENSEN & Son, G. P. W.	48
JOHNSON Company, S. T.	*
JUDSON Pacific Company	45
K	
KAWNEER Co.	Back Cover
KRAFTILE Company	8
M	
MATTOCK, A. F.	48
McCARTHY, Robert, Co.	2nd Cover
MULLEN Mfg. Co.	47
N	
NORTHERN California Electrical Bureau	11
P	
PACIFIC Coast Gas Association	7
PACIFIC Foundry Company, Ltd.	10
PACIFIC Manufacturing Company	44
PACIFIC Paint and Varnish Company	38
PACIFIC Portland Cement Company	11
PARAMOUNT Built-In Fixture Company	47
PARKER, K. E.	6
R	
REMILLARD-Dandini Co.	48
REPUBLIC Steel Corporation	44
S	
SALL Mountain Company	*
SIMONDS Machinery Company	44
SISALKRAFT Company	43
STANLEY Works, The	11
T	
TORMEY Company, The	47
U	
U. S. STEEL Company	*
V	
VERMONT Marble Company	43
W	
WASHINGTON - Eljer Company	*
WESTERN Asbestos Company	10
WOOD, E. K., Company	10
WAR Bonds	3rd Cover

Serving Western Industry

Insulation... for pipe, boilers and refrigeration
 Packings and Friction Materials
 Refractory Cements
 Corrugated Asbestos Roofing and Siding
 Acoustical Materials

ENGINEERS • CONTRACTORS • DISTRIBUTORS
WESTERN ASBESTOS CO.
Building Materials • Industrial Products
 OAKLAND • SACRAMENTO
 SAN FRANCISCO



QUALITY AND DEPENDABLE
Service

are the factors that influence architects and contractors when selecting lumber and mill work — Quality of merchandise — Integrity and Ability of the firm—Service in physical equipment — Experience and Personnel — All these factors contribute to a speedy and satisfactory completion of construction with minimum of time and expense.

MANUFACTURER OR DEALER IN

Douglas Fir—Redwood—Sugar and Ponderosa Pine — Plywood and Concrete Form Panels — Sash and Doors — Millwork — Insulation — Builders' Hardware.

E. K. WOOD LUMBER CO.

"Goods of the Woods" ©
 LOS ANGELES • SAN FRANCISCO • OAKLAND



PRESSURE TREATED LUMBER
 ● **PROTECTS AGAINST DECAY AND TERMITE ATTACK**

Specify it in your home Available through Lumber Dealers

LOS ANGELES SAN FRANCISCO
 601 W. 5th Street 333 Montgomery Street
 Phone Michigan 6294 Phone DOuglas 3883

J. H. Baxter & Co.

AGENTS FOR WEST COAST WOOD PRESERVING CO. SEATTLE WASH

CORROSIRON

MADE IN U.S.A.
 U. S. REGISTERED TRADE MARK

an acid resisting alloy for

Pumps • Valves • Chemical Coatings • Drain Pipe & Fittings

ARCHITECTS AND ENGINEERS ENGAGED IN WAR HOUSING AND POST-WAR PLANNING MAY CONSULT OUR ENGINEERING DEPARTMENT WITHOUT

OBLIGATION



PACIFIC FOUNDRY COMPANY LTD.
Engineers and Metallurgists

3100 - 19th Street
 SAN FRANCISCO

NEW YORK SAN FRANCISCO LOS ANGELES

BUILDINGS
to House the Base Command

The administration of our huge Military Forces is big business. Large staffs of officers and men are needed to do the mountainous "paper work", and their headquarters are BUILDINGS, at every base throughout the nation. Much of the hardware required for doors, windows, and cabinets is supplied by Stanley.

Stanley's already large production facilities have been stepped up, but the demand for this, and other war requirements is unceasing. The Stanley Works, New Britain, Connecticut.

STANLEY
HARDWARE

1843 **STANLEY** 1943

TEAMWORK for SECURITY

THERE IS NO SUBSTITUTE FOR A
HARDWALL PLASTER JOB
EMPIRE
GYPSUM PLASTER

STANDARD **RENO**
GYPSUM PLASTER GYPSUM PLASTER

PACIFIC
PORTLAND CEMENT COMPANY

FOR SOUND CONSTRUCTION

Use Electricity Wisely — Don't Waste It!

Electricity is vital to war production. Use it carefully and without waste. Check this light-saving list today:

- ✓ Clean bulbs and lamp reflector bowls frequently with soap and water. Dust can deprive you of as much as half your light.
- ✓ Avoid direct glare from lamp bulbs or bowl. Use shades that are deep enough and big enough.
- ✓ Use white-lined lamp shades. White reflects almost all light falling on it. Have the outside of your lampshade any color you please, but for light-thrift be sure that the inside of the shade is lined or painted white.
- ✓ Share the light—as well as the ride. Arrange furnishings so that at least two persons can use each lamp.
- ✓ Be sure to place lamps close enough for eye-comfort. Even a few inches farther away can mean fifty percent less light.

For additional wartime suggestions, send for the free booklet offered below.

**NORTHERN CALIFORNIA
ELECTRICAL BUREAU**

Northern California Electrical Bureau
1355 Market St., Dept. M-943
San Francisco, Calif.

Please send me your free booklet, "Lighting for the Home Front."

Name.....

Street.....

City..... State.....



ENTRANCE TO WILMINGTON HALL AUDITORIUM, LOS ANGELES

Seating 2,000 persons, this huge auditorium is merely a floor and semi-circular roof extended down to the foundations.

Thirteen Million Dollars for Housing 14,000 People

LOS ANGELES COMPLETES 5 LANHAM ACT PROJECTS

by HARRISON STEPHENS

The big job of building ships to win the war moved, in two years, something like 75,000 new industrial workers into three small towns edging the Los Angeles harbor. The city's greatest assignment in housing was created.

As the shipyards built so many ways they began to look like a giant picket fence around the whole waterfront, welders, riveters, ship-fitters, riggers, chippers, leadermen, burners, joiners, shipwrights, machinists, electricians and painters poured into San Pedro, Wilmington and Harbor City. Greenhorns and old hands, family men and bachelors, they all wanted a place to live.

Housing, already short in the closing months of 1941, became next to impossible to find after war boomed shipbuilding. Yet, according to official estimates, the number of industrial workers in the three towns, all part of Los Angeles, jumped from 20,000 to 96,000 after 1940. Thousands drove to the harbor daily from other parts of Los Angeles and nearby

towns, but thousands more had moved to their new jobs from other counties and other states. The efficiency of the shipyards depended on their finding places to live.

FIVE PROJECTS COST \$13,500,000

That is the background against which the Federal government took the stage to build in a few months enough public housing for more than 14,000 people. Thirteen and a half million dollars went into the building of five big projects, all of which are now occupied and all of which are managed for the duration of the war by the Housing Authority of the City of Los Angeles on agreement with the Federal Public Housing Authority.

The Housing Authority was already operating 10 permanent developments in Los Angeles which had been built as slum clearance, low rent projects but were turned over for the housing of war workers until the war's end. It was well organized to take over management of these five Lanham Act (from the Federal

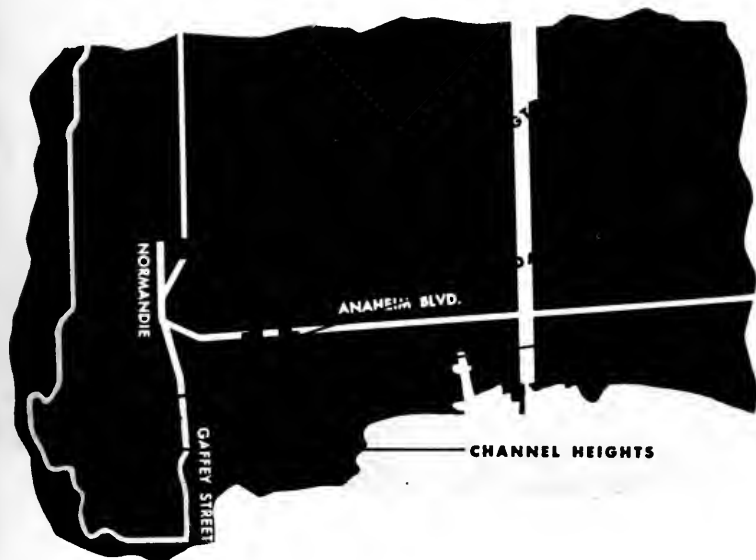
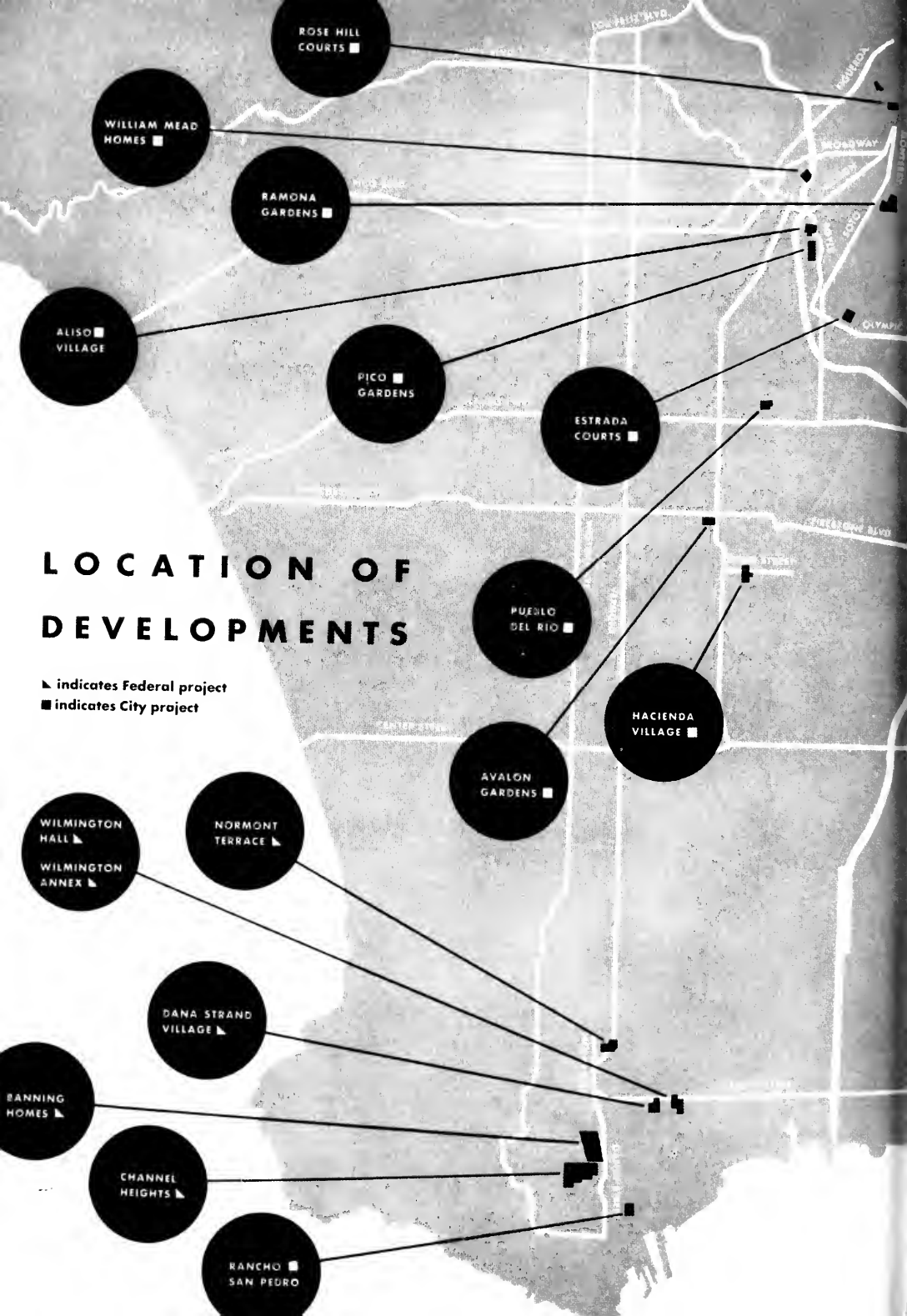

Diagram shows location of the five Federal financed war-housing projects in Los Angeles County.

All are being managed for the duration by the Housing Authority, City of Los Angeles.



LOCATION OF DEVELOPMENTS

▲ indicates Federal project
■ indicates City project

- ROSE HILL COURTS ■
- WILLIAM MEAD HOMES ■
- RAMONA GARDENS ■
- ALISO VILLAGE ■
- PICO GARDENS ■
- ESTRADA COURTS ■
- PUEBLO DEL RIO ■
- HACIENDA VILLAGE ■
- WILMINGTON HALL ▲
- WILMINGTON ANNEX ▲
- NORMONT TERRACE ▲
- DANA STRAND VILLAGE ▲
- BANNING HOMES ▲
- CHANNEL HEIGHTS ▲
- RANCHO SAN PEDRO ■

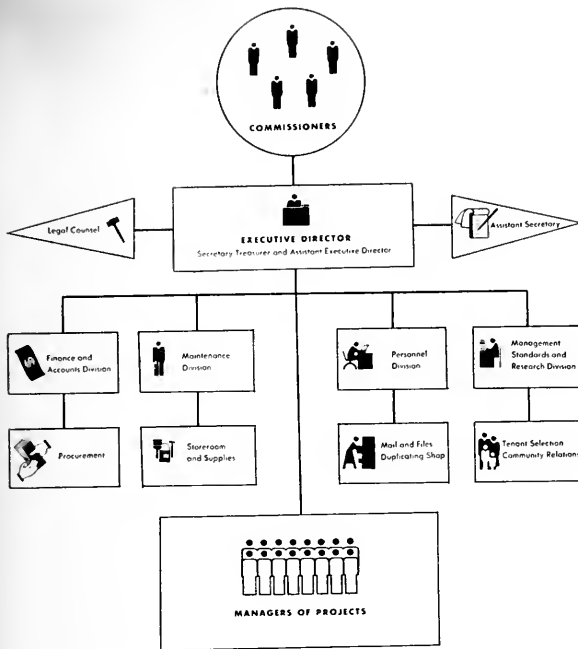

**ORGANIZATION CHART,
HOUSING AUTHORITY,
CITY OF LOS ANGELES**

Besides the five Lanham Act projects, illustrated, the Housing Authority is operating ten permanent developments built as slum clearance, low-rent projects, later turned over for the housing of war workers for the duration.

law appropriating money for such developments) and to handle construction of three of them.

The operating of war housing developments raised new, tough problems in both building and management and, according to Nicola Giulii, chairman of the Housing Authority, is proving an experience from which the Authority is learning valuable lessons in mass housing. No two developments are alike—they range from a huge dormitory for single men and women to a sprawling hillside project which may become a model mutual home ownership development after the war. They are expendable housing, some slated for sale to private bidders and others to be torn down when the war is over.

When war started, time was short and the need was great. The government began its harbor building program quickly. On February 23, 1942, Dana Strand Village and Nor-mont Terrace, both family type developments, went into the construction stage. Both were built by the Federal Works agency. On May

30 Wilmington Hall, a 1266-room dormitory-hotel, was started. Two days later building began on Channel Heights, a family project which was a sharp departure from all other developments in both building and plot design. Within another five weeks another 860 rooms for Wil-mington Hall were under construction and Ban-ning Homes, practically a complete city, was going up.

The local Housing Authority contracted with FPHA to build the last three developments, construction of which was supervised through-out by Walter G. Beck, construction assistant to Executive Director Howard L. Holtzendorff.

NEUTRA'S CHANNEL HEIGHTS

Probably the most interesting of the five is Channel Heights, which features the com-munity planning of Architect Richard J. Neu-tra. The site was a hilly, 150-acre plot of ground cut by one large ravine and several smaller ones. Neutra's plan was a super-block, park living layout of the sort he has studied for 10 years.

The result is a terraced development, with

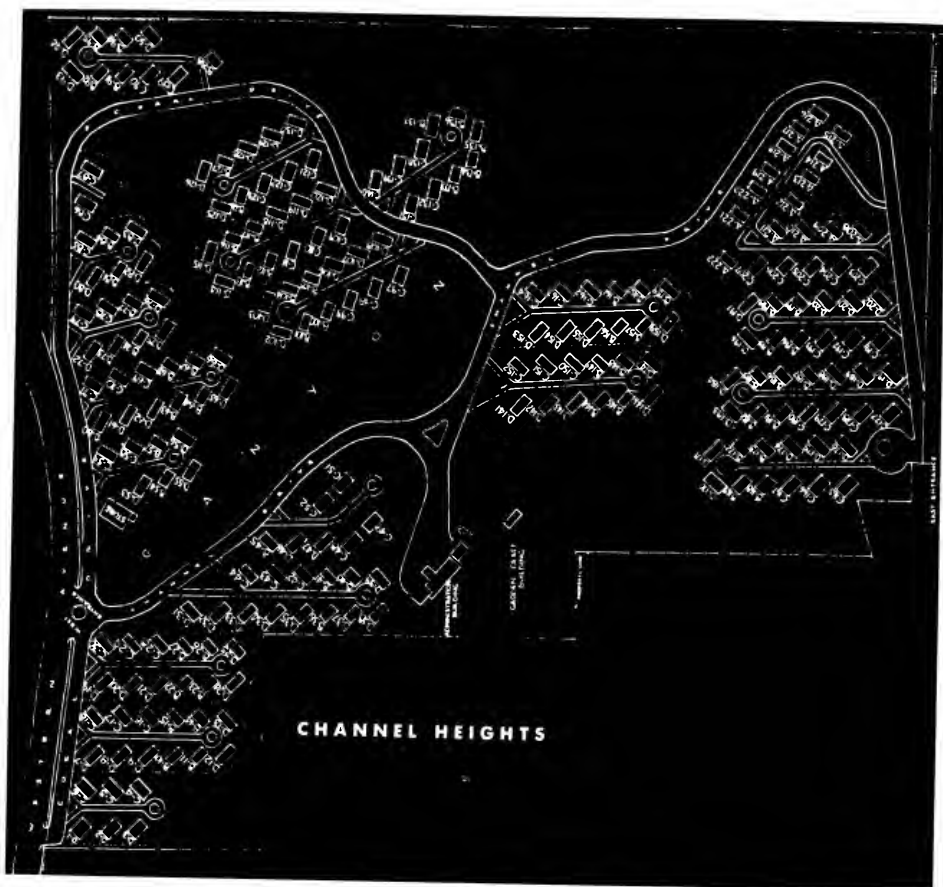

PLOT PLAN, CHANNEL HEIGHTS HOUSING DEVELOPMENT, LOS ANGELES
 Richard J. Neutra, Architect

every building on a separate elevation giving it a clear view of the whole harbor. A central park runs down the center and branches out into finger parks between each building. The 600 units are broken up into two and four apartment buildings instead of the heavier concentration usually found in mass housing. There are both one- and two-story buildings. One main road runs around the development but there are no through streets into it.

The apartments themselves are examples of Neutra's philosophy that the immediate surroundings of a home are as much a part of it as the interior. Large windows with a new type sliding sash allow much of one side of each living room to be moved away, making it almost part of the outdoors. Every two-story

building has a balcony for each apartment. Other highlights are big bedroom wardrobes, a large amount of shelf and storage space, roof insulation which is also the ceiling, and unusually spacious rooms.

Framework of the buildings was prefabricated. Exterior is a pleasant combination of plaster and redwood, with a contrast of brightly colored doors. Interior is stucco. Use of critical material was cut to a minimum with such things as plastic, pot metal and cast iron plumbing fixtures and all wood refrigerators.

The same "outdoor" planning that went into the apartments holds for the community buildings. Main parts are a 40 by 72 foot social hall and a nursery school. Both rooms have sliding partitions to make two rooms, and glass

COMMUNITY PLANNING AT CHANNEL HEIGHTS



Above: Typical one-story two-apartment unit.
Below (left): Detail of two-story, four-apartment unit;
(right): terraced development gives every building a harbor view.



sides slide away leaving the buildings open to the adjoining terrace. Covered porches nearly surround them. Besides these facilities there are a 9,000 square foot glass enclosed market building, a soft drink bar and small store.

BANNING'S WAR-TIME AUTO COURT

Banning Homes is almost the exact opposite of Channel. It is a duration city of more than 6,000 persons. Its 2,000 war apartments cover 156 acres of land—more than three times the number of dwelling units on a plot approximately the same size as that covered by Channel. Banning Homes has been termed a "war-time auto court."

Purpose back of the development was to furnish immigrant war workers, arriving in California with nothing but light luggage, everything they would need and the convenience that would be necessary with long hours at the shipyards and often both adults in a family working. First problem was location close to the shipyards. Clear land was available at the site finally chosen, but 350,000 yards of dirt had to be moved to level it for building. Gypsum board was selected as the chief building material and dwelling structures were designed to take standard sizes of the board for interior and exterior walls as well as ceilings. Lumber for framework was cut to standard lengths at the lumber yard. Three-foot wainscot of Masonite was included to protect the light gypsum board from damage. Factory finished floors were ordered to help speed the job.

Other non-criticals which went into the building were hot air ducts of plaster board to heat each building from oil furnaces, concrete oil storage tanks, plastic door knobs and faucet handles, concrete shower pans and wooden curtain rods. Water pipe was not available so 6,000 feet of used well casing was rounded up by a dealer in second hand oil well equipment, cleaned and turned over to the builders.

There are both one- and two-room apartments at Banning—for couples and for families up to four persons. Furnishings are complete. The whole project is built around five community buildings which contain practically every facility found in a small town. The big frame

and stucco structures house a gymnasium and auditorium for games, meetings, movies and dances, a 4,000-book library, market, barber and beauty shops, drug store, games room, coffee shop and complete infirmary. The health center is staffed by the California Physicians Service and 80 per cent of the residents pay a small monthly fee with their rent which gives them complete health services.

Families began moving into Banning Homes long before all buildings were completed, and the city began to pulsate life. Community church services were arranged, a nursery school program was developed, classes in nutrition, conversational Spanish, home nursing and civilian defense were set up, a Little Theater group was formed and volunteers joined a fire brigade to help man two engine companies placed on the development. Thirty-two acres of ground adjoining the project were leased by a resident organization for Victory gardens and some families have already harvested the first crop.

Architects William Allen and W. George Lutz were in charge of designing Banning Homes.

WILMINGTON HALL A DORMITORY CITY

Wilmington Hall is a dormitory with rooms for 3,000 war workers, plus special emphasis on community facilities to keep up the morale of the ship builders who live there. Its 67 buildings spread over nearly 40 acres of land. Besides the 2,126 double and single rooms, there are a theater and gymnasium building, music room, cafeteria, library, lounge, barber shop, laundry and cleaning shop, community store and infirmary, with a medical plan similar to that at Banning. A staff of 185 men and women gives complete hotel service.

The architect, Lewis Eugene Wilson, designed the place as a war baby throughout. Most of the buildings are walled with plywood—not a critical material at the time—with board siding on the outside. A single sheet of plywood does the job of both inside and outside walls in the community buildings where uncovered studs rib the exterior—and make an attractive design.

**BANNING WARTIME AUTO COURT
COVERS 156 ACRES**

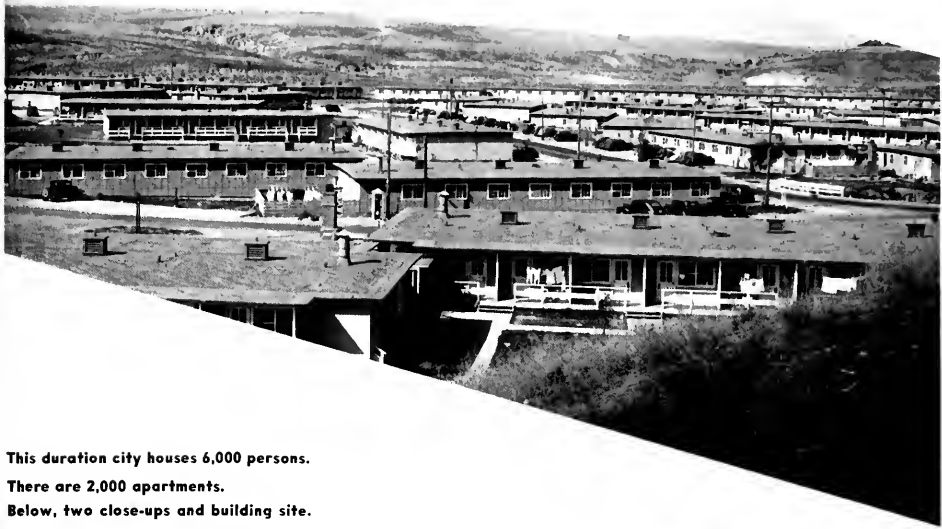

**This duration city houses 6,000 persons.
There are 2,000 apartments.
Below, two close-ups and building site.**





WILMINGTON HALL STRUCTURES WERE BUILT ON A JIG
Prefabricated sections up to 70 feet in length were hoisted into place and nailed together.



TEMPORARY DORMITORY, WILMINGTON HALL
Planned as a community center this development provides cafeteria, recreation, club rooms, library and health services.



**WILMINGTON HALL
LOUNGE**

Community facilities are emphasized to help maintain morale of 3,000 men working in the Wilmington-San Pedro shipyard area.

There are 2,126 double and single rooms provided in 67 buildings. A staff of 185 men and women gives complete hotel service.

Wilmington Hall structures were built on a jig. Cut to correct lengths at the lumber yard, wood for the framework was laid out on a template and prefabricated while the floors were being constructed. Then sections up to 70 feet in length were hoisted into place and nailed together.

The huge auditorium, 75 by 150 feet and able to seat 2,000 persons, is merely a floor and semi-circular roof which extends down to the foundations. It is held up by laminated arches—28 pieces of 7½ by ¾-inch board were glued together to make the curving timbers. The arches were delivered in half sections, bolted together at the top, hoisted into place with a gin pole and bolted at the foundations. About a quarter of the metal used in normal roof girder construction was necessary.

20 ACRES OF LAWN AT NORMONT

Space is the most characteristic feature of Normont Terrace. The 400-unit development is surrounded by 20 acres of lawn in addition to four play areas, a baseball diamond and volleyball court, and front and back yards for all units.

**BELOW: ENTRANCE TO WILMINGTON HALL ANNEX
VICTORY ROOMS**



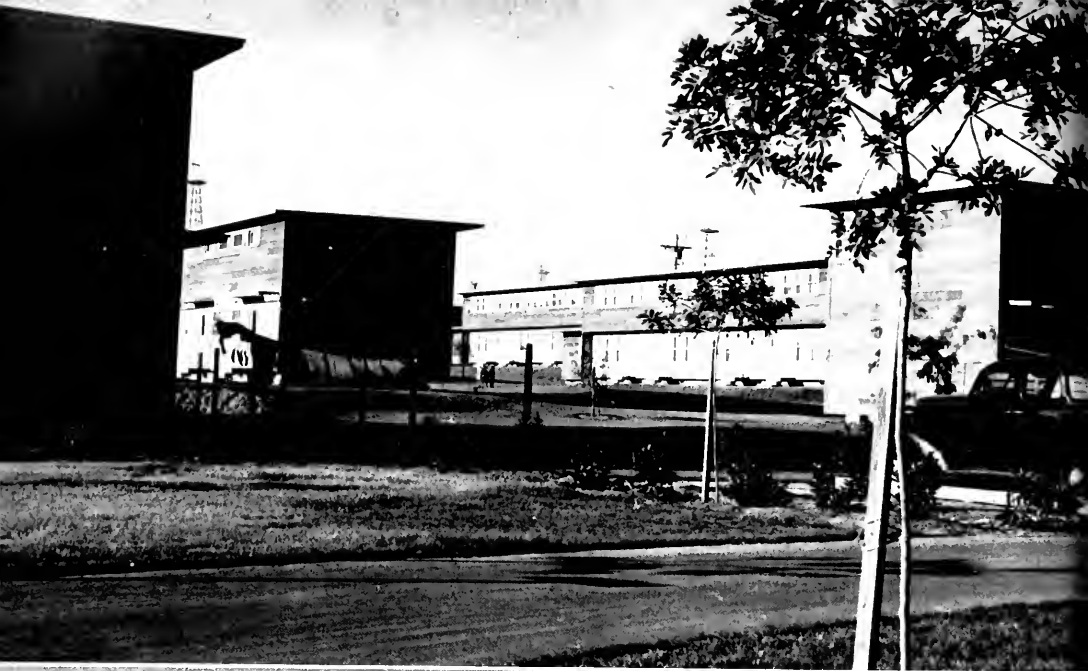



↑
**DANA
STRAND
VILLAGE**

Architects Winchton L. Risley and Stanley R. Gould designed the buildings to step up in increasing widths from the foundations. The first floor overhangs the foundation 10 inches on all four sides. The second floor overhangs the first by 27 inches and the flat roof juts out from this to shade the upstairs windows.

Light colored plaster on the exterior walls of the first floor is contrasted by redwood siding on the second story of every building. Interiors are finished in stucco. The war apart-

ments are one, two and three bedroom units.

One unusual time saver in construction was use of pre-formed front steps. Concrete was poured into forms for the steps, which were then set on the foundations.

Redwood community buildings feature a large social room for meetings and dances which holds 250 persons, and a nursery school. Nearly 2,000 people live on the development.

DANA STRAND VILLAGE

Dana Strand Village, a 384-unit develop-

←
**NORMONT
TERRACE**
**Two-story
family type
apartments.**

**DANA
STRAND
VILLAGE**
**A 384 unit
development.**





**"JUNGLE GYM." PART OF BAN-
NING'S PLAYGROUND EQUIPMENT.**
Note one-story studio type houses in
background.

Photo on right shows a typical studio
war apartment kitchen at Banning.



ment, was built on five city blocks in Wilmington. Architects George J. Adams and Graham Latta designed it to utilize existing streets as roads into five central parking lots, around which the buildings were grouped. A war housing ruling at that time that the entrance must be through the kitchen—to save extra sidewalks—was neatly handled by the designers. Large kitchens were planned for use as dining rooms as well, and the entrance is actually into the dining room portion of the room.

Several colors keep the two-story buildings from becoming monotonous, but the color planning is such that from any angle, all colors harmonize. The exterior plaster is painted various subdued shades of brown, coral and warm grey, while wood siding that makes up a portion of the exterior of some of the buildings is painted in several deeper tones. The whole color plan is tied together with the same trim throughout.

Like all other developments, Dana Strand has important recreational facilities. Six small play areas are scattered over the 21-acre plot, and

across the street is a community building with social hall and lounges as well as administrative offices. The development adjoins a public school playground.

As little critical material as possible was used in the construction—no metal went into termite protection, corner beads for plastering, range and under floor vents, hardwood for screens or roof flashing. To protect scarce screens against severe weathering of salt air, they were placed inside instead of outside the glass. Interior of the buildings is stucco and enameled plaster.

The war housing developments it manages for the duration, plus its own 10 permanent developments, give the L.A. Housing Authority 15 projects accommodating some 27,000 people. After the war the Lanham Act developments will be disposed of and the Authority will get back to the job of managing low rent, subsidized housing and probably an increasing program of slum clearance. But, for the duration, the important thing is to help win the war by providing homes for war workers and their families.

IF THE ARCHITECT LOSES HIS PUBLIC WILL ENGINEER REPLACE HIM?

(From The Federal Architect)

There has been a great deal of discussion in recent months upon the question that engineers have to some considerable extent come over into pastures held previously to be purely architectural. The engineering profession, it is held by many architects, aspires to do all the staff and control work in connection with designing and erecting buildings, calling on the architectural profession, as a subordinate to do the architecture.

We are not too much perturbed about that, while admitting that it is a possibility. If there was such a thing as an Engineer, combining all the functions of the broad scope of engineering in one person, we should be quite fearful.

But as a matter of fact the man who comes closest to having a full understanding of all the

types of engineering and their relationship to each other and to a building is the Architect.

To amplify that statement, we say in explanation that we never saw a mechanical engineer who looks upon a structural engineer with any seriousness. To the M. E. the S. E. is there to make it hard, putting beams where there should obviously be ducts and slabs where sanity dictates pipes. And a civil engineer, to the M. E., is just a sun-burned character who looks through a spy-glass and comes up with a wrong grade. So, while a M. E. could possibly coordinate engineering, he has never been educated for coordination.

The structural engineer considers the mechanical engineer and the sanitary engineer and the road engineer just playboys who, with

a little more patience and perseverance, might have progressed to be structural engineers. The structural engineers view the others as being in the tadpole stage of the profession, particularly the mechanical engineer, since it is elemental that water will run through a pipe and air through a duct.

But architects, while growling and grouching as is their nature, have learned through generations to evaluate the services and talents of the engineers. Nowhere in life do the various types of engineers get such wholehearted, though grudging, respect and admiration as from the architects. When an engineer says it's a 12-inch beam, it's a 12-inch beam, period, though the architect reserves the privilege of being dyspeptic and ill-tempered about it.

The architect is the coordinator, the staff strategist. He brings together all these engineering geniuses, growling all the time, but keeps fretting and tearing his hair until at length he coordinates engineering and architecture. At least he hopes.

We think engineers do not covet the architect's job of planning and coordination. The engineers we know are concerned too much with their trusses and their air-conditioning loads to want to take on over-all planning, to worry about seating-capacity and corridor circulation patterns.

Yet, if our diagnosis is correct, there is a certain section of the public that would like to give engineers rather than architects, plan and design control. Architects have unfortunately got themselves pretty well misunderstood in the past decade or so.

The curse of architects is that they are inarticulate. A long while ago the profession, after calm deliberation, became non-advertising. Unfortunately this was also taken to mean non-explanatory, the same as the medical profession which does not advertise. But as a profession it explains its progress and reasons for progress. Its X-ray technique, its drugs, its new anaesthetics all are brought to the attention of the world, as a public service. Educated people generally, therefore, have an understanding of the aims and viewpoint of the medical profession.

Not so architects. In the last twenty-five years the architectural profession took the most drastic step in its history, the most drastic step in the history of any profession. The architects cast aside the accumulated lore of their art, locked their books on the top shelf and started in to recreate their profession as practically a new vocation, insofar as outward and visible sign is concerned.

Whether that was aesthetically and socially wise is a question that has been argued and table-thumped for many years, without decision. The thing that, practically, was unwise about it was that it decided to come out as a modern profession unconnected with its past, without careful publicity preparation to apprise the public as to what was going to happen and why.

And thus the architectural profession lost its public. In changing its language, it made one fatal blunder. It failed to understand the nature of public appreciation of architecture. The public in general has no quick-changing reasoning, no mental appreciation of architecture. Its enjoyment of architecture is emotional, a good deal of it is deepseated, inherited through several generations, just as is their emotional ecstasy over green hills and valley and distant mountains. . . .

Who are architects that they alone may tell the public what to like, while all other creative genius listens breathlessly for the public's approval? The answer is that in that detachment of architects from the public lies the possibility of disaster.

The public are beginning to say now, indifferently and a little absent-mindedly, but they do say it, "We don't understand the product of these architects. We'll let **anyone** design our buildings."

We may be wrong in this attitude. We have been wrong before. But there are two facts. One, the architect went into his redesign status, without giving consideration to, or caring, whether the lay mind would like the new product. Two, the architect is, or is on the verge of, losing his public. Do these facts connect?

Editor's Note: Next month Louis La Beaume, F.A.I.A., discusses this timely subject under the heading, "Architectural Profession Needs a Voice."

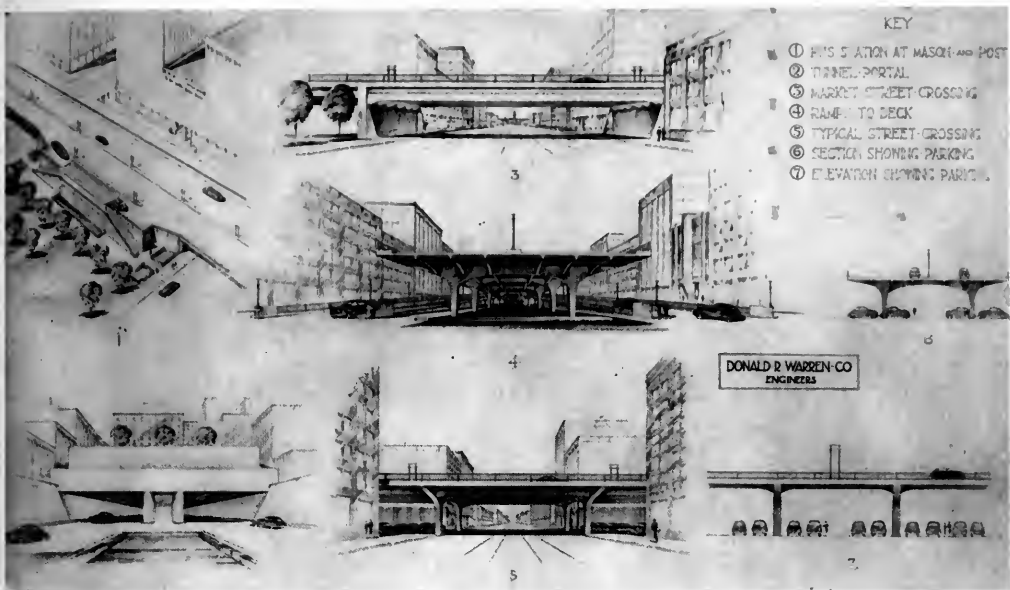

EL-WAY TO EASE SAN FRANCISCO TRAFFIC

by **FREDERICK HAMILTON**

INTENDED AS a post-war construction project and presenting a possible solution to the downtown traffic congestion of San Francisco, the Donald R. Warren Co., engineers, have designed and propose to build, if financial backing is assured, an "El-Way" consisting of a six-lane divided highway forming a loop about the heart of the city's business district. This loop circles the downtown area within a radius of one-half mile from the intersection of Kearny and Post Streets. The main loop has a total length of 15,000 feet, all of which is an elevated highway, with the exception of 2,100 feet of twin tunnels which extend from Grant Avenue to Bush, passing under Stockton, Powell, Sacramento, Mason, California and Pine Streets. To facilitate the movement of traffic, the "El-Way" has long sweeping curves and gentle grades. Ramps to and from the roadway are provided at various intervals for the convenience of traffic. Depots for public bus conveyances will be placed at various points with comfort stations and rest rooms adjacent.

The design of the structure considered both the roadway and the area below it, as each would have its influence on the general beauty of the city. Beneath this 88-foot wide "El-Way" provision has been made for parking 10,000 automobiles. The roadway has a division strip for its entire length, thus eliminating the great hazard of interference by traffic from the opposite direction. Five-foot emergency sidewalks with an ornamental rail will enhance the beauty of the structure.

To travel half-way around the "El-Way loop at thirty-five miles per hour will require but two and one-half minutes. A traffic study across the area embraced by the proposed "El-Way" was made on June 10, this year. At that time it was found that it took seven and three-fourths minutes to travel between First and Seventh Street on Market, eight minutes between California at Montgomery to Post and Taylor, and seven and three-fourths minutes from Sixth and Howard to Post and Taylor. The streets then were practically free of traffic, with the main interference being that of stop signals.

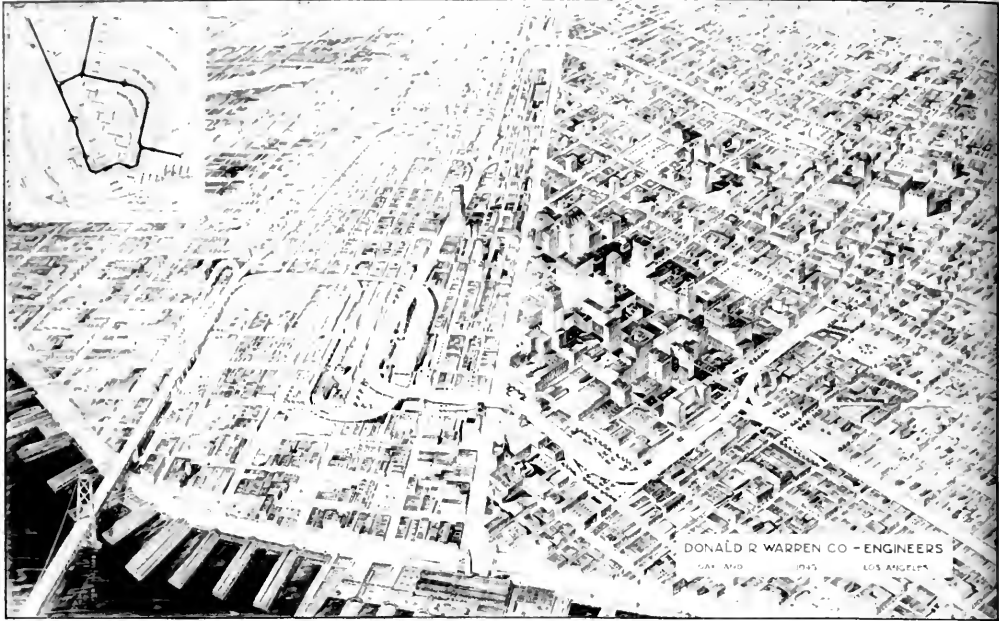

DRAWING SHOWS ROUTE OF PROPOSED EL-WAY THROUGH DOWNTOWN SECTION OF SAN FRANCISCO

The "El-Way" would provide for a free flow of traffic in excess of 70,000 motor vehicles daily, and is so located as to have ready access to the main streets and bridges contributing to the traffic arteries of the city. With its two miles of extensions and feeder ramps, it is estimated to cost thirty-five million dollars, fifteen million of which would be spent for the acquisition of right-of-way. At these times of gasoline rationing, traffic in downtown San Francisco is small compared with that of the past and only a small increment of that which may be expected in the post-war days. The traveling public ever now is spending in lost time alone, sufficient money, if capitalized at the rate of pay of common labor, to amortize a loan sufficient to pay for this "El-Way." In addition there is also the value and convenience of parking 10,000 auto-

mobiles beneath the structure which could readily be capitalized.

The project has not been sponsored by any civic or political group. The study and engineering work has been made by the engineers to contribute an idea for the relief and enhancement of the City of San Francisco to be used in the great construction program which necessarily must follow the day of Victory. However, there has been much moral support and many suggestions given by public-spirited individuals, who on the basis of a non-political and non-profit organization have united themselves as the Metropolitan Developers.

The Metropolitan Developers have elected to form a foundation to study from a purely engineering and economic standpoint those factors which by scientific solution may enhance the general flow of industry and commerce to the metropolitan areas.

ARCHITECTURAL USES FOR WEST COAST HEMLOCK

by R. T. TITUS*

IN rural Vermont they have a saying—"It takes a rough road to bring the big potatoes to the top of the barrel." Certainly war times provide sufficient "rough roads" to bring to the top, men, ideas and materials adequate to the emergency. This is the case of West Coast hemlock, a wood long considered by the lumber manufacturers of the Pacific Northwest as inferior to Douglas fir, the principal species of the region. This opinion was changed in 1942 when the war requirements for wood planes—trainers, gliders and transports, increased far beyond the possible production of Sitka spruce, the standard aircraft wood. After reviewing test data of the U. S. Forest Products Laboratory and other technical agencies, the Material Center Army Air Forces authorized the substitution of West Coast hemlock for Sitka spruce in airplane construction contracts.

Just as this wood proved itself suited to the exacting requirements of the aircraft industry, West Coast hemlock, through its performance, is convincing architects that it is a wood to be specified for many uses in homes, churches, schools and other structures.

The difference in the physical and mechanical properties of woods depends on the relative thickness of cell walls and the arrangement of the cells in relation to each other. The cell structure of West Coast hemlock gives it three very desirable qualities: uniform texture, a high strength-weight ratio and resilience. The wood is light in color, workably soft, strong, straight-grained and free from pitch or resin. Knots are usually small and sound, hence even the lowest grade sheathing makes a good nailing base for siding or roof covering. The wood nails firmly with strong resistance to splitting, saws smoothly and is light and easy to handle. For ordinary building purposes West Coast hemlock is equally as useful as Douglas fir.

Of the four species of hemlock native to the United States, West Coast or Western hemlock attains the largest size and has the greatest all-around value. The tree grows from Alaska to Northern California reaching its best development in Western Oregon, Washington and British Columbia where even temperatures and heavy rainfall are conducive to tree growth. While occasional trees have been found measuring as much as nine feet in diameter the average is two to four feet with a height of 200 to 225 feet. In extent of standing saw timber—115 billion board feet—West Coast hemlock is exceeded only by Douglas fir and ponderosa pine.

The even-growing, close-grained upland hemlock now being logged in the West Coast region, is producing logs with a large percentage of clear wood of a quality which is greatly superior to that of other species of hemlock with which it should never be confused.

FOR FLOORING AND PANELLING

Its hardness and uniformity of texture make West Coast hemlock particularly desirable for flooring. It has the unusual faculty of hardening with age and use. In vertical grain it is specified by architects for rooms in constant use. In school classrooms and halls, floors of

West Coast hemlock makes a "fast" gym floor.



* West Coast Lumbermen's Association.

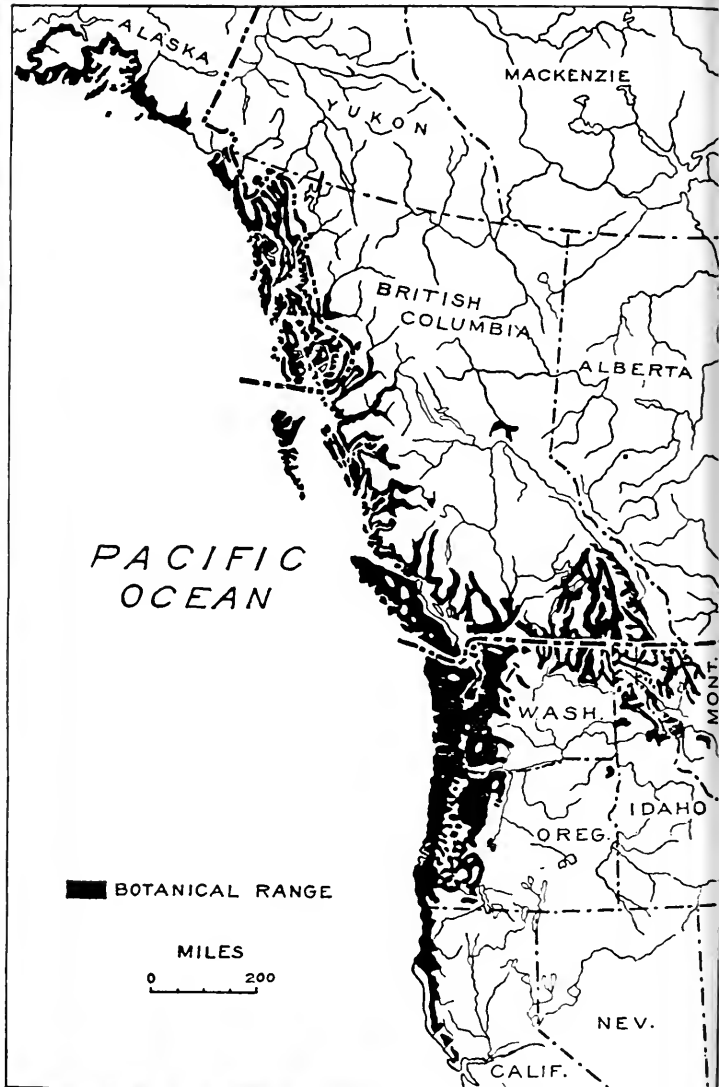

ABOVE: WHERE WEST COAST HEMLOCK GROWS

LEFT: MATURE TREE READY FOR HARVEST

LEFT: STAINED PANELING GIVES QUIET DIGNITY TO THE BOOK NOOK

ARCHITECT AND ENGINEER

West Coast hemlock endure years of scuffling feet; in the gymnasium their resiliency speeds the fastest game. They will not darken with age, and the ease with which their fine appearance is maintained is a continuing satisfaction. Flat grain flooring is recommended for rooms not subject to heavy wear or where the wood is to be covered.

Because it more closely resembles hardwoods in appearance than do most softwoods West Coast hemlock is popular for panelling. Its cells form patterns of bright beauty with an effect of depth. In homes, panels of natural finish make a perfect background for winter's formal draperies or summer's gay chintzes. In school rooms where light is needed, hemlock may be bleached to pale colors; in a church it may be stained to a deep candlelight-reflecting warmth. Simple sanding and clear waxing are a popular hemlock panel finish.

West Coast hemlock is specified for kitchen and service room cabinets; for shelving because it is strong enough to take heavy loads without sagging and because the wood has no taste or odor; for doors and drawers because it joints well, has little tendency to warp and is receptive to paints and enamels. The ease with which hemlock may be painted also recommends it for exterior siding in which it is available in a variety of patterns and sizes. Venetian blinds manufactured from vertical grain West Coast hemlock have been approved by the Federal Specifications Board—a distinction shared with only two other American woods.

SUITABLE FOR BUILT-IN FURNITURE

The qualities of strength, uniform texture, attractive grain and freedom from pitch, which make West Coast hemlock desirable for beautiful floors and interior finish make it suitable also for furniture, either detached or built-in. Breakfast-room, bedroom, and play room furniture of West Coast hemlock is now manufactured by some of the best factories on the Pacific Coast. Closely allied to furniture are various items of household equipment such as ladders. Spruce has long been known as the standard ladder material but West Coast hemlock is now taking over a large portion of this business and the American Standard Safety



West Coast hemlock siding lends beauty to a country home—



—or to a cottage in the city.



Dark stained treads and painted risers combined in a beautiful staircase of hemlock.

Code for Construction, Care and Use of Ladders sponsored by the National Safety Council provides that this species, along with a few others such as ash, may be used in dimensions five per cent less than those specified for spruce.

Scientists at the U. S. Forest Products Laboratory have studied and analyzed the properties of most native woods. The table below, taken from information supplied by the laboratory shows the relative strength of West Coast hemlock and other common construction woods:

SPECIES	Extreme Fiber in Bending	Compression Perpendicular to Grain	Compression Parallel to Grain	Maximum Horizontal Shear	Modulus of Elasticity
Cedar, western red	1,200	200	933	106	1,000,000
Douglas fir, coast region	2,000	325	1,466	120	1,600,000
Pine, southern yellow	2,000	325	1,466	146	1,600,000
Pine, Ponderosa and white	1,200	250	1,000	113	1,000,000
Spruce, Sitka	1,466	250	1,066	113	1,200,000
Hemlock, eastern	1,466	300	933	93	1,100,000
Hemlock, West Coast	1,733	300	1,200	100	1,400,000

(All values are in pounds per sq. inch)

Glued laminated construction is developing rapidly and the Forest Products Laboratory has made careful studies of the gluing properties of various woods. They have segregated our commercial woods into four groups, according to gluing properties, and have included West Coast hemlock in the first group along with Western red cedar, Sitka spruce, redwood and northern white pine, as a "wood that glues easily with different glues under a wide range of gluing conditions."

WCH HAS STRENGTH AND BEAUTY

West Coast hemlock is graded commercially for both strength and appearance. Choice of grades will depend upon the purpose intended. The Forest Products Laboratory has recently approved the 900#f and 1200#f (bending

stress) and 900#c and 700#c (compression stress) West Coast hemlock grades, adopted by West Coast Bureau of Lumber Grades and Inspection. The availability of stress grades in West Coast hemlock broadens the field of dependable materials for architects and engineers where lumber of definite known strength is required. For the ordinary frame structure joists, rafters, studs, sheathing and subflooring are selected from the construction grades: Select Merchantable, No. 1, No. 2 and No. 3. No. 1 is the preferred grade for joists, rafters and plates although the higher quality Select

Merchantable grade may be specified for the sake of appearance. No. 2 has ample strength for studs, plates, bridging and for floor or roof joists on short spans or in slightly larger sizes than No. 1. No. 3 is suitable for studs in 1-story walls and non-bearing partitions, and for laminated construction.

Select Merchantable and No. 1 boards are specified for subfloors and sheathing in first class construction; for concrete forms where a special finish is desired or where appearance is a factor. No. 2 boards have ample strength and satisfactory coverage for wall and roof sheathing and subflooring in the usual permanent construction; No. 3 boards may be used in low-cost or temporary building.

Flooring, paneling, finish and exterior siding are all selected from the clear or finish grades—"B&Btr.," "C" and "D." A limited amount of flooring is manufactured and graded as "Clear All Heart VG" for floors of highest quality where appearance warrants the premium which the grade commands. "B" and "Btr" grade is recommended for most purposes where natural finish is desired, "C" grade where stain or paint is to be used and "D" grade for low cost construction where some waste in cut-outs, or use of short lengths, is not objectionable.

Natural finish hemlock flooring reflects the sun's brilliance.

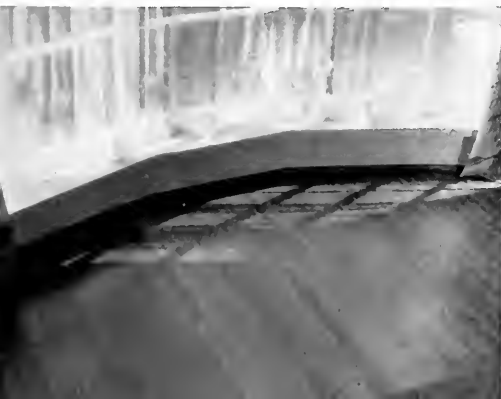

Heating Executive Denounces Post-War Ballyhoo

"Advertising budgets once used for the purpose of selling merchandise to the public may have to be applied widely in reverse to combat the wild and wierd dream-world products which uncontrolled and ill-advised publicity are creating today in the minds of Americans," according to Gordon Rieley, vice president of The Bryant Heater Company of Cleveland.

Backing up his belief that manufacturers in the automotive, aviation and building fields, as well as in his own industry, confront a problem demanding immediate action, Mr. Rieley already has assigned a portion of his company's advertising appropriation to the purpose of straightening the thinking of a misguided public.

A recent Bryant advertisement appearing in Newsweek and captioned "Speaking of the Shape of Things to Come," illustrates a scholarly looking old gentleman pointing seriously to a blackboard on which he has drawn an action diagram which rivals some of Rube Goldberg's best classics. The copy begins: "Hold everything, Horatio! It's a bit early, don't you think, to predict the heating of homes by captive heat waves? Or furnaces fed by radio beam?" The copy continues by explaining how there will be new, improved heating for postwar homes, but produced by "sensible, down-to-earth engineering," and outlines what Bryant is planning in this respect.

Admitting that most business men realize the cars which will come off the assembly lines of automobile manufacturers at the war's conclusion will be the 1942 models which were halted soon after first deliveries, Mr. Rieley expressed the opinion that the man-on-the-street still thinks he will get an ultra-streamlined teardrop, ready to travel at 100 miles an hour on the super highways which supposedly will be built to accommodate such traffic. Other popular public conceptions created by unwise publicity and which came in for criticism by Mr. Rieley were the "helicopter in every backyard," and the radically futuristic "home of tomorrow."

"Certainly, there will be progress in aviation," he said, "and Americans will fly more than we would have imagined even a scant two years ago. However, there will not be a helicopter ready for every family to buy and fly away the day after peace is made, nor will those available be in the price range of low-cost prewar automobiles as so many Americans now imagine.

"There will be new homes built by the thousands in the postwar period, but few of the 'home from Mars' designs which have received such widespread and careless publicity," Mr. Rieley continued. He emphasized the fact that there will be a considerable amount of low-cost housing and that these radically different homes could not be produced except at excessive cost.

Builders, themselves, were quoted as unalterably opposed to the current ballyhoo and firm in their intentions to continue building to the designs of prewar days, with certain improvements which can be made without skyrocketing building costs.

In his own field of heating, the Bryant executive found room for criticism in the stories circulated regarding developments which are far from ready for public use. He regarded as too costly the general application of district heating by which an entire area of homes would be supplied by a central heating plant. It is his opinion that heating of buildings with electrical energy stored during off-peak hours is a method on which much study is needed before it can become practical.

"None of us want to stand in the way of progress," concluded Mr. Rieley. "None of us want to delay any longer than necessary giving to Americans the better things that only American genius can and will provide. However, unless we more intelligently use the powers of advertising and publicity which, in the past have served us so well, we will discover Mr. and Mrs. America demanding and expecting us to deliver merchandise that not even Superman could produce."



Lightning Hose Rack, Plate 2, supported from wall, steel girder, wooden or concrete column. Carries linen hose.

Lightning Hose Racks

—and Lightning Fire Hose Cabinets are designed and made to enable the architect to plan the utmost in fire protection for his clients. Write for details, together with plans and specifications.

The

AMERICAN RUBBER

Factory and General Offices: **Manufacturing Co.**
Park Avenue and Watts Street, Oakland, 8, California

HOUSE A DAY

Record Building Achievement of Robert McCarthy

From a six-million-dollar housing job to one that totals thirty-five thousand makes little difference to Robert McCarthy, San Francisco contractor, in so far as speed goes.

To demonstrate speed, McCarthy put up a single 88-bed dormitory building in the San Francisco Civic Center for the accommodation of enlisted men on leave. The building was started in the morning and ten hours later, the same day, it was ready for occupancy, complete with showers, electric lights and painted. It was a gift to the city from Robert McCarthy and demonstrated that Mayor Rossi's long desire to provide such accommodations for our armed forces was a simple undertaking.

The Mayor was so elated that he asked the city

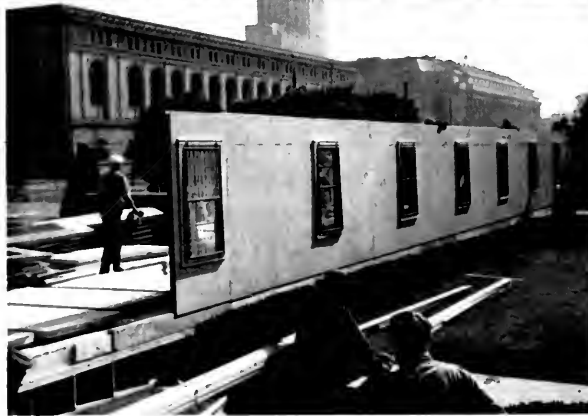

supervisors for money with which to build five more buildings.

Although McCarthy donated the first dormitory he had to bid in the usual way for the five other buildings. He not only was the lowest bidder by several thousands of dollars but he guaranteed to complete the job in six working days, against a time of 30 to 60 days by the other contractors. McCarthy's bid for the five buildings was \$34,600, complete in every detail excepting for the beds which were furnished by the city.

Each building is 112 feet long by 24 feet wide. The usual type of prefabricated sections was used for the floors and walls. Wall sections were constructed of plywood, glued and nailed on 2x3 studs having cross-bracing, with door or window openings where specified. These wall sections arrived on the job with window casements already in place and were of the double-wall type providing "dead" air space for insulation. Roofs are pitched and covered with green mineral-surface roofing paper. Inside, the ceilings are of plywood nailed on horizontal beams. The first coat of paint was sprayed on at the mill and the second coat, of cream-color plus turquoise trim, was hand-brushed after carpenters moved along.

The foundations are of the mud-sill type resting right on the gravel walks, which happened to be in the right places and of the right width so that all buildings could be placed in the Civic Center without so much as moving a plant or trimming a single tree.



Shower and wash facilities are provided so that our men at a time can use any of these respective conveniences which are provided in one large room at the end of each floor where there are also a separate bed room for an attendant and a large closet for linen storage.

Four of the buildings are of one floor and two are of two floors with all of the plans identical excepting where an interior stairway leads to the second story. In all, accommodations are provided for 704 persons; each will be charged 50 cents per night.

Construction of the five additional buildings started August 16 and finished five days later, one full day ahead of schedule.

During the last two years the Robert McCarthy Company has built about \$20,000,000 worth of Government housing. This includes 1,700 four or five-room separate prefabricated dwellings in Vallejo, 332 permanent prefabricated dwellings in Sacramento for Government airport employees, 5,800 war-apartment units in Richmond, 500 war apartments in Alameda, the alien evacuee center at Tanforan race track, housing along the Alcan Highway and some "military secret" jobs for the Army.

One of the outstanding characteristics of Robert McCarthy is his ability to slash through red tape, even during these days of "priorities", obtain all necessary material rapidly and get the jobs done ahead of schedule.

The large picture is a general view of completed project. Other views are progress photos, except lower right which shows Robert McCarthy (left), Eneas Kane, Secretary to Mayor Rossi, holding copy of Architect and Engineer (center), and Joseph McCann, Inspector of Police.

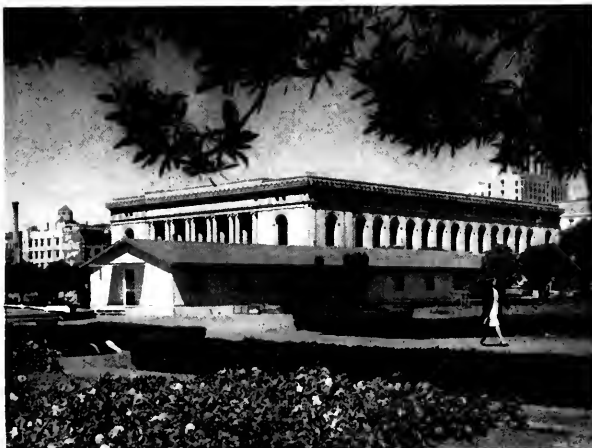

WHAT SAN FRANCISCO ARCHITECTS ARE DOING

MORE
EAST
BAY
WAR
HOUSING

Construction of more than 1,000 new war housing units has been authorized by the Federal Public Housing Agency in Berkeley and Albany. The projects will be financed under an appropriation of approximately \$6,500,000. Plans call for leasing the 42-acre Gill tract from the University of California. Fringing the Richmond Shipyard Railway the tract is almost opposite the abandoned Albany racetrack.

Another housing project for shipworkers and costing \$250,000, is being handled by J. M. Walker, Berkeley speculative contractor. There will be 25 apartment buildings located in the vicinity of Dwight Way and Sacramento Street.

A \$2,500,000 housing project in Alameda has been awarded F. C. Stolte, local contractor. Besides 1,640 temporary dwelling units there will be a community building and two nurseries for the care of war workers' children.

BLANCHARD,
MAHER &
WARD

Blanchard, Maher & Ward, 369 Pine Street, San Francisco, have two projects for the Home Owners' Loan Corp., consisting of apartment remodeling for war workers at Belmont and a similar job at 2014 Channing Way, Berkeley. . . . Preliminary drawings are in progress in the same office for 320 family dwelling units for the Federal Housing Authority at Eureka, Humboldt County.

Plans have been prepared in the office of Theo. C. Bernard and James D. Wickenden, 402 Jackson Street, San Francisco, for 60 dormitory and 20 family units for the San Luis Obispo Housing Authority.

A contract has been let to the John J. Moore Company of Oakland for the construction of a one-story brick office and factory building for the Kear Engineering Company of Palo Alto, from plans by R. H. Cooley, structural engineer.

PLUMAS
COUNTY
PROJECT

Leonard F. Starks, Sacramento architect, who now maintains a San Francisco office in the Monadnock Building, has been commissioned to prepare plans for 40 family dwelling units at Chester, Plumas County, for the Federal Public Housing Authority.

David H. Horn, Claremont Hotel, Berkeley, has completed plans and received construction bids for 500 dormitory units in Vallejo, Solano County, for the Housing Authority, City of Vallejo.

L. H. Nishkian, 155 Sansome Street, San Francisco, has completed plans for a \$60,000 grammar school building at Stege. Bids have been taken by the Federal Works Agency, War Public Works Division, 2223 Fulton Street, Berkeley. Mr. Nishkian's office also prepared the plans for a \$60,000 grammar school to be built in the Pullman District, Richmond.

NEVADA
DWELLING
UNITS

H. Rafael Lake, 320 Market Street, San Francisco, and Claremont Hotel, Berkeley, has working drawings practically completed for 20 family dwelling units and 55 dormitories for Carlin, Nevada, financed by the Federal Public Housing Authority.

Recent housing projects authorized by the Federal Public Housing Authority, 785 Market Street, San Francisco, include 60 dormitory units at Sparks, Nevada, DeLongchamps & O'Brien, architects; 40 family dwellings and 20 dormitories at Riverbank, California, Russell G. De Lappe, architect, and 1,000 apartment units at Rodeo, E. Geoffrey Bangs, K. O. Narbett and E. T. Spencer, architects.

FROM
HOTEL
TO
APARTMENTS

Architect Albert F. Roller, 1 Montgomery Street, San Francisco, has completed drawings and awarded a contract for remodeling the hotel building at 1101 Polk Street, San Francisco, into 19 apartments for war workers. The Home Owners Loan Corp. has authorized expenditure of \$37,000 for making the conversion.

The Housing Authority, City of Richmond, has selected the following architects to design housing projects at locations to be determined, the improvements to consist of 3,000 family units for war workers: A. F. Roller, K. O. Narbett, Miller & Warnecke, E. G. Bangs, F. H. Reimers, L. F. Starks and Ed Musson Sharpe.

ARCHITECTS' BULLETIN

Issued For

THE STATE ASSOCIATION OF CALIFORNIA ARCHITECTS
Northern Section

EDITOR OF BULLETIN

William C. Ambrose

Address all communications for publication in the Bulletin to W. C. Ambrose, 369 Pine Street, San Francisco.

STATE ASSOCIATION OFFICERS

Office of Northern Association
369 Pine Street, San Francisco

Officers

President.....Walter R. Hagedohm, Los Angeles
Vice-Pres.....Norman K. Blanchard, San Francisco
Secretary.....Hervey Parke Clark, San Francisco
Treasurer.....George E. Gable, Los Angeles

Southern Section Officers

President.....Walter R. Hagedohm, Los Angeles
Vice-President.....E. Allan Sheet, Los Angeles
Secretary.....Rowland H. Crawford, Beverly Hills
Treasurer.....George E. Gable, Los Angeles

Northern Section Officers and Directors

President.....Norman K. Blanchard, San Francisco
Vice-President.....Russell G. deLappe, San Francisco
Secretary.....Hervey Parke Clark, San Francisco
Treasurer.....David H. Horn, Berkeley
Directors: John S. Bolles, Ross; Andrew T. Hass, San Francisco; H. H. Gutterson, Berkeley; Vincent G. Roney, San Francisco; Frederick H. Reimers, San Francisco; Malcolm D. Reynolds, Oakland; J. Francis Ward, San Francisco, and Alfred C. Williams, San Francisco.

Northern Section Advisory Council

San Francisco District No. 1, J. Francis Ward; East Bay District No. 2 Irwin M. Johnson; Berkeley District No. 3, John K. Ballantine, Jr.; North Bay District No. 3, C. A. Caulkins; Marin District No. 5, John S. Bolles; Lower San Joaquin District No. 6, Frank V. Mayo; Upper San Joaquin District No. 7, Philip S. Buckingham; Santa Clara District No. 8, Ralph Wyckoff; Palo Alto District No. 9, Elizabeth Boyter; San Mateo District No. 10, Leo J. Sharps; Sacramento District No. 11, Harry J. Devine; Upper Sacramento District No. 12, Fred J. deLongchamps; Lassen District No. 13, Ralph D. Taylor; Monterey District No. 14, Charles E. Butner, and Redwood Empire District No. 15, Franklin T. Georgeson.

Northern Section Standing Committees

Legislative Committee.....Vincent G. Roney
Public Relations Committee.....J. Francis Ward
Building Industry Committee.....Hervey Parke Clark
Convention Program Committee.....Edgar Bissantz
Post-War Reconstruction Com.....J. Francis Ward
Membership Committee.....John S. Bolles
Building Industry Directory.....Russell G. deLappe
Policy Committee.....Russell G. deLappe

ARE YOU A "LITTLE AUDREY"

Do you know what YOU are going to do for the first year after the war is over? The answer is, fortunately for many people, "No!" We hope for the best. If we could foretell the future, hope would be out of our life picture, and the suicide rate would be very high. But hope, as a foundation for our future actions, needs a considerable reinforcing—its crushing strength is rather low. The only picture which we remember having seen of "Hope" was of a filmy female draped languidly over a globe.

The conclusion seems inevitable that, for the first year after the war, and for all of the rest of the years, Hope is just a nice gal to cheer us on our way. So with Hope as a supercargo, it seems that our voyage into the future will be on the same ship of Blood, Sweat and Tears as is carrying us through the war, with perhaps a little less emphasis on the blood and tears.

We are encouraged because the realists of the country are making themselves increasingly heard and felt. Indications are that a considerable group of people in this nation are not depending upon a wing and a prayer to get us back upon a peace time economy. For the first few months after the turn of the tide of war, and when the first echoes of post-war planning were being heard, the idea seemed to be that all that was necessary to assure full employment and an orderly transition to peace after the war was for a list of desirable work projects to be compiled. Then—Presto! The ten million sons of William Jennings Bryan's million men who were to "spring to arms over-night" would be gainfully employed.

Then some few, whose eyes were not blinded by star-dust, started hammering home the fact that, until the key was turned in the door, access was barred to the accumulation of work which was potentially available. The key, it is now becoming generally realized, is made of definite plans and specifications for the actual performance of the post-war work. It is becoming recognized that one can not build a building or a highway until he has money and land available and some rather definite documents with which to commence work. That is, one can not unless he doesn't care how much of a dollar's worth an expenditure of 100 cents will provide.

It now appears that we are entering the second stage of planning for the post-war struggle. The lists of projects are on their way, and, here and there, beginnings are being made on the process of translating "swell ideas" to tracing paper and mimeograph. But the parade has only started. It is now up to the architects and the engineers to prod their executive friends and their public legislators so that funds may be available and that definite planning work may be started now. To wait for the second step until the war is over means the birth of a new brother to the unlamented WPA. The new brother is not welcome under whatever set of initials.

Another W. P. A.?

A most vigorous boost to the public understanding of the necessity for definite planning was given by the nation-wide broadcast of the American Forum of the Air on August 19th, last. The subject was "Shall We Have Another WPA After the War?" The participants in the discussion included Representative Lynch, who has introduced legislation in Congress appropriating funds for the preparation of plans for public works to be built after the war; General Fleming of the Federal Works Agency; Walter R. MacCornack, Vice-President of the A.J.A.; Colonel Seabury of the A.C.E.A., and a representative of the General Contractors Association.

It was brought out very forcibly that, with the completion of the major construction of our war plants, there is now a large force of trained and competent architects and engineers available and eager for the definite planning of work to be constructed as soon as the war is over. A point which should be reassuring to those considering appropriations for getting actual plans under way is that provision planned in congressional appropriations, for the reimbursement of political sub-divisions which start plans now on post-war projects so that those sub-divisions will not be at a financial disadvantage as far as the cost of plans is concerned, in comparison with those who delay the starting of plans until the appropriations have been made actually available.

A valuable pamphlet is also now being distributed by the Chamber of Commerce of the United States, Washington, D.C., entitled "Plan Now For Future Public Works." It is a comprehensive review of the subject and puts special emphasis on the necessity of the efforts of each individual to get projects past the listing stage, and to do it now.

Post-War Changes Will Be Sudden

Just how many months will be given us to get ready for the post-war construction upon which the country has put high hopes for re-employment no one can tell. But our previous experience tells us that the change will be sudden.

You will remember that Little Audrey stood on the street corner, all dressed up, waiting for the Boy Friend, and stood and stood there for a long time—then she began to laugh and laugh. For she didn't have any Boy Friend. Perhaps she laughed because she realized that, nowadays, it takes more than hope to get a Boy Friend. And it takes more than hope to get our post-war industry under way.



NORTHERN AND SOUTHERN CALIFORNIA CHAPTER MEETINGS FOR AUGUST

The Northern California Chapter of the American Institute of Architects held their regular monthly meeting for August at the Alexander Hamilton Hotel, Tuesday, August 31, at 6:30 p.m., President Eldridge T. Spencer, presiding.

Members present: J. H. Devitt, J. H. Mitchell, S. Willard, L. A. Kruse, R. I. Stringham, E. T. Spencer, J. D. Young, H. H. Gutterson, I. F. Morrow, J. Bakewell, H. P. Clarke, D. Horn, I. Johnson and R. Pollack.

The minutes of the previous meeting were approved as published.

John Bakewell gave a stimulating account of the recent Institute Convention at Cincinnati, including a graphic description of the planning and presentation of the Convention Hotel—you should have heard it.

Henry Gutterson, Regional Director of the A.I.A., recited several interesting items on what is going on back of the scenes in the Institute and evidently there is plenty of activity, what with a newly streamlined membership drive and Post-War Planning Committee measures.

Getting close to home, considerable constructive discussion centered around a recent release from the Regional Office of the F.P.H.A., regarding Architects and Engineers.

A petition to Mayor Rossi of San Francisco, deploring and imploring, and having to do with the whole episode centering around the recent changes in the San Francisco Housing Authority, occupied a lively half hour. The petition in its final form should be out soon.

SOUTHERN CALIFORNIA CHAPTER, A. I. A.

As noted in last month's issue Southern California Chapter's August meeting was given over largely to a discussion of prefabrication and its implications. To relieve the tension some of the members put on a humorous skit entitled "Life is Great in a Prefabricate," the cast being made up of Welton D. Beckett, Carleton Winslow, J. E. Trudeau and Walter Steyer. The playlet was written by Theodore Criley, Jr., and Warren E. Hoyt.

(Turn to page 43)

PACIFIC PAINT & VARNISH CO.

A Paint or Varnish Product for Every Purpose

SAN FRANCISCO
Sales Office

BERKELEY
Factory

LOS ANGELES
Sales Office

PRODUCERS' COUNCIL PAGE

Northern California Chapter

The National Organization of Manufacturers of Quality Building Materials and Equipment
Affiliated with the AMERICAN INSTITUTE OF ARCHTECTS



F. K. "KEN" PINNEY
—he paid the piper.

Past-President F. K. "Ken" Pinney was as busy as a pair of Siamese twins in a bathtub when he was Secretary - Treasurer of the Northern California Chapter, P. C., way back in 1933. In those black days the treasurer frequently had to dig down in his jeans and advance the Club finances.

Ken must have done a swell job, because he was elected Vice-President and later President in 1939. And today Ken ably functions as Chairman of the Post-war Planning Committee.

Since 1928, Ken has been with the Armstrong Cork Company. In 1936 he was named San Francisco District Manager for the Building Materials Division of Armstrong. Ken is an alumnus of Pomona College. (P.S.—Robert Taylor went there too!) Rumor is that his track record . . . sprinting . . . helped him catch his charming wife, a Texan. The Pinneys, including an extra-cute daughter, are residents of San Francisco.

13 a Lucky Number? Our September 13th meeting with the American Institute of Architects brought to mind the interesting joint meeting held with the American Society of Military Engineers on May 13th. The A.I.A. and Producers' Council members swapped post-war planning ideas, and the Council's position in all the present welter of planning was explained. Westinghouse Electric gave the Architects and Producers a quick glimpse into the future of Electronics.

The A.I.A. Chapter requested that the dinner be "Dutch treat." The dinner ended on the note of good-fellowship that always characterizes relations between the Chapter and the Architects and Engineers.

Looking Back to August 2, we had an interesting talk by Norman Brown of Bell and Gossett. At this regular monthly luncheon, Vice-President Horace Pickett presided . . . he's been doing a first-rate job keeping the ball rolling throughout the summer. Bob Telfer gave an extemporaneous and humorous dissertation on "Doors." Bob was pinch-hitter on the spot reserved for The Peele Co.

October Meeting. . . . Program Chairman Bob Telfer announces that Ray Brown, of Gladding McBean & Co. will talk at our October 4th meeting. Motion

pictures by International Nickel will be presented by Hal Heakin of Pacific Foundry.

Jingle Bells will be heard on **December 7**, when the annual Xmas Jinks will be staged. The date is no mistake . . . from where we're standing it looks like we'll have something to really celebrate this year!

Fellowship Chairman "Nick" Nicholas has been given the nod by the Executive Committee to start planning for the annual holiday event. This year, again, the emphasis will be on informality, good-fellowship and simplicity. The Engineers Club will again be the scene of the festivities.

"Some of These Days" is the title of a sad song you might be singing if you lose sight of the fact that "post-war planning" will cease to be such one of these days. And when that time rolls around what will you be looking for? That's an easy one to answer . . . prospects and jobs! And as salesmen, we won't be expecting anybody else to do that job for us. Brought down to the level of the individual architect and producer, that's just what post-war planning is. In plain English, the time is ripe to keep a few extra eggs in the wartime nest for peace-time use. Why not line up those future peace-time jobs now?

Here's the Trouble. American life has become so highly organized, industrially and socially, that we've come to think that organization alone will handle post-war planning. But for peace-time planning, that old phrase, "individual initiative," is the only reliable element that will bring definite results.

It's Later Than You Think. After this issue, it might be too late to discuss the generalities of post-war planning. Unless you're out there pitching **right now**, you might find yourself fishing behind the net in the very, very near future!

Here's an Outfit That's Really Plugging. Detroit Steel Products are really doing something about post-war planning. Their advertising has struck out boldly to talk about definite jobs after V-Day. They're tying in their ad campaign with some of the Council's post-war objectives. C. R. Raquet, Vice-President at Detroit Steel, has announced the opening gun of an ad campaign to break with a national drive with the theme "Start an Architect on a Plan Now!" First ad in this series appeared in a July number of Newsweek. Others are scheduled for architectural media.

The "Work Pile Plan" of the San Francisco Chamber of Commerce is another campaign worth your attention.

(Turn to next page, 3d column)

USE QUALITY PRODUCTS



CONSULT AN ARCHITECT

The Month's Digest of New Building Products

All of the literature described here is available to architects, engineers, contractors, draftsmen and specification writers upon request direct to the manufacturers.

WOOD ROOF VENTILATOR—A new wood ventilator known as the "Air-X-Hauser" has been introduced by G. C. Breidert Co., 634 So. Spring Street, Los Angeles, represents a new principal in design. Wind striking it at any angle sets up a suction action which exhausts the inside air. The ventilator has no moving parts, is made of kiln-dried wood, and is treated with wood preservative. Tongue and groove construction uses few nails. Complete details can be obtained by writing the manufacturer.

DRAFTING AID—A new method of attaching drawings and blueprints to drawing boards, which eliminates the necessity of moving the T-Square over thumbtack heads, is the use of Kum-Kleen stickers. The stickers are paper thin, will lie flat, are applied without moistening, and are easily peeled off without affecting the surfaces to which they are attached. All of the adhesive remains on the label. Kum-Kleen stickers come in a variety of sizes and shapes, are made by Avery Adhesives, 451 E. Third Street, Los Angeles.

WOOD GRILLE—A rolling wood grille which uses wood bars strung on light steel tapes operating up and down on wood guides, coils overhead on a horizontal counterbalancing shaft, is the product of Cornell Iron Works, Inc., 36th Ave. at 13th Street, Long Island City, New York. The grille can be fabricated for opening widths up to 19 feet, with opening heights unlimited. Operation is either push up or, for large sizes, move by hand chain or electric motor. It locks into the side guide with a padlock and hasp on the bottom bar.

PLASTIC FLOAT—Kirkhill, Inc., 6828 McKinley Ave., Los Angeles, has introduced a plastic toilet float to replace the copper ones that were manufactured prior to the government regulations. The float sells for less than \$1 and measures 4x5". It is made of crystal-clear Lumarith and is impervious to water, non-corrosive, and has a tensile strength up to 14,600 pounds per square inch. The float is reinforced at the spud where strength is needed.

REDWOOD PLASTICS—A non-critical phenolic type thermoplastic perfected from the phlobaphenic structures of the Redwoods, is now available in abundant quantities for both war and civilian production of countless items formerly manufactured from hard rubber and other thermosetting plastic compounds. The redwood plastic embodies in one composite form both resin and filler employed in the molding of an endless variety of products. It is readily adaptable to either compression molding or the standard equipment of hard rubber plants. When special properties are desired, it can be mixed easily with other resins and plastic cizers with absolute control of the formulation ingredients. The new plastic, known as "Shellerite," was developed jointly by the Pacific Lumber Company, San Francisco, the Institute of Paper Chemistry, Appleton, Wis., and the Sheller Mfg. Co., Portland, Ind.

TRACING CLOTH—The Fredrick Post Co., has just recently developed a new improved white pencil tracing cloth known as "Whitex." One of the outstanding features is that it is moisture resistant on both sides, which guards against spots

from perspiration or moist hands which mar the prints from the finished drawing. Samples can be secured by writing the manufacturer (above) at Box 803, Chicago.

PLASTICS METAL PLATED—A new process by which plastics, glass, or any non-conductor, is plated with any of the plating metals, is announced by Precision Paper Tube Co., 2023 W. Charleston Street, Chicago, 47. This process can be used for plating magnetic and electric shielding of all kinds—radio shielding, electrostatic and magnetic shielding, applications as coil shields, condensers, etc. Plastic articles can be made to match those made of metals. Conductor and insulator can be combined in one unit. Detailed information and estimates can be had by writing.

PRODUCERS' COUNCIL

and industry-wide, of work that will go right on when the war is over. The main purpose of the campaign is to provide the very maximum of employment during the industrial reconversion period. It should turn up a prospect list that will contain some first rate leads for you, Mr. Architect, and you, too, Mr. Producer!

Here's an Opportunity to learn lots more about another effort to realize one of the Producers' Council's cardinal points . . . the promotion of dimensional coordination and modular products. Mr. Harry C. Plummer, Director of Engineering and Research of the Structural Clay Products Institute, will talk at the annual meeting of the Pacific Coast Building Officials Conference to be held in San Francisco October 5-6th.

Estimator's Guide

Giving Cost of Building Materials, Wage Scale, Etc.

Amounts given are figuring prices and are made up from average quotations furnished by material houses to San Francisco contractors. 3% Sales Tax on all materials but not labor.

All prices and wages quoted are for San Francisco and the Bay District. There may be slight fluctuation of prices in the interior and southern part of the state. Freight cartage, at least, must be added in figuring country work.

Bond—1½% amount of contract.
Government work ¾%.

Brickwork—
Common, \$43 to \$45 per 1000 laid, (according to class of work).
Face, \$125 to \$150 per 1000 laid, (according to class of work).
Brick Steps, using pressed brick, \$1.50 lin. ft.
Brick Veneer on frame buildings, \$1.10 sq. ft.
Common f.o.b. cors, \$16.00 a yard. Cartage extra, \$2.50 per 1000.
Face, f.o.b. cors, \$55.00 to \$80.00 per 1000, carload lots.

Building Paper—
1 ply per 1000 ft. roll\$3.50
2 ply per 1000 ft. roll6.25
3 ply per 1000 ft. roll5.00
Brownskin, Standard, 500 ft. roll.....5.00
Sisalcraft, 500 ft. roll5.00
Sash cord com. No. 7\$1.20 per 100 ft.
Sash cord com. No. 81.50 per 100 ft.
Sash cord spot No. 71.90 per 100 ft.
Sash cord spot No. 82.25 per 100 ft.
Sash weights, cast iron, \$50.00 ton.
Nails, \$3.50 base.
Sash weights, \$45.00 per ton.

Concrete Aggregates—
GRAVEL (all sizes) \$1.95 per ton at bunker; delivered, \$2.50. All quotations less 10% to contractors.

	Bunker	Delivered
Top sand	\$1.90	\$2.50
Concrete mix	1.90	2.45
Crushed rock, ¼ to ¾	1.90	2.50
Crushed rock, ¾ to 1½	1.90	2.50
Roofing gravel	2.25	2.80
River sand	2.25	2.70

SAND—

	Bunker	Delivered
River sand	\$2.25	\$2.70
Lapis (Nos. 2 & 4)	2.85	3.15
Olympia Nos. 1 & 2	2.85	3.10
Del Monte white		84c per sack

Common cement (all brands, paper sacks) carload lots \$2.42 per bbl. f.o.b. car; delivered \$2.60.
Cash discount on carload lots, 10c a barrel, 10th Prox.

Atlas White
Calaveras White
Medusa White } 1 to 100 sacks, \$2.70 sack, warehouse or delivery; \$7.65 bbl. carload lots.

Forms, Labors average \$40.00 per M.
Average cost of concrete in place, exclusive of forms, 35c per cu. ft.; with forms, 60c.
4-inch concrete basement floor12½c to 14c per sq. ft.
Rat-proofing7½c
Concrete Steps.....\$1.25 per lin. ft.

Dampproofing and Waterproofing—
Two-coat work, 20c to 30c per yard.
Membrane waterproofing—4 layers of saturated felt, \$4.50 per square.
Hot coating work, \$2.00 per square.
Medusa Waterproofing, 15c per lb., San Francisco Warehouse.
Tricolac waterproofing.
(See representative.)

Electric Wiring—\$12.00 to \$15.00 per outlet for conduit work (including switches).
Knob and tube average \$3.00 per outlet. (Available only for priority work.)

Elevators—
Prices vary according to capacity, speed and type. Consult elevator companies. Average cost of installing a slow speed automatic passenger elevator in small four story apartment building, including entrance doors, about \$6500.00.

Excavation—
Sand, 60 cents; clay or shale \$1 per yard.
Teams, \$12.00 per day.
Trucks, \$22 to \$27.50 per day.
Above figures are an average without water. Steam shovel work in large quantities, less; hard material, such as rock, will run considerably more.

Fire Escapes—
Ten-foot galvanized iron balcony, with stairs, \$150 installed on new buildings; \$160 on old buildings.

Floors—
Composition Floors—22c to 40c per sq. ft.
In large quantities, 18c per sq. ft. laid.
Mosaic Floors—80c per sq. ft.
Dureflex Floor—23c to 30c sq. ft.
Rubber Tile—50c to 75c per sq. ft.
Terazo Floors—45c to 60c per sq. ft.
Terazo Steps—\$1.60 lin. ft.

Hardwood Flooring (delivered to building)—

	¾x2¼"	¾x2"	¾x2"
	T&G	T&G	Sq.Ed.
Cir. Old. Oak	\$144.00 M	\$122.00 M	\$141.00 M
Sel. Old. Oak	118.00 M	101.00 M	114.00 M
Cir. Pla. Oak	120.00 M	102.00 M	115.00 M
Sel. Pla. Oak	113.00 M	92.00 M	107.00 M
Cir. Maple	125.00 M	113.00 M	

Wage—Floor layers, \$12.00.
Note—Above quotations are all board measure except last column which is sq. ft.

Glass (consult with manufacturers)—
Double strength window glass, 20c per square foot.
Plate 80c per square foot (un glazed) in place, \$1.00.
Art. \$1.00 up per square foot.
Wire (for skylights), glazed, 40c per sq. foot.
Obscure glass, 30c to 50c square foot.
Glass bricks, \$2.50 per sq. ft. in place.
Note—if not stipulated add extra for setting.

Heating—
Average, \$1.9C per sq. ft. of radiation, according to conditions.
Warm air (gravity) average \$48 per register.
Forced air, average \$68 per register.

Iron—Cost of ornamental iron, cast iron, etc., depends on designs.

Lumber (prices delivered to bldg. site)—

No. 1 common	\$45.00 per M
No. 2 common	43.00 per M
Select O. P. Common	48.00 per M
1x4 No. 2 flooring VG	80.00 per M
1x4 No. 3 flooring VG	75.00 per M
1x6 No. 2 flooring VG	90.00 per M
1¼x4 No. 2 flooring	85.00 per M

Slash grain—

1x4 No. 2 flooring	\$65.00 per M
1x4 No. 3 flooring	62.00 per M
No. 1 common run T. & G.	50.00 per M
Lath	75.00 per M

Shingles (add cartage to price quoted)—
Redwood, No. 1\$1.20 per bdle.
Redwood, No. 21.00 per bdle.
Red Cedar1.40 per bdle.

Plywood—Douglas Fir (add cartage)—
"Plyscord" sheathing (unsanded)
A" 3-ply and 48"x96"
"Plywall" (wallboard grade)—\$39.75 per M
¼" 3-ply 48"x96"\$43.70 per M
"Plyform" (concrete form grade)—
¾" 5-ply 48"x96"\$117.30 per M
 Exterior Plywood Siding—
★ 5-ply Fir\$132.00 per M
Redwood (Rustic) 1" x 8" clear heart. \$ 95.00 per M
\$ 5 less per M for A grade.

Millwork—Standard.
O. P. \$100 per 1000. R. W. rustic \$100.00 per 1000 (delivered).
Double hung box window frames, average with trim, \$6.50 and up, each.
Complete door unit, \$10.00.
Screen doors, \$3.50 each.
Patent screen windows, 25c a sq. ft.
Cases for kitchen pantries seven ft. high, per lineal ft., \$8.00 each.
Dining room cases, \$8.00 per lineal foot.
Rough and finish about 75c per sq. ft.
Labor—Rough carpentry, warehouse heavy framing (average), \$17.50 per M.
For smaller work average, \$35.00 to \$45.00 per 1000.

Marble—(See Dealers)

Painting—
Two-coat workper yard 50c
Three-coat workper yard 70c
Cold water paintingper yard 10c
Whitewashingper yard 4c

Turpentine, \$.08 per gal., in 5 gal. cans, and 95c per gal. in drums.
Raw Linseed Oil—\$1.32 gal. in light drums.
Boiled Linseed Oil—\$1.35 gal. in drums and \$1.48 in 5 gal. cans.

White Lead in oil Per Lb.
1 ton lots, 100 lbs. net weight.....11 1/2c
500 lbs. and less than 1 ton.....12 1/4c
Less than 500 lb. lots.....12 3/4c

Red Lead and litharge
1 ton lots, 100 lbs. net weight.....11 1/2c
500 lbs. and less than 1 ton.....12 1/4c
Less than 500 lb. lots.....12 3/4c

Red Lead in oil
1 ton lots, 100 lbs. net weight.....12 1/2c
500 lbs. and less than 1 ton.....13 1/4c
Less than 500 lb. lots.....13 3/4c
Note—Accessibility and conditions cause some variance in costs.

Patent Chimneys—
6-inch\$1.25 lineal foot
8-inch 1.50 lineal foot
10-inch 2.25 lineal foot
12-inch 3.00 lineal foot

Plaster
Neat wall, per ton delivered in S. F. in paper bags, \$17.60.

Plastering—Interior— Yard
1 coat, brown mortar only, wood lath.....\$0.70
2 coats, lime mortar hard finish, wood lath .90
2 coats, hard wall plaster, wood lath..... .80
3 coats, metal lath and plaster..... 1.60
Keene cement on metal lath..... 1.60
Ceilings with 3/4 hot roll channels metal lath (lath only) 1.10
Ceilings with 3/4 hot roll channels metal lath plastered 2.00
Single partition 3/4 channel lath 1 side (lath only) 1.10
Single partition 3/4 channel lath 2 inches thick plastered 2.90
4-inch double partition 3/4 channel lath 2 sides (lath only) 2.00
4-inch double partition 3/4 channel lath 2 sides plastered 3.50
Thermax single partition; 1" channels; 1/4" overall partition width. Plastered both sides 3.00
Thermax double partition; 1" channels; 1/4" overall partition width. Plastered both sides 4.00

3 coats over 1" Thermax nailed to one side wood studs or joists 1.50
3 coats over 1" Thermax suspended to one side wood studs with spring sound insulation clip 1.75

Plastering—Exterior— Yard
2 coats cement finish, brick or concrete wall\$1.00
3 coats cement finish, No. 18 gauge wire mesh 1.75
Wood lath, \$5.50 to \$6.50 per 1000 (not available)
2.5-lb. metal lath (dipped) (not available)... .19
2.5-lb. metal lath (galvanized) (not avail)... .21
3.4-lb. metal lath (dipped) (not available)... .22
3.4-lb. metal lath (galvanized) (not avail)... .24
3/4-inch hot roll channels, \$72 per ton.
Finish plaster, \$18.90 ton; in paper sacks.
Dealer's commission, \$1.00 off above quotations. \$13.85 (retate DC sack).
Lime, i.o.b. warehouse, \$2.25 bbl.; cars, \$2.15
Lime bulk (ton 2000 lbs.), \$16.00 ton.
Wall Board 5 pl. \$50.00 per M.
Hydrate Lime, \$25.00 ton.
Plasterers Wage Scale.....\$1.75 per hour
Lathers Wage Scale..... 1.75 per hour
Hod Carriers Wage Scale..... 1.50 per hour
Composition Stucco—\$1.80 to \$2.00 sq. yard (applied).

Plumbing—
From \$100.00 per fixture up, according to grade, quantity and runs.

Roofing—
"Standard" tar and gravel, \$7.00 per sq. for 30 sqs. or over.
Less than 30 sqs. \$7.50 per sq.
Tile, \$20.00 to \$35.00 per square.
Redwood Shingles, \$7.50 per square in place.
Copper, \$16.50 to \$18.00 per sq. in place.
5/2 # 1-16" Cedar Shingles, 8.00 Square
4 1/2" Exposure
5/8 x 16" # 1 Cedar Shingles, 9.00 Square
4/2 # 1-24" Royal Shingles, 9.50 Square
7/2" Exposure
Re-coat with Gravel, \$3 per sq.
Asbestos Shingles, \$15 to \$25 per sq. laid.
Slate, from \$25.00 per sq., according to color and thickness.
1/2 x 25" Resawn Cedar Shakes, 10" Exposure10.50
3/4 x 25" Resawn Cedar Shakes, 10" Exposure11.50

1 x 25" Resawn Cedar Shakes, 10" Exposure\$12.50
Above prices are for shakes in place.

Sheet Metal—
Windows—Metal, \$1.75 a sq. ft.
Fire doors (average), including hardware, \$1.75 per sq. ft.

Skylights—(not glazed)
Copper, 90c sq. ft. (flat).
Galvanized iron, 40c sq. ft. (flat).
Vented hip skylights 60c sq. ft.

Steel—Structural (None available except for defense work)
\$150 ton (erected), this quotation is an average for comparatively small quantities. Light truss work higher. Plain beams end column work in large quantities \$140 per ton.

Steel Reinforcing (None available except for defense work).
\$150 to \$200 per ton, set.

Stone—
Granite, average, \$6.50 cu. foot in place.
Sandstone, average Blue, \$4.00. Boise, \$3.00 sq. ft. in place.
Indiana Limestone, \$2.80 per sq. ft. in place.

Store Fronts—
Copper sash bars for store fronts, corner center and around sides, will average \$1.00 per lineal foot.
Note—Consult with agents.

Tile—Floor, Wainscot, etc. — (See Dealers)
Asphalt Tile—18c to 28c per sq. ft. installed.

Wall Tile—
Glazed Terra Cotta Wall Units (single faced) laid in place—approximate prices:
2 x 6 x 12 1.00 sq. ft.
4 x 6 x 12 1.15 sq. ft.
2 x 8 x 16 1.10 sq. ft.
4 x 8 x 16 1.30 sq. ft.

Venetian Blinds—
40c per square foot and up. Installation extra.

Windows—Steel
Factory type sash 30c ft.
Ventilators for steel sash \$5.00 each.

1943 BUILDING TRADES WAGE SCALES FOR NORTHERN CALIFORNIA

All crafts, except plasterers, are now working 8 hours a day. Plasterers' time is 6 hours.

CRAFT	San Francisco	Alameda	Fresno	Marin	Sacramento	San Jose	San Mateo	Vallejo	Stockton
ASBESTOS WORKERS	\$1.50	\$1.25	\$1.25	\$1.37 1/2	\$1.12 1/2	\$1.25	\$1.25	\$1.25	\$1.25
BRICKLAYERS	1.87 1/2	1.87 1/2	1.50	1.87 1/2	2.00	2.00	1.87 1/2	1.87 1/2	2.00
BRICKLAYERS' HODCARRIERS	1.40	1.40	1.05	1.40	1.40	1.40	1.40	1.40	1.40
CARPENTERS	1.43	1.43	1.25	1.43	1.43	1.43	1.43	1.43	1.43
CEMENT FINISHERS	1.37 1/2	1.37 1/2	1.25	1.25	1.25	1.50	1.50	1.25	1.25
ELECTRICIANS	1.70	1.50	1.50	1.37 1/2	1.50	1.50	1.50	1.50	1.50
ELEVATOR CONSTRUCTORS	1.41	1.56	1.50	1.61	1.61	1.50	1.50	1.56	1.37 1/2
ENGINEERS: Material Hoist	1.50	1.37 1/2	1.25	1.50	1.37 1/2	1.62 1/2	1.37 1/2	1.37 1/2	1.50
Piledriver	1.75	1.60	1.60	1.75	1.75	1.75	1.62 1/2	1.75	1.60
Structural Steel	1.75	1.60	1.60	1.75	1.75	1.75	1.60	1.75	1.60
GLASS WORKERS	1.25	1.25	1.12 1/2	1.25	1.25	1.25	1.25	1.25	1.25
IRONWORKERS: Ornamental	1.50	1.31 1/4	1.37 1/2	1.31 1/4	1.37 1/2	1.31 1/4	1.25	1.31 1/4	1.31 1/4
Reinf. Rodmen	1.50	1.31 1/4	1.31 1/4	1.31 1/4	1.31 1/4	1.31 1/4	1.31 1/4	1.31 1/4	1.25
Structural	1.75	1.60	1.60	1.60	1.60	1.75	1.50	1.60	1.37 1/2
LABORERS: Building	.85	.87 1/2	.82 1/2	.81 1/4	.85	.81 1/4	.81 1/4	.81 1/4	.80
Concrete	.87 1/2	.93 1/4	.90	.90	.92 1/2	.85	.90	.90	.90
LATHERS	1.75	1.75	1.50	1.75	1.60	1.75	1.75	1.50	1.50
MARBLE SETTERS	1.43 3/4	1.25	1.25	1.31 1/4	1.37 1/2	1.25	1.31 1/4	1.31 1/4	1.31 1/4
MOSAIC & TERRAZZO	1.50	1.25	1.12 1/2	1.12 1/2	1.12 1/2	1.15	1.15	1.15	1.50
PAINTERS	1.37 1/2	1.50	1.28-4/7	1.37 1/2	1.25	1.35-5/7	1.42-6/7	1.50	1.25
PILEDRIVERS	1.47	1.40	1.40	1.40	1.40	1.47	1.40	1.40	1.40
PLASTERERS	1.66-2/3	1.66-2/3	1.75	1.66-2/3	1.75	2.00	2.00	1.75	1.83-1/3
PLASTERERS' HODCARRIERS	1.50	1.45	1.40	1.40	1.43	1.35	1.75	1.40	1.50
PLUMBERS	1.70	1.50	1.53-1/8	1.50	1.56 1/4	1.62 1/2	1.50	1.50	1.37 1/2
ROOFERS	1.37 1/2	1.37 1/2	1.12 1/2	1.25	1.25	1.37 1/2	1.25	1.25	1.25
SHEET METAL WORKERS	1.50	1.37 1/2	1.43 3/4	1.37 1/2	1.50	1.50	1.37 1/2	1.25	1.37 1/2
SPRINKLER FITTERS	1.50	1.37 1/2	1.25	1.25	1.62 1/2	1.62 1/2	1.50	1.50	1.50
STEAMFITTERS	1.50	1.50	1.53 1/4	1.50	1.56 1/4	1.62 1/2	1.50	1.50	1.50
STONESETTERS (Masons)	1.50	1.75	1.75	1.75	1.50	1.50	1.75	1.75	1.50
TILESETTERS	1.50	1.37 1/2	1.37 1/2	1.37 1/2	1.37 1/2	1.50	1.50	1.37 1/2	1.37 1/2

Prepared and compiled by

CENTRAL CALIFORNIA CHAPTER, ASSOCIATED GENERAL CONTRACTORS OF AMERICA

with the assistance and cooperation of secretaries of General Contractors Associations and Builders Exchanges of Northern California.

CHAPTER MEETINGS

(Continued from page 38)

A. E. Barnes, president of the local Producers' Council Club, directed the roundtable discussion of the evening's topic and among those voicing their opinion were G. E. Morris, Los Angeles Superintendent of Buildings; C. D. Wailes, Joseph Weston, A. T. Danielson, Wilbur Barr and Fritz Burns, president of the National Home Builders Association, who expressed his belief that the future of the prefabricated house depends on the measure of public acceptance and until this is ascertained builders will continue to operate as in the past.

PARKMERCED HOUSING PROJECT

Latest reports by the Metropolitan Life Insurance Company which is financing the \$12,500,000 Parkmerced Housing Project in San Francisco, indicate that 1,700 units will be completed and ready for occupancy in the spring of 1944. The project has run the gauntlet of ups and downs since work was started two years ago. Changes in type of construction, due to scarcity of materials, from reinforced concrete to steel and brick, then to wood frame, has naturally delayed progress and caused the redrawing of architect's and engineer's plans. The original scheme called for 2,600 units which has been hacked one third. Some of the buildings have reached the painting stage, others the frame work is in progress.

Architects Leonard Schultze and Associates of New York are doing their utmost to move the job along. So are the contractors, Starrett Bros. & Elken, also of New York. Both H. J. Brunnier and Frederick H. Meyer of San Francisco, were originally identified with the project, Brunnier as structural engineer and Meyer as resident architect.

Metropolitan is also financing a similar project in Los Angeles, known as Park La Brea which has been cut to 1,300 units. Commenting, Time recently reported that "the remainder of the finished concrete foundations will be kept like the ruined city of Persepolis to be grown over by milkweed and wild daisies until after the war."

COMPETITION DATE EXTENDED

The Ministry of Public Works and Communications of Ecuador announces that the closing date of the first stage of the Architectural Competition for the Legislative Palace in Quito has been changed from October 1st to December 31st. Competitors will, therefore, have three more months in which to complete their entries.

Additional details may be obtained from the Pan-American Union, Washington, D.C.

ENGINEER'S EXCURSION

Members of San Francisco Section, American Society of Civil Engineers, participated in an excursion to Sunnyvale, Saturday, August 28, where they were es-

(Turn to page 44)

BASALITE

CAMBERED SHINGLE TILE

PERMANENT • FIREPROOF • STORM-SAFE • COLORFUL • ECONOMICAL

Manufactured by

BASALT ROCK CO., INC.
NAPA, CALIFORNIA

SISALKRAFT

REG. U. S. PAT. OFF.

"More than a building paper"

THE SISALKRAFT CO.

205 West Wacker Drive
Chicago, Ill.

55 New Montgomery Street
San Francisco, Calif.

VERMONT MARBLE COMPANY

Producers and Finishers
of

Domestic and Imported Marbles

Write for new pamphlet describing our
Marble Toilets and Showers

San Francisco and Los Angeles
San Francisco phone: SUTTER 6747

ALFRED F. ROSENHEIM

Alfred F. Rosenheim, F.A.I.A., died in Los Angeles September 9, at the age of 84. Mr. Rosenheim came to California from St. Louis when Los Angeles was just starting to build sky-scrapers. The I. W. Hellman building, designed by Mr. Rosenheim, was one of the first reinforced concrete office buildings to be erected in the Southern city. The structure stands as a monument to the architects' ability, as do a number of other pretentious structures, including schools and factories. Mr. Rosenheim was a member of Southern California Chapter, A.I.A., and some years ago took a prominent part in its activities.

**The Most Complete Line of
STEELS and BUILDING MATERIALS
Made by a Single Producer**



See Sweet's Catalog File or write us for full information.

REPUBLIC STEEL CORPORATION
GENERAL OFFICES: CLEVELAND, OHIO

DENVER, COLORADO CONTINENTAL OIL BUILDING
LOS ANGELES, CALIFORNIA EDISON BUILDING
SALT LAKE CITY, UTAH WALKER BANK BUILDING
SAN FRANCISCO, CALIFORNIA RIALTO BUILDING
SEATTLE, WASH. WHITE-HENRY-STUART BUILDING

**PACIFIC
MANUFACTURING CO.**

**HIGH CLASS INTERIOR FINISH
QUALITY MILLWORK**

142 SANSOME ST., SAN FRANCISCO
Garfield 7755

6820 MCKINLEY AVE., LOS ANGELES
THornwall 4196

BUILDERS EXCHANGE, OAKLAND

**"AMERICAN MARSH"
Redi-Vac Vacuum Heating Pump**



Send for
Bulletin 441

SIMONDS MACHINERY CO.

San Francisco
816 Folsom St.

Los Angeles
455 East Fourth St.

SANTA MARIA INN SANTA MARIA CALIFORNIA



On the Coast Highway
between Los Angeles
and San Francisco

**OVER NIGHT
or
JUST A MEAL**

FRANK J. MCCOY
Owner

EL ENCANTO HOTEL SANTA BARBARA

On the Riviera, above the Old Mission

Frank J. McCoy, Owner

Fred F. Pimental, Manager

corted through the Joshua Hendy Iron Works plant for a close-up of mass production of reciprocating engines. An engine every 24 hours is the plant's record to date. Those taking advantage of the invitation used the Southern Pacific trains for transportation both to and from the works. Carl W. Appleford acted as chairman of the program and excursion committee.

BUILDING CODE FOR PREFABRICATION

Anticipating a post-war trend in prefabricated construction for residences and small homes, the Uniform Building Code for the State of California is to undergo some changes and the following six provisions seem likely of adoption on recommendation of a special committee of the Pacific Coast Building Officials Conference:

1. Every approval of material not specifically mentioned in the code shall incorporate as a proviso the kind and number of tests to be made during prefabrication.

2. In lieu of structural design any assembly to be used as a structural element shall be submitted to test loads acting as they would in a completed structure. Such assemblies shall also be tested for durability and weather resistance.

3. Connections shall be designed to develop the strength of the members connected with structural connections conforming with the existing provisions of the code.

4. In the installation of pipes and conduits allowance shall be made for any material to be removed; panels to be tested after all chases and cavities have been cut and installations of pipes and conduits to conform to all laws applicable thereto.

5. Materials to be inspected for compliance with the code and to be grade-marked or labeled as required elsewhere in code; inspection to be made in the process of assembly and erection in the field with continuous inspection, if required for certain materials, where construction takes place at the site. Continuous inspection during assembly may not be required if certified for compliance by an approved agency.

6. A certificate of compliance by an approved agency shall be furnished with every assembly but one certificate may serve for all assemblies of one type delivered at one site.

EVERS OUT OF HOUSING JOB

Architect Albert J. Evers who has served as executive director of the San Francisco Housing Authority almost since its inception five years ago, was recently relieved of his office by a three to two vote of the board. Evers said it was a question of whether he or someone else was to direct the affairs of the Authority. John W. Beard, chief of the management division, has been named temporary acting executive director. The Authority still has several important housing projects to carry through.

SAN FRANCISCO'S FERRY BUILDING

The San Francisco City Planning Commission has offered some suggestions for modernizing the Ferry Building, long a land mark, as a post-war construction activity, recommending several optional schemes, any one or all of which would contribute to the betterment of a threatened blighted area.

For a period following the suspension of commuter service the Ferry building was practically deserted. The war, however, has brought new uses to the building as well as the district but only temporarily and the commission feels something will have to be done with the return of peace to keep this section of the city alive.

One plan is to maintain the building as a bus and street car terminal which would necessitate remodeling the structure and removal of the old ferry slips. It could also be used as a terminal for seaplane and highspeed motor boat service between bay cities. Establishment of a permanent museum is another suggestion offered by the commission which also would like to see a permanent plaza with a broad new terrace built directly in front of the building.

BOOK REVIEW

The Old Churches of London, by Gerald Cobb. Over one hundred illustrations of edifices, some of which were destroyed through recent indiscriminate bombing. Published by Charles Scribner's Sons, 597 Fifth Ave., New York. Price \$5.

The destruction of so many of Britain's fine buildings has awakened interest as it has excited grief about the splendid but little realized inheritance of the London churches. Professor Geoffrey Webb contributes an able survey of the work of five centuries, and Gerald Cobb a detailed and comparative account from his minute knowledge.

The illustrations include six color plates, views of vanished or falsified buildings from old drawings and prints, and over one hundred photographs of churches, surviving and destroyed, their exteriors and interiors, and all that noble craftsmanship in wood, stone, plaster and metal of Wren and his successors. The beautiful cover drawing by Professor Randolph Schwabe, Principal of the Slade School of Art, is based on an early eighteenth century engraving, and is intended to give a general impression of the towers and steeples of the city's churches shortly after their completion.

ARCHITECT OWNS VALUABLE TIME-PIECE

Ralph M. Wyckoff, architect of San Jose, is owner of a watch which he says was once carried by King Louis Phillipe of France in the 19th century.

The watch was made by A. Benoit Company of Versailles and is engraved as made by royal command. Frame and works are platinum and there are 15 rubies in the timepiece. Its intrinsic value was set by Wagstaff of London as \$500 to \$600.

HOGAN LUMBER CO.

Wholesale and Retail

LUMBER

MILL WORK • SASH & DOORS

Office, Mill, Yard and Docks

SECOND AND ALICE STREETS • OAKLAND, CALIF.

Telephone Glencourt 6861

CLINTON CONSTRUCTION CO. OF CALIFORNIA

General Contractors

923 FOLSOM STREET • SAN FRANCISCO

SUtter 3440

FORDERER CORNICE WORKS

Manufacturers of

Hollow Metal Products • Interior Metal Trim

Elevator Fronts and Cabs

Metal Plaster Accessories • Sanitary Metal Base

Flat and Roll Metal Screens

Metal Cabinets • Commercial Refrigerators

269 POTRERO AVE.

SAN FRANCISCO, CALIF.

HEMLOCK 4100

STRUCTURAL STEEL

**For Class A Buildings,
Bridges, etc.**

JUDSON PACIFIC CO.

1200 SEVENTEENTH STREET
SAN FRANCISCO

Plants: San Francisco - Oakland

LANDSCAPING WAR HOUSING PROJECTS

Maritime Commission
Apartments, Richmond
Sunnydale
G. G. Bridge Approach
Roosevelt Terrace, Vallejo
Camp Roberts
Chabot Terraces, Vallejo
Peralta Villa, Oakland
Sausalito
Union Square Garage



Growers and Distributors of
"Superior Quality" Nursery
Stock Since 1878

LEONARD COATES NURSERIES, INC.

Ray D. Hartman, President-Manager

SAN JOSE, CALIFORNIA



HERRICK IRON WORKS

STRUCTURAL STEEL.
REINFORCING STEEL.

18TH AND CAMPBELL STS.
OAKLAND, CALIF.
Phone GLencourt 1767

ABBOT A. HANKS, INC. Engineers & Chemists

INSPECTING — TESTING — CONSULTING
CONCRETE • STEEL • MATERIALS
CHEMICAL AND TESTING
LABORATORIES
• RESEARCH AND INVESTIGATION •

TESTS OF STRUCTURAL MATERIALS
DESIGN OF CONCRETE MIXES
SHOP AND ERECTION INSPECTION OF
STRUCTURES AND EQUIPMENT
INVESTIGATION OF STRUCTURES
AND MATERIALS
TESTS AND INVESTIGATION OF
FOUNDATION SOILS
FIRE RESISTANCE AND INSULATION
TESTS

624 Sacramento Street, San Francisco

"E" FOR VERMONT MARBLE

The Vermont Marble Company, whose home office is at Proctor, Vermont, was awarded an Army-Navy "E" on July 18th, in recognition of the Company's fine and unusual job of converting its stone working machinery to the manufacture of war implements.

Six large shops of the company are now devoting their whole facilities to this type of work, which accounts for some 85 per cent of the company's current production.

Stone working machinery generally works to tolerances of 1/16" to 1/8", but in these Vermont shops this equipment was rebuilt by the company's own maintenance force to work to tolerances of 5/1000 of an inch and even less. One shop was completely dismantled and equipped with wood-working tools. The production includes planing, turning and machining heavy castings which are used in machine tools, ship engines, winches and a large variety of other products. The wood-working plant makes ammunition boxes and other containers for war materials.

The "E" pennant was awarded by General Burton O. Lewis, District Chief of the Boston Ordnance Department, and Captain R. N. Henderson, U. S. Navy, (Ret.), presented the individual pins at the ceremonies. The pennant was accepted by Redfield Proctor, President of the Vermont Marble Company, and the individual pins for the employees by Frank Lorraine, President of the Independent Marble Workers of Vermont.

THE AIRPLANE OF TOMORROW

A warning against a dangerous conflict between the "international airplane" and "nationalistic ideas" is given by Waldemar Kaempffert, Science Editor of the New York Times, in The Airplane and Tomorrow's World, issued by the Public Affairs Committee of New York City.

"Isolation and the airplane cannot go together," declares Mr. Kaempffert in the new Public Affairs pamphlet. "The airplane demands a political outlook that goes beyond country or continent."

INCANDESCENT SUPPLY COMPANY

647

MISSION STREET
SAN FRANCISCO

Lighting Fixtures and
Lamps, Fireplace Fur-
nishings, Pictures and
Mirrors, Electrical Sup-
plies and Marine Fix-
tures.

Oakland - Fresno
Los Angeles

Independent Iron Works

Structural Steel
Ornamental Iron
Steel Service Stations
Steel Tanks
Standard Steel Mill Buildings
Bridges

821 Pine Street

Oakland

ANDERSON & RINGROSE

General Contractors

320 Market Street, San Francisco
Phone GARfield 2245

MULLEN MFG. COMPANY

BANK, STORE AND OFFICE
FIXTURES—CABINET WORK
OF GUARANTEED QUALITY
CHURCH SEATING

Office and Factory:
40-80 RAUSCH ST., Bet. 7th and 8th Sts.
San Francisco
Telephone UNDERhill 5815

THE TORMEY COMPANY

GENERAL PAINTERS
AND DECORATORS

Phone UNDERhill 1913

563 FULTON STREET
San Francisco

Phone GARfield 1164

Thomas B. Hunter

Consulting Engineer
DESIGNER OF HEATING
AIR CONDITIONING
VENTILATING AND WIRING
SYSTEMS, MECHANICAL
AND ELECTRICAL EQUIP-
MENT OF BUILDINGS

41 SUTTER STREET
ROOM 710
San Francisco California

Robert W. Hunt Company

ENGINEERS

Inspection - Tests - Consultation

Schools and Other Structures
Are Built as Designed

When Construction Materials are
Inspected at point of Manufacture
and during Erection by

ROBERT W. HUNT COMPANY

Cement, Concrete, Chemical, Metallurgical,
X-Ray and Physical Laboratories

Chicago - New York - Pittsburgh
Los Angeles - All Large Cities
San Francisco, 251 Kearny Street

Mr. Kaempffert sees, in recent speeches made both in Congress and in Parliament, a desire to use the long-distance airplane to secure economic and political advantages over distant countries. He calls deep nationalistic resistance to free intercourse "a headache for the future," and suggests—as one of the problems which must be ironed out in postwar planning and at the peacetable—a change in our concept of "Who owns the air?"

"The first giant planes to appear after the war will probably have a ceiling no greater than the C-54's 35,000 feet, but the true stratosphere plane will come," Mr. Kaempffert says. "It will climb at the rate of four miles a minute out of sight of ocean and land. It will be an ordinary event to breakfast in New York and lunch in Southampton or Portsmouth.

"This stratosphere plane with a range of half the earth's circumference could easily be used by a strong, predatory nation in making many simultaneous surprise attacks," reminds the author of the pamphlet. "Is world unity to be achieved by some ruthless, militaristic power and maintained by all the resources of transportation and communication? Or by some new League of Nations with power to enforce its decisions, or by some federation of states?"

"The more the relation of air power to permanent peace is studied," concludes Mr. Kaempffert, "the more it becomes obvious that air traffic must be placed under a single international authority and that peace must be preserved with the aid of an international air force. Probably ten or fifteen bomber stations strategically located around the Arctic Circle and other regions would be enough."

ALL STEEL ITEMS CLASS A

Steel shapes, plates, bars, concrete reinforcing bars, and wire products used for reinforcing concrete, in controlled material form, which have been formed, bent, punched, welded, riveted, bolted, or painted, by the fabricator, or which have been cut to specific size or length for a specific

USE
Mailway Banking

FOR SAVINGS AND CHECKING ACCOUNTS

For the convenience of your business or household—a Mailway checking account. For safe and systematic accumulation of a cash reserve—a Mailway savings account. Both are available to you, affording quick reliable service from one of the oldest and strongest banks in the West. Open a Mailway account today.

Full details on request

CROCKER FIRST NATIONAL BANK
OF SAN FRANCISCO
Crocker First National Bank

Member Federal Deposit Insurance Corporation
ONE MONTGOMERY STREET

the
LIVABLE KITCHEN

Architects today are not only designing the kitchen for convenience and efficiency but they are making a livable room of it.

To this end Paramount Built-in Fixtures meet the most exacting requirements. Their "Deluxe," "Moderne" and "Economy" cabinet fixtures are distinctive in design and construction and may be had in stock sizes or built to order.

Catalog for the asking

Paramount
PARAMOUNT
BUILT-IN FIXTURE COMPANY
5107 Broadway, Oakland, California
Phone PIdmont 8100

construction project by the fabricator, are to be treated as Class A products instead of as controlled materials, according to Direction No. 24 to CMP Regulation No. 1, the War Production Board has recently announced.

In supplying steel products for construction projects, fabricators found that most of the items were Class A products, but that there were frequently some items which were actually controlled materials. This meant that, for a Class A product, a fabricator had to receive an order accompanied by an allotment and a preference rating, while for controlled materials he had to receive an authorized controlled materials order. The Direction now permits fabricators to accept orders for all steel items going into construction as if they were Class A products.

LEASE INSTEAD OF PURCHASE

A total of 263 sites, or approximately one-third of the sites for war housing projects placed under construction during the fiscal year ending June 30, were leased, instead of purchased, Commissioner Herbert Emmerich of the Federal Public Housing Authority announced recently.

"The policy of leasing instead of purchasing sites for temporary structures wherever possible, is being consistently followed in all our land negotiations," Mr. Emmerich explained, "not only in the interest of economy but also to facilitate the speedy removal of temporary structures after the war."

Since adopting the lease-instead-of-purchase policy, sites for 35 war housing projects, comprising more than 1,315 acres, have been obtained from patriotic owners for the nominal rental of \$1.00 a year, he said. These sites are located in 14 different states.

Five sites have been leased at \$1 a year in each of the states of Alabama, Arizona, California and Utah; three each in the states of Colorado and Georgia; two in Nevada, Texas and Washington; one in Arkansas, Connecticut, Delaware, Indiana and Montana.

Combined rental costs of the 263 leased sites amounts to \$318,377 a

year, less than 4 per cent of their appraised valuation totaling more than \$8,000,000.

The policy of leasing instead of purchasing war housing sites was adopted by FPHA early in 1942. Under these leases, taxes on the land are paid to the local governments by the FPHA.

POST-WAR GAS APPLIANCES

That the western home-maker visions modern miracles in gas-fueled appliances for her "home of tomorrow" was revealed by the Pacific Coast Gas Association's coastwide contest for service and sales personnel of the gas companies, just concluded: "Have You Ever Seen a Dream Cooking?"

More than 400 men and women employes who are in constant contact with consumers submitted ideas for possible improvements in gas ranges, heating appliances, heaters and refrigerators, and collected over \$1000 in war bond prizes, offered by the post-war appliance committee, headed by W. H. Jacobs of Southern California Gas Company.

The women's committee, led by Gladys Warren, turned in 155 entries proposing additions to gas ranges. Although unanimous in their acclaim of the "certified performance" of present models, the women visualized many "gadgets" that will be studied by manufacturer-members of the Association for the practicability and economic value. Included were ideas for ovens that could be adjusted for height, glass ovens, two-oven ranges with separate controls, built-in cabinets and other convenience devices, built-in pressure cookers, tube lighting, wider use of lightweight metals and many other innovations.

A. F. MATTOCK CO.

Builders

★

212 CLARA STREET
SAN FRANCISCO

REMILLARD-DANDINI Co.

Brick and
Masonry Products

★

633 BRYANT ST., SAN FRANCISCO
569 THIRD ST., OAKLAND

G. P. W.
JENSEN & SON

Building Construction

320 Market Street, San Francisco
Phone: GARfield 2444

**DINWIDDIE
CONSTRUCTION
COMPANY**

•
BUILDERS
•

CROCKER BUILDING
SAN FRANCISCO

**JOHN
CASSARETTO**

—Since 1886—And Still Active—

Building Materials

READY MIX CONCRETE
ROCK - SAND - GRAVEL - LIME
CEMENT - PLASTER - MORTAR
METAL LATH - WOOD LATH
STUCCO - WIRE NETTING

Service Unexcelled

Bunkers
Sixth and Channel, San Francisco
Phones: GARfield 3176, GARfield 3177

ARCHITECT

AND

ENGINEER

PLASTICS for Post-War HOUSING
OCTOBER, 1943

TIME NOW FOR THINKING ABOUT TOMORROW

Right now our job is helping to win a war . . . for some time all our efforts — ours and yours — have been and still are, devoted to that job, evidenced by two of our recently completed housing projects in the San Diego Area

(Illustrated in this issue)

Perhaps it's time now for thinking about tomorrow—for making long range plans for the building and rebuilding of a better and saner world for which we are fighting

**GOOD CONSTRUCTION
WILL BE NEEDED**

MYERS  BROS.
Since 1900

GENERAL BUILDING CONTRACTORS
3407 San Fernando Road Los Angeles

ARCHITECT AND ENGINEER

OCTOBER, 1943

Volume 155 No. 1

FRED W. JONES
Editor

MARK DANIELS
Associate Editor

HOWARD MOISE
Post-War Planning

E. N. KIERULFF*
Ass't Editor
*In the Service

COVER:

Lettering by Wayne Hertzka, Architect

PHOTOGRAPHY:

Plastics by Dana B. Merrill
Fraternity Houses by Berton Crandall

CONTENTS

News and Comment on Art	4-5
What's On Your Mind?	7
Plastics for the Architect	12
Henry O. Belleville	
Three Fraternity Houses by John K. Branner	21
Two War Housing Projects at San Diego	23
Architectural Profession Needs a Voice	27
Louis LaBeaume, F.A.I.A.	
Plywood and Plastic Refrigerator	32
Plastics for Prefabricated Bathroom	33
Architects' Bulletin	37
Producers' Council Page	39

Illustrations

Some Post-War Plastic Models	12-17
Fraternity Houses at Stanford University	20-22
John K. Branner, Architect	
San Diego War Housing Projects	23-26
Frank L. Hope, Jr., Architect	
Oil Paintings by Elmer Grey	30-31

NEXT MONTH

THE FIRST of a series of reports on a Master Plan for the City of San Francisco offers some basic proposals of the Shoreline Plan. Highlights of this report, together with suitable illustrations, will be presented to ARCHITECT AND ENGINEER readers under the signature of L. Deming Tilton, Planning Director. Seven or more proposals are listed, including a 23-mile continuous shore drive, 560 acres of new industrial area, rehabilitation of the Ferry Building area, elimination of shoreline pollution, new recreational facilities, 380 acres of new residential land and more harbors for small boats.

Two huge wooden blimp hangars are nearing completion at the U. S. Naval Air Base at Santa Ana, California. One of these hangars, costing \$2,000,000, is 1,000 feet long, 171 feet high and has a clear span of 237 feet. It is an engineering accomplishment of unusual interest in that it is the largest clear-span wooden building ever erected.

A growing interest in prefabricated school houses for rural districts has prompted a San Francisco firm to specialize in this new type of construction. Several interesting examples will be illustrated, with descriptive matter by the author, who describes his method as "the new prebilt class rooms," a result of years of planning and engineering—not a war baby, he says, but "The School of the Future."

ARCHITECT AND ENGINEER (Established 1905) is published on the 15th of the month by The Architect and Engineer, Inc., 68 Post Street, San Francisco. President, K. P. Kierulff; Vice-President, Fred'k W. Jones; Secretary-Treasurer and Manager, L. B. Penhorwood; Advertising Manager, V. E. Atkinson, Jr.

Los Angeles Office: 403 W. 8th Street, Robert W. Walker, Manager.

Entered as second class matter, November 2, 1905, at the Post Office in San Francisco, California, under the Act of March 3, 1879. Subscriptions, United States and Pan America, \$3.00 a year; \$5.00 two years; foreign countries \$5.00 a year; single copy 50c.

ARCHITECTS' REPORTS are published daily from this office, Vernon S. Yellop, Mgr.

Model
No. 8D6



Model
No. 8C



Do you know the facts about HAWS?

- HAWS Cantonment type Drinking Fountains are Government type P-20.
- They are installed in Army Cantonments and Navy and Marine bases throughout the world.
- They are available in models with automatic and semi-automatic stream control valves.
- HAWS have six Cantonment models, four of which are illustrated.
- The HAWS catalog gives complete information and specifications on all models.
- HAWS have been manufacturers of sanitary drinking fountains and faucets since 1909, and can furnish drinking fountain equipment to meet your particular requirements.

Model
No. 1500

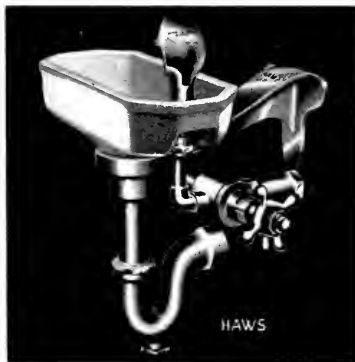

Model
No. 17



HAWS DRINKING FAUCET COMPANY

1808 HARMON STREET • BERKELEY 3 • CALIFORNIA

Agents in the following cities:

Chicago • Los Angeles • San Francisco • Seattle • Salt Lake City • Portland
New Orleans • Newark, N. J. • Houston • Atlanta • Philadelphia • Worcester, MA

USE "PENNVERNON" . . .
NOT JUST "WINDOW GLASS"



THE name "Pennvernon" means "quality" in window glass. It means transparency, resulting in good vision. It means a freedom from distortion, a brilliance of finish and reflective qualities extraordinary in a sheet glass. And it means better windows...because of a better window glass.

DISTRIBUTED BY

W • P • FULLER & CO

NEWS AND COMMENT ON A

TWO NEW ATTRACTIONS AT THE SAN FRANCISCO MUSEUM OF ART

A new course on Music started at the San Francisco Museum of Art October 7 and will be followed by a series of three more meetings for public attendance at an 83-cent admission charge for each meeting. The course is conducted by Mrs. Cecil Hollis Stone, pianist, and well known accompanist and chamber music player, student of musical history and form. Her lectures will form an admirable introduction to this year's symphony series, as well as a sound basis for musical understanding in general. The Museum regards this and similar courses on related arts as an important part of its contribution to the cultural activities of the community, and feels that no living art is outside its province, because of the constant influences the arts have upon one another and their parallel courses of development in our time.

Through October the San Francisco Museum of Art offers a dramatic presentation of "Ships For Victory," organized by the Portland Art Museum to give the community insight into what was being done to hasten victory, in the shipyards of the region. Here in San Francisco, the exhibition has a double interest: it illustrates in a general way a process going on tirelessly day and night in our own shipyards and it focuses attention on the accomplishment of another important center of the Pacific Coast. This is the first showing outside Portland. The exhibition will tour.

PHOTO EXHIBIT OF MODERN BRITISH ARCHITECTURE AT LEGION PALACE

Several excellent shows are attracting art love to the California Palace of the Legion of Honor. San Francisco this month. Outstanding exhibitions include—

"British Architecture," selected by the Royal Institute of British Architects for the New York World's Fair of 1939-1940. There are 92 photographs, giving a comprehensive idea of modern building in Great Britain, showing churches, flat office buildings, hospitals, factories, underground stations, airports, bridges, and so forth.

"Action Photography," circulated by the Museum of Modern Art, opened October 15. This exhibition traces the gradual reduction of exposure time in photographing action from the first snap shot of moving figures taken by Eadweard Muybridge in the 1880's to the amazing "stroboscopic or high-speed photography of today.

"From Gericault to Renoir," is a cross section of the graphic arts created by the French Masters of the 19th and 20th centuries. All works are original etchings and lithographs, some of the latter are colored. Included are, among others: The Faust Illustrations by Eugene Delacroix, works by Theodore Gericault, Honore Daumier, Gustave Dore, Paul Gavarni, Horace Vernet, Camille Corot, C. I. Daubigny, Edouard Manet, Paul Cezanne, Camille Pissarro, Alfred Sisley, H. de Toulouse-Lautrec, Paul Gauguin and Auguste Renoir.



SELF-PORTRAIT, 1943

DORIS ROSENTHAL

The above painting by one of America's leading women artists is among the most amusing and "far-fetched" of the more conventional self-portraits in the current De Young exhibit. Miss Rosenthal has invited us to meet not only the artist, but a whimsical, giggling crew of "muchachitos" encountered during a recent trip to Mexico. A patient burro for her perch, pallet, brushes and flit-gun in hand, and with tongue in cheek, the artist sets out—new paintings to conquer!

LEGION OF HONOR DRAWS HOOPER PAINTINGS

Adding immeasurably to the wealth of fine art in San Francisco's California Palace of the Legion of Honor, Albert Campbell Hooper, of Palo Alto, has just presented his valuable collection to the museum.

Included are 19 paintings by Dutch, Flemish and English masters; a bronze bust of Benjamin Franklin by Houdon; 25 pieces of furniture; approximately 100 pieces of porcelain, and miscellaneous decorative objects.

Paintings include: Portrait of a Man, and Earl of Pembroke and Montgomery, Anthony Van Dyck; William Sotherton, George Romney; Lady Elizabeth Churchill; John Hoppner; Cottage Scene; Isack van Ostade; Portrait of a Woman and Portrait of a Man; Nicolaes Maes; Ripperd van Groe vendijk and Claudina van Groe vendijk; Paulus Moreelse; Jemint Sainsbury; Thomas Beach; Self-Portrait, Cornelis J. Van Ceulen; Portrait of a Woman, Quiryn Brekelenkam; Landscape, J. B. C. Corot; Portrait of a Man, Gonzalez-Cockes; Portrait of a Woman, Gabriel Max.

AN EVER CHANGING WORLD

PORTLAND ART MUSEUM OFFERS DIVERSE EXHIBITIONS THIS MONTH

During October the Portland Art Museum is presenting two very diverse exhibitions. "America in the War," a collection of one hundred prints by American print-makers, is being shown concurrently with twenty-five other museums in the country. This is of particular interest in Portland, where the Museum last month presented an exhibition, "The Road to Victory," in which the story of America at war was conveyed photographically. The same subject, translated by the imaginations of creative artists, offers interesting contrast and demonstrates the fixed and separate fields of photography and creative art.

The second October exhibition is the work of Emilio Pettoruti, whose paintings were seen in San Francisco last year and which have been touring the country since that time. Introduced to America

by Dr. Morley, this Argentinian has been making his mark as an abstract painter of scientific penetration and controlled vigor. With the exhibition at Portland he has circled the entire country, and at least in the field of art Argentina has been demonstrating a will to good neighborliness.

MURAL DESIGNS IN SPRINGFIELD COMPETITION TO BE EXHIBITED

Following is the itinerary for 1943-1944 exhibition of the winner and twenty-five other designs selected from the Springfield Museum of Fine Arts' \$4500 mural competition:

October—Yale University, New Haven, Conn.

November 1-19—Miami University, Oxford, Ohio.

November 22-December 10—Cleveland School of Art, Cleveland, Ohio.



CARD PLAYERS
Oil on canvas by Karl Hofer

Albert Bender Collection,
San Francisco Museum of Art

LIGHT FOR EYES WITH WORK TO DO

This season of this year—right now, and for the next few months—your family is going to need the best electric light you can provide. Next Spring and Summer the need will not be so great—but now good light is imperative.

Short daylight hours make artificial lighting in your home more important, not only for normal seeing, but for all those increased seeing tasks imposed by school work, and long evenings of study, reading and other seeing tasks.

This year the problems of attaining good lighting are greater than usual because electricity is a wartime essential and must not be wasted. Each lamp must deliver full value in light for the electricity it uses.

In order to do this, a few simple rules should be observed:

1. Reflectors, lamp bulbs, and shades must be kept **CLEAN**.
2. Shades open at the top and wide at the bottom distribute light best.
3. Shades with white lining deliver much more usable light than those with any tinted lining.
4. Group your furniture, and then place each lamp to serve as many persons as possible.

NORTHERN CALIFORNIA ELECTRICAL BUREAU

1355 Market Street
San Francisco



January—University of Illinois, Urbana, Ill.
February—Thayer Museum, Lawrence, Kan.
March—Molvane Art Museum, Topeka, Kan.
April—Kansas State Teachers College, Emporia, Kan.
May—University of Minnesota, Minneapolis, Minn.

June—Springfield Art Museum, Springfield, Ill.
Only one California artist is represented in exhibition, Nell G. Best of Lynwood.

NOTES FROM THE ART DIGEST

The Santa Barbara Museum in California has recently received as gifts three works by contemporary American artists.

Lt. Wright S. Ludington gave into the permanent collection Yasua Kuniyoshi's "Weather-vane and Objects on Sofa," a widely exhibited canvas and Charles Sheeler's "Still Life" of a white pitcher and gladioli. Mr. and Mrs. Arthur Sachs gave to the Museum a figure study drawing by Jack Geary Stark which will be added to the well known Ludington collection of black and whites.

* * *

The art dealer, Grace Nicholson, of Pasadena has given her spacious gallery—which is a white building and "more like a museum than a dealer's gallery," people have always said—to the Pasadena Art Institute which has turned it over to the Pasadena Art Institute.

Miss Nicholson, a specialist in Oriental art, will retain her home apartment for life and will be a resident advisor. The galleries will house the collection of the Institute and there will be space for exhibitions and possibly for art classes.

* * *

The closing of the exhibition of the Royal Academy marked what was considered the most successful London season in some years. A count of the visitors shows that more than twice as many people attended than during the same period of the year.

The sales of paintings during the first four weeks exceeded in value those for the whole period of each of the last four exhibitions. During the first four weeks 254 works were sold for approximately \$3,000. The total sales last year were 263 for \$26,000. Last year the National Academy, American counterpart of the Royal Academy, made eight sales from its annual exhibition.

* * *

It is somewhat uncanny that the only work of art to reach England from the Continent during the last three years was the exhibition of more than 100 pictures by British prisoners of war. This took place at Knoedler's in Bond Street, London.

* * *

Bringing their summer's art activities to a conclusion, the James Vigeveno Galleries of Los Angeles presented through September a collection of 17th century Dutch master paintings. At the opening of the exhibition, Dr. Adrian Hogart, Netherlands Consul, made a brief commentary, drawing a comparison between the present war and the conflict against Spain which raged in Holland in the 17th century.

WHAT'S ON YOUR MIND?

Letters to the Editor

LAGOON AIRPORT TERMINAL

and Engineer:
 to thank you for the extra copies
 uly Architect and Engineer with re-
 ions of the Keehi Lagoon Airport
 may be interested in the following
 received from John H. Frederick,
 of Transportation & Industry, School
 Administration, University of
 and Air Cargo Editor of Distribution
 housing magazine:
 "I recently been talking with people
 of the larger cities of the Middle
 airport planning problems, includ-
 ing building construction and plans,
 must say that your thinking on the
 far ahead of anything I have found

territorial Superintendent of Public
 Dan F. Balch, some months ago,
 the rapidly changing conditions, and
 anial development of air transport,
 uted steps to meet the situation as
 possible after the war. As a prelimi-
 nary plans are finished and the
 sy funds for working drawings were
 ated by the last legislature.

Best regards and aloha, I am
 Sincerely yours,
 HART WOOD,
 ulu, Sept. 7, 1943.

ENGINEERS AND ARCHITECTS REVOLT

and Engineer:
 led is a bit of news entitled "Engi-
 Architects in Revolt," which I be-
 you will find sufficiently interesting to
 for publication in your October

ers of the Engineers and Architects Asso-
 of Southern California have revolted in
 ver the high handed policies of some of
 ritors and have reorganized themselves as
 eers and Architects Institute of Southern

ew organization has opened offices at 24
 uth Street, Suite 589-590, telephone Medi-
 in Los Angeles.
 ggressive and forward-looking group of
 nd directors were elected at a recent
 of the Institute as follows:
 nt: Wm. C. Becker.
 sident: George A. Smith.
 ry-Treasurer: Lynn Hirsch.

Directors
 .. Dodge Herman C. Muhlbach
 A. Gary Herman C. Muhlbach
 eredith Joseph Whitman

aw of the revolt and unusual action taken,
 e of the history of the old Engineers and
 s Association is revealing.

	1938-1939	1942-1943
hip.....	150	1,776
Income.....	\$1,384.00	\$8,298.23
Condition	In debt	Solvent
Technical		
ents).....	25 (12 mo.)	1,800 (12 mo.)
	Indifferent	Outstanding

Sphere of Influence.. Los Angeles & Unlimited* Vicinity

*Members in both Armed and Civilian Services throughout the world continue their membership and request data and accommodations.

"This rapid growth was based on more than the war boom in Southern California. In fact, one of the principal inducements offered members was a highly efficient and greatly appreciated free employment service.

"One contributing factor for the revolt was the well-known resentment that has been accumulating in many technical minds over the questionable honor of working on important war projects for considerably less money than that frequently paid many mechanics. Faced on every front with revolutionary changes demanding leadership and bold action, it became obvious that the necessary progress could not be achieved in an organization that could be so easily stymied by directors who did not understand the responsibility of their positions, ignored the welfare and demands of its members.

"Refusal of some of these directors to resign upon request and later, to submit to a referendum vote presented but two alternatives: (a) Waste valuable time in a fight through the courts, with harmful publicity to the entire profession, or (b) Re-organize. The latter was the overwhelming desire expressed by the membership at called meetings and by mailed-in ballots.

"With plans being perfected to take the Engineers and Architects Institute one of the most beneficial and highly respected technical societies in the country, committeemen and members are out working with the zeal and determination of commandos.

"The policy of assisting employing Engineers, Architects and Industry in obtaining the best technical assistants available without cost to either employer or employee, will be continued, enlarged upon and perfected, as one of the functions of the Institute. This is not only regarded as a worthwhile accommodation to the members, but a very important contribution to the war effort in a territory where rapidly expanding industry is constantly in need of technical men of a thousand and one skills and experience.

"Five thousand members, with headquarters in an appropriate club-like atmosphere, offering many long desired accommodations, is the immediate objective of the Engineers and Architects Institute."

L. S. SANDERSON,
 3448 Fifth Ave., Los Angeles.
 9-12-43.

SAN JOSE POST-WAR PROGRAM

Editor,
 Architect and Engineer:
 The enclosed article describes a long-range, post-war industrial program which has just been launched by Santa Clara County, California.

This is the first large-scale promotion on the part of any West Coast Community during war-time, and is the forerunner of a marked post-war industrial expansion on the Pacific Slope.

As such, it may be of interest to your readers.

Yours very truly,
 RUSSELL E. PETTIT,
 Secretary, San Jose Chamber
 of Commerce.

Extracts from the San Jose article referred to follow:

"Plans for a \$55,000-per-year campaign to attract new industries to San Jose, county seat of Santa Clara County, California, were announced recently. The effort will be sponsored by the San Jose Chamber of Commerce, the San Jose newspapers, and public-spirited citizens. The board of county supervisors put up \$25,000, the city council \$20,000, and business leaders subscribed the rest.

"One phase of the movement will be extensive advertising in national business and trade magazines."

GOING STRONG AT 72

Editor,
 Architect and Engineer:
 I am back at my home in California once more—and very glad to be here, instead of Florida, where they have a beastly climate. The California Institute of Technology here is given over entirely to war work now—is a hive of engineers—and I am holding down a position there along with several well-known architects.

Yesterday I was lunching with one and telling him about the murals that I painted in Florida. He said, "Have they been published?" That put the idea into my head of trying again to see if I couldn't get one or more of them published. [See pages 30 and 31 this issue.]

I am rather proud of the fact that at the age of 70 I was able to teach blueprint reading (somewhat out of my line) to groups of boisterous marines, during regular class hours, and out of hours paint a mural frieze 35 feet long, that the senior officers, after seeing half of it painted, decided they wanted it in their own quarters—when it was originally intended for the lobby of their auditorium.

With kind regards, truly yours,
 ELMER GREY.

Pasadena, Cal.
 LOW COST HOMES
 Editor,

Architect and Engineer:
 I would like to obtain literature, pictures, floor plans, etc., on:

1. Low cost homes.
2. Week-end cabins or cottages.
3. General instruction on building.

Have you anything of this nature available? If so, I would appreciate if you would advise me of the cost of this literature.

Can you recommend any other possible source for this type of literature? I would be very grateful for any assistance you can give me.

Yours very truly,
 EDYTHE R. REGINELLI,
 3181 California, St.,
 San Francisco, Cal.

(1) and (3) Contact an architect. (2) Possibly California Redwood Association may have literature on week-end cabins or cottages.—Editor.

Doing the **WAR** JOBS

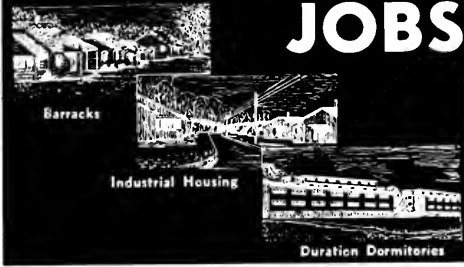

When labor is scarce and building hurried, call on Cabot's Shingle Stains for your war jobs. These stains are quickly and easily applied. They give maximum protection at minimum cost. And they do not peel or blister even when used on unseasoned lumber or before the building has dried out.

Booklet color card free



GUNN, CARLE & CO.

20 POTRERO AVE.
SAN FRANCISCO
UNDERHILL 5480

GET PEACETIME QUALITY

in Wartime Construction

★ ★ WITH KRAFTILE ★ ★

**No Priority • Immediate Delivery
End Building Bottlenecks**

Here are 5 big reasons why KRAFTILE CLAY PRODUCTS can be used to replace steel and other critical materials on *any* heavy construction job.

1. When it's built with KRAFTILE it's built to last; no upkeep cost.
2. KRAFTILE is waterproof, fireproof, stainproof, verminproof and scratchproof.
3. There's no quantity limitation on non-critical KRAFTILE Clay Products.
4. KRAFTILE saves up to one-half the time on interior walls... surfacing is unnecessary, since KRAFTILE WALL UNITS come pre-tiled one side, or both.
5. You can erect KRAFTILE installations in one-third the time required for old-fashioned frame construction. Only one craft is necessary for an entire job when you use KRAFTILE.

For more information,
phone or write today to

KRAFTILE
NILES, CALIFORNIA

LOANS TO CONTRACTORS

Government guaranteed V loans will be made available to war contractors and subcontractors on a much broader basis than heretofore, effective immediately, under a plan jointly announced by the War and Navy Departments, the U. S. Maritime Commission and the Federal Reserve Board.

The plan is designed to assure contractors that the working capital invested in war production will not be frozen in the event of contract terminations. Interest on loans guaranteed under the new program will be assumed by the Government upon termination of contracts as under present Regulation V guarantees.

This decision to broaden industrial credit facilities was reached with a view to preventing any lag in war production, which might be caused by fear on the part of contractors that their capital would be tied up as contracts are cancelled in response to swiftly changing war requirements. This broadened V loan will go far toward allaying such fears.

In the past, advances under V loans have been restricted, in general, to working capital needs for war production. The broadening of the plan will enable contractors to obtain the use of most of their own working capital immediately upon termination of the contracts. Banks will be enabled to make such advances at once, and with a minimum of complication.

The services stress the fact that cancellation of contracts must not be construed as marking the beginning of a general curtailment of war production. On the contrary, with the war rapidly becoming one of movement, with great Allied offensives in progress and in prospect, material requirements are subject to sudden and unavoidable changes, and it is essential to remove all possible causes of delays in war production.

PLYWOOD PRESIDENT OFFERS SUGGESTION

To permit prompt resumption of normal civilian production when the war ends, Lawrence Ottinger, president of the United States Plywood Corporation, has publicly urged that some procedure be developed for immediate settlement upon cancellation of war contracts of the claims of hundreds of thousands of prime contractors and their sub-contractors, suppliers and material men.

Mr. Ottinger suggests that banks be authorized to make payments on account of these contract-cancellation claims on the approval of certified public accountants, such action to be subject to ultimate Government review. The alternative to such an orderly adjustment of war contract-cancellation claims, said Mr. Ottinger, is chaos.

Post-war plans of the United States Plywood Corporation have been sufficiently perfected, Mr. Ottinger says, to give its "many qualified employees and associates now in the armed forces" assurances of immediate reemployment, as well as employment to "many more."

7 DEFINITE ADVANTAGES

SAL-MO SUPPLY DUCT

for Warm Air Heating, Ventilating and Air Conditioning Systems



- 1 Each SAL-MO SUPPLY DUCT carries the Underwriters' "INSPECTED" label for Heating, Safety and Permanence.
- 2 The unique folding feature of this DUCT saves space in cars, storage and transferring to jobs.
- 3 SAL-MO SUPPLY DUCT embodies built-in insulation, insuring years of fuel saving.
- 4 Superior lightness (less than 8 oz. per square ft.) combined with superior strength (Mullens Test over 400 lbs. per square inch) assures ease in handling and structural stability.
- 5 Fabricated entirely with insoluble adhesives, weather and high humidity cannot affect it.
- 6 Manufactured in 26 standard sizes (Areas from 26 square inches to 448 square inches—in 4-foot time-saving lengths) allowing for all types of installations.
- 7 Also furnished in flat sheets containing from 11 to 24 square feet which can be easily rolled or scored on the job.

SALL MOUNTAIN COMPANY

15 W. Adams Street Dept. A Chicago 3, Illinois

Index to Advertisers

*Indicates Alternate Months

A	
ALADDIN Heating Corp.....	*
AMERICAN Rubber Mfg. Co.....	43
ANDERSON & Ringrose.....	46
B	
BASALT Rock Company.....	43
BAXTER & Company, J. H.....	10
C	
CASSARETTO, John.....	48
CELOTEX Corp.....	*
CLARK, N., & Son.....	46
CLINTON Construction Company.....	45
COATES, Leonard, Nurseries.....	47
COLUMBIA Steel Company.....	11
CROCKER First National Bank.....	47
D	
DINWIDDIE Construction Company.....	48
E	
EL ENCANTO Hotel.....	*
F	
FORDERER Cornice Works.....	45
FULLER, W. P., Co.....	3
G	
GUNN, Carle & Company.....	8
H	
HANKS, Inc., Abbot A.....	46
HAWS Drinking Faucet Company.....	2
HERRICK Iron Works.....	46
HOGAN Lumber Company.....	45
HUNT, Robert W., Company.....	47
HUNTER, Thos. B.....	47
I	
IMPERIAL Brass Mfg. Co.....	35
INCANDESCENT Supply Co.....	46
INDEPENDENT Iron Works.....	46
J	
JENSEN & Son, G. P. W.....	48
JOHNSON Company, S. T.....	10
JUDSON Pacific Company.....	45
K	
KAWNEER Co.....	*
KRAFTILE Company.....	8
M	
MATTOCK, A. F.....	48
MULLEN Mfg. Co.....	47
MYERS Bros.....	2nd Cover
N	
NORTHERN California Electrical Bureau.....	6
P	
PACIFIC Coast Gas Association.....	*
PACIFIC Foundry Company, Ltd.....	10
PACIFIC Manufacturing Company.....	44
PACIFIC Paint and Varnish Company.....	38
PACIFIC Portland Cement Company.....	48
PARAMOUNT Built-In Fixture Company.....	*
PARKER, K. E.....	Back Cover
R	
REMILLARD-Dandini Co.....	48
REPUBLIC Steel Corporation.....	44
S	
SALL Mountain Company.....	9
SIMONDS Machinery Company.....	44
SISALKRAFT Company.....	43
STANLEY Works, The.....	*
T	
TORMEY Company, The.....	47
U	
U. S. STEEL Company.....	11
V	
VERMONT Marble Company.....	44
W	
WASHINGTON - Eljer Company.....	*
WESTERN Asbestos Company.....	*
WOOD, E. K., Company.....	10
WAR Bonds.....	3rd Cover

Take a buying tip from Uncle Sam
when you need
low-cost Hot Water!

Specify **AQULUX**
WATER HEATERS

That's what he is doing, and he ought to know . . . he's providing billions of gallons monthly for the Army and Navy alone. His hot water supply *has* to be dependable . . . and inexpensive. And it has to operate under the toughest working conditions that exist.

When Uncle Sam installs an Aqulux Water Heater in a Military Hospital . . . in an Army Mess Hall . . . or on board a fighting ship he knows what it will do, for he has checked its performance. He knows he is buying hot water as cheaply as it can be produced for the job in hand. And he knows he is putting in equipment that will deliver at maximum efficiency through years of severe usage.

If you have a water heating problem . . . either immediate or future . . . we suggest that you follow Uncle Sam's example; investigate the performance of Aqulux Heaters. Large-volume, heavy-duty models with capacities to 540 g.p.h. available for orders that have W.P.B. approval. We will gladly send complete data. S. T. Johnson Co., 940 Arlington Ave., Oakland, Calif., and 401 No. Broad St., Philadelphia, Pa.

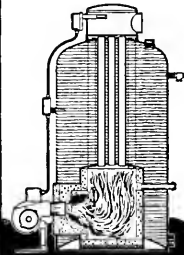

S. T. JOHNSON CO.

40 years of engineering and building fine Oil Burning Equipment



QUALITY AND DEPENDABLE
Service

are the factors that influence architects and contractors when selecting lumber and mill work — Quality of merchandise — Integrity and Ability of the firm—Service in physical equipment — Experience and Personnel — All these factors contribute to a speedy and satisfactory completion of construction with minimum of time and expense.

MANUFACTURER OR DEALER IN

Douglas Fir—Redwood—Sugar and Ponderosa Pine — Plywood and Concrete Form Panels — Sash and Doors — Millwork — Insulation — Builders' Hardware.

E. K. WOOD LUMBER CO.

"Goods of the Woods" ©
LOS ANGELES • SAN FRANCISCO • OAKLAND



PRESSURE TREATED LUMBER
● **PROTECTS AGAINST DECAY**
AND TERMITE ATTACK

Specify it in your home
Available through Lumber Dealers

LOS ANGELES
601 W. 5th Street
Phone Michigan 6294

SAN FRANCISCO
333 Montgomery Street
Phone DOugles 3883

J. H. Baxter & Co.

AGENTS FOR WEST COAST WOOD PRESERVING CO. SEATTLE, WASH.

CORROSIRON

U. S. REGISTERED TRADE MARK

an acid resisting alloy for

Pumps • Valves • Chemical
Coatings • Drain Pipe & Fittings

ARCHITECTS AND ENGINEERS
ENGAGED IN WAR HOUSING
AND POST-WAR PLANNING MAY
CONSULT OUR ENGINEERING

DEPARTMENT WITHOUT
OBLIGATION



PACIFIC FOUNDRY COMPANY LTD.
Engineers and Metallurgists

3100 - 19th Street
SAN FRANCISCO

NEW YORK

SAN FRANCISCO

LOS ANGELES

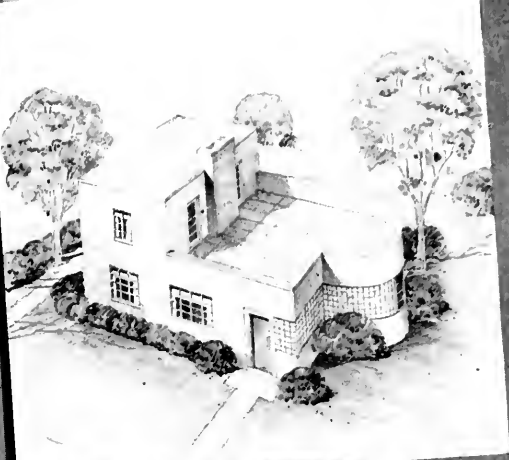

Marching back to . . . *What?*

DURING the first six months of peace, a U. S. Chamber of Commerce survey indicates that 1,015,000 families intend to build or buy new homes—592,000 intend to modernize kitchens—496,000 plan new bathrooms.

But what kinds of homes? How importantly will advanced design, improved construction and new materials influence their planning?

Architects and builders already have the answers to many such questions in the versatile performance of steel, not only in industrial buildings but also in dwellings. These qualities will serve an even more important need when it comes to designing the "homes of tomorrow." Modern construction will create many new demands for which the use of steel is a practical "must."

For no other material can serve so many purposes so well. Wherever there is need for strength, durability, resistance to the elements and fire there will be found a steel suited to that need. Mass production of prefabricated units, which seems destined to increase, is just one of the instances in which steel can serve to advantage.

We have collected a fund of valuable information concerning the most frequent uses of U·S·S Steel Products in home building. This information makes interesting reading in a fully illustrated brochure, "85 Ways to Make a Better Home." Just drop us a line and we shall be glad to forward you free copy.

★ BACK THE ATTACK . . . WITH WAR BONDS ★

U·S·S STEEL SHEETS

COLUMBIA STEEL COMPANY, *San Francisco*

CARNEGIE-ILLINOIS STEEL CORPORATION, *Pittsburgh and Chicago*

TENNESSEE COAL, IRON & RAILROAD COMPANY, *Birmingham*

United States Steel Supply Company, *Chicago, Warehouse Distributors*

United States Steel Export Company, *New York*

Properties and advantages of Special U·S·S Steels

U·S·S COPPER STEEL—Twice the atmospheric corrosion resistance of plain steel. Furnished black or galvanized for gutters, downspouts, flashing, duct work for air-conditioning systems and furnace construction.

The cost of U·S·S Copper Steel is so close to that of plain steel that it adds less than one dollar to cost of sheet metal work in average building under \$6,000.

U·S·S VITRENAMON—A galvanized Bond-erized Steel. Permits immediate painting. Paint holds tighter, lasts longer. Highly recommended for all outdoor uses such as gutters, downspouts, ducts, and all sheet metal work.

In the South and West, U·S·S Dul-Kote, with properties similar to Vitrenamon, is available.

U·S·S VITRENAMEL—Porcelain on U·S·S VITRENAMEL has almost unlimited possibilities both for interiors and exteriors. Base metal is easily formed into attractive shapes. Porcelain finish is durable and easily cleaned.

Ideal for wall panels, roofing, shingles, shutters, tiling, and bathroom, kitchen and laundry equipment. For bathtubs, lavatories, sinks, stoves, refrigerators, washing machines, hot water heaters, laundry trays, specify U·S·S VITRENAMEL.

U·S·S STAINLESS STEEL—a "perfect metal" for sinks, drainboards, work surfaces, kitchen and bathroom trim—any place where a permanent, sanitary and beautiful service is desired.



UNITED STATES STEEL

PLASTICS

FOR THE ARCHITECT

Henry O. Belleville

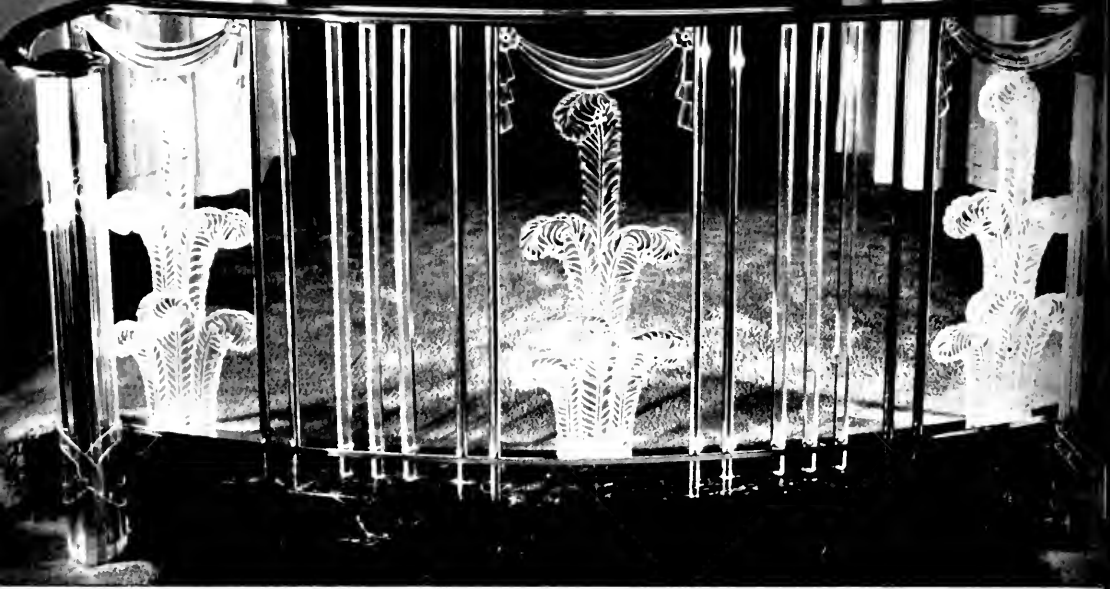

Balustrade
Plastic
in Apaque
Forms

Popular imagination has cast plastics in a glamor role among modern structural materials in re-building the post-war world. Plastic penthouses, synthesized from coal, air, and water, with a variety of conveniences known and unknown, are envisioned by the layman.

What is the prospect for the materialization of such a concept? If the architect is to be an Aladdin, he will be fore-armed for peace by exact data that will enable him to bring the popular flight of fancy down to earth, and recognize the limits within which he may expect to exploit the versatile functions of this new material.

Its possibilities are challenging. For the house of the future is likely in many instances to be made of standardized, mass-produced parts. Modern plastics are a creation of the mass-production age and as such were conceived and designed to fit into other mass-production processes.

In the chemical wonderland which gave birth to plastics, the architect, aware of the steady advance of synthetics from mere substitutes for existing materials to replacements of these, is

finally to a dominant position in a specialized field all their own, may be forgiven for harboring a belief that almost anything is rather more than likely to be possible.

It is the purpose here to report on the presently discernible limitations within which the designer may hope to count on plastics in projecting buildings of the future. It is said that an all-plastic house has been exhibited in Europe. Be that as it may, no attempt is made here to forecast the likely the prospect that these labor-

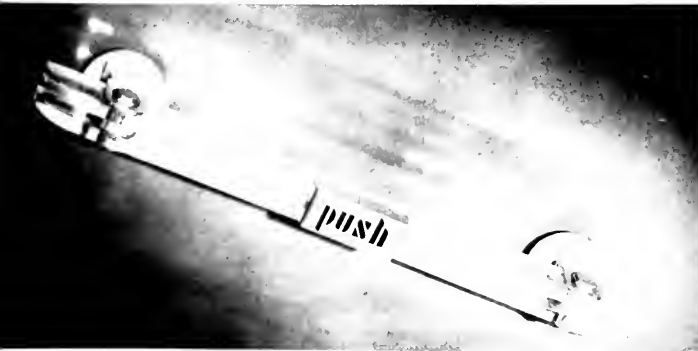

DOOR PUSH BAR OF "LUCITE"



**"Louverplas"
Shields for
Fluorescent
Light**

or creations are to be built on a mass-production scale.

Research workers responsible for the development of the new plastics are men of imagination. Their vision is due the progress of the industry at a rate and in directions that have glamorized the product in the public view. But they are scientists. And long ago they left off mere duplication of natural substances. Today, as in the acrylic resin plane noses, they set their goals by practical structural specifications and build to meet these.

PLASTICS IN POST-WAR PLANNING

Therefore, it is not surprising to find that in response to demand already widespread, plastics have been finding their way increasingly into housing. Under the impact of war still further adaptations are being perfected as plastics survive the rigors of service in the world's battle machines, exceeding oftentimes the performance of older materials in similar applications. In the coming peace, it is already obvious, they will continue to widen the field of their utility and increasingly attract the architect.

Plastics are produced in two broad classifications—thermosetting types, which, in a cycle somewhat analogous to that whereby a mass of soft clay is transformed by heat into a hard brick, take permanent form through heat-treating processes; and thermoplastic, which assume functional form, like molten iron, under heat, but which, like iron, maintain that form only below the molding temperature. Combination of both is achieved by pressure under heat.

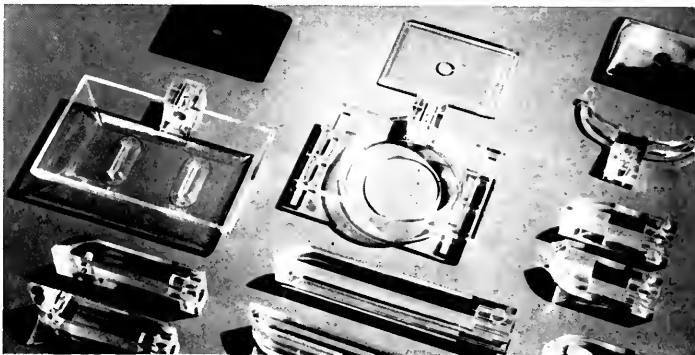

BATHROOM FIXTURES OF CRYSTAL-CLEAR PLASTIC



Within these two divisions, the industry recognizes distinctions between two further classifications. While many objects are formulated from plastics as such, certain plastics and related compositions are used as bonding agents or adhesives. As a bonding agent, they serve to unite non-plastic materials, either as an adhesive joining laminations of the non-plastic—wood or paper, for example—or as an impregnant to bind together non-plastic particles.

Among plastics adapted to a wide variety of uses for the architect or designer's purposes is "Lucite" methyl methacrylate resin. It is of the thermoplastic type. War allocations now consume the entire supply. But with the coming of peace, the designer will find a host of applications tried, tested and ready for enhancing the interiors of the homes of the future.

BATHROOM FIXTURES OF "LUCITE"

"Lucite" is fabricated into the clear, high-visibility housings from behind which our airmen fight the enemy. It is used for the cockpit, turret and blister enclosures, and "green-houses" of the big bombers. It is optically clearer and weighs less than glass.

When peace releases this product for general consumer use, it is destined for an important place in the home. In bathroom, kitchen or wherever plumbing handles, faucets, towel racks, soap cups, toothbrush and glass receptacles are required, it will offer opportunities for superior decorative and modern treatment. Transparent or colored opaque formulations present a varied choice for esthetic enhancement in these interior applications. The plastic has especial appeal in the form of extruded moldings.

It will be a valuable adjunct in the designing of illuminating fixtures, a use to which it has already been applied. This synthetic possesses properties for carrying light around its own curves and seems bound to reward the study of the pioneering designer able to exploit this unique quality for carrying illumination around corners.



Upper left: Plastic screen.

Below: Paint brush with natural bristles (left) and brush with tapered Nylon bristles (right). Latter wears three times longer than natural bristles.

"Plastacele" cellulose acetate plastic is another of the synthetic family which will find acceptable applications in the lighting field. In the form of "Louverplas," it will function as a pleasing director for the fluorescent type of lighting.

Nylon, the dramatic triumph of ten years of chemical research in the synthesis of plastics from coal, will emerge as a valuable aid to the builder in the post-war era. Famed among the public as a superior textile filament, of inestimable value as the life-raft of the airways in parachutes, the needs of the nation's military program have speeded perfection of its uses, opening up ever broadening areas of utility that stir the imagination of the designer.

WINDOW SCREENS OF NYLON

Window screens of nylon that can be rolled up, out of the way like shades, have been tested and will be available in volume after the war. Resistant to weathering, nylon screening will prove a boon to the architect. These screens will eliminate the disfigurement inevitably encountered when metal screens rust and corrode and pour staining streams of water on sills and other painted woodwork.

Development of nylon as a woven upholstery cover for seats and benches offers a challenging opportunity for the use of color in the treatment of breakfast nooks or sun porches.

Nylon bristles for paint brushes today are allocated solely for war use. But it may well be that their demonstrated superiority over animal bristles may find recognition in the specifications of the discriminating architect in his search for the highest quality finishes in post-war paint jobs when the decreasing needs of the war program release nylon for consumer use.

"Fabrikoid" pyroxylin-coated fabric represents an adaptation of plastic treatment which enjoys recognized advantages over many older materials in a variety of uses of interest to the architect. As an upholstery covering, it is superior because it is washable, durable, and

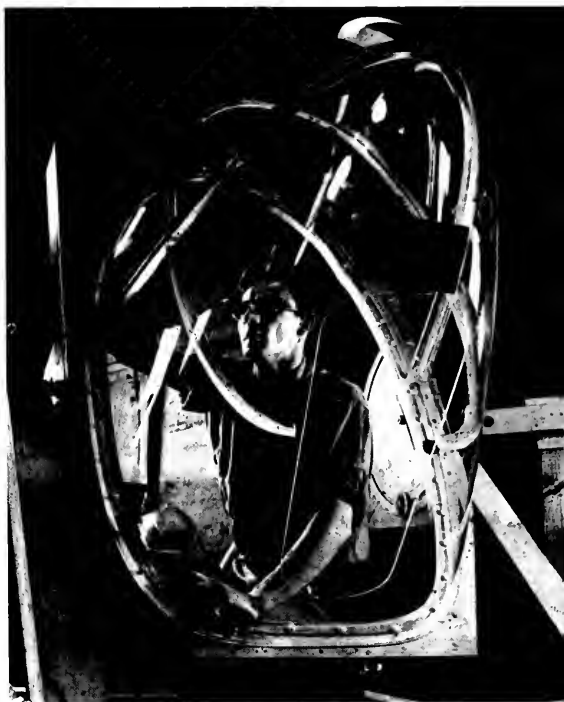

Upper right: Plastic nose for a Martin bomber.
Lower: Nylon plastic for post-war industry—rope, parachute cloth and bristles.

Note: All illustrations courtesy Du Pont De Nemours Co.

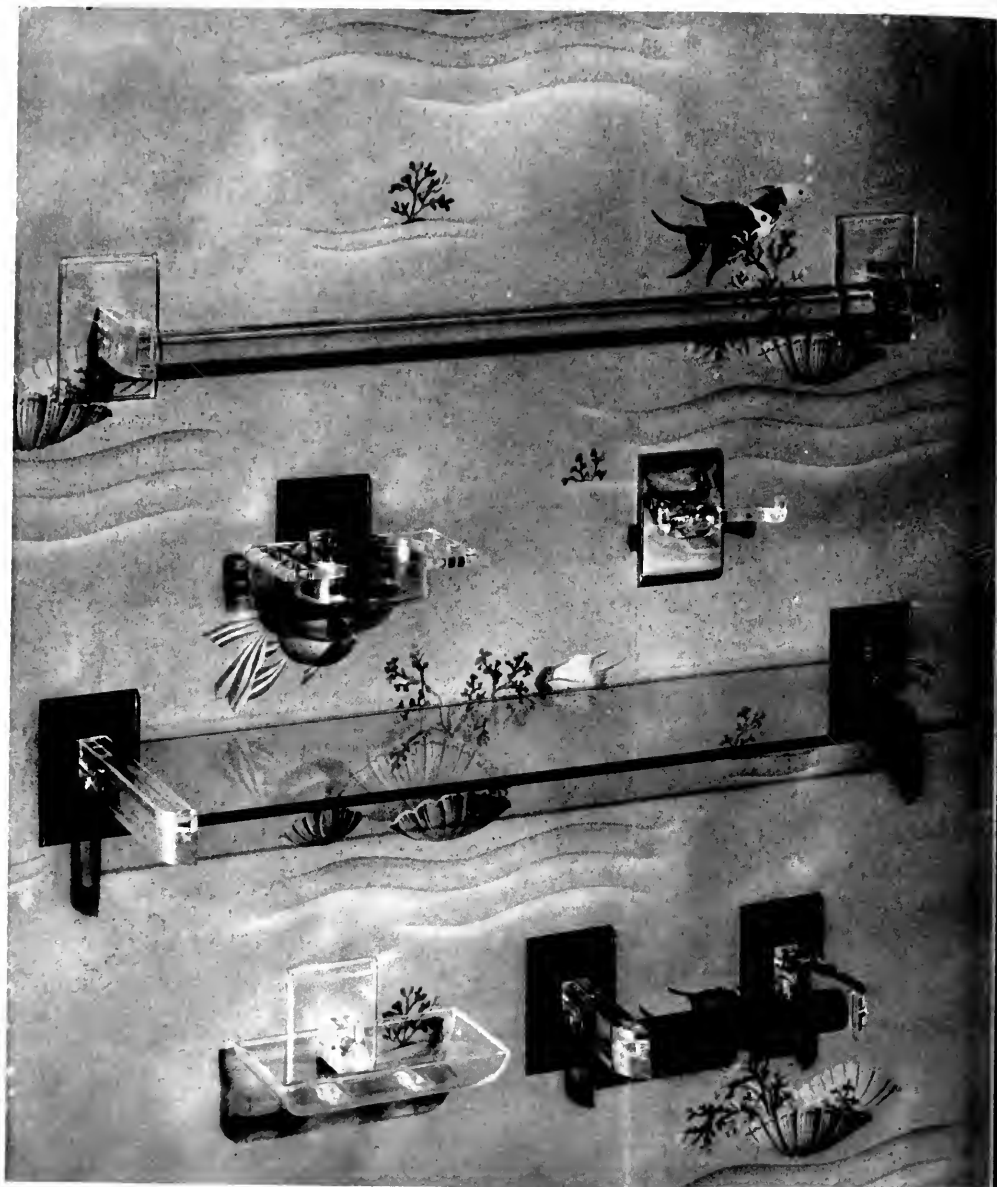

When victory releases plastics from uses for war purposes, decorative bathroom fixtures such as these made of "Lucite" methyl methacrylate will once more be available. Tumbler holder, wardrobe hook, soap dish, brackets and wall plates show in this pre-war group are of plastic construction. Styles of wall plates are completely transparent or with underneath finish in black or in chromium effect.



A light shone at one end of this snaky rod of "Lucite" methyl methacrylate resin—travels to and out the other end without heating the crystal-clear plastic. Ability to "pipe cold light around curves" makes the material particularly adaptable to medical instruments. A plastic gas mask lens is shown with the bent rod.

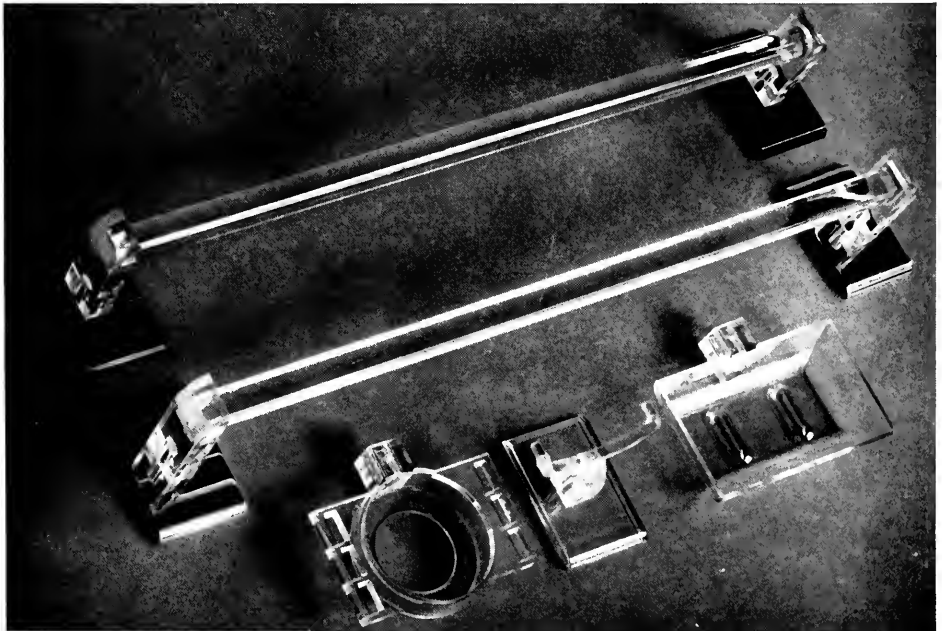

Decorative plastic bathroom fixtures pictured above include tumbler holder, wardrobe hook, soap dish, brackets and wall plates. Styles of wall plates are completely transparent or with underneath finish in black or in chromium effect.

colorful. Wearing qualities and scuff-proof properties have already won "Fabrikoid" wide acceptance among architectural specification writers as the covering for seats in theaters and public places.

Plywood adhesives recently perfected for the aviation industry make use of plastics or synthetic resins as a bonding agent. These will be available in great quantities after the war. Thin sheets of veneer bonded with these new plastic "glues" can be bent or molded into practically any shape desired.

Plywood furniture, light walls and movable partitions as strong per unit of weight as steel, are foreseen as holding the promise of inexpensive and durable housing for tomorrow.

Plasticizing is among the treatments chemical science has developed to endow wood with qualities that vastly improve upon nature. The chemist will be able to supply the post-war building industry with lumber so treated as to be a distinctive structural material in its own right.

PLASTICS FOR DECORATIVE FEATURES

Looking ahead, the designing architect may with confidence assume a widening and increasingly versatile field of plastics will develop for use in decorative features of bathroom, living rooms, and kitchens, in bars and lounges, theatre lobbies and soda fountains or gas stations wherever a distinctive and modern note is to be sounded.

Venetian blinds have been made of trans-

lucent plastics and colorful treatment has been achieved for ballrooms through the employment of plastic panels.

An advantage possessed by plastic door-knobs over the metal kind is their high-insulating value. Static electricity stored in the human body won't discharge a spark when the hand grasps the plastic knob. Wear resistance is a superiority of plastics adapted as thresholds while escutcheons and electric switches of the material offer scope for decorative enhancement, and plastic floats for flush tanks have proved longer lasting than the metal types.

Adaptations of plastics as embellishments, decorations and structural components of furniture and furnishings and building appointments are myriad and will multiply when war releases the synthetics for civilian use. Among the long list appear such items as shower curtains, cabinets, ceiling panels, store facades, moldings, drainboards, insulating materials, wainscotings, and electrical fixture parts.

All these and the other mentioned uses for plastics in the building field indicate the extent to which the designer may let his imagination roam in bringing down to earth the air-castles inspired in the modern man's fancy by the romance of synthetics. An all-plastic dwelling may now seem but a fantasy of the distant future but the most up-to-date house of the year-after-the-war will be a shining landmark of the progress toward ever-widening applications of plastics by the architect.

PLYWOOD SURFACES TO HAVE METALLIC SKINS GLUED WITH PLASTIC

Howard Blakeslee, Associated Press science editor, writes of a new post-war use of light metals which may be pressed into thin sheets or "metallic skins" and used in prefabricated houses, plywood surfaces, kitchen assemblies, etc. A plastic glue makes these innovations possible.

All that is needed to make this metal skin a permanent part of a structure is a glue which will form a bond as strong as the materials it sticks together. Two such glues have been announced recently.

One is reanite, a product of the United States Stoneware Company, New York City; the other is cycleweld, a product of the Chrysler company and of the Goodyear Tire and Rubber Company.

Both are plastics. Both, under mild heat and pressure, bond metal to metal, to rubber, to plastics, or any one of the three to any other. The bonds, in laboratory tests, are as strong as the original materials.

Lightweight stainless steel or aluminum is easily bent or dented. But combine it with moisture-proof and fire-resistant plywood and the resulting material is rigid, strong, not easily dented, and very light in weight. In addition, such a structure is expected to have good sound-insulation.

Plywood is easily bent and molded. The metal skins will bond perfectly over curved surfaces. These plastic bonding materials enlarge the usefulness of thin metallic sheets enormously, for very thin metal is not always easy to rivet or to weld.

The stoneware people believe that bonding will produce the nearest thing yet to a vibrationless and noiseless era after the war. This

will come from the enhanced use of rubber as a cushion. Bonding rubber to metal is not new. But the stoneware executives say that nothing like the strength of bonds for rubber now possible have been available. Present specifications for automotive manufacture are based on a rubber-to-metal bond able to withstand 250 to 300 pounds pull.

For reanite, a bond five times stronger than this specification is claimed. This means that heavier machinery can be cradled in rubber. The vibration strain should be lessened both for buildings and for the machines themselves.

Another possibility is a new form of metal, made by combining powdered metal with the bonding liquid. Powdered metals at present are molded into solid metals under heat and pressure. The reanite bonding material combines with powdered metal to form a cement. This material, still under laboratory tests, gives promise of reacting like a plastic. It follows difficult molding contours with ease.

The metal glues already are in industrial use, for joining lightweight metal structures where riveting and welding would be cumbersome. The layer of plastic glue is only about as thick as the adhesive used to seal an envelope. It is sprayed or painted on the surfaces to be joined, or laid between them as a thin tape.

This process does not promise to supplant nails for building houses, or to produce steel ships fastened by metallic glue instead of by welding. It is intended for use with lightweight metals, rubber (natural or synthetic), wood, leather, glass and ceramic materials.

Promising uses are in some parts of prefabricated houses: kitchen assemblies, refrigerators, and bonding of copper and zinc engravings to wood blocks.



BETA THETA PI FRATERNITY, STANFORD UNIVERSITY, PALO ALTO

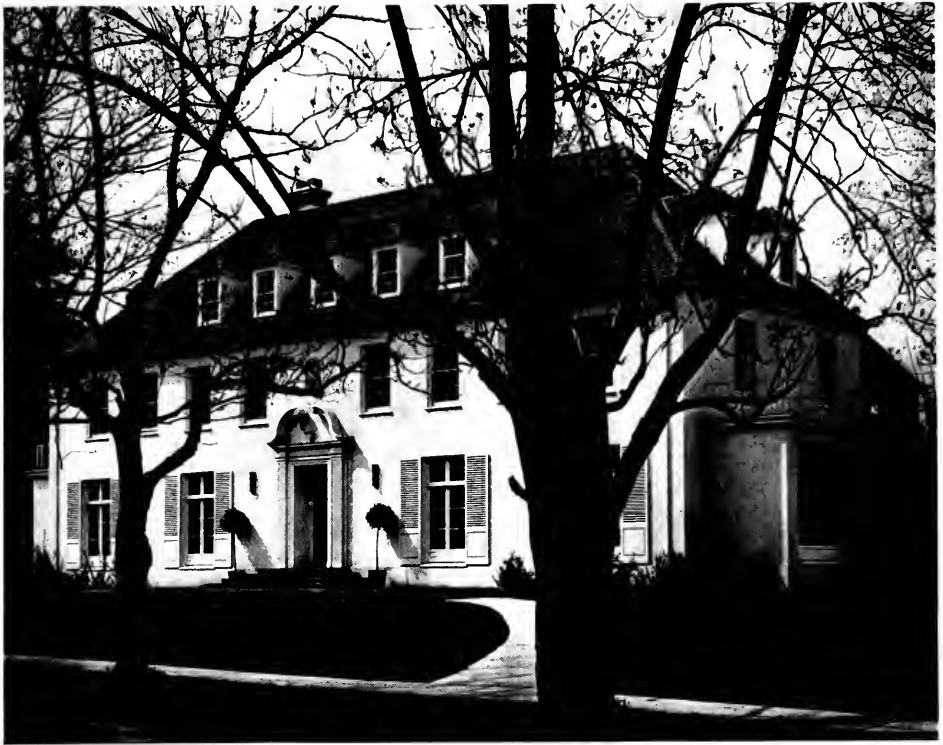

SIGMA CHI FRATERNITY, STANFORD UNIVERSITY, PALO ALTO

THREE FRATERNITY HOUSES BY JOHN K. BRANNER

Completed shortly before Pearl Harbor these well designed fraternity houses at Stanford University housed their members but a short while. The Army moved in soon after war was declared and will probably continue in possession until Hitler and Hirohito are decisively whipped.

Sigma Chi house is entirely new, while Beta Theta Pi and Chi Omega were alteration jobs. Modernized Georgian, Sigma Chi has several interesting features—viewing the exterior one would not suspect that the row of dormer windows light the Chapter hall which occupies the entire top floor. A modern staircase, which the members facetiously dubbed the "Hedy Lamarr," and two huge marble fireplaces are worthy of mention.

Chi Omega Sorority house has a New Orleans balcony across the front which gives the building an atmosphere of the South. Beta Theta Pi has the Mt. Vernon motif. In connection with the Chi Omega alterations, Mrs. David Livingston of San Francisco was the moving spirit behind the project and it was largely due to her tireless efforts that the funds were raised for the improvements.

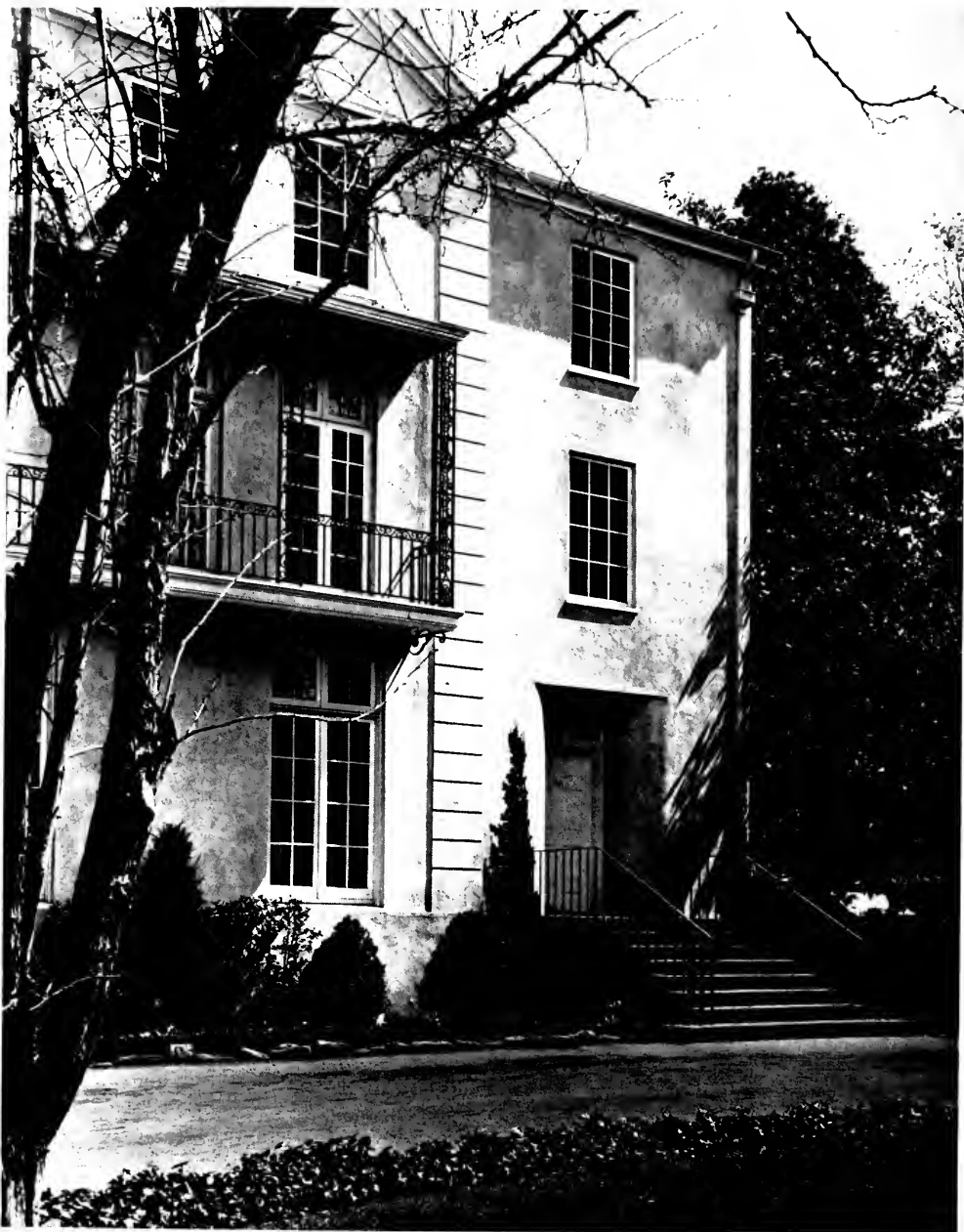

CHI OMEGA HOUSE, STANFORD UNIVERSITY, PALO ALTO



GENERAL VIEW OF BAYVIEW HEIGHTS, SAN DIEGO, CALIFORNIA

TWO WAR HOUSING PROJECTS AT SAN DIEGO

Two Federal public housing projects in San Diego are cited as better than the average in design and site planning, consequently are attracting nationwide interest by housing authorities. One project is at Bayview Heights, the other at Mission Beach. The former stretches over some 18 acres of fairly rugged topography six miles from San Diego's manufacturing district. Mission Beach is known as the Los Altos project. Both undertakings were carried through by the following personnel:

LANGDON W. POST, Director, Region 10.

RAYMOND W. HANSON, Area Project Engineer.

AUBREY M. DAVIS, Housing Manager, San Diego Area.

ARCHITECT-ENGINEERS: Frank L. Hope, Jr., Architect, and Edward Morehead.

GENERAL CONTRACTORS: Myers Brothers.

Bayview Heights has 127 units, 16 of which are one-bedroom units, 79 two-bedroom units and 32 three-bedroom units.

By extension of services, it was possible to utilize the city's sewer and water systems and the utility company's gas and electrical services.

All units are placed to conform to the natural contours, to get a maximum of sun, and to obtain advantage of the view from the principal rooms. Units are also placed so as to form courts in order to obtain maximum open spaces and privacy for living and service areas. The service courts are screened with wood fences to hide the clothes lines and service entrances. Two units are placed close together in such a manner that in future time the property may be divided into lots and sold with each lot containing two houses or a two-family dwelling, if such a procedure is feasible. Houses are prefabricated and demountable so that they may be readily moved to another site. In addition, the units are placed to keep the one, two and three-bedroom units together in courts, thus insuring neighbors with no children or the same number of children to be together.

The project was planned for a minimum of new streets in order to keep down the initial and maintenance cost; parking areas are located off the streets.

All the units are placed on concrete pier foundations, are of prefabricated plywood with exterior water-proof plywood walls, and plywood roof covered with composition. The

**FEDERAL PUBLIC
HOUSING PROJECTS
SAN DIEGO
CALIFORNIA**

**FRANK L. HOPE, JR.,
Architect**

**EDWARD MOREHEAD,
Site Planner**

**MYERS BROS.,
General Contractors**



**Row of houses placed to conform
to contour of site,
Bayview Heights,
San Diego, California.**

Illustrations courtesy Southwest Builder
& Contractor

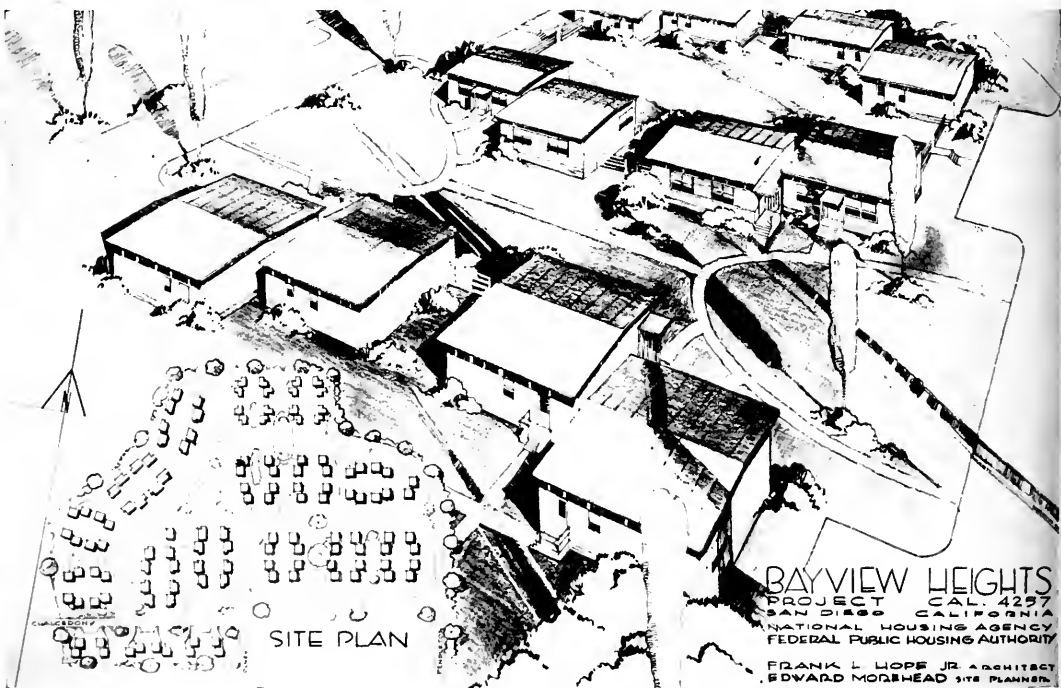

SITE PLAN

BAYVIEW HEIGHTS
PROJECT CAL 4257
SAN DIEGO CALIFORNIA
NATIONAL HOUSING AGENCY
FEDERAL PUBLIC HOUSING AUTHORITY

FRANK L. HOPE, JR. ARCHITECT
EDWARD MOREHEAD SITE PLANNER



Trees on site of Bayview Housing Project restricted necessity for landscaping to lawns and planting on banks to prevent soil erosion.

interior walls and ceilings are plywood. Sliding type windows are large and double hung. The units are equipped with gas ranges, automatic water heaters and portable oil circulating type heaters. Bathrooms have bathtubs and linoleum floors. Kitchens also have linoleum floors and

are provided with large storage space and laundry facilities.

The houses are painted light pastel colors, each court having different color combinations. The base of each dwelling is painted in a contrasting color to accent the modern lines.

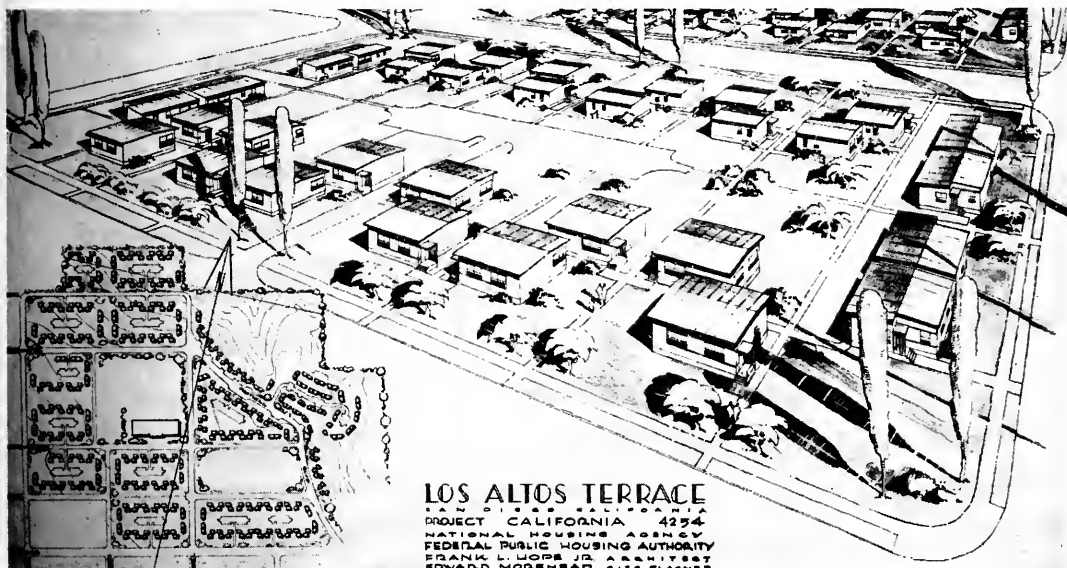

LOS ALTOS TERRACE
 SAN DIEGO, CALIFORNIA
 PROJECT CALIFORNIA 4254
 NATIONAL HOUSING AGENCY
 FEDERAL PUBLIC HOUSING AUTHORITY
 FRANK L. HOPE, JR. ARCHITECT
 EDWARD MOREHEAD, SITE PLANNER



Los Altos Housing Project, Pacific Beach, San Diego. The site had been partly developed for a residential subdivision.

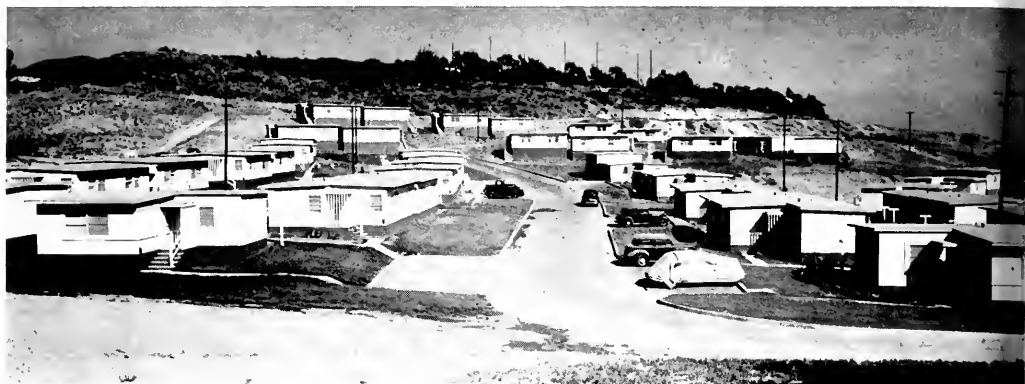

Development of site, type of buildings and their block arrangement is shown in view above.

The landscaping work includes lawns for most of the areas. On the steeper banks, mesembryanthemum was used for erosion control as well as for color. The streets are paved with asphalt and walks are of cement.

LOS ALTOS HOUSING PROJECT

The site for the Los Altos Housing project on the upper slopes of Northwest Pacific Beach, overlooks Mission Bay, Mission Beach and the ocean. Originally it was about half developed with certain streets and utilities in place. The other half was undeveloped on the hillside and of steeper contour. The project includes 428 houses or units, of which 68 are one-bedroom units, 256 two-bedroom units and 104 three-bedroom units. The site covers an area of 89 acres and is about eight miles from the industrial section where the tenants are employed.

In developing the area where blocks were

already established, each block was worked out into a large court with all units staggered to avoid monotony. Parking and service areas are located in the courts inside the lot. This keeps the parking off the streets and gives play and work areas seclusion from the street and a certain amount of privacy.

Units in the undeveloped part were placed so as to fit the contours and to take advantage of the view from the principal rooms. Two units were placed close together in such a manner that in future time the property can be divided into lots and sold with each lot containing two houses or a two-family dwelling, if such a procedure is feasible. The houses are prefabricated and demountable so that they may be moved to another site. In addition, the units are placed to keep the one, two and three-bedroom units together in courts, following the same idea as carried out at Bayview Heights.

ARCHITECTURAL PROFESSION NEEDS A VOICE

By LOUIS LA BEAUME, F.A.I.A.

At the present moment the architectural profession finds itself in a state of utter demoralization. The causes of this demoralization are numerous. Some of them may be due to circumstances beyond our immediate control; others are not. In any event, it may be well to consider them seriously and to analyze and discuss them with courage and candor.

It is shocking to discern so many symptoms of confusion in all the talk that goes on about architecture and the future of the architect. Even the old terms "Architecture" and "Architect" are being used more and more sparingly, as though they might hint at some taint or stigma. To refer to architecture as an art is no longer permitted in certain circles, and any chance reference to beauty makes the average architect hang his head in shame.

Until a few years ago the architect believed in himself and in the dignity of his calling. He was respected in his community as a man apart from the jerry builder or the structural engineer. By reason of his special qualities and as the result of his training, he had been able to cultivate the public appreciation of Architecture as an Art, differentiating it from mere building. Owing largely to the leadership and inspiration of the Institute he had succeeded in organizing his professional concepts in such a way as to win the respect of the more intelligent elements of society. By them he was considered not a futile visionary, a dilettante, but a man of taste, judgment and sound, practical sense. His instinct for order and his skill in plan and design were supplemented by a feeling for and a knowledge of fundamental structure. With sufficient administrative ability to correlate and combine the various elements and crafts involved in each special task entrusted to him, he served society efficiently and faithfully. He was indeed the Master Builder.

ARCHITECT'S POSITION TODAY

What of the Architect's status today? He feels himself not only unwanted but scorned.

He apologizes for his past virtues simply because he hears them vociferously described as vices. And there is no health in him.

I do not believe that this debility is wholly due to the impact of the war. Or because building for "commodities firmness and delight" seems to have ceased for the moment. The roots of our sickness lie deeper. The loss of employment is hard to bear, but the loss of one's self respect is not to be borne at all.

"Who steals my purse steals trash! But he who taketh away my good name steals that which enriches him not and makes me poor indeed."

Must we then stand idly by and allow others to steal our good name, or deride it and trample it in the dust? I think not.

The assault against the ancient and honorable (and beautiful) art of architecture should be faced squarely unless we are content to let the very spirit of Architecture become a mere historical memory. Can we afford to let the case against us go by default? An innocent bystander may command some measure of sympathy; but a guilty bystander will command neither sympathy nor respect.

In assessing the forces which are insidiously and even openly undermining the prestige of the profession and the faith of the Architect in himself and in Architecture, it should be made clear that we are not primarily concerned with the quarrel between the Conservatives and the Modernists. History affords sufficient evidence of the evolutionary process to render such debate idle. Architecture should, and does, adapt itself to changing conditions. It always has and it always will. The modernism of today may well be as outmoded tomorrow as the Victorian modernism, or Art Nouveau, of yesterday is outmoded today. We are concerned, however, with the complete denial of any esthetic values whatsoever and the emphasis by the modernists on mere utility and material functionalism. In this denial and this

over-emphasis, we see the negation of those intangible spiritual values which are the essence of true Architecture.

INSTITUTE NEEDS HOUSECLEANING

Recognizing the danger of this doctrine to the very existence of Architecture as an Art of profound cultural significance to society, the time seems to have come for a redefinition of the objects for which the Institute was founded. This redefinition is imperative for another reason less important perhaps for the preservation of the real spirit and substance of Architecture, but vital to the continuity of those professional ideals which have been laboriously formulated through the years by the Institute.

On every hand these ideals are being undermined by Government, by industry, by the press, even by the architectural profession itself.

Our battle against the encroachments of Federal, State and Municipal Bureaus into the field of private practice has not been crowned with success. We have lost ground and very likely shall continue to do so, for the tides are running strongly against all kinds of private enterprise everywhere. We could muster no valid argument against this trend were not the character and dignity of Architecture itself involved. Our selfish interests, and professional privileges would count for little were we certain that Architecture might be thus enobled and society thus enriched.

But we cannot be sure while so many voices within and without the profession are acclaiming the virtues of standardization, mass production, prefabrication and stereotyped design. We may excuse much and resign ourselves to many errors in the exigency of the war effort; but it can scarcely be denied that we are witnessing a steady and increasingly rapid deterioration not only of what we were proud to call Architectural design, but of craftsmanship and building integrity.

Were this condition only temporary it might be borne with equanimity. But it is seriously proposed by the spokesmen for industry that all building efforts be integrated; and all the elements concerned in the designing and planning in the mining or manufacturing of mate-

rials, and the fabrication, transportation and erection be co-ordinated and streamlined into one vast, smooth running (?) entity, for the mass production and sale of—what—of houses to be lived in, churches to be worshipped in, plants to be toiled in, whole cities to be foiled in.

THREATENED WITH COMPLETE EXTINCTION

The Architect is asked to connive in this grandiose arrangement. He is pointedly threatened with complete and utter extinction, if he does not choose complacently to play a minor part in this vast merchandising and sales organization. The old professional relationship between Architect and client is to be swept away. The idea has worked well in the ready-to-wear clothing industry. The American public buys packaged goods of all sorts. We have proprietary medicinal products, why not proprietary building (or Architectural) products? Why indeed not packaged sculpture, packaged paintings? We are on the march toward a higher, finer, richer civilization. So say the editors of our Architectural Press. So say the exponents of the new ideology.

We have no answer, we have only an inner faith. We have no journal, no pulpit, no rostrum from which to combat this sophistry. We have only the still small voice of conscience—and the Institute.

It may be that the fears of the writer will be considered morbid and his ideas dismissed as reactionary. But when, as Charles Maginnis has said, the Professors cease to profess, it is time to take stock of our few remaining values.

We need not bother about the older generation. It is the destiny of the younger generation which is at stake. It is they who call for leadership. We can only hope to kindle in them a renewed respect for:

The pure Spirit of Architecture.

The dignity and value of fine Craftsmanship.

The honor of the Professional Ideal.

In doing thus we will bequeath to them a priceless heritage.

These values are all that count.

They have little to do with such correlatives as Unification, Registration, Disciplinary Procedure, Schedules of Fees or the Producers Council.

It is later than we think and it will not do to stifle our forebodings with the comforting assurance that the shadow will pass. The total blackout of our most precious ideals can happen here—is happening here.

What then, we may ask, can be done about it? No one of us has a ready answer. The easiest way would be to let things slide, and trust that when they get bad enough the human race will cry for something better. The main point to be decided now is whether or not we believe that things have gotten bad enough to call for remedial action. If we do so agree, some discussion as to what direction such action should take would be in order.

We may grant that since architecture is out for the duration, the whole subject of this discussion is academic. Even so, or all the more because this may be so, discussion may proceed in a somewhat more purified atmosphere.

THREE REMEDIES ARE OFFERED

It has already been stated that we have no Journal, no Pulpit, no Rostrum. We have dispensed with the services of our publicist. How, then, are we to express our views and convictions, whatever they may be, to the profession, to the architectural schools, and, quite as importantly, to the public.

First—As to the lack of a Journal.

The Octagon has published the report of Mr. Talmage C. Hughes, Chairman of the Committee on Public Information. The proposals of Mr. Hughes are not new, and have been considered and rejected by previous Boards. On their face they would seem to be inconsistent with the criticisms just referred to against the policies of the existing architectural magazines. There is, however, enough merit in Mr. Hughes' suggestion to warrant a closer analysis.

2—The lack of a Pulpit.

It is true the Institute possesses no pulpit from which to address the public. It does, however, have a kind of pulpit in every Chapter. Should the Board of the Institute succeed in formulating a clear statement of policy, re-

garding the fundamentals listed above, means might easily be found to communicate such a statement, by word of mouth, directly to each Chapter membership. The resulting discussion would greatly hearten the membership, and might go far toward dispelling doubt, and binding it more closely to the Institute. Such procedure would have little news value, though it might conceivably strengthen morale.

3—The lack of a Rostrum.

To reach the general public and instill, in the public mind, a clearer conception of architectural values, further action might well be considered. The terms "Mass Housing," "Quantity Production," "Pre-fabrication," "Streamlining," "Town Planning," "Integration," etc., etc., have reached the public ear, and even though their implications have not always been understood, they have prepared the public mind for further discussion.

Certain publications have a considerable circulation among the more intelligent and thoughtful elements of the nation. Articles, not necessarily based on spot news but discussing intellectual, spiritual, and social values, find their way continually into such publications and are read with interest by large numbers of people. These articles are not always written by professional men. In fact, the most effective of them are written by professional writers. The possibility of preparing a series of articles on subjects affecting architecture, and the architectural profession, might well be considered. Journalists and publicists of reputation might be consulted and induced to contribute to such a series. The writers might be reimbursed wholly, or in part, by the magazines publishing the material.

I do not know how close the relationship of the Committee on Education with the Schools or Architecture is at the present time. The Committee on Education may hold views divergent from those expressed herein, but when, as, and if the Institute decides to redefine, or reaffirm its credo, a closer alliance with the schools will be of great value.

ELMER GREY, CALIFORNIA ARCHITECT, PAINTS OIL

It is said that one of Winston Churchill's hobbies is painting in oils. And I know from having seen them that the late Dr. Albert Michelsen, the discoverer of the speed of light, painted many water-colors that were very good. Without anything like the value or usefulness of these men to my credit, I can at least claim a similar avocation, for I delight in painting in oils.

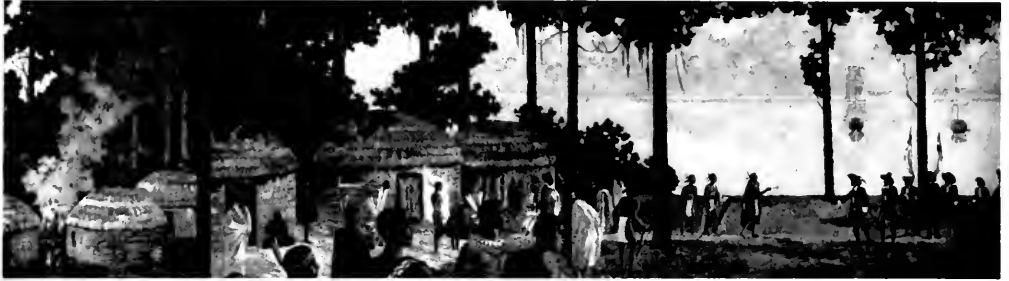

Parley between Indians and French. Florida, soon after its discovery by the Spanish, changed hands repeatedly between Spain and France.



On the left, more of the French coming up from the sea for the parley. On the right, dedication of a Christian shrine by the Spanish (unfortunately the photographer divided some of the episodes).



The same dedication ceremony with the interested but somewhat astonished natives watching from behind the trees.

FRIEZE DEPICTING EARLY HISTORY OF FLORIDA

It is because of that liking that I undertook the rather ambitious task of painting a frieze for the Senior Officers' Quarters in the Naval Air Station at Jacksonville, Florida, while I was employed there in 1941 and '42 as an instructor in mechanical drawing. The frieze measures 35 feet in length, and represents in five episodes the history and development of Florida. It was an enjoyable task and was worth doing. The panels shown here are photographed from the original work.—Elmer Grey.



Medieval shipping in the harbor of St. Augustine in 1678. Sketches and documents made by Spaniards at the time, copies of which are extant, show the place surrounded by high sand hills which 300 years of wind have blown away.

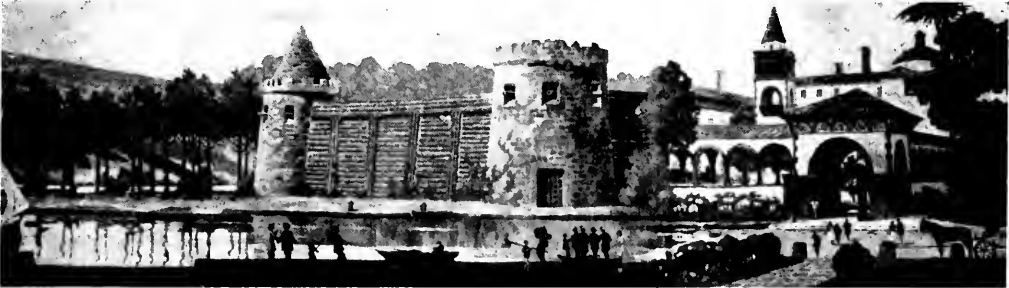

A wooden fort built at St. Augustine about 1678—taken from a Spanish sketch. Copies of a document are also extant in which the Spanish governor pleaded with the king of Spain to send him money with which to build an all-stone fort, saying that they could not fire off the cannon in the wooden fort because the fort would collapse.



Modern St. Augustine. These buildings are there but have been slightly modified in juxtaposition for the sake of pictorial composition. The old-fashioned carriages operated by colored cabbies wearing stove-pipe hats, appear in large numbers and help preserve the quaint aspect of the oldest city in the United States.

FOMINI ARENS,
Industrial Designer

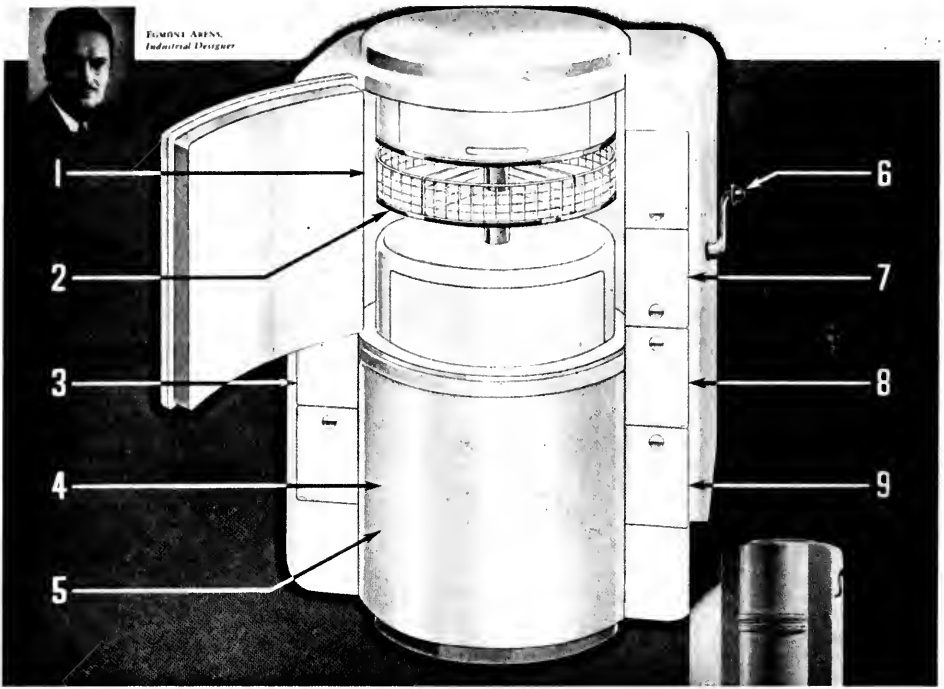

Courtesy Durez Plastics & Chemicals, Inc.

PLYWOOD AND PLASTIC REFRIGERATOR

Illustrated is an ice box of the not too distant future—made of resin-bonded plywood, faced with a skin of corrosion resistant plastics. To help you look into the future is a list of some of the high points of this post-war ice box.

1. Upper half for general refrigeration.
2. Revolving shelves make contents easy to reach.
3. Cooling locker drawers for tall bottles.
4. Lower half for frozen foods—kept at 10 degrees F. or lower.
5. Violet-ray compartment for sterilizing and tenderizing meats.
6. Ice cube ejector lever.
7. Ice cubes drop into this drawer for easy removal.
8. Cold water faucet inside door.
9. Cooling locker.



Courtesy Durez Plastics & Chemicals, Inc.

PLASTICS FOR PREFABRICATED BATHROOM

Here is a bathroom stressing the use of plastics. It was designed by Carl Sundberg of Sundberg and Ferar, New York. It offers a number of unique features, including a shower which folds into the wall when not in use.

The shower is adjustable in height, thereby eliminating the need for shower caps. The shower head and faucets are improved in appearance by the use of plastics.

The new post-war bathroom will be made of interchangeable units, also integrated compact units that minimize plumbing and mate-

rials. Plastics and resin-bonded plywood, as well as drawn steel, will undoubtedly play an important role in the development of future bathroom units.

Prefabricated bathroom units of drawn steel are a post-war certainty, preliminary designs calling for welded construction with cantilevered end units, overhead fluorescent lighting and ventilation. Besides general lighting, the bathrooms will require sidelights, preferably fluorescent, that may be easily adjusted to light the face and not the mirror.

POST - WAR HOME PLANNERS INSTITUTE

A Home Planners' Institute has been established in Portland, Oregon, to show families how to plan a home that will be more charming, efficient and economical. The Institute is offering a series of 24 classes, free. They have obtained outstanding authorities on each phase of home building to deliver lectures to the classes.

The Home Planners' Institute was organized by the West Coast Lumbermen's Association, the Western Retail Lumbermen's Association, and the Equitable Savings and Loan Association. Portland will be the pilot plant, and within a few months the lumber associations will make the proved plan available to every city in the United States. The plan has received the approval of the U. S. Savings and Loan League and the National Association of Lumber Manufacturers.

It is an educational and savings idea. In every city it will be free to anyone sincerely interested in building A home, and who, as proof of that sincerity, will accumulate a down-payment either in War Bonds or a Home Planners' Savings Account. A regular savings program must be started now, so the down-payment for the type of home planned will be accumulated in time to start building as soon as the war ends. Both the course and the savings program in Portland are being set up on a two-year basis. But if the war ends sooner than expected and building can be started earlier, the classes will be condensed so all the topics can be covered in a shorter time.

Local authorities in each city will be invited to address the classes on subjects such as site selection, financing the home, design, landscaping, heating and air conditioning, building materials, planning for hobbies and recreations, new developments, insulation, interior decoration, and 12 allied building subjects. Lecturing at these meetings will give the speaker an opportunity to meet a group of interested postwar home builders.

This is the largest single step private industry has taken toward postwar planning. Here is a program which will provide immediate jobs for returning service men and idle war workers. Through this program tens of thousands of American families will have their plans drawn, probably their lot chosen, and most important of all, have the money accumulated to finance a home the day peace is declared. This plan will provide immediate employment for thousands of millworkers, architects, carpenters, plasterers, plumbers, building supply men, and on through the endless occupational list.

Through this program the home building industry is preparing itself to take up the peacetime slack—and do it without any lag. Here is a program which will provide jobs, thus boosting the morale of returning service men and make sure that the thousands of men who have been trained as carpenters, electricians and painters in the shipyards have jobs in the field in which they are experienced.

The sponsors of this plan also feel that this public service will make the average home planner more sensitive to "graceful living," and how to obtain the most from a home. Also by introducing technical improvements to these people, it will increase desires, and enlarge the market for the thousands of new products which will be offered by manufacturers in the postwar period.

BUY MORE BONDS

Architect and Engineer publishers have received the following letter, with citation from the Treasury Department, Washington, in appreciation of its co-operation in encouraging the sale of war bonds through the medium of the advertising pages:

"Gentlemen:

It gives me great pleasure to transmit to you the enclosed citation, signed by the Secretary of the Treasury, in recognition of your outstanding service to the War Bond campaign.

Very truly yours,

THOMAS H. LANE,
Chief, Advertising Section,
War Finance Division."

(A facsimile of the citation is printed below.—Ed.)

UNITED STATES TREASURY DEPARTMENT



For distinguished services rendered in behalf of the War Savings Program this citation is awarded to

Architect & Engineer

Given under my hand and seal on

August 10, 1943

Henry Morgenthau Jr.
SECRETARY OF THE TREASURY

ARCHITECT AND ENGINEER

TODAY'S CLUES FOR POSTWAR FLUSH VALVES

★ While no one can lay down any very definite blueprints for the plumbing that will be found in postwar buildings, some valuable clues as to trends can be discovered in buildings completed within the last year or two.

Take hospitals, for example. Several outstanding institutions have been put into service during this period. The Jefferson Hospital at Birmingham — already recognized as one of the South's finest — is one of these.

Every piece of equipment that went into the Jefferson Hospital was selected with careful forethought to the comfort and well-being of the patients to be served. Noise reduction, for example, has been aided by the selection of Watrous *Silent-Action* Flush Valves.

In this detail there is a definite clue on postwar trends . . . the flush valves to be installed in most buildings of tomorrow will be smoothly functioning water control instruments which operate *silently* — without any of the tell-tale noise that once was associated with flush valves.

In fact, if we are to judge by the Jefferson Hospital's selection of Watrous *Silent-Action* Flush Valves, more and more careful attention will be given to—

- (a) the degree of noise elimination provided by a flush valve — and the PERMANENCY of the noise elimination.
- (b) the ability of the valve to be adjusted for maximum water savings.
- (c) the valve's simplicity and economy of maintenance.

Plans for Watrous Flush Valves for the buildings of tomorrow are already under way. You may be sure these valves will match fully the many other developments in building construction which are to come.

THE IMPERIAL BRASS MFG. CO.

1237 West Harrison Street, Chicago 7, Illinois

Data for wartime projects and postwar applications.

Sweet's Catalog File—Section 27, Catalog No. 39—covers both "V" model Watrous Flush Valves for essential wartime applications and the complete line of models and combinations for postwar planning . . . Or write for Bulletin 858-W and Catalog 448.



*The Jefferson Hospital, Birmingham, Alabama
Charles M. McCauley, Architect
The Pate Co., Plumbing Contractors*



● There are two of these utility rooms on each floor with service sinks equipped with Watrous *Silent-Action* Flush Valves. Watrous *Silent-Action* Flush Valves are also installed on fixtures in all bathrooms and washrooms.

Watrous Flush Valves



NORTHERN AND SOUTHERN CALIFORNIA CHAPTER MEETINGS FOR SEPTEMBER

The Northern California Chapter directors have adopted the following resolution:

"WHEREAS, The members of the San Francisco Chapter of the American Institute of Architects are vitally interested in the welfare of our city and are concerned that high standards of housing as so far developed be maintained, and

WHEREAS, The low cost housing as instituted by the Federal Government is an important part of the city's housing program; and

WHEREAS, The San Francisco Housing Authority as originally appointed by yourself and as organized and administered under its late Executive Director, has operated sympathetically, intelligently and efficiently in the interest of the city as a whole; and

WHEREAS, We regret the present condition which has given rise to the removal of the Executive Secretary, and the subsequent resignations of two distinguished Commissioners,

NOW, THEREFORE, BE IT RESOLVED: That this organization respectfully petitions your Honor, the Mayor of San Francisco, that in the reorganization of the Commission you be guided as follows:

Individuals to serve on the Commission shall be:

1. Sympathetic with Public Housing.
2. Well informed on the subject.
3. Capable of establishing a strong Housing Authority to preclude the possibility of losing control to the Federal Government.
4. Appointed on the basis of true fitness without regard to political affiliations."

CHAPTER VISITS WILMINGTON HALL

Wilmington Hall, one of the new projects of the Los Angeles Housing Authority, was the meeting place of Southern California Chapter on September 14. Many of the members had never had the pleasure of a close-up of this extensive war dormitory development and they were agreeably surprised to find such a well laid out building group. Wilmington Hall itself is the recreational unit of the project.

Brief talks were made by Roy Patterson, manager of the development, and Oliver Haskell, recreational director. Lewis E. Weston, architect of the project, was the principal speaker

FATAL ACCIDENT TO C. W. CARLE

C. W. Carle, vice-president of Gunn, Carle & Co., San Francisco building material distributors, met a tragic death by being struck by an assistant fire chief's automobile September 10. Carle had stepped off a Fairfax bus at Van Ness Avenue and Lombard Street, San Francisco, and was about to board a street car for his office, when the fire apparatus ran him down, inflicting fatal injuries. Carle had been identified with the building industry in San Francisco for more than 20 years and was an expert salesman. At the time of

his death he was a director and treasurer of the San Francisco Builders Exchange. He was 60 years old.

PASSING OF TWO PIONEER ARCHITECTS

Two of San Francisco's pioneer architects, so to speak, passed away the past month—James W. Reid, 91, and George Rushforth, 82. Both were prominently identified with the design and construction of many notable structures in the San Francisco Bay area in the early nineties.

Mr. Reid was the architect of the Fairmont Hotel, the Fitzhugh buildings in Los Angeles and Portland, Oregon, Hale Brothers' store, the original Claus Spreckels building, now the Central Tower, and many others.

Mr. Reid, who with his brother, Merritt Reid, had founded the pioneer architectural firm of Reid Brothers, had lived in San Francisco since 1889. He came to the Coast from his home in St. Johns, Canada, to construct the Coronado Hotel in Coronado, in 1887. Mr. Reid retired about 10 years ago.

He was one of the oldest members in point of membership of the Pacific Union Club, which he joined in 1890, the Burlingame Country Club and the San Francisco Golf Club. He also was a Knights Templar and a member of Northern California Chapter, A. I. A.

He died after a brief illness at his home, 1100 Union Street, which he designed. It was one of two homes in which Mr. and Mrs. Reid had lived, the other being the Fairmont.

George Rushforth, 82, died at his home, San Mateo Avenue, Berkeley, September 30. He retired from active practice some years ago, one of his last works being the two story concrete Wesley Foundation building in Berkeley and adjoining the First Methodist church, which latter he also designed.

For some years Mr. Rushforth was a member of the architectural firm of Wright, Rushforth and Cahill and when Mr. Wright died Messrs. Rushforth and Cahill continued in partnership until each went into business for himself. Mr. Rushforth maintained offices in San Francisco. He was architect of the Hotel Whitcomb, in San Francisco, the Forest Hill Hotel at Pacific Grove and churches, schools and residences in the Bay area.

He was a member of Northern California Chapter, A. I. A., and at one time was active in church work, being an official of First Methodist Church, Berkeley.

NEW SECRETARY OF ARCHITECTS' ASSOCIATION

Don Murray, recently given an honorable discharge from the U. S. Army, has been appointed secretary of the Engineers and Architects Association of Southern California, according to an announcement by Paul H. Ehlers, president.

For 10 years Mr. Murray served as assistant secretary of the Los Angeles Credit Men's Association, an affiliated unit of the National Association of Credit Men. The major part of his work was placement of personnel with wholesalers, jobbers, manufacturers, and financial institutions in Southern California.

ARCHITECTS' BULLETIN

Issued For

THE STATE ASSOCIATION OF CALIFORNIA ARCHITECTS

Northern Section

EDITOR OF BULLETIN

William C. Ambrose

Address all communications for publication in the Bulletin to W. C. Ambrose, 369 Pine Street, San Francisco.

STATE ASSOCIATION OFFICERS

Office of Northern Association
369 Pine Street, San Francisco

Officers

President.....Walter R. Hagedohm, Los Angeles
Vice-Pres.....Norman K. Blanchard, San Francisco
Secretary.....Hervey Parke Clark, San Francisco
Treasurer.....George E. Gable, Los Angeles

Southern Section Officers

President.....Walter R. Hagedohm, Los Angeles
Vice-President.....E. Allan Sheer, Los Angeles
Secretary.....Rowland H. Crawford, Beverly Hills
Treasurer.....George E. Gable, Los Angeles

Northern Section Officers and Directors

President.....Norman K. Blanchard, San Francisco
Vice-President.....Russell G. deLappe, San Francisco
Secretary.....Hervey Parke Clark, San Francisco
Treasurer.....David H. Horn, Berkeley
Directors: John S. Bolles, Röss; Andrew T. Hass, San Francisco; H. H. Gutterson, Berkeley; Vincent G. Raney, San Francisco; Frederick H. Reimers, San Francisco; Malcolm D. Reynolds, Oakland; J. Francis Ward, San Francisco, and Alfred C. Williams, San Francisco.

Northern Section Advisory Council

San Francisco District No. 1, J. Francis Ward;
East Bay District No. 2, Irwin M. Johnson;
Berkeley District No. 3, John K. Ballantine, Jr.;
North Bay District No. 3, C. A. Caulkins; Marin District No. 5, John S. Bolles; Lower San Joaquin District No. 6, Frank V. Mayo; Upper San Joaquin District No. 7, Philip S. Buckingham; Santa Clara District No. 8, Ralph Wyckoff; Palo Alto District No. 9, Elizabeth Boyter; San Mateo District No. 10, Leo J. Sharps; Sacramento District No. 11, Harry J. Devine; Upper Sacramento District No. 12, Fred J. deLongchamps; Lassen District No. 13, Ralph D. Taylor; Monterey District No. 14, Charles E. Butner, and Redwood Empire District No. 15, Franklin T. Georgeson.

Northern Section Standing Committees

Legislative Committee.....Vincent G. Raney
Public Relations Committee.....J. Francis Ward
Building Industry Committee.....Hervey Parke Clark
Convention Program Committee.....Edgar Bissantz
Post-War Reconstruction Com.....J. Francis Ward
Membership Committee.....John S. Bolles
Building Industry Directory.....Russell G. deLappe
Policy Committee.....Russell G. deLappe

S. A. C. A. ANNUAL CONVENTION

The annual convention of S.A.C.A. was held this year at the Mayfair Hotel, Los Angeles, October 14, 15 and 16. Due to war-time traveling conditions the attendance from Northern California was considerably smaller than usual. So that the Northern members would not be deprived of all the pleasures and benefits of a convention, a streamlined pre-convention meeting of the Northern Section was held at the Engineers Club, San Francisco, on October 4, 1943. Fifty-four members attended the dinner and listened to the after-dinner oratory of members who had done things for the Association in the past year. The election of officers for the Northern Section was held with results as noted under a separate heading in the Bulletin.

S.A.C.A. Election

will hold office in 1944:

President—John S. Bolles.
Vice-President—Malcolm D. Reynolds.
Treasurer—Ralph Wyckoff.
Directors—Norman W. Blanchard, Philip S. Buckingham.

These new officers and directors will, as already stated, hold office for the coming year, together with the following listed members, who have another year to serve:

Henry H. Gutterson—Regional Director, A.I.A.
Andrew T. Hass—Northern California Chapter, A.I.A.
Peter L. Sala—Central Valley's Chapter, A.I.A.
Frederick H. Reimers—State Board of Architectural Examiners.
Vincent G. Raney, J. Francis Ward, Alfred C. Williams—
elected by members.

The principal contest arose as a result of a write-in campaign in favor of Russel G. DeLappe, Vice-President of the State Association for the past year in opposition to the nominating committee candidate, John S. Bolles. The campaign was enlivened by letters, much telephoning and many conferences to make sure that the proper candidate received the most votes.

After the ballots were counted and the results announced, representatives of the Stockton Advisory Section moved that the election be declared void on account of irregularities in procedure. On a point of order that such a motion could not be considered after the completion of the balloting, the motion was not put to a vote. A motion to adjourn ended the debate.

Patents Available

Hervey P. Clark, Secretary of the N. C. Section, S.A.C.A., has been asked by the Office of Alien Property Custodian to publicize to architects that 45,000 U. S. patents and patent applications, which were formerly under

enemy control, are now available for license by Americans for use during the war and post-war periods. Further information may be obtained from Mr. Howland H. Sargeant, Chief, Division of Patent Administration, Office of Alien Property Custodian, Field Building, Chicago, 3, Illinois.

A fee of \$15.00 is charged for each patent issued. An index of patents vested in the Alien Property Custodian and an instruction sheet giving necessary information as to procedure are available.

Post-War & the Architect That the architect and workers in associated lines are becoming acutely aware of the necessity of positive action now in planning for post-war work has been evident in recent weeks.

At the Building Industry Conference Board meeting on September 15, Chairman J. Francis Ward outlined the program for the post-war committee for that organization. He emphasized the necessity of getting back as quickly as possible to a normal relationship between owner, architect, contractor, and material supplier. George W. Williams, contractor, urged that all branches of the building industry unite to guard against governmental agencies taking over the functions of private industry. Harry Michelson, architect, outlined legislation now in effect and now pending having to do with post-war building. Harold Smith of Dinwiddie Construction Company called attention to the current employment of private architectural and engineering firms by the Navy for the preparation of comprehensive reports on cost-plus-a-fixed-fee contracts. He cited such employment as an example of the value of private professional men in the construction field as a reinforcement for and knowledge of the men in governmental employment. Fred Hall, civil engineer, urged that every effort should be made to have complete plans and specifications prepared now for immediate use when the material and labor become available.

Copies of Broadcast Copies of a transcript of the broadcast, "Will We Need a W. P. A. After the War," which was noted here in the September issue, have been received from the A.I.A. office in Washington. Copies are available from Randall, Inc., Washington, D. C., with a ten-cent (10c) charge for handling and mailing.

Plans for Public Works We quote Douglas Dacre Stone, architect, and President of

the City Planning Commission, San Francisco: "The making of detailed plans and specifications for these Public Works, however, is not the function of the Planning Commission. Such work should be done by other agencies and by private architects and engineers. Funds must be procured to cover the cost of these plans at the earliest possible moment. Subsequently, funds for the actual construction of projects must be found through Federal, State, or local channels."

Executive Director Charles F. Strothoff, architect, has been appointed executive director of the Richmond Housing Authority. He succeeds Mr. Harry A. Barbour, who has resigned after serving in the position since the first project of the Authority in 1941. There are now 28,630 family units and 3,000 dormitory units under the jurisdiction of Mr. Strothoff.

Promotion for Bolles Following the other recent changes in the organization of the San Francisco Housing Authority, John S. Bolles, architect, has become Technical Director under J. W. Beard, Acting Executive Director.

Architects Wanted Believe it or not, there is a shortage of Architects in California at the present time. The San Francisco office of the Federal Housing Administration would like to hear from architects who have available time. If you know of anyone who might be interested, direct him to Harris Allen, Architect, at the F.H.A. offices, 315 Montgomery Street, San Francisco.

POST-WAR HEATING SYSTEMS

More than 60 per cent of post-war heating systems will use mechanical circulation to carry heat from the heating plant through the home and building, according to a survey by Fueloil & Oil Heat Magazine. Oil-heating dealers, including heating contractors, electrical retailers, fuel-oil suppliers, and other retail outlets in the states of Connecticut, New Jersey, Maryland, Wisconsin, Iowa, Washington and Oregon were polled by mail to get their estimate of post-war heating preferences in their localities.

According to their estimates, more than a third of post-war heating will be forced warm air and slightly less will be forced hot water. Gravity warm air and one-pipe steam run neck-and-neck in third and fourth places, and gravity hot water and two-pipe steam trail in fifth and sixth places.

PACIFIC PAINT & VARNISH CO.
A Paint or Varnish Product for Every Purpose
SAN FRANCISCO Sales Office BERKELEY Factory LOS ANGELES Sales Office

PRODUCERS' COUNCIL PAGE

Northern California Chapter

The National Organization of Manufacturers of Quality Building Materials and Equipment
Affiliated with the AMERICAN INSTITUTE OF ARCHTECTS



G. R. KINGSLAND

... his hobby—raising flowers.

When the parent organization of the Producers' Council decided upon a Council Club in San Francisco, they made a wise choice in G. R. "Ray" Kingsland as the man to start the ball rolling. That was more than twelve years ago . . . since then, Ray has not only been first president,

but succeeded himself in 1932 and 1933. In fact, he is the only remaining member of our original group of founders. On the personal side: Ray was born and raised in San Francisco, and after leaving the University of California, he joined the staff of the Otis Elevator Company . . . one of the few companies in the country that makes money by having its ups and downs. President-emeritus Kingsland is a member of the Bohemian Club and the Claremont Country Club. Ray was president of the Engineers Club of San Francisco in 1928. He lives high on a hilltop in the Claremont section of Berkeley with his wife and daughter. His hobby: raising flowers, which, unlike elevators, go only up, not down.

Here's a Quick Quiz: Can you name the past presidents of your Chapter? Give up? Well, here they are:

- | | |
|--------------------|--------------------|
| 1931—Ray Kingsland | —Otis Elevator |
| 2—Ray Kingsland | —Otis Elevator |
| 3—Ray Kingsland | —Otis Elevator |
| 4—Ben Blair | —Standard Sanitary |
| 5—Clark Wayland | —Western Asbestos |
| 6—Fred Scott | —National Lead |
| 7—"Gaz" MacKenzie | —Libbey-Owens-Ford |
| 8—Bill Wooldredge | —Columbia Steel |
| 9—Ken Pinney | —Armstrong Cork |
| 40—Vic Anderson | —Otis Elevator |
| 41—Ray Brown | —Gladding McBean |
| 42—Gano Baker | —Westinghouse |

You'll Hear More About Them in succeeding issues. Incidentally, speaking of Ray Kingsland, see our June Issue for a list of many other "firsts" in the development of Chapter affairs that were scored by Ray.

Last Round-Up: November 1st will be the last luncheon meeting of the year . . . both calendar and Chapter year. Let's all get together and wind-up the Chapter's 1943 activities with a bang! You'll like the program scheduled for this last luncheon. Johns-Manville and

Western Asbestos head the bill. Same place . . . Room "A," Palace Hotel . . . noon, Monday, November first.

Father's Day: At our October 4th meeting, we were lucky to have F. W. Morse, Vice-President of the Chamberlin Metal Weather Strip Company and Director and Past President of the Producers' Council. Mr. Morse was father of the Chapter idea. If it weren't for the fact that Mr. Morse was such an important person, we would cock a questioning eye-brow at the speed with which the members originally scheduled to speak gave way to Mr. Morse! Everybody agreed that his talk on the "Or Equal" clause was as timely as today's newspaper.

Old Mister O. R. Equal is on his way out, thanks to the approval of the Institute's 1943 Annual Meeting. A definite move has been made to eliminate the specification practice of including the "or equal" provision. Recommendation for this action came from the Institute's Committee on Contract Documents, under the able chairmanship of William Stanley Parker. It was developed through the persistent efforts of J. C. Bebb, past Chairman of the Council's Industrial and Commercial Committee. In 1942 the Council's Annual Meeting approved a statement on this practice prepared by Mr. Bebb's Committee. Since this subject has now reached the stage where it can be sold to individual designers and specifiers, the Executive Committee has transferred it to the jurisdiction of the Technical Cooperation Committee. This Committee is going to bring it to the attention of the national engineering societies for their endorsement, paving the way for nation-wide acceptance by practicing Architects and Engineers.

Local Chapters can really do a job on Old Mr. O. R. Equal. They should make every possible effort to see that he's dead and buried. Incidentally, this situation gives us the subject matter for another interesting meeting with the Architects.

The Welcome Mat's Out for E. L. Bruce Company and The Celotex Corporation, new Chapter members. F. L. O'Connor and E. P. Larson are their representatives. Note: This puts our new member score for 1943 at six to date.

Recruits? New National Members are Chapter prospects. This year the Producers' Council, Inc., has welcomed the following companies into our midst, besides Celotex which is now one of our local members:

(Turn to next page)

USE QUALITY PRODUCTS



CONSULT AN ARCHITECT

PRODUCERS' COUNCIL—Continued

Owens-Corning Fiberglas Corp. —Toledo, Ohio
Universal Zonolite Insulation Co. —Chicago, Ill.
J. A. Zurn Manufacturing Co. —Erie, Pa.
Mueller Brass Co. —Port Huron, Mich.
Surface Combustion Co. —Toledo, Ohio

The Chapter Joins the Citizens' Master Plan Committee of the San Francisco Housing and Planning Association. This step was authorized and encouraged by your Executive Committee. For many years the Council has urged local chapters to take part in local planning groups. We have always supported the Building Industry Conference Board as a manifestation of this policy.

Jinks Shift: The Xmas Jinks date has been switched to December 1st, due to schedule trouble. It's better early than late . . . so remember, the Xmas Jinks . . . December first.

Shingle Out: Architect Bill Knowles is back in town with his shingle out at 369 Pine Street. Post-war planning? Let's hope so.

ARCHITECTS STILL ON THE MOVE

James H. Anderson, Jr., has moved from the Claremont Hotel, Berkeley, to 5 Via Hermosa, Orinda, California.

Tennys F. Bellamy, from 1038 Exchange Building, Seattle, to 9925-15th, N.W., same city.

Gates W. Burrows has moved from 310 Cliff Drive, Laguna Beach, to 303 West Ninth Street, Long Beach.

Mario F. Corbett, from c/o McNeil Construction Company, Pleasanton, to 11 Star Route, Redwood City.

Clarence C. Dakin, from 10823 Braddock Drive, Culver City, to 434 South Garfield Avenue, Alhambra.

Marshall A. Dean, from Colonial Inn, Walnut Creek, to 186 Pacific Avenue, Pacific Grove.

John E. Dinwiddie has moved from 125 Stonewall Road, Berkeley, to Claremont Hotel, same city.

John N. Douglas, from 888 Victoria Drive, Pasadena, to 1003 West Hillcrest Street, Monrovia.

Sidney Eisenshtat, 4431 West 64th Street, Los Angeles, to Box 85, Yucaipa, San Bernardino County, California.

Julian F. Everett, from Vista, California, to 4811 Keneston, Los Angeles.

Gerald C. Field, from 1504 Textile Tower, Seattle, Washington, to 2217 Everett, North, same city.

Sherwood D. Ford, from Insurance Building, Seattle, Washington, to 512 Railway Exchange Building, same city.

William Grant Foster, from 34 Avon Road, Berkeley, to 1497 Posen Street, same city.

David L. Foulkes, from 4542 Latona Avenue, Seattle, Washington, to 4668 Eastern Avenue, same city.

Breo Freeman moved from 303 Markham Place, Pasadena, to 91 North Oakland Avenue, same city.

William C. Furer, moved from 402 Boston Building, Honolulu, to 1909 Aleo Place, same city.

Frank S. Gerner, from 1429 Grant Street, Berkeley, to H. Q. Company, N.C.S.W.D.C., Presidio of San Francisco, San Francisco.

Michael Goodman, from 1400 Hawthorne Terrace, Berkeley, to 2422 Cedar Street, same city.

Harry A. Herzog, from 311 Fenton Building, Portland, Oregon, to 407 Henry Building, same city.

Gilbert Hodgeson has moved from 208 Hillview Avenue, Redwood City, to Route 1, Box 697, Los Altos.

Keplar B. Johnson, from 5347 Golden Gate Avenue, to 503 North Laurel Avenue, Los Angeles.

Paul W. Jones, from 718 Colorado Avenue, La Junta, Colorado, to Gray Court No. 5, 8600 East Dixie Highway, Miami, Florida.

Walter E. Kelly, from Artisan Building, Portland, Oregon, to Broadway Oak Building, same city.

E. Keith Lockard, from 117 East de la Guerra, Santa Barbara, to 1746 Prospect Street, same city.

Leon D. Lockwood, from 50 Third Street, San Francisco, to 835 South Oxford Street, Los Angeles.

Walter W. Lund, from 2232 Boylston North, Seattle, Washington, to 2502 Boylston North, same city.

Richard Lytel, from 1006 Securities Building, Seattle, Washington, to 1015 Securities Building, same city.

Ensign William B. McCormick, from 28 Terrace Walk, Berkeley, to Cincpac Staff, c/o Fleet Post Master, Pearl Harbor, Honolulu.

Bjorne H. Moe, 2318 Second Avenue, Seattle, Washington, to 2650 North Dravus, same city.

Carl W. Morrison, from Textile Tower, Seattle, Washington, to 719 Second Avenue, same city.

Frank B. Smith, from 1234 East 98th Street, Seattle, Washington, to 4835 N. E. 100th, Portland, Oregon.

Harold G. Stoner, from 800 Butterfield Road, San Anselmo, to Larkspur.

James M. Taylor, Sr., from 1304 Textile Tower, Seattle, Washington, to 2042 Boyleston North, same city.

Archibald N. Torbitt, from Lloyd Building, Seattle, Washington, to 10580-15th N. W., same city.

Donald D. Williams, from Textile Tower, Seattle, Washington, to 312 Fairview North, same city.

Joseph H. Wohleb, from Old Capitol National Bank Building, Olympia, to 201 Chambers Block, same city.

KAHN ESTATE OVER TWO MILLION

The estate of Albert Kahn, distinguished Detroit architect who died last December 8, was listed at \$2,123,396.04 in an inventory filed recently in the court of Probate Judge Thomas C. Murphy, Detroit.

Largest item in the appraisal consisted of stocks valued at \$1,776,211. Other items included cash, \$266,789, real estate, \$59,023, and bonds and miscellaneous investments, \$21,371.

The late Albert Kahn was a brother of Felix Kahn, well known San Francisco contractor.

Estimator's Guide

Giving Cost of Building Materials, Wage Scale, Etc.

Amounts given are figuring prices and are made up from average quotations furnished by material houses to San Francisco contractors. 3% Sales Tax on all materials but not labor.

All prices and wages quoted are for San Francisco and the Bay District. There may be slight fluctuation of prices in the interior and southern part of the state. Freight cartage, at least, must be added in figuring country work.

Bond—1 1/2% amount of contract.
Government work 3/4%.

Brickwork—

- Common, \$43 to \$45 per 1000 laid, (according to class of work).
- Face, \$125 to \$150 per 1000 laid, (according to class of work).
- Brick Steps, using pressed brick, \$1.50 lin. ft.
- Brick Veneer on frame buildings, \$1.10 sq. ft.
- Common f.o.b. cars, \$16.00 a yard. Cartage extra. \$2.50 per 1000.
- Face, f.o.b. cars, \$55.00 to \$80.00 per 1000, carload lots.

Building Paper—

- 1 ply per 1000 ft. roll.....\$3.50
- 2 ply per 1000 ft. roll.....5.00
- 3 ply per 1000 ft. roll.....6.25
- Brownskin, Standard, 500 ft. roll.....5.00
- Sisalcraft, 500 ft. roll.....5.00
- Sash card com. No. 7.....\$1.20 per 100 ft.
- Sash card com. No. 8.....1.50 per 100 ft.
- Sash card spot No. 7.....1.90 per 100 ft.
- Sash card spot No. 8.....2.25 per 100 ft.
- Sash weights, cast iron, \$50.00 ton.
- Nails, \$3.50 base.
- Sash weights, \$45.00 per ton.

Concrete Aggregates—

GRAVEL (all sizes) \$1.95 per ton at bunker; delivered, \$2.50. All quotations less 10% to contractors.

	Bunker	Delivered
Top sand.....	\$1.90	\$2.50
Concrete mix.....	1.90	2.45
Crushed rock, 1/4 to 3/8.....	1.90	2.50
Crushed rock, 3/8 to 1 1/2.....	1.90	2.50
Roofing gravel.....	2.25	2.80
River sand.....	2.25	2.70

SAND—

	Bunker	Delivered
River sand.....	\$2.25	\$2.70
Lapis (Nos. 2 & 4).....	2.85	3.15
Olympia Nos. 1 & 2.....	2.85	3.10
Del Monte white.....		.84c per sack

Common cement (all brands, paper sacks) carload lots \$2.42 per bbl, f.o.b. car; delivered \$2.60.

Cash discount on carload lots, 10c a barrel, 10th Prox.

Atlas White
Calaveras White
Medusa White

{ 1 to 100 sacks, \$2.70 sack, warehouse or delivery; \$7.65 bbl. carload lots.

Forms, Labors average \$40.00 per M.
Average cost of concrete in place, exclusive of forms, 35c per cu. ft.; with forms, 60c.
4-inch concrete basement floor.....12 1/2c to 14c per sq. ft.
Rat-proofing.....7 1/2c
Concrete Steps.....\$1.25 per lin. ft.

Dampproofing and Waterproofing—

Two-coat work, 20c to 30c per yard.
Membrane waterproofing—4 layers of saturated felt, \$4.50 per square.
Hot coating work, \$2.00 per square.
Medusa Waterproofing, 15c per lb., San Francisco Warehouse.
Tricocel waterproofing.
(See representative.)

Electric Wiring—\$12.00 to \$15.00 per outlet for conduit work (including switches).
Knob and tube average \$3.00 per outlet. (Available only for priority work.)

Elevators—

Prices vary according to capacity, speed and type. Consult elevator companies.
Average cost of installing a slow speed automatic passenger elevator in small four story apartment building, including entrance doors, about \$6500.00.

Excavation—

Sand, 60 cents; clay or shale \$1 per yard.
Teams, \$12.00 per day.
Trucks, \$22 to \$27.50 per day.
Above figures are an average without water. Steam shovel work in large quantities, less; hard material, such as rock, will run considerably more.

Fire Escapes—

Ten-foot galvanized iron balcony, with stairs, \$150 installed on new buildings; \$160 on old buildings.

Floors—

Composition Floors—22c to 40c per sq. ft.
In large quantities, 18c per sq. ft. laid.
Mosaic Floors—80c per sq. ft.
Duraflex Floor—23c to 30c sq. ft.
Rubber Tile—50c to 75c per sq. ft.
Terazzo Floors—45c to 60c per sq. ft.
Terazzo Steps—\$1.60 lin. ft.

Hardwood Flooring (delivered to building)—

	1 1/2" x 2 1/4" T&G	3/4" x 2" T&G	1 1/2" x 2" Sq.Ed.
Clr. Old. Oak.....	\$144.00 M	\$122.00 M	\$141.00 M
Sel. Old. Oak.....	118.00 M	101.00 M	114.00 M
Clr. Pla. Oak.....	120.00 M	102.00 M	115.00 M
Sel. Pla. Oak.....	113.00 M	92.00 M	107.00 M
Clr. Maple.....	125.00 M	113.00 M	

Wage—Floor layers, \$12.00.
Note—Above quotations are all board measure except last column which is sq. ft.

Glass (consult with manufacturers)—
Double strength window glass, 20c per square foot.
Plate 80c per square foot (unglazed) in place, \$1.00.
Art, \$1.00 up per square foot.
Wire (for skylights), glazed, 40c per sq. foot.
Obscure glass, 30c to 50c square foot.
Glass bricks, \$2.50 per sq. ft. in place.
Note—if not stipulated add extra for setting.

Heating—

Average, \$1.9C per sq. ft. of radiation, according to conditions.
Warm air (gravity) average \$48 per register.
Forced air, average \$68 per register.

Iron—Cost of ornamental iron, cast iron, etc., depends on designs.

Lumber (prices delivered to bldg. site)—

No. 1 common.....	\$45.00 per M
No. 2 common.....	43.00 per M
Select O. P. Common.....	48.00 per M
1x4 No. 2 flooring VG.....	80.00 per M
1x4 No. 3 flooring VG.....	75.00 per M
1x6 No. 2 flooring VG.....	90.00 per M
1 1/4x4 No. 2 flooring.....	85.00 per M

Slash grain—
1x4 No. 2 flooring.....\$65.00 per M
1x4 No. 3 flooring.....52.00 per M
No. 1 common run T. & G.....50.00 per M
Lath.....7.50 per M

Shingles (add cartage to price quoted)—
Redwood, No. 1.....\$1.20 per bdle.
Redwood, No. 2.....1.00 per bdle.
Red Cedar.....1.40 per bdle.

Plywood—Douglas Fir (add cartage)—
"Plyscord" sheathing (unsanded)
3/4" 3-ply and 48"x96".....\$39.75 per M
"Plywall" (wallboard grade)—
1/4" 3-ply 48"x96".....\$43.70 per M
"Plyform" (concrete form grade)—
5/8" 5-ply 48"x96".....\$117.30 per M
Exterior Plywood Siding—
5/8" 5-ply Fir.....\$132.00 per M
Redwood (Rustic) 1"x8" clear heart.....\$95.00 per M \$9 less per M for A grade.

Millwork—Standard.

O. P. \$100 per 1000. R. W. rustic \$100.00 per 1000 (delivered).
Double hung box window frames, average with trim, \$6.50 end up, each.
Complete door unit, \$10.00.
Screen doors, \$3.50 each.
Patent screen windows, 25c a sq. ft.
Cases for kitchen pantries seven ft. high, per lineal ft., \$8.00 each.
Dining room cases, \$8.00 per lineal foot. Rough and finish about 75c per sq. ft.
Labor—Rough carpentry, warehouse heavy framing (average), \$17.50 per M.
For smaller work average, \$35.00 to \$45.00 per 1000.

Marble—(See Dealers)

Painting—

Two-coat work.....per yard 50c
Three-coat work.....per yard 70c
Cold water painting.....per yard 10c
Whitewashing.....per yard 4c

Turpentine, \$1.08 per gal., in 5 gal. cans, and 95c per gal. in drums,	
Raw Linseed Oil—\$1.32 gal. in light drums, Boiled Linseed Oil—\$1.35 gal. in drums and \$1.48 in 5 gal. cans.	
White Lead in oil	Per Lb.
1 ton lots, 100 lbs. net weight.....	111/2c
500 lbs. and less than 1 ton.....	121/4c
Less than 500 lb. lots.....	123/4c
Red Lead and litharge	
1 ton lots, 100 lbs. net weight.....	111/2c
500 lbs. and less than 1 ton.....	121/4c
Less than 500 lb. lots.....	123/4c
Red Lead in oil	
1 ton lots, 100 lbs. net weight.....	121/2c
500 lbs. and less than 1 ton.....	131/4c
Less than 500 lb. lots.....	133/4c
Note—Accessibility and conditions cause some variance in costs.	

Patent Chimneys—	
6-inch	\$1.25 lineal foot
8-inch	1.50 lineal foot
10-inch	2.25 lineal foot
12-inch	3.00 lineal foot

Plaster
Neat wall, per ton delivered in S. F. in paper bags, \$17.60.

Plastering—Interior—		Yard
1 coat, brown mortar only, wood lath.....		\$0.70
2 coats, lime mortar hard finish, wood lath80
2 coats, hard wall plaster, wood lath.....		.80
3 coats, metal lath and plaster.....		1.50
Keene cement on metal lath.....		1.60
Ceilings with 3/4 hot roll channels metal lath (lathed only).....		1.10
Ceilings with 3/4 hot roll channels metal lath plastered.....		2.00
Single partition 3/4 channel lath 1 side (lath only).....		1.10
Single partition 3/4 channel lath 2 inches thick plastered.....		\$2.90
4-inch double partition 3/4 channel lath 2 sides (lath only).....		2.00
4-inch double partition 3/4 channel lath 2 sides plastered.....		3.50
Thermax single partition; 1" channels; 2 1/2" overall partition width. Plastered both sides.....		3.00
Thermax double partition; 1" channels; 4 3/4" overall partition width. Plastered both sides.....		4.00

3 coats over 1" Thermax nailed to one side wood studs or joists.....	1.50	
3 coats over 1" Thermax suspended to one side wood studs with spring sound isolation clip.....	1.75	
Plastering—Exterior—		Yard
2 coats cement finish, brick or concrete wall.....	1.00	
3 coats cement finish, No. 18 gauge wire mesh.....	1.75	
Wood lath; \$5.50 to \$6.50 per 1000 (not available)		
2.5-lb. metal lath (dipped) (not available).....	.19	
2.5-lb. metal lath (galvanized) (not avail.).....	.21	
3.4-lb. metal lath (dipped) (not available).....	.22	
3.4-lb. metal lath (galvanized) (not avail.).....	.24	
3/4-inch hot roll channels, \$72 per ton.		
Finish plaster, \$18.90 ton; in paper sacks.		
Dealer's commission, \$1.00 off above quotations.		
\$13.85 (retake 10c sect).		
Lime, f.o.b. warehouse, \$2.25 bbl.; cars, \$2.15		
Lime bulk (ton 2000 lbs.), \$16.00 ton.		
Wall board 5 ply, \$50 per M.		
Hydrate Lime, \$25.00 ton.		
Plasterers Wage Scale.....	\$1.75 per hour	
Lathers Wage Scale.....	1.75 per hour	
Head Carriers Wage Scale.....	1.50 per hour	
Composition Stucco—\$1.80 to \$2.00 sq. yard (applied).		

Plumbing—
From \$100.00 per fixture up, according to grade, quantity and runs.

Roofing—	
"Standard" tar and gravel, \$7.00 per 30 sq. sq. or over.	
For 30 sq. sq. or over.	
Less than 30 sq. sq. \$7.50 per sq.	
Tile, \$20.00 to \$35.00 per square.	
Redwood Shingles, \$7.50 per square in place.	
Copper, \$16.50 to \$18.00 per sq. in place.	
5/2 #1-16" Cedar Shingles,	
4 1/2" Exposure.....	8.00 Square
5/8 x 16" #1 Cedar Shingles, 5" Exposure.....	9.00 Square
4/2 #1-24" Royal Shingles,	
7 1/2" Exposure.....	9.50 Square
Re-coat with Gravel, \$3 per sq.	
Asbestos Shingles, \$15 to \$25 per sq. laid.	
Slate, from \$25.00 per sq., according to color and thickness,	
1/2 x 25" Resawn Cedar Shakes,	
10" Exposure.....	10.50
3/4 x 25" Resawn Cedar Shakes,	
10" Exposure.....	11.50

1 x 25" Resawn Cedar Shakes,
10" Exposure12.50
Above prices are for shakes in place.

Sheet Metal—
Windows—Metal, \$1.75 a sq. ft.
Fire doors (average), including hardware, \$1.75 per sq. ft.

Skylights—(not glazed)
Copper, 90c sq. ft. (flat).
Galvanized iron, 40c sq. ft. (flat).
Vented hip skylights 60c sq. ft.

Steel—Structural (None available except for defense work)
\$150 ton (erected), this quotation is an average for comparatively small quantities. Light truss work higher. Plain beams and column work in large quantities \$140 per ton.

Steel Reinforcing (None available except for defense work).
\$150 to \$200 per ton, set.

Stone—
Granite, average, \$6.50 cu. foot in place. Sandstone, average Blue, \$4.00. Boise, \$3.00 sq. ft. in place.
Indiana Limestone, \$2.80 per sq. ft. in place.

Store Fronts—
Copper sash bars for store fronts, corner, center and around sides, will average \$1.00 per lineal foot.
Note—Consult with agents.

Tile—Floor, Wainscot, etc. — (See Dealers)
Asphalt Tile—18c to 28c per sq. ft. installed.

Wall Tile—
Glazed Terra Cotta Wall Units (single faced) laid in place—approximate prices:

2 x 6 x 12.....	\$1.00 sq. ft.
4 x 6 x 12.....	1.15 sq. ft.
2 x 8 x 16.....	1.10 sq. ft.
4 x 8 x 16.....	1.30 sq. ft.

Venetian Blinds—
40c per square foot and up. Installation extra.

Windows—Steel
Factory type sash 30c ft.
Ventilators for steel sash \$5.00 each.

1943 BUILDING TRADES WAGE SCALES FOR NORTHERN CALIFORNIA

All crafts, except plasterers, are now working 8 hours a day. Plasterers' time is 6 hours.

CRAFT	San Francisco	Alameda	Fresno	Marin	Sacramento	San Jose	San Mateo	Vallejo	Stockton
ASBESTOS WORKERS	\$1.50	\$1.25	\$1.25	\$1.37 1/2	\$1.12 1/2	\$1.25	\$1.25	\$1.25	\$1.25
BRICKLAYERS	1.87 1/2	1.87 1/2	1.50	1.87 1/2	2.00	2.00	1.87 1/2	1.87 1/2	2.00
BRICKLAYERS' HODCARRIERS	1.40	1.40	1.05	1.40	1.40	1.40	1.40	1.40	1.40
CARPENTERS	1.43	1.43	1.25	1.43	1.43	1.43	1.43	1.43	1.43
CEMENT FINISHERS	1.77 1/2	1.37 1/2	1.25	1.25	1.25	1.50	1.25	1.25	1.25
ELECTRICIANS	1.70	1.50	1.50	1.37 1/2	1.50	1.50	1.50	1.50	1.37 1/4
ELEVATOR CONSTRUCTORS	1.61	1.56	1.50	1.61	1.61	1.50	1.50	1.56	1.56
ENGINEERS: Material Hoist	1.50	1.37 1/2	1.25	1.50	1.37 1/2	1.62 1/2	1.37 1/2	1.37 1/2	1.25
Piledriver	1.75	1.60	1.60	1.75	1.75	1.75	1.62 1/2	1.75	1.75
Structural Steel	1.75	1.60	1.60	1.75	1.75	1.75	1.62 1/2	1.75	1.60
GLASS WORKERS	1.25	1.25	1.12 1/2	1.25	1.12 1/2	1.25	1.25	1.25	1.25
IRONWORKERS: Ornamental	1.50	1.31 1/4	1.37 1/2	1.31 1/4	1.37 1/2	1.31 1/4	1.25	1.31 1/4	1.25
Reinf. Rodmen	1.50	1.31 1/4	1.31 1/4	1.31 1/4	1.31 1/4	1.60	1.31 1/4	1.31 1/4	1.25
Structural	1.75	1.60	1.60	1.60	1.60	1.75	1.50	1.60	1.37 1/2
LABORERS: Building	.85	.87 1/2	.82 1/2	.81 1/4	.85	.85	.81 1/4	.81 1/4	.80
Concrete	.87 1/2	.93 3/4	.92	.81 1/4	.92 1/285	.90	.90
LATHERS	1.75	1.75	1.50	1.75	1.60	1.75	1.75	1.50	1.50
MARBLE SETTERS	1.43 3/4	1.25	1.25	1.31 1/4	1.37 1/2	1.25	1.31 1/4
MOSAIC & TERRAZZO	1.00	1.25	1.12 1/2	1.12 1/2	1.15 5/8	1.12 1/2	1.12 1/2	1.50
PAINTERS	1.37 1/2	1.50	1.28-4/7	1.37 1/2	1.25	1.35-5/7	1.42-6/7	1.50	1.25
PILEDRIVERS	1.47	1.40	1.40	1.40	1.40	1.47	1.40	1.40	1.40
PLASTERERS	1.66-2/3	1.66-2/3	1.75	1.66-2/3	1.75	2.00	2.00	1.75	1.83-1/3
PLASTERERS' HODCARRIERS	1.50	1.45	1.40	1.40	1.18 3/4	1.35	1.75	1.40	1.50
PLUMBERS	1.70	1.50	1.53-1/8	1.50	1.50 1/4	1.62 1/2	1.50	1.50	1.37 1/2
ROOFERS	1.37 1/2	1.37 1/2	1.12 1/2	1.25	1.25	1.37 1/2	1.25	1.25	1.25
SHEET METAL WORKERS	1.50	1.37 1/2	1.43 3/4	1.37 1/2	1.50	1.50	1.37 1/2	1.25	1.37 1/2
SPRINKLER FITTERS	1.50	1.37 1/2	1.25	1.62 1/2	1.50	1.50
STEAMFITTERS	1.50	1.50	1.53 1/8	1.50	1.50 1/4	1.62 1/2	1.50	1.50	1.50
STONESETTERS (Masons)	1.50	1.75	1.50	1.75	1.50	1.50	1.75	1.75	1.50
TILESETTERS	1.50	1.37 1/2	1.37 1/2	1.37 1/2	1.37 1/2	1.50	1.50	1.37 1/2

Prepared and compiled by
CENTRAL CALIFORNIA CHAPTER, ASSOCIATED GENERAL CONTRACTORS OF AMERICA

with the assistance and cooperation of secretaries of General Contractors Associations and Builders Exchanges of Northern California.

F.P.H.A. APPROVES SARAN TUBING

Federal Public Housing Authority, after exhaustive tests extending over several months, has authorized the use of saran tubing and fittings for water lines in publicly financed war housing. Extruded by several firms, the tubing will be available through regular distribution channels in virtually all parts of the country. The F.P.H.A., however, recommends saran for use in areas with difficult water conditions such as the eastern seaboard, some of the southern states and the two northwest states of Oregon and Washington. This suggestion is based on the fact that saran prices will compare with copper tubing and fittings considered desirable in the past for hard water.

Present arrangements call for the manufacture of some 600,000 feet of tubing and 200,000 fittings per month. For this preliminary three-month program, plans call for use of these parts in 5000 dwelling units per month or in a total of 15,000 units. Savings in galvanized steel pipe are calculated to approximate 500 tons. The tubing will be used for both hot and cold water lines. However, for connections between water-backs and range boilers, between direct fired coal water heaters and storage tanks, and for overflow lines from relief valves, F.P.H.A. recommendations call for the use of standard weight galvanized iron pipe. F.P.H.A. instructions note that the tubing, coming in three sizes— $\frac{3}{8}$, $\frac{1}{2}$ and $\frac{3}{4}$ -inch—and with a normal wall thickness of .062-inch, is considered safe within a range of 200° F. and psi. working pressure.

PLASTICS TODAY AND TOMORROW

"Plastics Today and Tomorrow," and exhibition of the uses of plastics in the war effort and in the post-war world, was recently held at the Yale School of Fine Arts in New Haven, Conn. Sponsored by Yale University, the exhibit was arranged for and collected by "Modern Plastics" in the belief that it would provide a graphic demonstration of the versatility of the industry and stimulate the interest of schools of higher education in the opportunities open to them for furnishing trained and skilled personnel for the plastic industry. Several thousand plastic items, ranging from a plastic set screw the size of a pin head, to the molded fuselage of an airplane, were shown.

ALBERT KAHN SCHOLARSHIP

The Albert Kahn Scholarship in Industrial Architecture will be awarded this year covering full tuition (\$400.00) to a student who has completed four years of a four-year or of a five-year course in architecture and who has shown outstanding ability in both design and construction in any accredited school of architecture. Deposits and fees amounting to \$35.00 are not included in the scholarship.

Any architect or student interested may obtain application blanks by writing to George Simpson Koyl, Dean, School of Fine Arts, University of Pennsylvania.

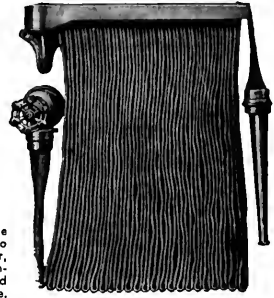

This Lightning Hose Rack is fastened to wall, steel girder, or wooden or concrete column, and carries linen hose.

A Required Safety Measure — A Desired Architectural Feature

The safety and accessibility of required fire protection is made unobtrusive with Lightning Hose Racks, Reels, or Cabinets. Types for every requirement.

The

AMERICAN RUBBER

Factory and General Offices: **Manufacturing Co.**

Park Avenue and Watts Street, Oakland, 8, California

BASALITE

CAMBERED SHINGLE TILE

PERMANENT • FIREPROOF • STORM-SAFE • COLORFUL • ECONOMICAL

Manufactured by

BASALT ROCK CO., INC.

NAPA, CALIFORNIA

SISALKRAFT

REG. U.S. PAT. OFF.

"More than a building paper"

THE SISALKRAFT CO.

205 West Wacker Drive
Chicago, Ill.

55 New Montgomery Street
San Francisco, Calif.

**The Most Complete Line of
STEELS and BUILDING MATERIALS
Made by a Single Producer**



See Sweet's Catalog File or write us for full information.

REPUBLIC STEEL CORPORATION
GENERAL OFFICES: CLEVELAND, OHIO

DENVER, COLORADO CONTINENTAL OIL BUILDING
LOS ANGELES, CALIFORNIA EDISON BUILDING
SALT LAKE CITY, UTAH WALKER BANK BUILDING
SAN FRANCISCO, CALIFORNIA RIALTO BUILDING
SEATTLE, WASH. WHITE-HENRY-STUART BUILDING

**PACIFIC
MANUFACTURING CO.**

HIGH CLASS INTERIOR FINISH
QUALITY MILLWORK

142 SANSOME ST., SAN FRANCISCO
GArfield 7755

6820 McKINLEY AVE., LOS ANGELES
THornwall 4196

BUILDERS EXCHANGE, OAKLAND

**"AMERICAN MARSH"
Redi-Vac Vacuum Heating Pump**



Send for
Bulletin 441

SIMONDS MACHINERY CO.

San Francisco
816 Folsom St.

Los Angeles
455 East Fourth St.

**VERMONT
MARBLE COMPANY**

Producers and Finishers

of

Domestic and Imported Marbles

Write for new pamphlet describing our
Marble Toilets and Showers

San Francisco and Los Angeles

San Francisco phone: SUtter 6747

A.I.A.'S "OCTAGON" TO BE REVISED

At the annual meeting of the A.I.A. in Cincinnati, a special committee was named to make recommendations for carrying out the Institute's wishes that the Octagon be revised in style, form and contents and to this end the various Chapters will be asked for their expressions upon the following:

Would you favor a change in the form of The Octagon to, say, "Reader's Digest" or some other size?

Would you favor the publication of articles of a broad nature on such subjects as the education of the architect, or the relation of the architect to post-war planning?

Would you favor articles of a technical nature, such as on the development of resin products in plastics?

Would you favor articles on personalities in the profession and their work, or personalities in allied fields, such as engineering, construction, etc.?

Would you favor an open forum department in The Octagon to contain short, signed comments from members in criticism or commendation of Institute policies or activities, or of anything else that is of real concern to the architectural profession—barring personalities, of course?

Would you favor discussion of the relation of architects to public building from the public official's point of view?

Can you suggest types of articles?

NEW U. S. STEEL SUBSIDIARY

United States Steel Corporation announces the completion of arrangements with Defense Plant Corporation, an RFC subsidiary, for the operation during the war of the new government-owned steel mill in Utah, substantial completion of which is now scheduled for the end of this year. Under the terms of the agreement, these facilities will be operated for the account of Defense Plant Corporation by Geneva Steel Company, a newly-organized U. S. Steel subsidiary.

No operating fee or other compensation is to be paid to Geneva Steel Company or U. S. Steel for their services in directing the war-time operation of this large plant. All costs incidental to its management and operation will be paid by Defense Plant Corporation, and all proceeds from the sale of its products will be for account of Defense Plant Corporation.

When completed, this will be by far the largest integrated steel mill west of the Mississippi, a plant of the most modern design, whose cost will approximate \$180,000,000. The site of the main plant at Geneva, Utah, known as Geneva Works, embraces more than 1,600 acres.

These Utah facilities were ordered by the Government primarily to provide steel for war shipbuilding needs on the Pacific Coast. Geneva Works was designed by U. S. Steel engineers and is being erected for Defense Plant Corporation by Columbia Steel Co.

DRAFTSMEN FOR WAR WORK

Over a hundred draftsmen are being sought by the U. S. Civil Service Commission for work in Federal agencies that is necessary to the prosecution of the war. Entrance salaries range from \$1,752 to \$3,163 a year, including pay for the eight hours of overtime incorporated in the 48-hour Federal work-week.

Draftsmen of all types are needed, particularly ship, electrical, and mechanical draftsmen, as well as topographic draftsmen. Agencies needing these types of personnel in the greatest numbers are the several bureaus of the Navy Department, the Coast and Geodetic Survey of the Department of Commerce, and the Geological Survey of the Department of the Interior. The Treasury Department and the War Production Board utilize statistical draftsmen.

Qualified engineering draftsmen in any field are urged to apply. However, persons without previous experience in the fields where needs exist may be appointed and trained in the subject. Women are especially desired. Applicants having training or experience primarily in commercial art, interior decorating, etc., which included any drafting training or experience will be considered.

For positions paying \$1,752 a year, requirements are at a minimum. Persons may qualify with six months of practical elementary full-time paid drafting experience, or with completion of one of the following types of study: at least three semesters of training in drafting in high school; or a thorough course of drafting requiring actual classroom work in a school specializing in drafting; or a U. S.-approved ESMWT course in engineering drafting; or a course in drafting in a college or university.

Persons enrolled in drafting courses are urged to apply, since they may be appointed prior and subject to the completion of these courses.

Applications should be sent to the U. S. Civil Service Commission, Washington, 25, D. C.

MORE HOUSING NEEDED IN L. A.

Seeking new housing to break up Los Angeles' dangerously jammed negro ghettos was the object of a special trip to Washington made recently by Howard Holtzendorff, executive director of the Los Angeles Housing Authority. Up to now the N.H.A. has never taken into consideration racial minorities in programming housing for Los Angeles nor has the local authority ever been consulted on housing needs. At least 2500 additional war housing units are needed for persons of all races. Dr. George Uhl, Los Angeles city health officer, is quoted as saying that conditions in the eastside and particularly in "Little Tokyo" threaten to breed an epidemic "that might assume tremendous proportions, slowing, if not paralyzing, the war effort in the southern city." Estimates are that the negro population in Los Angeles has grown from 40,000 to 91,000 since 1930.

HOGAN LUMBER CO.

Wholesale and Retail

LUMBER

MILL WORK • SASH & DOORS

Office, Mill, Yard and Docks

SECOND AND ALICE STREETS • OAKLAND, CALIF.

Telephone GLencourt 6861

CLINTON CONSTRUCTION CO. OF CALIFORNIA

General Contractors

923 FOLSOM STREET • SAN FRANCISCO

SUtter 3440

FORDERER CORNICE WORKS

Manufacturers of

Hollow Metal Products • Interior Metal Trim

Elevator Fronts and Cabs

Metal Plaster Accessories • Sanitary Metal Base

Flat and Roll Metal Screens

Metal Cabinets • Commercial Refrigerators

269 POTRERO AVE.

SAN FRANCISCO, CALIF.

HEMLOCK 4100

STRUCTURAL STEEL

For Class A Buildings,
Bridges, etc.

JUDSON PACIFIC CO.

1200 SEVENTEENTH STREET
SAN FRANCISCO

Plants: San Francisco - Oakland

N. CLARK AND SONS

Manufacturers of
Quality
Architectural
Clay Products

During this stage of the war, our principal energy is to manufacture products required by the various war agencies. We still can supply some pre-war materials for civilian needs.



401 PACIFIC AVENUE
ALAMEDA, CALIFORNIA
San Francisco • Los Angeles
Salt Lake City • Portland



HERRICK IRON WORKS

STRUCTURAL STEEL
REINFORCING STEEL

18TH AND CAMPBELL STS.
OAKLAND, CALIF.
Phone GLencourt 1767

ABBOT A. HANKS, INC. Engineers & Chemists

INSPECTING — TESTING — CONSULTING
CONCRETE • STEEL • MATERIALS
CHEMICAL AND TESTING
LABORATORIES
• RESEARCH AND INVESTIGATION •

TESTS OF STRUCTURAL MATERIALS
DESIGN OF CONCRETE MIXES
SHOP AND ERECTION INSPECTION OF
STRUCTURES AND EQUIPMENT
INVESTIGATION OF STRUCTURES
AND MATERIALS
TESTS AND INVESTIGATION OF
FOUNDATION SOILS
FIRE RESISTANCE AND INSULATION
TESTS

624 Sacramento Street, San Francisco

INSTITUTIONAL POST-WAR MARKET

An eight and one-half billion-dollar market for mass feeding and mass housing equipment and supplies is revealed by the post-war planning survey just completed by Institutions Magazine among more than 50,000 managements in the institutional field. Over 92 per cent of the hotels, hospitals, restaurants, schools, clubs and similar institutions making up this big-consumer market are definitely scheduling extensive rehabilitation work or new construction.

It is estimated that from three to five years will be required to complete this mammoth program. However, so many owners and operators of institutions are already blueprinting their plans, the survey indicates, that most of the work not already in progress will begin the moment that the necessary material can be made available to them.

The tabulation of the post-war planning survey indicates that 39% of the nation's more than 300,000 institutions are scheduling some new construction; 24% plan exterior remodeling; 55% intend to remodel interiors; 49% will re-equip general operating facilities; and 44% are going to re-furnish.

The \$8,500,000,000 which the work will require will be allocated to each department in the following manner: Kitchens (including food service

supplies)	14%
Bedrooms	10%
Dining Rooms	6%
Public Rooms	7%
Plumbing	10%
Heating	11%
Air Conditioning and Refrigeration	3%
Laundry	8%
Building Exteriors	29%
Other Departments	2%

Although 91% of all institutions are keeping their plans flexible so as to take advantage of new product developments, 7% of the field have work actually in progress, 36% are entirely ready to start when the material situation permits, 7% have plans in the blueprint stage, 12% state that their work is being actively

INCANDESCENT SUPPLY COMPANY

647
MISSION STREET
SAN FRANCISCO

Lighting Fixtures and
Lamps, Fireplace Fur-
nishings, Pictures and
Mirrors, Electrical Sup-
plies and Marine Fix-
tures.

Oakland - Fresno
Los Angeles

Independent Iron Works

Structural Steel
Ornamental Iron
Steel Service Stations
Steel Tanks
Standard Steel Mill Buildings
Bridges

821 Pine Street Oakland

ANDERSON & RINGROSE

General Contractors

320 Market Street, San Francisco
Phone GARfield 2245

MULLEN MFG. COMPANY

BANK, STORE AND OFFICE
FIXTURES—CABINET WORK
OF GUARANTEED QUALITY
CHURCH SEATING

Office and Factory:
60-80 RAUSCH ST., Bet. 7th and 8th Sts.
San Francisco
Telephone UNDERhill 5815

THE TORMEY COMPANY

GENERAL PAINTERS
AND DECORATORS

Phone UNderhill 1913

563 FULTON STREET
San Francisco

Phone GARfield 1164

Thomas B. Hunter

Consulting Engineer

DESIGNER OF HEATING
AIR CONDITIONING
VENTILATING AND WIRING
SYSTEMS, MECHANICAL
AND ELECTRICAL EQUIP-
MENT OF BUILDINGS

41 SUTTER STREET
ROOM 710

San Francisco California

Robert W. Hunt Company

ENGINEERS

Inspection • Tests • Consultation

Schools and Other Structures
Are Built as Designed

When Construction Materials are
Inspected at point of Manufacture
and during Erection by

ROBERT W. HUNT COMPANY

Cement, Concrete, Chemical, Metallurgical,
X-Ray and Physical Laboratories

Chicago - New York - Pittsburgh
Los Angeles - All Large Cities
San Francisco, 251 Kearny Street

planned and 38% indicated that it is under discussion.

TRAIN FOR RESCUE WORK

Plans for a school to train 50 or more Civilian Defense Rescue Service chiefs from eight western states are being laid by the Ninth Regional Office of Civilian Defense. The school, to be conducted by O.C.D. with the assistance of the U. S. Bureau of Mines, is scheduled tentatively for November 8-18 at the University of California.

The Berkeley school, for which complete accommodations have been provided by the College of Mines, will offer a ten-day course in rescue techniques to be employed in disaster due to enemy bombardment, sabotage, industrial accidents or natural causes. The faculty will include outstanding experts in the technical fields related to rescue work. Throughout the course a highly trained rescue squad will demonstrate, with the aid of a specially constructed "incident," such rescue techniques and procedures as tunneling, shoring, and extrication of casualties. The use and care of respiratory protective devices will be stressed, and an evening course in first aid will be offered by experienced Bureau of Mines instructors.

Chiefs of the Rescue Service of all State Councils in the Ninth Civilian Defense Region, and the rescue chiefs and other key rescue personnel in all the larger communities within target areas, are being urged to attend this course which is one of two Pilot Rescue Service Training Schools to be held in the nation.

BRIDGE COMPETITION POSTPONED

The American Institute of Steel Construction announces that, due to the effect of conditions brought about by the war emergency, it has been decided to suspend its Students' Annual Bridge Design Competition until the war has ended.

This action, although necessary because of students' wartime schedules, is greatly regretted by the Institute, particularly on account of the gratifying response on the part of students

USE
Mailway
Banking

**FOR LARGE OR
SMALL ACCOUNTS**

Whether your account is large or small, business or personal, checking or savings, you will find our Mailway service helpful. We have special facilities to make banking by mail easy and prompt. Our careful attention to your needs will enable you to bank with us by mail, at greater convenience to you.

Open a Mailway account by mail

**CROCKER FIRST
NATIONAL BANK**
OF SAN FRANCISCO
Chief Among United National Bank

Member Federal Deposit Insurance Corporation
ONE MONTGOMERY STREET

**LANDSCAPING
WAR HOUSING PROJECTS**

Maritime Commission
Apartments, Richmond
Sunnydale
G. G. Bridge Approach
Roosevelt Terrace, Vallejo
Camp Roberts
Chabot Terraces, Vallejo
Peralta Villa, Oakland
Sausalito
Union Square Garage

★
Growers and Distributors of
"Superior Quality" Nursery
Stock Since 1878

**LEONARD COATES
NURSERIES, INC.**

Roy D. Hartman, President-Manager

SAN JOSE, CALIFORNIA

**DINWIDDIE
CONSTRUCTION
COMPANY**

BUILDERS

CROCKER BUILDING
SAN FRANCISCO

REMILLARD-DANDINI Co.

**Brick and
Masonry Products**

633 BRYANT ST., SAN FRANCISCO
569 THIRD ST., OAKLAND

**G. P. W.
JENSEN & SON**

Building Construction

320 Market Street, San Francisco
Phone: GARfield 2444

**JOHN
CASSARETTO**

—Since 1886—And Still Active—

Building Materials

READY MIX CONCRETE
ROCK - SAND - GRAVEL - LIME
CEMENT - PLASTER - MORTAR
METAL LATH - WOOD LATH
STUCCO - WIRE NETTING

Service Unexcelled

Bunkers
Sixth and Chunnel, San Francisco
Phones: GARfield 3176, GARfield 3177

since the competition was inaugurated in 1929. The interest shown by the student entrants in this competition led to a marked stimulation of ideas in connection with modern bridge design.

SHASTA DAM 82% COMPLETE

The diversion tunnel at Shasta Dam is in full use with the entire flow of the Sacramento River going through it, the United States Bureau of Reclamation has announced.

Rising blocks of concrete in the spillway section turned part of the river through the tunnel on June 26 and continued construction activities in that section have brought the reservoir to a level permitting the tunnel to form a channel for the entire river flow.

Construction Engineer Ralph Lowry said that the actual diversion of a river around a dam usually is a significant event in the history of this kind of job, and a construction man never breathes easily until the river is under control. "By late fall, if the present schedule is carried out, concrete in the spillway section will be so high that it will take a bigger flood than has ever occurred to cause us much trouble," Mr. Lowry said.

With the river in the tunnel, a cofferdam across the river bed above the tunnel outlet will prevent backwater from interfering with placing the spillway apron. The apron is a thick layer of concrete placed over the river bed area at the foot of the spillway to prevent the fall of water from eroding the rock at the downstream toe of the dam.

With more than five and one-half million cubic yards of concrete in place Shasta Dam is nearly 88 per cent complete. The pouring schedule on mass concrete will be completed within a year if the present rate of placement is maintained. Since the first concrete was placed in July, 1940, Pacific Constructors, Inc., the general contractor, has manufactured and placed an average of nearly 156,000 cubic yards per month. In the right abutment section, 18 blocks are complete and most of the blocks of the left abutment

are ready for the final concrete pour in that area.

In the Shasta Power Plant, the installation of machinery continues, with the assembly of the No. 3 generator well under way. Installation of penstocks for Units 3 and 4 is about 60 per cent complete and cable and wiring installations are on schedule.

U. S. STEEL BUYS WAR BONDS

United States Steel Corporation and subsidiary companies purchased United States securities amounting to \$100,000,000 during the third War Loan Drive. The subscription will be allocated in various amounts for credit to the districts in the United States in which the corporation operates.

U. S. Steel and subsidiary companies purchased \$30,000,000 of securities in the second War Loan Drive.

the
**LIVABLE
KITCHEN**

Architects today are not only designing the kitchen for convenience and efficiency but they are making a livable room of it.

To this end Paramount Built-in Fixtures meet the most exacting requirements. Their "Deluxe," "Moderne" and "Economy" cabinet fixtures are distinctive in design and construction and may be had in stock sizes or built to order.

Catalog for the asking

Paramount
BUILT-IN FIXTURE COMPANY
5107 Broadway, Oakland, California
Phone PLedmont 8100

A. F. MATTOCK CO.

Builders

212 CLARA STREET
SAN FRANCISCO

ARCHITECT
AND
ENGINEER

NOVEMBER, 1943



... — **IT'S EVERYBODY'S JOB**

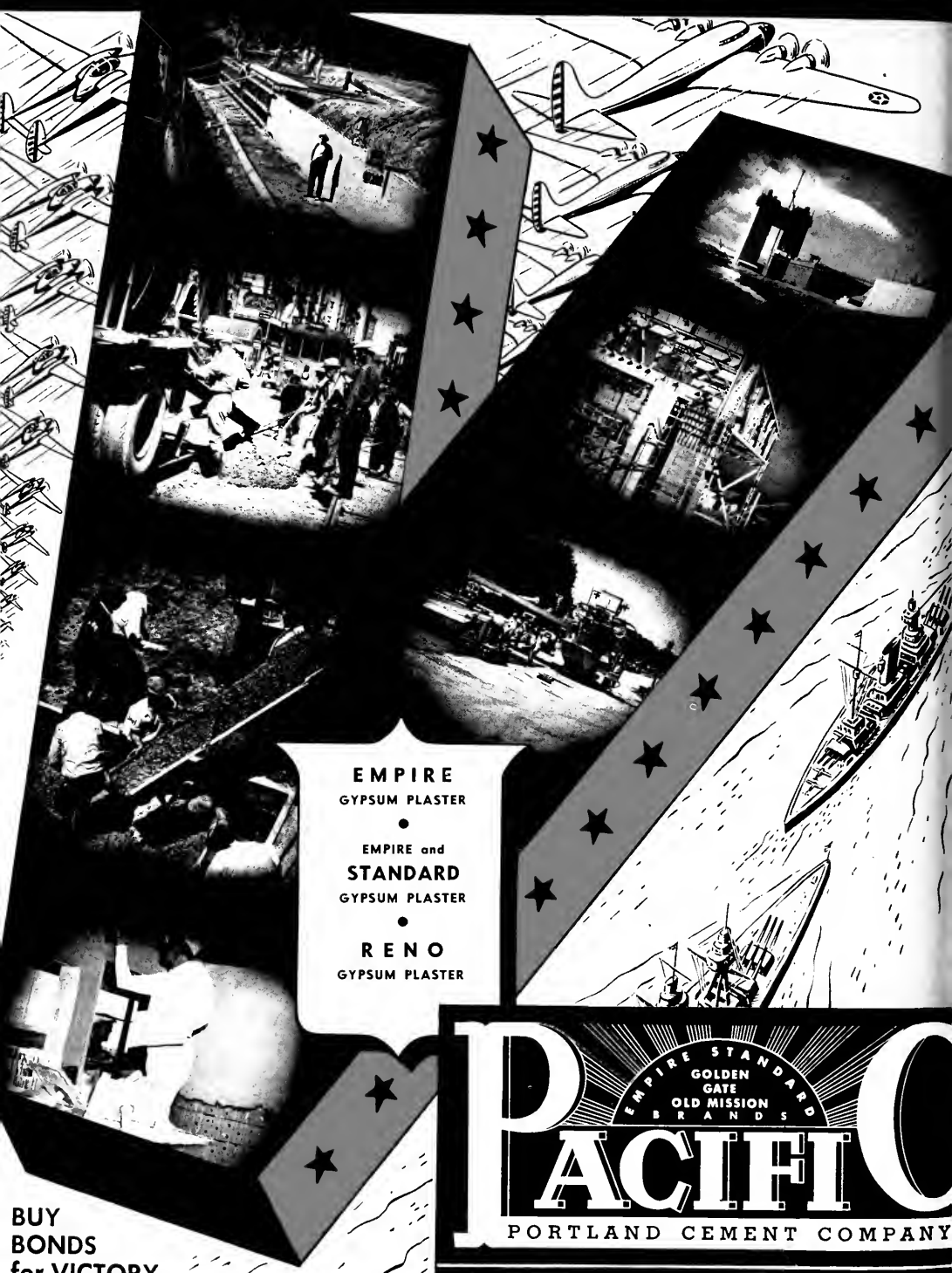

EMPIRE
GYPSUM PLASTER
•
EMPIRE and
STANDARD
GYPSUM PLASTER
•
RENO
GYPSUM PLASTER

BUY
BONDS
for VICTORY

PACIFIC
EMPIRE STANDARD
GOLDEN GATE
OLD MISSION
BRANDS
PORTLAND CEMENT COMPANY

SAN FRANCISCO • LOS ANGELES • PORTLAND • SEASIDE

ARCHITECT AND ENGINEER

Volume 155 No. 2

FRED W. JONES
Editor

MARK DANIELS
Associate Editor

MICHAEL GOODMAN
Consulting Editor

HOWARD MOISE
Post-War Planning

E. N. KIERULFF*
Ass't Editor
*In the Service

NOVEMBER CONTENTS

COVER:

Four views of San Pablo prefabricated elementary school

PHOTOGRAPHY:

San Pablo School—Robert C. Kaestner

Blimp hanger, Santa Ana Naval Air Station
—Navy official photographer

Running Fire	3
Mark Daniels	
News and Comment on Art	4
In the News	8
New Schools for War and Post-War Needs	12
Robert C. Kaestner	
Navy Blimp Hangar at Santa Ana	19
The Public and Its Architect	22
Jan Reiner	
Planning	
Actual Post-War Work?	26
Arnold A. Weitzman, A.I.A.	
The Post-War Employment Problem	28
State Association of California Architects— Sixteenth Annual Convention	33
W. C. Ambrose, Architect	
Producers' Council Page	35
Products for Post-War Practice	39

NEXT MONTH

Space limitations necessitated carrying over to December the San Francisco Shoreline Report by L. Deming Tilton, Director of Planning, announced for publication in this month's issue. A review of the Report will be accompanied by full-page plates illustrating the various proposals of the plan.

"Stained Glass, Past and Future," by Jeannette Dyer Spencer, describes the technique of this interesting age-old art—the glory of the ancient cathedrals, crowning achievement of a devout world. Mrs. Spencer answers the oft-repeated query today, "will stained glass be one of the arts resurrected?"

The war has been the means of developing many fresh examples of good, old-fashioned American ingenuity, one at point being a unique housing project of the Santa Fe Railroad and known as "Indian Village." The author describes the conversion of a train of abandoned freight cars into modern housing units for Navajo Indian war workers.

Recent discussion of "The Design, Fabrication and Erection of Rainbow Bridge at Niagara Falls," uncovered some interesting structural features enumerated by the Resident Engineer of Bethlehem Steel Company, E. L. Durkee, in a motion picture talk before the Structural Engineers' Association of Northern California. A summary of Mr. Durkee's paper (with illustrations) makes good reading.

ARCHITECT AND ENGINEER (Established 1905) is published on the 15th of the month by The Architect and Engineer, Inc., 68 Post Street, San Francisco. President, K. P. Kierulff; Vice-President, Fred'k W. Jones; Secretary-Treasurer and Manager, L. B. Penhorwood; Advertising Manager, V. E. Atkinson, Jr.

Los Angeles Office: 403 W. 8th Street, Robert W. Walker, Manager.

Entered as second class matter, November 2, 1905, at the Post Office in San Francisco, California, under the Act of March 3, 1879. Subscriptions, United States and Pan America, \$3.00 a year; \$5.00 two years; foreign countries \$5.00 a year; single copy 50c. ARCHITECTS' REPORTS are published daily from this office, Vernon S. Yallop, Mgr.



Haws
Model No. 7A
Automatic Stream
Control

Plan **NOW FOR TOMORROW**



TODAY, Haws is supplying our armed forces throughout the world and the many war industrial plants which are supplying our service men and women with fighting materials.

TOMORROW, Haws will supply the architect, builder and owner with drinking faucets and fountains having every sanitary advantage possible, with modern fixtures. They are efficient, economical to install and maintain, and convenient to use.

SINCE 1909, Haws have supplied schools, playgrounds, public buildings, industrial plants and buildings with sanitary drinking faucets and fountains, and for the past ten years with modern electric water coolers. Your confidence in the products, which we have produced in the past, serves us to plan to serve you well in the future. Specify HAWS drinking faucets and fountains.

Haws **DRINKING FAUCET COMPANY**

1808 HARMON STREET • BERKELEY, 3 • CALIFORNIA

Agents in the following cities:

Chicago • Los Angeles • San Francisco • Seattle • Salt Lake City • Portland
New Orleans • Houston • Atlanta • Philadelphia • Worcester, Mass.

RUNNING FIRE — by MARK DANIELS

PRIORITIES AND HOUSING

Not that it is at all unusual, there exists a particularly flagrant type of contradictory demand in the conditions and requirements established by the government as a basis for one of their songs with which they serenade the public. We all realize that emergencies cause contrary instructions that result in paradoxical requirements, although usually these are justified to harmony in the course of time.

"Mother may I go out to swim?

Yes, my darling daughter.

Hang your clothes on a hickory limb

But don't go near the water."

Yes, children, build us a lot of houses so that our red war workers will have nice homes to live in, but don't use any building material until you get priorities. And just try to get them!

Most of us understand clearly what the situation is and also make allowances for the patriotism of those who are trying to avoid the overuse of critical materials that might jeopardize the war outcome, but when the point is reached where the government refuses to give priorities on nearly all forms of building materials and then upbraids us for not producing new houses for the new war workers, things seem to be going too far. The American people are beginning to say, in the language of the late Harry Leon Wilson's "Cousin Egbert," "I can be pushed just so far."

BEAUTY AND THE BEAST

The other day I heard a highly qualified critic who was examining a series of plans in a recent publication, cry out, "What a beast of a plan that is!" I had been over those plans and thought they were exceptionally good from a functioning viewpoint, and told him so. I pointed out to him where the sunlight had been made available to the maximum, where circulation was excellent and low cost was apparent.

"True," he said, "and while I don't mean that even if it were good, still I wouldn't like it, it is never-the-less a beast of a plan. I mean that if the designer had been a true architect he could have accomplished all you claim for it and still have made the plan beautiful."

I did not feel equal to a long discussion of what is beauty, in the abstract, or what changes in our present concept of beauty might make that of today seem ugly. No, I did not want to argue the point; because I had a lurking suspicion that he was right.

PREFABRICATION AND PRODUCTION

Prefabrication has become such an all embracing subject that it has swallowed everything related to it, down to calling the making of bricks "prefabrication" because they are made for use in a structure before the structure itself is started. That is no prefabrication in the sense in which that overworked expression is used today. That is a primitive form of getting into PRODUCTION. If an architect designs a structure in such a way that certain units can be built apart from the site and later assembled on the site and there erected, that is PREFABRICATION. But if the builder manufactures elements of those

units and assembles them to construct those units, that is production, of a form. The line between Prefabrication and Production that is drawn by contractors is a shifting one and it is possible that, at some time, it will be all Production. Until that time we will all be trying to get Prefabrication into Production.

CHINESE EXCLUSION IN REVERSE

If the Chinese should put the Americans who are allowed in China on quota, we might look at our treatment of them in this country in a different light. Unthinking people will say, offhand with characteristic snap judgment, that the Chinese would be by far the greater losers, but the question is debatable.

Spiritually the Chinese would lose nothing. Aesthetically they could only gain by eliminating interference from our youthful conception, with their age-old cannons of art and profound philosophies. Economically I doubt if we ever leave half as much as we take out. And, just think of the salutary effect being placed upon a quota would have upon our boasting travelers!

ONE SOLUTION

The draft seems to be in doubt about the value of fighting too hard over dad drafting. This seems to me to be a bit of unnecessary pothole, or at least a little hasty. Give them a bit more time and the OPA will have the entire male population reduced to a condition where they will have to join the army to get anything to eat.

PETS

Birds are the national pets of China.

Dogs are the national pets of England.

The national pets of the U. S. vary in character, almost annually, usually according to politics. Right now they are the so-called "war-workers"; and how we are pampering them!

How long they will remain at the head of the list depends upon how long we plain earners can pay the piper. At present we are paying them unheard-of hourly rates. If a man, woman or child can prove that his is a war work (and who cannot), his demands for pay in astronomical figures are granted. Formerly, when we were caught in a war, those who did not shoulder a gun took a hitch in the belt and pitched in to work. Now we run bus lines to transport "war workers" a few hundred yards to work. A few days ago one of the leading New York papers carried an ad offering top prices for 1941 or later models of "Cadillacs" for resale to war workers. The natural inference is that only Cadillacs or better would be consistent with the income of the "war worker."

FENCES

In all probability some of Hitler's ideas were based upon good old customs. Take his determination to build a fence around Europe. The Anglo-Saxon race has, for centuries, been fencing in their properties, and Hitler is not the first man who has tried to fence in property that did not belong to him. In many instances, that is a way to acquire title that otherwise can't be established. Here in the west we call it acquiring title by the McEnerney act. All Hitler needed was a McEnerney act that could be applied to all Europe.



EXPECTANCY
by Chang Shu-Chi
deYoung Memorial Museum

Courtesy Art Institute of Chicago

DE YOUNG EXHIBITS PAINTINGS OF EMINENT CHINESE SCHOLAR

Now showing at the deYoung Museum in San Francisco is an exhibition of watercolors by one of China's foremost contemporary artists, Professor Chang Shu-Chi. Prof. Chang is already a familiar figure in this country both through his work, exhibited at leading American galleries and museums, and through his "official" capacity as "ambassador of art and good will" from the Chinese government. It was two years ago that Prof. Chang left the Orient and came to the United States as a sort of cultural emissary from Generalissimo Chiang Kai-shek.

Prior to the Japanese invasion Professor Chang lived with his wife and four children in Nanking, acting as head of the art department at the National Central University there. When the capital was moved to Chungking, the University went with it—and so did Prof. Chang. His family, however, were caught in occupied territory, and it has been six years since Professor Chang has seen them. Feeling that his country's cause and the permanent cause of cultural values could be furthered to a great degree by coming to America, in 1941 Chang packed his paints and brushes and left his native land.

During his stay here, such leading museums as the Chicago Art Institute, the Baltimore Museum of Art and the Kansas City Art Institute in this country, also the Royal Ontario Museum, the Montreal and Ottawa Museums of Canada, have held one-man shows of his work. The current exhibition at the de Young marks his first showing on the West Coast.

A major accomplishment was his "The Hundred Doves", a scroll symbolizing the doves of peace which was presented by the Generalissimo to President Roosevelt and which now hangs in the White House.

Regarding his work, his friend Dr. Lin Yutang, says: "Prof. Chang Shu-Chi . . . has achieved a special technique with two-color brushes which should be highly interesting to all artists. The delicate shading which he achieves with such complete ease is amazing. It is a delight to watch



Courtesy of Life Magazine

PROFESSOR CHANG SHU-CHI
... demonstrates his painting technique
at de Young Museum.

Professor Chang at work, which shows more clearly than anything else the quickness and ease with which conceptions of line and form are recorded by Chinese painters, through mastery of the brush."

Bay region visitors to the de Young Museum will have the opportunity to see for themselves this ease and dexterity which the Chinese artist has so completely mastered. During the run of his show, each Sunday afternoon from 3:00 to 5:00 o'clock, Professor Chang will demonstrate his painting technique, creating his lovely watercolors of flowers and birds for the public to watch and enjoy.

LATIN-AMERICAN CINEMAS AT SAN FRANCISCO MUSEUM OF ART

A Latin-American program of moving pictures will be presented monthly as a regular service to those interested in our neighbors. Russia, China, Great Britain as our allies will appear at frequent intervals. Occasionally war films will be shown because they are exceptionally fine and informative films, not simply to trade on the emotions of the

AN EVER CHANGING WORLD

times. The enemy will appear too, and so will lands like Italy, Greece, France, that will be much in the news. Pictures of what those lands look like will be good background for the headlines of the months to come. These programs are free, and are presented by the San Francisco Museum of Art as a public service in visual education.

RECENT WORKS OF QUINTANILLA ON VIEW AT DE YOUNG MUSEUM

The work of a soldier and artist of Republican Spain, Luis Quintanilla, on view at the De Young Museum, has brought forth both favorable and unfavorable comment. At the request of his Government the artist was commissioned to do a series of five frescoes to be hung in the projected Spanish pavilion at the New York World's Fair; he left the battlefield for the United States to accomplish this task. Before the assignment was completed, the Republican Government had collapsed, since which time Quintanilla has, quite naturally, been refused entrance to his native country. The panels were finished at a later date, however, and have been shown, along with others of his works, at the Museum of Modern Art in New York.

The exhibition which the De Young Museum is showing contains many of the same paintings, pastels, drawings and etchings contained in that previous and first American exhibit of his works. All that remains of his work done in Spain, his series of drawings of the Civil War, reproduced in the book, "All the Brave," may be seen, along with other black-and-whites on the Spanish scene.

The oils and pastels are the result of his efforts since coming to the United States, where he intends to make his home and has already taken out citizenship papers. A recent assignment here was his execution of working drawings for the film, "For Whom the Bell Tolls," and also a number of paintings done in conjunction with the picture. One of these, a large canvas showing Gary Cooper in the role of Robert Jordan, is now on view.

The San Francisco Chronicle in its review refers to the Quintanilla oils as scarcely the kind of thing one would expect from that quarter. "They are mostly sophisticated caricatures of a type the lamented Vanity Fair would have loved, and while they are good enough of their kind, the results seem scarcely worth all the trouble it took to paint them. The drawings are very much more significant. Here the caricaturist's power over human types is brought into play to provide arresting and memorable partly achieved vignettes of the Spanish war."

DE YOUNG DISPLAYS PAISLEY SHAWLS FROM ITS COLLECTION

The de Young Museum is now showing an unusually colorful and exotic textile display. It consists of Near-Eastern and Paisley shawls belonging to the Museum—incidentally, one of the best collections of the so-called "Cashmere" shawls. The fashion that Napoleon introduced in France upon his return from Egypt and which soon spread over the European continent, is beautifully illustrated in the current exhibit. Original shawls from Asia and from Paisley in Scotland, famous textile center

during the Victorian Era, in rich reds, blues and yellows, with typical all-over geometric and floral designs, combine to make this exhibition one of the most delightful the textile department of the de Young has assembled. The shawls can be seen throughout the month.

ARTISTS PREVIEW ANNUAL SHOW OF PAINTING AND SCULPTURE

Art Association Annuals furnish the opportunity each year for taking stock of the San Francisco art scene, as well as assessing new talents and familiar entries from all parts of the country. The same activity that made Marinship a large, and on the whole good show despite its limitations, has worked in the Annual to produce a lively, varied, vigorous but small, exhibition.

On Wednesday, October 19th, a preview for the artists, Art Association and Museum members and their friends, brought together all of prominence in the San Francisco Art world, who rarely meet these days of war. Later the exhibition was thrown open to the public.



"ISABELLA"
Oil on Canvas, by Alex Brook.

Albert N. Bender Collection at
San Francisco Museum of Art



PELIKE VASE—Greek, 5th Century B. C.
From the Spreckels Collection now on Exhibition
at Legion of Honor Palace.

LEGION OF HONOR PALACE HAS VALUABLE ART TREASURES

The recent gift of Albert C. Hooper of his art collection to the California Palace of the Legion of Honor in San Francisco (Architect and Engineer for October) consists of 368 items, including 19 paintings; 3 pieces of sculpture; 28 furniture items; and 98 pieces of porcelain; 19 clocks and watches, 39 pieces of silver; and a collection of miscellaneous items of decorative art including glass, ivory, enamel, lacquer, tapestry and marble.

In accepting the collection, the California Palace of the Legion of Honor has passed the following resolution:

"WHEREAS Mr. Albert Campbell Hooper of Palo Alto, California, has generously offered to present to the California Palace of the Legion of Honor his magnificent collection consisting of nineteen oil paintings and numerous valuable items of decorative arts, the collection totaling three hundred sixty-eight articles; and

"WHEREAS said articles will form a most important addition to the museum's permanent collections, for the education and entertainment of present and future visitors to the California Palace of the Legion of Honor; now, therefore, be it, and it is hereby

"RESOLVED, by the Board of Trustees of said California Palace of the Legion of Honor, that, on its own behalf, and on behalf of the people of the City and County of San Francisco, it gratefully accepts said offer of said important collection and extends to Mr. Hooper its heartfelt gratitude for his thoughtfulness and generosity."

TWO SPECIAL EXHIBITIONS AT THE PALACE OF THE LEGION OF HONOR

Two special exhibitions are being held now and will continue indefinitely at the California Palace of the Legion of Honor in San Francisco. One is an exhibition of painting and sculpture sponsored by the Society for Sanity in Art; the other is Greek vases in the Spreckels collection as published in

the Corpus Vasorum. The latter opened November 1 and will be shown for an indefinite period, probably two or three months.

The Corpus Vasorum is a scholarly portfolio illustrating the Greek and Italic vases of the two museums in San Francisco, the De Young and the California Palace of the Legion of Honor, with descriptive text on each vase. It was written by the great expert in the field, Professor H. R. W. Smith of the University of California. The Greek vases in the Spreckels Collection are among the finest and rarest in the world and are unsurpassed, really in quality. San Francisco art lovers are indeed fortunate to be able to study these vases.

DE YOUNG EXHIBITS RARE COLLECTION OF CHINESE ART

The De Young Museum is fortunate in having been loaned an exquisite exhibition of "Archaic Chinese Mirrors, Small Bronzes and Jades" from the collection of Mr. and Mrs. Frank G. Marcus of San Francisco. The public is afforded a rare treat of seeing an aspect of Chinese art which is usually sadly neglected by most museums; objects which do not come under the heading of "display" pieces, but which actually constitute small masterpieces.

EXHIBITIONS IN DECEMBER AT THE S. F. MUSEUM OF ART

Paintings by Liz Clarke—Now until December 5.
San Francisco Society of Women Artists' Annual—to December 12.

Prints by Roi Partridge, Retrospective Exhibition—to December 12.

Bay Area Council of Camera Clubs—to December 13.

PORTLAND ART NOTES

The feature exhibition in October at the Portland Art Museum was the "Twelve Oregon Artists." Invitations were issued to a dozen painters and sculptors whose work had outstanding merit in last year's Second All Oregon Exhibition. This sequence of large show, open to all comers followed by a smaller invitational show, in which the exhibitors present a number of their works, is a regular offering of the Museum for the purpose of fostering local art and selling it to the public. In the larger exhibition, the Museum assumes responsibility for selling a certain number of works to patrons among the general public, while from the smaller, invitational exhibition, the Museum itself has in the past made purchases for its permanent collection. This is the fourth year of a cycle which has proved itself extremely popular with both artists and public. A number of artists to be seen this year were presented last February by the San Francisco Museum in its exhibition of Oregon Artists. The exhibitors: Louis Bunce, Constance Fowler; Rev. Bernard Geiser, Marianne Gold, Charles Heaney, Lydia Herrick Hodge, Frederic Littman, Sgt. R. E. Jakobsen, Carl Morris, Hilda Morris, C. S. Price, and A. C. Bunquist.

A second exhibition presents Contemporary Textiles. This includes a collection of sixteen textile prints by leading American and European designers, fifteen examples of textiles woven by Dorothy W. Liebes of San Francisco; and nineteen pieces and samples of the fabrics woven for Timberline Lodge on Mt. Hood.—R. T. D.

WHAT'S ON YOUR MIND?

Letters to the Editor

ENGINEERS' REGISTRATION FEES

Editor
Architect and Engineer:
Many registered engineers serving in the armed forces apparently do not understand the law governing the payment of the annual fee during the time they are in service. There is nothing in the law that allows them to maintain their status as a registered engineer in California without paying the annual renewal fee. However, if his license has been revoked because of non-payment of the fee, an engineer may be reinstated without examination in accordance with Section 114 of the Business and Professions Code.

The State Board of Registration for Civil Engineers has stated that they interpret Section 114 to mean that any registrant, either registered civil engineer or a licensed land surveyor, who has permitted his certificate to expire, may have it reinstated under the following conditions:

- (a) That he served in the armed forces of the United States.
- (b) That his certificate was valid at the time he was inducted or enlisted.
- (c) That he makes application for reinstatement within 60 days after discharge.
- (d) That proof of the date of entrance to and discharge from the armed service be furnished at the time the application is made.

S. F. SECTION MEMBER.

1,000 PER HALLUC

Editor
Architect and Engineer:
In connection with the recent competition by a California architectural magazine, for a prize for post-war living, a Bulletin of the Illinois Society of Architects announces the 1,000 first prize winners thus tersely:

"Well, hallucinations at \$1,000 per hallucination are good business provided you can sell enough of them!"

JOHN STAFFORD.

Berkeley, Calif.

MULTI-STORIED FACTORIES

Editor
Architect and Engineer:
I am interested in a scheme for multi-storied factories for post-war erection in areas which are congested, particularly in bombed areas, where the ordinary type of single story factory is not an economical proposition.

I have consulted the Executive Secretary of The American Institute of Architects who was kind enough to suggest that I should communicate with you with a view to your very kindly giving me some information as to the publication of any details dealing with the multi-story factory.

I would visualize a large block of build-

ings, say six to seven stories in height, each floor subdivided for the occupation of smaller tenants, where all the necessary services, gas, water, electricity and heating, can be provided in exactly the same way as they are in a block of ordinary flats.

Can you let me have any information regarding any projects in the States of this particular character. Any information which you can supply will be very gratefully received.

Yours faithfully,

W. H. L. PRICE.

Bedford Ave.
Trading Estate
Slough, Bucks.

HOUSING PUBLICITY

Editor,
Architect and Engineer:

I want you to know how deeply we of the Housing Authority appreciate the splendid display of our five War Housing projects which you had in the September issue of your magazine, Architect and Engineer.

It is that sort of article and use of pictures which assists in bringing before the public the facts about public housing. We have already received several extra copies of the magazine and most of the officers and commissioners of the Authority have seen it and have been enthusiastic about the attractive way in which you presented it.

We have received several requests for additional copies of this magazine and want to have several more in our own office for distribution from time to time. Would you be kind enough to send us 75 additional copies and bill the Housing Authority?

Sincerely,

HOWARD L. HOLTZENDORFF,

Executive Director.

Los Angeles, Nov. 1, '43.

A MODEST CLIENT TO HIS ARCHITECT

Build us a house of quarried stones
With roof of slates—we hate asbestos—
Where we may sup on wine and scones
And sweetly rest us.

Or e'en a house of well-burned brick
With oaken beams, would amply please us,
So be it that the walls are thick,
For thin walls freeze us.

We loathe a house with too much glass,
And have scant love for plastic features
Or stools of chrome, for we, alas!
Are natural creatures.

And so we are constrained to state
That we reject, without misgiving,
Your cantilevered boiler plate
Machines for living.

—Bulletin Illinois Society of Architects.

LIGHTS ARE BURNING LATE



...IN GAS INDUSTRY DRAFTING ROOMS AND LABORATORIES

Gas appliance manufacturers are concentrating, these days, on war production. But they are finding time, after hours, to project their thoughts and technical skill into the future. ★ New designs are taking form . . . new materials being discussed . . . innovations perfected . . . models built and tested. ★ You can count on our industry to keep pace with your profession in equipping the better homes of tomorrow . . . homes that even now are materializing on your drawing table.

Meanwhile, let's all dig deeper for War Bonds

THE PACIFIC COAST
GAS ASSOCIATION

★ **GAS FUEL**

**SERVING THE WEST
IN WAR AND PEACE**

The New Weapon Against Fire IS **FIREPEL "S"**

A TIMELY CHEMICAL ACHIEVEMENT FOR
THE TREATMENT OF UNFINISHED INTERIOR
WOOD AFFORDING A PRACTICAL METHOD
OF SUCCESSFUL FIRE RETARDATION

IN
Homes

Industrial Plants - Schools

THE ONLY FIRE RETARDANT COATING MATERIAL ON
THE MARKET LISTED AND APPROVED BY

UNDERWRITERS LABORATORIES INC.

DISTRIBUTED BY



GUNN, CARLE & CO.

20 POTRERO AVE.
SAN FRANCISCO
Underhill 5480

BUILD NOW WITH KRAFTILE!

Look at these 9 big advantages
Kraftile Wall Units offer:

1. Priority-free!
2. Non-critical material!
3. Immediate delivery!
4. No limit on quantity!
5. Kraftile Wall Units replace steel and other gone-for-the-duration materials in load-bearing walls and partitions. These units have 10 times the State-required stress resistance.
6. Kraftile Wall Unit partitions go up in about one-third the time it takes for ordinary frame construction. One craft can handle the whole job.
7. No finishing required—these wall units come pre-tiled on one or both sides.
8. Upkeep cost ended. Kraftile Wall Units are scratchproof, waterproof, fireproof, stainproof, can take the heaviest abuse.
9. Costs are surprisingly low.



For more information,
phone or write today to

KRAFTILE
NILES, CALIFORNIA

IN THE NEWS

NEW PRESIDENT, S.A.C.A.



BOLLES

John S. Bolles, newly elected president of the Northern Section, State Association of California Architects, is 39 and a native of Berkeley. His father, the late Edward G. Bolles, was a well known San Francisco architect.

Mr. Bolles enjoys a fine professional background. In 1926 he received his B.S. in civil engineering at the University of Oklahoma. Harvard made him Master in Architecture in 1932 following tours in Turkey and Egypt for the University of Chicago and a year in Cluny, France, for the Medieval Academy of America (Ralph Adams Cram). Mr. Bolles spent nearly three years in Mexico studying Mayan art and architecture for Carnegie Institute. The University of Chicago sent him to Persepolis, Persia, in 1935 and the following year he began the practice of architecture with his father in San Francisco.

His earliest recollection of architect's offices was John Donovan's, in Oakland, with Gutterson, Morrow & Edward Bolles as fellow draftsmen. Mr. Bolles assisted Jose Moya del Pino in the design and execution of murals for the State Ball Room and Temple of Religion at the 1939 Exposition. In fact he designed the Temple of Religion. Soon after war was declared he was employed as area engineer, F.P.H.A. for Marin City and San Francisco housing projects. The State Association's new president maintains a private office at 681 Market Street, San Francisco. His home is in Ross, Marin County.

REGIONAL EXECUTIVE



GUTTERSON

Henry H. Gutterson, architect of San Francisco, is now West Coast Regional Executive for the United Service Organizations which include the Y.M. C.A., Y.W.C.A., National Catholic Community Service, Jewish Welfare Board, Salvation Army and the National Travelers Aid Association. Mr. Gutterson had previously served the United

Service Organizations as Building Counselor and Associate Regional Executive.

John D. Rockefeller, Jr., is Honorary Chairman of the Corporation which has been doing splendid work since the start of the war. West Coast Regional offices are at 26 O Farrell Street, San Francisco.

(Turn to Page 10)

ELECTRICAL SERVICE —

The "Liveability"

Factor in a Home

Homemakers today, forced by war conditions to do their own housework, are learning more than ever the value of electrical service in the home.

They are learning, too, the mistakes that were made in the wiring of their present homes—the awkward placing of switches and outlets — the inadequate wiring, resulting in blown fuses and inefficient operation of outlets.

People living in rented quarters blame the shortsighted policy of the owner in neglecting to provide proper electrical service. But those living in homes they have had built, sometimes unfairly, blame the architects.

Planning of future homes will put the electrical service at the top of the list of important considerations. Whatever else the architect's plans call for, the electrical service will be the key to the liveability of that home.

Study the new developments in the electrical world today. When you start blueprinting for the new homes of the electrical era, you will need all possible background in knowledge of modern electrical practice.

NORTHERN CALIFORNIA ELECTRICAL BUREAU

1355 Market Street
San Francisco

*Electricity is vital for war production.
Use it carefully and without
waste.*



Index to Advertisers

*Indicates Alternate Months

A	
ALADDIN Heating Corp.....	*
AMERICAN Rubber Mfg. Co.....	43
ANDERSON & Ringrose.....	46
B	
BARRETT & Hilt.....	11
BASALT Rock Company.....	44
BAXTER & Company, J. H.....	10
C	
CASSARETTO, John.....	48
CELOTEX Corp.....	*
CLARK, N., & Son.....	*
CLINTON Construction Company.....	45
COATES, Leonard, Nurseries.....	47
COLUMBIA Steel Company.....	*
CROCKER First National Bank.....	47
D	
DINWIDDIE Construction Company.....	48
E	
EL ENCANTO Hotel.....	*
F	
FORDERER Cornice Works.....	45
FULLER, W. P., Co.....	*
G	
GUNN, Carle & Company.....	8
H	
HANKS, Inc., Abbot A.....	47
HAWS Drinking Faucet Company.....	2
HERRICK Iron Works.....	48
HOGAN Lumber Company.....	45
HUNT, Robert W., Company.....	47
HUNTER, Thos. B.....	*
I	
IMPERIAL Brass Mfg. Co.....	31
INCANDESCENT Supply Co.....	46
INDEPENDENT Iron Works.....	46
J	
JENSEN & Son, G. P. W.....	48
JOHNSON Company, S. T.....	*
JUDSON Pacific Company.....	45
K	
KAWNEER Co.....	Back Cover
KRAFTILE Company.....	8
M	
MATTOCK, A. F.....	46
MULLEN Mfg. Co.....	47
N	
NORTHERN California Electrical Bureau.....	9
P	
PACIFIC Coast Gas Association.....	7
PACIFIC Foundry Company, Ltd.....	34
PACIFIC Manufacturing Company.....	44
PACIFIC Paint and Varnish Company.....	34
PACIFIC Portland Cement Company.....	2nd Cover
PARAMOUNT Built-In Fixture Company.....	40
PARKER, K. E.....	3rd Cover
R	
REMILLARD-Dandini Co.....	*
REPUBLIC Steel Corporation.....	44
S	
SALL Mountain Company.....	*
SIMONDS Machinery Company.....	44
SISALKRAFT Company.....	45
STANDARD Engineering Corp.....	42
STANLEY Works, The.....	10
T	
TORMEY Company, The.....	47
U	
U. S. STEEL Company.....	*
V	
VERMONT Marble Company.....	44
W	
WASHINGTON - Eijer Company.....	*
WESTERN Asbestos Company.....	43
WOOD, E. K., Company.....	40
WAR Bonds.....	41
Z	
ZOURI Store Fronts.....	Back Cover

HARDWARE for the "After the Victory" GAME ROOM

Since gas rationing changed the traveling American into a "stay-at-home" many people are studying their homes—finding improvements to make, or thinking of how they will build their new homes, once the war is over.

One of the rooms that will get careful consideration is the playroom. Here, home owners are inclined to give way to their originality. Pine paneling with built-in closets for games and sports equipment, benches with hinged tops to hold toys, cabinets for bar supplies, and other ingenious features will be devel-

oped by home-planners.

Whatever the hardware requirements of a post-war building are, STANLEY will be in a position to fill them.

Due to government restrictions on metals it is impossible to supply all civilian needs in hardware at the present time. We are certain that you and your customers understand why the present shortage exists, and realize that when our big war job is done you will have all the STANLEY hardware you need. The Stanley Works, New Britain, Connecticut.

Typical Stanley Hardware Items for the Game Room

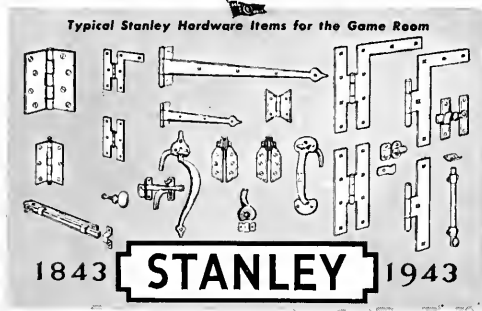

IN THE NEWS

(Continued from Page 8)

PROMOTED TO V.-P.



MANUEL

Burrell S. Manuel, Southern California District manager for the Westinghouse Electric Supply Co., with headquarters in Los Angeles, has been elected a vice-president of that supply company by its board of directors.

A native of Hannibal, Mo., Mr. Manuel first entered the electrical industry in 1901 at Denver, Colo., with the Mountain Electric Co., agents for the Westinghouse Electric & Manufacturing Co. He joined the staff of the latter company at Denver in January, 1905. In 1920 he was sent to San Francisco, where he served until 1927.

In 1927 the Westinghouse Electric Supply Co.—subsidiary of the Westinghouse Electric & Manufacturing Co.—acquired the property of the Illinois Electric Co. at Los Angeles, and Mr. Manuel was transferred there as district manager.

ARCHITECT'S FEE VALID

Claim of F. W. Stevenson, architect, against the San Diego County Board of Supervisors, for \$24,765 fees for preparation of plans for proposed additions to the county hospital, was sustained by Judge Robert Burch in the Superior Court at San Diego. The county having already paid about \$3500 to Stevenson, there is a balance of \$21,000 due him.

Stevenson had a contract with the county for preparation of plans and specifications for proposed hospital additions which were approved by the Supervisors August 11, 1941, and were used in an ineffectual effort to secure a Federal grant. The contract was terminated by a resolution adopted by the Supervisors on October 1, 1942, and further payments were refused. The court held the architect was entitled to his fees under the contract for the work done even though the hospital additions were not built.

RESUMES ARCHITECTURAL PRACTICE

Ernest Irving Freese, architect, has opened an office for the resumption of private practice at 6247 Pine Crest Drive, Los Angeles, and will give his attention to planning projects for postwar construction. Since start of the war Mr. Freese has been chief structural designer with Myron Hunt on projects at Camp Callan and Fort Rosecrans, San Diego.

CZC

PRESSURE TREATED LUMBER
● PROTECTS AGAINST DECAY
AND TERMITE ATTACK

Specify it in your home
Available through Lumber Dealers

LOS ANGELES 601 W. 5th Street Phone Michigan 6294	SAN FRANCISCO 333 Montgomery Street Phone DOuglas 3883
---	--

J. H. Baxter & Co.

AGENTS FOR WEST COAST WOOD PRESERVING CO., SEATTLE, WASH.



Launching the second of 26 concrete ships. Belair Shipyard, So. San Francisco



A city of 5000 homes for war workers. Erected in 180 days. Norfolk, Virginia.



The Bartlett Dam, highest multiple arch construction in the world. Arizona.



For Westinghouse. A new addition to their huge western plant in Emeryville, Calif.



Army - Navy "E" and Star awarded to Barrett & Hilp for over 150 projects on Mare Island.



Construction is the backbone of achievement. Buildings for manufacture and housing, dams for power and irrigation, bridges, roadbeds, ways, docks and airports for transportation . . . these are the products of the construction industry . . . and these had to be built first, before the productive power of our nation could again be proven.

Barrett & Hilp immediately joined with the rest of the construction industry to provide these facilities, and today America's might is pouring forth as a tidal wave to engulf the forces of greed and aggression.

B & H men and B & H methods have created homes for tens of thousands of war workers. New plants and plant additions for war industry. Dams and aqueducts for both wartime and peacetime service. Important sections of both of San Francisco Bay's great bridges. Drydocks, hospitals, cantonments, and ammunition dumps for our armed forces. We have built one complete shipyard and are now launching a new type of concrete ship-shape barge for ocean-going service.

Right now our job is the job of all Americans — to help win this war quickly and completely. The Barrett & Hilp organization is conditioned to fulfill its obligations to a nation at war — and to work with your engineers on blueprints for the future.

BARRETT & HILP
BUILDERS FOR THIRTY YEARS
SAN FRANCISCO • CALIFORNIA

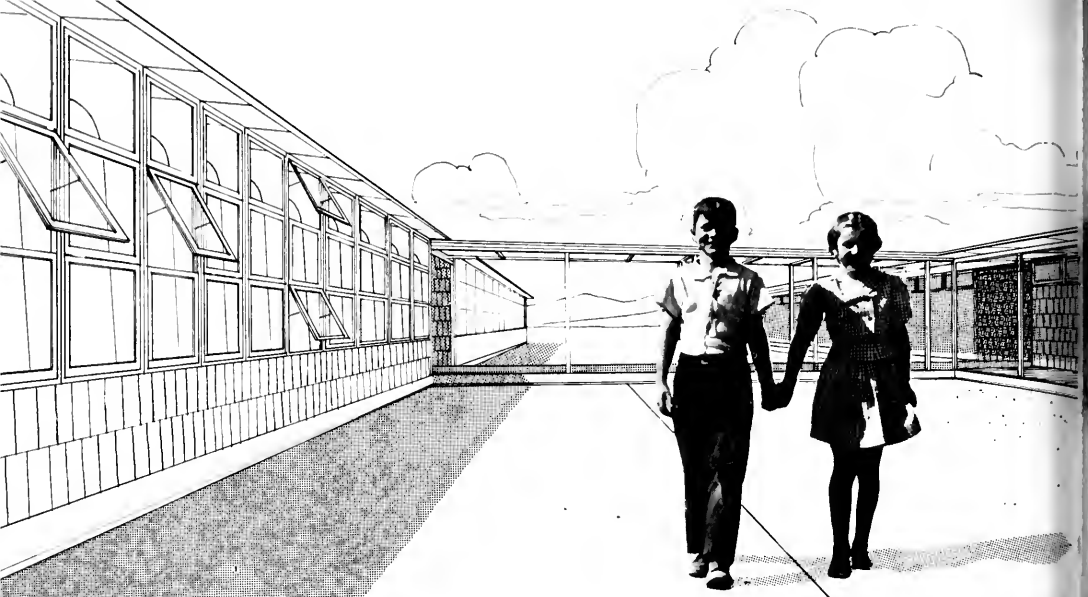

NEW SCHOOLS FOR WAR

by ROBERT C. KAESTNER

Due primarily to the tremendous migration of war workers, our school accommodations in defense areas are proving wholly inadequate. The greater majority of migratory war workers have large families and for every family there is an average of 1.4 children to overcrowd our present school systems. For example, the population statistics from Carquinez Heights Housing Project, near Vallejo, shows by actual count: .32 children of elementary school age (6-12 years inclusive); .096 children of senior high school age (16-17-18 years); .5 children of pre-school age (1-5 years inclusive). The large percentage of children per transient family indicates a younger married group than groups in average city population.

Numerous schools in California defense areas have had their enrollment increased 40 to 60 per cent and in many areas school enrollment has increased 500 to 600 per cent. The housing program for the family has come first while the school building program for the children has lagged behind. The tremendous defense housing program has taken a mighty toll in conventional building materials. Other war conditions have created a scarcity of both building materials and equipment. Notwithstanding all these obstacles, school buildings must be built. The temptation is to erect buildings of a temporary nature, of indifferent design, "to bridge the gap until the war is over" or to cheapen the initial cost rather than to evolve a far sighted or imaginative method to deal with the present critical requirements. The indulgence is to skimp in the qualities of good design instead of the opportunity to experiment with all the qualities of a well designed school.

From an economic standpoint, type, method and time of construction are important factors, not only in initial cost but in war life of the structure. It is obvious that a school building will not deteriorate and become structurally useless suddenly after the war is over. The school building must be at least 95 per cent salvagable. To meet this need it must be a type of prefabricated and pre-finished building which, in the initial construction, will be a time saver, and therefore a labor saver. The forego-

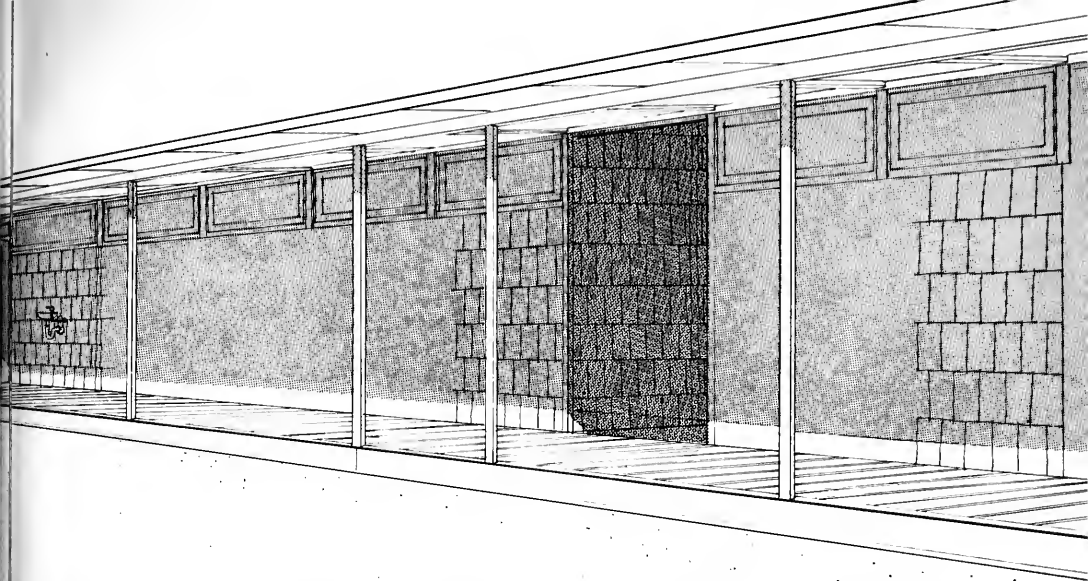

AND POST WAR NEEDS.

ing properties are a means to reduce post-war costs in readjusting the school buildings to other locations or conditions. Critical conditions and times are now forcing upon us, through necessity, a change in our conventional methods—a change long overdue. It should not be merely a temporary war measure to be discarded when peace is signed, but rather a step into the post-war.

The E. J. Kump Co., Architects & Engineers, and the Standard Engineering Corporation of San Francisco have produced manufactured construction by solving the common every day problems. Engineering, materials, manufacturing processes, shipping and erecting, all have been integrated into a well designed school. Each problem was closely connected to each other. The school had to be engineered to meet the requirements of the State Division of Architecture. The engineering plans comprised not only drawings and calculations, but actual physical tests which were the proof of the calculations. New manufacturing processes influenced the design of the structural members. Drawings were

ELEMENTARY SCHOOL, EL PORTAL TRAILER COURT, SAN PABLO, CALIFORNIA
Ernest J. Kump Co., Architects-Engineers
Federal Works Agency, Constructing Agency

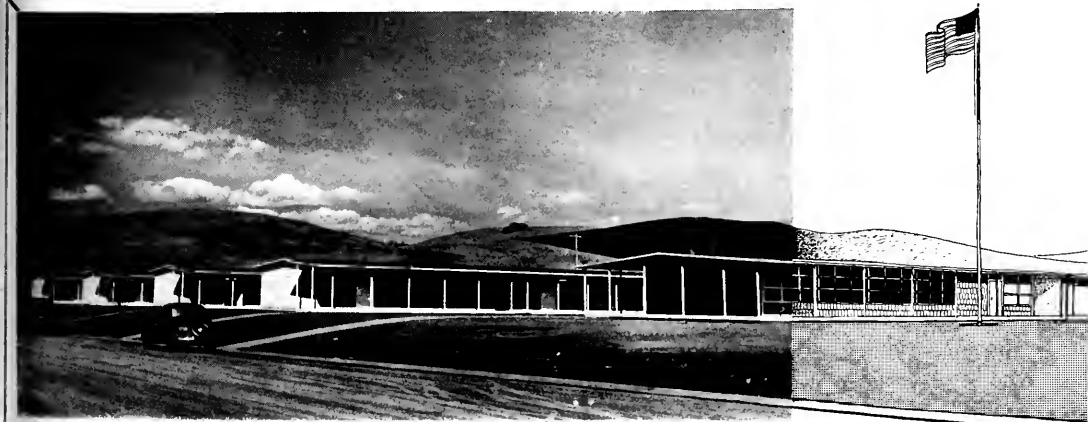



Complete Classroom Unit Being Unloaded From Truck



Laminated Three-Hinged Arches Before Erection

Struc

made for each member with allowances for glue, pre-finished structural members, pre-drilled holes for screws, and ease and speed of erection. Drawings, actual members, ideas, suggestions were often discarded when a better solution was at hand. Materials presented more problems; for example, what lumber was easiest to purchase with low priorities, and what sizes and lengths would be available at all times? There were but two concrete answers to these questions: short lengths and two-inch stock. As a result, the sizes of all members had to fit the two-inch stock and short lengths. Carpenters and mill men had to anticipate a thirty-second of an inch for precision in erecting. Carpentry labor was a critical shortage, therefore small members were used so that there was only one man to a piece. Lumber was green and had to be chemically processed to be true. Machinery and equipment was not available, thus ingenious ideas were put to work for various problems, to solve equipment shortages.

The laminated three-hinged wood arch presented many difficult problems. The arch had to be designed to resist seismic forces when erected and must be able to span different widths. The laminations had to be assembled into a homogeneous mass to construct a sturdy arch that would not crack, check or rupture. To standardize its parts for manufacturing and transportation to various locations entailed a great deal of tedious work. At first the arches took an hour each to assemble, now it takes only three or four minutes.

Space in the plant for working was limited, sizes of members for panels had to be standardized to a few jig tables. The size of all panels was standardized. Floor, wall and roof panels had members of the same and different sizes, but located in the panel in the same position. The panel was designed for any of the common materials of exterior and interior finish, including shingles, gypsum board, flooring, sidings, sheathing, pre-finished wall boards and insulation. All panels, when assembled and ready for erection are pre-finished. Members in panels are all pressure glued, screwed, or nailed as needed.

Labor had no previous experience, and assembly was learned the hard way. The three-hinged arch made the simple structural skeleton possible. Rim joists and girders took extruded shapes because of the limited size of available lumber stock. Each rim joist and girder was built of members pressure glued together. All lineal members were notched to allow for accurate fitting for erection in the field. Holes for screw connections were drilled.





Mudsills and Floor Girders (foreground).
Erecting Wall Panel (background)



Assembling of
Three-Hinged Arches

sembly

Flooring was pressure glued to form a panel and then pressure glued to the core members. A glued floor panel is extremely strong and will not squeak with age.

Windows had to be standardized to meet the following qualifications: Must be weatherproof, waterproof, easily vented, inside or out; horizontally projected, without patent hardware, and easily erected without meticulous fitting. The resulting sash had all these qualifications and one more—it could be a casement window which could be vented to the interior or to the exterior. Shipping and breakage were brought into the design and all preconceived ideas were abandoned to meet standardized requirements. Doors were standardized into units which could be applied the same as the windows. The door sill was part of the door unit.

The electrical system for lighting the classrooms could not be applied as in conventional construction. All of the manufacturing procedures were considered for the electrical distribution. The system had to be standardized to be integrated into the manufactured construction. The problems of concealing wires within the structure was difficult because another trade was brought into the picture. The wiring could not be pre-finished because of the nature of the materials, so it was concealed by semi-structural members. Lighting fixtures had to be designed of least critical materials, yet give proper light for classroom needs. Ceiling surfaces had to have adequate reflecting qualities. The location of the fixtures required expert study to give maximum results. The whole system was standardized for good light, using available materials and insuring speed and economy.

The tendency for most designs for a school building is to let the plumber get his equipment in by boring, notching and cutting, but not in a manufactured pre-finished building. As in the electrical system, another trade was introduced. Cutting or boring of structural members were minimum to code requirements and could not be compensated by other members, as each had a working position. It is not economical to cut and patch, but it is economical to integrate plumbing to a standardized system. Plumbing locations and fittings within the building, therefore, were standardized to the critical and available materials.

Raising End of Wall Panel into Place



Dropping Roof Panel into Place



Fastening Roof Panel With Electric Screwdrivers





TYPICAL CLASSROOM INTERIOR, ELEMENTARY SCHOOL, EL PORTAL TRAILER COURT

Note Bi-Lateral Lighting

When the finished products were ready for shipment, each piece had a definite place on the eight-by-twenty-four truck or trailer bed. Each panel was crated so that the finished surfaces were protected. Crates were designed for easy packaging, removability and reuse. Paper and scrap wood was used between each member with the minimum points of bearing. The packages had to be light enough for a man to handle, yet strong enough to be packed together in a moving truck. The layout and coordination within the manufacturing plant had to be such that as the fabrication proceeded the finished products were stored in single classroom units.

A pallet was designed to fit onto a truck. Each panel and lineal piece was placed so that on arrival for erection the first panel or member needed was on top. Each pallet with a load became one complete classroom building. Steel hoists were designed so the load could be easily picked up and placed on the truck and upon arrival rapidly unloaded. Traveling to the erection site presented problems of dirt, dust and rain. A tarpaulin was fitted to the packaged building.

It should be observed that, as construction proceeds, improvements and adjustments are learned.

The day before the truck arrives with its load the foundation for the building is prepared and mudsills are trued and leveled. Because of the latent condition at the various sites the foundations were not prefabricated.

The truck is parked in a desirable location at the site and can be unloaded in fifteen minutes by a crew of four men. The tarpaulin is removed and the rim joists, girders and floor panels are placed on the foundation. Each panel and members are connected together by screws for greater strength and ease in de-mounting in the future. Electric screwdrivers replaced the hammer as on the conventional building. Pre-drilled holes and electric screwdrivers removes the temptation of driving screws with a hammer.

Lineal members were notched, so butting members were easily placed and connected. Notched plates are screwed to the floor and rim joists to take the thrust of the three hinged arches. If the floor is pre-finished, care is taken so as not to mar it, but if it is to have a composition covering it is treated as any other floor. The arches are placed and lifted into their proper position, followed by the end wall columns. This then forms a structural skeleton with only the skin to be applied. A carpenter and laborer can erect the walls and another

THE SAN PABLO ELEMENTARY SCHOOL IS THE FIRST LARGE SCHOOL PLANT COMPLETED WITH THE PRE-BILT STRUCTURES. IT SERVED AN EXTENSIVE TRAILER CAMP WHICH IS PROVIDED ALSO WITH A COMMUNITY BUILDING AND OTHER FACILITIES.

SEVERAL OTHER PRE-BILT SCHOOL PLANTS ARE UNDER WAY IN OTHER POINTS IN CALIFORNIA. WHEN ERECTED IN THE VALLEY WHERE CLIMATIC CONDITIONS ARE MORE EXTREME, INSULATION IS PROVIDED IN THE PANELS AND THE CHIMNEYS ARE GLAZED IN.

ON PAPER TRAILERS FACILITIES

ELEMENTARY SCHOOL, SAN PABLO, CALIFORNIA



PLANS, ELEMENTARY SCHOOL, EL PORTAL TRAILER COURT SAN PABLO, CALIFORNIA

THE PRE-BILT CLASSROOM UNITS ARE BEING INCREASINGLY USED TO MEET THE NEEDS OF THE RAPIDLY GROWING SCHOOLS. EACH OF THESE UNITS CAN BE SHIPPED IN ONE TRUCK AND ERECTED IN TWO DAYS WITH A HELPER OR IF NEEDED, THEY ARE A PLEASANT AND FUNCTIONAL ADDITION TO THE EXISTING SCHOOL THAT SERVES THE SWOLLEN WAR INDUSTRY COMMUNITY. THERE IS ALSO THE POSSIBILITY OF DISMANTLING OR RESELLING THESE UNITS WITH A MAXIMUM OF SALVAGE VALUE FOR A FUTURE REARRANGEMENT OF THE SCHOOL PLANS. THE POST WAR WILL BRING MORE DEVELOPMENTS ALONG THE SAME LINES WITH THE LARGE DEMAND ON SCHOOL BUILDINGS BECAUSE OF THE INCREASED ENROLLMENT AND THE EVENING CLASSES OF DIFFERENT TYPES OFFERED TO THE RETURNING ARMED FORCES.

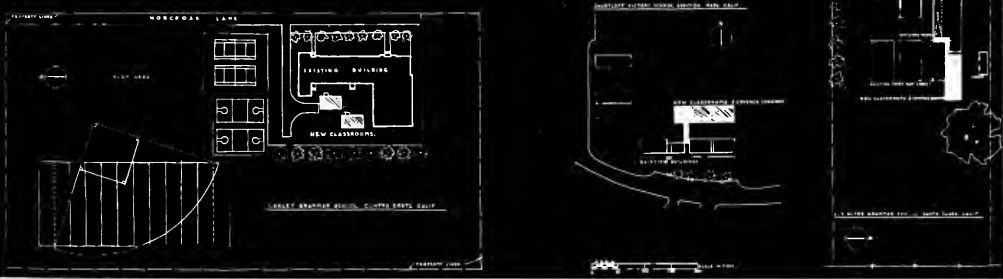
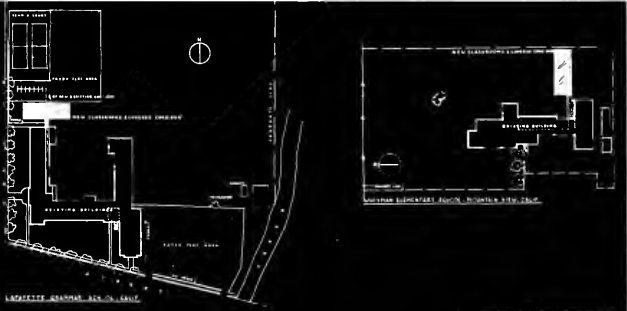

PLANS FOR FIVE OTHER SCHOOLS USING "PRE-BILT" FABRICATED UNITS

carpenter and laborer can apply the roof panels. Wall panels are screwed from the inside and roof panels on the outside. Each pre-finished panel is interchangeable with any other panel and is not structural. Doors and windows are separate units which are applied to the structural skeleton. A door unit can replace a panel or window unit, or vice versa. The standardization of the skin to the structural frame adds to the speed of erection. The possibilities of this light unit skeleton construction have not been exploited. When the floor, wall, roof panels, lighting fixtures and roofing have been erected the building is ready for use.

A one-unit classroom building for Pleasant Hills Elementary School District was erected and occupied by school children in five days. A classroom school unit may be built in one day minus the electrical system, composition flooring, roofing and unit heater.

The roofing of the buildings presented problems inasmuch as a one-unit classroom in a remote location raised the cost of roofers to come to the site. The cost for this procedure was out of proportion to the rest of the unit, so the use of a patent cold roofing was used and applied by one of the erection crew. The speed with which these buildings are erected does not mean that a large crew of men are used. A three-man crew can erect a building, but naturally not as speedily as a four-man crew.

The exterior appearance of the prefabricated school building has not been materially changed from other types of schools, but em-

phasis on the method and speed of erection lends itself to our present war conditions.

This type of construction, though light, is strong and durable. It is not expensive to maintain, while it fulfills requirements and, being easy to dismantle and of high salvage value, will not have to be retained when requirements change. One school district can sell or lease to another district when a building is needed or not needed.

The design of the "pre-bilt" school does not lack in any of the qualities of a well designed school. Bi-lateral light in each classroom gives constant and adequate light for every student. A naturally well lighted classroom will not produce contrast glare. Solar orientation of all classrooms produce an absolute guarantee of excellent light. In most locations the north orientation is best, but some locations and site conditions warrant different exposures. Proper orientation, combined with loose or open planning, gives the possibility of fluidity in the general design and lay-out, to suit ever changing demands. Manufactured construction is flexible and easily adapted to integrate into natural and existing environments. The light and rigid construction allows for individual expansion and simple alteration.

Manufactured construction is a necessary tool for everyone who designs and builds and wishes to do both better.

The work done in prefabricated and manufactured construction has only scratched the surface of its latent possibilities. The point is to design something better now and to continue on into the post-war period.

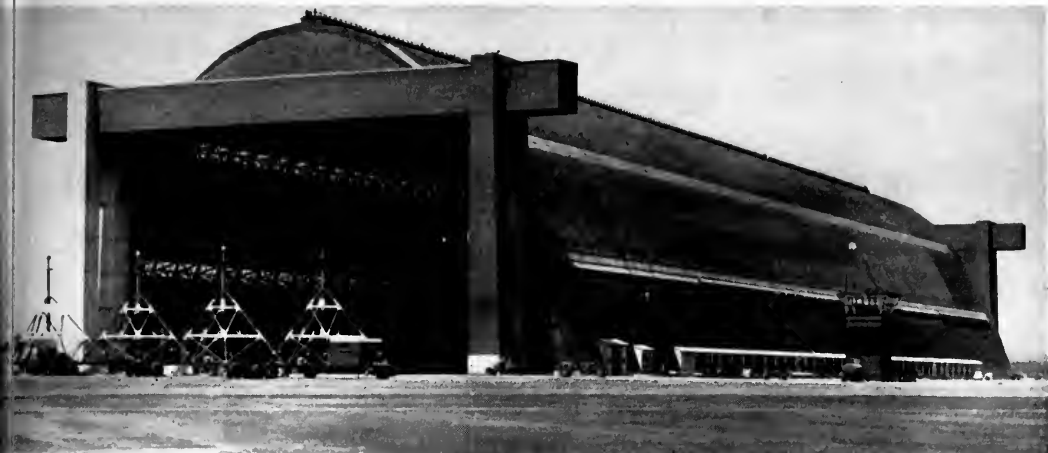

Wooden blimp hangar at the Naval Air Base, Santa Ana, California, is 171 feet high, and has a clear span across of 237 feet, largest ever erected.

NAVY BLIMP HANGAR AT SANTA ANA

(Publication approved by Eleventh Naval District, Area Public Relations Office.)

When structural steel became scarce a year ago, threatening to halt the Navy's lighter-than-air expansion program, the Navy's Bureau of Yards and Docks decided something had to be done.

At that time Nazi U-boats were ravaging the North and South Atlantic shipping lanes. Allied merchant ship sinkings were rising to alarming figures. Nothing, the Navy's top-ranking officers said, must halt even momentarily any phase of the anti-submarine campaign.

Navy engineers and draftsmen were given the problem. After two months of unceasing, painstaking work they could report they had won.

Concrete example of this American ingenuity is found at the U. S. Naval Air Station at Santa Ana, California, where two huge blimp hangars of a type never before attempted by engineers are nearing completion.

In these giant airship sheds will be housed the Navy blimps which patrol the Southern California sea lanes searching continually for enemy undersea raiders.

The largest clear span wooden buildings in the world, these hangars are 171 feet high—equivalent to a 17-story building; more than 1,000 feet long, and almost 300 feet wide at the base.

Between the bents or footings the clear span is 237 feet wide, sufficient room to quarter blimps in rows of two inside the structure with no danger of the fabric tearing on the sides of the hangar.

Behind the building of these great lighter-than-airship dromes is a typical story of determination.

Navy officials found two Pacific Northwest lumber companies that could prefabricate sufficient timber to build the hangars.

Before shipment, each beam was cut to the

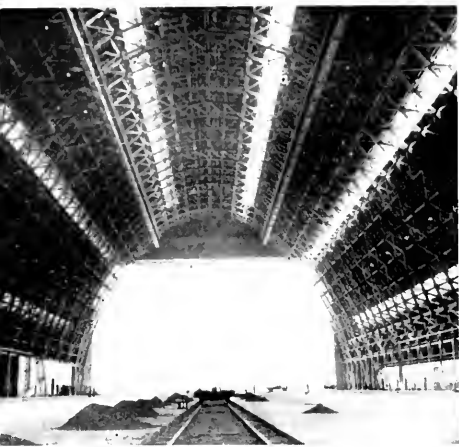

Official Navy photos

Left, looking down the car track of the Santa Ana Naval Air Station blimp hangar. Right, a near 90-degree skyward angle shot shows construction of a rib section of arched roof.



Left, folding doors at each end of hangar are supported by twin concrete pylons carrying an enormous built-up wooden "box beam." The doors fold up in recess between pylons.

Right, interior view of hangar, showing detail of timbered arch roof and scale of structure.

correct length, with the ends shaped at the exact angles, and holes drilled at the precise points for assembling bolts and fixtures. The timbers and sheathing, all treated with fire-resistant chemicals at the prefabricating plant, were transported to the Santa Ana lighter-than-air and other bases.

Assembling required no more than 60 days' time.

Captain H. N. Coulter, U. S. Navy, commander of air station at Santa Ana, said a feature of these wooden blimp hangars is their novel, folding leaf-like sectional doors which are suspended independently of the hangar. Huge twin reinforced concrete pylons on either side support an enormous square "box beam" girder, he explained, and the doors, which can be opened with the touch of an electric button, fold away accordion-like in the recesses between pylons.

The sliding sections are 120 feet high and are supported on railroad rails at top and bot-

tom. Navy engineers designed the huge built-up wood girder with a sag allowance of 1 inch, but actual tests have shown a sag of $\frac{7}{8}$ inch.

These doors, consisting of steel frames covered with plywood, relieve the hangar of supporting more than 200 tons of dead weight, and offer a minimum of wind resistance.

The two hangars, covered by two-inch thick wood plank sheathing, cost approximately \$2,000,000 each, or about one-third less than steel hangars of the same capacity.

The saving of \$8,000,000 at Santa Ana alone constitutes a feat of no small magnitude. It is equivalent to 426,666 war bonds of the \$18.75 denomination—and that, as they say, "ain't hay."

All structural lumber fabricated by the Henry Mill & Timber Company for these projects was fireproofed by a vacuum-pressure-inert salt method at plants of the American Lumber & Treating Company.



THE

PUBLIC

AND ITS

Jan Reiner will be remembered as author of a lecture on "Building Materials—the Grammar of Architecture," published in the *Architect and Engineer* for January, 1943. This month's contribution by Mr. Reiner presents some of the salient points emphasized by the young Czech designer in a talk before the Berkeley Women's City Club. Mr. Reiner has been identified with a number of important housing projects in the San Francisco Bay Area the past several years in addition to teaching at Mills College and the Schaeffer School in San Francisco.

In the main, an architect is concerned with three public groups. First, the people—or the clientele—who are chiefly interested in residential work. Second, governmental agencies and private corporations, interested in large-scale construction, and Third, the people who cannot afford the services of an architect, those living in the slums.

Group 1 is the group of which we generally think when we say "the Public." This is the public which goes to art museums, art lectures, which reads art books and art magazines. A group of people that may be enthusiastic about a modern home, traditional home, or a home. This group usually thinks in terms of an individual home, and not in terms of neighborhood or regional planning.

The governmental agencies and corporations comprising **Group 2** deal mostly with large-scale planning and construction such as administration buildings, schools, hospitals, airports, warehouses, factories, and so on. A great many factories built during the past century embody the principles of modern architecture. Their functional design, derived from simplicity and

economy of planning, demonstrates that "form follows function." On the other hand, the design of many governmental buildings is much too monumental; functional design is of less importance than the symbolic value of columns on the facade.

Groups 1 and 2 represent a "cash-and-carry" architecture, while **Group 3** represents a subsidized social architecture. However, Group 3 forms a considerable part of the population of many cities. The "style" of the slums is an "international style" accompanied by poverty, illness, and criminal records. The pre-war slum clearance projects and the present war housing projects are definite steps to raise morale and the standard of living. It is farsighted to build adequate housing projects now, rather than to build jails and maintain armies later.

I suspect that this audience is chiefly interested in individual homes: let me therefore turn toward this subject. How do we think of a home? Do we first think of its plan, or of its facade? The other day I came across a Hindu description of a house. The house is called "akasha" which means accommodation for living. The Hindus think primarily of a plan when they think of a house. Western people think primarily of a facade.

For instance, one person will say, "I want a Spanish house because it fits this climate and the California tradition." Another person will say, "No, I want an Early American house, because that is the American style." The third will say, "Let's build modern, I want a house



with big windows, plenty of light, a streamlined machine for living." Still another will say, "No, I don't want big windows, I want a cozy Old English cottage with a high roof." And so on.

Thus, the discussion of the house boils down to a collection of facades, and if we are analytical enough we discover that the question focuses actually on ONE facade—the front of the house. After this great discovery, let us see what difference we find in the actual plans of these homes.

Take three families of the same size living in the same neighborhood here in Berkeley, and you will find that their Spanish, French, and Old English houses have practically identical plans. Why, then, do people build in different styles? One reason is, of course, that they want individual-looking homes. But often the reason for these various styles is a clever speculative builder who sells them a facade instead of a home.

What is a facade—what is a style? The French architect Perret wrote that style is man himself. He meant the man of a particular geographical and social strata and of particular time. Thus, the man of Ancient Egypt built in different style from the man of the Middle Ages. To a large degree the style of a building is determined by the available building materials and current building methods. The building materials are the language of the architect, and the grammar of architecture of each civilization. In the January, 1943, issue of the *Architect & Engineer* I wrote on

this subject and because of limited space now, I have to refer the reader to that issue.

The use of contemporary building materials and building methods does not guarantee a good modern design. The design develops through elaborate research. As a conspicuous example let's take a lamp. Before a light fixture is designed, a great many studies of light distribution must be undertaken. Many people, especially the dealers in light fixtures, believe that a fixture looking like an 18th century chandelier is a beautiful fixture. It is perhaps the most expensive fixture, but I am certain it is the most unfunctional fixture. The round shape of an electric bulb made of glass is entirely different from the long shape of a candle, made of wax. Therefore, the electric bulb should not be shaped like a candle, and vice versa. The time may come when the source of light will be either hidden in the ceiling, or the ceiling and the walls themselves will be the source of evenly distributed light.

The other day, when I was sitting in the Top O' the Mark during a very heavy mist, it was impossible to see outside even though it was still daylight. I realized that the huge windows of this room in foggy weather look like the future luminous walls and ceilings of our homes.

But no matter how ingenious the house design may be, the majority of people cannot afford it because of the high cost. Perhaps the best way to produce a comfortable and inexpensive house is by standardized mass-production.

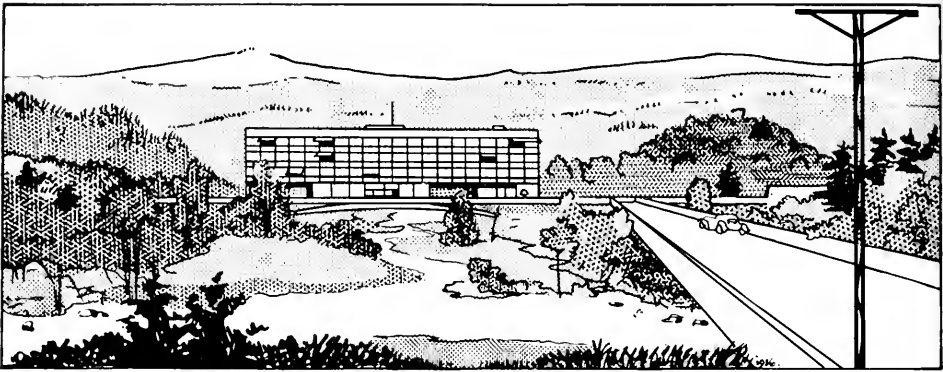

The idea was not to destroy the natural surroundings by paving, sidewalks, etc., therefore the hotel was built on a bridge over a creek. Part of the bridge roadway became the main floor accommodating the hotel lobbies, and the in-and-out door dining space, both overlooking valley and mountains.

If the last war created a popular car, this war should create a popular house. In the future some of the armament plants could be converted into production of houses and home appliances. We will undoubtedly have more mechanical gadgets in the kitchen, laundries, new heating and lighting equipment, and so on. There will be various models of houses just as there are now various models of automobiles. There will be the demountable house, the package house, the plastic house, the light metal house, and so on. The change will not be so much a matter of appearance as it will be a matter of price, which will be much lower—

and that will be the most modern thing about the modern house.

It should be possible to transport sections of pre-fabricated houses into locations thousands of miles distant and assemble them into well-planned communities. A decentralized community will then become a true creation and expression of the 20th century. Socialized housing, developed for large areas, will surpass the competitive real estate speculation now operating in small areas. A decentralized city could ease up the crowded cities and much improve the living conditions of people, who, up to now, were unable to secure the services of an architect.

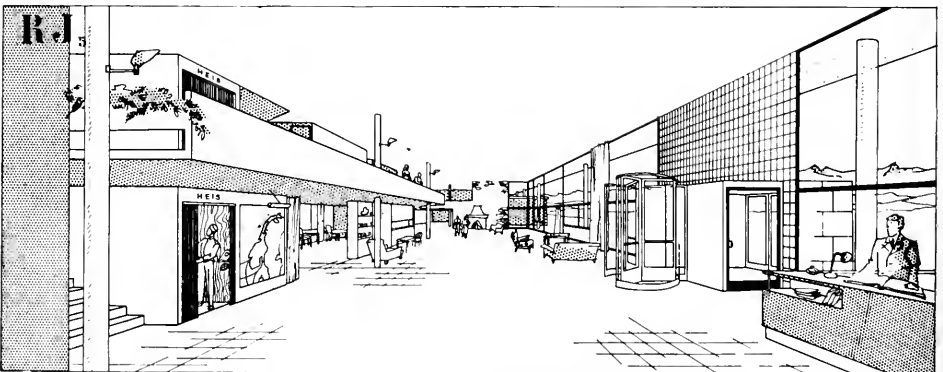

The lobby of this high mountain tourist hotel for Norway, sketched by Mr. Reiner, reveals a two-story scheme in which the social and sport life takes place. As in other Scandinavian buildings, one observes here the use of modern building materials and functional design.

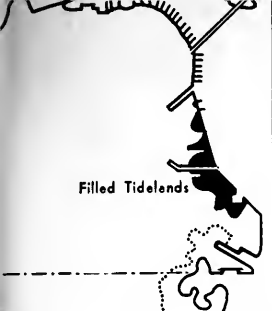

560 ACRES OF NEW INDUSTRIAL AREA

The level shoreline area between Hunters Point and the Embarcadero constitutes a logically established industrial district. Five hundred and sixty acres of valuable new land can be created by filling the tidelands.

CONTROL OF EROSION AND ACCRETION

Land slippage injures scenic drives and walks in Lincoln Park; erosion and sand accretion on the Great Highway are costly. Scientific surveys are needed as a basis for economical corrective measures.

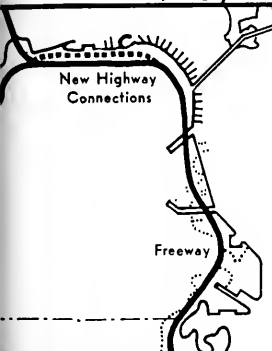
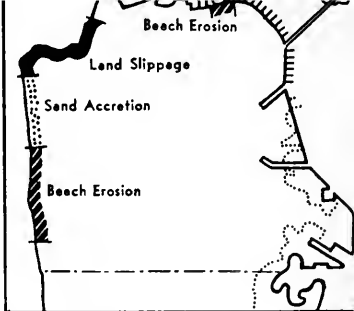

A 23-MILE CONTINUOUS SHORE DRIVE

Protection and improvement of the Great Highway along the ocean; new roadway connections along the Golden Gate, and a new Freeway on the Bay Shore are proposed to complete a useful traffic artery and notable scenic highway around San Francisco.

REHABILITATION OF FERRY BUILDING AREA

Remodeling of the Ferry Building, land clearance and street revision will provide a Water Gate to the City; a street car and bus terminal; a tourist-commercial center, with shops, exhibits, recreation facilities, offices, and docks for sight-seeing and fishing trips.

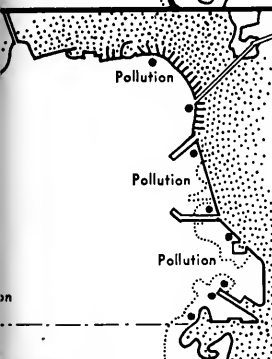
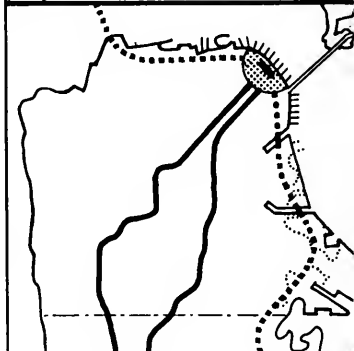

ELIMINATION OF SHORELINE POLLUTION

San Francisco and neighboring cities are polluting the Bay, creating a health hazard and preventing full use of shoreline properties. Nearly 46,000,000 gallons of untreated sewage are discharged daily by this City, spoiling its own beaches and yacht basins. A complete system of sewage treatment plants is proposed as a post-war project.

NEW RECREATIONAL FACILITIES

New beaches, shore parks and picnic areas; walks, bicycle paths, observation points; improved parking lots, and more accessible and attractive tourist facilities can be created along the shore. Land is generally available; a comprehensive plan for its ultimate development is now provided.

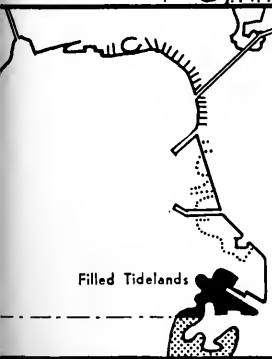
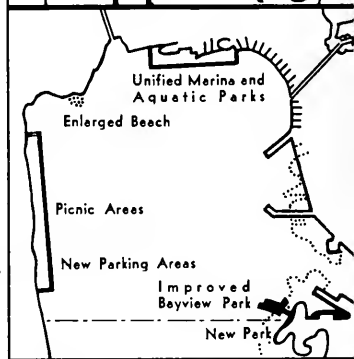

380 ACRES OF NEW RESIDENTIAL LAND

Filling of shallow tideland areas near Candlestick Point will provide new land for a well-planned residential district on the Bay. Small homes here would be within walking distance of the Navy Yard and other places of employment, and close to the protected waters and sunny recreation areas on the Bay Shore.

NEW HARBORS FOR SMALL BOATS

The Marine Yacht Harbor would be doubled in capacity, Aquatic Park developed for boats, and the Ferry Building transformed as a pleasure craft landing. Facilities for boat building, rowing, and small sailboats would be located near the new Hunters Point residential areas.

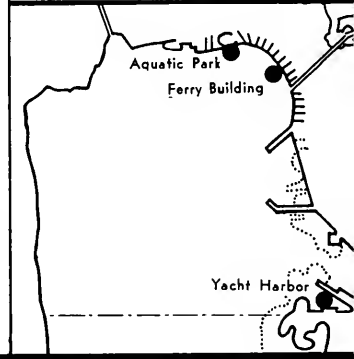

BASIC PROPOSALS OF SAN FRANCISCO'S SHORE LINE PLAN

A summary of the City Planning Commission's preliminary report, recently revised, will be published in this magazine next month.

TO AVOID POST-WAR SLUMP

The U. S. Department of Commerce has recently prepared a handbook for the guidance of small cities in their post-war planning. It is titled, "Community Action for Post-War Jobs and Profits." Secretary of Commerce Jesse Jones hopes to get organizations in 2,000 cities set up by the end of the year.

Although the booklet makes many suggestions for strengthening business now, its main theme is post-war planning. It suggests that local Chambers of Commerce and other business organizations start at once to do some or all of the following:

- Establish a "work pile plan" by collecting and cataloging figures on what each local business firm plans to spend after the war on repair, modernization, expansion or conversion—and on their probable post-war personnel needs.
- Contact both local and nearby firms and make preliminary arrangements to ease and speed the placement of workers who will need new jobs.
- Urge companies, through local newspaper and radio advertising, to build up their capital reserves by curtailing their present expenditures.

PORTLAND HAS PLAN

Robert Moses, commissioner of the Department of Parks of New York City, has been engaged at a \$100,000 fee to plan a post-war construction and development program for the Portland, Ore., area. Drafting of the program, a 60-day undertaking, began Sept. 1. Of the \$100,000 fee to Moses, \$14,000 will go to his staff, \$80,000 to eastern engineering firms and \$6,000 to a firm of New York attorneys. Mr. Moses will consider development of an arterial highway system through the Portland district; unification and modernization of rail terminals, truck, bus and air transport facilities; and improvement of port and dock facilities, including turning basins, drydocks, repair and wharfrage accommodations.

ACTUALLY

Planning

POST-WAR WORK?

by ARNOLD A. WEITZMAN, A.I.A.

In the columns of all architectural and engineering magazines discussions are carried on about post-war work, in one form or another. A few architectural firms actually have work on the boards, either by order of some client or on their own initiative and cost. But in point of volume, if measured on a national scale, this work is insignificantly small. Besides, these so-called "programs" are general and undefined. We still do not know who will actually do what, where and how much of it. What instrument and method of financing a **national program**? And a national program it must be; or it is not even worth talking about. It is a very elementary fact that unless these factors have been definitely established we are all talking generalities and groping in the dark. We are not planning, because the proper steps have not been taken by national agencies, which must be done before we can do actual and fruitful work in preparing a "painless" transition from war economy to permanent peace prosperity for the nation. Until such time we are only toying with a cherished ideal of planning; planning everything we can think of as architects or engineers.

Planning of course is our very nature, and there is no doubt that co-ordinating and planning post-war work on a national scale and immediately, is very necessary for the well being of this nation. It is the only sure and sound method by which to avoid economic disaster after the war is over. The architect must, out of patriotic and humane impulses,

lend strong and vehement emphasis to his advice for **definite** national planning immediately, because he is the one who can logically prepare and put such a program into operation. Certainly now, more than ever, it must be made known that the architect is not an abstract dreamer, contrary to the idea which the general public has, in utter error, formed about him. If the architect of yore liked the halo of a poetic picturesque artist attached to him, the architect of today repudiates and resents such an idea about him. He wants his public to know him the way he really is; and he is not a mere dreamer, but a scientific, creative realist with esthetic taste, a master builder. The architect is zealous in his profession and is always eager to reflect these attributes on the community in which he lives.

This truth about the architect must now diligently be carried to the public. The architect must now introduce himself, because there is at present a tremendous job to be accomplished all over the world which he alone can do, by his training and by his method of scientific planning; **not scheming**. There is, however, certain and great danger lest the public continues to confuse planning with scheming, and by his passive attitude the architect helps misconception about the real nature of his work to continue.

Scheming is done by individuals and groups of selfish interest, who take advantage of opportunities, no matter how calamitous, for furthering their own gains. The public may coincidentally and temporarily derive benefits from such schemes; but the main objective of such enterprise is "self-service"; whereas planning, as the enlightened architects now recommend, is that the interest of the community shall be of prime importance. Justified profits will surely result to investors from **constructive enterprises**; not from gambling. Such selfish interest that stems from public interest would be of the **enlightened** kind, and stimulating permanent and severe economic growth.

The Octagon of May, 1943, appeals very timely for such an attitude when it writes: "The enlightened selfish interest of groups shall be coordinated and **action taken** must be based on the principle, that the well being of the people as a nation will be reflected in advantage to the various groups." The same article sounds the emphatic warning that "the time to set about planning for post-war reconstruction is **now!**"

Events are moving swiftly and we have nothing, actually, planned to meet this acute situation which we are certain to face at home. There is so much talk about Johnny's coming home but, excepting a promise that Johnny will have a few months salary after peace or general armistice is declared, we fail to hear of any concrete plan how millions of them will obtain steady employment in order to build on it their future life! We also hear that Johnny will get his job back. How? At the expense of John, his father, and Bill, his uncle? Is this a solution to a problem that, if overlooked, it may rob us of all the advantages that we hoped to gain by winning this war at such enormous sacrifices? Certainly not! Our present economic structure would prove itself bankrupt and naughty, and it would totter to the ground if we would have to deprive the millions of men who stayed home of their bread in order to give it to the demobilized soldiers. Yet such a fruitless and pernicious procedure **will have** to be followed if definite planning on an organized national scale is not diligently started immediately. In such a planning the architect, the engineer, and the economist, supported by an informed public, must lead; not **enlightened**, selfish, scheming interests!

We are happy in our firm conviction that our national will and our economic system, both are sound. Tremendous opportunities are there for development and building, more than enough to keep this nation economically sound and to maintain a stable prosperity, if the right man is given the right job. The American people of this time should understand to keep the schemers out and call on the architect and the engineer for **actual planning**.

POSSIBLE AFTER-WAR DANGERS IN CALIFORNIA

Discussing the immediate need of post-war plans and programs by both industry and government, the California Housing and Planning Association, through the medium of its publication, *Agenda*, says:

"To expedite immediate post-war reemployment and to help distribute and sustain employment will require programs not only for conversion of manufacturing industries but also to aid reemployment in agriculture, mining, trade and services, private construction and public works, and to sustain public confidence in post-war recovery. Neither complete economic planning with regimentation of all productive enterprise, nor complete absence of advance planning by both private industry and governmental agencies can be relied upon to bring about readjustments satisfactory to the American people.

"One of the dangers facing the Pacific Southwest and the Nation after the war will be the widespread desire to return to a peacetime economy overnight—a belief that the difficult problems of readjustment can be whisked away merely by the sudden dispersal of all wartime organization and controls. To apportion equitably the limited supplies of raw materials among manufacturers and of goods among consumers, to shift war workers from armament plants, aircraft factories, and shipyards and retrain them gradually for new jobs as peacetime activities are resumed; and to prevent prices from soaring as they did in 1920, with subsequent collapse as in 1921, it will be necessary to relax controls judiciously. The timing of decisions to abandon war production in this or that plant, to muster out this or that group of soldiers, to remove priorities on certain raw materials and finished goods will be all-important.

"Another danger facing the Region and the Nation would be the refusal to accept new opportunities and to attempt to return to a more primitive economy. If the war is prolonged to the point of economic and psychological exhaustion, there may arise a cry of 'back to the land—a farm and sub-

THE POST-WAR EMPLOYMENT PROBLEM

The country is faced with the emergency problem of employment during the post-war period for: (a) men in uniform at the war's end, (b) government employees in excess of peace-time requirements, (c) employees of government-owned and privately-operated plants producing war material, (d) employees of privately-owned plants now producing war material, that can be reconverted to peace-time production (anticipating that during reconversion there may be an extended period of unemployment). To meet these emergency needs for post-war employment and to build more permanently for the general welfare, there are many possible solutions, among which are the following:

1) Encourage the development of private enterprise by every means consistent with the general good, including review of controls and fiscal policies applied as war-time measures.

2) Encourage all units of industry, large and small, to plan now for their type and scope of operation after the war. Many producers of war goods will return to their former production for civilian needs; others must convert to new lines and new products. Upon the thoroughness of industrial planning now, post-war employment and productivity will depend, especially in view of the prodigious character of post-war expansion required to equal war production.

3) Encourage the complete readiness for use, by private enterprise and by all levels of government, of a true "shelf" of post-war construction projects for which there are authorizations, surveys, plans and specifications, with financing provided:

(a) Let there be special provision for a repair, maintenance, replacement and new work program that emphasizes jobs long deferred by war, and that can be set in motion with the least loss of time at war's end, to tide over employment for the period in which large projects are gotten under way. By thorough advance planning provide work in reference to public need, avoiding "made" work that might otherwise be hastily improvised and uneconomically executed without attaining maximum public service.

(b) Let long range construction planning for continuing programs and large projects be with reference to public need and employment and be reconciled with construction potentialities, the national economy in general, and the wartime backlog of demand for many consumer goods. Consider the overall construction program with a view to maximum employment consistent with construction needs and a balanced economy. With an assumed national income of \$110 billion, \$14 billion might be spent for construction, of which four or five billion might be for public works. If construction, other than that for war, continues at war's end at \$1.5 billion, large possibilities for employment will depend upon the acceleration of the construction program. If this program attains an annual acceleration of \$3.8 billion (the war-time peak) an annual construction total of \$14 billion would be attained only by the fourth year. In this is further emphasis of the need that a so-called "shelf" of construction projects consist not in projects merely "proposed" but in those advanced to the point of getting under way at once when men return from the military and industrial war-fronts. Assuming that \$5,000 for construction hires one man

on-site and 1.5 men off-site in shops, mines, transportation, and so forth, for one year, \$14 billion would employ 2.8 million men on-site and 4.2 million off-site, 7 million in all of which 2.5 million might be on public works. Although not eliminating unemployment, such a program would be a substantial contribution from the construction industry toward that end.*

4) Consider employment possibilities in dismantling surplus military installations.

5) Plan and schedule demobilization of the armed forces so far as practicable, to return men to civil pursuits as and where employment becomes available—some regions being ready sooner than others, some skills more in demand than others. Such scheduled demobilization might be made feasible by a reversal of the war training program, refitting men in uniform for return to peacetime occupations. The great military training stations and the established educational institutions, both of which play such important parts in special training for war, might be used for post-war courses in the manual arts, academic subjects, languages, history and so forth, including political economy and the duties and responsibilities of citizens—often less well understood and practiced than the citizen's civil rights.

6) Consider universal military service first for national safety and also in reference to employment problems. One year of such service for boys will not solve the problem of unemployment but will remove some employment competition.

7) Study opportunities for greater coordination of agriculture with industrial and chemical uses of farm products.

8) Apply a lesson of this war in measures to maintain adequate stockpiles of selected raw materials.

9) Seek a solution of continuing problems of social security as related to unemployment and old age benefits.

10) Continue the study of conservation measures for agricultural and forest lands.

11) Encourage the preparation of master plans for cities, and for metropolitan and regional areas by which a more logical arrangement of their development may be laid down, including provisions for adequate housing, streets, parks, facilities, playgrounds, and means of transportation and for the elimination of slums and blighted areas.

12) Effect international agreements for the elimination of financial and legal obstructions to trade between nations.

13) Encourage that expansion of private enterprise necessary for full employment by measures to make the natural resources of the country more easily available. Give thorough study to the best plans not only for conserving natural resources but for their utilization for the public good.

14) Consider the revision of laws and regulations for the greater freedom of commerce between states of the United States, including the most efficient use of all transportation facilities.

UNEMPLOYMENT SITUATION MAY BE SERIOUS

sistence for every family! Such a movement would defeat efforts to conserve and develop natural resources on a selective basis. In some sections the war is removing workers from land that might better never have been put under cultivation, thereby alleviating farm problems. In others the war-induced migration has drained workers from land which could provide them a good living after the war. Post-war programs for agriculture should seek to point out opportunities in these areas of proved fertility and to prevent recurrence of pre-war problems in poorer farming districts.

"This word of caution against indiscriminate farm settlement does not mean that no new agricultural land should be developed in the Pacific Southwest. It does mean, however, that future land reclamation projects should be thoroughly studied before their authorization, to determine whether there will be prospective markets for the crops to be grown, whether the settlers can probably make a satisfactory living on the land, and whether more crop land in the area is actually needed. Population growth in the Region alone may justify some increase in the farm acreage.

"Because of California's huge numerical increase in population and labor force, the great bulk of unemployed in the Pacific Southwest under both favorable and adverse conditions will be in this State. Under adverse conditions, more than a million persons might be unemployed in California during the transition period. But under favorable conditions (which might be achieved through cooperative planning and timing of post-war redevelopment), total unemployment might be about half this figure, or only one-fourth larger than in April, 1940, and the ratio of unemployed to total population would be about the same as that date. However, the unemployed will be more largely concentrated in the major industrial areas of Los Angeles, San Francisco Bay, and San Diego than were the State's unemployed in 1940."

* For the figures in (3) reference is made to public releases of the National Resources Planning Board. General outline is taken from the Journal of the American Concrete Institute.

REGIONAL CONFERENCE HELD AT LOS ANGELES

New problems that enlarging forces of the Pacific war are bringing to the West Coast and their carryover into the post-war period, were discussed by speakers at the semi-annual board of governors' dinner and regional conference of the California Housing and Planning Association at the New Rosslyn Hotel in Los Angeles, October 29.

Robert W. Kenny, state attorney general and president of the C.H. P.A., one of the principal speakers, pointed out that California's war industries have brought 650,000 persons into the state in the past three years. A little more than half of them live in newly constructed dwellings, mostly in public housing projects. The rest found places for themselves in existing dwellings, converted buildings and trailers.

"This migration has occupied practically all the available housing," Kenny declared, "and government agencies estimate that 1944 will bring an additional quarter of a million people into the state. How to provide living facilities, housing, food, schooling and health protection for those who are coming is the biggest question in California today. As the Pacific offensive speeds up, war production must keep pace and the matter of providing adequate manpower and keeping it on the job is of paramount importance."

Langdon W. Post, regional director of the Federal Public Housing Authority, San Francisco, and E. S. McKittrick, building vice-president of the Associated Contractors of Southern California, talked on housing and planning from the respective viewpoints of public administration and private construction.

Dr. Harry Girvetz, Santa Barbara State College, discussed the political aspect of State and Federal social programs in the immediate post-war period.

Other speakers included Gordon Whitnall, member, board of governors, Los Angeles Town Hall; Charles B. Bennett, Los Angeles City Planning director; Maurice Saeta, vice-chairman, Los Angeles City Housing Authority; Walter E. Packard, Central

Valley Research Committee; C. J. Haggerty, State president, A. F. of L., and Oscar Fuss, legislative representative, C. I. O.

REPLACES CALIFORNIA PLANNING BOARD

The California Reconstruction and Re-employment Commission, which replaces the State Planning Board, abolished, has been functioning less than two months with gratifying success. The new agency has broad powers "to prevent unemployment, conserve and develop the natural, social and economic resources of the State, promote development of new industries, create new markets, promote the re-employment of discharged service men and readjustment of displaced war workers, and the conversion of industry and commerce from a war to peace standards, to provide for post-war readjustment and reconstruction, and to encourage economic and social improvement of the general public."

The bill creating the commission also includes specific instructions to plan and promote improvement and expansion of highways and freeway systems, and the reconstruction and expansion of State buildings, hospitals, and institutions.

Charles H. Purcell, Director of Public Works, is chairman of the Commission with Finance Director J. F. Hassler serving as vice-chairman. Other members of the Commission are the directors of the departments of natural resources, agriculture, industrial relations, and professional and vocational standards, the president of the University of California, the superintendent of public instruction, and the executive secretary of the Governor.

Each member of the Commission will act as chairman of a citizen advisory committee of five experts to be nominated by him for appointment by Governor Warren.

V. B. Stanbery, formerly regional counselor in the Berkeley field office of the National Resources Planning Board, has been employed as chief of the Commission's technical staff.

CALIFORNIA STATEWIDE POST-WAR EMPLOYMENT

The California State Chamber of Commerce has appointed a statewide Committee on Post-War Economics to stimulate and assist private industries in California in making long-range plans for maximum employment and production in the post-war period.

Chairman of the committee is Asa V. Call, president of the Pacific Mutual Life Insurance Co., Los Angeles. Serving with him are 22 leaders in shipbuilding, aircraft, transportation, finance, agriculture, oil, retail trade, steel, and utilities.

A sub-committee has been appointed to draft proposals of public policy favorable to expansion, investment of venture capital, and maximum production and employment by private enterprise in the post-war period.

WORK PILE PLAN HAS GOOD START IN SAN FRANCISCO

Returns from the San Francisco "work pile plan" are highly gratifying. Eighteen industrial groups and 388 individual companies have indicated a post-war expenditure of more than \$64,000,000.

The city's ten leading banks expect to spend more than \$2,000,000, starting as soon as possible after the war ends. Individual predictions range from a few thousand dollars to the American Trust Company's \$1,000,000. The money will go variously for new construction, new equipment, repairs and remodeling.

The Municipal Railways are laying aside more than \$1,600,000 for new rolling stock, new construction and replacement of rails. Hotels, as reported by the Hotel Employers' Association, plan to spend more than \$116,000 for repairs, a similar amount for new fixtures. Chain stores, automobile dealers, oil companies and various other groups indicate that although their estimates are not yet complete the total amount will run into the millions.

Figures for job openings indicate that nearly every group reporting expects to have room for many ex-service men and war workers.

TODAY'S CLUES FOR POSTWAR FLUSH VALVES

★ While no one can lay down any very definite blueprints for the plumbing that will be found in postwar buildings, some valuable clues as to trends can be discovered in buildings completed within the last year or two.

Take hospitals, for example. Several outstanding institutions have been put into service during this period. The Jefferson Hospital at Birmingham — already recognized as one of the South's finest — is one of these.

Every piece of equipment that went into the Jefferson Hospital was selected with careful forethought to the comfort and well-being of the patients to be served. Noise reduction, for example, has been aided by the selection of Watrous *Silent-Action* Flush Valves.

In this detail there is a definite clue on postwar trends . . . the flush valves to be installed in most buildings of tomorrow will be smoothly functioning water control instruments which operate *silently* — without any of the telltale noise that once was associated with flush valves.

In fact, if we are to judge by the Jefferson Hospital's selection of Watrous *Silent-Action* Flush Valves, more and more careful attention will be given to—

- (a) the degree of noise elimination provided by a flush valve — and the PERMANENCY of the noise elimination.
- (b) the ability of the valve to be adjusted for maximum water savings.
- (c) the valve's simplicity and economy of maintenance.

Plans for Watrous Flush Valves for the buildings of tomorrow are already under way. You may be sure these valves will match fully the many other developments in building construction which are to come.

THE IMPERIAL BRASS MFG. CO.

1237 West Harrison Street, Chicago 7, Illinois

Data for wartime projects and postwar applications.

Sweet's Catalog File—Section 27, Catalog No. 39—covers both "V" model Watrous Flush Valves for essential wartime applications and the complete line of models and combinations for postwar planning . . . Or write for Bulletin 858-W and Catalog 448.



The Jefferson Hospital, Birmingham, Alabama
Charles M. McCauley, Architect
The Pate Co., Plumbing Contractors



● There are two of these utility rooms on each floor with service sinks equipped with Watrous *Silent-Action* Flush Valves. Watrous *Silent-Action* Flush Valves are also installed on fixtures in all bathrooms and washrooms.

Watrous Flush Valves



SOUTHERN CALIFORNIA CHAPTER MEETING FOR OCTOBER

CONCRETE, WOOD, PLASTICS

One hundred and six members, associates and guests attended the October meeting of Southern California Chapter at the Hotel Clark, Los Angeles.

James Byers, president of the Structural Engineers Association of Southern California, was called upon to tell of advancements, if any, made in reinforced concrete construction, in recent months.

"No vast changes have occurred in reinforced concrete construction, but, evolutionary processes have been accelerated by the war," according to Samuel Hobbs of the Portland Cement Association. "New techniques in design practice have been speeded up, others have been shelved for the duration."

Excessive cracks in tank construction have been avoided by ring tension produced prior to load by the Hewitt Process. Pre-stressed concrete piles of great density within a few hours have been produced by the use of steam and special cement at Fresone, France.

The fusion of cement and aggregates around reinforcing steel by electrical heating and then cooling after initial hardening of concrete is another innovation, described by Mr. Hobbs.

Asserting that wood is the strongest building material in comparison with its weight, Charles Mackintosh berated architects and engineers for wasting wood. Selected pieces having a low moisture content possess amazing strength—comparable to working values for steel, the speaker said. In a blackboard talk Mr. Mackintosh pointed out that eccentric loading on one face only of a wood diagonal member of a truss reduced its strength 75 per cent.

The new flying box-cars with a wing spread equal to the length of a football field are of plywood, as are also a number of the recent fighter plane types.

Mr. Delmonte gave an expert's review of plastics made from wood (lignin), asphalt, soybeans, corn, milk, and of the thermo, nylon and silicon plastics. Tensile strengths up to 100,000 pounds per square inch, it was said, have been achieved in certain plastics. Their architectural uses will be largely as moisture barriers for wood, canvas, paper and other materials and as extruded or cast moldings and in many places where metal or wood have heretofore been employed. (See article on "Plastics for the Architect" in Architect and Engineer for October.)

The following excellent board of officers has been nominated to represent the Southern Chapter in 1944:

For president—Herbert J. Powell.
For vice-president—Chas. O. Matcham.
For secretary—Paul R. Hunter.
For treasurer—Robert V. Derrah.
For director (1 year)—Theo. Criley, Jr.
For director (3 years)—Welfton D. Becket.

S. F. STRUCTURAL ENGINEERS

Members of the Structural Engineers Association of Northern California resumed their meetings at the Engineers Club, San Francisco, November 2. Preceded by dinner, the gathering was addressed by Harry E. Kennedy on "Welding Techniques and Welding Problems." Mr. Kennedy is the inventor of what is now called the unionmelt process and his talk embraced personal experiences in connection with the development of welding techniques and applications. Mr. Kennedy is an inventor of enviable reputation as well as an engineer who delights in "trouble-shooting."

* * *

Ellison and King announce the removal of their offices to 500 Sansome Street, Suite 715, San Francisco 11, telephone EXbrook 6698. William Ellison says the Barrett & Hilp concrete barges are progressing nicely, with eight in the water to date.

* * *

The following members of the Structural Engineers Association of San Francisco attended the convention of the P.C.B. Officials Conference in San Francisco October 5 and 6: E. S. Banta, R. D. Dalton, T. P. Dresser, M. S. Farwell, F. F. Hall, A. C. Horner, John Little, A. E. Lilly, C. A. Lindgren, J. E. Mackie, W. T. Norris, W. H. Popert, M. C. Poulsen, C. E. Seage, J. B. Wells, C. A. Whitton, D. C. Willett, also Martin Falk, and proposed member R. D. Rader.

John J. Gould has been rendering service on timber structures for a large company in Tacoma, Wash., requiring frequent trips north.

* * *

Kaj Theill recently completed the design of two jobs for the U. S. Navy, one in Berkeley and the other in Pittsburgh, which have since been completely constructed.

* * *

Theo. P. Dresser, S. S. Gorman, and Franklin P. Ulrich have been nominated for the office of vice-president of the San Francisco Section, American Society of Civil Engineers, to be voted on at the December meeting.

PERSONAL MENTION

E. B. McClure has become associated with the Soule Steel Company, and for the present he will be located at the company's home office in San Francisco. Soule Co. also maintains offices in Los Angeles and Portland.

Charles S. Strothoff, architect and engineer, has been named executive director of the Richmond Housing Authority to succeed Harry Barbour, resigned.

THE STATE ASSOCIATION OF CALIFORNIA ARCHITECTS

Northern Section

EDITOR

William C. Ambrose

Address all communications for publication in this department to W. C. Ambrose, 369 Pine Street, San Francisco.

Office of Northern Section
STATE ASSOCIATION OF CALIFORNIA
ARCHITECTS

369 Pine Street, San Francisco

Officers for 1943

President.....Walter R. Hagedohm, Los Angeles
Vice-Pres.....Norman K. Blanchard, San Francisco
Secretary.....Hervey Parke Clark, San Francisco
Treasurer.....George E. Gable, Los Angeles

Southern Section Officers

President.....Walter R. Hagedohm, Los Angeles
Vice-President.....E. Allan Sheet, Los Angeles
Secretary.....Rowland H. Crawford, Beverly Hills
Treasurer.....George E. Gable, Los Angeles

Northern Section Officers and Directors

President.....Norman K. Blanchard, San Francisco
Vice-President.....Russell G. deLappe, San Francisco
Secretary.....Hervey Parke Clark, San Francisco
Treasurer.....David H. Horn, Berkeley
Directors: John S. Bolles, Ross; Andrew T. Hass, San Francisco; H. H. Gutterston, Berkeley; Vincent G. Ranev, San Francisco; Frederick H. Reimers, San Francisco; Malcolm D. Reynolds, Oakland; J. Francis Ward, San Francisco, and Alfred C. Williams, San Francisco.

Northern Section Advisory Council

San Francisco District No. 1, J. Francis Ward; East Bay District No. 2 Irwin M. Johnson; Berkeley District No. 3, John K. Ballantine, Jr.; North Bay District No. 3, C. A. Caulkins; Marin District No. 5, John S. Bolles; Lower San Joaquin District No. 6, Frank V. Mayo; Upper San Joaquin District No. 7, Philip S. Buckingham; Santa Clara District No. 8, Ralph Wyckoff; Palo Alto District No. 9, Elizabeth Boyter; San Mateo District No. 10, Leo J. Sharps; Sacramento District No. 11, Harry J. Devine; Upper Sacramento District No. 12, Fred J. deLongchamps; Lassen District No. 13, Ralph D. Taylor; Monterey District No. 14, Charles E. Butner, and Redwood Empire District No. 15, Franklin T. Georgeson.

Northern Section Standing Committees

Legislative Committee.....Vincent G. Ranev
Public Relations Committee.....J. Francis Ward
Building Industry Committee.....Hervey Parke Clark
Convention Program Committee.....Edgar Bissantz
Post-War Reconstruction Com.....J. Francis Ward
Membership Committee.....John S. Bolles
Building Industry Directory.....Russell G. deLappe
Policy Committee.....Russell G. deLappe

SIXTEENTH ANNUAL CONVENTION

Election of 1944 officers at the convention of the State Association of California Architects, held in Los Angeles on October 14, 15 and 16, 1943, resulted as follows:

President—John S. Bolles, Northern Section (see page 8)
Vice-President—Robert H. Orr, Southern Section
Second Vice-Presidents—Russell G. de Lappe and Vincent Palmer
Secretary—Adrian Wilson, Southern Section
Assistant Secretary—Malcolm D. Reynolds, Northern Section
Treasurer—Ralph Wyckoff, Northern Section
Assistant Treasurer—George E. Gable, Southern Section

The Lights Are On

By the time this magazine reaches the mailing room the lights will have been on all over the United States for some time. Of course we know the war is not yet over, but there are undoubtedly many plans being made now to slam the bureau door (this is not a mis-print) when the war does end and to set up shop again as private practitioners in the noble art of architecture.

Lest we forget, it might be well to highly resolve that this time, when we have an office, we are going to charge fees for our work sufficiently large so that when the first slackening of work comes along, as it inevitably will, we won't have to dig into that savings deposit that the Government and our patriotism has made us set aside from war-time earnings. The temptation of a new fur coat for the missus may be strong in our heart when we get a check for two months work which is as large as any three months' pay even in the inflated war wages. But, in the words of the song, "Sailor, beware!"

For there is a rack ahead in the course of every architect steering a path in private business. It is slightly submerged at the highest tides in our fortunes, and it causes the foundering of many a practice. Someone had another simile or metaphor in mind when he named it "Overhead," and maybe that name is more descriptive, for it hangs over the door of every office and the link by which it is suspended is very fusible.

So, remember these facts when you start to count up expenses and stop counting after rent, telephone, office supplies and petty cash.

If you have worked at full speed for ten of the twelve months of a year and have worked on the books and done mostly filing for the other two months, you have made 16 2/3 per cent less profit on the job than your books showed when you finished that job.

If you do not have any more to show for your labor at the end of the year than when you were working for some one else, you have been assuming the risks of an employer and getting paid at the rate of an employee. You don't begin to make a profit on a job until after you have paid a wage to everyone who has worked on the job, including yourself. A holiday for an employee is a holiday. For an employer, even though the employer is hiring only himself, a holiday is an item of overhead—the expenses go on; but the benefits from the holiday do not pay any grocery bills.

Two weeks off for the draftsman means four per cent more cost than the books show against every job upon which he has worked during the year.

"Kid stuff!" is the reaction of many men when these items and a dozen other items of "overhead" which anyone can think up with a little effort are called to their attention. But the cycle of job—office of own—office in house—and job again goes on time after time. Part of the cycle is inevitable. But much of it might be cured by replacing a degree of optimism and realism, by knowing your costs and charging accordingly.

Remember that if you are not getting about twice as much for a job as the amount of the drafting costs, including your own time, you haven't begun to make any profit, and you may be on your way out of business.

Errata

Our face is red, and our apologies are humble. Somewhere in this Editor's office a line was skipped last month in joining the office to the office-holder, with the result that in the list of Northern Section officers elected at the Pre-Convention Meeting in San Francisco, the Secretary was listed as Vice-President and the Vice-President was omitted entirely. The list of officers and directors for the Northern Section should read:

President, John S. Bolles; Vice-President, Russell G. de Lappe; Secretary, Malcolm D. Reynolds; Treasurer, Ralph Wyckoff. Board of Directors—Norman K. Blanchard, for 2 years; Philip S. Buckingham, for 2 years; Henry H. Gutterson, Regional Director, A.I.A.; Andrew T. Hass, No. Calif. Chapter, A.I.A.; Vincent G. Raney, 1 more year; Frederick H. Reimers, State Board Architectural Examiners; Peter L. Sala, Central Valleys Chapter, A.I.A.; Alfred C. Williams, 1 more year.

Quo Vadis

Of interest to all architects in California, and particularly to architects in the San Francisco Bay Area, were the facts recited by Mr. R. M. Dorton, Area Representative of the Executive Office of the President on the Committee for Congested Production Areas, before the Building Industry Conference Board in San Francisco on October 13, 1943.

Mr. Dorton seemed hardly at all handicapped by his lengthy title. He stated that, on the basis of ration board records, the growth in population in Bay Area communities in the period 1940-1943 was approximately as follows:

West Bay Area (San Francisco)	9.5%
East Bay Area	22.5%

CORROSION

U. S. REGISTERED TRADE MARK

an acid resisting alloy for

Pumps • Valves • Chemical Coatings • Drain Pipe & Fittings

ARCHITECTS AND ENGINEERS
ENGAGED IN WAR HOUSING
AND POST-WAR PLANNING MAY
CONSULT OUR ENGINEERING
DEPARTMENT WITHOUT
OBLIGATION



PACIFIC FOUNDRY COMPANY LTD.
Engineers and Metallurgists

3100 - 19th Street
SAN FRANCISCO

NEW YORK SAN FRANCISCO LOS ANGELES

Pittsburg Area	30.0%
Richmond	111.0%
Vallejo Township	132.0%

He spoke of the strain upon municipal facilities such as schools, hospitals, shopping areas, recreation and transport facilities, and upon the services of police and fire protection, and garbage disposal. Mr. Dorton quoted Eugene Weston, Regional Representative of the National Housing Agency, as stating that one-third of the total housing program of that agency in the whole United States had been centered in California, with 85,000 "title 6" units and 100,000 war-apartment and dormitory units having been authorized.

Plans are being made to care for the estimated 500,000 population increase in California in the next nine months. Of this number from 84,000 to 100,000 persons are expected to come to the San Francisco Bay Area.

To the members of the construction industry present, the end of the war did not seem to be the end of the problems incident to this modern migration. Someone remarked that mushrooms spoiled badly unless properly taken care of.

PACIFIC PAINT & VARNISH CO.

A Paint or Varnish Product for Every Purpose

SAN FRANCISCO
Sales Office

BERKELEY
Factory

LOS ANGELES
Sales Office

PRODUCERS' COUNCIL PAGE

Northern California Chapter

The National Organization of Manufacturers of Quality Building Materials and Equipment
Affiliated with the AMERICAN INSTITUTE OF ARCHITECTS



CLARKE E. WAYLAND
... slide trombonist

as President of the Northern California Chapter, back in '35.

Born in San Francisco, he studied mechanical engineering at U. C., graduated in 1917. His next four years were spent with the Chas. C. Moore Co., San Francisco engineers, and with the Babcock and Wilcox Company in the design, construction and testing of steam electrical power plants.

From 1920 to '30, Clarke helped Johns-Manville Sales Corporation in San Francisco to prosper. In 1930, Clarke branched out on his own, taking on the Johns-Manville franchise for the sale and installation of Sound Control Materials, Corrugated Transite Materials, plus the distribution of Industrial Power Products. In 1934, the Wayland Co. merged with Western Asbestos Magnesia Co., to form the Western Asbestos Co. As Vice-President, Clarke has kept his organization in the active column in Chapter affairs. Early years of the Producers' Council Club of Northern California saw Clarke serving not only as President (they called 'em Governors then) but also as Secretary and Vice-President. Clarke's interests and activities in the construction industry are many, and he has gained fame far and wide as a gentleman farmer and apple grower de luxe.

Xmas Jinks Rationed! Attendance this year is limited to 180. So run, do not walk, to the nearest phone and dial SUtter 4211, and fix up your reservation with Harry Lemos right now! Don't forget, the Jinks is the highspot of the year's activities—and it comes early this year—December 1. TIME: Cocktails at 6:30 p.m. PLACE: The Engineers Club of San Francisco. TICKETS: \$4.00. What's holdin' you back?

Seal Scores in Survey. We're talking about the Producers' Council Seal, of course. In a recent anonymous

market survey made in this area, the Seal chalked up a 70 per cent acceptance by Bay Area Architects and Engineers, when it was used in advertising. If member companies need definite assurance to get them off the dime on the matter of using the Seal, here it is. Certain it is that our advertising departments don't have to work with tongue in cheek when it comes to talking about the merit of our products . . . and the Council Seal can serve a very definite purpose in developing the quality idea. Don't forget what we call ourselves. "The organization of manufacturers of **quality** building materials and equipment. Affiliated with the American Institute of Architects."

It's nice to know, for sure, that when the Architect or Engineer gets ready to make a buying decision, the number one factor that helps him decide is his confidence in the salesman. Also high in the buyer's estimation is the reputation of the manufacturer and the quality of his products.

Good Idea Dept.—Use the Council Seal on business cards and correspondence. Here's a fine opportunity to increase prestige of individual companies.

Ballyhoo Banned. A recent letter from Theodore I. Coe, Technical Secretary to the A.I.A., provides the best picture possible of the unique relationship between the Architect-Engineer and the Producers' Council Member. Coe sees them as associates, rather than customer and salesman. Mr. Coe says: "We like to feel that the objectives of the affiliation, 'A closer and more professional relationship between architects and the producers of material, and their use,' have made a substantial contribution to the better understanding which has developed during the period of the affiliation between architects and the producers of the products they need and specify. We like to feel that these objectives have played a part in creating an appreciation of the fact that the architect needs factual, technical information concisely presented and not the ballyhoo of silvery-tongued 'spielers.' Certain it is that responsible producers are now represented by those qualified to explain and demonstrate the technical characteristics of the products in which the architect is interested."

An obligation is implied too, of course. Let not any one of us let the rest of us down.

(Turn to next page)

USE QUALITY PRODUCTS

CONSULT AN ARCHITECT



PRODUCERS' COUNCIL (continued)

"Or Equal" slapped again. Architects in convention in Los Angeles last month passed a resolution recommending an improved bidding procedure, eliminating the use of the "Or Equal" clause.

Modular Planning Boosted. Last month your Chapter sponsored a meeting of local structural clay products manufacturers to hear Harry C. Plummer, Director of Engineering and Research for the Structural Clay Products Institute. The Modular Planning project was favorably accepted by all present. Particularly enthusiastic were the masonry contractors, who foresaw 25 per cent savings resulting from modular masonry units. **Modular Post-War Planning** was the outgrowth of a further session by manufacturers of glazed wall units, called by Ray Brown (Gladding, McBean), Chairman of our Technical sub-Committee under the Post-War Planning Committee. Modular sizes were adopted by the industry and the following manufacturers: Kraftile, Gladding, McBean and N. Clark & Sons pledged themselves to have modular products available for post-war construction.

"THE MEANEST THIEF"

Twelve million checks a month are being mailed by the United States Treasury Department. They are going principally to dependents of men in the armed forces—to the wives and mothers of men who are giving their all in the barren wastes of the Arctic, in the far reaches of the Pacific, in the unbearable heat of the desert—that American ideals may not perish from the earth.

"That anyone would stoop to the level of pilfering these checks from private mailboxes is well nigh unbelievable, yet true," the Treasury says.

Because of the hardships occasioned by such thievery, and due to the necessary investigation and routine of issuing a duplicate check, the United States Secret Service has requested that everyone join in a nationwide campaign of education designed to protect payees and merchants against this meanest of all thieves.

When cashing checks for others, the Secret Service suggests these four points:

1. Know your endorsers.
2. Before cashing a Government check for a stranger, ask yourself this question—"If the bank returns this check as a forgery, can I find the forger and recover my loss?"
3. Have all checks initialed by the employee who cashes them.
4. Insist upon having all checks endorsed in your presence.

If an allotment or allowance check is received from the Government, the Secret Service urges that these simple suggestions be followed:

1. Never endorse a check until you are actually in the presence of the person who will cash it.

2. Be sure your mailbox is locked.
3. Whenever possible, arrange with your mail carrier to deliver all checks in person rather than to the box.
4. See that your name is printed plainly on your mailbox.
5. If you change your address notify the postal authorities immediately.
6. Cash your checks in the same place each month.
7. Cash your checks yourself. Don't send small children to the store with it. Such a practice encourages juvenile delinquency and already one Federal Judge has sentenced a merchant for cashing a Government check for a child, obviously not the payee.

NEW USES FOR GLASS

In modernizing kitchens today, builders are finding it possible to use Carrara glass as splashers behind kitchen stoves. The glass, cut to size, may be attached to the wall either by means of rosettes or by means of mastic. It is impervious to grease, grime and dirt, and does not absorb odors.

Such a panel also may be used behind the lavatory in the bathroom, where it is colorful, attractive and smart, as well as useful in protecting the wall from splashing and discoloration.

The glass is easily cleaned with a damp cloth.

CIVIL ENGINEERS—S. F. SECTION NOTES

Wm. J. O'Connell, Jr., technical consultant of San Francisco, graduate of the University of California in 1925, was principal speaker at the bi-monthly meeting of San Francisco Section, American Society of Civil Engineers, Tuesday evening, October 19. His subject was "Wastes from California Industries—Pollution Loadings and Treatments."

* * *

Henry D. Dewell is completing his work as editor of the "Timber Test Reports of the Structural Members Used In Treasure Island Exposition" under sponsorship of the San Francisco Section, A.S.C.E.

* * *

The following have been reported as serving their country, as indicated:

- Ensign Donald R. Brown, U.S.N.
- Sgt. Stephen D. Crow, U.S.A.
- Lt. Morgan E. Stewart, U.S.A.

XMAS SEAL SALE

With the mail delivery of November 22, tuberculosis associations throughout the United States will inaugurate the thirty-seventh annual Christmas Seal sale.

The design showing a child watching Santa Claus is a cheerful reminder that Christmas will soon arrive. The double-barred cross, appearing in the lower left-hand corner is also a reminder—that tuberculosis is still a dangerous enemy which must be brought under control.

Estimator's Guide

Giving Cost of Building Materials, Wage Scale, Etc.

Amounts given are figuring prices end are made up from average quotations furnished by material houses to San Francisco contractors. 3% Sales Tax on all materials but no labor.

All prices and wages quoted are for San Francisco and the Bay District. There may be slight fluctuation of prices in the interior and southern part of the state. Freight cartage, at least, must be added in figuring country work.

Bond—1 1/2% amount of contract.
Government work 3/4%.

Brickwork—
Common, \$43 to \$45 per 1000 laid, (according to class of work).
Face, \$125 to \$150 per 1000 laid, (according to class of work).
Brick Steps, using pressed brick, \$1.50 lin. ft.
Brick Veneer on frame buildings, \$1.10 sq. ft.
Common f.o.b. cars, \$16.00 a yard. Cartage extra. \$2.50 per 1000.
Face, f.o.b. cars, \$55.00 to \$80.00 per 1000, carload lots.

Building Paper—
1 ply per 1000 ft. roll.....\$3.50
2 ply per 1000 ft. roll.....5.00
3 ply per 1000 ft. roll.....6.25
Brownlin, Standard, 500 ft. roll.....5.00
Sisalcraft, 500 ft. roll.....5.00
Sash cord com. No. 7.....\$1.20 per 100 ft.
Sash cord com. No. 8.....1.50 per 100 ft.
Sash cord spot No. 7.....1.90 per 100 ft.
Sash cord spot No. 8.....2.25 per 100 ft.
Sash weights, cast iron, \$50.00 ton.
Nails, \$3.50 bale.
Sash weights, \$45.00 per ton.

Concrete Aggregates—
GRAVEL (all sizes) \$1.95 per ton at bunker; delivered, \$2.50. All quotations less 10% to contractors.

	Bunker	Delivered
Top sand.....	\$1.90	\$2.50
Concrete mix.....	1.90	2.45
Crushed rock, 1/4 to 3/8.....	2.95	3.15
Crushed rock, 3/8 to 1/2.....	1.90	2.50
Roofing gravel.....	2.25	2.80
River sand.....	2.25	2.70

SAND—

	Bunker	Delivered
River sand.....	\$2.25	\$2.70
Lapis (Nos. 2 & 4).....	2.95	3.15
Olympia Nos. 1 & 2.....	2.85	3.10
Del Monte white.....	.84c per sack	

Common cement (all brands, paper sacks) carload lots \$2.42 per bbl. f.o.b. car; delivered \$2.60.

Cash discount on carload lots, 10c a barrel, 10th Prox.

Atlas White
Calaveras White
Medusa White

1 to 100 sacks, \$2.70 sack, warehouse or delivery; \$7.65 bbl. carload lots.

Forms, Labors average \$40.00 per M.
Average cost of concrete in place, exclusive of forms, 35c per cu. ft.; with forms, 60c.
4-inch concrete basement floor.....12 1/2c to 14c per sq. ft.
Ret-proofing.....7 1/2c
Concrete Steps.....\$1.25 per lin. ft.

Dampproofing and Waterproofing—
Two-coat work, 20c to 30c per yard.
Membrane waterproofing—4 layers of saturated felt, \$4.50 per square.
Hot coating work, \$2.00 per square.
Medusa Waterproofing, 15c per lb., San Francisco Warehouse.
Tricocel waterproofing.
(See representative.)

Electric Wiring—\$12.00 to \$15.00 per outlet for conduit work (including switches).
Knob and tube average \$3.00 per outlet. (Available only for priority work.)

Elevators—
Prices vary according to capacity, speed and type. Consult elevator companies.
Average cost of installing a slow speed automatic passenger elevator in small four story apartment building, including entrance doors, about \$6500.00.

Excavation—
Sand, 60 cents; clay or shale \$1 per yard.
Teams, \$12.00 per day.
Trucks, \$22 to \$27.50 per day.
Above figures are an average without water. Steam shovel work in large quantities, less; hard material, such as rock, will run considerably more.

Fire Escapes—
Ten-foot galvanized iron balcony, with stairs, \$150 installed on new buildings; \$160 on old buildings.

Floors—
Composition Floors—22c to 40c per sq. ft.
In large quantities, 18c per sq. ft. laid.
Mosaic Floors—90c per sq. ft.
Duraflex Floor—23c to 30c sq. ft.
Rubber Tile—50c to 75c per sq. ft.
Terrazo Floors—45c to 60c per sq. ft.
Terrazo Steps—\$1.60 lin. ft.

Hardwood Flooring (delivered to building)—

	1 1/2" x 2 1/4"	3/4" x 2"	1 1/2" x 2"
	1 1/2" x 2 1/4"	1 1/2" x 2"	1 1/2" x 2"
Cir. Old, Oak.....	\$144.00 M	\$122.00 M	\$141.00 M
Sel. Old, Oak.....	118.00 M	101.00 M	114.00 M
Cir. Pla. Oak.....	120.00 M	102.00 M	115.00 M
Sel. Pla. Oak.....	113.00 M	92.00 M	107.00 M
Cir. Maple.....	125.00 M	113.00 M	

Wage—Floor layers, \$12.00.
Note—Above quotations are all board measure except last column which is sq. ft.

Glass (consult with manufacturers)—
Double strength window glass, 20c per square foot.
Plate 80c per square foot (ungleazed) in place, \$1.00.
Art. \$1.00 up per square foot.
Wire (for skylights), glazed, 40c per sq. foot.
Obscure glass, 30c to 50c square foot.
Glass bricks, \$2.50 per sq. ft. in place.
Note—if not stipulated add extra for setting.

Heating—
Average, \$1.9C per sq. ft. of radiation, according to conditions.
Warm air (gravity) average \$48 per register.
Forced air, average \$68 per register.

Iron—Cost of ornamental iron, cast iron, etc., depends on designs.

Lumber (prices delivered to bldg. site)—
No. 1 common.....\$45.00 per M
No. 2 common.....43.00 per M
Select O. P. Common.....48.00 per M
1x4 No. 2 flooring VG.....80.00 per M
1x4 No. 3 flooring VG.....75.00 per M
1x6 No. 2 flooring VG.....90.00 per M
1 1/4x4 No. 2 flooring.....85.00 per M

Slash grain—
1x4 No. 2 flooring.....\$45.00 per M
1x4 No. 3 flooring.....62.00 per M
No. 1 common run T. & G.....50.00 per M
Lath.....7.50 per M

Shingles (add cartage to price quoted)—
Redwood, No. 1.....\$1.20 per bdle.
Redwood, No. 2.....1.00 per bdle.
Red Cedar.....1.40 per bdle.
Plywood—Douglas Fir (add cartage)—
"Plyscord" sheathing (unsanded)
1/2" 3-ply and 48"x96".....\$39.75 per M
"Plywall" (wallboard grade).....\$43.70 per M
1/2" 3-ply 48"x96".....\$47.30 per M
"Plyform" (concrete form grade).....\$17.30 per M
3/8" 5-ply 48"x96".....\$13.70 per M
Exterior Plywood Siding—
1/2" 3-ply Fir.....\$132.00 per M
Redwood (Rustic) 1 1/8" clear heart. \$ 75.00 per M
\$5 less per M for A grade.

Millwork—Standard.
O. P. \$100 per 1000. R. W. rustic \$100.00 per 1000 (delivered).
Double hung box window frames, average with trim, \$6.50 and up, each.
Complete door unit, \$10.00.
Screen doors, \$3.50 each.
Patent screen windows, 25c a sq. ft.
Cases for kitchen pantries seven ft. high, per lineal ft., \$8.00 each.
Dining room cases, \$8.00 per lineal foot. Rough and finish about 75c per sq. ft.
Labor—Rough carpentry, warehouse heavy framing (average), \$17.50 per M.
For smaller work average, \$35.00 to \$45.00 per 1000.

Marble—(See Dealers)

Painting—
Two-coat work.....per yard 50c
Three-coat work.....per yard 70c
Cold water painting.....per yard 10c
Whitewashing.....per yard 4c

Turpentine, \$1.08 per gal., in 5 gal. cans, and 95c per gal. in drums.
 Raw Linseed Oil—\$1.32 gal. in light drums.
 Boiled Linseed Oil—\$1.35 gal. in drums and \$1.48 in 5 gal. cans.

White Lead in oil

Per Lb.
 1 ton lots, 100 lbs. net weight.....11¹/₂c
 500 lbs. and less than 1 ton.....12¹/₄c
 Less than 500 lb. lots.....12³/₄c

Red Lead and litharge

1 ton lots, 100 lbs. net weight.....11¹/₂c
 500 lbs. and less than 1 ton.....12¹/₄c
 Less than 500 lb. lots.....12³/₄c

Red Lead in oil

1 ton lots, 100 lbs. net weight.....12¹/₂c
 500 lbs. and less than 1 ton.....13¹/₄c
 Less than 500 lb. lots.....13³/₄c
 Note—Accessibility and conditions cause some variance in costs.

Patent Chimneys—

6-inch\$1.25 lineal foot
 8-inch1.50 lineal foot
 10-inch2.25 lineal foot
 12-inch3.00 lineal foot

Plaster

Neat wall, per ton delivered in S. F. in paper bags, \$17.60.

Plastering—Interior—

Yard
 1 coat, brown mortar only, wood lath.....\$0.70
 2 coats, lime mortar hard finish, wood lath .90
 2 coats, hard wall plaster, wood lath.....1.50
 3 coats, metal lath and plaster.....1.60
 Keene cement on metal lath.....1.60
 Ceilings with 3/4 hot roll channels metal lath (lath only).....1.10
 Ceilings with 3/4 hot roll channels metal lath plastered.....2.00
 Single partition 3/4 channel lath 1 side (lath only).....1.10
 Single partition 3/4 channel lath 2 inches thick plastered.....\$2.90
 4-inch double partition 3/4 channel lath 2 sides (lath only).....2.00
 4-inch double partition 3/4 channel lath 2 sides plastered.....2.50
 Thermax single partition; 1" channels; 2 1/2" overall partition width. Plastered both sides.....3.00
 Thermax double partition; 1" channels; 4 3/4" overall partition width. Plastered both sides.....4.00

3 coats over 1" Thermax nailed to one side wood studs or joists.....1.50
 3 coats over 1" Thermax suspended to one side wood studs with spring sound isolation clip.....1.75

Plastering—Exterior—

Yard
 2 coats cement finish, brick or concrete wall.....1.00
 3 coats cement finish, No. 18 gauge wire mesh.....1.75
 Wood lath, \$5.50 to \$6.50 per 1000 (not available)
 2.5-lb. metal lath (dipped) (not available)......19
 2.5-lb. metal lath (galvanized) (not avail.)......21
 3.4-lb. metal lath (dipped) (not available)......22
 3.4-lb. metal lath (galvanized) (not avail.)......24
 3/4-inch hot roll channel, \$72 per ton.....
 Finish plaster, \$18.90 ton in paper sacks.
 Dealer's commission, 11% off above quotations.
 \$13.85 (rebate 10c sack)
 Lime, f.o.b. warehouse, \$2.25 bulk; cars, \$2.15
 Lime, bulk (ton 2000 lbs.), \$16.00 ton.
 Wall Board 5 ply, \$50.00 per M.
 Hydrate Lime, \$25.00 ton.
 Plasterers' Wage Scale.....\$1.75 per hour
 Lathers' Wage Scale.....1.75 per hour
 Hod Carriers Wage Scale.....1.50 per hour
 Composition Stucco—\$1.80 to \$2.00 per sq. yard (applied).

Plumbing—

From \$100.00 per fixture up, according to grade, quantity and runs.

Roofing—

"Standard" tar and gravel, \$7.00 per sq. for 30 sqs. or over.
 Less than 30 sqs. \$7.50 per sq.
 Lime, \$20.00 to \$35.00 per square.
 Redwood Shingles, \$7.50 per square in place.
 Copper, \$16.50 to \$18.00 per sq. in place.
 5/2 # 1-16" Cedar Shingles, 4 1/2" Exposure.....8.00 Square
 5/8 x 16" # 1 Cedar Shingles, 5" Exposure.....9.00 Square
 4/2 # 1-24" Royal Shingles, 7 1/2" Exposure.....9.50 Square
 Re-coat with Gravel, \$3 per sq.
 Asbestos Shingles, \$15 to \$25 per sq. laid.
 Slate, from \$25.00 per sq., according to color and thickness.
 1/2 x 25" Resawn Cedar Shakes, 10" Exposure.....10.50
 3/4 x 25" Resawn Cedar Shakes, 10" Exposure.....11.50

1 x 25" Resawn Cedar Shakes, 10" Exposure.....12.50
 Above prices are for shakes in place.

Sheet Metal—

Windows—Metal, \$1.75 a sq. ft.
 Fire doors (average), including hardware, \$1.75 per sq. ft.

Skylights—(not glazed)

Copper, 90c sq. ft. (flat).
 Galvanized iron, 40c sq. ft. (flat).
 Vented pig skylights 60c sq. ft.

Steel—Structural (None available except for defense work)

\$150 ton (erected), this quotation is an average for comparatively small quantities. Light truss work higher. Plain beams and column work in large quantities \$140 per ton.

Steel Reinforcing (None available except for defense work).

\$150 to \$200 per ton, set.

Stone—

Granite, average, \$6.50 cu. foot in place.
 Sandstone, average Blue, \$4.00. Boise, \$3.00 sq. ft. in place.
 Indiana Limestone, \$2.80 per sq. ft. in place.

Store Fronts—

Copper sash bars for store fronts, corner, center and around sides, will average \$1.00 per lineal foot.
 Note—Consult with agents.

Tile—Floor, Wainscot, etc. — [See Dealers]
 Asphalt Tile—18c to 28c per sq. ft. installed.

Wall Tile—

Glazed Terra Cotta Wall Units (single faced) laid in place—approximate prices:
 2 x 6 x 12.....\$1.00 sq. ft.
 4 x 6 x 12.....1.15 sq. ft.
 2 x 8 x 16.....1.10 sq. ft.
 4 x 8 x 16.....1.30 sq. ft.

Venetian Blinds—

40c per square foot and up. Installation extra.

Windows—Steel

Factory type sash 30c ft.
 Ventilators for steel sash \$5.00 each.

1943 BUILDING TRADES WAGE SCALES FOR NORTHERN CALIFORNIA

All crafts, except plasterers, are now working 8 hours a day. Plasterers' time is 6 hours.

CRAFT	San Francisco	Alameda	Fresno	Marin	Sacramento	San Jose	San Mateo	Vallejo	Stockton
ASBESTOS WORKERS	\$1.50	\$1.25	\$1.25	\$1.37 1/2	\$1.12 1/2	\$1.25	\$1.25	\$1.25	\$1.25
BRICKLAYERS	1.87 1/2	1.87 1/2	1.50	1.87 1/2	2.00	2.00	1.87 1/2	1.87 1/2	2.00
BRICKLAYERS' HODCARRIERS	1.40	1.40	1.05	1.40	1.40	1.40	1.40	1.40	1.40
CARPENTERS	1.43	1.43	1.25	1.43	1.43	1.43	1.43	1.43	1.43
CEMENT FINISHERS	1.37 1/2	1.37 1/2	1.25	1.25	1.25	1.50	1.25	1.25	1.25
ELECTRICIANS	1.70	1.50	1.50	1.37 1/2	1.50	1.50	1.50	1.50	1.37 1/2
ELEVATOR CONSTRUCTORS	1.61	1.56	1.50	1.61	1.61	1.50	1.50	1.56	1.56
ENGINEERS: Material Hoist	1.50	1.37 1/2	1.25	1.50	1.37 1/2	1.52 1/2	1.37 1/2	1.37 1/2	1.25
Engineers: Piledriver	1.75	1.60	1.60	1.75	1.75	1.75	1.62 1/2	1.75	1.75
Engineers: Structural Steel	1.75	1.60	1.60	1.75	1.75	1.75	1.62 1/2	1.60	1.60
GLASS WORKERS	1.25	1.25	1.12 1/2	1.25	1.12 1/2	1.25	1.25	1.25	1.25
IRONWORKERS: Ornamental	1.50	1.31 1/4	1.37 1/2	1.31 1/4	1.37 1/2	1.31 1/4	1.25	1.31 1/4	1.31 1/4
IRONWORKERS: Structural	1.75	1.60	1.60	1.75	1.75	1.60	1.50	1.60	1.25
LABORERS: Building	.85	.87 1/2	.82 1/2	.81 1/4	.85	.81 1/4	.81 1/4	.81 1/4	.80
LABORERS: Concrete	.87 1/2	.93 3/4	.90	.81 1/4	.92 1/2	.85	.85	.90	.90
LATHERS	1.75	1.75	1.50	1.75	1.60	1.75	1.75	1.50	1.50
MARBLE SETTERS	1.43 3/4	1.25	1.25	1.31 1/4	1.37 1/2	1.25	1.31 1/4	1.25	1.25
MOSAIC & TERRAZZO	1.00	1.25	1.12 1/2	1.12 1/2	1.15-5/8	1.25	1.31 1/4	1.25	1.25
PAINTERS	1.37 1/2	1.50	1.28-4/7	1.37 1/2	1.25	1.35-5/7	1.42-6/7	1.50	1.25
PILEDRIVERS	1.47	1.40	1.40	1.50	1.40	1.47	1.40	1.40	1.40
PLASTERERS: Reinf. Rodmen	1.66-2/3	1.66-2/3	1.75	1.66-2/3	1.75	2.00	2.00	1.75	1.83-1/3
PLASTERERS' HODCARRIERS	1.50	1.45	1.40	1.40	1.19 3/4	1.35	1.75	1.40	1.50
PLUMBERS	1.70	1.50	1.53-1/8	1.50	1.56 1/4	1.62 1/2	1.50	1.50	1.37 1/2
ROOFERS	1.37 1/2	1.37 1/2	1.12 1/2	1.25	1.25	1.37 1/2	1.25	1.25	1.25
SHEET METAL WORKERS	1.50	1.37 1/2	1.43 3/4	1.37 1/2	1.50	1.50	1.37 1/2	1.25	1.25
SPRINKLER FITTERS	1.50	1.37 1/2	1.25	1.25	1.25	1.50	1.62 1/2	1.50	1.50
STEAMFITTERS	1.50	1.50	1.53 1/4	1.50	1.56 1/4	1.62 1/2	1.50	1.50	1.50
STONESETTERS (Masons)	1.50	1.75	1.50	1.75	1.75	1.50	1.75	1.75	1.50
TILESETTERS	1.50	1.37 1/2	1.37 1/2	1.37 1/2	1.37 1/2	1.50	1.50	1.37 1/2	1.50

Prepared and compiled by

CENTRAL CALIFORNIA CHAPTER, ASSOCIATED GENERAL CONTRACTORS OF AMERICA

with the assistance and cooperation of secretaries of General Contractors Associations and Builders Exchanges of Northern California.

PRODUCTS FOR POST-WAR PRACTICE

PLYWOOD IN POST-WAR—Emphasizing the new developments which the war has brought to the plywood industry, and stressing the peace-time applications of these developments, a new booklet, "In Service On All Fronts," has been issued by United States Plywood Corporation. The 16 pages include more than 30 photographs illustrating the wartime uses of plywood. These photographs show not only flat plywood products but molded, metal-faced, waterproof, and tubular plywood products as well. Copy will be sent upon request, addressing 616 West 46th St., New York, 19, N. Y.

PRESSURE LUBRICATION—Positive lubrication of all bearings on machine tools and similar equipment, regardless of condition or location of bearings, is claimed for the improved "Multival" system



Power-operated portable gun oils and greases machinery.

made by the Farval Corporation, Cleveland, Ohio. Oil and grease under pressure is delivered to the distributing blocks by the means of a manual or power-operated portable gun which serves as a central pump. Use of the system affords a number of economical advantages, according to the manufacturer.

GLASS BLOCK AS REPLACEMENTS—Methods of replacing worn-out windows with Insulux Glass Block are described in detail in a new booklet just released by the Owens-Illinois Glass Co. Photographs of typical installations are included along with specifications, technical data, and typical construction details. Many advantages are claimed for such altera-

tion. Copy may be obtained by writing the Insulux Products Division, Owens-Illinois Glass Co., Toledo, Ohio.

PAINT SPRAYING RULES—A wall chart of spraying rules showing how to save paint, air, time, power, fuel, and equipment, reduce time lost because of sickness or accident, and improve results, has been published by the Eclipse Air Brush Co., 400 Park Ave., Newark, 7, N. J. These rules apply to all types of spray equipment. Chart will be sent gratis to anyone requesting it.

RESIN GLUE AND WOOD—Giant laminated wood span trusses are being used extensively for the roof supports in military structures. On one unusual job recently several three-hinged arches, with each section made up of thirty-seven $\frac{3}{4}$ " x 8" boards, were stretched without support from ground level to ground level for over 117 feet, with a rise of 44 feet. These span arches, which measured 7" x 27 $\frac{1}{2}$ " in cross-section, are thought to be the largest ever built of glue-laminated wood. Plaskon Resin Glue, manufactured by the Plaskon Division of the Libbey-Owens-Ford Glass Co., was used for the laminating of these arches. Important features are said to be permanent strength and weatherproof qualities. In shear tests the wood shatters leaving the glue intact.

PORCELAIN ENAMELED IRON—Useful data for product engineers, designers, architects and others interested in the use of porcelain enameled iron are presented in a booklet just published by The American Rolling Mill Co., Middletown, Ohio. Engineering information is given on the abrasion and friction resistance, weather resistance, resistance to chipping, resistance to thermal shock, color fastness and range, finishes available, chemical resistance and physical properties of porcelain enamel. Its physical properties also are compared with those of many other materials: glass, ceramic white ware, thermo-setting plastics, hard rubber, aluminum and its alloys, nickel, copper, zinc, iron alloys

and cast iron. Copies of the booklet, which is entitled, "Porcelain Enamel, the Lifetime Finish," may be obtained by writing The American Rolling Mill Co., Middletown, Ohio.

THREE-POINT GAGE—A new pocket size gage for measurement of all sizes of pipe from $\frac{1}{8}$ " to 12" is announced by the Three-Point Gage Co., 3821 Broadway, Chicago, Ill. This gage, which is patented in Canada and for which

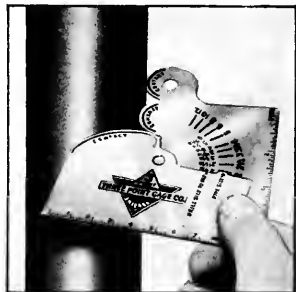

Convenient pocket-size gage for pipe measurement.

patents are pending in the U. S., consists of two pivoted steel plates with edges curved at three points for contact with the pipe to be measured, together with scale which automatically registers not only the pipe size in terms of inside diameter but the drill size for tapping.

ABC OF ELECTRONICS—The fundamental principles of the six basic ways in which electronic tubes function are explained in a new 36-page booklet announced by Westinghouse Electric and Manufacturing Company. Schematic drawings for the tube construction and diagrams showing the typical circuits for the various functions are used to explain how electronic tubes rectify, amplify, generate, control, transform light into current and current into light. Industrial and military uses are described and illustrated in this booklet, "The ABC of Electronics at Work." A copy of booklet B-3260 may be secured from Dept. 7 N 20, Westinghouse Elec. & Mfg. Co., East Pittsburgh, Pa.

PARAMOUNT

Built-In Fixtures

USED IN MANY OF
THE BETTER WAR
HOUSING PROJECTS
ARE DESIGNED TO IN-
SURE MAXIMUM EFFI-
CIENCY AT MINIMUM
COST

*PARAMOUNT FIXTURES are
recognized by architects and
builders for their distinctive appear-
ance and superior workmanship.*



HOME BUILDING AFTER THE WAR

Post-war buying intentions of the nation's families are increasing almost daily and present indications are that post-war purchases will be far in excess of the billions of dollars that were in prospect last winter.

Bringing a December, 1942, nationwide survey up-to-the-minute, the Chamber of Commerce of the United States reports that, for example, the number of families now planning to purchase one or more major articles within six months after the return of peace has risen from 53 per cent to 64 per cent of the nation's total.

On the other side of the ledger, 61 per cent of the people interviewed said they now are able to save. It was 56 per cent eight months ago. These figures include only those people who **think** they are saving. Actually, 84 per cent, an increase of 3 percentage points, are either accumulating money in a savings account or are putting it in some other form of savings or investment.

At the same time, the public as a whole believes a little more firmly that the first year after the end of the war will be one of prosperity, and that there will be less unemployment than they believed probable eight months ago. The Chamber's figures show that the number of those who have grown more optimistic has risen from 49 per cent of the people to 55 per cent. As to the public's appraisal of industry's post-war capacity to meet the demand for civilian goods, 86 per cent now believe that American factories will take more than six months to catch up with the demand for consumer goods.

While virtually all components in the statistics relating to consumer purchasing and savings intentions went up in the new tabulation, there has been a noticeable drop in family planning for such things as furniture and floor coverings in their homes. There also have been decreases in intentions to redecorate the interior of homes, to modernize kitchens, to add new porches and to renovate bathrooms.

The Chamber's survey shows these major changes in trends:

3,675,000 families, compared with 2,590,000 in December, now intend to buy automobiles to cost \$3,307,500,000, compared with \$2,331,000,000.

The household appliance field shows an increase in buying intentions from \$860,185,000 to \$1,215,910,000, with the greatest jump occurring in radios and electric kitchen mixers.

Overall home furnishings purchase intentions show only a nominal increase from \$709,905,000, to \$711,410,000.

1,540,000 families—an increase of 50 per cent—intend to build or buy a new home within six months after the war is over. The prospective investment has risen from an estimated \$5,000,000,000 to \$7,184,800,000.

72 per cent of the people say they feel they are



QUALITY AND DEPENDABLE Service

are the factors that influence architects and contractors when selecting lumber and mill work — Quality of merchandise — Integrity and Ability of the firm — Service in physical equipment — Experience and Personnel — All these factors contribute to a speedy and satisfactory completion of construction with minimum of time and expense.

MANUFACTURER OR DEALER IN

Douglas Fir—Redwood—Sugar and Ponderosa Pine — Plywood and Concrete Form Panels — Sash and Doors — Millwork — Insulation — Builders' Hardware.

E. K. WOOD LUMBER CO.

"Goods of the Woods" ©
LOS ANGELES • SAN FRANCISCO • OAKLAND

for THIS battle, G. H. Q.

is at YOUR own desk!

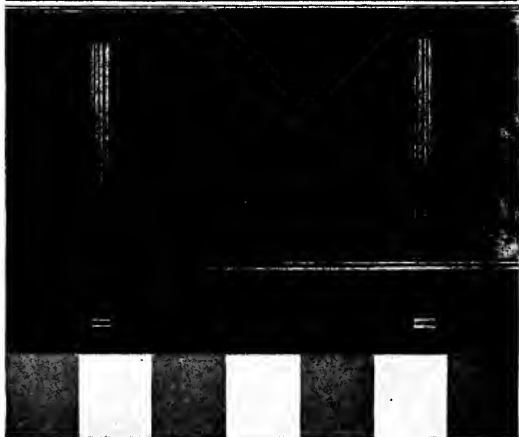

★ Here's how you—yes, YOU—can carry out a smashing "pincer movement" against the Axis. Swing in on one flank with increased production of war goods! Drive in on the other with redoubled purchases of War Bonds through your Pay-Roll Savings Plan!

You're an officer in both of these drives. Your personal leadership is equally vital to both. But have you followed the progress of your Pay-Roll Savings Plan as closely as you have your production?

Do you know about the new Treasury Department quotas for the current Pay-Roll Allotment Drive? Quotas running about 50% above the former figures? You see, these new quotas are based on the fact that the armed forces need more money than ever to win the war, while the average worker has more money than ever before to spend. Particularly so, on a *family income* basis—since in so many families several members are working, now.

Remember, the bond charts of today are the sales curves of tomorrow! Not only will these War Bonds implement our victory—they'll guard against inflation, and they'll furnish billions of dollars of purchasing power to help American business re-establish itself in the markets of peace.

So get this new family income plan working at once. Your local War Finance Committee will give you all the details of the new plan. Act today!

This advertisement prepared under the auspices of the War Advertising Council and the U. S. Treasury Department.

LET'S KEEP ON Backing the Attack!

This Space is a Contribution to America's All-Out War Effort by

ARCHITECT AND ENGINEER

pre bilt

SCHOOL CLASSROOMS



For information phone CArfield 8677 or write

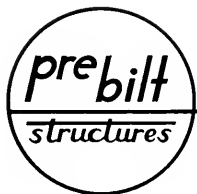

STANDARD ENGINEERING CORPORATION

MANUFACTURERS
251 KEARNY STREET
SAN FRANCISCO

at least as well off financially as a year ago, a drop of 1 per cent. The figures, broken down, show the following percentages for the two surveys: East, 65 per cent and 69 per cent; Middlewest, 74 per cent and 72 per cent; South, 79 per cent and 78 per cent; Far West, 70 per cent and 78 per cent.

Not only are people in the higher income brackets more likely than others to be saving money, but they are saving a greater proportion of their incomes, the Chamber reported. For example, 34 per cent—it was 28 per cent last December—of all respondents say they are able to save more than 10 per cent of their monthly income. But, only 14 per cent of people earning less than \$90 a month save that amount, compared with 32 per cent of those earning from \$90 to \$160 monthly, and 54 per cent of those earning more than \$210 monthly.

This second survey shows that the percentage of people buying war bonds and stamps has risen from 69 to 76. The percentage of people in the upper income groups investing as much as 10 per cent of their income in such bonds and stamps has dropped from 28 to 23; the middle income group has slumped from 35 to 26; the lower income groups has dropped from 28 to 21. It is obvious from the Chamber's other figures that the number of persons who so invest at least 10 per cent of their income has climbed sharply.

Life insurance investments are attracting the funds of 56 per cent of the people, compared with 58 per cent in December. The percentage going to savings accounts windows has risen from 21 per cent to 26 per cent.

But only 25 per cent of the nation's families are saving for a specific purpose. Even so, that figure is 6 points higher than eight months ago. Despite the evidence that many people intend to make immediate, major post-war purchases, most of them are not, on the basis of present savings, counting on paying cash.

ASSOCIATED HOME BUILDERS

Associated Home Builders have opened an office in the Hearst Building, San Francisco, in anticipation of a home building boom after the war. At a recent meeting of the directors the following resolution was passed on resuming civilian home building:

WHEREAS, according to information received from our National Association of Home Builders and the National Association of Real Estate Boards, metals, critical materials and other materials used in building construction are more plentiful and less required by the armed services and are starting to accumulate; and

WHEREAS, the freezing of home construction for civilians has now reached a point that has created a dangerous shortage of said homes in crowded metropolitan centers, working a hardship upon the civilian population to the point of interfering with the country's civilian economy, and creating a certain amount of unemployment among skilled workers connected with this industry; and

WHEREAS, the continued construction of Title VI homes for

Thank You, Mr. Jeffers For Relief in the Rubber Crisis

Thanks for a hard job, well done, as Rubber Director. The American Rubber Manufacturing Company joins its customers in expressing appreciation for this achievement:

Many industrial rubber products formerly unobtainable, may now be had with little or no delay!

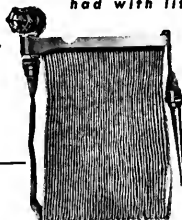

Lightning Hose Racks, Reels, and Cabinets are so varied in style that at least one meets any requirement.

For details, write to:

The
AMERICAN RUBBER
Manufacturing Co.
Factory and
General Offices:
Park Avenue and Watts Street, Oakland, 8, California

Quiet . . . for offices,
schools, banks, hospitals,
radio stations, with . . .

CELOTEX
ACOUSTICAL MATERIALS

*High sound absorption . . . easily
cleaned . . . paintable . . . low in cost!*

WESTERN ASBESTOS CO.
Acoustical Engineers and Contractors
SAN FRANCISCO · OAKLAND · SACRAMENTO

**The Most Complete Line of
STEELS and BUILDING MATERIALS
Made by a Single Producer**



See Sweet's Catalog File or write us for full information.

REPUBLIC STEEL CORPORATION
GENERAL OFFICES: CLEVELAND, OHIO

DENVER, COLORADO CONTINENTAL OIL BUILDING
LOS ANGELES, CALIFORNIA EDISON BUILDING
SALT LAKE CITY, UTAH WALKER BANK BUILDING
SAN FRANCISCO, CALIFORNIA RIALTO BUILDING
SEATTLE, WASH. WHITE-HENRY-STUART BUILDING

PACIFIC MANUFACTURING CO.

HIGH CLASS INTERIOR-FINISH
QUALITY MILLWORK

142 SANSOME ST., SAN FRANCISCO
GArfield 7755

6820 MCKINLEY AVE., LOS ANGELES
THornwall 4196

BUILDERS EXCHANGE, OAKLAND

"AMERICAN MARSH" Redi-Vac Vacuum Heating Pump



Send for
Bulletin 441

SIMONDS MACHINERY CO.

San Francisco
816 Folsom St.

Los Angeles
455 East Fourth St.

VERMONT MARBLE COMPANY

Producers and Finishers
of
Domestic and Imported Marbles

Write for new pamphlet describing our
Marble Toilets and Showers

San Francisco and Los Angeles
San Francisco phone: SUTter 6747

immigrant war workers in first class residential districts threatens the post-war property value stability of those districts; and

WHEREAS, the forbidden building of new homes for civilian consumption has taken all competition out of the re-sale market, thus creating a dangerously inflated market in said re-sale homes; and

WHEREAS, the under supply of both old and new civilian homes creates a situation which may be used by advocates of public housing not only for continued construction of this nature, but the retaining of emergency public war housing after the war on the grounds that homes for these people are not available and will take a long time to provide; now, therefore

BE IT RESOLVED, by the Associated Home Builders of San Francisco that the National Housing Agency program allocations of civilian new homes to sell up to ceiling prices of \$7500, that the immigrant war worker directive be set aside for these homes, and that the War Production Board release materials and grant priorities for their construction in accordance with the civilian needs of critical metropolitan centers.

MODULAR PLANNING

Much discussed Modular Planning was the subject of a talk recently given before a group of San Francisco masonry contractors and structural clay products manufacturers. Harry C. Plummer, Director of Research and Engineering of the Structural Clay Products Institute, was the speaker at the meeting, which was sponsored by the Northern California Chapter of the Producers' Council.

Highlight of the program was the enthusiastic reception given Modular Planning by the masonry contractors present, who stated that Modular Planning could reduce brick laying costs as much as 25 per cent on residential construction in this area. Local architects, now bottlenecked in their use of brick because of the cost of detailing such work under today's largely hit-or-miss methods, will be enabled to increase their specification of brick work, through Modular Planning. Structural clay products manufacturers present announced themselves as in favor of the plan as a timely post-war project.

Local manufacturers of glazed structural wall units are now taking action to establish new standards in keeping with Modular Planning requirements.

BASALITE

CAMBERED SHINGLE TILE

PERMANENT • FIREPROOF • STORM-
SAFE • COLORFUL • ECONOMICAL

Manufactured by

BASALT ROCK CO., INC.
NAPA, CALIFORNIA

BOOK REVIEWS

PRACTICAL PERSPECTIVE DRAWING, by Philip J. Lawson, Pratt Institute. McGraw-Hill Book Company, Inc., 330 West 42nd Street, New York 18, N.Y. Price \$2.75.

For the student and practicing artist in the fields of advertising illustration, fiction illustration, industrial design rendering, and architectural rendering. A text and reference book that gives the basic geometrical and optical principles of perspective, outlines in detail two methods for making perspective drawing instrumentally, together with procedures for making freehand perspective drawings. It then shows how these techniques are used in the drawing of simple basic forms, actual objects derived from these forms, and groups of objects in perspective compositions.

STUDIES IN ARC WELDING, the James F. Lincoln Arc Welding Foundation, Cleveland, Ohio. Price \$1.50 in U.S.A.; \$2.00 elsewhere.

Embraces design, manufacture and construction. The book had its first printing in August. It may be ordered through any recognized book dealer or direct from the Foundation.

PLASTICS, by J. H. Dubois, American Technical Society, Drexel Avenue, at 58th Street, Chicago, Ill. Price \$3.75.

This is the second edition of a very popular book. It contains considerable fresh matter as evidenced by the addition of 144 pages. Practically all of the new material is devoted to the latest developments in synthetic rubber.

SLIDE RULE SIMPLIFIED, by Charles O. Harris, B.S. Published by American Technical Society, Drexel Avenue at 58th Street, Chicago, Ill. Price \$2.50.

A well written book, easy to understand and eminently practical. Slide Rule Simplified contains 266 pages, is well illustrated and has been written so it may be used either with or without the slide rule.

SISALKRAFT

REG. U. S. PAT. OFF.

"More than a building paper"

THE SISALKRAFT CO.

205 West Wacker Drive
Chicago, Ill.

55 New Montgomery Street
San Francisco, Calif.

HOGAN LUMBER CO.

Wholesale and Retail

LUMBER

MILL WORK • SASH & DOORS

Office, Mill, Yard and Docks

SECOND AND ALICE STREETS • OAKLAND, CALIF.

Telephone GLencourt 6861

CLINTON CONSTRUCTION CO. OF CALIFORNIA

General Contractors

923 FOLSOM STREET • SAN FRANCISCO

SUtter 3440

FORDERER CORNICE WORKS

Manufacturers of

Hollow Metal Products • Interior Metal Trim

Elevator Fronts and Cabs

Metal Plaster Accessories • Sanitary Metal Base

Flat and Roll Metal Screens

Metal Cabinets • Commercial Refrigerators

269 POTRERO AVE.

SAN FRANCISCO, CALIF.

HEMLOCK 4100

STRUCTURAL STEEL

For Class A Buildings,
Bridges, etc.

JUDSON PACIFIC CO.

1200 SEVENTEENTH STREET
SAN FRANCISCO

Plants: San Francisco - Oakland

STATEMENT OF THE OWNERSHIP, MANAGEMENT, CIRCULATION, ETC., REQUIRED BY THE ACT OF CONGRESS OF AUGUST 21, 1912 AND MARCH 3, 1933.

Of the Architect and Engineer, published monthly at San Francisco, Calif., for October 1, 1943.

City and County of San Francisco } SS.
State of California

Before me, a notary public in and for the state and county aforesaid, personally appeared L. B. Penhorwood, who, having been duly sworn according to law, depose and says that she is the Business Manager of The Architect and Engineer, and that the following is to the best of her knowledge and belief, a true statement of the ownership, management (if daily paper, the circulation), etc., of the aforesaid publication for the date shown in the above caption, required by the Act of August 21, 1912, as amended by the Act of March 3, 1933, embodied in section 537, Postal Laws and Regulations, printed on the reverse of this form, to wit:

1. That the names and addresses of the publisher, editor, managing editor, and business managers are:

Publisher, The Architect and Engineer, Inc., 68 Post St., San Francisco, Calif.

Editor, Fred W. Jones, 68 Post St., San Francisco, Calif.

Managing Editor—None.

Business Manager, L. B. Penhorwood, 68 Post St., San Francisco, Calif.

2. That the owner is: (If owned by a corporation, its name and address must be stated and also immediately thereunder the names and addresses of stockholders owning or holding one per cent or more of total amount of stock. If not owned by a corporation, the names and addresses of the individual owners must be given. If owned by a firm, company, or other unincorporated concern, its name and address, as well as those of each individual member, must be given.)

The Architect and Engineer, Inc., 68 Post St., San Francisco, Calif.

K. P. Kierulff, 68 Post St., San Francisco, Calif.

Fred W. Jones, 68 Post St., San Francisco, Calif.

L. B. Penhorwood, 68 Post St., San Francisco, Calif.

V. S. Yallop, 68 Post St., San Francisco, Calif.

E. J. Cardinal, 942 Howard St., San Francisco, Calif.

3. That the known bondholders, mortgagees, and other security holders, owning or holding one per cent or more of total amount of bonds, mortgages, or other securities are: (If there are none, so state.) E. J. Cardinal, 942 Howard St., San Francisco, Calif.

4. That the two paragraphs next above, giving the names of the owners, stockholders, and security holders, if any, contain not only the list of stockholders and security holders as they appear upon the books of the company but also, in cases where the stockholder or security holder appears upon the books of the company as trustee or in any other fiduciary relation, the name of the person or corporation, for whom such trustee is acting, is given; and that the said two paragraphs contain statements embracing affiant's full knowledge and belief as to the circumstances and conditions under which stockholders and security holders who do not appear upon the books of the company as trustees, hold stock and securities in a capacity other than of a bona fide owner; and that affiant has no reason to believe that any other person, association, or corporation has any interest direct or indirect in the said stock bonds, or other securities than as so stated by him.

5. That the average number of copies of each issue of this publication sold or distributed, through the mails or otherwise, to paid subscribers during the twelve months preceding the date shown above is. (This information is required from daily publications only.)

L. B. Penhorwood, Business Mgr.

Sworn to and subscribed before me the 29th day of September, 1943.

(Seal) CHAS. F. DUSENBERG
Notary Public in and for the City and County of San Francisco, Calif.

(My commission expires May 22, 1945.)

**JUST HOW BIG IS
A SPECK OF DIRT?**

Girl workers at Northrop Aircraft, Inc., Hawthorne, California, check the answer to this question on a comparator, a photo-electric machine that throws an image of delicate precision gages, enlarged 62½ times, onto a screen. These gages are used to check tolerances of all precision parts used in fighter plane production—hence it is vital that these measuring blocks be kept free of abrasive dirt.



The hairs and lumps on the gage shown in the picture above are bits of dust and lint that accumulated on the gage when it was left outside the air conditioned storage room. Foreign particles such as these are virtually eliminated from the gages when in the storage and repair room now, for more than 90 per cent of all air-borne dust and dirt particles blown into the room through the air conditioning ducts are trapped by a Westinghouse Precipitron, an electric air cleaning device. Before the recent installation of this Precipitron, dirt accumulation, invisible to the eye, caused damage by permitting abrasion of the highly polished surfaces of the measuring blocks.

A. F. MATTOCK CO.

Builders



**212 CLARA STREET
SAN FRANCISCO**

**INCANDESCENT
SUPPLY
COMPANY**

6 4 7

**MISSION STREET
SAN FRANCISCO**

Lighting Fixtures and
Lamps, Fireplace Furnishings, Pictures and Mirrors, Electrical Supplies and Marine Fixtures.

**Oakland - Fresno
Los Angeles**

**Independent
Iron Works**

Structural Steel
Ornamental Iron
Steel Service Stations
Steel Tanks
Standard Steel Mill Buildings
Bridges

821 Pine Street

Oakland

**ANDERSON
&
RINGROSE**

General Contractors

320 Market Street, San Francisco
Phone GARfield 2245

MULLEN MFG. COMPANY

BANK, STORE AND OFFICE
FIXTURES—CABINET WORK
OF GUARANTEED QUALITY
CHURCH SEATING

Office and Factory:
40-80 RAUSCH ST., Bet. 7th and 8th Sts.
San Francisco
Telephone UNderhill 5815

THE TORMEY COMPANY

GENERAL PAINTERS
AND DECORATORS

Phone UNderhill 1913

563 FULTON STREET
San Francisco

ABBOT A. HANKS, INC. Engineers & Chemists

INSPECTING — TESTING — CONSULTING
CONCRETE • STEEL • MATERIALS
CHEMICAL AND TESTING
LABORATORIES

• RESEARCH AND INVESTIGATION •

TESTS OF STRUCTURAL MATERIALS
DESIGN OF CONCRETE MIXES
SHOP AND ERECTION INSPECTION OF
STRUCTURES AND EQUIPMENT
INVESTIGATION OF STRUCTURES
AND MATERIALS
TESTS AND INVESTIGATION OF
FOUNDATION SOILS
FIRE RESISTANCE AND INSULATION
TESTS

624 Sacramento Street, San Francisco

Robert W. Hunt Company ENGINEERS

Inspection - Tests - Consultation
Schools and Other Structures
Are Built as Designed

When Construction Materials are
Inspected at point of Manufacture
and during Erection by

ROBERT W. HUNT COMPANY

Cement, Concrete, Chemical, Metallurgical,
X-Ray and Physical Laboratories

Chicago - New York - Pittsburgh
Los Angeles - All Large Cities
San Francisco, 251 Kearny Street

FLOWING LINES OF FLUORESCENT LIGHT

Army Air Base for the Air Service Command, Sacramento, Calif., speeds vital repairs, hence helps to hasten victory, by supplying 45 foot-candles of illumination at bench level. More



Strips of fluorescent lamps
illuminate war plant.

than 850 eight-foot Westinghouse lighting fixtures, each holding six 40-watt fluorescent lamps, are installed in continuous strips spaced 10 feet apart at a mounting height of 14 feet in the repair bay.

Power for the lighting load in this building is supplied from three-phase transformers rated from 150 to 300 kva. These transformers are suspended from the ceiling in cages, which permit the productive use of more floor area and removes the possibility of injury that might occur from contact with high voltage equipment.

PLAN NOW FOR YOUR PEACE TIME HOUSING

Low-rent housing projects suspended during the war will be given prior consideration in any publicly-financed program authorized by Congress after the emergency is over, according to Herbert Emmerich, Commissioner of the Federal Public Housing Authority.

He said that application for other Federally-aided projects for post-war construction would be accepted by F.P.H.A. regional offices, but pointed out that authority must be granted and funds made available before any action can be taken.

"The President has called attention to the need for preparing plans for public projects to be undertaken in the post-war period, and thus storing up a reservoir of work that can be

USE

Mailway Banking

**NIGHT
OR DAY**

Make deposits when you want to . . . right at the nearest mailbox. No need to "go to the bank." Nine out of ten transactions are routine that can be handled by our Mailway service, night or day, Sundays and holidays. Our special Mailway envelopes and passbook make service quick and safe.

Open a Mailway account by mail

CROCKER FIRST NATIONAL BANK

OF SAN FRANCISCO
California's Largest National Bank

Member Federal Deposit Insurance Corporation
ONE MONTGOMERY STREET

LANDSCAPING WAR HOUSING PROJECTS

**Maritime Commission
Apartments, Richmond
Sunnydale
G. G. Bridge Approach
Roosevelt Terrace, Vallejo
Camp Roberts
Chabot Terraces, Vallejo
Peralta Villa, Oakland
Sausalito
Union Square Garage**



Growers and Distributors of
"Superior Quality" Nursery
Stock Since 1878

LEONARD COATES NURSERIES, INC.

Ray D. Hartman, President-Manager

SAN JOSE, CALIFORNIA

**DINWIDDIE
CONSTRUCTION
COMPANY**

BUILDERS

CROCKER BUILDING
SAN FRANCISCO



**HERRICK
IRON WORKS**
STRUCTURAL STEEL
REINFORCING STEEL

18TH AND CAMPBELL STS.
OAKLAND, CALIF.
Phone GLencourt 1747

**G. P. W.
JENSEN & SON**

—
Building Construction
—

120 Market Street, San Francisco
Phone: GArdfield 2444

**JOHN
CASSARETTO**

—Since 1886—And Still Active—

Building Materials

READY MIX CONCRETE
ROCK - SAND - GRAVEL - LIME
CEMENT - PLASTER - MORTAR
METAL LATH - WOOD LATH
STUCCO - WIRE NETTING

Service Unexcelled

Bunkers
Sixth and Chennel, San Francisco
Phones: GArdfield 3176, GArdfield 3177

useful in providing employment opportunities and demands for materials," said Mr. Emmerich. "Many local housing authorities have already formulated plans for post-war housing projects and have asked that these be included in any shelf of public projects."

Projects are to be accepted for review by Regional Offices, Mr. Emmerich said, only where the local housing authority states:

a. That such projects will be consistent with a sound public housing program for the locality; and

b. That such projects could be put under construction promptly after loan funds, contributions and permanent materials are available, but not more than two years thereafter.

These proposed projects must represent programs locally initiated by the duly constituted local agencies, rather than programs made by the Federal Government.

PATTERNS OF PEACE

America must "begin to visualize the post-war problem, not as an excursion into the realm of fancy, but as one demanding an immediate survey of peacetime needs" was the view expressed by Clyde G. Conley, president of the American Institute of Steel Construction, in his annual convention address at Rye, N. Y., October 19.

Speaking to more than 300 members of the Institute, Mr. Conley characterized World War II as "the greatest dislocation in human history" and warned that unless industry is able to anticipate and begin now to plan constructively on the basis of "expected and logical demand," post-war recovery may be seriously delayed. "Industrial research must be doubled—even tripled," said Mr. Conley. "Planning for the post-war world must be detailed and realistic . . . must be based on facts."

Citing industry's record of wartime achievement, Mr. Conley characterized his own industry's part in that achievement as a vital one. "Geared to meet a variety of demands, we have again affirmed our reputation as a make-to-order industry. With the

order of the day for victory, the performance of the structural steel fabricating industry may well be termed a major factor in the defeat that is being crammed down Hitler's and Hirohito's throats."

"Today, all of us are engaged in the fabrication of products entirely different from those which went through our plants in the pre-war and early war period. When the construction of war manufacturing facilities and defense installations neared completion, the industry turned to the production of the actual instruments of war. The variety of these products is astounding to many of those who did not appreciate the reservoir of planning ability and versatility within the industry."

It has been estimated, Mr. Conley said, that the average construction volume in the ten years following the war's end will exceed the annual volume of any previous decade. Stressing the ability of the steel fabricating industry to meet all expected needs, Mr. Conley pointed out that despite the industry's capacity of 4,800,000 tons as estimated by the Department of Commerce in 1929, the industry was called upon during 1941 to fabricate only 2,296,954 tons—with 1941 being the peak year of the entire period beginning with 1931.

Needed in the post-war period, said Mr. Conley, will be construction for "public works, utilities and railroads, institutional buildings, plant facilities for consumers' goods, and multiple housing dwellings." In addition, it was his view that foreign countries will have even greater need for such construction. "Those countries which have been in the actual fighting zone will of necessity require a rehabilitation of public and industrial facilities."

Foreseeing a bright future for the steel fabricating industry, Mr. Conley declared: "While these demands will bring novel problems of engineering and production, the lessons which your recent changes in production methods have taught you should be of material assistance. It is my feeling that we have entirely demonstrated the versatility and the adaptability of the structural fabricating shops."

ARCHITECT

AND

ENGINEER



POST-WAR DEVELOPMENT PLAN FOR S. F. WATERFRONT

STAINED GLASS—PAST AND FUTURE

REGIONAL PLANNING—THE CENTRAL VALLEY PROJECT



PARKER BULL

ARCHITECT AND ENGINEER

Volume 155 No. 3

FRED W. JONES
Editor

MARK DANIELS
Associate Editor

MICHAEL GOODMAN
Consulting Editor

HOWARD MOISE
Post-War Planning

E. N. KIERULFF*
Ass't Editor
*In the Service

DECEMBER CONTENTS

Running Fire	3
Mark Daniels	
News and Comment on Art	4-8
In the News	10
Post-War Development Plan for San Francisco Waterfront	13
L. Deming Tilton	
<i>Illustrated with 10 full-page diagram plates</i>	
Stained Glass Past and Future	24
Jeannette Dyer Spencer	
Regional Planning—the Central Valley Project	27
Walter E. Peckard	
Survey Indicates New Uses for Woodwork in Post-War Homes	29
Frederick Hamilton	
Rainbow Bridge	31
E. L. Durkee	
War Housing Project	34
Producers' Council Page	37
State Association Notes	39
Wm. C. Ambrose	
Soule Steel Company Wins Army and Navy Award	41

NEXT MONTH

A memorial chapel by the office of Michael Goodman is to be featured as a result of an individual approach to ecclesiastic interior design. The question of present-day church design is a vexing one and confronts all creeds and denominations alike in their building programs to meet arising needs.

The chapel may be considered an alteration job, having been carved into two and a half stories of a wing of San Francisco's distinctive Temple Emanu-El.

Blazing new trails, the article on "A Modern Architectural Glass Medium for Memorial Windows" by Prof. Goodman, done for the de Young Museum, will be a follow-up to the one on the past and future of stained glass by Jeannette Dyer Spencer in the current issue.

Added to the set by Michael Goodman is an article on the "Post - War House - Beautiful" which Mr. Goodman views with a disturbed eye.

The story of Barrett & Hilp's phenomenal success as shipbuilders for Uncle Sam is told from an original angle, and The Architect's Future is discussed with marked frankness by Miles Colean, member of the A.I.A. committee on post-war relations with the government.

ARCHITECT AND ENGINEER (Established 1905) is published on the 15th of the month by The Architect and Engineer, Inc., 68 Post Street, San Francisco. President, K. P. Kierulff; Vice-President, Fred'k W. Jones; Secretary-Treasurer and Manager, L. B. Penhorwood; Advertising Manager, V. E. Atkinson, Jr.

Los Angeles Office: 403 W. 8th Street, Robert W. Walker, Manager.

Entered as second class matter, November 2, 1905, at the Post Office in San Francisco, California, under the Act of March 3, 1879. Subscriptions, United States and Pan America, \$3.00 a year; \$5.00 two years; foreign countries \$5.00 a year; single copy 50c. ARCHITECTS' REPORTS are published daily from this office, Vernon S. Yellop, Mgr.



★
★
★
★
★
★
★

THROUGH prosperity and peace, through adversity and war, we have always enjoyed greeting our friends. At this time we again extend our Season's Greetings, with the hope that your future will be bright.

Haws DRINKING FAUCET COMPANY

1808 HARMON STREET
BERKELEY, 3, CALIFORNIA

And Their Representatives

SAM ANDERSON, SEATTLE • JOSEPH TANET, NEW ORLEANS • HARRY E. CLARK, HOUSTON, TEX. • CLAUDE W. CORNELIUS, ATLANTA, GA. • ARTHUR S. HALL CO., WORCESTER, MASS. • G. H. KILLITS, PORTLAND, ORE. • WALLACE MITCHELL, EXPORT, SAN FRANCISCO • ERIC ROBERTS, SAN FRANCISCO • L. E. SHAFFER CO., LOS ANGELES • WALL & HOLLOWAY, PHILADELPHIA • REX WILLIAMS, SALT LAKE CITY.

RUNNING FIRE — by MARK DANIELS

OBSELESCENCE

Planning will not eliminate obsolescence. Nothing will until we discover eternal youth. All that can be hoped for is that planning will postpone obsolescence and slow it up to a speed that will enable us to prepare for it. Of course, preparing for obsolescence may be considered as only another form of planning but, as popularly used, it is coming to be considered a panacea for all the ills of age.

The widely publicized merits of city planning do not recognize, in print at least, that there are causes of obsolescence which cannot be controlled by planning. Styles and customs change, sometimes unexpectedly. A whole district may spring up in a residential area, dominated by the architectural style of some Frank-Lloyd-Wrightian enthusiast only to be abandoned in a short time to a weed-grown group of vacant houses. No method has yet been devised that will control architectural designs within the bounds of good taste and sound reason.

Nor is the adoption of a fad, or worse, style of architecture, the only stumbling block placed by the architect in the path of city planning. Frequently he accedes to his own or his client's ambition and designs a structure out of all reasonable size for its site, which is doomed to demolition some day to clear the path for proper city growth. While the city planner is occupied more with engineering than architectural problems it is by virtue of his work intelligently done, that the architect can help build a city that will be enjoyed and a joy to behold, for without the proper fitting no monumental structures can carry all the power of creation that went into the design. Here, as in so many other phases of preconceived plans, engineering and architecture should work hand in hand.

OVERHEARD AT THE SYMPHONY

They were in the slow moving exit jam just behind me.

"I studied that shiny, tall instrument that looks like a periscope in the wind section all through the program. It fascinated me," he said.

"It puzzled me, too. Must have been a double bassoon or a bass clarinet or maybe that double bass saxophone that Richard Strauss used in Rosenkavalier. The moderns use the double bass a great deal."

"Yes, I studied it all evening and I couldn't tell whether it was nickel or chrome plated."

PRISONERS OF WAR

Writing in the N. Y. Times for November 21, Mr. G. Alleston Cook, after reporting that the German prisoners of War have never tried to break out of the wired compound, goes on to say, "In their modern kitchens I saw piles of juicy hams, plenty of butter, teaks and sausages. No margarine is served them." Probably the only reason for the guards and the high wire fence around the compound is to keep the hungry OPA'ed citizens from breaking in.

• POST-WAR

"Post-War" has been a godsend to the publishers and advertisers. We have had "Post-War" Houses, "Post-War" Debts, "Post-War" Factories and "Post-War" Living. If the final peace is established to end war I don't know what the press will do to fill the gap when "Post-War" becomes "Post-Dated."

What will be the breath-taking difference between "Post-War" Living and "Pre-War" Living other than food supply and additional comforts? "Post-War" will undoubtedly mean much to the people of Europe but in the U. S. it is difficult to see how it can be a great upheaval resulting in a new epoch of civilization such as is implied in our press. Whether we will sprout wings or horns, eat less and drink more, or turn nudist, seems still in doubt, but I personally have a lurking suspicion that we will continue to live substantially as we have for the past few decades until we come to "Post-Civilization" Living, which may not be far away.

• INCREDIBLE

Apparently the radio advertisers are beginning to fall for the applause of their own mechanical clacques.

• THE LAST STRAW

I hate to do it, but the OPA should be told of one item of food that they have not rationed—salt. Here on the Pacific Coast most of our salt is taken from seawater, which in turn is under control of the government, for the time being, at least. This would eliminate the question of priority in the matter of ownership of raw material.

• PLANNED DECAY

It is questionable whether any people in the world, other than our own, ever deliberately planned quick decaying developments. We have done just that during the past few years under the guise of housing necessities.

The need for additional housing was a natural corollary of war but the use of short-lived materials was not. Nor was it necessary to surround the problem with restrictions and regulations that made it impossible for an architect to design structures that could be used for anything but housing after the emergency had passed. Neither did it seem necessary to establish a priority system that forced the people to build shanties in good residential districts.

But there is one saving grace in this planning in reverse—it may be the last needed condition to prove to some that city planning **MUST** be adopted by all.

• PRE-FABS AND LANDSCAPE ARCHITECTURE

One of America's leading architects once said, "If your house develops elements that don't look right, plant them out." It has been done, extensively and successfully. That should wipe out the last aesthetic objection to the prefabricated house. What is sauce for the goose is sauce for the gander in addition to which the landscape architects should join the advocates of prefabrication.

NEWS AND COMMENT ON ART

YOUNG INTERNATIONAL ARTISTS EXHIBIT AT THE DE YOUNG

Art of the War's Children is the fitting title of a new show featuring the de Young's Christmas Exhibition for 1943.

The exhibition has been organized by the Refugee Children's Evacuation Fund in London. There are paintings and drawings by youngsters, many of whom came from countries under the yoke of Hitler, including children from Germany and Austria who have found refuge in England. British children evacuated from raid-ridden areas, young artists from 6 to 17 years from Belgium, Sweden, Poland, Spain, Denmark, Czechoslovakia, Holland, Yugoslavia, Norway, France, Switzerland — also young Indian, Chinese, Russian, and even Japanese nationals are represented. Some of these children have described the war's experiences they so vividly remember; others have chosen to forget in the joys found in new and happier environments. The Spanish children, many of whom have literally never known anything but exile from a ravaged homeland, still can use their brushes to enjoy the lively dances and the bullfights of Madrid.

Art of the War's Children was originally shown in London, was then exhibited in various English cities before being sent to America. Its showing in San Francisco throughout the current month is its first appearance in the United States. From here, under the auspices of the Joint Anti-Fascist Refugee Committee, it will travel throughout the country before returning to Britain.

Another interesting exhibit at the de Young this month is a collection of oils by a widely-known San Francisco artist, Jane Berlandina. Born in France where she studied and exhibited before coming to the United States, Miss Berlandina has achieved recognition in this country as a painter, teacher and stage designer. Local opera and ballet enthusiasts will remember her beautiful sets for the productions of "Die Rosenkavalier" and "Pelleas and Melisande" and visitors will recall her striking murals at the Golden Gate International Exposition. She recently held a one-woman show at the Bignou Galleries in New York. Her exhibit at the de Young includes oils and watercolors and also two "portable murals," an invention of the artist's which have never been shown before.

MARK TWAIN AND OTHER SCULPTURE BY GLADYS BUSH

Commenting on Gladys Bush's recent exhibition of sculpture at the Dalzell Hatfield galleries in Los Angeles, "Art Digest" for November prints:

"Among the exhibits is her bust of Mark Twain, a bronze, first cast of which has been purchased for the permanent collection of the Metropolitan Museum. Miss Bush had all the Clemens family photographs of Mark Twain to work from, and the assistance of Madame Clara Clemens Gabrilowitsch, Mark Twain's daughter, who was present during the execution of the bust.

"When the bust was completed Madame Gabrilowitsch wrote of it to Miss Bush: 'I looked at your bust of my father and saw his wonderful spirit shining through the quickened clay. It is a

veritable miracle that in this earthly medium you have succeeded in revealing the innermost soul of Mark Twain. The salient characteristics of his personality you have captured with amazing perfection—his intelligence, a certain majesty of sincerity that was his, and even a touch of humor.'"

Other important sitters for Miss Bush's portrait busts were Arthur Rodzinski, Lotte Lehmann, Susan M. Dorsay, Helen Wills Moody, Nina Gabriłowitsch, Dorothy Arzner, Ernest Dupont, Mrs. Edward Small Moore, Mitchell Leisen, Mae West, George A. Hormel, Marco Stuart.

Gladys Lewis Bush is a direct descendant of Colonel Fielding Lewis and Betty Washington Lewis, only sister of George Washington.

Also exhibiting in the Hatfield galleries last month was Loren Barton, who showed portraits, figure paintings and landscapes in oil and watercolor, including a series of industrial watercolors of the Kaiser steel mills at Fontana, California.

SON OF DISTINGUISHED ARTIST NOT VERY WELL INFORMED

Under the heading, "A Prophet Without Honor," the Associated Press reported from Kansas City the following:



THE LONG WAIT

JANE BERLANDINA

This oil painting of a man and boy in theatrical costume waiting for their cue to enter, is one of a series of "Back Stage" scenes typifying the work of the vivacious French-born artist, teacher and stage designer, whose watercolors and easel paintings are being shown at the de Young Museum this month.

AN EVER CHANGING WORLD



LANDSCAPE FROM A DREAM

PAUL NASH

This abstraction is representative of the work of one of the founders and leaders of the modern movement in British art. The painting is shown at the de Young Museum.

"T. P. Benton, son of Thomas Hart Benton, noted artist, was doing fine in an intelligence test at Kansas University, where he is a freshman, until they asked him—

"What widely-known artist won the first cash prize in the Metropolitan Museum of Art show last year?"

"That stumped him. He asked his dad that night when he got home.

"I won it," the elder Benton replied."

GERMANS LOOT PRICELESS WORKS OF ART IN ROME

Robert Dowson, United Press staff correspondent, is quoted in the World Telegram of Oct. 7, under a London date line, as having received word that the Germans have embarked on an unparalleled campaign of looting in Rome—confiscating priceless paintings, manuscripts and other art treasures as Allied armies draw nearer the Italian capital. Wrote Dowson:

"Nazi squads were said to be stripping Roman palaces, museums and private homes of masterpieces on a scale dwarfing their sacking of Paris and Warsaw. The London Daily Mirror reported that several trains laden with pictures, books, manuscripts and statuettes already have left for Berlin. Some, however, were derailed and burned by saboteurs.

"Reichmarshal Goering frequently has drafted minute lists of valuable art for transfer to Germany as soon as occupation of an historic city is completed.

"First reports indicated that the Nazi looting was confined to the Italian part of Rome. Vatican City apparently has not been touched."

BENDER COLLECTION HOLIDAY FEATURE AT S. F. ART MUSEUM

The **Bender** collection—oils, sculpture, watercolors, drawings and prints—are the holiday attraction this month at the San Francisco Museum of Art. Some of the works are familiar, some appear for the first time. Much of the collection has not been shown for several years, for it is so large that only a portion may be hung at one time.

FRANCIS DE ERDELY EXHIBITS WAR DRAWINGS AT DE YOUNG

A concrete result of the recent "Meet the Artist" exhibition at the de Young Museum, is the showing for the first time on the West Coast of the work of one of the most dynamic artists represented in that show, Francis de Erdely, Hungarian-born artist, who studied, taught and painted for many years in Europe and who is now living in this country.

Included are 27 oils, the same number of drawings, and a special group which the artist calls his "cycle of war drawings." The same bold, free style in which Mr. de Erdely's powerful self-portrait was painted, is evident in his landscape, still lifes and figure studies.

EXHIBITION OF RELIGIOUS ART

Now at San Francisco Museum of Art and continuing until January is an exhibition of religious art, consisting of Spanish, French, Italian, German and Russian carved religious figures; also a few candlesticks, plaques, furniture and paintings—from the 14th to 18th centuries.



THE FLOWER VENDOR

Diego Rivera

The **Flower Vendor** has become the best known painting in the Albert M. Bender Collection at the San Francisco Museum of Art. It has been reproduced with unusual fidelity of color in a print sold widely throughout the United States, while a smaller color reproduction appeared on the cover of the Book-of-the-Month-Club News recently.

RENOIR EXHIBIT APPEALS TO HOLLYWOOD FILM COLONY

The Renoir exhibition, recently held in the Ambassador Hotel in Los Angeles, was unique in many ways. The French master has long been a prime favorite with the motion picture colony, and the show was offered largely for their pleasure. The paintings included such notable canvases as "Baigneuse a Guernsey," "Chapeau Fleurie," "Jeune Femme au Chien" and "Roses dans un Vase Bleu," as well as several important loans from West Coast collectors.

A special feature was the display of paintings and sketches given by Renoir to his most famous model, Gabrielle, who is now Mrs. Conrad Slade, wife of an American artist. Gabrielle came to live with the Renoir family in the 1890's and was with them until the artist's death in 1919. Renoir painted her from childhood to full womanhood. Mr. and Mrs. Slade live in Hollywood and it is through their generosity that these intimate paintings were shown to the public.

ANNUAL INTERNATIONAL TEXTILE EXHIBITION, WEATHERSPOON GALLERY

Weather Spoon Art Gallery, Greensboro, N.C., announces its annual international textile exhibition March 1 to March 28, 1944. Entry blanks for exhibits must be received by February 1; exhibits two weeks later.

Jury of Award will consist of (Chairman) Mary Leath Stewart, Assistant Professor of Art, The Woman's College of the University of North Carolina, Greensboro; Dorothy W. Liebes, textile designer, National Director Art and Skill Projects, American Red Cross, San Francisco; Meyric R. Rogers, Curator of Decorative Arts and Curator of Industrial Arts, The Art Institute, Chicago.

With the jury alone will rest the decision as to which textiles shall be accepted or rejected. Each decision will be based upon the artistic merit of the entry under consideration.

CALIFORNIA CHAPTER OPENS GALLERY IN SAN FRANCISCO

Taking over a penthouse gallery in the heart of San Francisco's shopping district, the California Chapter of the American Artists Professional League recently opened as a co-operative venture for the benefit of chapter members. The gallery is at 133 Geary Street, less than two blocks from Union Square.

During American Art Week an invitation show of the work of better known members was held. Since then all members have been entitled to show from one to five pictures, depending on the space available. A moderate fee is charged.

CONTEMPORARY BRITISH ART ON VIEW AT DE YOUNG MUSEUM

A new major exhibition, organized by the British Council in London, went on view at the de Young Museum November 18th. Comprising over 150 oil paintings, watercolors, drawings and prints, the show is being circulated throughout the United States by the Toledo Museum of Art, where it was recently shown to the American public for the first time. Representative and well-known names in

the modern British art scene have all been assembled for a limited showing.

ART BOOMS IN BRITAIN

That terrible summer day in 1940, when the French Army—termed at the time of Umbrella Diplomacy the greatest in Europe—broke before Hitler's Panzers, the war was deposited neatly in Britain's front yard. The survival of our way of life was up to England alone, and England met the ordeal with bulldog courage. Her people did not waste valuable time asking "what are we fighting for?"—they knew, the hard way. Which brings me to the point of this "comment." What did the embattled English do about art?

Perhaps we Americans, still debating the value of art in an all-out war, will be helped to a decision by the following C.T.P.S. dispatch datelined September 20 from London: "A great boom in works of art is indicated by sales at the summer exhibition of the British Royal Academy, which has just ended after the most successful season since 1936. During the course of the exhibition, 405 works were sold for \$56,105."

Works sold and the total purchase prices in the five war years are:

1939	187 for	\$38,720
1940	137 for	36,310
1941	152 for	20,933
1942	237 for	32,555
1943	405 for	56,105

If the above figures mean anything, it is that the English hunger for art and beauty, even as they face the grim reality of war. To them, it is evidently one of the indispensables.—Art Digest.

CORROSIRON
MADE IN U.S.A.
U. S. REGISTERED TRADE MARK

an acid resisting alloy for

**Pumps • Valves • Chemical
Coatings • Drain Pipe & Fittings**

ARCHITECTS AND ENGINEERS
ENGAGED IN WAR HOUSING
AND POST-WAR PLANNING MAY
CONSULT OUR ENGINEERING
DEPARTMENT WITHOUT
OBLIGATION

☆

PACIFIC FOUNDRY COMPANY LTD.
Engineers and Metallurgists
3100 - 19th Street
SAN FRANCISCO

NEW YORK SAN FRANCISCO LOS ANGELES

You can't beat
STEEL
for strong, safe
construction

FROM the sturdy, deep-driven bearing piles upon which a building stands to the very top of the structural steel framework, steel has no rival for strength and performance, for endurance under stress, for speed and economy in erection. It is an axiom: The more steel used, the stronger and safer the building.

Here are some of the reasons why you can't beat steel for building construction.

- 1. Steel won't burn!** The more steel you use in building construction and equipment, the more you reduce fire hazard.
- 2. Steel combines strength and lightness.** Its high strength-weight ratio has established steel as the ideal material for structural uses. This same basic advantage makes it the natural choice for many other applications throughout the modern building.
- 3. Steel is adaptable.** Because it is economical and easy to fabricate, steel is well suited to the requirements of functional design and building modernization.

- 4. Steel is movable and salvageable.** Prefabricated Steel Structures are easy to dismantle and move to new locations.

Many types of cold-formed sections have been developed for prefabricated construction. Cold-forming, for instance, makes possible sound-proof wall panels—easy to erect, easy to move—providing maximum flexibility of interior arrangement.

Building modernization is simplified by wall facings, wainscoting and fixtures made of *Porcelain on Steel*, in a variety of colors, as well as *stainless steel* for mouldings, trim, panels and storefronts.

Steel ceilings, floors, windows, doors, frames, baseboards, etc., all contribute to safety and low-cost upkeep. When stairways, marquees, shower stalls and toilet partitions are built of steel, they last longer and reduce fire hazards. In furniture and equipment, too, steel provides durability, lightness, compactness and attractiveness.

Just as the mechanisms for war have advanced in efficiency far beyond our widest expectations, so have advanced the improvements in steel which made them possible. Amazing are the new uses to which this versatile material can be put.

★ *Steel as a building material is as modern as tomorrow* ★

COLUMBIA STEEL COMPANY

SAN FRANCISCO · LOS ANGELES · PORTLAND · SEATTLE · SALT LAKE CITY—*Pacific Coast Distributors*

American Bridge Company · American Steel & Wire Company · Carnegie-Illinois Steel Corporation · National Tube Company



UNITED STATES STEEL

WHAT'S ON YOUR MIND?

Letters to the Editor

ENGINEER-ARCHITECT
Editor,

Architect and Engineer:

Apobos to your recent articles relative to the status of the architect and the engineer, I am sending the attached clipping from the Draftsman, as it seems to confirm, in the main, a growing feeling that the professions are becoming more and more inseparable and that our post-war building revival will see closer affiliation of the two.

W. ADRIAN

Part of the clipping referred to follows.—Editor.

"For the past seventy-five years a gap has been widening between the engineer and the architect. There was a time when the titles were interchangeable and all but synonymous, but specialization has driven in a wedge that has resulted in an all but complete divorce.

"The history of the doctor and the surgeon is more or less parallel with that of the engineer and the architect. Nevertheless, specialization here also is 'making little ones out of the big ones,' for we are now getting the eye doctor, the heart doctor and even the corn doctor where once we had the general practitioner who did everything.

"The basic training of the medical doctor bears about the same relation to that of the surgeon as does that of the engineer to that of the architect or vice versa. It is that of learning to think logically along certain scientific lines. There is no difference in the method of thought learned in architectural training and the method learned in engineering training. The addition of other factors in subsequent experience or further training causes the ultimate divergence in practice.

"We are prone to think of all forms of engineering as either structural or mechanical but problems in enameled metals, plastics, paints, hardware and innumerable other elements of construction are calling for the development of a type of engineer and architect where they were once left to the general practitioner.

"At any rate we are convinced that there is only the thin line of aesthetics dividing engineering from architecture and that there is no reason why the qualifications for both cannot be under one brain pan."

HOME PLANNERS' INSTITUTE

Editor,

Architect and Engineer:

... In reading the October issue of Architect and Engineer, I was pleased indeed to find on Page 34 some reference to the Home Planners' Institute which is now being tried out in Portland, Oregon. It may interest you to know that four classes of 50 members each have already been organized and by the middle of next week all

of these classes will have had their first lecture on selection of the homeseite, the speaker being Chester A. Moores, past president of the Portland Realty Board, vice-chairman of the Housing Authority of Portland and a member of the City Planning Commission.

The next subject to be considered by the home planning classes will be house design, the lecturers in which will be outstanding Portland architects selected by the local Chapter of the A.I.A. It occurs to me that you might be interested in having a short article prepared by one of these architects, explaining the Home Planners' Institute from the point of view of the architects.

Very truly yours,

R. T. TITUS,

Director of Trade Extension, West Coast Lumbermen's Association,

Portland, Oregon,

November 6, 1943.

An article on the subject is being prepared by Architect Roi Morin for publication next month.—Ed.

THE MIRACLE HOUSE

Editor,

Architect and Engineer:

The die-hards who scoffed "get a horse" every time an early automobile broke down are at it again. They don't believe in "fairy stories" or in "miracle houses." Like the harness makers of 1902, they want to stick to "the good old ways."

The true Miracle House of tomorrow will be measured by the same yardstick: can it be built to sell at a price the ordinary man can afford to pay? If not, it will be no miracle but just another luxury, even if it has movable walls that will change the size and shape of rooms, air conditioning that will reproduce any sort of climate at the touch of a button, and electrostatic equipment that will do all the housewife's dusting and cleaning.

For the building industry, the real miracle will be the production of substantial, attractive, durable homes within reach of the income of every able-bodied working man.

There are many arguments about how houses can be built, what material can be used, who will build and sell them. All are beside the point. The success of the low cost house will depend, not on whether it is built of this material or that, or just how it is made, but whether it can be built to sell at a price the millions who have never been able to own a home can then afford to pay.

If a good, attractive low cost house can be built, the building industry can reasonably expect to double the size of its market. These extra 900,000 homes will require the labor of, at a guess, 1,500,000 workers for

N. CLARK AND SONS

Manufacturers of

Quality
Architectural
Clay Products

During this stage of the war, our principal energy is to manufacture products required by the various war agencies. We still can supply some pre-war materials for civilian needs.



401 PACIFIC AVENUE
ALAMEDA, CALIFORNIA
San Francisco • Los Angeles
Salt Lake City • Portland

Independent Iron Works

Structural Steel
Ornamental Iron
Steel Service Stations
Steel Tanks
Standard Steel Mill Buildings
Bridges

821 Pine Street

Oakland

construction and 2,000,000 workers in manufacturing plants, making a total of 3,500,000 extra workers provided with jobs by low cost housing alone.

There are those who say that it will take a miracle to build and sell such a volume of houses at that price. These are days of miracles—ships built in days instead of months, radar that "sees" unerringly through fog and darkness, atoms cracked, the riches of coal-tar chemistry, huge bombers flowing off mass production lines, helicopters that hover stationary and even fly backwards.

I sincerely believe that the production of the low cost house will be another such miracle.

BROR DAHLBERG

Chicago, Ill.

The New Weapon Against Fire IS **FIREPEL "S"**

A TIMELY CHEMICAL ACHIEVEMENT FOR THE TREATMENT OF UNFINISHED INTERIOR WOOD AFFORDING A PRACTICAL METHOD OF SUCCESSFUL FIRE RETARDATION

IN
Homes

Industrial Plants - Schools

THE ONLY FIRE RETARDANT COATING MATERIAL ON THE MARKET LISTED AND APPROVED BY

UNDERWRITERS LABORATORIES INC.

DISTRIBUTED BY



GUNN, CARLE & CO.

20 POTRERO AVE.
SAN FRANCISCO
Underhill 5480

BUILD **NOW** WITH KRAFTILE!

Look at these 9 big advantages
Kraftile Wall Units offer:

1. Priority-free!
2. Non-critical material!
3. Immediate delivery!
4. No limit on quantity!
5. Kraftile Wall Units replace steel and other gone-for-the-duration materials in load-bearing walls and partitions. These units have 10 times the State-required stress resistance.
6. Kraftile Wall Unit partitions go up in about one-third the time it takes for ordinary frame construction. One craft can handle the whole job.
7. No finishing required—these wall units come pre-tiled on one or both sides.
8. Upkeep cost ended. Kraftile Wall Units are scratchproof, waterproof, fireproof, stain-proof, can take the heaviest abuse.
9. Costs are surprisingly low.



For more information,
phone or write today to

KRAFTILE
NILES, CALIFORNIA

Index to Advertisers

*Indicates Alternate Months

A	
ALADDIN Heating Corp.....	*
AMERICAN Rubber Mfg. Co.....	42
ANDERSON & Ringrose.....	46
B	
BASALT Rock Company.....	44
BAXTER & Company, J. H.....	10
C	
CASSARETTO, John.....	46
CLARK, N., & Son.....	8
CLINTON Construction Company.....	43
COATES, Leonard, Nurseries.....	45
COLUMBIA Steel Company.....	7
CROCKER First National Bank.....	45
D	
DINWIDDIE Construction Company.....	46
F	
FORDERER Cornice Works.....	43
FULLER, W. P., Co.....	11
G	
GUNN, Carle & Company.....	9
H	
HANKS, Inc., Abbot A.....	45
HAWS Drinking Faucet Company.....	2
HERRICK Iron Works.....	46
HOGAN Lumber Company.....	43
HUNT, Robert W., Company.....	45
HUNTER, Thos. B.....	46
I	
IMPERIAL Brass Mfg. Co.....	*
INCANDESCENT Supply Co.....	46
INDEPENDENT Iron Works.....	8
J	
JENSEN & Son, G. P. W.....	46
JOHNSON Company, S. T.....	*
JUDSON Pacific Company.....	43
K	
KAWNEER Co.....	*
KRAFTILE Company.....	9
M	
MATTOCK, A. F.....	44
MULLEN Mfg. Co.....	45
N	
NORTHERN California Electrical Bureau.....	32
P	
PACIFIC Coast Gas Association.....	*
PACIFIC Foundry Company, Ltd.....	6
PACIFIC Manufacturing Company.....	44
PACIFIC Paint and Varnish Company.....	40
PACIFIC Portland Cement Company.....	10
PARAMOUNT Built-In Fixture Company.....	*
PARKER, K. E.....	2nd Cover
R	
REMILLARD-Dandini Co.....	44
REPUBLIC Steel Corporation.....	44
S	
SALL Mountain Company.....	38
SANTA Maria Inn.....	44
SIMONDS Machinery Company.....	44
SISALKRAFT Company.....	44
SOULE Steel Co.....	Back Cover
STANLEY Works, The.....	*
T	
TORMEY Company, The.....	45
U	
U. S. STEEL Company.....	7
V	
VERMONT Marble Company.....	44
W	
WASHINGTON - Eljer Company.....	*
WESTERN Asbestos Company.....	38
WOOD, E. K., Company.....	42
WAR Bonds.....	3rd Cover
Z	
ZOURI Store Fronts.....	*

TEAMWORK for SECURITY

THERE IS NO SUBSTITUTE FOR A
HARDWALL PLASTER JOB

EMPIRE
GYPSUM PLASTER

STANDARD
GYPSUM PLASTER

RENO
GYPSUM PLASTER

PACIFIC
PORTLAND CEMENT COMPANY

FOR SOUND CONSTRUCTION

BAXCO

CHROMATED ZINC CHLORIDE

CZC

PRESSURE TREATED LUMBER

- **PROTECTS AGAINST DECAY
AND TERMITE ATTACK**

Specify it in your home

Available through Lumber Dealers

LOS ANGELES

601 W. 5th Street
Phone MIchigen 6294

SAN FRANCISCO

333 Montgomery Street
Phone DOuglas 3883

J. H. Baxter & Co.

AGENTS FOR WEST COAST WOOD PRESERVING CO. SEATTLE, WASH

IN THE NEWS

BRIDGE EXPERT

E. L. Durkee, who recently entertained the structural engineers of Northern California with a graphic description of the Rainbow Bridge at Niagara Falls (see page 31), has been identified for a number of years with the design and erection of some of the major steel bridges and structures in the United States and other countries. For his outstanding professional achievements in the field of structural engineering, Mr. Durkee received the Construction Prize Award of 1939 by the American Society of Civil Engineers.



DURKEE

At present Mr. Durkee is in charge of the erection of a 21,000-ton floating steel drydock at the Alameda, California, plant of the Bethlehem Steel Co., where he is permanently located as Resident Engineer.

A FLOOR SALESMAN

Chet Cook, for the past ten years with the Sisalkraft Company, San Francisco, is now associated with Ed Banta and the H. H. Robertson Co., 689 Mills Building, San Francisco.

Mr. Cook, after leaving the University of Illinois Engineering School, worked out of the Chicago office of the Sisalkraft Company and later out of the New York office. Five years ago he came to the Coast to cover the Northern California territory. He will be representing the full Robertson line of Q floors and panels, Robertson protected metal ventilation units and skylights.



COOK

Cook is an active member of San Francisco Chapter, Producers' Council.

UP AND UP.

Jay E. Jellick, recently named Sales Manager of Pacific Portland Cement Company, by President J. A. McCarthy, has enjoyed an enviable record of executive responsibility ever since he was graduated at the University of Idaho with the degree of civil engineer. That was back in 1908.



JELICK

One of Mr. Jellick's first positions was with the Department of Interior on construction work at the Moqui Indian Reservation in Arizona. Later he was with the Washington Water Power Company, Spokane, then with the Los Angeles County Road Department as Senior

ARCHITECT AND ENGINEER

resident Engineer. He also served as District Engineer for the Wyoming State Highway Department and from 1921 to 1941 occupied various positions, from Field Engineer to District Engineer and Manager, with the Portland Cement Association.

Mr. Jellick was Manager of the San Francisco office of the Portland Cement Information Bureau when appointed to the position of Sales Manager of Mr. McCarthy's company. Jay belongs to the aggressive type of executives and is well liked by the leaders of the building industry in the San Francisco area.

POST-WAR SCHOOL BUILDINGS

Indications are that school architects are going to have plenty of work after the war. Several leading school architects are already discussing the advisability of forming a combination of working executives, consisting of architect, engineer and contractor. This type of working personnel appears destined for a strenuous tryout.

School districts throughout California already have set aside \$9,000,000 for new school construction in the post-war period, according to Dr. Walter F. Dexter, State Superintendent of Public Instruction.

Factors making new construction necessary, Dr. Dexter said, are increased enrollment due to population gains, expanded plant needs which cannot be met during the war emergency and "new types of educational services that will be carried on after the war."

Dr. Dexter said several school districts already have sought the assistance of the State Division of Schoolhouse Planning on contemplated projects. They include Carmel, Fresno, Fullerton, Kern County, Modesto, Monterey, Needles, Redlands, San Bernardino, San Mateo and Stockton.

NEW CODE ON PREFABRICATION

Besides adopting a new Code on prefabricated construction, the Pacific Coast Building Officials' Conference, at their 21st annual meeting in San Francisco, adopted the following resolution:

"Whereas war conditions have necessitated the construction of many substandard types of temporary housing facilities by government agencies, resulting in depreciation of property values and in many cases creating a serious fire hazard, the Conference recommends to all interested government agencies the removal of these substandard buildings immediately after the war emergency."

Duncan E. Kennedy, building inspector of Victoria, B.C., who has been president of the Conference for the last two years, was elected president for the coming year.

RETURNS TO SAN FRANCISCO

Donnell E. Jaekle, architect, has moved back to San Francisco from Los Altos. His new address is 731 North Point Street, San Francisco.

*Architects
...Engineers*

In these days of re-formulations, due to raw material shortages and priorities, it's more important than ever to seek reliable counsel and use only dependable products. Fuller research has long been preparing for today's emergency needs. Our technicians will gladly help you.

"CALL FULLER"
ON ALL YOUR PAINT PROBLEMS



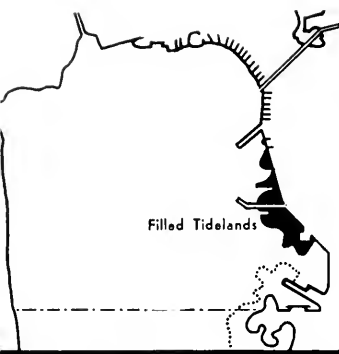

560 ACRES OF NEW INDUSTRIAL AREA
 The level shoreline area between Hunters Point and the Embarcadero constitutes a logically established industrial district. Five hundred and sixty acres of valuable new land can be created by filling the tidelands.

CONTROL OF EROSION AND ACCRETION
 Land slippage injures scenic drives and walks in Lincoln Park; erosion and sand accretion on the Great Highway are costly. Scientific surveys are needed as a basis for economical corrective measures.

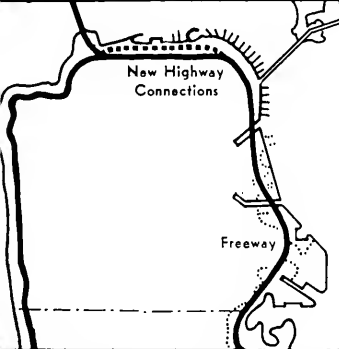

A 23-MILE CONTINUOUS SHORE DRIVE
 Protection and improvement of the Great Highway along the ocean; new roadway connections along the Golden Gate, and a new Freeway on the Bay Shore are proposed to complete a useful traffic artery and notable scenic highway around San Francisco.

REHABILITATION OF FERRY BUILDING AREA
 Remodeling of the Ferry Building, land clearance and street revision will provide a Water Gate to the City; a street car and bus terminal; a tourist-commercial center, with shops, exhibits, recreation facilities, offices, and docks for sight-seeing and fishing trips.

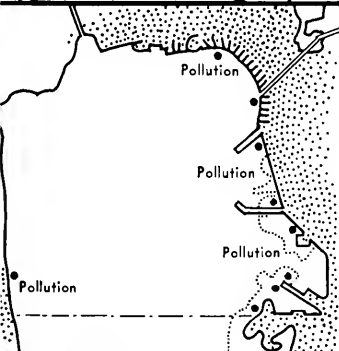

ELIMINATION OF SHORELINE POLLUTION
 San Francisco and neighboring cities are polluting the Bay, creating a health hazard and preventing full use of shoreline properties. Nearly 46,000,000 gallons of untreated sewage are discharged daily by this City, spoiling its own beaches and yacht basins. A complete system of sewage treatment plants is proposed as a post-war project.

NEW RECREATIONAL FACILITIES
 New beaches, shore parks and picnic areas; walks, bicycle paths, observation points; improved parking lots, and more accessible and attractive tourist facilities can be created along the shore. Land is generally available; a comprehensive plan for its ultimate development is now provided.

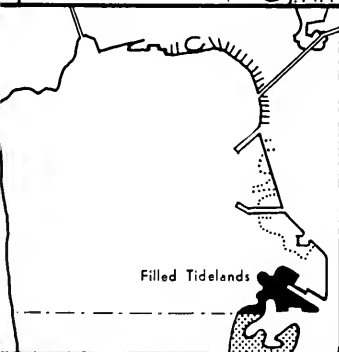

380 ACRES OF NEW RESIDENTIAL LAND
 Filling of shallow tideland areas near Candlestick Point will provide new land for a well-planned residential district on the Bay. Small homes here would be within walking distance of the Navy Yard and other places of employment, and close to the protected waters and sunny recreation areas on the Bay Shore.

NEW HARBORS FOR SMALL BOATS
 The Marina Yacht Harbor would be doubled in capacity, Aquatic Park developed for boats, and the Ferry Building transformed as a pleasure craft landing. Facilities for boat building, rowing, and small sailboats would be located near the new Hunters Point residential areas.

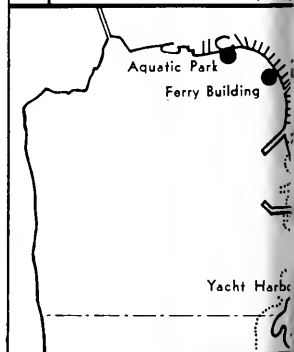
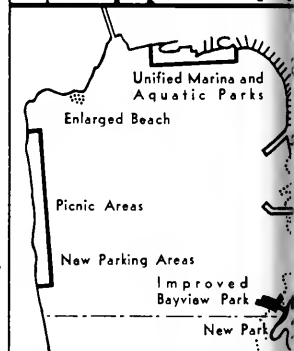
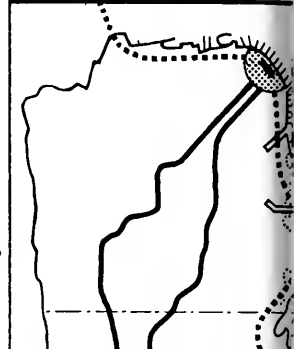
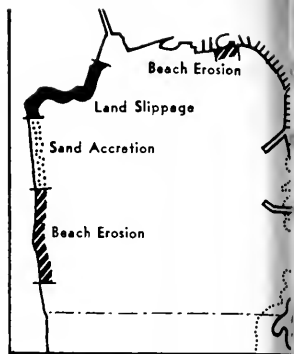

BASIC PROPOSALS OF SAN FRANCISCO'S SHORE LINE PLAN

POST-WAR DEVELOPMENT PLAN FOR SAN FRANCISCO WATERFRONT

by M. DEMING TILTON*

The San Francisco Planning Commission has completed and is presenting its first technical report to the Mayor, the Supervisors, and department heads. The report outlines a tentative post-war development plan for the entire waterfront of the city.

The Master Plan which the City Planning Commission is now making is to be based upon a series of such reports. The first preliminary studies will deal with districts or areas, such as the business districts, industrial and warehouse areas, blighted and depressed neighborhoods and residential sections. Other reports will be concerned with public improvements such as streets and highways, housing, parks and recreation areas, street car and bus service and railroad transportation. Because of the industrial, scenic and recreational importance of the waterline of the city, the planning of these areas has had initial attention.

GENERAL BENEFITS OF MASTER PLAN

The Master Plan in its final form will be composed of many lesser plans properly fitted together. Single projects, such as have been developed in the study of shoreline areas, will have greater value because they are part of a comprehensive scheme designed to bring improvement to the entire city.

The Shoreline Plan and others of similar type, are expected to have the following general benefits:

(1) The competitive position of San Francisco in the fields of industry, business and transport will be improved.

(2) Conditions under which people live and work in the city will be better.

(3) Opportunities will be provided for investment of both public and private funds on thoroughly sound improvement projects.

The basic purpose of the Shoreline Plan is the orderly re-establishment of peace-time enterprise and the continued employment of the working forces upon whom the city de-

pends for normal, healthy community life.

The twenty-three mile shoreline of San Francisco is a priceless natural asset. It provides advantageous sites for transportation and industry, areas for health-giving recreation and the enjoyment of scenery, and access to sunshine and fresh air. Because of the great social and economic importance of shoreline areas, their orderly, systematic improvement is a major concern of the city. The waterfront of San Francisco is not yet a finished public improvement. It cannot produce maximum returns and benefits until all its exceptional qualities have been fully capitalized.

BASIC PROPOSALS OF SHORELINE PLAN

Briefly stated, the major proposals of the Shoreline Plan (see cut) are as follows:

1. Shallow tideland areas on the Bay, to the extent of about 730 acres, would be filled for industrial, transportation, and warehouse and storage purposes.

2. Sewer projects for the elimination of Bay pollution should be advanced, and listed as one of the major post-war reemployment projects.

3. Tidelands South of Hunters Point, to the extent of approximately 350 acres, could be filled to provide high quality homesites for employees of the Hunters Point Navy Yard and, if necessary, additional industrial areas.

3. A continuous twenty-three-mile Shoreline drive should be developed, the section along the Bayshore to be a Freeway providing direct high-speed access to the gates of the new Navy Yard.

5. The Ferry Building and its surrounding area must be modernized and improved, to provide the City with an impressive watergate, a modern street car and bus station at the terminus of Market Street, and a tourist exhibit and recreation center.

6. New recreational facilities can be provided along the Ocean, Golden Gate, and Bay shores, on land now largely owned by the City and on new land to be created by filling tide-

* Director of Planning, San Francisco City Planning Commission.

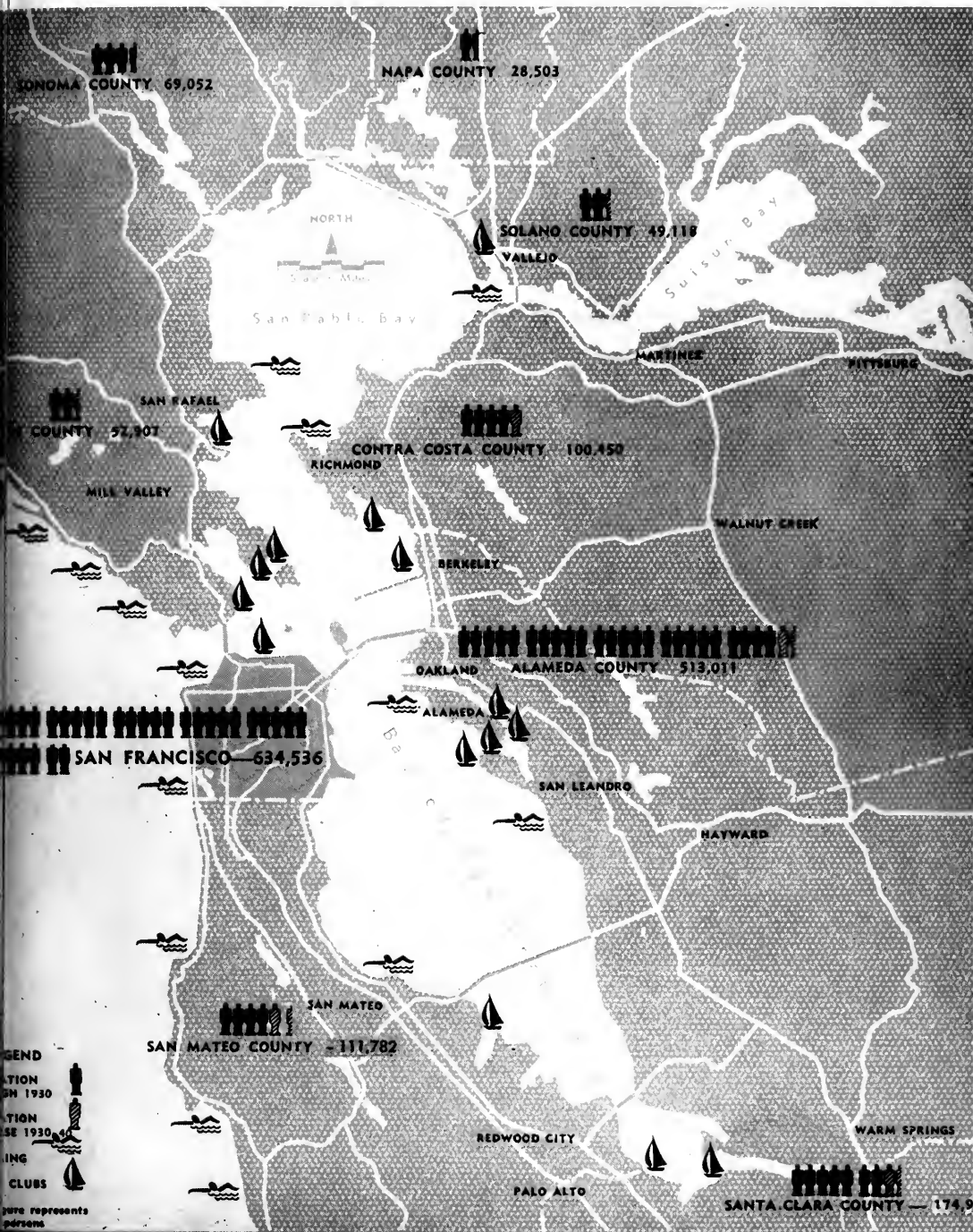

REGIONAL RELATIONSHIPS

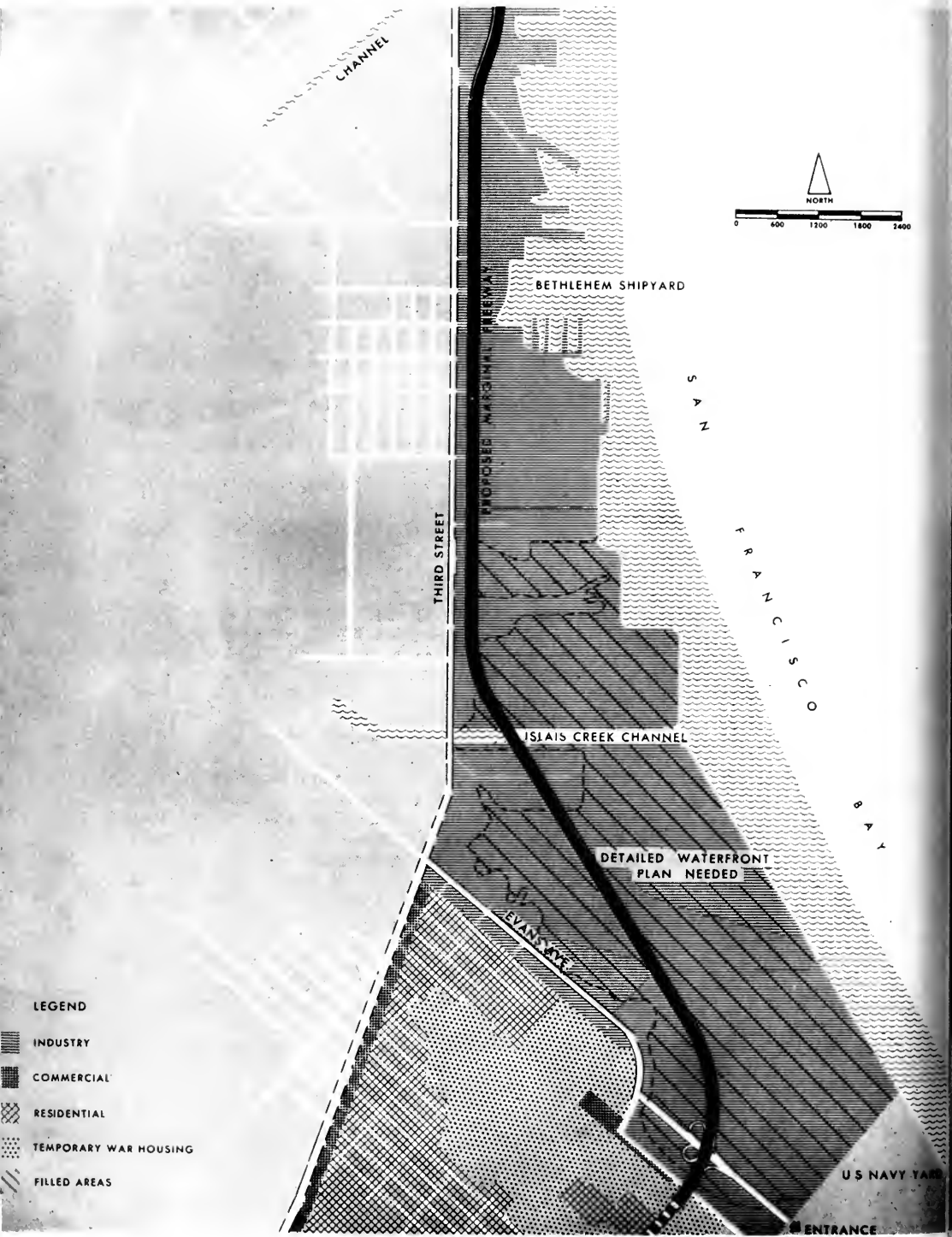

PROPOSED WATERFRONT PLAN (North of Hunters Point)

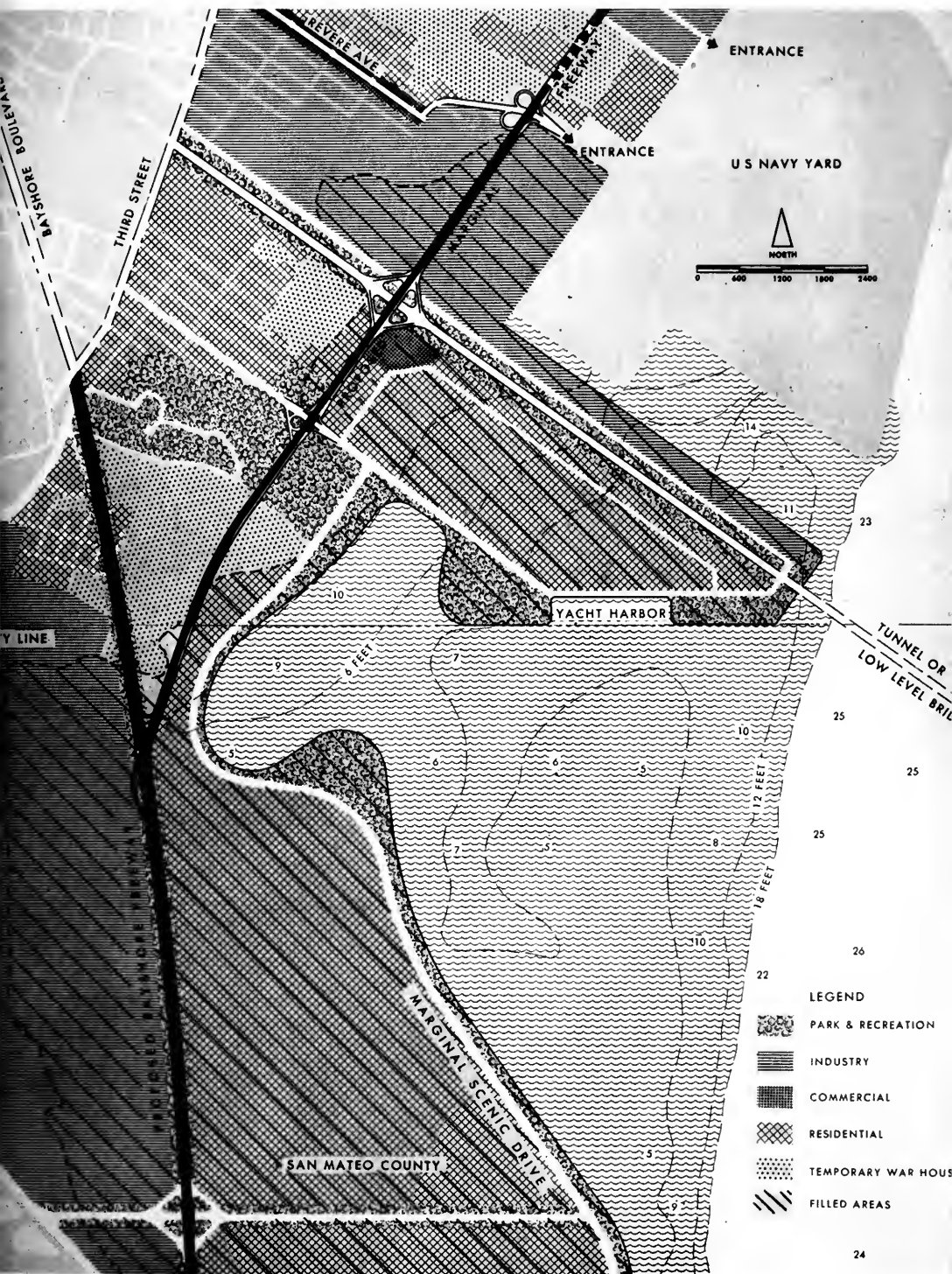

PROPOSED SOUTH BAY SHORE PLAN (South of Hunters Point)

LEGEND

-  PARK & RECREATION
-  INDUSTRY
-  COMMERCIAL
-  RESIDENTIAL
-  TEMPORARY WAR HOUSE
-  FILLED AREAS

SAN FRANCISCO
CITY AND COUNTY

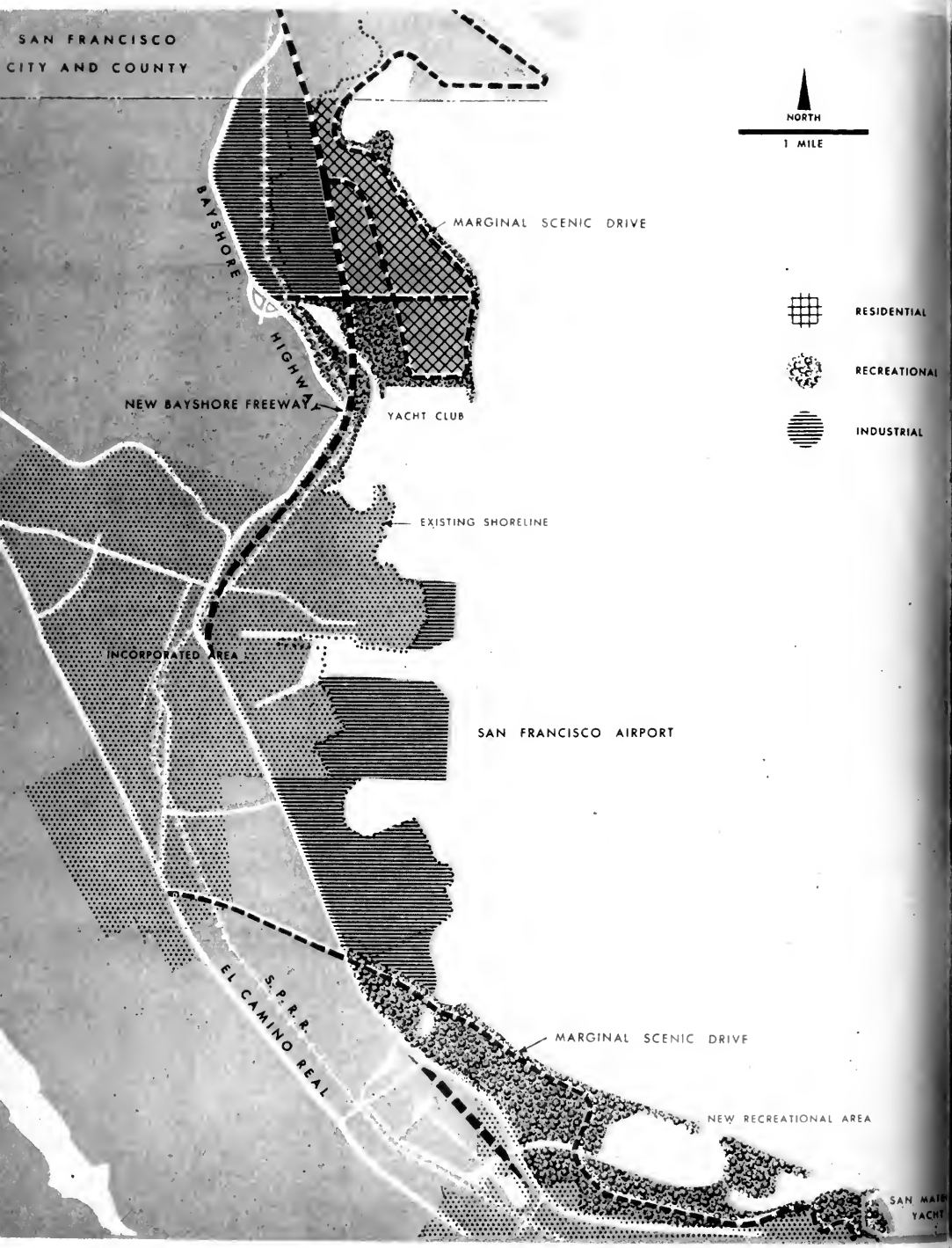

PLAN FOR COORDINATED BAY SHORE DEVELOPMENT
(Prepared by the San Mateo County Planning Commission)

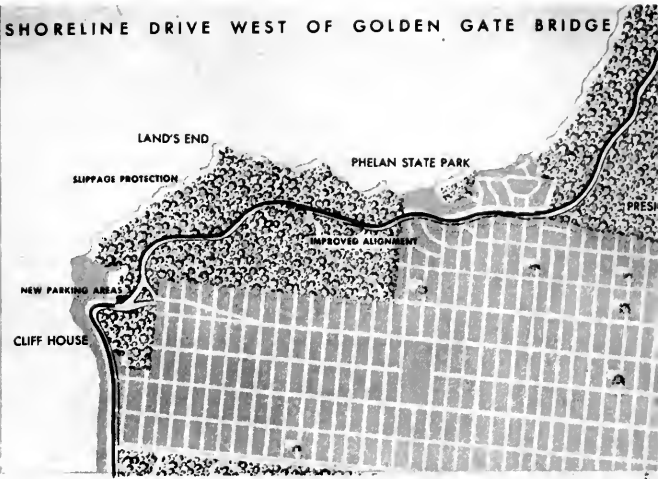

YACHT HARBOR - AQUATIC PARK AREA

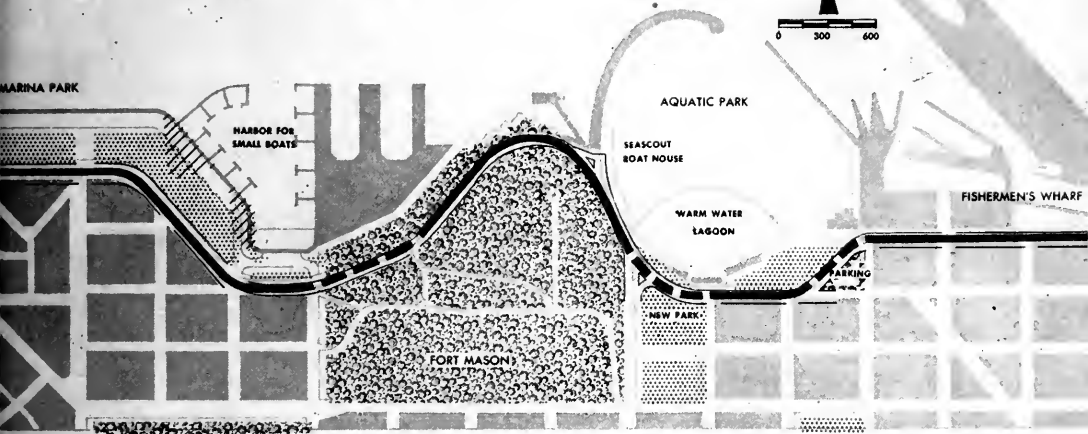

SHORELINE DRIVE EAST OF GOLDEN GATE BRIDGE

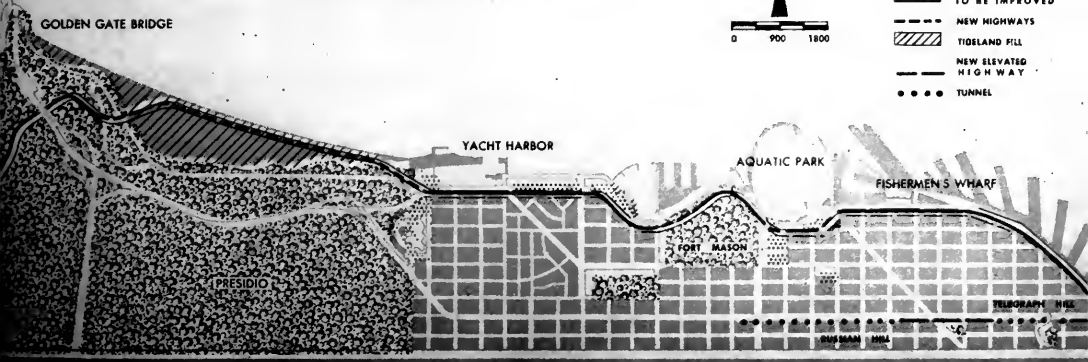

- EXISTING HIGHWAYS TO BE IMPROVED
- NEW HIGHWAYS
- ▨ TIDELAND FILL
- NEW ELEVATED HIGHWAY
- TUNNEL

PLANS FOR CONTINUOUS SHORELINE DRIVE

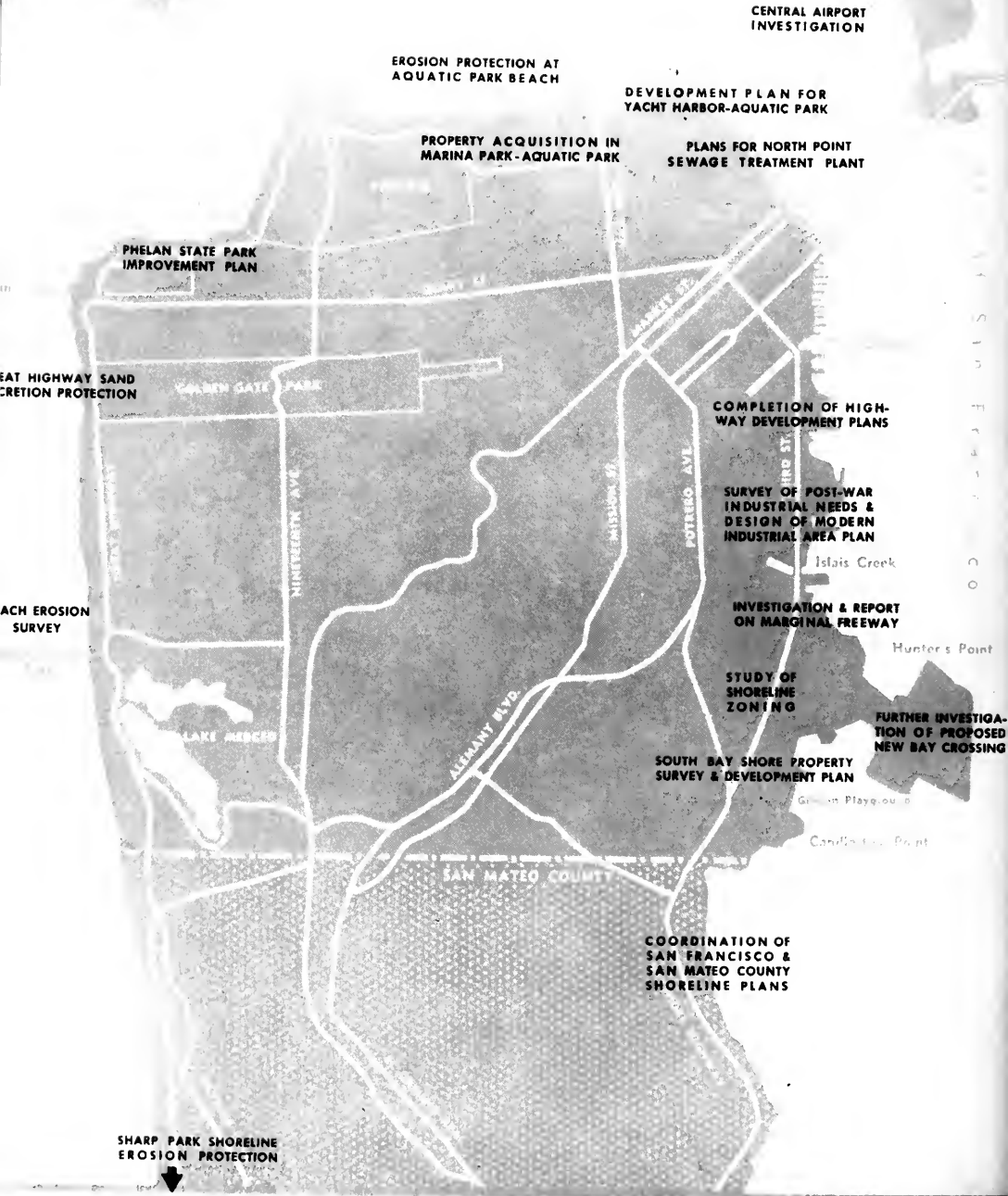

IMMEDIATE PROGRAM

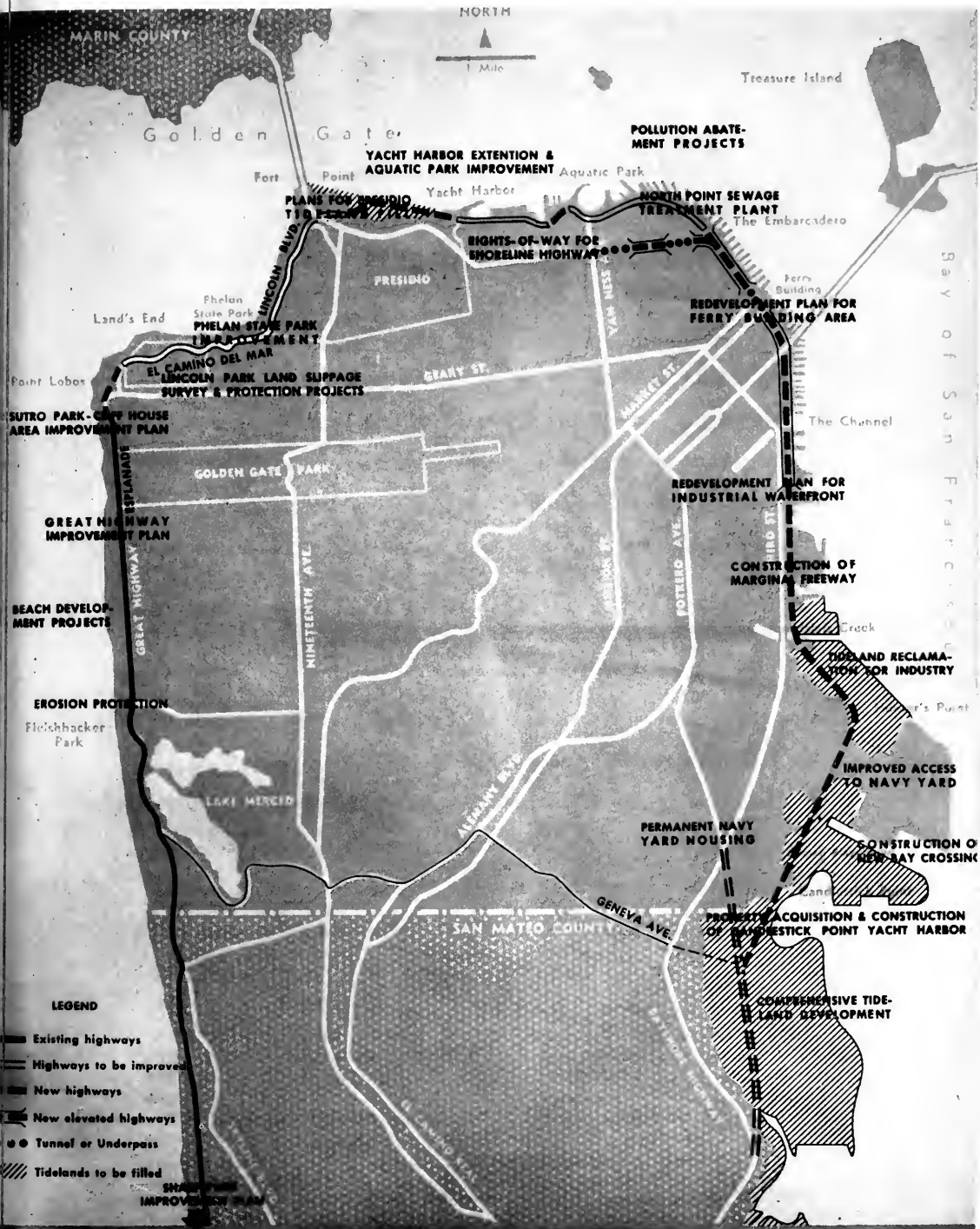

POST-WAR PROGRAM

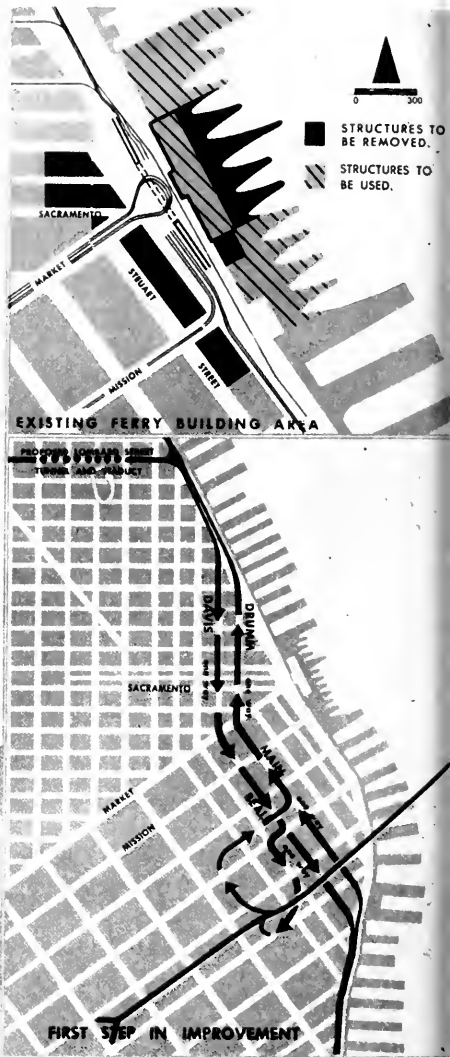
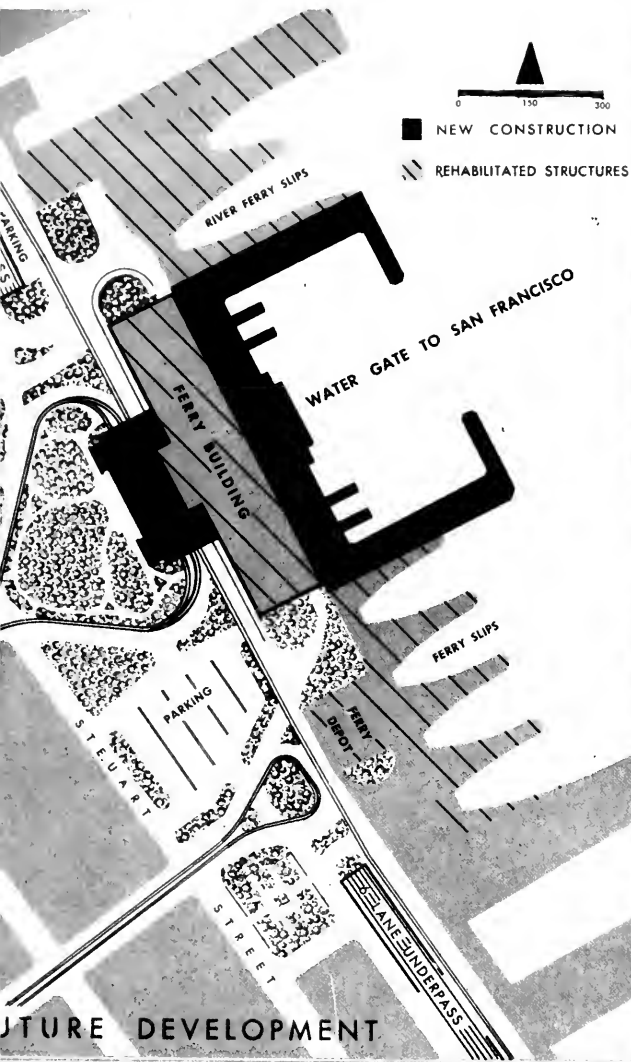

STUDIES FOR FERRY BUILDING AREA

land areas. The new facilities proposed would include bathing beaches, shore parks and picnic areas, walks, bicycle paths and observation points, improved parking lots, and more accessible and attractive tourist facilities.

7. Harbors for small boats would be increased in size and number, to give greater encouragement to sailing, fishing, pleasure boating and other uses of San Francisco Bay. This would be accomplished by doubling the capacity of Marina Yacht Harbor, transforming Aquatic Park and the Ferry Building and providing new facilities for boat building, rowing, and small sailboats in protected basins along the Bayshore at the County line.

8. Complete scientific surveys and investigations should be made of erosion, sand accretion and land slippage along the Ocean shore. These investigations are regarded as necessary for the protection of lands and improvements already in public ownership. Completion of such scientific studies will enable the city to employ the forces of nature profitably in the building up of new land, new beaches, and the creation of new park and recreation areas.

TEN POST-WAR YEARS FOR COMPLETION

The City Planning Commission estimates that at least ten years would normally be required for carrying out the proposed plan. If large scale unemployment appears after the war, however, the allowance of time for construction of many projects should be shortened.

The Commission has made no estimates of the total cost of the plan. These costs will

depend upon the prices of labor and materials prevailing at the time the work may be undertaken in the years following the war. The Commission is confident, however, that the problem of financing the construction of many of the proposed projects can be solved because the City of San Francisco has an excellent financial record and an enviable position with respect to its borrowing capacity.

The report points out that certain projects, such as the tideland reclamation along the South Bay Shore, have regenerative value. They create new land, useful facilities for industry and transportation and stimulate new types of economic activity. Improvements of this type may require a large initial expenditure, but the Commission points out that once these new lands and facilities have been created, they continue to provide dividends for the community for many years thereafter.

The report concludes with a reminder that certain hazards attend all efforts to look into the future. The City Planning Commission believes, however, that San Francisco is a city in which people will always want to live. They will always want the city to become better, to be more modern, and more attractive. They will pay the bill willingly, if the work is well planned. The labor forces needed to do the job are here; the resources, machines and equipment are available, and as soon as the war is ended, the people of San Francisco will have both the will and the need to go ahead with many reconstruction and improvement projects of the type outlined in the Shoreline Plan.

SAN FRANCISCO CITIZENS' MASTER PLAN COMMITTEE

The Citizens' Master Plan Committee of the San Francisco Planning and Housing Association held its first meeting Tuesday, November 16, in the Italian room of the St. Francis Hotel.

Jerd Sullivan, chairman of the com-

mittee, presided and L. Deming Tilton, City Planning Director, and Thomas A. Brooks, Chief Administrative Officer, addressed the meeting.

Members of the Citizens' Master Plan Committee are: Harry B. Allen,

Hervey P. Clark, S. Waldo Coleman, Marshall Dill, Morse Erskine, Morgan Gunst, Daniel E. Koshland, William G. Merchant, James K. Moffitt, Richard M. Oddie, Ralph Rodgers, Alexander Watchman, Carl A. Wente, George Wilson.

STAINED GLASS PAST AND FUTURE

by JEANNETTE DYER SPENCER

Stained glass is the glory of the ancient cathedrals, the crowning achievement of a devout world. Today the war threatens to bomb it out of existence. If stained glass and the masterpieces of past cultures are destroyed, Europe will be a dreary place until the arts of color come to life once more. Will stained glass be one of the arts resurrected?

The answer is yes, possibly, for three definite reasons. First, the rules which guided the glass workers of the middle ages have been rediscovered and live again because they are an integral part of our modern standard of esthetics. Second, today is an age of glass and not only is stained glass the most beautiful use of the medium so far developed by man but it is also the most intense medium of expression developed in the visual arts considered as a whole, more intense than painting, sculpture or mosaic, the medium with which it is most closely allied. Third, stained glass is a superb instrument for the promulgation of a great message. Will there be a great message? For the sake of our sanity we must hope that something more will come out of the cataclysm of this war than dadaism, futurism, surrealism and all the other products of world war number one.



ADAM AND EVE

From Art et Decoration
by Emmanuel Vigeland

Considering first our modern standard of esthetics, what has it in common with medieval glass? Two things: a feeling for the material, that is for glass itself, and an understanding of color in terms of light. The medieval artists used glass as a mosaic, forming their designs with small pieces of glass held together by lead. Since glass is heavy, leaded panels containing nine square feet or thereabouts were supported by bars of iron forming an armature, which was at first a simple gridiron in the window opening but later, in the storied windows of the thirteenth century, outlined the form of the medallions and was itself decorative. In recent years the evolution of decorative forms from purely functional prototypes has been extraordinarily speeded up, though more perhaps in the field of industrial design than in the field of stained glass and of the fine arts.

Before the war, stained glass windows in the technique of the twelfth and thirteenth centuries were being produced both here and abroad. The technique of the early centuries of stained glass, measured by our modern yardstick, is the finest. The artists then were true to their medium. They colored the glass in the crucible and did not paint upon it with enamel colors as did the artists of the renaissance who tried to imitate in glass the great compositions of the oil painters. The illustration of modern work, Adam and Eve in the Garden of Eden, by Emmanuel Vigeland at Stockholm, is an excellent example of glass in the style of the old. Compare it with the thirteenth century scene of Moses from the Sainte Chapelle at Paris. Vigeland handles his medium in exactly the same manner, for he treats it as a translucent mosaic and produces a powerful design with the lead lines used to emphasize form and small pieces of glass used decoratively for scintillating effect.

Today we find an appreciation of the true quality of glass in objects of art of all kinds and in sculpture. A small head from the Templeton Crocker collection which was exhibited



Moses places the flowering rod of Aaron on the altar, Sainte Chapelle, Paris

at the 1939 Golden Gate International Exhibition shows an extraordinary appreciation on the part of the artist, Henri Navarre, for the quality of glass. It is a head, but in addition it is a heavy, glowing, molten form, the color of ruffled sea water, pitted on the surface so that the light seems trapped within it. Here is an understanding that the irregularities of the old glass, the rough surface, the bubbles, the uneven depth was much of its quality.

COLOR IN STAINED GLASS

Stained glass is colored glass. Because light comes through it instead of being reflected from the surface as from a painting, some of the laws governing it are different. When the painter changes the value of a color he changes the quality too. Not so the artist working in glass. He may deepen his color by using a thicker piece of glass or by plating one piece with another and not change the hue. Consequently, he may, if he chooses, eliminate modified tones and work only in the colors of the spectrum, thus giving his work great brilliance. In the twelfth and thirteenth centuries the colors used were few: an orange red, a greenish blue, green, and violet that in bright sunlight seemed pink. To this were added small quantities of yellow and of off white.

Though color in glass is not the same as on canvas, painters have enriched their medium by a knowledge of the laws of light which governed the medieval artists working in glass. Impressionism in painting is first and foremost the realization that color is light. Thus the canvases of the impressionists are rich in the three

primaries of the light color theory: orange, green and blue violet. Often, too, rainbow hues give luminosity to impressionistic painting. Renoire especially seems to bathe his figures in the colors of the spectrum as though the light upon them was refracted light coming through a prism.

The post impressionists as well as the impressionists have much in common with the early window makers. Picasso passed through a stained glass period in which he used the diaper patterned backgrounds of the storied windows of medieval times. Braque in some of his recent very colorful canvases gives value to red by the use of pink as in stained glass. Roualt, of all the modern artists, is most profoundly influenced by glass. In his youth he worked on the windows of the old cathedrals and when he changed his medium and applied pigment to canvas he never forgot the color, the design or the texture of the old glass.

WARM VS. COOL COLORS

The thirteenth century artists knew that blue tends to recede, red to advance and in their windows usually silhouetted the figures against a celestial blue. When they wished a figure to appear within a doorway, however, they often used a red background to make the figure seem distant, the doorway near. Today it is common practice for the painter to use warm colors versus cool colors to give a feeling of three-dimensional form. The old system of shading and high lighting has been discarded and painting has captured a bit of the vitality of glass.

In the scene of Moses placing the flowering



Center of Apocalypse Window, Sainte Chapelle, Paris

rod of Aaron on the altar, the background is blue, the altar red. Moses wears a gown of green and a cloak of violet pink. His horns are yellow, indicating the light that streamed from his countenance after he talked with God. The quaint device of the horns was invented by the actors in the old mystery plays; then it was adopted by the artists working in glass and by the sculptors. Michelangelo's Moses has two marble horns. They are interestingly symbolical but not at once indicative of radiating light.

Glass is light and today is an age of glass and an age of light. We have made our windows larger and larger to let in more and more light and also to capture (within a building) a feeling of spaciousness and of the out-of-doors. Medieval builders likewise made their windows larger and larger, the supporting walls of the cathedrals narrower and narrower, partly to let in more light and partly, as today, for the sake of esthetics, for the sake of the windows themselves. The middle ages loved color, deep, rich, glowing color such as no other period has known. Because the color streams through the windows like the rays of the sun nothing in art has so stimulated our sense of sight.

Stained glass was at its height in the days when the story of Christ's suffering for the redemption of mankind was a moving force in man's daily life. Since then it has languished for it is too intense to exist merely as an exercise in esthetics. The artist may soar but not for long unless he touches life. Diego Rivera was just another able artist before he had a message to give the world. When he began to portray the laboring Mexican peons, he grew to the stature of his idea, namely that labor is noble. So in stained glass, the rays of red light, the greenish blue that complements it or mingles with it to form a rich purple, pour through a cathedral window like the full blast of a symphony orchestra in an endless fortissimo which would seem but a travesty if it lacked human significance.

Many artists inspired by an understanding of mankind will be born from the melting pot of this war. At the close of world war number one, Robert Boardman Howard said he wanted

to paint that war because it was the greatest thing that had happened up to that time. He did not do it. Somehow world war number one did not sufficiently move the American people. Out of the Spanish civil war, the bloody preamble to world war number two, came a new horror, the bombing of defenseless women and children and Picasso painted *Guernica*.

THE APOCALYPSE WINDOW

Guernica is apocalyptic and creates a greater feeling of awe than any of the apocalypse windows of medieval times. These never equalled the grandeur of the text. The apocalypse window illustrated is the rose window of the Sainte Chapelle. Only the center of the window is shown. Saint John kneels at the feet of the All Mighty, who is seated on a rainbow, a sword in his mouth. Behind him are the seven stars and the seven candlesticks symbolical of the seven churches of Asia which appear in the petals surrounding the central scene. The glass is fifteenth century, less colorful than the thirteenth but still beautiful. All the scenes of Saint John's vision of the destruction of the world and the resurrection are depicted in the rose of the Sainte Chapelle as a fitting conclusion to the stories of the old testament and of the life of Christ told in the lancet windows of the chapel. Stained glass windows of medieval times were the Bible of the poor. Stained glass was developed as a means of teaching the people and is the greatest example of the successful use of one of the visual arts for the expression of an idea that the world has ever known.

The ancient apocalypse windows, in spite of their tragic drama, have the same quiet serenity that permeates all the great stained glass. This serenity is attributable to the faith of the artists who saw a promise for the future in the stories they portrayed. If, after the war, our artists turn again to stained glass, which indeed they may because of the power of glass to tell a story, its intensity, and its relationship to modern esthetics, let us hope that they too may be inspired by a faith in the future.

REGIONAL The Central

Planning Valley Project*

by WALTER E. PACKARD

Planning encompasses two fields of research. One of these concerns the problems of physical science, including engineering. The other concerns economic and social relationships. This second field is often neglected, not because it is unimportant, but because it involves conflicts of interest which make agreement difficult. The pressing issues which remain to be solved in the Central Valley Project are economic issues primarily, and nothing is to be gained by dodging them.

Economics concerns man and the way he makes a living. It may not be a science in the strict meaning of the word; but effect does follow cause in economics as in physics or chemistry, which is the important fact. If a certain social objective is to be reached, there must be appropriate economic action to that end. Man's welfare depends first upon his philosophy of life, which determines his objectives. His objectives, in turn, shape his economic patterns of action, which are but a means to an end.

It is assumed as a premise that the principles enunciated in the Declaration of Independence and the Constitution of the United States embody the essential aspirations of a democratic people. The propositions that we are all endowed by our Creator with the inalienable rights of Life, Liberty and the pursuit of Happiness, and that Government derives its just powers from the consent of the governed, offer a sufficiently definite philosophy for present purposes. What we are interested in primarily, is the character of the economic pattern developed to implement this philosophy.

The desire for freedom, which has led to the establishment of the democratic philosophy of the New World was essentially a desire for freedom of enterprise, including the right to believe as well as act in one's own interest. What was needed at that time was an institutional device which would place the function of government in the hands of the governed so that they might create economic rules and regulations to their own liking. Political democracy was an essential prerequisite to economic progress.

The revolutionary step taken by the backers of the Declaration of Independence reflected the free atmosphere of a new world. But they were dealing with new economic forces for which their experience had not prepared them. They were conditioned to the concepts of a craft economy of an agrarian civilization recently modified by the effects of a rising merchant class. Modern economic thought was just taking form. It was in the year that Jefferson declared his belief that man possesses an inalienable right to life, liberty and the pursuit of

* Talk delivered at the California Housing and Planning Association dinner meeting in Los Angeles, October 29.

happiness, that Adam Smith published his "Wealth of Nations." Machines and new sources of power were altering not only the mechanics of production but management techniques as well. Thoughtful leaders were groping for theories to explain the course of changing events and to define the forces with which they had to deal.

THREE FUNCTIONAL PATTERNS

Three basically different functional patterns emerged from these inchoate circumstances. Two of the patterns represent a naturally balanced functional unity in which consumer want is the primary motivating force. The family farm is one of them. The family farm operator is owner, enterpriser, laborer and manager all in one, and to a degree he is consumer also. Consumer co-operatives form the second of the two patterns in which functions are united. They include not only the growing number of consumer owned and operated stores and gas stations, but they include also, municipally owned and operated enterprises of all kinds; irrigation districts where water users join in developing their own supply; farmers marketing and processing co-operatives in which farmers who are users of various kinds of goods and service join in getting what they need; the T.V.A., and other Federal power projects; the forest service, U. S. post office; the U. S. Bureau of Public Roads, with its vast labyrinth of highways; river and harbor development; the Soil Conservation Service and the Bureau of Reclamation to mention but typical examples of activities which are motivated primarily by consumer want.

The third functional pattern is the dominant one in the industrial field. It is one in which the functions of ownership, enterprise, labor and the consumer are exercised very largely by separate individuals or groups of individuals. Most of the problems of present day industrial life are concerned with the conflicts of interest of these opposing groups. The interest of the consumer is the only common denominator. All are consumers, and all consumers want an ample supply at the lowest possible cost to them.

No planning project can be fully considered without reference to these alternative economic patterns. In the case of the Central Valley Project, the law favors the two patterns representing a unity of function. The Reclamation law, which represents the results of forty years of planning, favors the family farm and is opposed to large scale corporate organization in the agricultural field. It favors consumer ownership and enterprise in the power field. Also, it is important to note that the design in this policy is to support free enterprise by preventing monopoly ownership of two basic sources of energy, the biological energy of sun, soil and water upon which agriculture rests, and electrical energy which serves industry and the consumer. If either of these primary sources of energy are monopolized by a relatively small number of producers, free enterprise will be partially stymied, it will be heavily burdened and the resulting concentration of income will tend to lessen mass consumer purchasing power.

Most of the controversial issues relating to the Central Valley Project arise because some individuals favor a pattern of divided functions in both agriculture and in the power field.

DISTRIBUTION OF INCOME

The basic issue involves income. Shall income from land be concentrated in the hands of a relatively few large land owners or shall it be distributed more widely through the establishment of family farms or by a land tax on holdings in excess of a family farm unit or by public ownership as at Boulder City and as provided for in the case of the Columbia Basin Project. Shall power be owned and distributed by municipalities and districts where the returns to ownership and enterprise will go eventually to consumers in lower rates, or shall it be distributed by private interests, in which case the income will flow from consumers into the hands of a comparatively small number of stock and bond holders through higher rates.

These are problems which planners must face. The consequences of the possible alternative lines of action are very far reaching.

SURVEY INDICATES NEW USES FOR WOODWORKING IN POST-WAR HOMES

Woodwork, a No. 1 pre-war building material, will retain a major place in the plans of those who will build or remodel after the war. This fact is strongly and factually indicated in a recent survey, made by an independent research organization.

According to authorities in the building field, the survey strikes a refreshing note of realism at a time when speculation—much of it fanciful—is rife concerning "home building materials of the future."

In addition, the survey contains valuable information for architects, builders, and others on those features and conveniences which post-war home builders will desire most.

For example, as demonstrated by the survey, 83.78% of those interviewed want more storage space. Existing closets will have built-in drawers and shelves with cupboard doors to keep out dust. Shoe racks built just above the level of the floor will prove helpful. Double-duty closets, made by installing a full-length mirror on the inside of the closet door, will prove particularly convenient in bedrooms or front hallways. And the use of louvered doors—available in stock sizes and attractive designs—will help provide both light and ventilation for closets.

Windows, too, are a primary desire. 56.21% of those interviewed definitely want more windows in their tomorrow's home. Correct use and spacing of windows will make the home of tomorrow sunnier, more cheerful, more healthful. Use of windows will also make small rooms seem larger. Enclosure of porches for year 'round living accommodations, as well as the conversion of previously unused areas in attics, basements, and passageways between house and garage into additional sleeping quarters or playrooms, is also possible with windows.

Crowded housing conditions today have stimulated a desire for more bedrooms. As shown by the survey, 47.2% of those interviewed want more bedrooms in post-war homes. In small homes, particularly, this desire for more bedrooms will place greater emphasis on architectural design—particularly on the placing and grouping of windows and doors. Bedrooms being smaller, correct selection of doors is important as doors can make a room look smaller, larger, longer or wider. Mirrored or louvered doors can immensely improve the "smartness" of the bedroom.

Driving and travel restrictions are opening the eyes of American home owners to the possibilities of the home as a place of entertainment and recreation. Sixty per cent of those interviewed prove that statement by declaring a recreation room as a "must" in their post-war home.

In analyzing these issues, the economist and sociologist must use precise techniques of measurement and valuation in precisely the same way that engineers gauge the physical feasibility of a project and determine between alternative courses of action. Facts should be developed relative to the economic and social consequences of alternative ways of doing things. Just what will happen if you follow one course or another? Will those results, whatever they are, serve the general welfare or will they serve a minority group or groups? Will the resulting economy balance? Will there be enough buying power in the hands of consumers to create a necessary outlet for the goods and services produced? Will unemployment and business stagnation result from one or another of possible alternatives?

In addition to the service of trained economists and sociologists who are able to apply techniques of measurement and valuation in these economic and social fields, it is necessary, also, to have the participation of persons who by reason of their closeness to the problem, can provide facts which are pertinent but which may not be found through a more theoretical analysis alone. These practical operators are specialists although they may not be technicians. Their knowledge may not be systematic but it may be very significant. Their participation should begin as soon as the technicians have built the frame of facts.

Then follows the analysis of forces which influence opinion with reference to alternative courses of action suggested by the planning group. A study of a modern rural town shows the leading individuals are often the managers of the power company, chain stores of various kinds, transportation agencies, telephone and telegraph companies, gasoline stations owned by large distributors, and by the managers of large processing and distributing agencies, including creameries and packing houses whose organizations may be state or nation wide. The lines of control and of policy formation represented by these agencies lead to metropolitan centers and to interests often partial to the system

(Turn to Page 30, Col. 2)

WOODWORK RETAINS MAJOR PLACE IN POST-WAR HOME MARKET, RECENT SURVEY INDICATES

Sturdy, attractive doors and colorful built-in shelves and cupboards will add immeasurably to appearance and increase utility as well. Dutch doors, for a bedroom—unusual, yes—but they permit a maximum of light and air, yet protect small children by keeping them within the room when the lower half of the door is closed.

STEP-SAVING CABINETS DESIRED

With maids and laundry help scarce, Mrs. America has really learned to appreciate the value of step-saving, built-in cabinets. Of the people interviewed, 89% insisted on built-in cabinets for their post-war homes. By planning in advance, the cabinets can be fitted to the "work-flow" plan. Using stock wood cabinets, which are delivered unpainted, the housewife can work out any color or combination of colors she desires. Use of "decals" can add immeasurably to their appearance. Wood can be redecorated frequently for, unlike metals, paint on wood does not chip nor does it become lumpy with frequent paintings as do most metals.

Stock cabinets will prove equally versatile for other rooms. Linen closets right in the bedroom or cabinets built into the head or foot of the bed will eliminate the need for large dressers or bureaus in small bedrooms. Fitted trays installed in combination with mirror doors in bedroom closets will make a dressing closet deluxe.

Built-in cabinets in the dining room can be both useful and decorative. Corner cabinets are especially appropriate for the display of fine china or knickknacks.

SURVEY VOICES NEED FOR DINING ROOMS

Many of today's families are "eating in the kitchen" for convenience and quickness. But they aren't planning to do it tomorrow. According to the survey, 46.48% are listing a separate dining room in their homes of tomorrow. Tomorrow's dining room will differ considerably from the gloomy "cave" of the past. New arrangements and grouping of windows combined with bright decorations will create a bright, cheery atmosphere and an illusion of large space.

Doors, too, will play an important part in this post-war dining room. Flush doors may be used to create an appearance of spaciousness in small rooms. Wood partitions extending partially across the room will be used in some cases to separate the dining room from the balance of the home where space is limited.

On larger sized homes, windows and doors will enhance equally the beauty and utility of the dining room. Modern doors and windows—casement windows in particular—French doors and corner cabinets will make the dining room truly beautiful and livable.

REGIONAL PLANNING

(Continued from Page 29)

of divided function. A wide distribution of metropolitan papers tends to emphasize the influence of the city and the interests which may dominate it. The conclusions of technicians may easily be overruled by the pressure of interests seeking contrary action in line with their special liking.

WIDE FIELD FOR PLANNERS

When these organizational influences and interests are measured and appraised, planning enters a new and more personal field. What do individuals think about the issues to be met? What is the attitude of the representatives of metropolitan corporate interests? What are they doing to promote their views? What does labor think? What are the views and interests of the small business man and the family farm operator? What do the women think? What views do the local schools and churches hold and what influences do they exert?

When these factors have been measured and evaluated, the democratic process can be put into motion and "we the people" can finally direct our affairs on the basis of necessary knowledge and understanding.

BILLION DOLLAR BUILDING FUND

The California Senate committee on post-war reconstruction work, meeting in Sacramento December 13, discussed plans for a billion-dollar building fund to take care of post-war construction needs. On the subject, State Senator Jesse Mayo said:

"I think our committee should meet with city councils, supervisors and others, ask them to immediately start drawing plans for new dams, school houses, city halls and other public works.

"I believe a billion dollars' worth of public work can be blueprinted in that way. Then Congress should appropriate half of that, and the cities, counties, etc., match the half billion.

RAINBOW BRIDGE



At a recent meeting of the Structural Engineers' Association of Northern California, a discussion of "The Design, Fabrication and Erection of the Rainbow Bridge at Niagara Falls" and a forty-five minute motion picture showing the erection of this structure, was presented by E. L. Durkee (see page 10), resident engineer for the Bethlehem Steel Company, Shipbuilding Division, Alameda, California.

The new Rainbow Bridge, costing \$3,700,000, connecting Canada and the United States across the Niagara River below Niagara Falls, replaces its well-known predecessor, The Hon-eymoon Bridge, which collapsed under the pressure of an unusually severe ice jam in January, 1938. This new bridge is the world's longest fixed arch, having a span of 950 feet and a rise of 150 feet. It carries two 22-foot roadways separated by a 4-foot mall and a 10-foot sidewalk on the south side toward the Falls. Concrete approaches span the remaining distance at each end of the arch span, completing the 1200-foot length of roadway between the sheer, vertical, rock - rimmed edges of the gorge.

Mr. Durkee's presentation included a discussion of a series of sketches depicting the various stages in the erection of this structure, which enabled his listeners to visualize the general procedure of erection, at the same time providing them with the background necessary for full understanding of the motion picture which followed.

Due to the conditions existing at the site, it was impossible to consider falsework for the erection of this arch, and it was necessary to devise a method of erection without the use of any falsework bents in the river. An overhead tie-back system of support was devised for the erection of this structure. Since the arch ribs were entirely self-supporting, there being no spandrel truss system, it was decided to cantilever only the arch ribs and their bracing which would considerably reduce the dead load to be supported during erection. An interesting feature of this erection procedure was the utilization of approximately 1000 tons of fabricated steel, ultimately to be used for columns and the floor system, in the temporary erection structures required.

To support the tie-backs a steel tower 130 feet high with columns 56 feet on centers was erected on the end of the concrete approach, on each bank of the river, directly above the skew backs supporting the arch. These towers were made up of the permanent spandrel columns later installed in the structure. Anchorages were constructed on shore to which back stay cables were connected from the steel tower. Each of the two anchorages back staying the cable bent consisted of a rectangular block of concrete weighing 550 tons, bearing against the natural rock. From the top of the cable bent, tie-backs were connected to various points on the arch. Erection proceeded until the arch was erected from each bank of the

IS THE BEST LIGHT IN YOUR HOME IN YOUR KITCHEN?

If you have the slightest doubt about how good your lighting is, try this test. Take your book or your work into the kitchen. Can you see better? If you can you have proved two things to your own satisfaction:



1. That the living room lighting is not as good as it might easily be.
2. That proper lighting fixtures and lamps need not be expensive. Your kitchen fixture probably cost less than any other lighting equipment in your home.

The production of good light for seeing depends upon certain laws of light and sight.

The kitchen unit gives you good light because:

1. The bulb is enclosed in a diffusing bowl and all light reaching your eyes is well distributed—glareless and almost shadowless.
2. Light is evenly spread over a large area.

You can have just as good lighting in your living room or any other room of the home if these same simple rules are observed.

1. Be sure your living room lamps and fixtures have diffusing units.
2. Have large, wide shades on lamps so that light is well spread over a large area.

Your existing fixtures, or perhaps even some which have been "shelved" may need only simple adjustments such as right sized bulbs and enclosing globes, ample sized shades with white lining.

Why not review your home lighting NOW and see if you can't bring its quality throughout the house up to that high standard in any modern kitchen.



NORTHERN CALIFORNIA ELECTRICAL BUREAU
1355 Market Street
San Francisco, California
M-1243
Kindly send me your new FREE booklet, "Lighting for the Home Front."

Name

Street

City

State

NORTHERN CALIFORNIA ELECTRICAL BUREAU

*Electricity is vital to war production. Use it
carefully and without waste.*



ERECTION SHOWN PROCEEDING FROM BOTH SIDES OF RIVER. INITIAL TIE BACKS HAVE BEEN REMOVED AND ADVANCED FURTHER OUT ON THE SPAN AS ERECTION PROCEEDED

river to the crown, where a specially fabricated keystone piece was inserted.

Each abutment was provided with thirty-two 3-inch diameter up-set anchor bolts. On these anchor bolts was erected a steel grillage section, made up of plate girders and weighing $63\frac{1}{2}$ tons, to receive the arch sections. A 47-ton steel skewback section and three arch sections weighing respectively 65 tons, 75 tons and 58 tons, were then erected on this grillage and cantilevered out under their own weight over the river. At this point tie-backs to the cable bent were attached to support the structure as additional sections of arch rib were erected. In general, two sections of arch rib were cantilevered beyond each tie-back before installation of additional tie-backs for the arch support.

Material was received at the end of each concrete approach by a stiffleg derrick of 85-ton capacity and lowered from this point to the abutment below. Rails were placed on one arch rib section and on a beam supported on the cross bracing system, and a material truck operating on these rails was used to haul the arch rib sections and bracing system from the abutment out on the span to the end of the cantilevered portion. At this point a second derrick moving on the arch rib itself

(Turn to Page 36)



Placing of steel grillage section weighing $63\frac{1}{2}$ tons on anchor bolts at abutments.

WAR HOUSING PROJECT

Santa Fe Box Cars are made Into Two Family Shelters for Navajo Indians

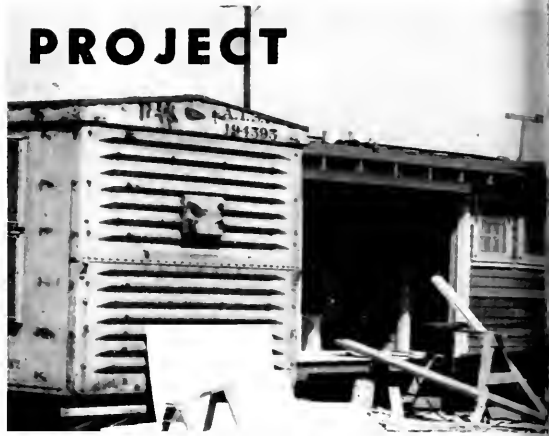

Wartime emergencies develop a relativity of needs reminiscent of the empire that was lost, "all for the want of a horseshoe nail."

We must have ships. But you can't have ships without men, machines and material. You can't get men unless men have places to live. And transportation is another essential link in the chain.

Good, old-fashioned American ingenuity has helped the Santa Fe Railroad relieve many of these jams, an interesting example being the housing project known as "Indian Village," near the freight yards in Richmond, California.

No, not teepees with their primitive characteristics. Instead a row of housing units—clean, substantial shelters, with adequate plumbing and plenty of room. They required

a minimum of material that could be used for other purposes.

Although they have completed hundreds of projects of greater size and cost, Barrett and Hilp, general contractors, found the Indian Village one of their most interesting operations.

Santa Fe had some box cars no longer fit for heavy freight duty. Yet they had some value. The steel trucks and frames could be used again as rolling stock if equipped with new superstructures.

So a plan was worked out to set two of the box cars on parallel foundations and build bath rooms, kitchens and a porch between the two. Such a unit would then accommodate two families. Completed, the project enabled Santa Fe to bring in a group of Navajo Indians from the desert, give them housing and thereby have the benefit of their labor.



Residents of Santa Fe Indian Village

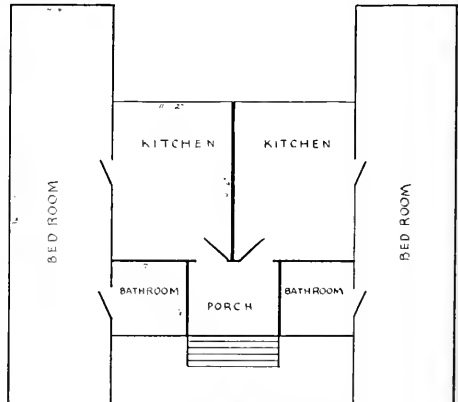

Floor plan of 2-Apartment Unit



LIKE HIS ANCESTORS

True to the tribal tradition of his ancestors, one seven-year-old Navajo resident of the Santa Fe Indian Village, Richmond, clings to his bow and arrow.

He's a crack shot, too. Any time the family wants a pigeon breakfast, the potential brave provides the piece de resistance.

Not from his own coops though. Those are his personal pets and he raises them and tends them most carefully.

But if a stray pigeon wanders into the neighborhood, he's walking right into a Navajo pot pie.



Completed and occupied unit of Santa Fe Indian Village, Richmond

Preliminary surveys revealed one difficulty. The plot of ground was so low that it could not be drained into the Richmond sewer system by gravity.

So it was necessary to construct a sump pit at a depth which would receive the flow from 980 feet of sanitary sewer. Adjoining the sump pit was another pit of similar size containing the pumps necessary to lift the sewage from the sump into the Richmond municipal sewer system.

It had to be done, so they did it. And the occupants are enjoying all the comforts of modern homes. Success of the original project may prompt its enlargement by the addition of other units later.



Sump Pit showing pump equipment

RAINBOW BRIDGE

(Continued from Page 33)

was provided. This consisted of a stiffleg derrick of sufficient capacity to handle the maximum loads of 53 tons, mounted on a triangular shaped steel underframe. This derrick was used in picking the loads off the traveler and setting them in place, and as the erection proceeded it was moved forward towards the center of the span.

On the completion of the erection of the arch ribs, jacking brackets were bolted to the top and bottom flanges of the ribs at the top and bottom of the ribs at the crown to support the arch until the measurements could be taken for fabrication of the 11-inch keystone sections, after which the tie-backs were removed and the supporting cable bents dismantled. Erection of spandrel columns and the floor system proceeded in the usual manner, with loads placed by both derricks, one operating on the deck of the structure from the abutments, and the other working back from the crown.

Throughout all erection operations a safety net, similar to that used on the Golden Gate Bridge, was suspended below this structure. Although the erection proceeded during the winter and under extremely hazardous conditions, an enviable record was established, inasmuch as there were no deaths or serious injuries on the project.

NEW LIGHTING PRACTICE FOR POST-WAR HOUSING

A real market for fluorescent lighting after the war will be the nearly two million stores in the U. S. A. These stores, according to utility executives, are chiefly interested in F-lighting. Incandescents, however, will still have considerable use for spot-lighting.

Chain stores alone, one survey shows, will spend a half billion dollars in the first year after the war for store modernization. That divides itself into \$3,500 per store.

There are three objectives in the G.E. 3A store-lighting plan: Lighting for attraction, appraisal, and for atmosphere. Of interest to architects and manufacturers of store-front materials is the all-glass "visual storefront" which reveals the whole store from the street. To accomplish this,

the "visual storefront" store will require a relatively great amount of light. Among other markets for greater amounts of fluorescent lighting will be the theater and the gas service station.

Only one-third of American industry as a whole is well lighted today. That leaves two-thirds of the industrial market (both large and small plants) yet to be lighted in accordance with present lighting practice.

Many types of hermetically sealed lamps are being used on military vehicles, as landing lamps for war planes, for signaling on the ground, in the air, and at sea. An exceedingly powerful lamp is being developed for searchlighting and other military applications too secret to be revealed

here. With slight modifications, sealed-beam lamps should find good post-war applications in the farm and railroad lighting fields. New opportunities for improved lighting for outdoor sports and for better drying methods through infrared radiation are indicated as the result of other lamp types developed for war needs.

"The peace time demand for projection lamps should expand at a greatly accelerated rate," according to Ward Harrison of General Electric Co. The value of movies, as an educational medium used so extensively by the armed forces, has been definitely proved. Doubtless there will be a wide peace time application of the V-mail idea for photographing and projecting of microfilm records.



Four sections of arch rib erected with one section cantilevered beyond first tie back. Note: Rib section being moved out to derrick by means of traveler operating on near arch rib.

The bridge was built by a Joint Commission of Canadian and American members who retained two American firms to design and superintend its erection—Waddell & Hardesty of New York City, and Edward P. Lupfer Corporation of Buffalo, New York.

PRODUCERS' COUNCIL PAGE

Northern California Chapter

The National Organization of Manufacturers of Quality Building Materials and Equipment

Affiliated with the AMERICAN INSTITUTE OF ARCHITECTS



MRS. SCOTT'S LITTLE BOY

Past President A. W. "Fred" Scott, who headed the Producers' Council, Northern California Chapter in 1936, comes from Australia. Genial, (with a capital "G") Fred arrived in San Francisco in 1902. He became one of Uncle Sam's nephews in 1905. Incidentally Fred has been so busy as Director of Sales, white lead and oxides, in addition to his job as head of the export department of National Lead, that he didn't have time

to have a photo made. In fact, from the look of these "plus-fours" he's wearing in the picture it has been a mighty long time since he's had the leisure to play golf. Fred, National Lead since 1914, is Past-President of the Golden Gate Paint and Varnish Association and of the San Francisco Sales Managers' Association. He has a daughter with the American Red Cross Military Service in Australia and another daughter at home. One son is a second lieutenant in the Army Air Corps; and his stepson is a first lieutenant stationed in Oregon. P.S.—If you run out of "brown points" remember this: Fred is a first-rate striped bass fisherman.

We Make a Hop, Skip and Jump from Fred Scott to that fine group of Past-Presidents—Ken Pinney of Armstrong Cork, Ray Brown of Gladding McBean, and Gano Baker of Westinghouse. The traditions and prestige so well established and built-up by that earlier outstanding group of leaders, with whom we have been acquainted, has since been energetically carried on by the newer crop of able Past Presidents.

They Had To Be Good to get where they are. That is the answer to those who think that business that is big is also bad. This was evident to those who heard Ed Cathcart of Johns-Manville and Clarke Wayland of Western Asbestos, trace the development of their companies from small beginnings to their present positions of eminence.

Without Benefit of Wassail. A recent survey of Rotary Clubs disclosed that 80% of the members polled, placed fellowship as the No. 1 reason they attended

meetings. The rest rated fellowship second. When entire groups of clubs in Rotary have a regular attendance of 90% or better, it seems to indicate that fellowship is a definite attendance stimulant. Of course, we don't propose the service club set-up for our monthly Chapter meetings, but merely to cite it as an example of its effect. They meet at high noon, in broad daylight **every week**, and without benefit of alcoholic stimulation, sing and relax and enjoy each other's company. Could be that the Annual Christmas Jinks at the Engineers' Club provides all the extra-curricular stimulation we need to last through a year's Chapter meetings?

Group Goal. As producers of quality building materials and equipment, we have the advantage of a common aim. Fellowship can be plenty of help. Let's make a definite effort to see to it that we always have an architect, engineer or other interested buying or specifying guest at our meetings.

Beat the Early Bird and get to the Chapter meetings a little ahead of time, loosen up a little, mill around and get acquainted. The Chapter provides the background and the opportunity . . . the rest is up to you. And if you happen to be a new member, it's a swell chance to make lots of new friends.

Xmas For Architects. Wrapped up in the little "black-package" below is a Christmas present for the architects. The plan was started by the Detroit Steel Products Co., and the idea is gaining wide popularity in the Council ranks. In order to constantly remind Chapter members of this practical approach to post-war planning, this slogan will appear monthly on the Producers' Council Page. Remember this:



NOW IS THE TIME TO START PLANNING POST-WAR JOBS!

The Shoreline Plan. Gano Baker, our Chapter representative on the Citizens' Master Plan Committee of the San Francisco Housing and Planning Association, reported on a committee meeting held at the St. Francis Hotel last month. Subject of the get-together was the Bayshore Highway six-lane project, a part of the Shoreline Plan (illustrated elsewhere in this issue). Adequate sewer facilities, to eliminate shoreline pollution, was also urged by the committee.

(Turn to next page)

USE QUALITY PRODUCTS

CONSULT AN ARCHITECT



PRODUCERS' COUNCIL (Continued)

Semi-Annual Meeting held in New York, November 10-11th, was the greatest in Council history. A large part of this can be attributed only to the real interest in post-war planning. This gathering followed the annual meeting in May which was, up to that time, the best attended.

Membership Up. Incidentally, here's another significant fact. The Producers' Council membership is at an all-time high nationally, and the Northern California Chapter is as big, if not bigger, than ever.

A Platform For Post-War Construction was formulated at the Semi-Annual Meeting. The Producers' Council believes that if the construction industry is to discharge full responsibility to national welfare, immediate action should be taken:

... To create maximum construction employment in the transition economy, when general industry is retooling and reconverting to peacetime production, and

... To sustain a high level of useful construction activity in the years which follow, thereby maintaining high national income and employment, and

... To achieve proper integration of land, environment, design, materials, construction, financing, and utilities to the end that the public will receive good design, materials of the proper quality, sound construction, low maintenance and operating costs, safe, convenient financing, and sales and service responsibility.

Just how it is proposed to gain these objectives will be outlined in following issues of the Producers' Council Page.

Serving Western Industry

Insulation... for pipe, boilers and refrigeration

Packings and Friction Materials

Refractory Cements

Corrugated Asbestos Roofing and Siding

Acoustical Materials

ENGINEERS • CONTRACTORS • DISTRIBUTORS

WESTERN ASBESTOS CO.

Building Materials • Industrial Products

OAKLAND • SACRAMENTO
SAN FRANCISCO

NON-METALLIC SAL-MO SUPPLY DUCT

for PUBLIC BUILDINGS—INDUSTRIAL BUILDINGS — HOMES and HOUSING PROJECTS

Sal-Mo Supply Duct is SAFE—Approved and Listed for Safety, Permanence and Heating by UNDERWRITERS' LABORATORIES, INC. COMPACT—Exclusive folding feature saves space in cars, storage and in transfer to job; saves time in erection. INSULATING—Built-in insulation assures years of fuel saving. LIGHT—Weighs less than 8 oz. per square foot. STRONG—Withstands Mullens Test of over 400 lbs. per square inch. MOISTURE RESISTANT—Fabricated entirely with insoluble adhesives. High humidity will not separate the various layers.

Manufactured in 26 standard sizes (areas from 26 square inches to 448 square inches, in convenient 4-foot lengths) allowing for all types of installations. It is also furnished in flat sheets containing 11 to 24 square feet which can be easily rolled or scored on the job.

FOR WARM AIR HEATING, VENTILATING AND AIR CONDITIONING SYSTEMS

A Typical Duct Installation in a Large Church Building. Sal-Mo Supply Duct Was Used Throughout.



SALL MOUNTAIN COMPANY

176 WEST ADAMS STREET • CHICAGO 3 • ILLINOIS

THE STATE ASSOCIATION OF CALIFORNIA ARCHITECTS

Northern Section

EDITOR

William C. Ambrose

Address all communications for publication in this department to W. C. Ambrose, 369 Pine Street, San Francisco.

STATE ASSOCIATION

Officers for 1944

President.....John S. Bolles
 (Northern Section)
 Vice-President.....Robert H. Orr
 (Southern Section)
 Second Vice-President.....Russell G. deLappe
 (Northern Section)
 Second Vice-President.....Vincent Palmer
 (Southern Section)
 Secretary.....Adrian Wilson
 (Southern Section)
 Assistant Secretary.....Malcolm D. Reynolds
 (Northern Section)
 Treasurer.....Ralph Wyckoff
 (Northern Section)
 Assistant Treasurer.....George E. Gable
 (Southern Section)
 Directors: Henry H. Gutterson, Regional Director, A.I.A.; Frederick H. Reimers, State Board of Architectural Examiners (Northern Section); Winsor Soule, State Board of Architectural Examiners (Southern Section).

Northern Section

President.....John S. Bolles
 Vice-President.....Russell G. deLappe
 Secretary.....Malcolm D. Reynolds
 Treasurer.....Ralph Wyckoff
 Directors: Norman K. Blanchard (for two years); Philip S. Buckingham (for two years); Henry H. Gutterson, Regional Director, A.I.A.; Andrew T. Hass, Northern Calif. Chapter, A.I.A.; Vincent G. Raney (one more year); Frederick H. Reimers, State Board of Architectural Examiners; Peter L. Sala, Central Valley Chapter, A.I.A.; Francis Ward (one more year); Alfred C. Williams (one more year).

Southern Section

President.....Robert H. Orr
 Vice-President.....Vincent Palmer
 Secretary.....Adrian Wilson
 Treasurer.....George E. Gable
 Directors: Henry H. Gutterson, Regional Director, A.I.A.; E. Keith Lockard, William P. Lodge, Charles O. Matcham, Captain E. Allen Sheet, Winsor Soule, State Board of Architectural Examiners.

ESTIMATOR'S GUIDE—

giving cost of building materials, wage scale, etc., a regular feature of Architect and Engineer, is being revised and publication will be resumed in the January number. Some new items are being added and every effort will be made to make this information even more valuable to the architect and builder than it has been in the past.

Other changes in the magazine are being planned for the New Year, including a new cover design.

WITHIN THE FAMILY

A double question is frequently asked by architects when they see a statement for annual dues from the State Association. The question: "Shall I pay it? What do I get out of it?" The statements for annual dues will soon be in the mail. Perhaps the architects would like to be reminded:

The State Association includes every registered architect in the State. It is the medium whereby he may express himself and use his influence for the betterment of the profession and for the advancement and protection of his professional standing. There are frequent assaults upon every profession by men who figure that they can profit by tearing down a profession and that they can do a certain amount of looting in the ruins of their demolition. Practically all of the professions have found it advisable and advantageous to band together in self-defense, and for the purpose of accomplishing work which the individuals of the profession cannot accomplish separately. And if the professional men wait until they have felt the force of an assault upon them before organizing, they repeat the experience of the unprepared nations which suffered assault from the Germans and the Japanese.

The Association can do good and resist evil. Do we do good for ourselves and for the community, and do we resist the demolition gang? The programs of the State Association for better public and governmental relations which are constantly in progress to the limit of the funds and personnel available, and the work of such committees as the Post-War Planning Committee are examples of the good which the Association does. The record of the activities of the Association at the last State legislative session is proof that we must be vigilant.

The officers and executive committee of the State Association are receptive and alert to suggestions from the members. They appreciate your interest and your desire to help the good cause. May we suggest that you send in your ideas for action in the same envelope with your dues?

Incidentally, this magazine which you are reading comes to you because you are a member of the State Association. Your contribution of news items and suggestions sent to the Editor of this page will be regarded as a measure of your willingness to cooperate for a more vigorous service to the profession.

Are You Alert?

According to a recent news release, school districts throughout California have so soon set aside \$9,000,000 for new school construction in the post-war period. It is also stated that several school districts have already sought the assistance of the State Division of Schoolhouse Planning on contemplated projects. Among those mentioned are Carmel, Fresno, Fullerton, Kern County, Modesto, Monterey, Needles, Redlands, San Bernardino, San Mateo, and Stockton.

The architects of the State welcome the assistance of the State Agencies in providing latest data on educational processes and facilities. But they believe that the State assistance should not extend to the length of sup-

planting the architect in private practice. One way of preventing this is for the architect to make sure that it is not necessary for the local board to depend too heavily upon State services. The competition with tax-supported State agencies is hard. But alertness on the job is quite a help.

Association Committees

At a meeting of the executive committee on November 8, President Bolles was authorized to group the committees for the year 1943-1944 under three general headings, and his recommendation that the chairman of each group of committees be a member of the executive committee was approved.

The grouping of committees and their respective chairmen are as follows:

Committee on Public Relations: J. Francis Ward, Chairman, (Construction Industry, Regional Planning, Publications).

Committee on Governmental Relations: Vincent G. Rane, Chairman, (Legislative Committee, Government in Architecture, Bureaus and FPFA).

Committee on Professional Relations: Alfred C. Williams, Chairman, (Programs and Membership, Dues, Practice of Architecture, By-Laws, Education).

The membership of each committee will be submitted at the next meeting of the committee.

Producers' Council Hosts

Many of the State Association members were guests at the Christmas Jinks of the Producers' Council, which was held at the Engineers' Club in San Francisco on December first. The men of the local chapter of the Producers' Council lived up to their reputations as fine hosts and connoisseurs of good living. The concluding entertainment and recognition of the fact that the next day was a work day left a very happy remembrance of a well-spent evening.

ARCHITECTS AND ENGINEERS MOVE

George J. Adams has moved from 2430 Cascadia, Glendale, to 113 East Los Feliz, same city.

Herman A. Bell's address, from Box 1386, Miami, Arizona, to 1310 West Portland Street, Phoenix, Arizona.

Norman K. Blanchard, from 226 Arguello Boulevard, San Francisco, to 1494 Plymouth Avenue, San Francisco.

Al Brinckman, back from Honolulu, Hawaii, recently in charge there as Associate Civil Engineer, U. S. Engineer's Office, has returned to Engineer's Office,

Berkeley. His present address is 2324 Valley Street, Berkeley.

Sidney A. Colton, from 18 Rico Way, San Francisco, to Ross, Marin County.

Scotfield DeLong has moved from 1331 Garfield Avenue, Berkeley, to 2656 LeConte Avenue, same city.

W. H. Ellison, structural engineer, from Pacific Building, to 500 Sansome Street, San Francisco.

Mervyn Gunzendorfer, from 3367 Washington Street, San Francisco, to 170 Vasquez Ave., same city.

W. Herbert, from 702 Water Street, Port Townsend, Washington, to 426-29th Street, Oakland.

Herbert C. Howard, from 3422 Hermosa Avenue, Hermosa Beach, to 2018 North Hobart Street, Los Angeles.

Reginald D. Johnson, from 5300 Rodeo Road, Los Angeles, to 507 Architects Building, 816 West Fifth Street, Los Angeles.

Roger K. Nissen, from 345 Carroll Park Beach, California, to Maui Grand Hotel, Wailuku, Maui, Hawaii.

Albert M. Pyke, from 6611 Maryland Drive, Los Angeles, to 1409 West Boulevard, same city.

Amos Randall, from 1414 South Orange Grove Avenue, Los Angeles, to 2605 West Adams Garden, same city.

Roward Riley, from 1201 Vance Building, Seattle, Washington, to 406 New World Life Building, same city.

E. Allan Sheet, from 323 North Western Avenue, Los Angeles, to 8743 Clifton Way, Berkeley Hills.

S. E. Sonnichsen, from 114 West North Avenue, Baltimore, Maryland, to c/o Phoenix Engineering Company, Halethorpe, Maryland.

Edwin L. Snyder, from 618 Riker Street, Salinas, to Box 1021, Carmel.

APPRAISERS' BUILDING

San Francisco's \$5,000,000 seventeen-story Appraisers' building, unoccupied for lack of plumbing and heating equipment for many months, is at last being completed and will probably be ready for occupancy early next spring.

For months the building has stood about 90 per cent finished because of needed critical war materials, which have finally been released. Unless the WPV changes its mind, the huge building will house the Interior Department, Social Security, Agriculture, National Labor Relations Board, regional headquarters, Navy, Coast and Geodetic Survey, Civil Service, Department of Justice, Department of Commerce, Maritime Commission, Treasury and Public Building Administration.

PACIFIC PAINT & VARNISH CO.

A Paint or Varnish Product for Every Purpose

SAN FRANCISCO
Sales Office

BERKELEY
Factory

LOS ANGELES
Sales Office

SOULE STEEL CO. WINS ARMY AND NAVY AWARD



Rear Admiral W. L. Friedell, Commandant, Mare Island Navy Yard (right) presenting Army-Navy "E" flag to Soule Steel San Francisco plant November 19. E. L. Soule, president (left), and Ed Eschenauer, employee representative (center) receiving the Award which was made for "Excellence in war production."

On November 19, Soulé Steel Company at its South San Francisco plant, was presented with the Army-Navy "E" award of "Excellence in Production." Rear Admiral W. L. Friedell, Commandant, Mare Island Navy Yard, officiated, and present was a large gathering of war workers and their families, business and civic leaders and Army and Navy officials.

In presenting the Army-Navy burgee, which now flies from the Soulé flagstaff, Admiral Friedell pointed out that less than 3% of the war plants in America have qualified for this distinction. In praising the cooperative spirit that exists between Soulé employees and management, he declared the "whys" of an "E" award are really demonstrated, concrete, patriotic efforts. "You might say," he continued, "that the workers who win an 'E' flag are really putting the reinforcing steel into the concrete structure of all-out patriotic war effort on the home front. You can take my word for it that lateness in delivery can cause disastrous ramifications at the war fronts which result in American young men losing their lives needlessly. Thus every job you finish ahead of schedule is as surely a contribution to victory and the saving of American lives as if you too were at the front behind a gun." He summed up his remarks with "Well done! Here's your flag—keep it flying!"

In his acceptance talk Edw. L. Soulé, president and founder of the company, stated: "Never before in any war have the men on the production line borne such a responsibility to the men out on the firing line. Our part here at Soulé Steel has been the construction of landing barges—building 'bridges to victory' between the mother ships and the beach heads. During those last few tense moments before the zero hour—just as the barge is grounded on the beach—the fighting men of America . . . your sons, brothers, neighbors . . . are entrusted to the care of Soulé war workers.

Our work cannot be compromised—for war grants no second chance."

Lt.-Col. Carlos W. Huntington, of the Army Service Forces, San Francisco Port of Embarkation, made the award of the Army-Navy "E" pins to the workers for "meritorious and distinguished service to the country in time of need." In accepting for the employees, Ed Eschenauer pledged continuance of the record that has earned the "E" and expressed the determination of the entire organization to "maintain or exceed the production that has won the 'E,' thus qualifying for the service star award six months hence."

Other Soulé veteran employees chosen by their fellow workers, who took part in the program, included Charles Bruno, Paul Blicke, Bernhard Dinse, Viola Dexheimer, George Fisher and Abel Romero. Max Thelen, director, Soulé Steel Company, served as chairman of the day. Music was furnished by the U. S. Coast Guard Barracks Band.

"NEW TOWNS FOR OLD"

The film "New Towns for Old" was shown at the regular November meeting of Southern California Chapter, A.I.A., and to make the pictures more interesting, Miss Margaret Russell, attached to the British Consulate in Los Angeles, described the effects of bombing on some of London's famous buildings, Miss Russell having been a resident of the city at the time of the bombings. The talk was backed by a full realization of necessary reconstruction work in England after the war.

MORRIS H. KNUDSEN

Morris H. Knudsen, chairman of the Board of Director of Morrison-Knudsen Company, Inc., one of the West's largest construction companies, died at his home in San Diego on November 16, aged 81.

AR-POLENE

American Synthetic
— is actually better
than natural rubber

Synthetics, developed by American chemists, can be blended in various ways to suit various requirements. We'll use one type of AR-POLENE for a certain belting . . . another type for a certain hose. As a result, industrial rubber products of this company are actually improved in quality. What's more, the shortage is becoming less acute day by day.

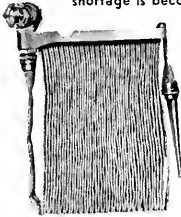

Lightning Hose Racks

—reels and cabinets provide the measure of protection required by law and business sense. Various types to meet every architectural requirement.

The

AMERICAN RUBBER

Factory and
General Offices: **Manufacturing Co.**
Park Avenue and Watts Street, Oakland, 8, California



QUALITY AND DEPENDABLE Service

are the factors that influence architects and contractors when selecting lumber and mill work — Quality of merchandise — Integrity and Ability of the firm—Service in physical equipment — Experience and Personnel — All these factors contribute to a speedy and satisfactory completion of construction with minimum of time and expense.

MANUFACTURER OR DEALER IN

Douglas Fir—Redwood—Sugar and Ponderosa Pine — Plywood and Concrete Form Panels — Sash and Doors — Millwork — Insulation — Builders' Hardware.

E. K. WOOD LUMBER CO.

"Goods of the Woods" ©
LOS ANGELES • SAN FRANCISCO • OAKLAND

MEXICAN ARCHITECTS IN REVOLT

Newsweek reports, in its art column, that Mexican architects have boldly taken in hand a situation which has been growing ever worse, with the determination to do something about it right now.

Residential architecture in Mexico City is an artistic horror, architects say, since it left off being Spanish. It has become fake-Colonial, with variations. The nouveau-riche are responsible for the new suburban constructions built by "post-revolution politicians and industrialists," who have their houses amateur-planned. And the style is described by Newsweek as "a fermentation of the United States modern and Spanish Californian" (not Spanish Mission, which is much to be preferred). These structures are built of inferior grades of concrete, bricks and mortar; use second-hand fixtures, but are bedecked lavishly with expensively ugly coats of arms and stained-glass.

Education of the public and the modern Mexican householder, is the solution of the evil, believes the Mexican Society of Architects.

So the Society advertised that it would pay \$30 to the person who will send in before a fixed time photographs of the ugliest house in Mexico City. Camera fans will look for ugliness and they may find it among the rows and rows of suburbia where examples of what architects dub Narvarte Colonial, Tepeyac Colonial and Polanco Colonial abound in almost any direction. For 99 per cent of Mexico's homes are civil engineer or amateur planned.

The 200-year-old Mexican Society of Architects would give the householder, instead of "these unspeakably horrible examples," a simple utilitarian job, executed with good local materials; floor-length windows, terraces, flat roofs; a front door to the street instead of all back doors on courts. It will have central heating, for Mexico City's climate is cooling; becoming "Americanized."

PRIVATE BUILDING COMING BACK

A general strengthening of building permit totals in the eleven western states and British Columbia during October offers a reasonable indication of the wider spread of privately financed war housing and alteration activity. At the same time, decreases in permits in the larger centers point to a lessening of Federal projects as emergency housing requirements in these communities are reduced.

According to Western Building's Monthly Statistical Survey, 13,413 building permits were issued during October 1943 in 181 cities reporting. These at a value of \$24,612,323. In October 1942, 11,277 permits were issued with a value of \$20,325,430. Heading the list of twenty-five leading cities were Los Angeles with 2,159 permits issued, valued at \$4,379,849, and Seattle, Washington, where 470 permits were issued with a value of \$3,677,438.

Permits for alterations and conversions numbered

ARCHITECT AND ENGINEER

7,612 for expenditure of \$4,272,679. The value of the 5,778 alteration permits issued in October 1942 was \$1,935,637.

Returns from 215 cities regularly reporting to Dun & Bradstreet, Inc., indicated a moderate building expansion in October. The aggregate for the month at \$48,286,921, was 11.5 per cent above the September figure of \$43,320,500, and 8.0 per cent greater than the \$44,707,721 recorded in October, 1942. Except for April and August, the estimated cost of permits issued in October was the largest since September, 1942. The following table presents the leading cities:

	Ten Months	
	1943	1942
Detroit, Mich.	\$30,503,839	\$48,816,485
New York, N. Y.	19,605,484	46,965,626
Los Angeles, Cal.	19,459,692	57,754,289
Portland, Ore.	18,768,985	12,518,430
Washington, D. C.	16,749,714	28,989,643
Seattle, Wash.	14,270,903	8,902,345
Cleveland, Ohio	12,985,400	21,216,200
Chicago, Ill.	12,181,580	29,194,309
Baltimore, Md.	11,602,434	20,404,488
San Francisco, Cal.	10,454,125	8,614,921
Philadelphia, Pa.	10,294,620	20,879,250
Spokane, Wash.	9,874,600	4,480,449
Boston, Mass.	8,155,887	9,191,321
Long Beach, Cal.	7,099,570	11,811,765
Houston, Tex.	7,098,645	16,400,765
Oakland, Cal.	6,638,971	5,646,052
San Diego, Cal.	6,494,336	8,857,734
Jacksonville, Fla.	5,798,015	3,651,487
Fort Worth, Tex.	5,742,700	10,095,416
Akron, Ohio	5,580,950	12,451,902

OAKLAND POST-WAR PROJECTS

Oakland's playground directors have asked for an appropriation of nearly \$2,000,000 for post-war improvements. The list of projects includes \$270,000 to be spent on three city swimming pools, with one enclosed central pool figured at \$150,000 and two open-air pools in West and East Oakland; rehabilitation of present recreational facilities and equipment, \$120,000; three community centers, open to the public every night, including gyms, clubrooms, workshops, kitchen and showers, and five smaller recreation centers, \$475,000; night lighting of tennis courts, baseball fields and other playgrounds, \$70,000; central stadium and athletic field, \$375,000; dredge and improve boating facilities in Lake Merritt, \$150,000; improving Lake Chabot Municipal Golf Course, \$100,000.

CONTRACTORS' ANNUAL DINNER

Over 500 members and guests attended the annual stag dinner of the Central California Chapter of Associated General Contractors at the Palace Hotel December 3. The speakers included Governor Warren, Major General Philip B. Fleming and R. L. Nicholson. Major General Fleming said present plans by all agencies add up to \$7,000,000,000 worth of construction, \$600,000,000 of which could be put into operation the first year after an armistice.

HOGAN LUMBER CO.

Wholesale and Retail

LUMBER

MILL WORK • SASH & DOORS

Office, Mill, Yard and Docks

SECOND AND ALICE STREETS • OAKLAND, CALIF.

Telephone GLencourt 6861

CLINTON CONSTRUCTION CO.

OF CALIFORNIA

General Contractors

923 FOLSOM STREET • SAN FRANCISCO

SUtter 3440

FORDERER CORNICE WORKS

Manufacturers of

Hollow Metal Products • Interior Metal Trim
Elevator Fronts and Cabs
Metal Plaster Accessories • Sanitary Metal Base
Flat and Roll Metal Screens
Metal Cabinets • Commercial Refrigerators

269 POTRERO AVE.

SAN FRANCISCO, CALIF. HEMLOCK 4100

STRUCTURAL STEEL

For Class A Buildings,
Bridges, etc.

JUDSON PACIFIC CO.

1200 SEVENTEENTH STREET
SAN FRANCISCO

Plants: San Francisco - Oakland

**The Most Complete Line of
STEELS and BUILDING MATERIALS
Made by a Single Producer**



See Sweet's Catalog File or write us for full information.

REPUBLIC STEEL CORPORATION
GENERAL OFFICES: CLEVELAND, OHIO

DENVER, COLORADO CONTINENTAL OIL BUILDING
LOS ANGELES, CALIFORNIA EDISON BUILDING
SALT LAKE CITY, UTAH WALKER BANK BUILDING
SAN FRANCISCO, CALIFORNIA RIALTO BUILDING
SEATTLE, WASH. WHITE-HENRY-STUART BUILDING

REMILLARD - DANDINI COMPANY

**BRICK AND MASONRY
PRODUCTS**

633 Bryant Street, San Francisco
569 Third Street, Oakland

**PACIFIC
MANUFACTURING CO.**

HIGH CLASS INTERIOR FINISH
QUALITY MILLWORK

142 SANSOME ST., SAN FRANCISCO
GARfield 7755

6820 MCKINLEY AVE., LOS ANGELES
THornwall 4196

BUILDERS EXCHANGE, OAKLAND

**SANTA MARIA INN
SANTA MARIA, CALIFORNIA**

FRANK J. McCOY, Owner

On the
Coast
Highway
between
San
Francisco
and
Los
Angeles



American
Plan
•
Old
English
Tavern

**"AMERICAN MARSH"
Redi-Vac Vacuum Heating Pump**

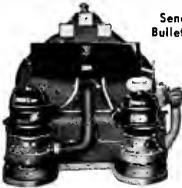

Send for
Bulletin 441

SIMONDS MACHINERY CO.

San Francisco
816 Folsom St.

Los Angeles
455 East Fourth St.

SISALKRAFT

REG. U. S. PAT. OFF.

"More than a building paper"

THE SISALKRAFT CO.

205 West Wacker Drive
Chicago, Ill.

55 New Montgomery Street
San Francisco, Calif.

**VERMONT
MARBLE COMPANY**

Producers and Finishers
of

Domestic and Imported Marbles

Write for new pamphlet describing our
Marble Tablets and Showers

San Francisco and Los Angeles
San Francisco phone: SUTter 6747



BASALITE

CAMBERED SHINGLE TILE

PERMANENT • FIREPROOF • STORM-
SAFE • COLORFUL • ECONOMICAL

Manufactured by
BASALT ROCK CO., INC.
NAPA, CALIFORNIA

MULLEN MFG. COMPANY

BANK, STORE AND OFFICE
FIXTURES—CABINET WORK
OF GUARANTEED QUALITY
CHURCH SEATING

Office and Factory:
60-80 RAUSCH ST., Bet. 7th and 8th Sts.
San Francisco
Telephone UNderhill 5815

THE TORMEY COMPANY

GENERAL PAINTERS
AND DECORATORS

Phone UNderhill 1913

563 FULTON STREET
San Francisco

ABBOT A. HANKS, INC. Engineers & Chemists

INSPECTING — TESTING — CONSULTING
CONCRETE • STEEL • MATERIALS
CHEMICAL AND TESTING
LABORATORIES
• RESEARCH AND INVESTIGATION •

TESTS OF STRUCTURAL MATERIALS
DESIGN OF CONCRETE MIXES
SHOP AND ERECTION INSPECTION OF
STRUCTURES AND EQUIPMENT
INVESTIGATION OF STRUCTURES
AND MATERIALS
TESTS AND INVESTIGATION OF
FOUNDATION SOILS
FIRE RESISTANCE AND INSULATION
TESTS

624 Sacramento Street, San Francisco

Robert W. Hunt Company ENGINEERS

Inspection • Tests • Consultation
Schools and Other Structures
Are Built as Designed

When Construction Materials are
Inspected at Point of Manufacture
and during Erection by

ROBERT W. HUNT COMPANY

Cement, Concrete, Chemical, Metallurgical,
X-Ray and Physical Laboratories

Chicago - New York - Pittsburgh
Los Angeles - All Large Cities
San Francisco, 251 Kearny Street

POST-WAR KITCHENS TO BE HOMEY

Post-war kitchens will stress hominess and such "working comforts" as top shelves that are easy to reach. There will be a softening of the cold, laboratory type kitchen and a return to some of the fundamentals that made the kitchens of yesteryear so comfortable and restful, according to Irving W. Clark, manager of the Westinghouse Better Homes Department.

Mr. Clark explained that better use of window drapes, bric-a-brac and a wider range of wall colors will add personality to the kitchens of the post-war era.

Livability will be the theme, and kitchen designing will include a definite place for the radio, a table and a comfortable chair. The trend will be away from kitchens that are so compact and coldly efficient that they lack charm and warmth. He predicted that larger windows of improved design, plus a better use of floor space will give an "air of spaciousness" to kitchens which actually contain a limited floor area.

While the spacious pantries that were standard equipment for most homes in the early 1900's will remain a matter of history, a modern application of their best features will again become an integral part of the post-war kitchen.

END FEDERAL CONTROL

Private financial institutions should prepare to take over, as soon as possible after the war, all mortgage insuring functions now assumed by the Federal Housing Administration, Douglas Whitlock, president of the Producers' Council, told members of the U. S. Savings and Loan League at a recent meeting in Chicago.

Whitlock also warned that all branches of the construction industry must work closely with War Production Board officials in order to make certain that restrictions on private building and construction are removed as fast as developments in the war program permit, thus providing the maximum amount of employment for demobilized construction workers



AT THE OFFICE AND AT HOME

There is no such thing as "banking hours" with a Mailway account. You can open one by mail (checking or savings) and conduct it entirely by mail — right from your home or office to suit your own convenience. Our special Mailway envelopes and passbook make this service fast and safe.

Open a Mailway account by mail

**CROCKER FIRST
NATIONAL BANK**
OF SAN FRANCISCO
California's Oldest National Bank

Member Federal Deposit Insurance Corporation
ONE MONTGOMERY STREET

LANDSCAPING WAR HOUSING PROJECTS

Maritime Commission
Apartments, Richmond
Sunnydale
G. G. Bridge Approach
Roosevelt Terrace, Vallejo
Camp Roberts
Chabot Terraces, Vallejo
Peralta Villa, Oakland
Sausalito
Union Square Garage



Growers and Distributors of
"Superior Quality" Nursery
Stock Since 1878

**LEONARD COATES
NURSERIES, INC.**

Ray D. Hartman, President-Manager

SAN JOSE, CALIFORNIA

**INCANDESCENT
SUPPLY
COMPANY**

647
MISSION STREET
SAN FRANCISCO

Lighting Fixtures and
Lamps, Fireplace Fur-
nishings, Pictures and
Mirrors, Electrical Sup-
plies and Marine Fix-
tures.

Oakland - Fresno
Los Angeles

**G. P. W.
JENSEN & SON**

—
Building Construction
—

320 Market Street, San Francisco
Phone: GARfield 2444

**JOHN
CASSARETTO**

—Since 1886—And Still Active—

Building Materials

READY MIX CONCRETE
ROCK - SAND - GRAVEL - LIME
CEMENT - PLASTER - MORTAR
METAL LATH - WOOD LATH
STUCCO - WIRE NETTING

Service Unexcelled

Bunkers
Sixth and Cheneil, San Francisco
Phones: GARfield 3176, GARfield 3177

when the war program begins to slacken.

Granting that the FHA has served a valuable purpose in the past and has demonstrated the feasibility of mutual mortgage insurance, the Council president expressed the belief that the public's post-war housing needs nevertheless would be met most successfully by returning full responsibility for the nation's housing program to private business and reducing the extent of Federal control over construction. To that end, he recommended that the insuring operations of the FHA should be continued during the early post-war years until equivalent facilities can be arranged by private enterprise.

Referring to the Platform for Post - War Construction, recently adopted by the Council, Whitlock said: "Manufacturers of building materials and equipment represented by our organization believe in the principle that government should assist and motivate private enterprise, but not compete with it, and that we should work to hasten the day when government will revert to its true and legitimate function.

"Our platform states that private new construction and maintenance and improvement of residential real estate, both in urban and rural communities, should be stimulated by the provision of financial facilities adequate for post-war needs. Encouragement should be given to the establishment of privately-owned mutual insuring facilities to guarantee investments in mortgages and notes, both for the financing of new and existing construction and for the financing of maintenance and repair.

"Such facilities should adopt procedures designed to enhance the probability of producing good environments, sound construction, and stable investments. Governmental instrumentalities which provide financial guarantees should be continued only until equivalent services are provided by private enterprise.

"Financial institutions should be permitted and encouraged to invest directly in the production of houses for sale and in rental projects."

**DINWIDDIE
CONSTRUCTION
COMPANY**
•
BUILDERS
•

CROCKER BUILDING
SAN FRANCISCO



**HERRICK
IRON WORKS**

**STRUCTURAL STEEL
REINFORCING STEEL**

18TH AND CAMPBELL STS.
OAKLAND, CALIF.
Phone GLencourt 1767

Phone GARfield 1164

Thomas B. Hunter

Consulting Engineer

**DESIGNER OF HEATING
AIR CONDITIONING
VENTILATING AND WIRING
SYSTEMS, MECHANICAL
AND ELECTRICAL EQUIP-
MENT OF BUILDINGS**

41 SUTTER STREET
ROOM 710
San Francisco California

**ANDERSON
&
RINGROSE**

—
General Contractors
—

320 Market Street, San Francisco
Phone GARfield 2245

ARCHITECT AND ENGINEER

OF THE
SOUTHERN
CALIFORNIA
INSTITUTE OF ARCHITECTS
(AIA) AND ENGINEERS

**MICHAEL
GOODMAN**

- ... Memorial Chapel
Temple Emanu-El
- ... St. John's Church
Marysville
- ... Three Bay Area
Houses

JANUARY • 1944



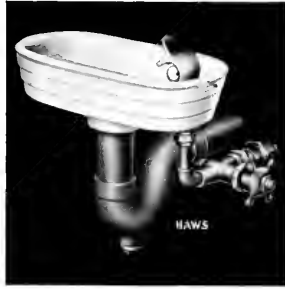

HAWS
Model No. 8
Semi-automatic

Today **INDUSTRIAL PLANTS INSTALL HAWS FIXTURES**

Numerous new and many well established industrial plants built or expanded during the present war emergency have installed HAWS Drinking Fountains to supply sanitary drinking water to their workers.



To specification writers — specify HAWS Drinking Fountains and Faucets. There is a model for every particular requirement.

This is an indication of HAWS' ability to meet the requirements so necessary in the maintenance of the workers' morale for keeping up production.

It is also an indication of American Industry's recognition of the importance of adequate sanitary drinking water for the workers' welfare and convenience.

HAWS DRINKING FAUCET COMPANY

1808 HARMON STREET • BERKELEY, 3 • CALIFORNIA

Agents in the following cities:

Chicago • Los Angeles • San Francisco • Seattle • Salt Lake City • Portland
New Orleans • Houston • Atlanta • Philadelphia • Worcester, Mass.

ARCHITECT AND ENGINEER

Volume 156 No. 1

FRED W. JONES
Editor

MARK DANIELS
Associate Editor

L. H. NISHKIAN
Consulting Editor

HOWARD MOISE
Post-War Planning

E. N. KIERULFF*
Ass't Editor
*In the Service

JANUARY CONTENTS

COVER PICTURE: St. John's Episcopal Church, Marysville

PHOTOGRAPHY:

Memorial Chapel—Phil Fein
Marysville Church—Van Doren
Matzger House—Esther Born
Myers House—Roger Sturtevant
Duplex Dwelling—Ray Birch

ARTICLES:

Running Fire	Mark Daniels	3
News and Comment on Art		4
In the News		9
The Work of Michael Goodman	F. W. Jones	13
The Post-War House Beautiful	Michael Goodman	22
Our National Post-War Economic Problem		
	Roi L. Morin	32
State Association Notes	W. C. Ambrose	37
Producers' Council Page		39
New Estimators' Guide		41

ILLUSTRATIONS:

Work of Michael Goodman—		
Memorial Chapel, Temple Emanu-El		13-17
St. John's Episcopal Church		18-21
House for Dr. Edward Matzger		24-26
House for Bertram Myers		27-29
Duplex Dwelling		30-31
Court Flight	John Haley	4
Lady Godiva	Elizabeth S. Jones	5

ARCHITECT AND ENGINEER (Established 1905) is published on the 15th of the month by The Architect and Engineer, Inc., 68 Post Street, San Francisco. President, K. P. Kierulff; Vice-President, Fred'k W. Jones; Secretary-Treasurer and Manager, L. B. Penhorwood; Advertising Manager, V. E. Atkinson, Jr.

Los Angeles Office: 403 W. 8th Street, Robert W. Walker, Manager.

Entered as second class matter, November 2, 1905, at the Post Office in San Francisco, California, under the Act of March 3, 1879. Subscriptions, United States and Pan America, \$3.00 a year; \$5.00 two years; foreign countries \$5.00 a year; single copy 35c. ARCHITECTS' REPORTS are published daily from this office, Vernon S. Yallop, Mgr.

NEXT MONTH

Viston, if you will, a massive cafeteria equipped to serve 60,000 meals a day; a building occupying an entire city block with 65,000 square feet ground level. Said to be the largest employee-owned-and-operated "hot food on the job" project in the country, some idea of its size may be had from the statement that the commissary requires a personnel of 450 persons to operate. The cafeteria is in California.

"Parklabrea," the Metropolitan Life Insurance Company's latest housing venture in Los Angeles, has been partially completed and tenants have already moved into one of the two completed sections. The project was originally planned for 2750 units containing 11,000 rooms. Most of the buildings have been designed in the Southern Colonial style. Architects: Leonard Schultze and Associates, New York, and Earl T. Heitschmidt, resident architect.

West Coast architects played an important part in the recent national architectural competition sponsored by the Kawneer Company and some heretofore unpublished details, with pictures of the prize winning store fronts will be presented.

An article of special interest to engineers will round out a truly meaty number.

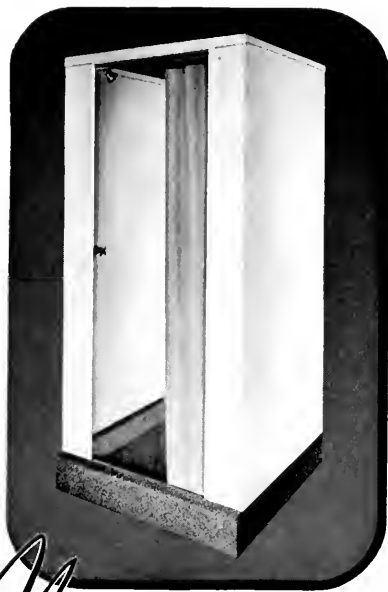

No. 85 **ENSIGN TYPE**
FIAT
SHOWER CABINET

A Better Shower—Standard Size 36" x 36" x 78"

now available for immediate delivery under low priority. Conforms to government regulations restricting the use of critical materials.

The No. 85 fills the need for a good quality shower cabinet for homes, clubs, hospitals and public buildings. Designed along the lines of our Ensign model, using the regular Ensign deep type receptor, the No. 85 compares very favorably with our standard Ensign cabinet and is the best shower we have been able to build under government material restrictions. Extra heavy treated fibre board wall panels are joined on all four corners with the Fiat tension locking joint which provides a rigid, permanent, waterproof structure that can be quickly erected on the job, as no additional fastenings are required for the corner joints.

The No. 85 was originally designed for use in military hospitals where a permanent type of construction is required. Many of these showers have been installed and have proved their value in practical use. Now we are able to offer this high grade shower cabinet for civilian use through the plumbing trade.

SPECIFICATIONS—WALLS: Heavy duty 1/4" S-2-S masonite hard board, coated inside and out with waterproof baked-on enamel. Metal frame pieces, 20 gauge steel. Head rail 16 gauge steel. All parts formed to eliminate rough edges within the interior of the cabinet. Furnished in white only.

RECEPTOR: Regular Ensign type, precast, reinforced terrazzo. Height 6" with cast-in wall flange and drain. Leakproof and sanitary.

SIZE: Over-all dimensions 36" x 36" x 78". One size only.



FIAT METAL MANUFACTURING CO.



1205 Roscoe St., Chicago 13, Ill.
21-45 Borden Ave., Long Island City 1, N. Y.
32 S. San Gabriel Blvd., Pasadena 8, Cal.

ADEQUATE WIRING

—The Key to
The Home of
Tomorrow

Today's acute housing problems are making people more than ever "home conscious" and millions are dreaming of the day when they will live in a home of their own — a home with electrical conveniences lacking in present living quarters.

When the war is over and they start building and buying homes, they are going to be far more critical of architectural plans than ever before.

Electrical service will be one of the prime items of consideration, with a demand for sufficient and conveniently placed electrical outlets and switches, and, above all, modern and satisfactory illumination.

Adequate wiring will provide the key to the home of tomorrow — the future way of living. Architects, responsible for the proper planning of wiring service, are keeping abreast of advances in the electrical industry now, and preparing for exacting post-war demands.

**NORTHERN CALIFORNIA
ELECTRICAL BUREAU**

1355 Market Street
San Francisco

*Electricity is vital for war production.
Use it carefully and without
waste.*



RUNNING FIRE — by MARK DANIELS

WHY DO THEY LIE TO US?

According to Rupert Hughes two Jewish traveling salesmen met on a train leaving Berlin. One asked the other, "Vere are you goink?"

"I am goink to Vienna," the other replied.
"Vy do you lie to me!" screamed the first. "I know you are goink to Vienna, but you tell me you are goink to Vienna to make me think you are goink to Prague."

"Why do they lie to us Americans? They keep telling us it is a terrible war and that our casualties are going to be stupendous. We know it is a terrible war and that our casualties are going to be stupendous, but they keep telling us that it is a terrible war and that our casualties are going to be stupendous to make us think the O. P. A. is a good idea.

"Vy do they lie to us!"

BY-PASSING THE ARCHITECT

With the foundation so well established by the architects themselves it did not take the War Department long to completely by-pass architecture as a profession essential to the proper designing of structures, groups of structures, and community plans. Percival and Paul Goodman wrote in the December 20th issue of "The New Republic," "The lesson drawn by the army, however, seems to have been that fundamental architecture is not architecture at all but engineering . . ." In support of their claim that "Military architecture is stand-pat and has analyzed nothing," the authors state that the date 1917 was erased from War Department plans and 1939 substituted; that "a good architect would have altered the design"; that "in general, there is no distinction in construction for hot and cold climates;" and many other charges that seem to be well substantiated.

But the public knows little or nothing about the lamentable results of the by-passing of the architects by the War Department. They merely followed suit with no waste of time. Even if they did realize that the substitution of the War Department's own engineers for practicing architects was a costly failure that is no proof that some other substitution would not succeed. And so, according to Messrs. Percival and Paul Goodman, "The most important problem of survival facing the architects is to learn their own function and come forward with proofs that they are indispensable."

A ROSE BY ANY OTHER NAME

A short time ago Congress was laboring over a change in the Food and Drugs Act that would legalize the substitution of "De-fatted Milk" for plain Skimmed Milk." De-nicotinized tobacco and de-alcoholized beverages went over all right, if you like them. We might even stand for the de-fatted calf in the return of many of our political prodigals but de-buttered bread, de-beefed meat and de-whiskied New Year will strain even the magic of the O. P. A.

ADVERTISING IT AND HOW

It has been said on good authority that, given a commodity with a modicum of merit and an ample advertising fund, the American public can be talked

into spending millions of dollars for that commodity whether they need it or not. As an example, a firm in Kansas City bought trainloads of lumber in Washington and Oregon, shipped it to their yards, stamped it with their firm name and sold it back to those two states at a marked up price plus freight. But in instances of this sort the advertising firms always had something to sell, be it ever so worthless. It took a global war to bring out the trick of advertising goods whether you had any to sell or not.

Are these whiskey manufacturers pulling a Hitlerian hoax on us with their three and four color full page ads? Or do they think that some Lady Godiva will shame the government into lifting the blockade? Based on results, I think these advertisers are wrong, for the reaction of most people is turning to resentment and the feeling that the advertisers are making fools of the public. Of course, if the lack of a Lady Godiva is holding up the procession and they really have some of that much advertised straight whiskey, I am sure that the offer of a case of it would bring in many applications for the job.

• A NEW MAYOR

The replacement of any office holder, political or otherwise, does not always mean that the ousted one ceased to be useful. The American people long have been known as lovers of change, and when they want one they make it. The people of San Francisco wanted a new mayor this year and chose Mr. Roger D. Lapham, emphatically. No matter what were their reasons for making the change, the city is 100 per cent behind him.

• WHY DIFFERENT DESIGNS?

Early in the development of the shelter for human beings, the element of protection began to embrace the idea of comfort. The mere protection from weather and danger was not sufficiently all inclusive. How many centuries elapsed before man became aware of the need for intellectual comfort no one knows, but assuredly he did not wait for the discovery of the psychoanalyst. It is this cry for intellectual comfort that creates much of the demand for different designs for structures that otherwise perform the same functions. The expression, "I would be miserable in that house," is all too common to be prompted by utilitarian considerations alone.

Personally I think this sort of reasoning is nonsense, but I just couldn't live in a Rococo house. It would drive me nuts.

MEMORIAL EXHIBITION OF PAINTINGS BY JOHN TUFTS

The late John Tufts began serious painting in middle life, found a style and manner of his own—very expressive, very sensitive, decorative and fresh in its reaction to sensation and experience. This group of oils and gouaches, in majority late works, are at once a memorial to a beloved and highly gifted Berkeley artist and the first survey of his work in its entirety. At the San Francisco Museum of Art until February 1.

NEWS AND COMMENT ON ART

POST WATERCOLORS ADDED TO BENDER COLLECTION AT MUSEUM

Mother Lode Interior, a watercolor by George Post, has been acquired for the Bender Collection as the Annual Memorial Purchase put into effect for the first time this year, at the S. F. Art Museum.

The collection is especially rich in representative works in watercolor, and illustrates well the development and practice of the medium by artists in the San Francisco Bay Region.

Mother Lode Interior is a notably fine achievement technically and is an important addition to this part of the collection. Post specializes in watercolor, has developed an individual style within the classic character of the watercolor medium. He had not previously been adequately represented in the collection. Born in the East Bay, he studied art in the schools of the region, has had frequent exhibitions here, traveled and studied in Mexico and in Europe. His most typical work, however, concerns the moods of San Francisco and the picturesque aspects of the Mother Lode country, depicted very freely and in no tightly illustrational way. In his best work, as in the Memorial Purchase, values of abstract design and color are important.

A Memorial Purchase will be made annually

to be shown at the time of the yearly exhibition of the Bender Collection. In the spirit of the late Albert M. Bender's own purchases from artists and gifts to the Museum it is intended that the acquisitions shall be representative of art in the Bay Area.

ART OF WAR'S CHILDREN CONTINUES THRU JANUARY

The popular current exhibition of paintings and drawings by young artists from all over the world which the Joint Anti-Fascist Refugee Committee is sponsoring and which the de Young Museum in Golden Gate Park has made its special holiday show, is to remain on view throughout the current month. A lively and colorful display, complete with music box, Christmas tree and trimmings, the exhibit features solely the work of children from five to fifteen, refugees from their European and Asiatic homelands. Some of them have vividly described their participation in the war's grim experiences while others have preferred to forget in gay scenes of country life, decorative still lifes and portraits.

Visitors will be interested to know that many of the pictures have now been placed on sale, proceeds from which will go to aid these youngsters, now being cared for in Britain and Mexico.



COURT FLIGHT
by John Haley

Artists' Fund Prize Award
San Francisco Art Association, 1943

AN EVER CHANGING WORLD

CALIFORNIA ARTIST'S WORK REVIEWED BY "ART DIGEST"

It is not often in this day of painting that an artist attempts to further an idea, or an ideal, putting aside all considerations of self-advancement or even of sales or subsidies, in the pursuit of exemplifying a truth given unto him to believe.

Although the Argent Gallery in New York is not the place one would expect to find something entirely new and untried, it nevertheless houses this month astonishing paintings by just such a crusading artist, a Mrs. Pauline Peavy of California.

Mrs. Peavy has technical equipment equal to Dali. But instead of using her inherent ability (developed, certainly, in the cases of both by dint of long hard work) to give vicarious thrills of the unnatural and decadent, as Dali does, this artist tells a tale of the abstract forces of thought abroad in the world and attempts to give validity to the belief that the mind is real. She gives form to the "electronic structure," and these forms are no more unworldly than Dali's melting watches.

To do this, the artist devised a technique that defies analysis. She paints plasmas similarly to Matta's, uses church window colors of intense reds and blues, creates forms which are neither plant nor animal nor human. But they are not "non-objective." For many are built around the figures of Biblical characters and there is deep beauty in the faces of the subjects.

By caption, Mrs. Peavy has advanced her belief in the need for better balance of the parts played by men and women in the affairs of the world. There must be more balance of compassion, forgiveness, peace in thought (all maternal qualities) than we have now, if wars are to cease, she advances. Man uses his power for destruction. His beast instinct is stronger than his urge to contribute to the advancement of humanity. But woman, the giver of new life, has the power to build the temples not built by hands. One of the captions reads like this: "The 'mother' power of the earth has been as the moon—dimmed, as always in ages over-lorded by the male."

The keynote of the exhibition of 59 paintings, the work of the last seven years, is a 14-foot long panel of "The Last Supper." In colors like Byzantine enamels, she has painted the figure of Christ as compassionate, of pure thought and absolute justice and the disciples as representing various aspects of our character.

Mrs. Peavy is not an impractical mystic. She studied at Oregon State College, at Chouinard School of Fine Arts; taught art in high schools in California and has done a text book on the elements of anatomy. She has two sons, one 19 and in the Navy, the other in high school. She believes that art is not painted for morons by morons but is done and understood by developed minds. That it should take long study and much writing and interpretation before any new form of art can add to the till of understanding, is only to be expected. The paintings in themselves might not penetrate without explanation, she says.—M. R.



Modern Version of Lady Godiva Elizabeth Sparhawk-Jones
Lent by Mrs. Otto L. Spaeth, Exhibition of Romantic
Painting, American Museum of Modern Art, New York

SAINTS AND MADONNAS STILL SHOWING AT LEGION PALACE

Saints and Madonnas will continue throughout the month at the Legion of Honor galleries. Some of the main exhibits of the show are the beautiful group of the Madonna and Child, flanked by two marble Annunciation figures. The Madonna's robe, decorated with gold, red and blue, has a border of real lace which has softened and mellowed with time. In front of these figures is an Italian 17th Century prie dieu, or prayer bench, of old and worn wood, complete with its original pillow of brocade. Among the paintings are the two by Agnola Gaddi, the Cione Madonna and a beautiful Della Robbia wooden relief of the Madonna and Child. There are carved wood saints from Italy, Spain, Russia, Mexico and Germany, each equally important and typical of its time—ranging from the 13th to the 18th Century. There are, besides, the very fine 15th Century Spanish vargueno, or desk, lavishly inlaid in ivory; four very fine Renaissance chairs; an interesting ecclesiastical coin box of iron and wood.

ADAMS' BEQUEST FEATURED AT PORTLAND ART MUSEUM

The Portland Art Museum opens its exhibition calendar of the new year with a presentation of the bequest of C. F. Adams. A devoted and active trustee of the museum for many years, Mr. Adams left to that institution his collection of thirty-three canvases, most of them by the Barbizon group of painters. The pictures are all small, but excellent examples of the work of these men who were held together by a similar point of view, especially towards landscape painting. Practically all the canvases in the bequest are landscapes, although a few show animals, and, one or two, human figures. Perhaps those that would appeal most to contemporary taste are Boudin's "Harbor of Brest" and Monet's "Lavacourt." Monticelli's "The Mar-

riage of the Marquis d'Amboise" is also particularly noteworthy. Included in this bequest are two paintings by William Keith, one of them painted in San Francisco, and two cowboy scenes by Charles M. Russell.

Another January exhibition is "Meet the Artist," the collection of self-portraits by living American artists which recently had so much success at the de Young Memorial Museum in San Francisco.

Continuing into January from December is an exceptionally charming show of small sculptures, "Animals of All Ages." This group of fifty animals range in period from ancient Egypt, China and Greece to our own day and were especially brought together as an exhibition for children. An anonymous benefactor gave a fund last year for the purpose of building up a children's collection. The museum expects to purchase a group of sculptures from those being shown as the first installations of its Children's Room.

STATE-WIDE ART EXHIBITION AT SANTA CRUZ NEXT MONTH

The 15th annual state-wide art exhibition at Santa Cruz will open at the Civic Auditorium January 30, continuing until February 13. The show will be open to Californians or artists painting in California now. Media: watercolor, oil, pastel. Prizes will be given by a special jury of award. Margaret E. Rogers, 99-B Pilkington Avenue, Santa Cruz, will receive entries.

WHY SO FEW CAPABLE ART TEACHERS IN OUR SCHOOLS?

Lieut. Lester B. Bridham, of the U. S. Navy, formerly public relations director at the Art Institute of Chicago, has written a letter apropos of government aid to art in the post-war world. He says:

"The problem, to my mind, is not one of stimulating production of art here, but rather one of stimulating consumption. We have too much production of art in this country. Every good artist has a studio full of unsold, unhung works.

"Here is one reason why there is no adequate mass consumption of art in this country. First, children and their parents obviously should be exposed to art and have the main barriers to art enjoyment removed painlessly by the art teachers in the public schools. That is impossible, under the present public school system, because creative artists are not employed as they cannot pass the normal school requirements.

"For example, Miss Jones, who has just completed her teaching requirements, wants to teach mathematics. Upon presenting herself at her school she is told by her principal that she is to teach 'art.' But, she pleads, I know nothing about art. The principal is firm. Miss Jones you are the new art teacher. So she gets some arty cut-out materials and soon has the kiddies cutting out Easter bunnies—how she hates all art by this time! She (through no fault of her own has no interest in, nor capability for, explaining to anyone in simple terms what art means—for she has been paralyzed by it since that fateful decision of the principal.

"Thousands of producing American artists should have these public school art jobs. How they and their work would expand with such useful contact with the public! This would take

care of thousands of artists who would not have to be wards of the Government.

"As an aid to mass consumption of art we need mass art education. We spend millions educating people: not to leave food in the can after opening; that it is usually fatal to turn on a light switch while in the bathtub. Yet, relatively little has been done toward mass art education, in spite of corny colored reproductions for cigarette ads. Life Magazine has done more toward mass art education than any other mass medium. I think it is wonderful that a cowboy in Wyoming can have his appetite for art whetted for ten cents by good color reproductions of Chinese paintings and those of many other cultures.

"Several hundred thousand intelligent citizens (all potential buyers of art), who might get sold on art, often get scared off (at that decisive moment when their nascent interest is aroused) by the squabbles between the devotees of art which appear in the press. The nation is divided into two bitter factions: the modern and conservative schools, which are always battling in the newspapers and magazines. Perhaps, the uninitiated seek in art a release from the horrors of war and politics; many of them may be frightened off by the vituperative bitterness of the two feuding factions. Local art critics do not always assist in mass art education.

"No honest, vital program of national fine arts can escape the necessity to solve first the problem of stimulating the consumption of American art by the people, before any plans are made to take care of the artists. Years of experience with the WPA artists' program has given us plenty of valuable experience to deal with that side of the problem. Let us discuss in these pages how to stimulate the consumption of art everywhere throughout the nation."—Art Digest.

AT DE YOUNG MUSEUM THIS MONTH

Paintings by Francis de Erdely.
Art of the War's Children.
Ships and the Artist.
Color Prints by the Silk Screen Group.
Sculpture by Bernhard Sopher.
Prints by Charles W. Bartlett.
A 19th Century Wardrobe.
Photographs of the Art Treasures and Architecture of Russia.
Paintings and Drawings by Boris Chaliapin.
Oils, Pastels and Etchings by Gyula Zilzer.
Oils, Watercolors and Prints by Monty Lewis.

THIS MONTH AT LEGION HONOR PALACE

Dr. Jermaine MacAgy, acting director of the California Palace of the Legion of Honor, San Francisco, has announced the following schedule of exhibitions and special events for January:

Albert Campbell Hooper Collection—January 12 to February 29.
Audubon Prints—January 3-30.
Saints and Madonnas—An Exhibition of Religious Art—through January 30.
Recent Acquisitions to the Museum's Collection—January 4-February 29.
The Children's Museum—Design in Nature, assembled by the California Academy of Sciences—January 3-31.

WOULD YOU HAVE THE NERVE?

How'd you like to "sweat it out" with the Paratroopers? . . . step off into space on a combat mission? * Perhaps you, and we, could do it *if we had to*. But all that Uncle Sam asks of us is to buy more War Bonds, sacrifice a few comforts and produce for Victory! * The PAYNE plant has concentrated on war production for two years. But PAYNE Gas Furnaces will be back . . . surpassing even their pre-war standards of design, quality and performance. *You can count on that.*



PAYNEHEAT

NEARLY 30 YEARS OF LEADERSHIP



Payne FURNACE & SUPPLY CO., INC., BEVERLY HILLS, CALIFORNIA

We're Winning the War *on the rubber shortage*

Like the greater war, of which it is a part, the war on the rubber shortage is not yet won, but victory is on the way. Thanks to American chemists and American industry, we have developed AR-POLENE, the American synthetic which is actually better than natural rubber for many uses. So you can depend upon the quality of our industrial rubber products!

**May this year
1944** *show even further progress*

This is our wish, for the war on our enemies, and our expectation, for the war on the rubber shortage.

- Lightning Hose Reels
- Lightning Hose Reels
- Lightning Hose Cabinets
- Fire Hose

The **AMERICAN RUBBER**

Factory and General Offices: **Manufacturing Co.**
Park Avenue and Watts Street, Oakland, 8, California



... "and
add a Dash of
**STANLEY
HARDWARE**"

What "flavor" will their new kitchens be? Certainly, homekeeping magazines are suggesting a wide choice—from the ultra-modern with glass-enclosed ovens and 3-minute dishwashers—to the homey farm-kitchen designs with cleverly camouflaged modern appliances.

But you can be certain of one thing—Stanley will have hardware

to match every design. Time-tested and long-preferred styles or modern and "functional" designs—all are on our production lists, ready to go when Uncle Same Gives the word!

So, keep kitchen-minded and Stanley will be with you when the day of building and re-newing arrives. The Stanley Works, New Britain, Connecticut.

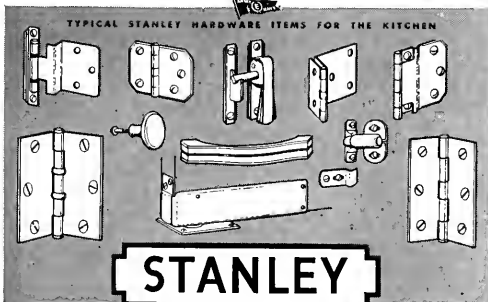



STARTING JANUARY 18TH IT'S UP TO YOU!

STARTING January 18th, it's up to you to lead the men and women working in your plant to do themselves proud by helping to put over the 4th War Loan.

Your Government picks you for this job because you are better fitted than anyone else to know what your employees can and should do—and you're their natural leader. This time, your Government asks your plant to meet a definite quota—and to break it, *plenty!*

If your plant quota has not yet been set, get in touch now with your State Chairman of the War Finance Committee.

To meet your plant quota, will mean that you will have to hold your present Pay-Roll Deduction Plan payments at their peak figure—and then get at least an average of one **EXTRA \$100 bond from every worker!**

That's where your leadership comes in—and the lead-

ership of every one of your associates, from plant superintendent to foreman! It's your job to see that your fellow workers are sold the finest investment in the world. To see that they buy their share of tomorrow—of Victory!

That won't prove difficult, if you organize for it. Set up your own campaign right now—and don't aim for anything less than a 100% record in those *extra* \$100 bonds!

And here's one last thought. Forget you ever heard of "10%" as a measure of a reasonable investment in War Bonds under the Pay-Roll Deduction Plan. Today, thousands of families that formerly depended upon a single wage earner now enjoy the earnings of several. In such cases, 10% or 15% represents but a paltry fraction of an investment which should reach 25%, 50%, or more!

Now then—Up and At Them!

Keep Backing the Attack!—WITH WAR BONDS

This space contributed to Victory by ARCHITECT AND ENGINEER

This advertisement prepared under the auspices of the United States Treasury Department and the War Advertising Council

IN THE NEWS

HEADS CHAPTER

Herbert J. Powell, who has been named President to direct the destinies of Southern California Chapter, A.I.A., this year, is a native of Chicago, where he received his early education prior to coming to California. Here he attended Redlands High School, and in 1920 graduated from the University of Redlands. Obtaining his degree in architecture at Harvard, he won the Sheldon Traveling Scholarship and the A.I.A. medal.



POWELL

Mr. Powell received his early training in the nationally-known offices of McKim, Mead and White and Thomas Harlan Ellett, New York City. Returning to California in 1926, Mr. Powell worked with Marston, Van Pelt and Maybury, of Pasadena, later forming a partnership with Norman F. Marsh and D. D. Smith. This firm has designed many of the better schools and public buildings in Southern California, including the Hollywood High School, Newport Harbor Union High School and the Henry E. Huntington School in San Marino.

Mr. Powell is a Past President of the Oneonta Club of South Pasadena; the University of Redlands Alumni Association and the Los Angeles Rotary Club. In politics, Herbert is Independent; for recreation he enjoys mountain hiking; his hobby, photography and sketching. Happily married to Alice I. Morse, of Bangor, Maine, there are two sons, James and Robert, and a daughter, Maybelle.

REOPENS S. F. OFFICE

The Donald R. Warren Co., structural and civil engineers, announce the reopening of a San Francisco office in the Sheldon Building, Carl E. Nelson staff engineer in charge.

Mr. Nelson has supervised the engineering design on many million dollars worth of war plant construction. Some of the most outstanding of these projects handled by the Donald R. Warren Co. are the magnesium plants at Manteca, Natividad, Moss Landing and Permanente, California. Mr. Nelson served in the capacity of structural engineer on the design work at the Roosevelt Fleet Base. Prior to this work he was employed by the State Bridge Department.

ART TEACHER

Dean Guy Gayler Clark announces appointment of Charles M. Rieger, Algerian-born architect, to the faculty of Cooper Union Art School, New York. Mr. Rieger will teach architectural presentation.

Index to Advertisers

*Indicates Alternata Months

A	
ALADDIN Heating Corp.....	*
AMERICAN Rubber Mfg. Co.....	7
ANDERSON & Ringrose.....	46
ARCHITECTURAL Competition	35
B	
BARRETT & Hilp	11
BASALT Rock Company.....	44
BAXTER & Company, J. H.....	40
C	
CASSARETTO, John	46
CLARK, N., & Son.....	*
CLINTON Construction Company.....	43
COATES, Leonard, Nurseries.....	45
COLUMBIA Steel Company.....	*
CONCRETE Grid Forms.....	36
CROCKER First National Bank.....	45
D	
DINWIDDIE Construction Company.....	46
E	
EMANUEL, L. & E.....	40
F	
FIAT Metal Mfg. Co.....	2
FORDERER Cornice Works	43
FULLER, W. P., Co.....	*
G	
GUNN, Carle & Company.....	40
H	
HANKS, Inc., Abbot A.....	45
HAWS Drinking Faucet Company.....	2nd Cover
HERRICK Iron Works.....	46
HOGAN Lumber Company.....	43
HUNT, Robert W., Company.....	45
HUNTER, Thos. B.....	46
I	
IMPERIAL Brass Mfg. Co.....	*
INDEPENDENT Iron Works.....	47
J	
JENSEN & Son, G. P. W.....	46
JOHNSON Company, S. T.....	*
JUDSON Pacific Company.....	43
K	
KAWNEER Co.....	*
KRAFTILE Company	*
M	
McNEAR Brick Co.....	44
MULLEN Mfg. Co.....	45
N	
NORTHERN California Electrical Bureau.....	2
P	
PACIFIC Coast Gas Association.....	Back Cover
PACIFIC Foundry Company, Ltd.....	38
PACIFIC Manufacturing Company.....	44
PACIFIC Portland Cement Company.....	36
PARAMOUNT Built-In Fixture Company.....	46
PAYNE Furnace & Supply Co., Inc.....	7
R	
REMILLARD-Dandini Co.....	44
REPUBLIC Steel Corporation.....	44
S	
SALL Mountain Company.....	*
SANTA Maria Inn.....	*
SIMONDS Machinery Company.....	44
SISALKRAFT Company	44
SOULE Steel Co.....	*
STANLEY Works, The.....	7
T	
TORMEY Company, The.....	45
U	
U. S. STEEL Company.....	*
V	
VERMONT Marble Company.....	44
W	
WASHINGTON - Eljer Company.....	*
WESTERN Asbestos Company	*
WESTERN Lighting Fixture Co.....	10
WOOD, E. K., Company.....	38
WAR Bonds	3rd Cover

Distinctive Lighting Fixtures



CHANDELIER IN CHAPEL OF TEMPLE EMANU-EL, SAN FRANCISCO

Michael Goodman, Architect

EXECUTED BY

WESTERN LIGHTING FIXTURE CO.

Designers and Manufacturers of
HIGH GRADE LIGHTING FIXTURES
BRONZE WORK AND MIRROR
FURNITURE

**WESTERN LIGHTING
FIXTURE COMPANY**

E. J. FLETCHER

WM. H. HOLLOPETER

**70 IVY STREET
SAN FRANCISCO**

Coming to the United States in 1939 Mr. Rieger collaborated that year with Norman Bel Geddes in designs for the General Motors Pavilion Exhibit at the New York World's Fair. He also was commissioned by Sabry Pacha, high commissioner of the Egyptian Government, to collaborate in the interior decoration and design of the Egyptian Pavilion at the World's Fair, and to serve as consultant on Egyptian architecture.

NEW PRESIDENT

Clarence E. Seage, newly elected President of the Structural Engineers Association of Northern California, succeeding Professor J. B. Wells, has maintained an office for the practice of his profession in San Francisco since 1920, except for a short period when he was employed on the staff of the San Francisco-Oakland Bay Bridge as one of the senior bridge design engineers, and also as chief planning and assistant executive officer in charge of design, construction and operation of participation of the California Commission for the Golden Gate International Exposition at Treasure Island.



SEAGE

As a practicing consulting engineer, Mr. Seage's commissions have embraced public and industrial structures, the more prominent being the Sacramento High School and Junior College; First Congregational Church, Berkeley; Temple Emanu-El (Henry Dewell, Associated); St. Dominics Parochial School, San Francisco, and Brophy College, Phoenix, Arizona.

In the industrial field Mr. Seage designed the Maria Elena Nitrate Plant, Chili, South America, and only recently completed a 60,000-ton capacity rolling mill for the Oregon Electric Steel Rolling Mills of Portland, Ore.

Mr. Seage's professional career started in New York City where he was employed by the American Bridge Company and Milliken Bros. as draftsman on the Pennsylvania Station and the North and East River tunnels and bridges.

ENGINEERS AND THE UNIONS

Unionism is fast becoming an issue in engineering, according to Clement J. Freund, Dean, College of Engineering, University of Detroit, who sums up the situation with the following conclusions:

"I do not see how engineers, the engineering profession and labor unions can possibly evade the following conclusions:

"1. Draftsmen, testers, technicians, instrument men, calculators, operators and others in engineering type occupations will find it practically impossible to achieve full professional standing if they belong to labor unions.

"2. Labor unions are just as appropriate among

draftsmen, testers, etc., who do not aspire to professional standing as they are in any other high class, skilled craft.

"3. If great numbers of professional engineers everywhere affiliate with labor unions, either because they choose to or because they are forced to, engineering occupations may continue to flourish, but the profession of engineering, as such, will most assuredly vanish from the face of the earth."

HIRING CONSULTANTS

The right of New York City to hire outside firms to do engineering and architectural work in connection with the city's planning for post-war construction was upheld by the Supreme Court of the State of New York in a decision rendered on October 13. The decision was in a suit brought by the Civil Service Technical Guild to have the court nullify existing contracts for such work and restrain the city from letting other contracts. The guild claimed that engagement of outside firms for this work was in contravention of the civil service sections of the state constitution.

In his decision Justice Pecora of the Supreme Court said: "I conclude that nothing contained in the Constitution of the State of New York or in the provisions of the Civil Service Law prohibits the City of New York from awarding contracts for architectural and engineering services to private concerns in connection with the post-war planning program. This court further holds that the action of the city attacked herein is in line with sound public policy and represents a wise exercise of discretion. The application, therefore, is in all respects denied, and the petition dismissed."—Engineering News-Record.

OHIO ARCHITECTS ON THE JOB

The blueprints will be ready on V-day on those needed construction improvements in Ohio, if the advice and surveys of architects in that State are followed. Reports of the Tenth Annual Convention of the Architects Society of Ohio held in Columbus, November 19th, showed that architects in practically every large city in Ohio are working in unison, as they never have before on post-war planning programs. They realize the great opportunity that this post-war program has given the architectural profession and practically every chapter of A.S.O. as well as the American Institute of Architects, are working zealously together with public officials and public spirited citizens in making surveys of the needs of their communities for all kinds of public building and engineering projects.

RUSSIAN ARCHITECTURE

Preview of an exhibition sponsored by the American-Russian Institute, was held at the de Young Memorial Museum, San Francisco, January 7th. The show comprises photographs of cultural, architectural and art treasures in the Soviet Union, before and after the organized destruction and looting by the Hitlerites.



THERE IS MORE THAN ONE KIND OF FAITH IN THIS SANCTUARY

A place of worship is a place of faith, of confidence in the goodness of men and the thoughtful designs of nature. Here is where men and women turn with the knowledge that they can find comfort and strength and inspiration.

That faith, during years of peace, has been enshrined by many a creed and denomination in settings founded on another kind of faith — faith in the builder's fidelity to the architect's design, in his use of durable materials and sound structural methods. The impressive Memorial Chapel in Temple Emanu-El, San Francisco, embodies both kinds of faith.

We, as builders of that Chapel, have still a third kind of faith — faith in the future. The coming of war turned all our manpower and facilities to the momentous tasks created by the emergency, but the coming of a New Year brings hope that the day is near at hand when triumphant peace-loving people may again call upon their builders for the places they desire.

BARRETT & HILP

Builders for 30 Years

918 Harrison Street

San Francisco, 7, California

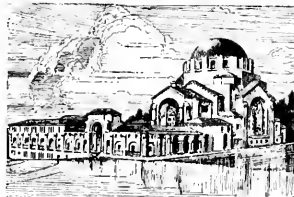

Temple Emanu-El, San Francisco

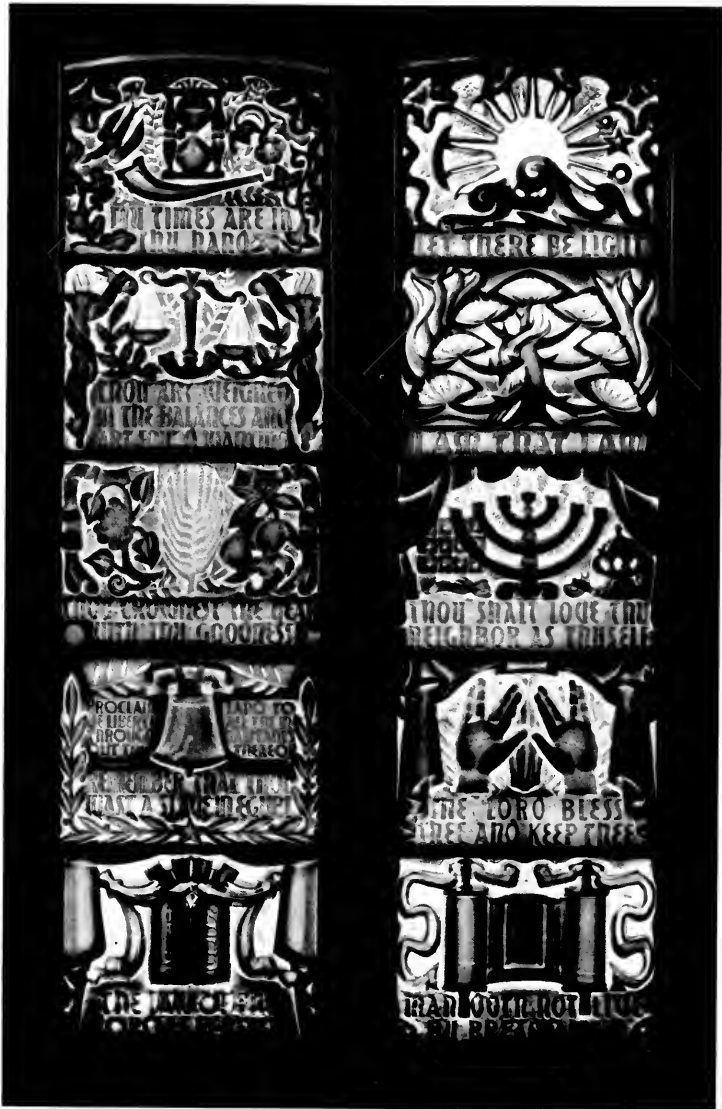

WINDOWS IN MEMORIAL CHAPEL, TEMPLE EMANU-EL
San Francisco



MEMORIAL CHAPEL, TEMPLE EMANU-EL, SAN FRANCISCO, LOOKING TOWARD THE ARK

WORK OF MICHAEL GOODMAN

When work in progress was severed by the war a half score of offices in this country not only summed up the past but also set landmarks to inspire peace-time designers.

In these days of demountables and emergency restrictions, continued recognition is given to the work of the office of Michael Goodman for just such manifestly expressive designs executed during the trying days of Pearl Harbor. Thus, with the above in mind, Architect and Engineer is reproducing in this issue some examples of work in which Mr. Goodman blazes trails in the technique and application of a glass and concrete construction.

He insists that his design is unfortunately experimental in many instances. "Let others improve on the detail." His explorative urge, he claims, is prompted by the necessity to seek solutions pertinent to the building of the day. "A martyr's existence," he adds enthusiastically! Mr. Goodman believes, for instance, that in this "age of plastics" the use of concrete promises an equally great and romantic future. He refers to Prefabrication as a snare and cliché in its popular acceptance.

Lithuanian born and Russian educated, Mr. Goodman brought to this country a cultivated appreciation of wood. He developed an affection for local woods and furthered the possibilities of the use of Redwood when he saw Maybeck's early work in Berkeley. Times have changed rapidly, he recalls, referring to the reluctance of the loaning institutions back in 1934, to finance his designs employing unpainted Redwood exteriors, plywood lining, gravel roofs, and a multitude of other features in house design.

Professor Goodman is very proud of the wartime achievements of the graduates of the School of Architecture of the University of California, of which he is a faculty member. "The

(Turn to Page 17)

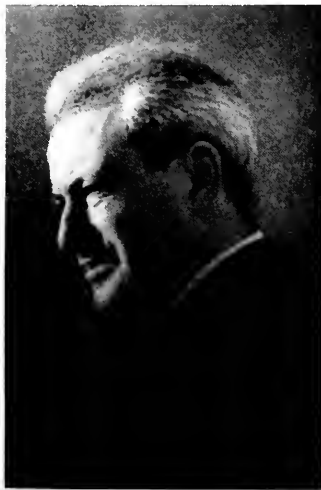

Teaches and practices architecture.

A MODERN ARCHIT

by Michael Goodman



Clay full scale study (9 feet high) of glass panels for window dedicated to the Holy Holidays.

Because the installation of two unique panels in the Temple Emanu-El in San Francisco may be of interest taken by eminent architect and Engineer is reprinting on these pages which appeared in a recent issue of the Memorial Museum.

The manager of an ornamental glass factory in Venice confided to me during working hours that, "they really can do glass in the United States if they only cared and were not afraid of indulging in sentimentalities."

I ventured to add that a tendency to narrow specialization and our slight accomplishment in the absence of established traditions, explain why we have so few names in modern glass-making. Besides, let it be said in whispered tones, the restraint of glass-makers in this country may have had a good deal to do with the fact that "American inheritors" of the French revival and their successors produced little work of merit as regards quality and design.

Functionalists will say that until recently mass production of sheet and plate glass, and that gift of small time decorators, the glass block, stifled interest in craftsmanship and experimentation in the manufacture and design of glass. Possibly what prevented industrial manufacture of varieties of glass in this country was the stigma attached to early "highly personalized" creations, often depending for their beauty on chance effects, and not infrequently degenerating into feats of technical virtuosity.

The existence of too much tradition and weight of accumulated precedent also may have been a hindrance to the blazing of new trails by these unsentimental American manufacturers. I know that glass-makers of today have returned to more basic methods of production, with greater attention to the "feel" and perfection of the metal. The glass-linteled entrances to the Rockefeller Center already are dated, heroic deeds in the new direction. But sandblasted glass, icy looking and frosty, chilled off any desire by architects to continue specifications in this medium. The designing departments sadly conceded the truth of the matter in the course of discussions on the subject.

I recalled the suggestion of my Venetian friend, that with the annealing facilities in this country, I should be able to get heavy slab glass made

RURAL GLASS MEDIUM

...ws in the new Memorial Chapel of the
...ew technique in architectural glass, and
...glass industry and the art world, Architect
...ct's own story of this new glass medium
...view, published by the M. H. de Young

For artistic purpose, on an architectural scale, "if they care to do it, mind you." If the dream of the last two centuries was the achievement of the whitest and most transparent metal, why not do what the medieval craftsman must have wished for in their prayers—obtain deeply colored glass so thick that any cutting-in will have induced a prismatic effect. After a wonderful occasion presented itself in my designing practice, the first two windows of the Temple Emanu-El Chapel were installed—"Ad Majorem Dei Gloriam"—one dedicated to the Five Books of Moses, the other to the Holy Holidays.

Be it noted here that all deeply colored glass 1 1/2 inches thick, as in this case, appears black in slab form. In cutting through with metallic particles to various depths we obtained colors from near-black to tones of red, through gold, to almost silver at the last eighth of an inch. The effect obtained is pellucid in quality, unlike the surface of sculpture. Moulding of the symbolic patterns from steel dyes would have been prohibitive and wasteful. Consequently, sketches were made with casts executed in "jello" from full-sized models. Then new drawings subject to spot-improvements were transferred to the rough slabs for blasting. Hand-blasting allowed using a variety of under-cuts impossible to achieve by moulding at the factory. After this work was done, the slabs were melted down mechanically to regain the former lustre. They are about 22 inches high each, and 25 inches wide. The finished slabs were set up on felt on brackets in metal frames to reduce excessive vibration.

I carved a thick piece of Cobalt glass to find, much to my delight, at a certain depth of cutting, a warm purple glow between a black area and shades of blue and silver. This hint may point to the possibilities of the "techniques to come" in architectural glass. In specifying the glass to the makers, we asked them to reduce the amount of seed and bubble by chemical additions, thereby enabling the slab glass to take the abuse of hand processing.



Clay full scale study of window in Memorial Chapel, Temple Emanu-El, symbolizing the five Books of Moses.



MEMORIAL CHAPEL, TEMPLE EMANUEL, SAN FRANCISCO, LOOKING TOWARD VESTIBULE

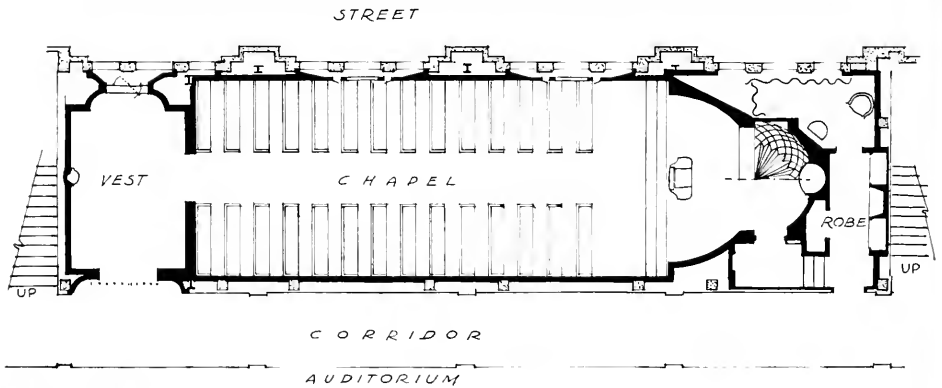

PLAN OF CHAPEL

MEMORIAL CHAPEL, TEMPLE EMANU-EL

San Francisco

Michael Goodman, Architect

The Chapel was built-in, or rather carved into a two story classroom wing of the distinctive Temple. Since the street noises created an acoustical hazard, the "shell" of the Chapel was suspended and isolated. Largest dimension of the Chapel is 76 by 19 feet. The acoustical condition is one of the most notable features of the new structure.

All the interior detail of lighting, metalwork, furniture and the windows were designed in the office and executed from office models.

It was mandatory to avoid the use of indirect lighting as well as the old-fashioned exposed-source type of units. The chandelier units are composed of three seven-branch candlesticks, 5 feet in diameter. A "dimming variety" of lighting was obtained to fit the type of service held.

To emphasize the value of the window decoration at night, lighting strips and reflectors were placed between the old, outside windows and the new ones. The five glass panels in each window are supported at two points only, with felt strips filling $3/16$ inch spaces between.

The dignity of the Chapel is maintained by its proportions and lack of ornamentation other than in the parts designed for service use. The walls are of English lacewood, redwood cored veneer paneling hung on isolators over layers of deadening, etc. The vault ceiling and all other plaster surfaces are of acoustical plaster.

The Ark containing the sacred scrolls is designed along the type of the ancient sacred cylindrical containers which, Mr. Goodman believes, later may have developed into variations as used in Europe.

The Chapel is heated by steam heated air blown down, with exhausts at floor level, utilizing the acoustical hollow spaces in the walls for recirculation. Space above the ceiling vault is used as a plenum and is acoustically insulated.

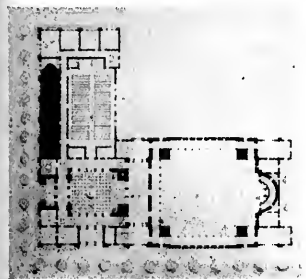

Upper right: One of two chandeliers, rheostat controlled, in chapel.

Executed by Western Lighting Fixture Company.

Center: Alms box.

Below: Vestibule grille.

Left: Plan of Temple, showing location of the new Chapel.

WORK OF MICHAEL GOODMAN (Continued from Page 13)

experience of our graduates will be valuable to us to reorient architectural education after the war," he asserts. His popularity stems from a friendship built up toward him by his students and a recognition in this country and abroad of his ability to think creatively in materials. Mr. Goodman sums up on Architecture by stating that, "we should know the past, but not advance the charms of extinction against the claims of real life; that in order to achieve nobility in design, we have to do a lot of wrangling with trial and error."—F. W. J.



ST. JOHN'S EPISCOPAL CHURCH, MARYSVILLE, CALIFORNIA
 General view of group.

Michael Goodman, Architect

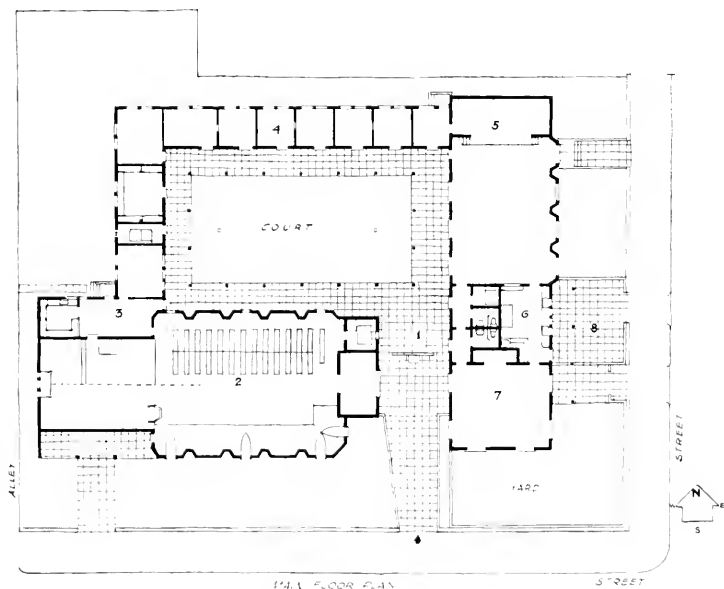

PLAN OF GROUP

Legend: 1. Covered entrance court; 2. Church building; 3. Vestry and Sacristy; 4. Class rooms; 5. Guild Hall; 6. Kitchen and service; 7. Kindergarten; 8. Service court. Dimensions of building, 134 x 96.



ST. JOHN'S EPISCOPAL CHURCH, MARYSVILLE, CALIFORNIA

View of center court.

A loosely connected "group plan" was adopted by the building committee at the time, due to:

- a. Budget program limitations and
- b. The looming emergency building and labor restrictions.

Low height units were connected with covered walks due to excessive climatic heat. The highest wall measures 23 feet; the lowest 8 feet 6 inches.

Because of the limitations, traditional decorative features were sacrificed in favor of obtaining maximum usable space. Provisions were made for future installation of memorial and decorative bequeathments. Furniture and equipment, as well as the leaded windows, were reinstalled from the original church building now dismantled.

A distinctive contribution in the plan was made by the introduction of the Court for out-of-doors service. The Chancel is large. Some of the wood construction is easily interchangeable. The building group represents the minimum requirements of the Congregation with the possibility of inexpensive alteration in the future.

The building covers an area of 100 feet by 157 feet of the total plot.

Construction features: Hard rock concrete, low soil pressure foundations. Above, walls of light weight, low water content, designed mix concrete. Floors are mostly wood joist construction with pine finish. The roof has wood "carpenter" trussing with asbestos shingle covering.

The concrete forms used were of movable type, made of aluminum 20 inches deep. In most cases they were removed after 15 minutes to an hour, depending on conditions. The batch was tamped in uniformly. The placement of the reinforcing steel had a feature of "inducing of a plane of cleavage" in order to keep cracking and shrinkage under control. The 30 day strength averaged 3500 lbs. per sq. in. with a lean mix. Early strength would show low. The texture of the placed mix provided good bond. A large proportion of labor used was unskilled, but within regulations.

Surfaces outside and inside are finished with two coat waterproof cement stucco with integral color.



Tamping concrete into slip forms, showing lock with hard rock foundations.



Showing wall panels in process of erection.



Tamping of typical form lift.



TWO DETAILS OF ST. JOHN'S EPISCOPAL CHURCH, SHOWING KINDERGARTEN AND YARD INCLOSURE



THE POST-WAR HOUSE BEAUTIFUL

by MICHAEL GOODMAN, Architect

Much has been written on post-war housing with seeming uncertainty. In most cases the medley of reports and programs presented to the public added to the general confusion. Out of the still mounting discussion of things to come after the D-day, one thing persists, and it is the house "for all" free of all shackles, one of the other Freedoms, as Churchill said recently.

While most of the evangelists and prophets have been heard from, evidence tends to point to the fact that little change may be expected in the hazy firmament of housing. Perhaps faintly gradual in either the shaping of programs or establishing the necessary controls to achieve results for the common good. In general, my point rests on the fact that while I, too, desire clarity, I would rather be confused by confusion than by false clarity.

The architects, too, are being called in to expend effort on working out our future housing salvation—or damnation. One of the most interesting and eloquent of such reports to the public were the results of a nation-wide competition which I viewed in a local museum a few months back. The contest was conducted by a Southern California magazine with the purpose to gather suggestions for post-war houses. It is unimportant here that you may not have seen it. You will not escape it, for it was given good publicity. The drawings provoked much thought in my mind.

I regretted the small number of winning designs which fact was possibly not due entirely to the war situation; rather, I thought, the reason was due to the basic difficulty of an inherent condition that in order to be a prophet one must have inordinary foresight as well as knowledge of the past.

The highlight of this competition was that by means of the "drawn essay" the competitors dared to pin down the future to concrete conditions. One might, on studying the drawings, escape their conclusions and reject their solutions, some of which are singularly inconclusive. They, the designers, boldly proclaim a packaged house (to cite the winning case

which is technically impractical to achieve, by the way), tent-like projects and constructions borrowed from the idiom of the airplane wing. Competitions must be held during critical periods. The entrants, like other poets, reacted to the complexity of the times by establishing their personal systems, which are particularly interesting in the manner in which they, the designers, have projected new concepts of building "for all," whoever they may be, out of current cliches and practices.

I hold that at the present stage, plans for mere construction systems and particularized designs is a comparatively minor matter in the face of the urgency for an all-embracing plan for the future. Hence, a competition of this sort in which values are lacking in reinforcement by facts, it is just as well to accept a cheerful point of view. The whole thing, in summing up, is that life is easy to arrange under any condition provided all the working detail had been disregarded; which is a legitimate theme. The spirit of the terms of the contest point to the fact that "shocking design" is welcome, thereby supporting the oft repeated contention that all generations are alike in that each is convinced its elders did not go far enough and that its younger contemporaries are going too far.

We see and read that the millennium of the prefabricated and standardized house, or types of housing, is to come along with the millennium of the common man. That the product will wed itself with the rollicking countryside. At a lower ebb last year, equally convincing were panicky statements that post-war architecture will be an expression of the "Bomber Age" crouching and clinging to mother earth—by design, a child of concealment.

THE FUTURE

As to the future of the House it is my opinion, and not hope, that in the peace emergency to come the situation will appear not unlike the one after the first war. The American soldier back from this war, and settled, as well as the future tourist discovering Europe, or what is left

of it, may desire the sentimental house, the kind they saw overseas. French, English, Spanish, not to mention our own Cape Cod strain of cottages, will be revived. In whichever way they may be constructed (or stamped) they will be offered with good kitchens, bathrooms and equipment.

Objectively stated, I think the following should be considered: The solution cannot be localized by any one agency or by a limited narrow set of conditions, but will emerge gradually from the complexity of our vast potential resources, plants and money. Even the anti-planners are making post-war plans to end all guesswork. This job must be, as some writers stated, along a plan the originality of which must first lie in the political implications to be promoted. There is no large demand by the public as yet on political changes to effect such a plan; but there is a great recognition that the House must be better and more accessible for the brave world to come.

It was stated that for some time the post-war house will be little different from the pre-Pearl Harbor models, just as the car of the future may be much like the 1942 model. My contention is that only those improvements in the house and related planning activities with their controls established during the war, will be carried over into the coming stages of peace. In other words, the new setup will, to a large extent, be the presently existing one. Postponement may have to be sought for other improvements and betterment of living.

The New Yorker Magazine reported recently that at a symposium held by the Society of Automotive Engineers, one of the speakers remarked while displaying a picture of a car that looked like a pale-green teardrop wept by a giant,—“here we have the general trend of the air-brush designers.” Obviously, there is a confusion existing between the prophets and those who embrace the sidewalk.

EMULATION

Assuming that automobile and aircraft problems are in different spheres of technique and economy, the House needs some other essential terms and philosophy. The profession has yet to initiate independent terminology instead of borrowing terms idiomatic of other technical

sciences and arts. The designers developed a fawning admiration for engineering terms, slang and techniques, probable and imaginary. The Engineers on the other hand suffer from the same doubts as the airbrush professions. If both the said Engineers and Architects could get together and agree on what they are rebelling against, perhaps things may shape better in perspective.

The New Yorker turns to a car which is in no need of guesswork—the jeep, and states that this thing will be certain in the post-war scene, I suppose, because we tend to go by hindsight. Possibly that's why, confident of public acceptance, there is an indication that a manufacturer will present the Cape Cod cottage in plastic materials with some detail changes; or it may appear before the buying public stamped out in such plastic. Horrible thought! We are just getting over our dislike of one-piece cast-iron building fronts.

PROFESSION'S FUTURE

Many architects expect that their lot will consist either of rendering clerical services to the Industry, or be, a romantic idea, planners for a reorganized society.

In the first case those designers accustomed to work only within the limits of their imagination may find themselves, when confined to a narrow cage, at the pleasure of their entrepreneurs. In the past they leaned heavily in the direction of individual design as an activity of esthetic satisfaction, since the House in general was considered merely a matter of a mechanical solution. In the future if they wish to work independently of corporations they must pay a personal price for the pleasure of a creative activity in response to this urge of balancing utility and delight. Otherwise they will be purveyors of services with desks in and out of the corporations.

It is said that pre-fabrication is the only hope of the building industry's sustained growth after the war. I am not afraid of that or of standardized practice as such. I do, however, have misgivings of the consequences it may induce. Should we train our architects to become virtuosos of handbook assembly, or to do

(Turn to Page 34)

HOUSE FOR DR. EDWARD MATZGER



SOUTH VIEW OF HOUSE FROM STREET

G. P. W. Jensen & Son, Builders

SAN FRANCISCO, CALIFORNIA



DINING ROOM

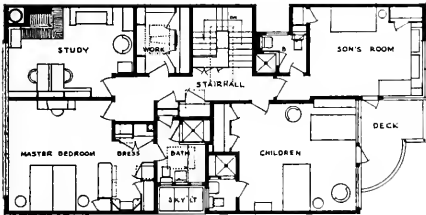

ORIENTATION:

North-South, as in many instances in San Francisco, the house is open to the South and affords a superb marine view to the North..

MATERIALS:

Foundations—Concrete.
 Superstructure—Wood frame.
 Stucco (buff) North and South walls.
 Trim and wood surfaces painted cream white.
 Heating—Warm air, gas fired, semi air-conditioned.
 Wiring—Conduit.
 Sash—Steel.
 Floors—Oak, tile, linoleum.

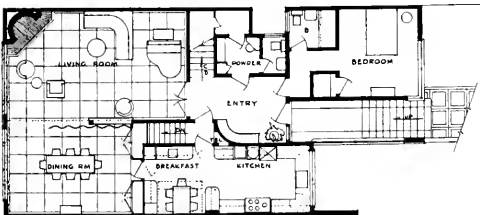

Walls—Combed white pine; painted canvas and grasscloth; interior stucco tinted; matched French walnut panels and cabinets in dining room.

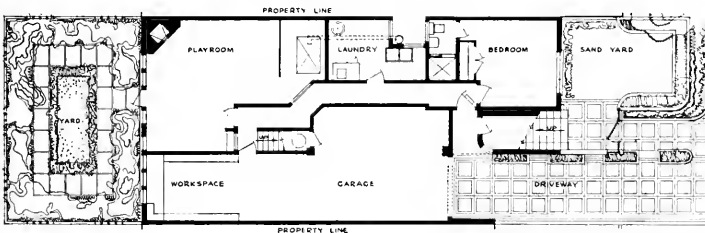

PLANS

Left: Entrance court and basement.

Above: First floor.

Top: Bedrooms.

HOUSE FOR DR. EDWARD MATZGER



1



2



3

1. Entrance hall.
2. Stair hall.
3. Living room.
4. Breakfast end of kitchen.
5. Master bedroom cabinets.



4



5

HOUSE FOR BERTRAM MYERS, PIEDMONT



Carl Walstrom, Builder

VIEW FROM ENTRANCE DRIVEWAY

A distinctive feature of this house is the study-office floor between garage level and main floor, all placed at half levels.

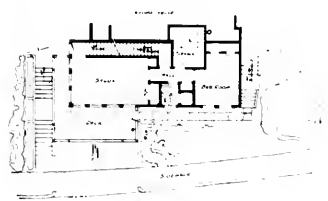
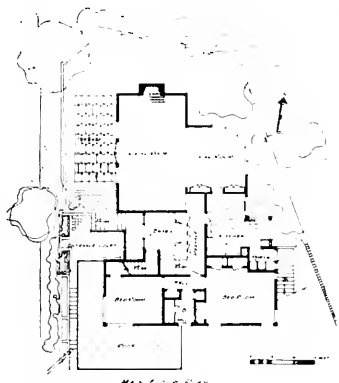

PLANS



ENTRANCE DETAIL

HOUSE FOR BERTRAM MYER



Left: Service walk, showing
Concrete Grid Walls.

Below: Entrance hall.

Below: Living room.



EDMONT, CALIFORNIA



Above: Dining room.

Below: Kitchen.

Right: Upper entrance hall landing.



DUPLEX DWELLING FOR MISS BEULAH LEMM



VIEW FROM STREET LEVEL

An interesting duplex built in anticipation of the war impact on this industrial area.

The Albany City Council cooperated by rezoning the district to accommodate the first architect-designed dwelling. Hillside patios are provided for both apartments.



Detail of step-back living rooms and garage . . . exterior treated in natural Redwood.

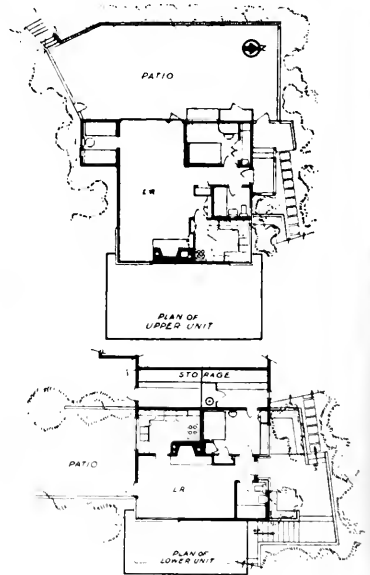

Plans

ARCHITECT AND ENGINEER

LBANY, CALIFORNIA



LIVING ROOM OF UPPER DWELLING

Fireplace: Common brick; walls and ceiling light cream stucco; cabinets painted.



Hillside view



Combined kitchen and laundry

OUR NATIONAL POST-WAR ECONOMIC PROBLEM

By **ARNOLD A. WEITZMAN, A.I.A.**

"Behold I create a new heaven and a new earth and the former shall not be remembered nor come into mind."

—(Isaiah LXV-17.)

I know that many people upon reading this article, will ask themselves: "What does he want? Isn't there such and such a board, and such and such a committee active?" Yes, indeed there are many, and from the architectural profession very active and excellent ones! But the criticism uttered in the last article, concerning such boards and committees, has even gained more significance by the accelerated pace with which events have been moving since that time. In it the complaint was made that while architects all over the country have joined in sincere and concerted effort and are producing marvelous results, there is as yet no means created for converting this effort into actual use as soon as the necessity for such work arrives after cessation of hostilities in Europe.

It seems that few people realize the enormity of the problem which this nation faces immediately after the command—"Cease Firing"—has been bugled. This problem is infinitely greater than what we faced during the last depression, unless effective measures are taken to solve the question of unemployment. In fact it will be the continuation of the depression which raged during the thirties and never ended when the war started in Europe. Unless we manage to create a solid peace prosperity the war prosperity will have been a mere interlude caused by the war and which will end with the finish of the war.

This depression, if negligence and complacency on the part of those who are in responsible charge of this nation's welfare allow it to recur, will be deepened by the addition to the ranks of the unemployed of a big segment of

our population (17,000,000 women) which have been transformed from housewives into industrial workers. They will continue to be job seekers and no government under democratic processes can drive them back into the kitchen! This is besides the, according to statistics, natural annual increase in job seekers of about two million during the last four years. On the other hand, technological advancement, with its accompanying more labor-saving devices, has been stepped up enormously, owing to the war production fever. These advanced methods on the field of production, the new economic status into which a large part of our population has entered as a result of the war and an attending new social status, these are factors that must enter the equation whenever the near economic future of our nation is being appraised.

The New World, about which we hear so much of late, as a future promise, is here. We live in it already. "The former shall not be remembered nor come into mind." Regardless of what statesmen will do or will not do, the old world has passed and the new is not to come after the war, but is here now. It has been born out of circumstances which no one can alter now. However, instead of making it a better world, our inactivity, or activity in the wrong direction may make it into a much worse one than the one which we saw passing. We should now resolutely form economic circumstances so that they are in consonance with this new world. Above all we must be serene and not permit ourselves to be carried along by mere slogans and nice phrases into a feeling of "everything will be all right!" Such readjustments as are required now do not just happen by themselves!

We should not fix the nation's hope on "conversion of industry" as an important factor to continue employment after the war. This would at best create a flashlike prosperity. Also in

Editor's Note—Mr. Weitzman's first article was published in *Architect and Engineer* for November under the heading "Actually Planning Post-War Work?" Both articles were originally prepared for the *Weekly Bulletin* of the Michigan Society of Architects to which we are indebted for permission to use.

many cases conversion of industry from war to peace production entails a mere reorganization; an expenditure of time only and even a temporary work stoppage; instead of that feverish and work-absorbing activity that people have been taught to think of in connection with "conversion." Also the much-talked of home building does not form a major source of employment to come. It may some day be a disappointment to many to find that a lot of the much-talked-of small housing building has been accomplished by the government in the form of war housing. It is hardly thinkable that all war houses, although they are not of substantial construction, will be scrapped after the war.

The surest solution to the problem of continued activity, as far as the building industry is concerned, lies in an extensive and well planned public works program and an expanding utility development program. There are many such projects which are self-liquidating in nature and are very necessary. Under this heading come:

1. Electrification of railroads wherever such a conversion from steam power is technically feasible.
2. Development of waterways.
3. Facilitating credit for home building.
4. Housing projects.

CIVIC IMPROVEMENTS

1. Development of abundant playgrounds and parks.
2. Resume the program of building schools, community centers, hospitals and other public

buildings. Also this program was interrupted by the war.

3. Road over-passes and under-passes. (This very urgent work had only a good start when it was entirely stopped. The highways and city arteries are full of life-endangering spots and the number of victims for which these danger points are responsible, is enormous throughout the nation.)

4. Resumption of an extensive highway and bridge building program.

These projects must be immediately arranged for by the Federal, State and City governments to be put into actual operation as soon as the war is over and material and labor can be diverted. In spite of the war, time and effort must be applied to this task, which is very urgent, for winning and alike for keeping the peace. Mere assertions of what we could do and even promise to do, is not sufficient; may they come even from the highest authorities in the nation. Things will have to be done, and even by methods that will appear to many of us unorthodox. Thus is the verdict of history, of the eternal power that destroys old worlds and builds new ones on the ashes of the old. As we are in a new world, new ways must be adopted and "the former shall not be remembered, nor come into mind."

Architects and engineers, who are the creators in the building industry, which, with its ramifications comprises 45% of the country's economic activity must teach, tell and tell again the American people, to make this still a better world, to live in it and for it.

STRUCTURAL ENGINEERS' ANNUAL MEETING

At the annual dinner meeting of the Structural Engineers Association of Northern California, December 7, election of officers and reports of the various committees featured the business session which preceded an illustrated talk by John E. Rinne on the Canol Project, a part of the U. S. Army Engineers' war program in Canada and Alaska. Mr. Rinne is structural engineer for the Standard Oil Company of California.

The Canol project, currently controversial, involves oil production in the Mackenzie River valley and a pipe line to the refinery in Alaska. Color slides illustrated Mr. Rinne's description of construction problems peculiar to the climate and geography of the Northland. At the outset of his talk the speaker

explained that he did not propose to debate details of the current controversy regarding the Canol project, which is reportedly under investigation, since his company is acting only as agent for, and is under specific orders of, the U. S. Army Engineers.

Retiring President J. B. Wells, professor of structural engineering, Stanford University, presided during the business session at which Clarence E. Seage, consulting structural engineer of San Francisco, was elected president (see Page 10), while J. G. Wright of Berkeley was elected vice-president. Consulting Structural Engineer John J. Gould was the third addition to the board of directors, while hold-over directors are M. C. Poulsen, secretary Port Costa Brick Works, and Theodore P. Dresser, Jr., manager of Abbott Hanks, Inc.

THE POST-WAR HOUSE BEAUTIFUL

(Continued from Page 23)

creative design? The former is a clerical occupation.

The architect will have to face the choice between the city planner, the engineer or industrial designer. All these activities are within his possibility. The profession must turn into an action group not unlike labor and industry and identify itself with a scheme of orientation, long-term by necessity. If we are to serve the masses, or the "one-third of the nation," we may have to deal with government agencies and dictates by standards. We will have to learn how to deal with city and state governments and their bureaus. If we are to participate in public works programs, will it be through a combination of private enterprise and pools of equipment, or government control, or a combination of both? We have no answers; many facts are known, however.

INDUSTRY

The recently built up prestige of pre-fabrication is based on an unanalyzed reputation. The industry was set up in business to meet emergency problems at the time when the officials were beholden to European examples. Its current standards may discredit the excellent lesson learned from its practice. It does not save time or money. The demountability factor is a saving device. Some suspect that the pre-fabricated house exists in the imagination of enthusiasts and by tax-exempt advertising. Standardization is as old as Adam, except to those who just discovered it. Meeting post-war requirements for a public will be more difficult because it will tend not to tolerate a type of building "by omission." On the other hand, high standards set up for mass acceptance proved not profitable so far.

To each dozen of construction formulae conjured up, there is no suggestion as to what will finance do to help solve the more pertinent questions of the future. The field of housing offers a vast opportunity, reports Mr. Amlie in the Nation, if we peg our national income at \$150,000,000 or \$200,000,000, but if we permit it to drop back to \$70,000,000 or \$80,000,000 then we are overhoused—not in terms

of human needs but in terms of what we can afford. I do not know whether I will be able to afford a Monocoque, a Mast hung, a Mechanical Core or a Modified Conventional house as the Michigan Society Weekly Bulletin summarized.

Nowadays a house is defined as a collection of catchy detail fostered by advertising. We have to educate first the houseless people in the art of the use of the domicile and its livability. The General Electric promises a future demand by women for automatic household equipment. This is probably true, since the stage was set before the war. Who will supply the House? Materials, gadgets and equipment will come and go mysteriously after a spell, only to reappear again in modified or improved guise backed by guarantees. Thus the purchasing public would have participated in the improvement of the product and pay for it.

PLANNING

Business and Industry is doing its own planning now, as reported by Advertising Age, and is urging its membership to conform to its provisions.

Are houses to be offered on a "retirement time-plan" or on the same antiquated basis? Will tax, insurance, and servicing of the offered house be made part of a plan involving land cost as well as a saner purchase scheme of furnishings and equipment for the consumer, "ready to move in." Will there be an industry comparable to the automotive which will actually take over the present sprawling mammoth house building field.

A neighborhood store system established by the large building materials companies in participation with the government may emerge. Services of site-fitting architects, landscapers and engineers should be included in the deal with guaranteed maintenance. A sort of expanded WPA based on the best of bygone experience. The lessons of the past emergencies must be utilized, for if the government subsidized war production and regulated manpower, why not continue to a degree during the first hardships of the peace emergency?

Why not now offer "house purchase saving bonds for people's houses" if saving as econ-

[Turn to Page 36]

**ARCHITECTS GREET
NEW A.I.A. PRESIDENT
AT LOS ANGELES**



Architects on the Pacific Coast have had an opportunity this month to personally meet the new Institute President, Raymond J. Ashton of Salt Lake City. A member of the A.I.A. since 1929 Mr. Ashton is best known as of the firm of Ashton, Evans and Hodgson, architects of many notable buildings in the Middle West, including the Mountain States Telephone & Telegraph Company Building, Salt Lake City, and the Geo. Thomas Memorial Library, University of Utah.

At the University Club, Los Angeles, the evening of January 11th, the new Institute president was greeted by an enthusiastic assemblage composed of Southern California, Santa Barbara and San Diego Chapter members and State Association Southern Group members.

Prior to the dinner Mr. Ashton was in brief conference with the Chapter Executive Committee for discussion of Institute affairs.

Later the architects participated in an open forum at which problems facing the profession were discussed.

At 6:00 a reception was held for the president, followed by dinner at 7:00. Public officials from the city, county, and state governments and leaders from the principal professional, business and civic organizations were guests of the Southern California Chapter, and special recognition was paid Sylvanus Marston, Harold Chambers and Winchton Risley, who have been elevated to Fellowship in the Institute.

The new officers of S. C. C. were installed and Herbert J. Powell, president elect, outlined briefly the program for the activities ahead. Mr. Ashton spoke on the importance of solidarity in the architectural profession and of its relationship to other elements of the construction industry and to government.

HUGE FLOOD CONTROL PROGRAM

The Pacific Division, Office of the U. S. Engineers, Sacramento, has endorsed a \$690,000,000 post-war dam construction program and is seeking immediate construction of two dams for flood control in the Butte basin at Stony Creek and Table Mountain.

The post-war project includes construction of seven multiple purpose dams on the Sacramento and American rivers at a cost of \$190,000,000 and a general expenditure of \$500,000,000 for power and irrigation development and flood control in the Sacramento and San Joaquin valleys.

Announcement!

COMPETITION FOR SANATORIUM IN IRELAND

COMHAIRLE CATHRACH ATHA CLIATH, EIRE
DUBLIN CORPORATION, IRELAND

The Dublin Corporation invites competitive designs for a new tuberculosis sanatorium (to accommodate 320 patients) to be erected at Ballyowen, Lucan, County Dublin.

The competition is open to all qualified architects who are members of the Royal Institute of the Architects of Ireland, the Royal Institute of British Architects, the American Institute of Architects, Registered Architects in any of the above countries or who are members of a similar body or society elsewhere.

The assessors are Messrs.

Harry Allberry, A.R.I.B.A. (Chairman)
Vincent Kelly, B. Arch., President, R.I.A.I.,
F.R.I.B.A.

John Murray Easton, F.R.I.B.A.
Ralph Byrne, F.R.I.A.I.

Dr. A. J. Walsh, M.B., B.Ch., D.P.H., Resident Medical Superintendent, Crooksling Sanatorium, County Dublin.

The premiums are € 500, € 350, £250, £150.

Application for the conditions should be made to The City Manager and Town Clerk, Corporation of Dublin, Public Health Department, Municipal Buildings, Dublin, and should be received by him not later than the 13th March 1944.

A deposit of three pounds and three shillings made payable to the City Treasurer, Dublin, Ireland, should accompany the application.

Deposit will be returned on receipt of a bona fide design or on the return of the conditions.

P. J. HERNON

City Manager and Town Clerk

THE POST-WAR HOUSE BEAUTIFUL

[Continued from Page 34]

omists hold, is good now, and spending will be healthy for the U. S. after the war?

What will the building industry labor be like? Will labor engulfed now with speedup building programs think about returning to traditional craft ways? Why not bring the fabrication to the job or site? This method may turn out to be more up-to-date with new erection machinery and techniques. New skills or diversification of labor may be needed for this type of fabrication. The present depletion in the ranks of the traditional building trades may require substitution by less skilled labor and mechanical methods. With the possible post-war WPB ministrations and restrictions, labor reports on its own planning suggesting release of building materials to make jobs with least lag and upset.

It is a two-way obligation for, if those responsible are unable to deliver, it may look as if a solemn promise had been broken.

In conclusion, we must investigate the whole problem in the light of present conditions and see how they can play their part in the future. We need a **purpose** and a **plan** to integrate all concerned to it; for the question of planning is the question of expert knowledge and understanding of problems involved and not tinkering. It is a matter of a long process of educational measures for the public. John Mill said, "Where the object is to raise a permanent condition of a people, small means do not merely produce small effects—they produce no effects at all."

S. F. ARCHITECTURAL CLUB

Plans for the new year were discussed at the last regular meeting of the San Francisco Architectural Club when the new officers presided for their first session.

The February 2nd meeting will be an open one and will feature a travel movie in technicolor and some very interesting news reels. The show will be put on by Henry Snyder and Charley di Cristina.

All draftsmen are invited to attend the club's open meetings which are held at the Builders Exchange, 666 Mission Street, at 8:15 on the first Wednesday of each month.

Newly installed officers are as follows: President, Clement A. Mullins; vice president, Hans Schickele; secretary, Leo F. Daly; treasurer, John Wasley; directors, John H. Arndt, A. M. Cantin, Robert Page; trustees, Leland Hyde, E. J. Rybicki and Ira H. Springer.

TEAMWORK for SECURITY

THERE IS NO SUBSTITUTE FOR A
HARDWALL PLASTER JOB

EMPIRE
GYPSUM PLASTER

STANDARD
GYPSUM PLASTER

RENO
GYPSUM PLASTER

PACIFIC
PORTLAND CEMENT COMPANY

FOR SOUND CONSTRUCTION

For the Post-war Home

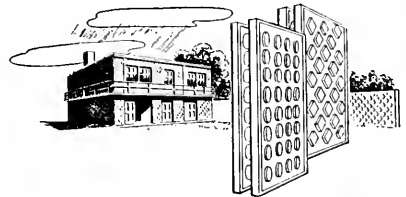

CONCRETE GRID FORMS

(Tomorrow's Way to Build Today)

A new tool to insure better buildings, better homes — of reinforced concrete. GRID FORMS are quickly and easily assembled and poured in place . . . they present a new framing method, practical and economical . . . they provide fire resistant, and termite-proof concrete structures.

Write, telephone or wire for
full particulars

CONCRETE GRID FORMS

George A. Scott

3075 Telegraph Avenue

Berkeley, Calif.

THE STATE ASSOCIATION OF CALIFORNIA ARCHITECTS

Northern Section

EDITOR

William C. Ambrose

Address all communications for publication in this department to W. C. Ambrose, 369 Pine Street, San Francisco.

STATE ASSOCIATION

Officers for 1944

President.....John S. Bolles
(Northern Section)
Vice-President.....Robert H. Orr
(Southern Section)
Second Vice-President.....Russell G. deLappe
(Northern Section)
Second Vice-President.....Vincent Palmer
(Southern Section)
Secretary.....Adrian Wilson
(Southern Section)
Assistant Secretary.....Malcolm D. Reynolds
(Northern Section)
Treasurer.....Ralph Wyckoff
(Northern Section)
Assistant Treasurer.....George E. Gable
(Southern Section)

Directors: Henry H. Gutterson, Regional Director, A.I.A.; Frederick H. Reimers, State Board of Architectural Examiners (Northern Section); Winsor Soule, State Board of Architectural Examiners (Southern Section).

Northern Section

President.....John S. Bolles
Vice-President.....Russell G. deLappe
Secretary.....Malcolm D. Reynolds
Treasurer.....Ralph Wyckoff

Directors: Norman K. Blanchard (for two years); Philip S. Buckingham (for two years); Henry H. Gutterson, Regional Director, A.I.A.; Andrew T. Hess, Northern Calif. Chapter, A.I.A.; Vincent G. Roney (one more year); Frederick H. Reimers, State Board of Architectural Examiners; Peter L. Sala, Central Valley Chapter, A.I.A.; Francis Ward (one more year); Alfred C. Williams (one more year).

Southern Section

President.....Robert H. Orr
Vice-President.....Vincent Palmer
Secretary.....Adrian Wilson
Treasurer.....George E. Gable

Directors: Henry H. Gutterson, Regional Director, A.I.A.; E. Keith Lockard, William P. Lodge, Charles O. Matcham, Captain E. Allen Sheet, Winsor Soule, State Board of Architectural Examiners.

COMPETITION

See Page 35 for official announcement of Irish Sanatorium Architectural Competition.

ARE WE WASTING THEIR MONEY?

The last time you wrote a specification for a residence (remember that far back?) did you cheat your client by making the house cost too much? Did you specify that at least one vent pipe should extend through the roof, with a diameter of not less than four inches all of the way? Did you specify that the studs should not be more than sixteen inches on centers? Did you specify that all soil pipes should be not less than four inches in diameter? If so, why did you do it?

Of course we know the answers—you specified those things as you did because the ordinance said that was the way they had to be. We wonder whether such an answer reflects very highly upon our professions. Some day we will be specifying things for houses again, and unless something is done about it, you will be specifying the same way that you did long years ago before the first bomb landed on the USS Oklahoma. In the meantime lots of things have happened even in the building of residences, and some more should be made to happen.

What we are trying to say is that it is about time for us to re-examine the standards which the building codes have made into law. If we are to build that fine new world about which we have filled so many pages of news print, isn't it about time that we get busy in finding out whether our pre-war standards are fit for use in that new world? Were our building code standards formulated from the demands of pressure groups so that their materials would be used in reckless abundance, or were they the result of scientific investigations?

We believe that the architectural and engineering professions, through their organizations and by individual effort, should be the leaders in making sure that the bases from which they work have the firm foundations of facts. Many an architect who has worked on war construction must wonder whether steel has a greater strength for five years of war service than it has for fifty years of peaceful life; whether there is reason to believe that a soil stack three inches in diameter can serve three years without clogging and not serve thirty years; whether studs in houses should be spaced to fit spans for laths when the house isn't going to have any laths; whether four inch studs are necessary on one story houses provided they are properly designed with three inch studs; and on, on, through a long list. It seems a little odd that we build a wall of glass with only an occasional support and if, instead of glass, we use a substantial bracing material to cover studs, then the supports must be sixteen inches on centers.

It may not be advisable to advocate whole new sets of building codes; we have too many of them already. But some house cleaning of the codes which we have is long overdue. We are fond of reciting that the architectural and engineering professions provide professional service. Might it not be a good idea to ask ourselves whether we are giving full measure of professional service when we make no effort to bring the technical standards under which we work to be in line with modern material characteristics and techniques? While we continue to use antiquated formulae we cannot truthfully say to our clients that we are not wasting their money.

We Are Puzzled

We are sometimes puzzled by data which happens to flow across our desk. We don't like to be captious, much less do we wish to be "smarty," but we do not quite understand the trend of events, at times.

Before us is a communication signed by Mr. Horace W. Peaslee, Secretary, Technical Board, Office of Civilian Defense, relating to the formation of technical committees to become acquainted with the problems of Civilian Defense, and to be ready for action on those problems when the occasion shall arise. We are assured that we must be vigilant.

Along side of this we read, in the construction reports of a public circulated newspaper, that plans are in process for the removal of camouflage where camouflage measures were deemed essential a few months ago. The camouflage is being removed, it may be assumed, by a branch of the service also having to do with the defense of our country. It just doesn't make sense.

New Committee Organization

An innovation in committee organization was inaugurated at the meeting of the Executive Board of the State Association of California Architects, Northern Section, on December 13, when President Bolles submitted lists of committee chairmen to the Board and received the Board's approval of his selections.

The committees for the ensuing year are divided into three main groups with each group under the direction of a Board member as general chairman. The general chairman of each group and the chairman of each special committee were approved as follows:

Public Relations, J. Francis Ward, chairman; Construction Industry, Wilbur D. Peugh; Publications, David H. Horn; Regional Planning, Carl F. Gromme; Exhibits, Ernest Born; Federation of Arts, Francis E. Lloyd.

Governmental Relations, Vincent G. Raney, chairman; Legislative, Keith O. Narbett; Local Government Bureaus, William Mooser; Federal Agencies, Andrew T. Hass.

Professional Relations, Alfred C. Williams, chairman; Program and Membership, Loy Chamberlain; Professional Practice, Chester Root; By-Laws, James H. Mitchell; Education, Howard Moise.

PAYNE GIVEN "E" AWARD

Payne Furnace & Supply Company, Inc., are a new advertiser this month. The company's Beverly Hills plant is running full time supplying war products and last November it received the Army and Navy "E" award for outstanding excellence in war production. When Uncle Sam no longer needs Payne war products the company will again turn to the manufacture of furnaces—new, even finer post-war models.



QUALITY AND DEPENDABLE *Service*

are the factors that influence architects and contractors when selecting lumber and mill work — Quality of merchandise — Integrity and Ability of the firm—Service in physical equipment — Experience and Personnel — All these factors contribute to a speedy and satisfactory completion of construction with minimum of time and expense.

MANUFACTURER OR DEALER IN

Douglas Fir—Redwood—Sugar and Ponderosa Pine — Plywood and Concrete Form Panels — Sash and Doors — Millwork — Insulation — Builders' Hardware.

E. K. WOOD LUMBER CO.

"Goods of the Woods" ©
LOS ANGELES • SAN FRANCISCO • OAKLAND

CORROSIRON

MADE IN U.S.A.
U. S. REGISTERED TRADE MARK

an acid resisting alloy for

**Pumps • Valves • Chemical
Coatings • Drain Pipe & Fittings**

ARCHITECTS AND ENGINEERS
ENGAGED IN WAR HOUSING
AND POST-WAR PLANNING MAY
CONSULT OUR ENGINEERING

DEPARTMENT WITHOUT
OBLIGATION



PACIFIC FOUNDRY COMPANY LTD.
Engineers and Metallurgists

3100 - 19th Street
SAN FRANCISCO

NEW YORK

SAN FRANCISCO

LOS ANGELES

PRODUCERS' COUNCIL PAGE

Northern California Chapter

The National Organization of Manufacturers of Quality Building Materials and Equipment
Affiliated with the AMERICAN INSTITUTE OF ARCHITECTS



R. H. RAY BROWN
Architectural Ambassador

Raymond H. Brown was the last of the double-duty Secretary-Treasurers, but so accustomed is he to extra effort that he still carries a double share of active interest in Chapter affairs.

As President in 1941, Ray's administration achieved the then unique distinction of being the first to operate on a balanced budget.

Ray was born in Virginia City, Nevada, in 1893 (would you believe it?), soon removed to San Francisco. World War I interrupted studies at Mark Hopkins Art Institute and Ray served his country as an officer in the U. S. Navy. The war changed his plans for studying architecture at the University of Pennsylvania so he characteristically went to work. From a cub draftsman he advanced through the granite business to cast stone to terra-cotta with Gladding, McBean & Co., where he is still close to his first love as head of the Architectural Products Department.

Ray lives in Corte Madera, is married and has a son, Donald, age 13. Family and golf are his hobbies and parenthetically speaking, he has been known to play a little poker come Friday night.

Look 'Em Over, the new set of officers for 1944. President, Horace L. Pickett, National Lead Company; Vice President, George B. Quamby, Detroit Steel Products Co.; Secretary, E. E. "Ed" Cathcart, Johns-Manville Sales Corp.; Treasurer, C. A. "Chat" Cook, H. H. Robertson Co.

To Hear the outgoing officers tell it, the Chapter had quite a successful year judging from the reports given at the annual meeting this month. Certain it is that Chapter members proved they were no "fair-weather" friends in the past disrupted year. Ties with architects and engineers were strengthened as evidenced by the tendency of various groups to look to the Producers' Council for support and backing.

President of the A.I.A., Raymond J. Ashton, writes of this relationship in the October issue of "The Octa-

gon" under the title "Our Affiliate—The Producers' Council." Mr. Ashton in reviewing the early beginnings of the Producers' Section of the A.I.A. states "The architect and the producer have a common interest in many more subjects today than at the time The Producers' Council was founded."

Elimination of Wastage in informational material was the initial motive that brought the two groups together.

A Broad Program of service to architects and engineers, the entire building industry and to the public as set forth in the Council's Articles of Incorporation resulted.

Mutual Advantages result in the benefits of the Architects Consultation service to Council members on the use and fabrication of quality materials and the review of advertising matter. Council Chapters serve the Architect by extending Council influence into local communities. Informational meetings have come to be looked upon as a fixture in Chapter activities. Dimensional Coordination is a cooperative effort, the result of which will simplify detailing of building projects for the architect and engineer and reduce the variety of sizes of materials and equipment for the manufacturer, all of which should give the owner better performance at reduced cost, the most practical approach to this very desirable objective yet devised. Project A62, of the American Standards Association—Coordination of Dimensions of Building Materials and Equipment is a joint A.I.A. and P.C. sponsorship. The Small Home Problem was jointly attacked by the two groups with the Federal Home Loan Bank Board. Contribution to the huge war construction programs was another joint effort and now as Mr. Ashton says, "Perhaps the greatest opportunity for collaboration by the two groups is afforded in the field of Post-War Planning. The Council's comprehensive program is a natural complement to the Institute's program—to direct the talents of the architect into the technical planning phases." **The Year Ended** with a big back-log of goodwill and ample working capital financially. It was not the policy of your outgoing officers to try to build up the Chapter's cash reserve materially but to do all possible our finances permitted and wind up with an ample balance for future contingencies.

Architect Guests at our annual meeting remind us that Al Evers and Fred Meyer were present at our first

(Turn to Next Page)

USE QUALITY PRODUCTS



CONSULT AN ARCHITECT

organizational meeting, and have met with us at annual meetings ever since.

Truscon Steel has joined the crusade for encouraging post-war planning now. Quoting Major General Philip B. Fleming, F W Administrator, "There will be no immediate postwar construction unless plans are made now." "Start planning with your Architect and Engineer right now," is their slogan.

To achieve its objectives the Producers' Council proposes a 21-point-post-war planning program divided into four major divisions. It is interesting to note in this connection that the Council does not concern itself with such problems as termination of war contracts, adequate provision of reserves, disposal of war plants, incentives for venture capital and other problems common to all lines of manufacture, the province of over-all business and industry organizations. The Council's Post-War Planning Committee recommends:

To Facilitate Reconversion to Peacetime Economy

1. Advance planning of Private Construction.
2. Work Pile Plan (a San Francisco idea).
3. Preparation by Industry.
4. Resumption of Civilian Construction—as fast as war requirements for critical materials and manpower decrease.
5. Advance planning of Public Improvements.
6. Disposal of Government Surpluses for rehabilitation abroad or through established trade channels.

Next Month we'll tell you about Council plans to expedite Technical advancement.

The New Weapon Against Fire IS **FIREPEL "S"**

A TIMELY CHEMICAL ACHIEVEMENT FOR THE TREATMENT OF UNFINISHED INTERIOR WOOD AFFORDING A PRACTICAL METHOD OF SUCCESSFUL FIRE RETARDATION

IN

Homes

Industrial Plants - Schools

THE ONLY FIRE RETARDANT COATING MATERIAL ON THE MARKET LISTED AND APPROVED BY

UNDERWRITERS LABORATORIES INC.

DISTRIBUTED BY



GUNN, CARLE & CO.

20 POTRERO AVE.
SAN FRANCISCO
UNderhill 5480

..... A BEAUTIFUL CHURCH INTERIOR

achieved at Temple Emanu-El Chapel, San Francisco, by the sympathetic collaboration of Architect and Craftsman (See Pages 13 and 16 this issue.)

Side walls of chapel are built of Australian silky oak lacewood veneer panels, redwood cored. Pews are jenisero. Reading desk and ark are finished in olive wood, figured mahogany and jenisero.

from the studios of

L. & E. EMANUEL INC.
2665 JONES STREET • SAN FRANCISCO

BAXCO

CHROMATED ZINC CHLORIDE

GLC

PRESSURE TREATED LUMBER
● **PROTECTS AGAINST DECAY
AND TERMITE ATTACK**

Specify it in your home

Available through Lumber Dealers

LOS ANGELES
601 W. 5th Street
Phone Mlchigen 6294

SAN FRANCISCO
333 Montgomery Street
Phone DOUGles 3883

J. H. Baxter & Co.

AGENTS FOR WEST COAST WOOD PRESERVING CO. SEATTLE, WASH

ARCHITECT AND ENGINEER

Estimator's Guide

Giving Cost of Building Materials, Etc.

AMOUNTS GIVEN ARE FIGURING PRICES AND ARE MADE UP FROM AVERAGE QUOTATIONS FURNISHED BY MATERIAL HOUSES TO SAN FRANCISCO CONTRACTORS. 2% SALES TAX ON ALL MATERIALS BUT NOT LABOR

All prices and wages quoted are for San Francisco and the Bay District. There may be slight fluctuation of prices in the interior and southern part of the state. Freight cartage, at least, must be added in figuring country work.

BONDS—Performance—50% of contract.
Labor and materials—50% of contract.

BRICKWORK—

- Common Brick—Per 1M laid—\$50.00 to \$60.00 (according to class of work).
- Face Brick—Per 1M laid—\$120 to \$150 (according to class of work.)
- Brick Steps—\$1.60 per lin. ft.
- Brick Veneer on Frame Bldg.—Approx. \$1.30 per sq. ft.
- Common Brick—\$19.00 per M, truckload lots, f.o.b. job.
- \$19.00 per M, less than truckload, plus cartage.
- Face Brick—\$40 to \$80 per M, truckload lots, delivered.
- Cartage—Approx. \$4.00 per M.

BUILDING PAPER—

- 1 ply per 1000 ft. roll..... \$3.50
- 2 ply per 1000 ft. roll..... 5.00
- 3 ply per 1000 ft. roll..... 6.25
- Brownskin, Standard, 500 ft. roll..... 5.00
- Sisalcraft, 500 ft. roll..... 5.00
- Sash cord com. No. 7..... \$1.20 per 100 ft.
- Sash cord com. No. 8..... 1.50 per 100 ft.
- Sash cord spot No. 7..... 1.90 per 100 ft.
- Sash cord spot No. 8..... 2.25 per 100 ft.
- Sash weights, cast iron, \$50.00 ton.
- Nails, \$3.42 base.
- Sash weights, \$45.00 per ton.

CONCRETE AGGREGATES—

- The following prices net to Contractors unless otherwise shown.
- Gravel, all sizes—**
\$1.95 per ton at Bunker; delivered..... \$2.50
- | | | |
|---------------------------------|--------|--------|
| | Bunker | Del'd |
| Top Sand..... | \$1.90 | \$2.50 |
| Concrete Mix..... | 1.90 | 2.45 |
| Crushed Rock, 1/4" to 3/4"..... | 1.90 | 2.50 |

- | | | |
|-----------------------------------|------|------|
| Crushed Rock, 3/4" to 1 1/2"..... | 1.90 | 2.50 |
| Roofing Gravel..... | 2.25 | 2.80 |
| River Sand..... | 2.00 | 2.45 |

Sand—

- | | | |
|---------------------------|------|----------|
| River Sand..... | 2.00 | 2.45 |
| Lapis (Nos. 2 & 4)..... | 2.85 | 3.15 |
| Olympia (Nos. 1 & 2)..... | 2.85 | 3.10 |
| Del Monte White..... | 84c | per sack |

Cement—

- Common (all brands, paper sacks), carload lots, \$2.42 per bbl. f.o.b. car; delivered \$2.72.
Cash discount on carload lots, 10c a bbl., 10th Prov.; less than carload lots \$3.20 per bbl. f.o.b. warehouse or delivered.
Cash discount 2% on L.C.L.
- | | | |
|----------------------|-------------------------------|---------------------------|
| Atlas White..... | } 1 to 100 sacks, \$2.50 sack | warehouse or del.; \$7.65 |
| Calaveras White..... | | |
| Medusa White..... | bbl. carload lots. | |

- Forms, Labors average \$200.00 per M.
Average cost of concrete in place, exclusive of forms, 35c per cu. ft.; \$10 cu. yd.; with forms, 60c.
4-inch concrete basement floor..... 30c per sq. ft.
Rat-proofing..... 7/12c
Concrete Steps..... \$1.25 per lin. ft.

DAMP-PROOFING and Waterproofing—

- Two-coat work, \$3.50 per square.
- Membrane waterproofing—4 layers of saturated felt, \$7.00 per square.
- Hot coating work, \$2.50 per square.
- Medusa Waterproofing, \$3.50 per lb. San Francisco Warehouse.
- Tricocel waterproofing.
(See representative.)

ELECTRIC WIRING—\$12 to \$15 per outlet for conduit work (including switches).

- Knob and tube average \$3.00 per outlet. (Available only for priority work.)

ELEVATORS—

Prices vary according to capacity, speed and type. Consult elevator companies. Average cost of installing a slow speed automatic passenger elevator in small four story apartment building, including entrance doors, about \$6500.00.

EXCAVATION—

- Sand, 60 cents; clay or shale \$1 per yd.
- Teams, \$12.00 per day.

Trucks, \$22 to \$27.50 per day.
Above figures are an average without water. Steam shovel work in large quantities, less; hard material, such as rock, will run considerably more.

FIRE ESCAPES—

Ten-foot galvanized iron balcony, with stairs, \$150 installed on new buildings; \$160 on old buildings.

FLOORS—

- Composition Floor, such as Magnesite, 33c to 50c per square.
- Linofilm—2 gages—\$1.25 to \$2.75 per sq. yd.
- Mastapay—90c to \$1.50 per sq. yd.
- Battleship Linoleum—available to Army and Navy only—1/8"—\$1.75 sq. yd.
3/8"—\$2.00 sq. yd.
- Terazzo Floors—50c to 70c per square.
- Terazzo Steps—\$1.75 per lin. ft.
- Mastic Wear Coat—according to type—20c to 35c.

Hardwood Flooring—

- Standard Mill grades not available.
Victory Oak—T & G
3/4" x 2 1/4"..... \$143.25 per M. plus Cartage
1/2" x 2"..... 122.00 per M. plus Cartage
1/2" x 1 1/2"..... 113.50 per M. plus Cartage
Prefinished Standard & Better Oak Flooring
3/4" x 3 1/4"..... \$180.00 per M. plus Cartage
1/2" x 2 1/2"..... 160.50 per M. plus Cartage
Maple Flooring
3/4" T & G Clear \$160.50 per M. plus Ctg.
2nd 153.50 per M. plus Ctg.
3rd 131.25 per M. plus Ctg.
Floor Layers' Wage, \$1.50 per hr.

GLASS—

- | | | |
|-----------------------------------|------------|--------------------|
| Single Strength Window Glass..... | 20c per | □ ft. |
| Double Strength Window Glass..... | 30c per | □ ft. |
| Plate Glass, under 75 sq. ft..... | \$1.00 per | □ ft. |
| Polished Wire Plate Glass..... | 1.40 per | □ ft. |
| Rgh. Wire Glass..... | .34 per | □ ft. |
| Obscure Glass..... | .27 per | □ ft. |
| Glazing of above is additional. | | |
| Glass Blocks..... | \$2.50 per | □ ft. set in place |

HEATING—

- Average, \$1.90 per sq. ft. of radiation, according to conditions.
- Warm air (gravity) average \$48 per register.
- Forded air, average \$68 per register.

IRON—Cost of ornamental iron, cast iron, etc., depends on designs.

LUMBER—All lumber at O.P.A. ceiling prices—

No. 1 Common	\$49.00 per M
No. 2 Common	47.75 per M
Select O. P. Common	52.75 per M

Flooring—

	Delvd.	
V.G.-D.F. B & Bfr. 1 x 4 T & G Flooring	\$80.00	
C 1 x 4 T & G Flooring	75.00	
D 1 x 4 T & G Flooring	65.00	
D.F.-S.G. B & Bfr. 1 x 4 T & G Flooring	61.00	
C 1 x 4 T & G Flooring	59.00	
D 1 x 4 T & G Flooring	54.00	
Rwd. Plastic—"A" grade, medium dry	82.50	
"B" grade, medium dry	78.50	

Plywood—

	Under \$200	Over \$200
"Plyscord"— $\frac{3}{8}$ "	\$49.50	\$47.55
"Plywall"— $\frac{1}{4}$ "	45.15	43.30
3 ply— $2\frac{1}{2}$ — $\frac{1}{4}$ "	48.55	46.60
"Plyform"— $\frac{3}{8}$ "—		
Unoil'd	126.50	121.45
Oiled	127.90	122.75

Above prices delivered if quantity is sufficient to warrant delivery.

Shingles (Rwd. not available)—

Red Cedar No. 1—\$6.75 per square; No. 2, \$5.75; No. 3, \$4.45.
Average cost to lay shingles, \$3.00 per square.
Cedar Shakes—Tapered: $\frac{1}{2}$ " to $\frac{3}{8}$ " x 25"—\$8.95 per square.
 Resawn: $\frac{3}{4}$ " to $1\frac{1}{4}$ " x 25"—\$10.65 per square.
 Resawn: $\frac{3}{4}$ " to $1\frac{1}{4}$ " x 25"—\$10.65 per square.
Average cost to lay shakes, \$4.00 per square.

MILLWORK—Standard.

O. P. \$100 per 1000. R. W. rustic \$100.00 per 1000 [delivered].
Double hung box window frames, average with trim \$6.50 and up, each.
Complete door unit, \$10.00.
Screen doors, \$3.50 each.
Patent screen windows, 25c a sq. ft.
Cases for kitchens pantries seven ft. high, per lineal ft., \$9.00 each.
Dining room cases, \$9.00 per lineal foot.
 Rough and finish about 80c per sq. ft.
Labor—Rough carpentry, warehouse heavy framing (average), \$40.00 per M.
For smaller work average, \$40.00 to \$55.00 per 1000.

MARBLE—See Dealers

PAINTING—

Two-coat work per yard 50c
Three-coat work per yard 70c
Cold water painting per yard 10c
Whitewashing per yard 8c

PAINTS—

Two-coat work 50c per sq. yd.
Three-coat work 70c per sq. yd.
Cold water painting per yard 10c
Whitewashing 8c per sq. yd.
Turpentine \$1.03 per gal. in drum lots.
 \$.08 per gal. in 5-gal. containers.
Raw Linseed Oil—not available.

Boiled Linseed Oil—\$1.38 per gal. in drums. Available only to work with high priority—\$1.48 per gal. in 5-gal. containers.

Use replacement oil—\$1.86 per gal. in 1-gal. containers.

Replacement Oil—\$1.20 per gal. in drums. \$1.30 per gal. in 5-gal. containers.

A deposit of \$6.00 required on all drums.

PATENT CHIMNEYS—

6-inch	\$1.20 lineal foot
8-inch	1.40 lineal foot
10-inch	2.15 lineal foot
12-inch	2.75 lineal foot

PLASTER—

Neat wall, per ton delivered in S. F. in paper bags, \$17.60.

PLASTERING (Interior)—

3 Coats, metal lath and plaster	Yard	1.50
Keene cement on metal lath		1.80
Ceilings with $\frac{3}{4}$ hot roll channels metal lath (lath only)		1.20
Ceilings with $\frac{3}{4}$ hot roll channels metal lath plastered		2.20
Single partition $\frac{3}{4}$ channel lath 1 side (lath only)		1.20
Single partition $\frac{3}{4}$ channel lath 2 inches thick plastered		3.20
4-inch double partition $\frac{3}{4}$ channel lath 2 sides (lath only)		2.20
4-inch double partition $\frac{3}{4}$ channel lath 2 sides plastered		3.85
Thermex single partition; 1" channels; $2\frac{1}{4}$ " overall partition width. Plastered both sides		3.30
Thermex double partition; 1" channels; $4\frac{3}{4}$ " overall partition width. Plastered both sides		4.40
3 coats over 1" Thermex nailed to one side wood studs or joists		1.65
3 coats over 1" Thermex suspended to one side wood studs with spring sound isolation clip		1.90

Note—Channel lath controlled by limitation orders.

PLASTERING (Exterior)—

2 coats cement finish, brick or concrete wall	Yard	\$1.00
3 coats cement finish, No. 18 gauge wire mesh		2.00
Lime—\$3.00 per bbl. at yard.		
Processed Lime—\$3.10 bbl. at yard.		
Rock or Grip Lath— $\frac{3}{8}$ "—20c per sq. yd.		
$\frac{1}{2}$ "—19c per sq. yd.		

Composition Stucco—\$1.80 to \$2.00 sq. yard (applied).

PLUMBING—

From \$100.00 per fixture up, according to grade, quantity and runs.

ROOFING—

"Standard" tar and gravel, 4 ply—\$8.00 per sq. for 30 sqs. or over.
Less than 30 sqs. \$9.50 per sq.
Tile, \$30.00 to \$40.00 per square.
Redwood Shingles, \$7.50 per square in place.
5/2 # 1-16" Cedar Shingles, 4/2"
Exposure \$8.00 square

5/8 x 16"—#1 Cedar Shingles, 5"
Exposure \$9.00 square
4/2 # 1-24" Royal Shingles, 7/2"
Exposure \$9.50 square
Re-coat with Gravel \$4.00 per sq.
Asbestos Shingles, \$23 to \$28 per sq. laid.
1/2 x 25" Resawn Cedar Shakes.
10" Exposure \$10.50
3/4 x 25" Resawn Cedar Shakes.
10" Exposure 11.50
1 x 25" Resawn Cedar Shakes.
10" Exposure 12.50
Above prices are for shakes in place.

SHEET METAL—

Windows—Metal, \$1.75 a sq. ft.
Fire doors (average), including hardware, \$2.00 per sq. ft.

SKYLIGHTS—(not glazed)

Copper, 90c sq. ft. (flat).
Galvanized iron, 40c sq. ft. (flat).
Vented hip skylights 60c sq. ft.

STEEL—STRUCTURAL (None available except for defense work).

\$150 ton (erected), this quotation is an average for comparatively small quantities. Light truss work higher. Plain beams and column work in large quantities \$140 per ton.

STEEL REINFORCING (None available except for war work).

\$150 to \$200 ton, set.

STONE—

Granite, average, \$6.50 cu. foot in place.
Sandstone, average Blue, \$4.00. Boise. \$3.00 sq. ft. in place.
Indiana Limestone, \$2.80 per sq. ft. in place.

STORE FRONTS (None available).

TILE—

Ceramic Tile Floors—70c to \$1.00 per sq. ft.
Cove Base—\$1.10 per lin. ft.
Glazed Tile Wainscot—\$1.25 per sq. ft.
Asphalt Tile Floor $\frac{1}{8}$ " & $\frac{3}{16}$ "—\$.18 to \$.35 per sq. ft. Light shades slightly higher.
Cork Tile—\$.40 to \$.75 per sq. ft.
Mosaic Floors—see dealers.
Lino-Tile, \$.35 to \$.75 per sq. ft.

Wall Tile—

Glazed Terra Cotta Wall Units (single faced) laid in place—approximate prices:
2 x 6 x 12 \$1.10 sq. ft.
4 x 6 x 12 1.25 sq. ft.
2 x 8 x 16 1.20 sq. ft.
4 x 8 x 16 1.40 sq. ft.

VENETIAN BLINDS—

40c per square foot and up. Installation extra.

WINDOWS—STEEL (None available).

PLASTICS FOR ASPHALT ROOFS

The building industry appears to afford a large field for post-war synthetic plastics, even with apparently small items, especially if costs are reduced as a result of tonnage production. Dr. John M. Weiss, New York industrial chemist, says in a report to the American Chemical Society.

"For example," says Dr. Weiss, "felt-base asphalt-saturated roll roofing and shingles, often coated with slate or other colored mineral granules, is a very popular type of residential roofing, especially in low-cost housing construction.

"It is doubtful if, from a material standpoint, prepared roofing based on synthetic plastics will ever reach the price levels of asphalt felt-base roofings, but cost of the roofing is only part of the story. Freight, sales expense, and especially the cost of applying the roofing also enter the picture. Effective life is another factor, since properly prepared synthetic plastic products should give longer service than the average felt base-asphalt products.

"The final criterion should be the average cost of the roof per year of service. Judged from this standpoint, the price of certain synthetic plastics is approaching the range where their adoption in certain parts of this field may be soundly justified. Moreover, unique decorative effects may be obtained with synthetic plastic products, which are not attainable with present roofing and siding materials.

"At present, the output of felt base-asphalt roll roofing, shingles, and siding aggregates about 3,000,000 tons per year. A relatively small percentage of this corner of the building industry would form the basis for at least a 100 per cent expansion of the synthetic plastic production.

"Extending our imagination to the replacement of wood in certain uses by rot-proof, termite-proof, non-inflammable, and washable compositions, the possible field for expansion of the synthetic plastics is extremely large."

30% BUILDING RISE PREDICTED

According to a recent analysis of the Post-war building market by Wilson E. Wright of the Producers' Council, construction costs are expected to rise 30 per cent over 1940 levels. A \$5,000 residence built in 1940 will cost after the war approximately \$6,500.

The figure of \$146.3 billion is arrived at as the best approximation of the average annual "gross national product" for years 1947-51, using 1940 prices as yardstick. If current prices are used instead, the estimate rises to \$194 billion. Post-war construction estimates in the table are given in terms of both price levels, and total respectively \$12.49 billion and \$16.24 billion per year.

The committee estimates that the above figures would allow for 972,000 dwelling units annually on the average for the year 1947-51, at a current cost of \$6.38 billion per year.

HOGAN LUMBER CO.

Wholesale and Retail

LUMBER

MILL WORK • SASH & DOORS

Office, Mill, Yard and Docks

SECOND AND ALICE STREETS • OAKLAND, CALIF.

Telephone GLencourt 6861

CLINTON CONSTRUCTION CO. OF CALIFORNIA

General Contractors

923 FOLSOM STREET • SAN FRANCISCO

SUtter 3440

FORDERER CORNICE WORKS

Manufacturers of

Hollow Metal Products • Interior Metal Trim
Elevator Fronts and Cabs
Metal Plaster Accessories • Sanitary Metal Base
Flat and Roll Metal Screens
Metal Cabinets • Commercial Refrigerators

269 POTRERO AVE.

SAN FRANCISCO, CALIF.

HEMLOCK 4100

STRUCTURAL STEEL

**For Class A Buildings,
Bridges, etc.**

JUDSON PACIFIC CO.

**1200 SEVENTEENTH STREET
SAN FRANCISCO**

==== Plants: San Francisco - Oakland ====

The Most Complete Line of
STEELS and BUILDING MATERIALS
Made by a Single Producer



See Sweet's Catalog File or write us for
 full information.

REPUBLIC STEEL CORPORATION
 GENERAL OFFICES: CLEVELAND, OHIO

DENVER, COLORADO CONTINENTAL OIL BUILDING
 LOS ANGELES, CALIFORNIA EDISON BUILDING
 SALT LAKE CITY, UTAH WALKER BANK BUILDING
 SAN FRANCISCO, CALIFORNIA RIALTO BUILDING
 SEATTLE, WASH. WHITE-HENRY-STUART BUILDING

REMILLARD - DANDINI COMPANY

**BRICK AND MASONRY
 PRODUCTS**

633 Bryant Street, San Francisco
 569 Third Street, Oakland

PACIFIC MANUFACTURING CO.

HIGH CLASS INTERIOR FINISH
 QUALITY MILLWORK

142 SANSOME ST., SAN FRANCISCO
 Garfield 7755

6820 McKINLEY AVE., LOS ANGELES
 THornwall 4196

BUILDERS EXCHANGE, OAKLAND

HAYDITE

used for light-weight concrete on
 St. John's Episcopal Church,
 Marysville

(Illustrated in this issue)

The designed concrete mix specified
**SELECTED HAYDITE LIGHT WEIGHT
 AGGREGATES**

Manufactured by

McNEAR BRICK COMPANY
 Rialto Building, San Francisco

"AMERICAN MARSH" Redi-Vac Vacuum Heating Pump



Send for
 Bulletin 441

SIMONDS MACHINERY CO.

San Francisco
 816 Folsom St.

Los Angeles
 455 East Fourth St.

SISALKRAFT

REG. U. S. PAT. OFF.

"More than a building paper"

THE SISALKRAFT CO.

205 West Wacker Drive
 Chicago, Ill.

55 New Montgomery Street
 San Francisco, Calif.

VERMONT MARBLE COMPANY

Producers and Finishers
 of

Domestic and Imported Marbles

Write for new pamphlet describing our
 Marble Toilets and Showers

San Francisco and Los Angeles
 San Francisco phone: SUTTER 6747



BASALITE

CAMBERED SHINGLE TILE

**PERMANENT • FIREPROOF • STORM-
 SAFE • COLORFUL • ECONOMICAL**

Manufactured by
BASALT ROCK CO., INC.
 NAPA, CALIFORNIA

MULLEN MFG. COMPANY

BANK, STORE AND OFFICE
FIXTURES—CABINET WORK
OF GUARANTEED QUALITY
CHURCH SEATING

Office and Factory:
40-80 RAUSCH ST., Bet. 7th and 8th Sts.
San Francisco
Telephone UNderhill 5815

THE TORMEY COMPANY

GENERAL PAINTERS
AND DECORATORS

Phone UNderhill 1913

563 FULTON STREET
San Francisco

ABBOT A. HANKS, INC. Engineers & Chemists

INSPECTING — TESTING — CONSULTING
CONCRETE • STEEL • MATERIALS
CHEMICAL AND TESTING
LABORATORIES
• RESEARCH AND INVESTIGATION •

DESIGN OF STRUCTURAL MATERIALS
SYSTEMS OF CONCRETE MIXES
SHOP AND ERECTION INSPECTION OF
STRUCTURES AND EQUIPMENT
INVESTIGATION OF STRUCTURES
AND MATERIALS
TESTS AND INVESTIGATION OF
FOUNDATION SOILS
FIRE RESISTANCE AND INSULATION
TESTS

624 Sacramento Street, San Francisco

Robert W. Hunt Company ENGINEERS

Inspection • Tests • Consultation
Schools and Other Structures
Are Built as Designed

*When Construction Materials are
Inspected at point of Manufacture
and during Erection by*

ROBERT W. HUNT COMPANY

*Cement, Concrete, Chemical, Metallurgical,
X-Ray and Physical Laboratories*

Chicago • New York • Pittsburgh
Los Angeles • All Large Cities
San Francisco, 251 Kearny Street

LAMPS LIGHTED BY RADIO BEAMS

To help plan the better homes, hotels and public buildings of tomorrow a group of prominent architects and designers were recently shown lamps lighted by wireless electronic power, a 10,000-watt mercury vapor lamp one-fifth the brightness at the surface of the sun, and watched an electric lamp cook bacon and eggs. The demonstration of laboratory models of new lamps, and of wartime and possible post-war uses of lamps and light, was conducted by Samuel G. Hibben, director of applied lighting for the Westinghouse Lamp Division, at the Waldorf-Astoria, in New York City.

Walking about the room carrying brilliant, vari-colored fluorescent tubes fully lighted although they were unconnected to sockets or electrical wiring, Mr. Hibben said:

"Although practical use of electric power transmitted without wires—except for signal purposes—is probably many years away, the spectacular strides in development of electron generating tubes we have made during World War II seem to be leading in that direction.

"Actually, these lamps are not connected with any power source. They are electronically harnessed to a beam of high frequency radio energy generated here in this room by a pre-war diathermy set such as your doctor might use to treat a cold in your chest.

"Generators vastly more powerful than this therapeutic apparatus are serving in wartime radio and communications equipment by transmitting radio waves in beams. This engineering advance, now applied wholly to fighting the war, conceivably may bring about the peacetime expansion of wireless power," the lighting expert continued, adding:

"Baby brothers of the fluorescent lamps now so widely used in war plants are illuminating bomber cockpits and airplane instrument panels. After the war, these six-inch long and other miniature fluorescents will have many safety and comfort applications. Because they use less current than an electric clock, they can be



SUNDAYS OR HOLIDAYS

Don't wait for "the bank to open." With our Mailway service, and special envelopes and passbook, do your banking with us by mail at your nearest mailbox. More and more people are opening Mailway accounts because they can do their banking when most convenient. Open a Mailway account today... checking or savings, business or personal.

Write for information

CROCKER FIRST NATIONAL BANK

OF SAN FRANCISCO
California's Oldest National Bank

Member Federal Deposit Insurance Corporation
ONE MONTGOMERY STREET

LANDSCAPING WAR HOUSING PROJECTS

Maritime Commission
Apartments, Richmond
Sunnydale
G. G. Bridge Approach
Roosevelt Terrace, Vallejo
Camp Roberts
Chabot Terraces, Vallejo
Peralta Villa, Oakland
Sausalito
Union Square Garage



Growers and Distributors of
"Superior Quality" Nursery
Stock Since 1878

LEONARD COATES NURSERIES, INC.

Ray D. Hartman, President/Manager

SAN JOSE, CALIFORNIA

Built-In Fixtures for the Post-War Home

Paramount Fixtures will fit your post-war needs . . . investigate our new kitchen ideas which make for convenience and efficiency.

Paramount Built-in Fixtures meet the most exacting requirements. Our "Deluxe," "Moderne" and "Economy" cabinet fixtures are distinctive in design and construction and may be had in stock sizes or built to order.

Catalog for the asking



left burning night and day for such jobs as lighting clock faces and house numbers.

"Meanwhile, we have a fluorescent laboratory development, admittedly crude, devised from two glass pipe plates. It shows that fluorescent lamps are not limited to tubular shape. Such lamps as these, with their cool and shadowless light, offer both practical and decorative advantages for hotel halls and public buildings.

"And we've also discovered that we can use the tubular-shaped fluorescents in other than the conventional straight form. Because we can bend the tubing, circular lamps are a possibility for post-war homes."

PLAN NEW HOMES NOW

Many families hoping to acquire new homes immediately after the war face prolonged delay and disappointment unless they complete soon arrangements for starting construction at the first opportunity, according to a statement by Russell Creviston, general post-war chairman of the Producers' Council.

As soon as war-time restrictions on residential construction are removed, builders, architects, contractors, and material and equipment dealers will be swamped by the pent-up demand for construction of all types, with the result that many prospective buyers of new houses will be forced to wait as long as a year or more before their hopes can be realized, Creviston said.

"A recent estimate by the Market Analysis Committee of the Producers' Council indicates that only about 350,000 new dwelling units will be constructed by builders and contractors during the first twelve months after the end of the war, while nearly 2,000,000 additional housing accommodations will be needed immediately after the war ends to house new families formed since 1941," the statement pointed out.

"Builders in cities and towns throughout the country are now planning their operations for the post-war period. Until their organizations can be completely mobilized and until materials and equipment are freely available, these builders can take care of only a small part of the potential

DINWIDDIE CONSTRUCTION COMPANY • BUILDERS •

CROCKER BUILDING
SAN FRANCISCO



HERRICK IRON WORKS STRUCTURAL STEEL REINFORCING STEEL

18TH AND CAMPBELL STS.
OAKLAND, CALIF.
Phone GLencourt 1767

G. P. W. JENSEN & SON

Building Construction

320 Market Street, San Francisco
Phone: GARfield 2444

JOHN CASSARETTO

—Since 1886—And Still Active—

Building Material

READY MIX CONCRETE
ROCK - SAND - GRAVEL - LIME
CEMENT - PLASTER - MORTAR
METAL LATH - WOOD LATH
STUCCO - WIRE NETTING

Service Unexcelled

Bunkers
Sixth and Chennel, San Francisco
Phones: GARfield 3176, GARfield 3177

Phone GARfield 1164

Thomas B. Hunter

Consulting Engineer

DESIGNER OF HEATING
AIR CONDITIONING
VENTILATING AND WIRING
SYSTEMS, MECHANICAL
AND ELECTRICAL EQUIP-
MENT OF BUILDINGS

41 SUTTER STREET
ROOM 710
San Francisco California

ANDERSON & RINGROSE

General Contractors

320 Market Street, San Francisco
Phone GARfield 2245

demands for homes. Prospective home owners who want quick action should see a builder without delay and make all necessary advance arrangements.

"Individuals who want a specially designed home should arrange now for architectural service, have plans and specifications prepared, select a site, and make other necessary arrangements so that construction can be started with the minimum of delay after restrictions are removed.

"The home buying public tends to forget that four to six months often must elapse between the time when they first approach their architect and the time when actual construction can begin. The intervening time is required for drafting and approving plans and specifications, selecting equipment, obtaining bids, and getting the work under way."

Advance planning of residential construction also will help greatly to reduce the temporarily heavy period of unemployment which is predicted for the months immediately after the end of the war with Germany when factories now engaged in manufacture of war goods are reconverting to production of civilian requirements, Creviston stated.

"If advance planning of residential construction continues at the slow rate indicated by recent reports, the country may face the unfortunate situation where both employment and the volume of construction will fall well under the attainable maximum in the early post-war period. This might easily lead to large-scale resumption of a WPA program under which further huge sums of Federal money would be spent for non-essential made-work projects."

RADIANT HEATING

Unlike most of the revolutionary changes suggested for the immediate post-war period, many of which may have to wait years for development, radiant heating by means of floor, wall or ceiling pipe coils already has achieved some 600 successful installations of record in homes, factories and commercial structures.

Radiant heating, in the opinion of

many competent authorities, has arrived at a stage in its development that entitles it to consideration for all types of structures when resumption of private building is allowed.

Recently a national magazine mailed a questionnaire to several thousand subscribers and one of the questions asked was, "What type of heating system would you like to have?" When the returns (which were unusually high) were tabulated, it was found that better than 40 per cent wanted a radiant heating system. The circumstance which makes this result so surprising is the fact that no one, so far as known, has even spent a cent to directly promote with the public the use of radiant heating.

Charles A. Hawk, with the engineering service department of the A. M. Byers Company, in an address before the Engineers' Club of Omaha, described radiant heat as nothing more than a system of producing comfort conditions by means of large, warm, room surface areas instead of depending on the movement of relatively high-temperature air currents.

Commenting on the floor type system the speaker said:

"In the structural sense the floor type radiant heating system is exactly the same as the conventional forced hot water system except that pipe coils are substituted for radiators. The same boilers, expansion tanks, circulators, etc., are used, and you may safely consider the integration of these elements to be exactly the same for the radiant heating system as for the conventional hot water system.

"Among the questions most often asked about floor type systems are, 'Doesn't the floor get too hot?' and 'Will it work with wood floors or rugs?' The answer to the first question is that a properly designed system will never produce floor surface temperatures above 85 degrees and this temperature—based on the experience of hundreds of installations—is not excessive. As a matter of fact, it is almost impossible to tell where the heat is coming from in a properly designed installation even though floor temperatures do reach 85 de-

What's On Your Mind?

ALOHA!

Editor,

Architect and Engineer:

May I take the liberty of up-to-dating you on your "Architects Still On the Move" column? Ensign William B. McCormick is no longer at address given in your October issue. New address is: Lt. Cmdr. William B. McCormick, U.S.N.R., Comcenpac Staff, c/o Fleet Postmaster, San Francisco.

In his absence, I send you his Aloha!

Sincerely,

AGNES A. McCORMICK.

2417A Sonoma Drive,
Honolulu 54, T. H.

YOUTH LIKED IT

Editor,

Architect and Engineer:

Congratulations on your November issue. It certainly appealed to the younger generation of architects. An all around good number.

Yours for more like it,

J. R.

San Francisco.

THE WEITZMAN ARTICLES

Editor,

Architect and Engineer:

In answer to your letter of Dec. 3, the articles referred to were both prepared for the Weekly Bulletin of the Michigan Society of Architects and it will be appreciated if you give our publication a credit line.

I thank you very much for your compliment and encouraging words. The articles were written as a part of my activity as a member of the "committee on practice and education," of this state's Society.

Your publication has special appeal to me for I strongly adhere to and often talk for the integration of architecture and engineering.

ARNOLD A. WEITZMAN.

Detroit, Dec. 9, '43.

Independent Iron Works

Structural Steel
Ornamental Iron
Steel Service Stations
Steel Tanks
Standard Steel Mill Buildings
Bridges

821 Pine Street

Oakland

grees. This surface temperature question also bears a relation to the question of floor construction and coverings. However, I believe it is safe to assume—again basing the assumption on the results of a great many installations involving all types of floor construction and coverings—that just about any of the common materials can be used.

"The matter of insulation is one which should receive just as much attention in a house having a radiant system as is given to the same problem when a conventional heating system is used."

In regard to cost of installing a radiant heating system perhaps the best index can be had from a comparison of the costs of actual complete installations with the total cost of the structures involved. This provides a figure which in turn can be compared with the same cost ratio for conventional systems. On this basis, it has been demonstrated that radiant heating systems will average from 6 to 10 per cent of the total cost of the structure. Consider these three examples, all 6-room houses:

House No. 1 cost \$8,000 of which the radiant heating system accounted for 6.8 per cent.

House No. 2 cost \$6,500, the heating system accounting for 7.5 per cent.

House No. 3—\$5,200, with 9.6 per cent going into the heating system.

These figures compare favorably with any good conventional system.

Naturally when comparing the cost of any two heating systems care should be taken to see that the comparison is made on an equal basis. Where such refinements as zone control, anticipating thermostats, aquastats, etc., are involved, they should be either allowed for or included in all systems being studied.

Comparative operating costs have also been a little hard to pin down, according to Mr. Hawk, but available data indicates that measurable economy, in some cases as much as from 15 to 30 per cent, can be expected.

FEDERAL HOUSING

During the last several months, government financed housing for war workers has been completed at an average rate of 1,000 units a day, according to the Federal Public Housing Authority.

A total of 236,697 units were completed in the first seven months of 1943, twice the number completed in the last seven months of 1942, according to Herbert Emmerich, FPHA Commissioner. A total of 174,306 dwelling units were under construction at the end of July, and contracts were yet to be let for 60,747 more under the present program.

Since July 1, 1940, a total of 470,924 units have been completed, of which 321,380 were family units, 122,137 dormitory units and 27,407 trailer units.

These production records do not include the dwelling units to be made available through government conversion of existing homes and other structures under the National Housing Agency's home use program. As of the end of August, 26,109 such units were under lease to the government for conversion, some 15,531 of which are completed or under construction. —Engineering News-Record.

START PLANNING NOW

Architects will be kept busy throughout the country during the current year if home builders, local officials in charge of public works, and business concerns planning post-war expansion read the handwriting on the wall. L. C. Hart, member of the executive committee of the Producers' Council, asserted in a talk before a joint meeting of the Philadelphia Chapter, American Institute of Architects, and the Philadelphia District, Pennsylvania Assn. of Architects.

Hart pointed out that war developments may make it possible to resume certain types of private construction in a relatively short time and that those projects which have been fully developed and carried through to the blueprint stage naturally will be the first to get under way when wartime restrictions are removed and building products and construction

labor again becomes available.

"In view of the vast amount of construction, both private and public, which is contemplated for the immediate post-war period, architectural services will be in great demand, and many projects which could be developed in detail at the present time, in advance of the removal of restrictions, will have to wait their turn if the decision to get plans started is delayed," he said.

"Lack of complete information about the nature of post-war building products need be no obstacle to immediate planning of construction. Changes in prospect will for the most part be evolutionary. Architects are safe in assuming that practically all pre-war lines of materials and equipment will reappear on the market in the early post-war months, and that changes for the most part will consist of improvements and refinements on products available before the war. If necessary, minor revisions in plans and specifications can be made at the last minute to accommodate the relatively few materials and equipment which will be greatly changed from pre-war designs.

"Manufacturers of building products have many new lines in prospect for post-war use, but most will require further perfection and testing before they can appear on the market.

"Research and development are going on continuously and over the past twenty years a long list of improvements adding comfort and convenience to the average home have been moved out of the luxury class and made available in the ordinary low priced residence. As a result of this development work, private construction enterprise has produced values second to no other industry in return for the consumer's dollar investment."

A. F. MATTOCK CO.

Builders

★

212 CLARA STREET
SAN FRANCISCO

ARCHITECT AND ENGINEER

THIS ISSUE

•
"Parklabrea"
PERIODIC Apartments

•
Nation's Largest
Cafeteria

•
New Trends in
Store Fronts

•
The Post-War
Kitchen

•
FEBRUARY, 1944

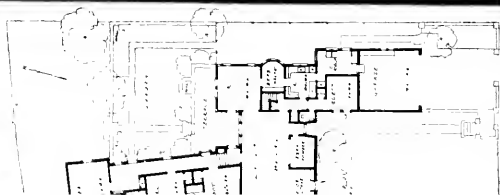

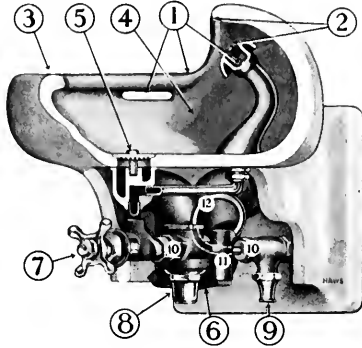

Re-design with **HAWES!**

Many industries will re-design their plants, factories or buildings after the war for greater peacetime production and better working conditions. These same industries can re-design their drinking water facilities NOW!

HAWES Drinking Fountains and Faucets can now be supplied free from restrictions, with immediate delivery available. (W.P.B. Order L-79).

HAWES angle stream drinking Fountains and Faucets meet the requirements of the American Public Health Association in regard to the construction, design and operation of sanitary drinking fountains.

Insist on HAWES! — Have you our latest catalog?

1. Orifices of all HAWES Fountains are one inch above the rim of the bowls to protect the fresh water supply from contamination in the event of flooded bowls. Safety-overflow under the rim is installed on many of HAWES fountains.

2. Good stream clearance is provided on all HAWES angle stream fountains. Streams do not touch the guard.

3 & 4. HAWES Fountains are constructed of vitreous china and are free from dirt collecting corners.

5 & 6. Efficient strainer and wastes are provided. All cast traps have clean-out plugs.

7, 8 & 9. On the greater number of HAWES Fountains the control of water is provided by use of self-closing valve, with concealed flow regulating screw. On other HAWES Fountains a flow regulator or loose-key stop in conjunction with a self-closing valve is used. STREAM CONTROLLED fountains have diaphragm type pressure regulating valve governing the water pressure and volume.



HAWES Model No. 7A

Haws DRINKING FAUCET COMPANY

1808 HARMON STREET • BERKELEY, 3 • CALIFORNIA

Agents in the following cities:

Chicago • Los Angeles • San Francisco • Seattle • Salt Lake City • Portland • New Orleans
Houston • Atlanta • Philadelphia • Worcester, Mass. • Newark, New Jersey • Richmond, Virginia

ARCHITECT AND ENGINEER

Volume 156 No. 2

FRED W. JONES
Editor

MARK DANIELS
Associate Editor

L. H. NISHKIAN
Consulting Editor

MICHAEL GOODMAN
Post-War Planning

E. N. KIERULFF*
Ass't Editor
*In the Service

FEBRUARY CONTENTS

COVER: Residence of William R. Dorr, Palos Verdes
Winchton L. Risley, Architect

PHOTOGRAPHY:

Ryan Aeronautical Co.
Parklabrea Apartments: Southwest Builder and Contractor
Store Fronts: The Kewneer Co.
Kitchen of Tomorrow: Courtesy Libbey-Owens-Ford

ARTICLES:

Long Span Wood Roof Trusses for War Plant . . .	15
Lockheed Builds Nation's Largest Cafeteria . . .	16
Parklabrea Apartments	19
New Trends in Post-war Store Fronts	24
The Post-war Kitchen	26
Fireproof Wooden Hangars for Patrol Blimps Frederick Hamilton	29
When Architect's Acceptance of Check Spells Pay- ment in Full Leslie Childs	23
Architects, Get Busy . . . Miles A. Coleen, A.I.A.	31

ILLUSTRATIONS:

Bowspring Roof Trusses	14
Lockheed Commissary Club Parkinson & Parkinson, Architects	16
Parklabrea Apartments Leonard Schultze & Associates, Architects	19
Store Front Designs	24
Kitchen of Tomorrow	27
Blimp Hangar for U. S. Navy	29

NEXT MONTH

An Oakland architect designed a pre-war church that is not without its post-war appeal. Photographs and plans will enable you to form your own conclusions.

"Architecture and City Planning in Soviet Russia," and the story of the Nazis' destruction of many priceless works of art and architecture, with first publication in America of some of these buildings, will constitute an outstanding feature of the March issue.

ESTIMATOR'S GUIDE

The two pages of building material price quotations which have been a feature of Architect and Engineer for more than twenty years and are particularly valued by Government officials, Chambers of Commerce executives, and research authorities for their accuracy, have been revised, checked and double checked, and as presented in this issue offer a dependable guide for those in need of this type of information. Architects, engineers and building contractors in particular will find today's *Estimator's Guide* highly valuable as a reference aid. While most of the quotations given are approximate, they should be useful for the average preliminary estimate.

ARCHITECT AND ENGINEER (Established 1905) is published on the 15th of the month by The Architect and Engineer, Inc., 68 Post Street, San Francisco. President, K. P. Kierulff; Vice-President, Fred'k W. Jones; Secretary-Treasurer and Manager, L. B. Panhorwood; Advertising Manager, V. E. Atkinson, Jr.

Los Angeles Office: 403 W. 8th Street, Robert W. Walker, Manager.

Entered as second class matter, November 2, 1905, at the Post Office in San Francisco, California, under the Act of March 3, 1879. Subscriptions, United States and Pan America, \$3.00 a year; \$5.00 two years; foreign countries \$5.00 a year; single copy 50c.

ARCHITECTS' REPORTS are published daily from this office, Vernon S. Yallop, Mgr.

STRENGTH ★ UNIFORMITY ★ DEPENDABILITY



There is ★ ★ ★
NO SUBSTITUTE
FOR GOOD
Plaster

PACIFIC
PRODUCTS
for



PRODUCED BY

PACIFIC PORTLAND CEMENT COMPANY
SAN FRANCISCO LOS ANGELES COASTWIDE SERVICE PORTLAND SEATTLE

WHAT'S ON YOUR MIND?

THE SOUND-PROOF ROOM

Editor,

Architect and Engineer:

Time was in rural America when the Stork ad welcome signs on farm houses everywhere he brought a new installment. Time is in city America when even a pregnant woman turned away from a prospective apartment. "When the baby comes, it'll be a wild, madam! This apartment house doesn't take children." (To quote from a true San Francisco story). Time always is that women lead children to complete their lives and others need sons and daughters to perpetuate the race. Time will be when city and countryside alike will welcome the arrival of the Stork.

That time is practically upon us! It is merely a matter of architecture! The materials are at hand now to solve the ancient problem of race suicide in cities. The materials are at hand to develop a new post-war building industry—the sound-proof room!

Why are babies not wanted in apartments? Because they are a noise nuisance to their too close neighbors. (Even on farms, their wailing is a nuisance to distracted parents.) Why are growing boys not wanted in apartments? Because they, too, are a noisy nuisance!

Up to the very present, nothing could be done about crying babies except not have them, when there was no place to offer them to live afterwards. But men, women, ARCHITECTS, today there is the broadcasting studio! Sound proof! Does that suggest anything?

Why not a sound-proof room in every house? Certainly one in every family size apartment! A sound-proof room where a mother could place her baby when it begins to cry, where the child later can play naturally and noisily yet be unheard outside the room walls, where the budding musician can practice bugle calls or saxophone wailings, where father and mother can entertain their friends as late as they please, as marriage they please, without worrying over slumming fellow apartment house dwellers.

Because a mother must make sure her baby is still alive when she can't hear it and at Junior is practicing piano lessons when he goes into the sound-proof studio, this room, like most broadcasting studios, must have a glass or plastic transparent wall giving onto an adjoining room.

The scientific knowledge, the materials are available or will be immediately after the war—available. All that's needed now is to get the price for sound proofing right for household apartment building.

What a revolution that will be for Mr.

Stork! What building jobs that will create in post-war adjustment days! What a boon that will be for future war brides! (Or present ones, after their heroes come home again!) Anyone with two eyes can see that the Stork is extremely welcome universally—except by the apartment owner.

But architects, you can change all that! Make plans now!

HELEN HAINES STUART.

San Carlos, Jan. 12, '44.

WAR-SUBSTITUTE FOR STEEL

Editor,

Architect and Engineer:

Asbestos-cement tubular framing is now in commercial use in Great Britain, as a war-substitute for steel angles, tees, and bars.

A measure of permanent effect on future construction is possible, as the material has merit and considerable strength in its own right.

Current examples of the new framing are of normal design and include light roof-trusses, having all-tubular members, or tubes combined with tension rods.

Joints are simple and convenient, being formed chiefly by slotting small into larger tube sections: These are secured by bolts and pins, or assembled with small connecting-plates. Fewer shop drawings and work sheets probably are required. Ridges, purlins, bracing and rafter members also are tubular sections, overlaid with light cement preformed slabs or composition sheathing.

The trusses may be demountable and offer advantages against fire and corrosion, besides dispensing more or less with preservative painting. Condensation and noise are minimized by the natural insulating qualities of the material, and the appearance is attractive.

Minor incidental uses of asbestos tube members, include various forms of framing for heavy duty benches and shelving, with slabs and divisions also pre-formed to match.

Asbestos-cement material is of long standing in U.S.A. and Canada, in many varieties, but usually is adopted for fire resistance or special services, apart from cost. Except as scaffolding, even steel tubing has not been exploited for framing, in America, to any great extent, and is a promising field.

CHARLES CRESSEY, Architect.
San Diego, Calif.

SETTLED

Editor,

Architect and Engineer:

Many thanks for the mention in your December issue. It seems that I am in the

same boat as a great many of my fellow architects—continually on the move. However, I believe the below-mentioned business addresses will be permanent; at least as permanent as anything can be these days: 201 South Market Street, San Jose, and 1202 Hearst Building, San Francisco.

Again thanking you, I am

Very truly yours,

DONNELL E. JAEKLE.

January 10, 1944.

NEW CONCRETE BLOCK

Editor,

Architect and Engineer:

In connection with our post-war plans, we have been approached by an inventor who has a machine for making a new and improved type of pre-cast reinforced concrete block.

Through the use of this block, unusual structural strength is claimed. Instead of using mortar at the top and side of the block, the mortar is poured into channels or grooves in the block, in this way joining the blocks together in a permanent manner. Steel strengthening rods are also suggested.

Other advantages claimed are high insulation value; a positive dry wall (since the block is formed at very high pressures); cheaper construction than brick and tile, frame, or monolithic cement; attractive outside or inside wall effects.

We would like to submit samples to some 25 architects throughout the country, for their opinion as to the value of this idea, and its commercial possibilities, and would greatly appreciate your suggestions as to whom we should write.

Very truly yours,

LOMBARD GOVERNOR CORP.
W. B. Greenlaw.

Address the Lombard Governor Corp., Ashland, Mass., and sample will be mailed free.—Ed.

THE FACTS OF LIVING

Two recent stories underline the necessity for public housing better than any oratory we've heard in a long while.

In Philadelphia, the minimum shelter rent for new houses started during the first half of 1943 was \$47.50. And only 21 per cent of the new homes were for rent at any price.

In Wilmington, Del., not many miles down the line, the average shelter rent paid by the city's slum dwellers is \$20.99.

How many slum dwellers could be reduced by private enterprise under conditions anything like these?—A. L. C.

NEWS AND COMMENT ON ART

OSKAR KOKOSCHKA'S WORK AT THE S. F. MUSEUM OF ART

The work of Oskar Kokoschka, impressionist painter, was the center of interest at the San Francisco Museum of Art during late January and early February.

Kokoschka's early graphic work was represented in the show by a nude done in watercolors, still showing a strong influence by Schiele. The later years of his Viennese period, were represented by the lithographs illustrating the Bible, of which the "Last Supper" deserves special attention, and the three sanguine drawings, done in 1917, depicting impressions of the war. The post-war years contributed the "Illustrations for a Bach Cantata" and a number of magnificent portrait studies. Finally, the exhibition showed important water colors and drawings from the time of Kokoschka's stay in Europe.

Oskar Kokoschka is now living in London. Many of his pictures have found their way to American museums and collections during recent years. The Nazi regime's antagonism against all true art has opened for the artist a path to the New World after his genius had long been universally recognized in Europe.

Kokoschka is represented in this country in the following museums and art collections:

Museum of Modern Art, New York City
Art Institute of Chicago
Phillips Memorial Gallery, Washington, D. C.
Art Institute, Detroit
Albright Art Gallery, Buffalo



William Sotheron, the Younger, of Darrington
by George Romney (1734-1802) English School

This painting is one of the outstanding examples included in the recent gift of Mr. Albert Campbell Hooper, of Palo Alto, to the California Palace of the Legion of Honor.



THE MONKEY MAN

by Gyula Zilze

One of many black and whites, oils and pastels shown in the one-man exhibit at de Young Museum by the imaginative Hungarian-born artist, now residing in Los Angeles.

Collection Elmer Rice, New York City
Collection Joseph von Sternberg, Hollywood
Collection Robert H. Tannahill, Detroit
Collection Wright Ludington, Santa Barbara
Collection, Mrs. Adolph Mack, San Francisco
and other private collections in Cincinnati and Hollywood.

DE YOUNG MEMORIAL MUSEUM ACQUIRES RUBENS MASTERPIECE

The M. H. de Young Memorial Museum announces the purchase of a magnificent oil painting by the famous Flemish master, Peter Paul Rubens (1577-1640). The large painting (74¾ x 56¾ inches) is now being displayed inside the entrance of the park museum in a specially constructed framework. The subject of the painting is "The Tribute Money," and the composition of nine life-size figures seen to the knees, illustrates the passage in the 22nd Chapter of St. Matthew, 16th to 21st verses.

DRAWINGS BY THOMAS ROWLANDSON AT THE LEGION PALACE NEXT MONTH

Approximately seventy-five drawings and prints by the celebrated etcher, Thomas Rowlandson, will be on view at the California Palace of the Legion of Honor in San Francisco from March 1 to 30.

Thomas Rowlandson was born in London in 1756. He attended Dr. Barrows' Academy in Soho Square and even at this early period showed a talent for caricature. He studied for a while in Paris, returning to London to the Royal Academy.

Rowlandson found a good market for his prints. The excitement of the famous Westminster election of 1784 carried him into political satire and he found similar inspiration in the career of Napoleon.

AN EVER CHANGING WORLD

"The Miseries of Life," "Comforts of Bath," "Cries of London," and the "Dr. Syntax" series were among his most famous works.

THREE RECENT PURCHASES BY THE SAN DIEGO ART GALLERY

The San Diego Fine Arts Gallery has announced three recent purchases from funds bequeathed to the Gallery by Helen M. Towle, as follows:

Doris Rosenthal's painting, "At the Blackboard," acquired from the Midtown Galleries in New York; Karl Zerbe's encaustic painting, "Marion Square," from the Downtown Gallery at the same time, and Charles Reiffel's "Early Morning, Nogales, Arizona." This canvas was presented to the Gallery by friends of the artist as a proper memorial to the painter and for its obvious high value as "a splendid record of the era the picture celebrates." Alfred R. Mitchell headed the committee of 50 that raised the necessary purchase price.

PRICE'S CALIFORNIA PAINTINGS ARE WILLED TO OREGON STATE COLLEGE

The widow of William Henry Price, California miner who began to paint pictures of the Pacific surf and the great Sierra mountains after he had retired from active employment at the age of 56, has given the collection of 70 paintings remaining after his death to the Oregon State College.

Mrs. Price's gift is intended as a tribute to her husband's memory and as an aid to others "in their quest for nature's beauty." The College accepted the gift as a nucleus for a permanent gallery for the school. Social functions have been arranged around the paintings which attracted more than 700 people on opening day.

WILLIAM L. GERSTLE COLLECTION AT SAN FRANCISCO ART MUSEUM

Two interesting exhibitions opened at the San Francisco Museum of Art the middle of the month and will continue to March 5. One of these exhibitions consists of paintings, watercolors and prints collected over a period of years by William L. Gerstle, San Francisco art lover and one of the Museum's staunch supporters.

Also as part of the Museum's selection for showing in this exhibition is a fine and comprehensive group from the W.P.A. Allocation which the Museum was honored in receiving last year at the close and dispersal of the W.P.A. program.

Posters, mostly of the war theme, donated to the Museum by the Government, are all American.

Fine photographic work from the Museum collection is also on view, including work by Ansel Adams, Edward Weston and others.

Selected Native Crafts from Latin American Countries is another new exhibition this month. These crafts, gathered during many trips to the Latin American countries by their lenders, are part of three local collections. Because of the general familiarity of Mexican crafts, they are not included in this showing. The emphasis is on the



FEDOR CHALIAPIN

by Boris Chaliapin

This drawing of the great Russian singer in the role of Boris Godounoff is one of a number of portraits of his famous father and other notables which Boris Chaliapin is showing this month at the de Young Museum. Born in Moscow, the artist has achieved recognition since coming to this country in 1935 through his portraits of celebrities, many of which have appeared on the covers of "Time."

Andean countries, where the Indian tradition persists, strong despite successive overlays of European origin. These fine crafts in weaving, silver-work and pottery give the visitors of the Museum an excellent survey of the great imagination and skill of the Indians, developed to a very high point of artistic value though devoted to every day use.

CHINATOWN ARTISTS' CLUB'S THIRD ANNUAL EXHIBITION

Following their custom inaugurated a few years ago, the members of the Chinatown Artists' Club are holding their third annual exhibition of oils and watercolors at the de Young Museum, San Francisco. The names of most of the nine artists exhibiting are familiar to gallery visitors through former showings.

Dong Kingman is represented by four watercolors, including a lovely still-life as well as his more familiar landscapes. Jake W. Lee, who last year held a most successful show at the Raymond & Raymond Galleries, has contributed three wa-

tercolors, two glimpses of familiar San Francisco scenes and a landscape, "Santa Cruz Ranch."

The many oils and watercolors by Chee Chin S. Cheung Lee, who recently exhibited at the Legion of Honor, are extremely colorful. Hu Wai Kee's landscapes in the two media are interesting; his oil, "Ocean at Night," is particularly fine. Chang Shu-Chi, the professor from Chungking who recently held a large one-man exhibition, has contributed four of his charming nature studies. David P. Chun, president of the club; Siu Chan, George Chann and Goodman Loy have each contributed at least two paintings to the Annual, which boasts a total of forty works in all.

MARCH EVENTS AT CALIFORNIA PALACE OF LEGION OF HONOR

The California Palace of the Legion of Honor announces the following special exhibitions for the month of March:

Prints and Drawings by Thomas Rowlandson. Opening March 1—closes March 30.

Paintings of American (Navajo) Indians and Pololen Ceremonial Paintings by Maud Oakes. Opening March 1—closes March 30.

Oriental Stencils. Lent by Mrs. Herbert Lawrence. Opening March 1—closes March 30.

The Hooper Collection. Through March.

The Children's Museum. Work done by Children in the San Francisco Public Schools. March 1 to 30.

"The Arts of Today," lectures for March, will be as follows:

- | | | |
|-------|----|---|
| March | 1 | Painting—Dr. Jermayne MacAgy |
| " | 8 | Sculpture—Dr. Jermayne MacAgy |
| " | 15 | Materials (Plastics, etc.)—Mrs. Elizabeth Wisner Fuller |
| " | 22 | Mobiles—Mrs. Elizabeth Wisner Fuller |
| " | 29 | Industrial Design—Mr. Walter Landor |

"The Arts of Today" will continue through June 14, covering painting, sculpture, industrial design, flower arrangement, interior decoration, glass and silver, jewelry, textiles and weaving, and ceramics.

LUCIEN LABAUDT'S TRAGIC DEATH

Lucien Labaudt, California artist who was killed on Sunday, December 12, in a plane crash in Assam, near the Burma border, had been in India since mid-November as a war artist-correspondent for Life Magazine. The plane in which he was traveling to a new assignment in China, crashed at dusk during an attempted landing and all on board were killed, the eleven others being Army personnel.

Labaudt's paintings, done during his assignment in India, are believed to have been destroyed in the crash.

West Coast artists held Labaudt in high regard. He was a good leader among students and associates and was known widely as a host.

Lucien Labaudt is the third American prominent artist to meet his death in this war. McClelland Barclay and Tom La Farge, both attached to the Navy, were killed last year.

COMING EXHIBITIONS

Los Angeles, California

Fifth Annual Exhibition, April 23-May 28. Los Angeles County Museum. Open to artists residing in Los Angeles or within a hundred mile radius. Media: oil, sculpture, ceramics, textiles, metal work, leather work, wood carving. Entry cards, work due April 18. Write James Normile, c/o Los Angeles County Museum, Exposition Park, Los Angeles, California.

San Francisco, California

Exhibit of contemporary work, living California master artists, California Chapter, American Artist's Professional League, at the Penthouse Gallery, 133 Geary Street, San Francisco. Daily from 10 a.m. to 5 p.m., except Sunday. Tuesday and Thursday evenings, 8 p.m. to 10 p.m.

Annual exhibition of prints and drawings of San Francisco Art Association at the San Francisco Museum, February 29 to March 19.

Seattle, Washington

Northwest Printmakers Sixteenth International Exhibition, March 8 to April 2, 1944. Seattle Art Museum. Open to all artists. All print media. Fee \$1.00. Jury. Entry cards due Feb. 23; entries Feb. 28. Purchase prizes. Entry cards from R. C. Lee, Secy., 534 East 80th, Seattle 5, Wash.

Laguna Beach, California

Third Annual Print and Drawing Exhibition. May 1 - June 1. Laguna Beach Art Gallery. Open to American artists. Jury. Prizes. Entry cards available March 1, due April 20. Work due April 25. Norman Chamberlain, Director, c/o Laguna Beach Art Gallery, Laguna Beach, California.

Oakland, California

1944 Annual Exhibition of Oil Paintings. March 5 - April 2. Oakland Art Gallery. Open to all. Media: oil and tempera. Jury. Prizes. For further information write Oakland Art Gallery, Municipal Auditorium, Oakland, California.

HUNGARIAN-AMERICAN ARTIST'S WORK IS SHOWN AT DE YOUNG

The de Young Museum is now showing a comprehensive one-man exhibit of the works of a noted Hungarian artist, Gyula Zilzer. (See cut.) This exhibition covers the period from the early 20's when Zilzer first achieved success on the European continent to the present day.

Born in Budapest of a celebrated family of painters and musicians, Zilzer received his art training in his native city, graduated from the Royal Hungarian College and the Royal Academy of Arts. His success as a graphic artist dates from 1924 when his first series of lithographs was published. In Paris, in 1925, he made a special study of etching, working under Charles Leblanc.

Since coming to the United States in 1935, the artist's revulsion to the horrors of war has made him turn to the more placid and peaceful landscapes of American rural life, and most of the oils and pastels, which make up a major portion of the present exhibition, are without political implications.

Jeepers,—

**THEY'RE EITHER TOO HOT
OR TOO COLD!**

A PROBLEM familiar to every architect and builder. But...
Cheer up, Junior! After the war, your family
can enjoy PAYNE ZONE-CONDITIONING

... successor to the old-fashioned central furnace. Dependable, economical gas heating and fresh air circulation, controllable by zones or individual rooms. ★ Not available now; we're producing for war. But before writing any post-war specifications, consult your PAYNE Dealer. ★ Meanwhile, let's all back the boys with Bonds.



PAYNEHEAT

NEARLY 30 YEARS OF LEADERSHIP



Stands the Gaff!

Now being made with Ar-Polene, the American synthetic rubber, blended especially for its particular purpose—

"American Rubber" Industrial Fire Hose Can Take It

AR-POLENE

— the American synthetic, is blended in different ways for different purposes. That's one reason why, in many cases, it is superior to natural rubber.

It may be years will pass before the need arises, but when that time comes, the fire hose in factory or office building must be absolutely dependable. You can rely upon "American Rubber" hose!



Lightning Hose Racks, Reels, and Cabinets are made in many styles. There's at least one for every requirement.

The AMERICAN RUBBER

Factory and General Offices: **Manufacturing Co.**

Park Avenue and Watts Street, Oakland, 8, California

SATISFY YOUR CLIENTS WITH...



It costs no more!

Next time specify Pennvernon

Distributed by

W. P. FULLER & CO.



Pin-up picture for the man who "can't afford" to buy an extra War Bond!

YOU'VE heard people say: "I can't afford to buy an extra War Bond." Perhaps you've said it yourself . . . without realizing what a ridiculous thing it is to say to men who are dying.

Yet it is ridiculous, when you think about it. Because today, with national income at an all-time record high . . . with people making more money than ever before . . . with less and less of

things to spend money for . . . practically every one of us has extra dollars in his pocket.

The very *least* that you can do is to buy an extra \$100 War Bond . . . above and beyond the Bonds you are now buying or had planned to buy.

In fact, if you take stock of your resources, and check your expenditures, you will probably find that you can

buy an extra \$200 . . . or \$300 . . . or even \$500 worth of War Bonds.

Sounds like more than you "can afford?" Well, young soldiers can't afford to die, either . . . yet they do it when called upon. So is it too much to ask of us that we invest more of our money in War Bonds . . . the best investment in the world today? Is that too much to ask?

Let's all BACK THE ATTACK!

ARCHITECT & ENGINEER



This is an official U. S. Treasury advertisement—prepared under auspices of Treasury Department and War Advertising Council

IN THE NEWS

DIRECTOR OF FINANCE

California's new State Director of Finance, James S. Dean, is remembered by the architectural profession as a former practicing architect in Sacramento,



DEAN

member of the firm of Dean & Dean. "Jimmy" Dean was business head of the firm while his brother, "Charlie," a brilliant designer, was responsible for the production department. Schools, commercial structures and private homes, designed by Dean & Dean, stand as fine examples of their work throughout the Sacramento Valley.

Born in Belton, Texas, in 1885, James Dean graduated from Texas Agricultural and Mechanical College, as an architectural engineer and later became an instructor in drawing at the same school. He served as Deputy State Architect in California from 1913 to 1920. He practiced architecture with his brother from 1920 to 1930, during which time he held membership in the A.I.A. and from 1925 to 1930 served on the State Board of Architecture. In 1930 Mr. Dean returned to public life as City Manager of Sacramento, doing a splendid job up to the time of his resignation last year to accept the position of Deputy State Director of Finance. When John F. Hasler resigned as Director of Finance to enter the banking business in Oakland, Mr. Dean was named his successor by Governor Warren. He began his new duties February first.

HOUSING IN BRAZIL

At a recent luncheon meeting of the San Francisco Housing and Planning Committee, Gardner A. Dailey gave an interesting account of his six months' stay in South America, as head architect and engineer for the Rubber Development Corporation (R.F.C.).

The Amazon Valley, he told his listeners, is rich in resources, offers a boundless hope for the future. "In that country," Mr. Dailey declared, "lies a real solution for some of our post-war problems. It possesses a limitless market of raw materials which we may exchange for our peacetime goods. After the war thousands of small shelters may be fabricated there and sent down there to help Northern Brazil in its housing problem."

Gardner A. Dailey was born in St. Paul, Minn. After serving in the Air Service during the first World War, he took up ranching in Mexico. He became interested in city planning and acted as consultant for Stanford University and the San Francisco Park Department. Following extensive architectural study in Europe, he commenced his practice in San Francisco and is now noted for his residential work and the workingmen's

Index to Advertisers

*Indicates Alternate Months

A	
ALADDIN Heating Corp.....	47
AMERICAN Rubber Mfg. Co.....	7
ANDERSON & Ringrose.....	48
B	
BASALT Rock Company.....	46
BAXTER & Company, J. H.....	12
C	
CASSARETTO, John.....	48
CLARK, N., & Son.....	47
CLINTON Construction Company.....	45
COLUMBIA Steel Company.....	Back Cover
CROCKER First National Bank.....	47
D	
DINWIDDIE Construction Company.....	48
DOUGLAS Fir Plywood.....	13
F	
FIAT Metal Mfg. Co.....	10
FORDERER Cornice Works.....	45
FULLER, W. P., Co.....	7
G	
GUNN, Carle & Company.....	12
H	
HANKS, Inc., Abbot A.....	47
HAWS Drinking Faucet Company.....	2nd Cover
HERRICK Iron Works.....	48
HOGAN Lumber Company.....	45
HUNT, Robert W., Company.....	47
HUNTER, Thos. B.....	48
I	
INDEPENDENT Iron Works.....	47
J	
JENSEN & Son., G. P. W.....	48
JOHNSON Company, S. T.....	*
JUDSON Pacific Company.....	45
K	
KAWNEER Co.....	*
KRAFTILE Company.....	*
M	
MULLEN Mfg. Co.....	48
N	
NORTHERN California Electrical Bureau.....	12
P	
PACIFIC Coast Gas Association.....	*
PACIFIC Foundry Company, Ltd.....	40
PACIFIC Manufacturing Company.....	46
PACIFIC Portland Cement Company.....	2
PARAMOUNT Built-In Fixture Company.....	*
PAYNE Furnace & Supply Co., Inc.....	7
R	
REMILLARD-Dandini Co.....	*
REPUBLIC Steel Corporation.....	46
S	
SANTA Maria Inn.....	*
SIMONDS Machinery Company.....	46
SISALKRAFT Company.....	46
SOULE Steel Co.....	11
STANLEY Works, The.....	*
T	
TORMEY Company, The.....	48
U	
U. S. STEEL Company.....	Back Cover
V	
VERMONT Marble Company.....	46
W	
WESTERN Asbestos Company.....	*
WOOD, E. K., Company.....	40
WAR Bonds.....	3rd Cover

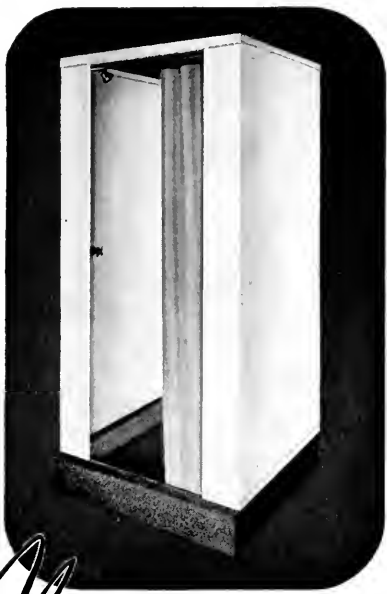

No. 85 ENSIGN TYPE FIAT

SHOWER CABINET

A Better Shower—Standard Size 36"x36"x78"

now available for immediate delivery under low priority. Conforms to government regulations restricting the use of critical materials.

The No. 85 fills the need for a good quality shower cabinet for homes, clubs, hospitals and public buildings. Designed along the lines of our Ensign model, using the regular Ensign deep type receptor, the No. 85 compares very favorably with our standard Ensign cabinet and is the best shower we have been able to build under government material restrictions. Extra heavy treated fibre board wall panels are joined on all four corners with the Fiat tension locking joint which provides a rigid, permanent, waterproof structure that can be quickly erected on the job, as no additional fastenings are required for the corner joints.

The No. 85 was originally designed for use in military hospitals where a permanent type of construction is required. Many of these showers have been installed and have proved their value in practical use. Now we are able to offer this high grade shower cabinet for civilian use through the plumbing trade.

SPECIFICATIONS—WALLS: Heavy duty 1/4" S-2-S masonry hard board, coated inside and out with waterproof baked-on enamel. Metal frame pieces 20 gauge steel. Head rail 16 gauge steel. All parts formed to eliminate rough edges within the interior of the cabinet. Furnished in white only.

RECEPTOR: Regular Ensign type, precast, reinforced terrazzo. Height 6" with cast-in wall flange and drain. Leakproof and sanitary.

SIZE: Over-all dimensions 36" x 36" x 78". One size only.



FIAT METAL MANUFACTURING CO.

1205 Roscoe St., Chicago 13, Ill.

21-45 Borden Ave., Long Island City 1, N. Y.

32 S. San Gabriel Blvd., Pasadena 8, Cal.



IN THE NEWS

housing units in Nevada and Arizona.

Architect and Engineer plans to devote an early issue of the magazine to some of Mr. Dailey's most recent work.

A MERITED HONOR

The cover picture this month is a house at Palos Verdes Estates, Southern California, built some years ago for Wm. Ripley Dorr from plans by Winchton L. Risley, architect of Los Angeles, who was recently honored with two other Los Angeles architects by being elected to fellowship in the American Institute of Architects. The Palos Verdes house was one of several residences designed by Architect Risley which drew honor awards by a jury of Institute members.

For three years in succession, 1937, 1938 and 1939, Mr. Risley's work in domestic architecture received prize awards in House Beautiful competitions. A native of Delphos, Ohio, Mr. Risley studied two years at Maami University, Oxford, later graduating in the School of Fine Arts, Columbia University. His early architectural training was in the office of the late Bertram G. Goodhue. Mr. Risley has been practicing architecture in Los Angeles since 1921, most recently in partnership with Stanley R. Gould.

BETTER LATE THAN NEVER

Due to commitments of material scheduled months in advance, coupled with limited space because of paper curtailment by the Government, it was necessary to hold over several important articles in the December and January issues. In the meantime some of the material has appeared sparsely in other publications. The articles referred to are published in this issue. They describe the Lockheed cafeteria in Burbank and the Ryan Aeronautical plant at San Diego.

Magazines, as well as newspapers, are confronted with many vexing problems these hectic times, not the least of which is the paper shortage. Another annoyance is slow mail delivery. Regular subscribers are asked to please bear in mind the Post Office is doing its utmost to deliver your magazine on time despite the shortage of labor and uncertain transportation facilities.

AN ARCHITECT'S LEGACY

A classic example of Italian Renaissance architecture, believed to have been a part of an altar and constructed between 1575 and 1600, has been presented to the Cooper Union Museum for the Arts of Decoration by Whitney Warren, Jr., of New York City.

The wooden structure, fourteen feet in height, came from the estate of the late Whitney Warren, architect. It was used as a doorway in his Park Avenue apartment. Though dimmed and cracked with age, the original carving, gilding, and paint are intact.

[Turn to Page 13]

The blue print of the future



New products . . . new methods . . . new ideas . . . all will have their influence on post-war building projects. One thing, however, is certain—Soulé fabricated steel products will play their part in supplying the sinews of strength and permanence just as they have in the past. ★ Today building "Bridges to Victory" (invasion barges), Soulé Steel will be ready when the time comes to meet the challenge of the post-war world with better products for the building industry. ★ In your post-war planning for "building in the West" Soulé service engineers will gladly help with technical data and ideas.



PRODUCTS

Steel Windows and Doors
Reinforcing Steel
Welded Fabric

Steel Farms
Metal Lath Products
Expanded Metal

Stucco Netting
Fabricated Steel
Merchant Steel



Award made to
San Francisco Plant

Soulé Steel Company

SAN FRANCISCO

LOS ANGELES

PORTLAND

SEATTLE

HOUSTON

FABRICATED STEEL PRODUCTS



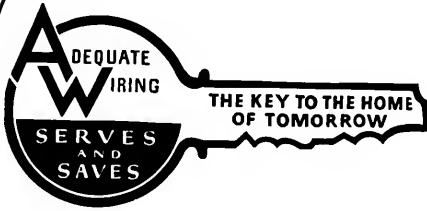

If anything was needed to make the homeowner realize the importance of electrical appliances in the modern home, it has been supplied in the wartime restrictions on manufacture of appliances.

And on every hand remarks are made by people planning future homes, that the one first requirement of the new home is that it be completely equipped electrically.

This means that the architect will require thorough knowledge of electrical wiring that will provide adequate and convenient service on a scale never known before for the average priced home.

Planning electrical service is no longer a matter that can be slipped in at the last moment. It must now be a prime consideration.

Many architects are taking advantage of present conditions to inform themselves thoroughly on modern electrical wiring planning and practices.

Assure your future home plans by studying latest electrical developments and wiring methods.

NORTHERN CALIFORNIA
ELECTRICAL BUREAU
1355 Market Street
San Francisco

*Electricity is vital for war production.
Use it carefully and without
waste.*



The New Weapon Against Fire IS **FIREPEL "S"**

A TIMELY CHEMICAL ACHIEVEMENT FOR THE TREATMENT OF UNFINISHED INTERIOR WOOD AFFORDING A PRACTICAL METHOD OF SUCCESSFUL FIRE RETARDATION

IN
Homes

Industrial Plants - Schools

THE ONLY FIRE RETARDANT COATING MATERIAL ON THE MARKET LISTED AND APPROVED BY
UNDERWRITERS LABORATORIES INC.

DISTRIBUTED BY



GUNN, CARLE & CO.
20 POTRERO AVE.
SAN FRANCISCO
UNderhill 5480

BAXCO

CHROMATED ZINC CHLORIDE

CCZC

PRESSURE TREATED LUMBER
● **PROTECTS AGAINST DECAY
AND TERMITE ATTACK**

*Specify it in your home
Available through Lumber Dealers*

LOS ANGELES
601 W. 5th Street
Phone Michigan 6294

SAN FRANCISCO
333 Montgomery Street
Phone DOugles 3883

J. H. Baxter & Co.

AGENTS FOR WEST COAST WOOD PRESERVING CO. SEATTLE, WASH.

IN THE NEWS

The embellishment of angels and the liturgical motifs on the columns and arch indicate to the research specialist of the Museum, Dr. Rudolf Berliner, that it may have been used as a retable, the superstructure of an altar, containing a painting, in one of the Renaissance cathedrals.

Another notable addition to the Museum's extensive collection of working papers of the masters consists of four volumes of Whitney Warren's original drawings, a gift from his daughter, Mrs. William Greenough, of New York.

Two volumes, executed in Europe from 1887 to 1890, contain pencil and watercolor sketches of fishing craft, gondolas, staircases, iron lamps, church spires, village streets, and typical examples of European architecture. Many sketches carry the working comments of Mr. Warren.

CITY AND REGIONAL PLANNING

The City Planning Division of the Massachusetts Institute of Technology is sponsoring a short training course in City and Regional Planning during the spring of 1944, in addition to its regular program of undergraduate and graduate work. The training course, which will be open to men and women with professional experience in architecture, landscape architecture, civil engineering, political science, or public administration, will commence on Monday, April 3, and will continue for a period of twelve weeks. Lectures and seminars will be held on principles and techniques of planning, social and economic aspects of planning, and planning legislation and administration. These will be supplemented during the entire period by a program of practical experience.

The fee for the training course is \$125, payable at the time of registration, and participants will be enrolled as special students at M. I. T. Further information concerning admission requirements, lecture schedule, etc., may be obtained from Professor Frederick J. Adams, Division of City Planning, Massachusetts Institute of Technology, Cambridge 39, Massachusetts.

NEW METHOD OF AWARDING CONTRACTS

A bill calling for the establishment of a new method of awarding Government construction contracts is pending in Congress. It is designed "to replace the present cost-plus and other systems of contracting for public construction by a system of negotiated lump-sum contracts."

The proposed legislation, "The Negotiated Contract Plan," evolved by Frederic W. Lord, founder of the fifty-year-old Lord Electric Company of New York, promises to save the Government much priceless time and many millions of dollars annually, during the war and after peace is restored.



LETTERS FROM HOME .. delivered sooner in Plywood cases

• Mail from home—greatest morale-builder for our fighting men—now reaches them SOONER because of Douglas Fir Plywood. Developed by Seattle Port of Embarkation officers, a portable, sea-going mail-box cuts hours—sometimes days—from the delivery time of mail for our Aleutian outposts. Built of inch-thick Exterior grade Douglas Fir Plywood, this new locker carries the mail "top side" . . . is the last thing aboard and the first thing ashore. It's water-tight, resists the harshest weather, can't sink even when loaded with 135,000 letters. The mail gets through—quickly, safely—because it's Plywood-protected. Write for information to Douglas Fir Plywood Association, Tacoma 1, Washington.

• Douglas Fir Plywood is specified for many other containers used by our armed forces. When peace comes, this strong, rigid, durable "miracle wood" will be your most versatile construction material.

TO HELP SPEED
VICTORY
the Douglas Fir
Plywood Industry
is developing its en-
tire capacity to
war production.
We know this pro-
gram has your
approval.

DOUGLAS FIR PLYWOOD

Real Lumber
MADE LARGER, LIGHTER
SPLIT-PROOF
STRONGER

STRONGER
PER POUND
THAN STEEL

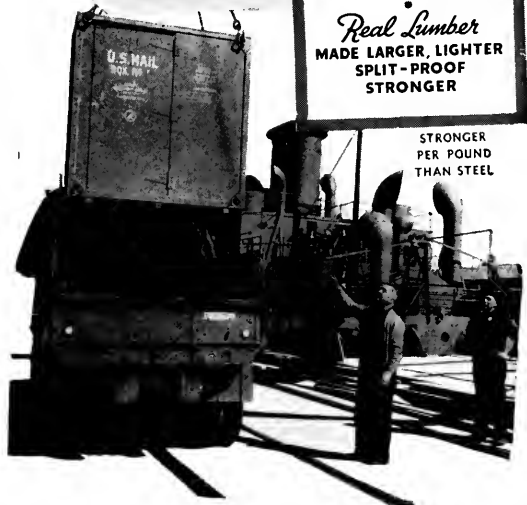

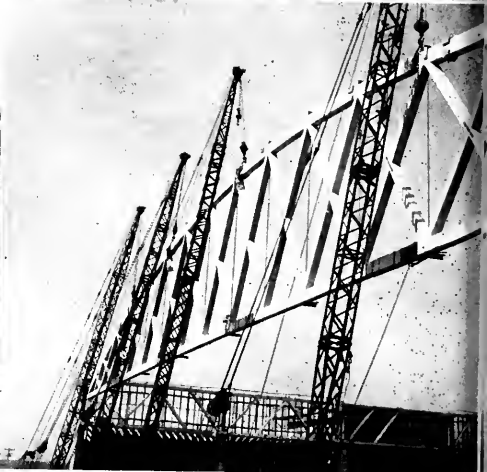
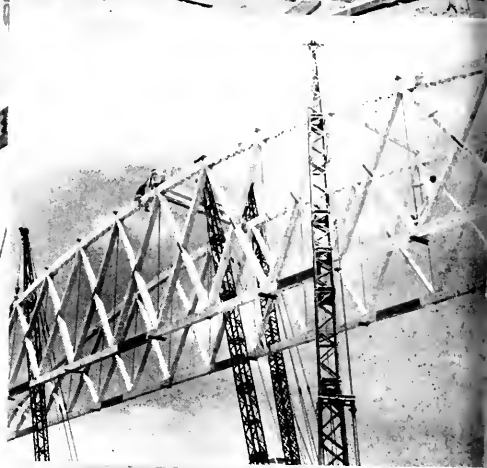
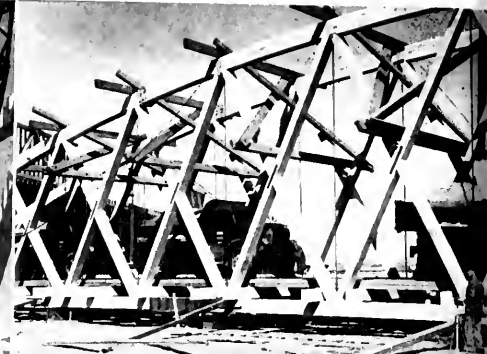

200-FOOT BOWSPRING ROOF TRUSSES FOR RYAN AERONAUTICAL PLANT, SAN DIEGO

Large photo shows four cranes lifting huge trusses into place. Upper right, two trusses being subjected to load tests. Upper chords are laminated, lower chords are solid timbers.

LONG SPAN WOOD ROOF TRUSSES FOR WAR PLANT

Some months ago the Ryan Aeronautical Company completed a final assembly building at its San Diego plant embodying several unusual structural features, including a series of 200-foot span clear wood trusses, believed the longest of their type ever built. Following many requests for technical information and photographs, permission was finally granted by both the Army and Navy for publication of some of the structural details and illustrations. While the photographs show the plant in the construction stage, the building has been completed and occupied for some time. Due to military security regulations, pictures of the finished structure have been censored.

The entire building is one large room, 570 feet long, 200 feet wide, 35 feet clear height under the trusses, and 60 feet to the crown of the roof, there being 31 trusses spaced 19 feet apart. Trusses are 26 feet high at the center, the height thus being one-eighth of the span. The upper chords are laminated, permitting the use of smaller sizes of timber (quite a consideration) and which, of course, makes curved chords relatively easy to build. The lower chords are solid timbers, joined with steel splice plates, and construction details throughout are of orthodox design. Trusses are designed to sustain customary dead and live loads, plus certain moving crane loads applied to the lower chord. The various component parts of the trusses were made at the truss company's plant and shaped to template and were interchangeable. These parts were numbered, shipped and assembled on the job.

Deflection of wood trusses, due to "compacting" of the various joints under the influence of time and loading and also to timber shrinkage, is a major consideration, especially in long spans. To minimize shrinkage difficulties in the new green lumber, all parts were treated in a hot solution of wood preservative, which had the effect of removing surface sap and

replacing with preservative so that seasoning would proceed without abnormal checking or distortion. Excellent workmanship was required at the dapped joints of the diagonals, and where steel keps were employed at the heel joints and lower chord splices, space was provided in the daps for pouring in melted lead, which not only insured dead fits, but also equalized distribution of stresses among the keys. The resulting stiffness, and uniformity of deflection proved very satisfactory.

It was felt that, as a matter of principle, it would be well to test these trusses under load, a procedure rarely adopted where spans are shorter and less apt to incur scepticism. Accordingly, two trusses were set up on the ground, with blocking under the ends, and a sort of bridge constructed, upon which was loaded sufficient tonnage in such a manner as to simulate full design load conditions. Under this test a maximum deflection of $4\frac{3}{4}$ inches was observed at the middle, quite small for this span, and while the trusses appeared structurally adequate, it was found advisable to reinforce the heel plates of the end panel points.

The problem of lifting into place to a height of from 35 to 60 feet, a single unit of this size was not so much a matter of the 16-ton weight of the truss, as avoidance of excessive distortion and similar mistreatment. Reversal of stresses incident to hoisting had been provided for in the design. At the start, four "crawler" cranes were employed, until a sufficient number of trusses were in place and tied together by the horizontal and vertical bracing system to laterally support those following. Thereafter three cranes were sufficient, one at the center and one at each quarter point. To maintain equal distribution of load while maneuvering into position, the closest coordination was necessary between the cranes.

LOCKHEED BUILDS NATION

ARCHITECTS: PARKINSON & PARKINSON



DETAIL OF ARCADE, LOCKHEED COMMISSARY
BURBANK, CALIFORNIA

Equipped to serve 60,000 meals a day, six days a week, over the steam tables and counters of a massive central cafeteria and from 22 canteens serving every Lockheed factory in the metropolitan area of Los Angeles, the new \$500,000 Employees' Recreation Club Commissary is said to be the largest employee-owned and operated "hot food on the job" project in the country.

The main cafeteria, served by six lines, seats 1700 at one time and is equipped to serve 24,000 meals every 24 hours. It is closed only on Sundays. An additional 36,000 hot meals can be rushed each 24 hours by specially designed insulated "hot and cold" trucks to the 22 canteens, some of which are miles away in cities where branch plants are operated.

Built and equipped by the Lockheed Company, the property was turned



GENERAL VIEW OF COMMISSARY OF LOCKHEED EMPLOYEES'
RECREATION CLUB, BURBANK, CALIFORNIA

LARGEST CAFETERIA

S ANGELES



Part of the main dining room equipped to serve 60,000 meals a day. Seating capacity 1700.

over as a gift to the employees' club to own and operate. The main cafeteria building, where all the food for the several canteens is prepared, is located on Empire Avenue, across from the main factory in Burbank. It occupies an entire block, 450 feet by 144 feet, with 65,000 square feet ground level in addition to 3000 square feet of office space on a balcony overlooking the main dining room. The latter is 144 by 100 feet with extra space for closed-off private dining rooms for special departmental luncheons or dinners. One small room is reserved for company executives.

Designed by John Parkinson and Donald B. Parkinson, all exterior walls are of reinforced brick with a concrete slab roof supported by reinforced concrete columns and beams. The interior partitions are terra-cotta tile.

Underground boiler rooms are fireproof, walls and slabs being of reinforced concrete. The transformer

(Turn to Page 28)

GROUND FLOOR PLAN

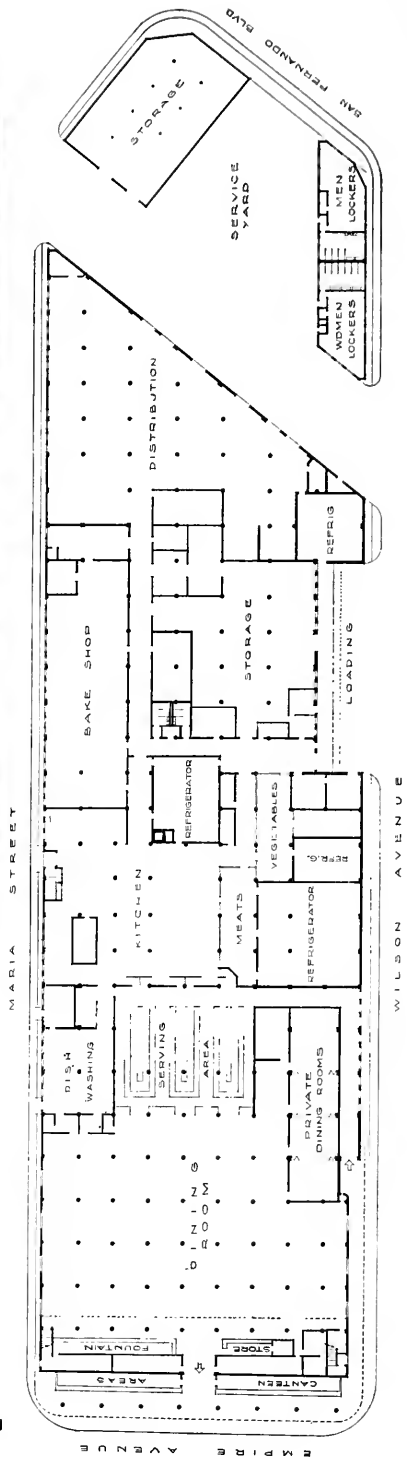

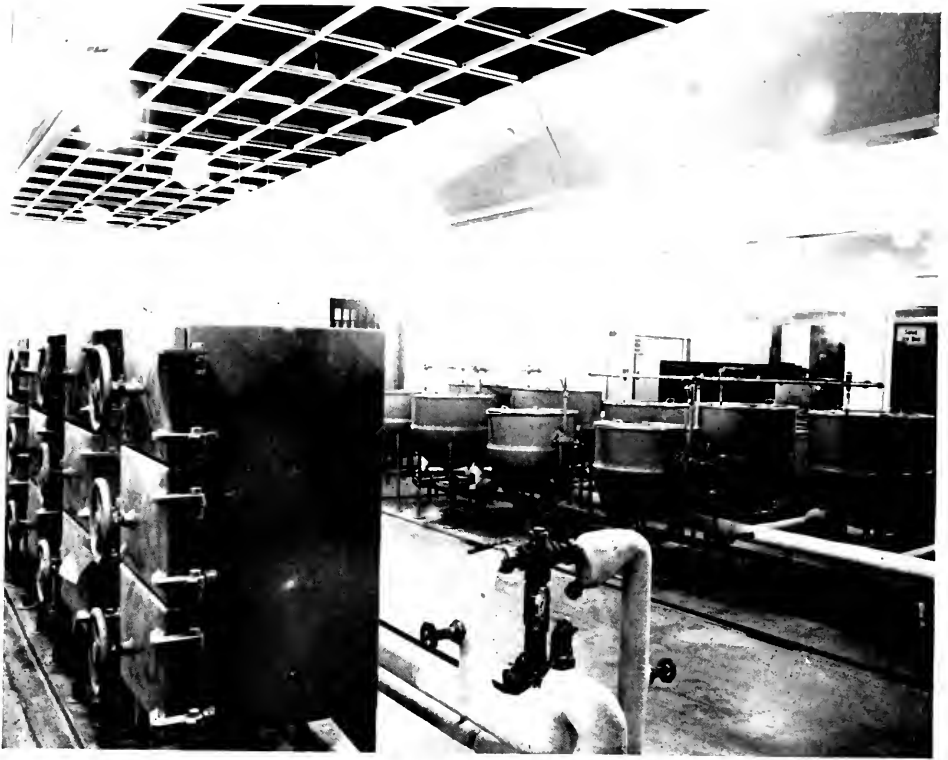

TWO ROWS OF GIANT KETTLES OPERATE LIKE DOUBLE BOILERS, UTILIZING STEAM RATHER THAN BOILING WATER FOR LIQUID COOKING



VENTILATORS

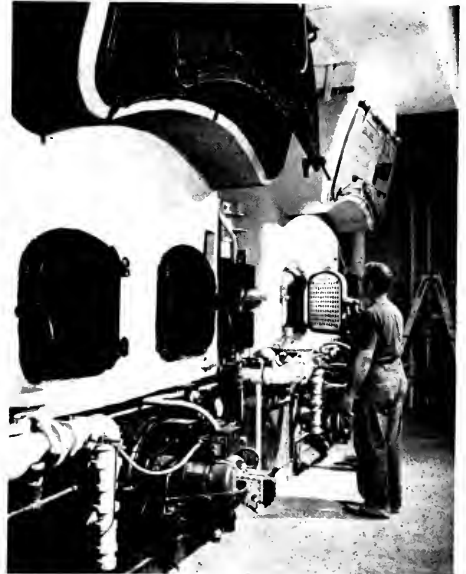

GAS AND OIL FIRED BOILERS PROVIDE STEAM HEAT



ARCHITECTS:
Leonard Schultze and
Associates
**RESIDENT
ARCHITECT:**
Earl T. Heinschmidt
BUILDERS:
Starrett Bros. & Eken
OWNER:
Metropolitan
Life Insurance Co.

**TYPICAL LANDSCAPED COURT, PARKLABREA PRIVATE HOUSING
PROJECT, LOS ANGELES, CALIFORNIA**

PARKLABREA APARTMENTS

Two of the better type of private housing projects will shortly be ready for occupancy in California—one in Los Angeles, the other in San Francisco. Financed and owned by the Metropolitan Life Insurance Company, which is investing more than \$25,000,000, the projects were originally planned to provide accommodations for 2500 families, but due to priority restrictions on certain materials, the owners elected to complete only portions of the two undertakings. The Southern California project, "Parklabrea," is in the Hancock Park District, while in San Francisco the improvements are near Lake Merced and have been appropriately named "Parkmerced."

None of the San Francisco buildings have been opened to tenants as yet, but they probably will be very shortly, at which time they will be featured in this magazine. The same architects, Leonard Schultze & Associates of New York, and the same builders, Starrett Bros. & Eken, also of New York, planned and built both "Parklabrea" and "Parkmerced."

The accompanying pictures of Parklabrea are shown by courtesy of Southwest Builder and Contractor, whose photographer succeeded in obtaining some excellent views despite the fact that construction and landscaping were in an unfinished state.



APARTMENTS ARE ALL INDIVIDUALLY PLANNED



The Los Angeles project was originally planned for 2750 units (11,000 rooms). Tightening war restrictions limited building operations to only two sections; one at the southwest corner of the 173-acre site on Fairfax and Sixth Streets, the other on Third Street, east of Fairfax.

All of the two-story buildings are grouped around courts to provide privacy for each apartment, some having entrances off the courts, others from private streets. The architectural motifs are Southern Colonial.

To avoid monotony, the architects have broken up the usual conventional pattern by introducing diagonal streets, staggered offsets in the building walls, and studied variations in architectural treatment of featured facades. The architectural details throughout are a refreshing improvement over certain other housing ventures of recent date.

Of particular interest in the planning is the concealment of service areas from the apartment courts and the streets. The garages are entered directly from the

PARKLABREA APARTMENTS
Los Angeles

Upper and lower views show
Colonial street facades.

Center: Staggered walks and
landscaped court.

Tommy Tomson,
Landscape Architect.





streets and are walled enclosures between apartment buildings. Extended open shed roofs shelter the cars, providing ample space to maneuver vehicles entering or leaving the garage. A one-story connecting building between the garages houses a community laundry for each block of apartments and this structure and the rear garage walls form an enclosure to be used for a playground.

All buildings have concrete foundations on spread footings and concrete floors on a compacted earthfill. Walls are reinforced brick construction with Class C interior and roof construction except for stairways which are hollow monoliths with reinforced brick walls and reinforced concrete treads and risers. These stairways, built before erection of the buildings was started, also rest on concrete foundations. Windows and door frames are steel and doors are wood, all specially designed and milled.

Exteriors of all the buildings are painted, while the interior walls and ceilings are plas-

(Turn to Page 28)

PARKLABREA APARTMENTS

Los Angeles

All the two story buildings are grouped around courts to insure privacy.

Pictures show studied treatment of apartment entrances.

Note protecting canopies over entrances.





Height of apartment structures flanking garages is accentuated and roofs are hipped architectural variations. Garages are concealed from courts in this view.

Below, Colonial staircase in a six room apartment. Living room and kitchen are on the ground floor with bed rooms and bath above.



Two front entrances to apartments. Note ventilators over windows. Walks fringed with shrubbery.



WHEN ARCHITECT'S ACCEPTANCE OF CHECK SPELLS PAYMENT IN FULL

by LESLIE CHILDS

There is no point of commercial law better settled than that the acceptance of a check, tendered as settlement in full of a **disputed** account, will constitute payment in full. Yet business and professional men are continually tripping over it. And, as an example of the application of the rule to a dispute over an architect's contract, the following will serve:

Here the plaintiff, an architect, contracted to draw plans and superintend the erection of a building. Plaintiff received payments from time to time, and upon completion of the work submitted a bill for a balance due of \$470.80.

The defendants, owners, refused to pay this claim, on the grounds that it was excessive, and countered with an offer of \$245.80. The plaintiff declined to accept this offer, and the dispute dragged along for some time.

Finally the defendants mailed the plaintiff a check for \$245.80, which carried a notation upon its face that recited: "In full of a/c." Along with the check the defendants detailed their objections to the plaintiff's charges, and made it clear that the check was being tendered as settlement in full of all claims under the contract.

The plaintiff cashed this check, credited the amount on account, and then filed suit for the balance he contended was due. The defendant set up an accord and satisfaction, on the grounds that by accepting the check plaintiff was barred from thereafter collecting anything additional.

Plaintiff had judgment in the lower court. On appeal, however, the higher court in reversing same and in directing the dismissal of the action reasoned:

"In the present case there was but one con-

tract, and the only object sought to be obtained was the construction of the building which was in fact built. While plaintiff may have been entitled to maintain an action upon quantum meruit for extra services rendered, the various claims were so interwoven as to constitute an unliquidated demand, and, when coupled with the contentions by defendants, and which they introduced testimony to support, show that none of this claim was in fact liquidated, and when plaintiff accepted the check with the conditions under which it was tendered, he must be deemed to be bound by those conditions. * * *

"It is well settled that, where a claim is unliquidated or in dispute, payment and acceptance of a less sum than claimed in satisfaction operates as an accord and satisfaction. * * * In our opinion the affirmative defense is sustained by the evidence, and the judgment will be reversed, with directions to dismiss the action." (208 P. 260.)

So ended the case with the plaintiff, architect, being denied any recovery upon his claim for additional payment. Too, his acceptance of the check, tendered as settlement in full of the disputed account, also barred him from even litigating the justness of his contention that he was entitled to a balance due.

On the foregoing, it is obvious that an architect may well be cautious in situations of this kind. If a check so offered is less than his claim, and he is not willing to accept it as payment in full, it promptly should be returned. For, as illustrated herein, if accepted it may constitute an accord and satisfaction and result in the loss of valuable legal rights.

NEW TRENDS IN POST-WA

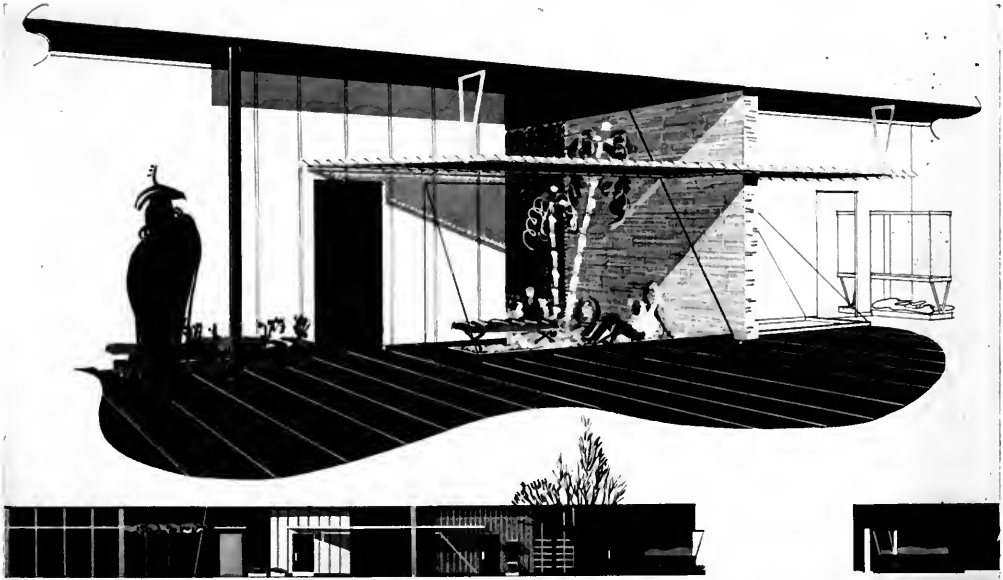

Recognized for its originality and splendid presentation, this design by Robert Bezzo, of Pullman, Washington, suggests a type of small shop especially suited for Pacific Coast or resort use. The walls at entrance could be solid, as indicated, or transparent to reveal the interior.

As indicated in this magazine some months ago, Pacific Coast architects played a prominent part in the national architectural competition sponsored by The Kawneer Company, of Niles, Michigan—originators of the modern store front—and the New Pencil Points.

Maynard Lyndon, of Los Angeles, won third prize for his outstanding store front design. Donald E. Olsen and Alvin Fingado, of Berkeley, received honorable mention, as did Stanley Sharp and Jedd Reisner, of San Francisco. Special commendation of the jury went to Whitney R. Smith and Robert W. Dickinson, of Pasadena. The design entered by Robert Bezzo, of Pullman, Washington, and shown above, was purchased by The Kawneer Company.

Store fronts that reveal the interior of the store, sheltered "window-shopping areas" that allow prospective customers to avoid sidewalk traffic, and free-standing and movable exterior display cases that lure the pedestrian into such areas, are some of the trends uncovered in the competitive drawings.

The architects have based their suggestions not only on good architecture and good taste, but also on other considerations, such as store identification, pedestrian traffic, buying habits, and the primary store-front problem of attracting the interest of the passerby and getting him into the store.

The entire store, in fact, has been considered as a device for selling goods or services, and functional design has been employed to this end. Thus, the store front of the future will be an even more practical sales tool for the retail merchant than ever before.

First, there is the trend to the "Open-Face Front," which reveals the interior and makes a display theater of the whole store by the use of transparent materials and the elimination of the continuous show window back. This is an attempt to get away from the psychological obstruction of the conventional "closed type" front, and more effectively invite entrance. Display windows, however, both large and small, continue to be used in the "open-face" type.

(Turn to Page 34)

STORE FRONTS

STORE

Prize-winning store front design entered by Maynard Lydon of Los Angeles. From the report of the jury: "This picturesque solution attempts to combine building-line display with a general central arcade. There is a good sweep to the projecting marquee, and a good anchor for this feature in the projecting restaurant . . . the most noteworthy feature of this design is its lighting system. Surface reflection on window glass has always been a hindrance to clear vision of store interior. Here, it is counteracted by the shadow of the projecting roof and by an excellent system of combined daylight and artificial light just inside. The designer has skillfully combined a glass brick skylight with combined flood and spot-lighting for the window displays. In the case of the restaurant, "invisible" glazing supplies a view of the interior . . . the store interiors themselves are the display."

RESTAURANT

Honorable Mention design submitted by Donald E. Olsen and Alvin Fingado of Berkeley. From the jury's report: "This entry shows a new and imaginative system of store front construction, with unlimited possibilities for flexibility in advertising and display. The structural members of the store walls are the only permanent feature. On these may be clipped opaque or translucent plastic panels in whatever pattern the designer wishes—from an open-front to a solid poster wall. Since the panels are of stock size and make, it is possible to vary the design of any store front from time to time. The signs would also build well, preferably as neon tubing. The designers have not forgotten that roof signs are chiefly valuable from a distance. They have also shown small store front lettering for closer vision. . . ."

FOOD STORE

Design by Stanley Sharp and Jedd Reisner of San Francisco, Honorable Mention, and characterized by the jury as "perhaps the most sophisticated rendering presented in the entire competition . . . and excellently detailed." Further, "The staggered system of store fronts is a good idea . . . the food store interior is nicely handled. The signs, the display systems, and the lighting are excellent."

IN THE OPEN

This design by Whitney R. Smith and Robert W. Dickinson of Pasadena, won Special Commendation of the jury which characterized it as "imaginative and beautifully presented . . . based on the supposition that science will some day permit control of weather, without use of enclosing walls." In this design the storekeeper finds that customers have free access to the store—something now possible only in a public market. Yet in the market or department store the individual storekeeper loses his independence. . . . The group plan is well handled. Public circulation is excellent. Signs, displays, vistas are the best of their kind. Freedom, flexibility, and spaciousness result from the treatment of the store party-walls as low, free-standing screens. . . . Even with the glass fronts and glass screens (from party walls to ceiling) which would probably be needed if such a project were to be built today, this would still be distinguished architecture.



THE POST-WAR KITCHEN

The kitchen of tomorrow may not be revolutionary, but the one of day-after-tomorrow is sure to be a lulu, if expectations of Jared A. Hill, domestic utilization engineer of the Pacific Gas and Electric Company, come true.

"Immediately after the war we will have 're-sumption-models'—really 1941 or 1942 models on which the machinery is ready to go," Mr. Hill says. "In some cases manufacturers even have their pre-war factories set up for immediate production. Others may take as long as six months for reversion. At any rate, 're-sumption models,' with little or no change, will be ready for the consumer in short order.

"As to new, strictly post-war models," Mr. Hill says, "it's still too early to know what to expect, except in general terms. Certain it is that most manufacturers will have automatic washing machines. These may be similar to the few pre-war models on the market or they may go much further. One manufacturer is said to have a complete automatic unit, consisting of washer, dryer and ironer—a fully equipped automatic laundry capable of doing everything but put the clean linen away.

"While there will always be a market for portable, 'plug-in' laundry equipment, it seems certain that the bulk of home laundry appliances in the future will be permanently installed—fastened to the floor and connected to electricity, hot and cold water and drains, as much a part of the house as the bathtub."

Kitchens are due for surprising changes, according to Mr. Hill, who looks for an era when both refrigerators and ranges will be divided into parts and placed where they will offer the most convenience.

"Refrigerator compartments," he states, "may be situated in various parts of the kitchen, with different temperatures suitable for different types of storage. For instance, the ice compartment might be close to the sink, left-overs by the pantry, and, near the stove, frozen foods, cabinets for which will no doubt be in every home. The compressor unit, under this arrangement, could be in some remote place, such as the basement or a storage closet. These new refrigeration units, scattered about, will probably have top openings (to prevent loss

of cold, dehydration, etc.) and might even be in the form of drawers, which would pull out and provide complete visibility of contents, as well as ease in placing or removing foods therein."

The breaking up process for the kitchen range—particularly the electric range—also offers plenty of pleasant surprises, Mr. Hill suspects. Cooking surfaces may be scattered—possibly two or three burners together, and one off by itself for the convenient simmering of sauces, gravy or frosting. No more stoop, no squat, no nylon runs, no charley horse in the cook's torso to inspect the beautifully streamlined, to be sure, but d—inconvenient broiler hovering near the floor. New broilers and ovens, unhampered by the general effect of the stove chassis, will come popping out at elbow level or any other spot the home builder may designate in the architect's blueprints.

In the kitchen, Mrs. America will be able to do three-quarters of her work sitting down. She'll hardly ever have to stoop or bend. She'll have no pots or pans to wash, will cook in the same dishes used for serving, and will be able to go out for the afternoon while automatic timers stand guard over the dinner as it cooks. She'll even have a special cabinet that dries dish towels with the heat generated by the compressor that refrigerates her food!

Another kitchen improvement will be pedal operated faucets at the sink, leaving hands completely free for other tasks. Kitchens of the future will probably go fluorescent, with cove or general overhead lighting, plus localized lighting over working surfaces furnishing higher illumination for the kitchen than ever before.

Mr. Hill says the post-war contractors and home builders are considering the idea of selling "packaged" equipment—a home complete with built-in refrigerator, dishwasher, stoves and laundry equipment—all part of the house and figured into its selling price, just as plumbing is today. This would add little to payments and would provide owners of small homes the convenience of owning all appliances at once.

With the new use of electricity and a wider variety of appliances, adequate wiring would seem to be a "must" in homes of the future.

THE KITCHEN OF TOMORROW (Cut 1)

As Visualized by a Libbey-Owens-Ford Engineer

In the past, the kitchen and dining room have constituted the greatest area of waste space in the average home because their utility has been limited almost entirely to the preparation and serving of food. Thus, a large part of the time they stood idle.

The Kitchen of Tomorrow is a 'round-the-clock room. All equipment used for the preparation and cooking of food-stuffs is so designed as to allow it to be closed when not in use. The natural wood finishes on all cabinets harmonizes with other furniture in the house and this area now becomes just as attractive as the living room. Between meals, it can be converted into a study room, game room, buffet bar or other extra living space.

After an exhaustive study of conventional kitchen equipment and analysis of its efficiency, H. Creston Doner, head of L-O-F's department of design, developed suggestions for new equipment radically different from anything that had been seen before. Bending and stooping is practically eliminated by hanging all cabinets and fixtures from the wall at proper working level. Ample foot space beneath the cabinets permits the housewife to do 75 per cent of her work sitting down.

KITCHEN AND DINING ALCOVE (Cut 2)

Spacious, bright and colorful, the Kitchen of Tomorrow and its adjoining dining alcove represent a long step forward in the concept of the part these rooms can play in domestic living. Walls are of richly colored Vitrolite glass, offset by softly glowing translucent panels and huge windows that welcome sunshine and the outdoors.

The handsome cabinet separating kitchen and alcove is, in reality, the refrigerator, built horizontally so that one end serves as a convenient counter while the other supports a glass-shelved, indirectly illuminated china cabinet. Both refrigerator and cabinet have sliding doors on each side, making them accessible from either room.

The striking "mural" on the alcove wall is actually the dining table. The decorated glass top swings up against the wall when the table is not in use, its design forming a mural which is framed by the folding legs.

REFRIGERATOR UNIT (Cut 3)

Built directly below the service counter separating kitchen and dining alcove, the refrigerator follows the principle of food store cabinets by being divided into a series of individual compartments with controlled temperatures for each. It has a capacity four times that of the average present-day home refrigerator. Sliding transparent Thermopane doors make stock-taking and food selection easy and provide exceptional insulation. In the center of the refrigerator a revolving turntable, with shelves of Tuf-flex or clear plate glass and divided into four sections, is used for frequently-needed foods—custards, salads, cream.

The end of the refrigerator unit next to the work top would normally be waste space, but here the space is used to house the refrigerator unit. A small towel cabinet between the refrigeration unit and the refrigerator proper uses the waste heat from the refrigeration unit to dry the kitchen towels.

ROOM FOR PLAY (Cut 4)

With table swung up against the wall, the full floor area of the dining alcove immediately becomes available for play pen, games, sewing or other activities that would otherwise be difficult or impossible. Both doors on the alcove side of the refrigerator could be of opaque material if desired.



LOCKHEED CAFETERIA

(Concluded from Page 17)

room and balcony are reinforced concrete, and the ground floor is a plain concrete slab. The floor slopes from north to south, with a drop of approximately four feet in the 450-foot length of the building.

The average ceiling height is sixteen feet.

There are specially designed floor drains to take up water used in steam cleaning the kitchen and storage areas which occupy four-fifths of the entire building. These drains divide the floor into sections for quick, easy drainage.

All materials in the building were of minimum requirements in accordance with WPB limitations on scarce or critical products. A 3000-gallon concrete oil storage tank is located underground. The boilers normally are operated by gas, but oil is used as a standby in case the gas company requires a temporary shut-down to save the consumption of gas. The burners are so designed as to be able to use either gas or oil.

Steam heat is carried through one- to four-inch insulated pipes and radiators are placed at floor level. There is also a circular-type overhead radiator system.

Incandescent fixtures are used for lighting. In the main dining room the fixtures were designed for war, being simple wooden boxes with a high gloss enamel with the lower part of the bulb frosted to give an indirect light at low cost and minimum use of critical materials. Each fixture recedes about 14 inches into the ceiling and uses a 250-watt bulb.

The \$300,000 kitchen equipment includes a \$65,000 refrigeration system.

There is a ventilation fan under each of three hoods located directly over the three sections of cooking equipment (gas ranges, fry-kettles, soup kettles and steam pressure vegetable cookers). These hoods are of special design

and supplied with filters to eliminate the gathering of grease.

There are complete public address and intercommunicating systems throughout the plant. Total personnel of the Commissary approximates 450 persons.

PARKLABREA APARTMENTS

(Concluded from Page 21)

tered and painted. All floors, except in kitchens and bath rooms, are hardwood paraquet blocks laid in mastic. The bathrooms have white tile floors and wainscot; kitchen floors are covered with linoleum. The fixtures include enclosed sinks with cabinets, gas or electric ranges and

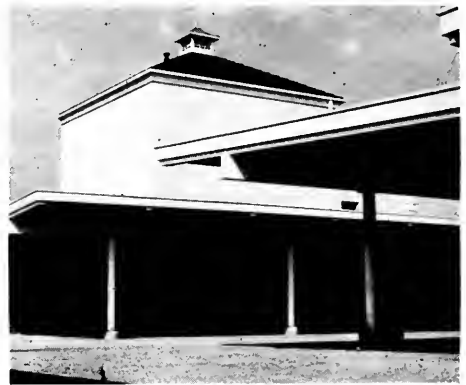

Typical private garage for tenants of Parklabrea Apartments, Los Angeles

electric refrigerators. There is an individual gas-fired forced-air heating unit for each apartment and a central gas-fired water-heater serving each block of apartments.

There are from three to six rooms to each apartment, some complete on one floor and others with living rooms and kitchen on the ground floor and bedrooms and baths above.

Earl T. Heitschmidt of Los Angeles was associate architect of the project with Paul Jeffers structural engineer, and Ralph E. Phillips mechanical engineer.



BLIMP HANGAR UNDER CONSTRUCTION FOR U. S. NAVY

FIREPROOF WOODEN HANGAR FOR PATROL BLIMPS

by **FREDERICK HAMILTON**

The score or more giant flameproofed wooden hangars for the coastal patrol blimps, which have recently been completed for the Navy under the Bureau of Yards and Docks plan, are said to have few, if any, structural precedents. The timber frame hangars consist of an oval-arched roof, stiffened by a series of arch ribs, and two-end doors. The dimensions run: 1000 feet long, 170 feet high at the crown, nearly 300 feet wide at ground level.

Doors for the huge openings at either end of the hangars were unusual engineering problems in themselves. It was necessary to construct them to be independent of the main building so that they would not weigh upon the hangar framing. This framing could not be built to resist either the weight of doors generally used for steel hangars of similar shape, or the wind pressure which would be transmitted from the doors of such immense area. Meeting these design problems, two types were finally selected: (1) a flat sliding door with separate support, and (2) a semi-dome door which would be self-supporting in any position from open to closed.

Twin reinforced-concrete pylons support an enormous, square, built-up timber girder to guide the flat, sliding door

Five-eighth-inch Douglas fir plywood panels were chosen for covering framework to gain maximum rigidity with minimum weight in the doors. Plywood flame-proofed by Minalith system.



type. Multi-leaf electric operators will close and open the six sections of the doors at the touch of a button. The leaves are 120 feet high and are supported laterally by guide rails



Flame-proofed wood sheathing is nailed to purlins on a steel door leaf.

at the top. They roll on flanged steel wheels over railroad-type tracks. The operating mechanism is so engineered as to move the several segments, or leaves, at different rates of speed—the second traveling twice as fast as the first, and the third three times as fast—causing all three leaves to arrive at open or closed positions simultaneously. Maximum speed of the flat door is 75 feet a minute, making it possible to open or close these doors in less than two minutes.

The basic requirements of rigidity, light weight, and large size offered a design problem which was met at three different bases by three different combinations of materials, including one new product, which has an ex-

remely important future—flameproofed plywood. One solution to the problem of door construction uses steel frames (actually box trusses on end) faced with pressure-flameproofed 1x6 tongue-and-groove pine sheathing, nailed to purlins on the truss face. Another design incorporates steel longitudinal members stiffened with wood braces which furnish the base to which asbestos-cement boards are fastened. At the Santa Ana base, the door retains the all-steel truss frame, but is sheathed with flameproofed Douglas fir plywood, mounted on steel angles bolted to the frame.

Because of its light weight, and the large size of the panels, the treated plywood sheathing permitted faster, simpler erection than either of the two other types. No scaffold was required in mounting the plywood sheets on the door panel trusses; the sheets were handled by a Moto-crane with an extended boom, two or three men placing and bolting up the panels. Materials used throughout the hangars were fabricated.

Each set of doors, built in six sections, closes an opening about 120 feet high and 220 feet wide. The leaves, in effect, are box trusses on end with plywood covering $\frac{5}{8}$ -inch thick on the outside bolted to steel framing members.

Exterior (waterproof) type fir plywood in sheets 12 by 4 feet were supplied to the door prefabricator who assembled them into sections 12 by 16 feet. En route from the plywood factory to the door builder, the panels were flame-proofed by the Minalith system.

Design and construction of all the hangars (referred to in Navy parlance as "docks for lighter-than-air craft") was supervised by Rear Admiral Ben Moreel (CEC) chief of the Bureau of Yards and Docks, U. S. Navy. Private contractors have carried out the bulk of the expanded work of the bureau with James I. Barnes, Santa Monica, California, general contractor for the Santa Ana hangar.

ARCHITECTS, GET BUSY!

by MILES A. COLEAN

Chairman, A.I.A. Committee on Post-War Relations with Government

The war has struck the architectural profession about as drastic a blow as did the financial collapse of the early thirties. It has left it high and dry, empty-handed, with little hope of immediate relief. But there is at least one very important difference between the two catastrophes.

The depression not only disrupted the profession, it destroyed the profession's clients. In the almost complete coma into which the economic system had fallen, private initiative languished, private funds were dissipated or frozen in fear, private construction sank to an all-time low, local public works programs were ended, and the Federal government was left as the only instrumentality with resources enough to set the wheels of industry again in motion.

In those confused and discouraging years, the architect, if he was able to obtain a job at all, was forced to look directly or indirectly to the government. He might be selected to design public works or public housing projects; he might take a job in a Federal or local governmental agency for which his talents suited him; he might develop some project financed with Federal funds or with the aid of Federal mortgage insurance; he might twiddle his T-square in the hope of a better day; he might, at worst, go on relief. But usually his normal sources of employment were just not to be found.

The war, for all the present difficulties resulting from the prohibition of private work and the current rapid cessation of public building, has restrained but not destroyed the architects' prospective clients. Back of the necessary restrictions of wartime are generally large numbers of houses, shops, schools, hospitals, and in many places office buildings, hotels, and factories—all waiting to be built.

It is helpful to recall that, when the war struck, construction was only beginning to show full recovery from the disastrous depression

years. Housebuilding, with only three new dwellings built for each five new families (net) formed between 1930-1940, was still far behind the potential demand. The general real estate situation was just reaching the point where the need for commercial buildings of various sorts was making itself felt. Municipal improvements in many cases were still lagging.

The complete shutdown of these activities (except where they could pass the rigid requirements of war necessity) has served to increase the potentialities of demand. Cities have continued to grow, and existing structures have continued to depreciate. In fact the difficulties encountered in carrying on even normal repair and maintenance has accelerated depreciation above normal rates.

But beyond the basic facts of increasing growth and depreciation, there is another, probably even more fundamental. There should be money available with which to build. In spite of taxes and mounting living costs, people have been able to save. The down payment problem should be at least somewhat lessened in the early post-war period and the more favorable income situation should relieve the almost hopeless situation we faced in meeting the relatively low income demand of the thirties. Cities also have been able to save. Tax collections have improved and municipal debt has declined. The means for improving and adding to municipal facilities should consequently be available. Many businesses, in order to adapt themselves to the post-war market will need new buildings, and will have, even after all wartime deductions, funds to proceed. Financial institutions will have ample resources to supplement equity investment. Interest rates in all probability will continue low.

The prospect is certainly a brighter one for architects to face in a time of inactivity than they had in the bleak days of the last decade. Good as it is, however, it should not provoke unalloyed cheerfulness, for in it there are sev-

eral important ifs. If the transition from war to peacetime activity is bungled, if capital is not to be enabled to get rapidly to work, if unemployment should become serious, the pleasant prospect might very quickly fade. Then again we might be in the old cycle of relief and made-work, with construction, as usual, trailing in the recovery procession.

Whether the favorable prospect is realized or not will depend in no small measure on those in the construction industry. It is now being frequently said that construction should play an important part in post-war readjustments because construction can be more easily reconverted to normal operations than any other industry. This is true, but it is true only on a strictly mechanical plane, in that the labor and tools and management necessary for war construction are precisely the same as are needed for the works of peace. But the possibility of taking advantage of this convertibility depends on having ready the plans from which to build. Plans come first; and plans take time.

The architects, therefore, are at the very spearhead of a successful transition period. They must not only make plans but they must sell their prospective clients the idea that it is vital to have plans ready when the first break in the labor and material supply occurs.

Aside from the Bureau of Public Roads, no federal agency has at this time any funds for the preparation of plans for public works. There is legislation pending in Congress, but it is likely to continue pending for several months, with a subsequent period of organization for action when and if the legislation is passed. After that may come more delays before funds are appropriated and allocations made for actual construction. Few of the states and cities have real planning under way. Private business, still preoccupied with the war effort, is apt to be either slow to recognize the necessity for prompt action when war demands decline or without the facilities and personnel to deal effectively with postwar problems.

Lack of plans made it impossible in the early thirties to get a useful economical public works program promptly inaugurated, with the result that a hastily improvised PWA became neces-

sary. Lack of plans tomorrow may lead to a similar result. "Dreaming," as General Fleming reminds us, "is not planning," and plans are something more than "vague, generalized ideas." Plans are the hard stuff of working drawings and specifications, of soil tests and engineering details. They presuppose the acquisition of definite sites. They imply careful cost estimates, evidence of economic soundness, and financial arrangements. Such preparatory work will take months of work before the construction industry, easily convertible though it may be, can dip a shovel or lay a brick.

Architects know all this, but too often they are willing to wait for others who do not realize it so well to take the initiative. And then, out of fear of losing a job, they are too likely to minimize the time that should be allowed them for designing and other preparatory work. It will not be safe to make these errors in the period ahead.

It is proper for architects, individually and through their societies, to urge upon government—Federal, state and municipal—the advisability of making immediate provision for preparing plans and acquiring sites for useful public works. (Note General Fleming's admonitions in August issues of the "Architectural Record.") More important, however, is the work that architects might now be doing in stimulating action by their private clients.

Preparation for private work is important for several reasons. Private operations can be got under way much more rapidly than is possible with work carried on under the cumbersome procedures of government. They can bring into the picture a more varied group in the construction industry than can public projects. They can more quickly get a wide geographic spread. And, most vital of all, the extent to which private construction is ready will largely determine the amount of public work that will be necessary.

Every architect who can now persuade a client to authorize plans for a house to be built at the earliest feasible time is making a real contribution to the post-war world. Every architect who can now assist an operative builder in laying out his land and planning his dwellings to meet postwar needs is doing the same. And

the same applies to the new apartments, shopping centers, theaters, commercial buildings, and important alterations that await a slackening in the materials situation.

Initiative in getting plans under way requires more than exhortation, although plenty of exhortation may be needed. The architect must bring to his client a good knowledge of the building needs and the economic prospects of his community. This he can acquire through information obtainable from his local FHA office, from his bank, from special reports prepared by the Bureau of Census, the Bureau of Foreign and Domestic Commerce, the Bureau of Labor Statistics, and from such private organizations as the Committee for Economic Development, the local Chamber of Commerce and Real Estate Board. In reverse, he should be prepared to persuade the local FHA office (if it is involved) and the local lending institutions (which almost certainly will be) of the practicability of his projects.

The architect must also keep himself constantly current with the labor and materials situation. Labor for private construction work will not become available in all areas or in all trades at the same time, nor will all building materials be obtainable in normal quantities at once. Plans must be made in view of the fact that surpluses will appear more or less gradually and unevenly. The architect who, through exact knowledge and clever specifying, can take advantage of these surpluses as they appear and avoid serious demands on materials that may still be critically scarce will be the one who gets his projects started first. He should consequently keep in touch with WPB representatives, with contractors and material dealers, who are in close touch with the materials market and regulations affecting it.

The architect will also have to keep informed about new materials and appliances. Sometimes he will be able to find a new product available in sufficient quantity to provide a practicable substitute for a scarce article. More often, unfortunately, he will have to be prepared to persuade his client that the ecstatic tales of the startling innovations to be had when the war is over are so much moonshine. Innovations there will be—in time—but few of them will be ready when construction is

ready to start again, and most of them will filter into the market without any revolutionary effect on existing structures.

In preparing for future work, there is yet another activity that architects may helpfully engage in. The general programs that are discussed for the post-war era too often skip the period of transition and the problems involved in moving from a war to a peace footing. But before any nonwar building can take place there are first of all to be faced the grim realities of L-41 and other WPB and OPA restrictions. How are these orders to be successively modified so as to smooth out the difficulties of transition? to prevent unemployment in areas where war activity may slacken? to aid in the reestablishment of private construction enterprises? and to assure an equitable distribution of surplus materials?

The solution of these very practical problems is the first step in an overall post-war construction program. And the time to begin thinking about it is at hand. Architects, through their societies, should work with engineering, builder, and real estate groups to answer these questions and to advise in respect to them with the Federal authorities. A procedure for transition must be thoroughly worked out before transition can begin. And none of us knows how soon this beginning may properly occur.

The activities suggested here should in no way detract from a vigorous prosecution of the war. The contribution of the architect, as such, to the war effort is largely over. His time, his effort, and his imagination are available for the next step, and he is doing his country no disservice in making use of them to that end. On the contrary, the architect can and should, if properly engaged, be able to relieve those of his clients who are still busy with war work of much of their concern with the tasks that lie ahead. He should expect to undertake much of the work of investigation and of site and financial negotiation that, under normal circumstance, the client might do for himself. Without pressing any move that would in the slightest way disrupt our present concentration on war production, he can be prepared to press with the utmost vigor when such disruption is no longer a danger.

NEW TRENDS IN STORE FRONTS

(Concluded from Page 24)

Another trend is toward the use of exterior free-standing display cases, often movable—which provide an additional "side-show" to whet the shopper's appetite. The impact of new displays can be thus enhanced by changes in the position of the display cases themselves.

Group Planning of stores is also favored. The obvious advantages of a well-planned shopping center are gained for all the stores in the group. Control of signs contributes to the general effect, and a Sheltered Window-Shopping Area is provided for individual stores, or for the group, by moving the entrance back from the building line and, in effect, widening the sidewalk. In other words, part of the normal store area is covered, but not enclosed, and people find themselves practically inside the store before they know it. In Many of the designs this sheltered window-shopping area is protected by an overhang; in others, by various devices which take the place of the canvas awning.

A revolution in store equipment is not improbable. As to lighting, competitors suggest more intense lighting of the show window and store area immediately behind it. This added lighting, combined with greater protection from direct sunlight on the outside, is intended to do away with distracting reflections on the show-window and display-case glass.

Greater flexibility of the entire store front is recommended, so that changes can be made without major expense, or alterations. In some

cases, interchangeable wall panels are provided—with choice of opaque or transparent panels, and of various colors and materials. Thus, the nature of the front could be altered, from time to time, to meet new merchandising requirements or for satisfying, more specifically, the needs of new tenants. Provision is even made for the removal of certain walls, so that the store or restaurant can be opened up in favorable weather.

In the past, the sales efficiency of many store fronts has been actually lowered by the use of poorly planned, and over-flashy, signs of various types. The new trend is to plan the necessary signs as part of the architectural scheme, and keep the whole front in harmony and good taste. If properly executed, this development does not mean the elimination of signs but rather a better, more exciting use of them—to attract attention, gain quick identification, both from the street and sidewalk; and avoid unnecessary competition with good merchandise displays.

Looking into the future, it is obvious that store front manufacturers will offer many new and startling developments after the war. According to The Kawneer Company, that organization is now engaged in extensive research with the purpose of providing progressive merchants with the most effective sales tools that modern methods can create. Announcements will necessarily have to await the winning of the war, for this company's entire production facilities, like many others, are today harnessed 100 per cent to the war effort.

BOOK REVIEWS

PRECAUTIONARY CAMOUFLAGE—United States Office of Civilian Defense, Washington, D. C.; O.C.D. Publication 2019, Sept., 1943; U. S. Government Printing Office, Washington, D.C. Price, 15 cents.

The authors state that this booklet is intended for civilian rather than for military consumption. It should serve as a foundation for those who may be technically responsible for the designing and execution of camouflage projects, come next war.

The problems of Camouflage, or Protective Concealment, are ever green, so to speak. While principles persist and basic writings still govern from your bookshelves, added to the current knowledge of the subject are new ideas developed in the light of recent study and experience.

Civilian camouflage, if one can name it so, may currently appear to be in neglect. The fact is that we have gone over to the offense. Another reason was the scarcity of materials and labor which prevented elaborate schemes of "corrective camouflage." The tendency in this booklet is to develop and treat the activity in the field of "precautionary camouflage," a planning effort without much dependence upon artificial and critical covering materials. To sum up it is a "preventive" policy in planning and performing—a watchfulness of measures which, if properly taken care of at the beginning of a design of construction or site plan, will bring dividends later in terms of economy of material and labor. The authors also state that, "the urgency of actual corrective camouflage, though important in special instances, is generally less important than the urgency for precautionary planning in terms of camouflage." The authors point out that "actually there lies before us a vast field of study and activity applicable to the attainment of low visibility." Because of this need, and because of the fallacy of continuing to neglect it, this booklet has been prepared. Its purpose is to focus attention on what today looms as practicable, workable measures by which may be attained low visibility, siting and planning, thus forestalling the subsequent demand for covering up. "If a goal is not now established, what will be left on which to build, except another vacuum such as followed the first World War?" the author asks.

The question arising in my mind is, how can we plan in advance for war when we are not a nation planning for war for years to come?—not even for revenge. The principles stated rather generally in the booklet are perhaps impossible of achievement, at least not for some time. They belong to a class of speculation in which broad problems of regional control of our civilian activities are involved. Suffice it to say that good

general planning is reciprocal with good camouflage planning. In effect it is an attempt to revise much of the problems of concealment by means of rational planning. Long-range regional and local zoning prohibition of construction and general design of facilities with a view to decentralization, dispersion, obscuration, etc., is a job to be controlled by the military with some central authority. By accomplishing such planning we shall have lessened the damage that can accrue from bomb hits and the consequent damage from fire. This is based on the contention that we cannot achieve the approach to perfect concealment. We, therefore, must deceive or divert the attention of the bombardier, and thus retard his decision, or throw him off his track.

It must be said that to a great extent other means have replaced the need of camouflage. They are better warning devices and more skilled defense organization based on fluidity of deployment of forces and action.

The thinking expressed in this booklet is in direct connection with comprehensive laboratory studies conducted in the United States. Interesting pilot projects were designed for some target areas and cities. In England application of camouflage on the same general basis developed recently to serve pertinent needs. Unfortunately military camouflage is a secret of which we shall hear after this war, or come next war.

Note must be made that in addition to the novelty of using current planning expressions, the booklet in no uncertain terms advocates the use of capable architects, planners and landscape men instead of the old dabblers.

In conclusion, credit must be given to those workers of the Camouflage Section of the 9th Regional Office of Civilian Defense in San Francisco and their laboratory associates in Los Angeles, due to whose efforts this thinking originated, and which may form the basis of things to come in Protective Concealment.

—Michael Goodman

THE NEW A.I.A. JOURNAL

Announcement in recent issues of The Octagon that this long-standing house organ was to be superseded by a new journal more representative of and useful to the architectural profession, had aroused both interest and curiosity. January has brought the answer in Volume I, Number I of the Journal of the American Institute of Architects.

Perhaps the moment is unpropitious for launching a new venture in publications. Perhaps the editors feel that rise from a modest start is in the long run a safer policy than decline from a sudden flash. Barring change in format and elimination of the specifically "house organ" material, there is not a great deal by which the new publication is to be distinguished from the old.

The articles are commendably realistic, illustrations few, but good. Improvement with age may naturally be expected.

F. W. J.

ARCHITECTS INDORSE HOME PLANNERS' INSTITUTE

by ROI MORIN, A.I.A.

Most people have no conception of the importance of having an architect design their home. By **most** I mean the average American who will be building the million homes in the \$4500 range after the war. Many of these people look upon the architect as a visionary, an artistic genius, the playfellow of the rich who builds a \$50,000 home.

This average man never meets an architect. When he decides to build a home, he works out his floor-plan with some carpenter or contractor friend who, more than likely, adapts a house design from some stock plan. Thus the owner has a home which is not suited to the individual needs of this family or his particular tastes.

It is just as foolish to have a carpenter design a home as it would be to have the linotype operator compose one's story.

But now a national movement has been set in motion for teaching prospective home owners how to build an ideal home. Since night school enrollments are booming during these war years, night classes in home building are being conducted by an organization called the Home Planners' Institute. This plan was described briefly in the October issue of *Architect and Engineer*.

Classes started in October in Portland, Oregon. Enthusiastic groups of home owners meet in the lobby of the Equitable Savings and Loan Association. The enrollment was so large that different sections were formed, and these sections meet on different week-nights. Soon the two lumber organizations—the West Coast Lumbermen's Association and the Western Retail Lumbermen's Association—will make the Institute available to cities throughout the country.

The Oregon Chapter of the A.I.A. is giving the Institute its genuine support and cooperation. The executive committee of the Home Planners' Institute came to our president, Pietro Belluschi, for speakers and Mr. Belluschi referred the selection to me. Glenn Stanton, past president of the Oregon Chapter of the A.I.A., was chosen to give the first lecture; subject, architecture. Mr. Stanton spoke on the business and contractual relations of the architect, explained how to select an architect and what the functions of the architect are.

The class responded very enthusiastically to Mr. Stanton's talk. As soon as he finished, they asked dozens of questions. Following the class they gathered around to see his blueprints, copies of specifications and contracts.

Other speakers from the Oregon Chapter will include Van Evera Bailey and Herman Brookman. These men will confine themselves to design. They will explain and contrast the traditional and the functional. Later if more speakers are needed, Mr. Belluschi and Mr. Hollis Johnston will conduct class sessions.

We, of the Oregon Chapter, think this Institute is one of the most progressive movements ever started in America. We are backing it 100 per cent and think it highly desirable that A.I.A. Chapters in other states cooperate and support the idea.

Through this plan the architects are given an opportunity to explain how important is their function to groups of people who are definitely planning to build a home after the war.

SUPPORT RED CROSS WAR FUND

The millions of volunteer donors who have visited American Red Cross blood donor centers have helped save the lives of great numbers of our soldiers and sailors. These centers are equipped with up-to-the-minute scientific apparatus, and their operation is financed from Red Cross funds. Readers of this magazine are urged to support the 1944 Red Cross War Fund and thereby help save the lives of the boys at the front. The goal is \$200,000,000 and the campaign starts in March.

MORE HOUSING

The housing situation in San Francisco is still acute and more projects have recently been authorized by the local Housing Authority. The new projects will provide temporary living quarters for 240 families. Construction of a 1000-seat theater at Hunter's Point by the Fox West Coast Theaters has also been authorized at a cost of approximately \$85,000, with an additional \$30,000 for equipment.

OAKLAND HOSPITAL ADDITION

A \$1,000,000 addition to the Kaiser-Permanente Hospital in Oakland is one of the larger 1944 building projects promised. The present hospital, badly overcrowded, was planned by Architects Birge M. and David Clark of Palo Alto who have also prepared drawings for the proposed addition.

SIR EDWIN LUTYENS

Sir Edwin L. Lutyens, famous British architect and president of the Royal Academy since 1938, died at his home in London after a long illness. He was 74 years old. His works included the new British embassy in Washington.

PRINTMAKERS' SHOW

The Northwest Printmakers 16th International Exhibition will hold forth at the Seattle Art Museum March 8 to April 2. Entry cards may be obtained by addressing R. C. Lee, secretary, 534 East 80th, Seattle 5, Washington.

**UNIFICATION PLANS
NEW PUBLICATION
ANNUAL CONVENTION**



In line with the A.I.A.'s unification plans, Detroit Division of the Michigan Society of Architects has automatically been abolished and its membership will hereafter be merged with the Detroit Chapter, A.I.A. Some 88 per cent of the combined membership of the Division and the Institute were Institute members. The merger should strengthen the profession's standing considerably in the Detroit area. It is believed that before long the remaining divisions of the State Society will become Chapters of the Institute.

* * *

The A.I.A.'s official publication, "The Octagon," is no more. Its December number, late in coming out (our copy reached us in the middle of January), was the last issue to carry the name, "The Octagon." In its place is a new publication taking again the name of "Journal of the American Institute of Architects," a pocket-size magazine carrying limited pages of advertising. Henry H. Saylor, A.I.A., veteran editor of many other architectural periodicals, heads the Journal's editorial staff. To provide a voice for the profession will be the aim of the new Journal. (See Page 35 for review.)

* * *

Frederick H. Reimers of San Francisco and Roi L. Morin of Portland, Oregon, are members of the National Unification Committee appointed by President Raymond J. Ashton to work out a program of unification of Society and Association membership, so that Institute membership may become universal for all architects in good standing.

* * *

The Committee on Awards and Scholarships of the A.I.A. has recommended that there be no 1944 awards of the Edward Langley Scholarships, School Medals, Henry Adams Scholarships or the Milton M. Medary Scholarship. The Institute Directors have approved the report and the architectural schools, members, chapters and others concerned are asked to take notice of this announcement.

* * *

The 76th annual meeting of the American Institute of Architects will be held in Indianapolis, Indiana, May 3, 4 and 5. A program will be developed in keeping with the practical needs of the profession.

* * *

The following Pacific Coast architects have been selected to represent this territory upon the A.I.A. committee for collaboration with the Department of

Technical Service: Harry J. Devine, Sacramento; Will G. Corlett, Oakland; Irving G. Smith, Portland, Oregon; William P. Lodge, San Diego; John F. Murphy, Santa Barbara; Earl T. Heitschmidt, Los Angeles; Harry C. Weller, Spokane, and William Aitken, Seattle, Washington.

CHAPTER DINNER MEETINGS

Southern California Chapter, under the aggressive management of its new board of officers, headed by Herbert Powell, president, has inaugurated a unique plan to insure good attendance at all of the Chapter dinner meetings. Tickets are being sold in advance for the remaining monthly dinners this year, at a saving to the purchaser.

SAN FRANCISCO ARCHITECTURAL CLUB

Believing that a draftsman's value increases in direct proportion to his knowledge of materials, the San Francisco Architectural Club will endeavor to bring material manufacturers and draftsmen together in a series of open meetings this year. The next gathering, March 1, at the Builders Exchange, will feature Columbia Steel's movie, "Steel, Man's Servant." The film is narrated by Edwin C. Hill and has a musical background by Robert Armbruster's orchestra. Further comment on the subject will be made by J. R. Gruphill of the Columbia Steel Company.

Those wishing to stay down town for dinner will find the boys at 609 Montgomery Street, at 6:15 p.m. sharp.

A. S. C. E. NOTES

The regular dinner meeting of the San Francisco Section, American Society of Civil Engineers, was held at the Engineers' Club, Tuesday, February 15. The technical program which followed the dinner featured an informative talk by A. M. Rawm, chief engineer of the Los Angeles County Sanitation District, on "The Committee on Employment Conditions."

President-elect Thor Corwin has appointed the following committee chairmen for the current year:

Program and Excursion, R. B. Rothschild, Jr.; Professional Conduct and Objectives, C. G. Hyde; Publicity, J. M. Server, Jr.; Membership and Reception, E. N. Murphy; Sanitation, L. B. Reynolds; Registration, R. L. Allin; Soil Mechanics and Foundations, S. S. Gorman; Legislation, L. H. Nishkian; Juniors, J. G. Wright; Salaries, T. A. Perrott; Building Code, A. W. Earl; Test on Exposition Building Details, H. B. Hammill; Civilian Protection, J. C. Steele; Post-War Construction, H. D. Dewell.

* * *

Past-president I. C. Steele, formerly chief of the Division of Civil Engineering of the Pacific Gas and Electric Co., has been appointed chief engineer of the company, and past-president Walter Dreyer has been promoted to Mr. Steele's former position.

* * *

Newton D. Cook reports that the San Francisco Office of the Engineering Societies Personnel Service registered 679 men (and a few women) in 1943 and

made 225 placements, which leaves some engineers still available.

* * *

Henry J. Brunner has been elected secretary of the Commonwealth Club of California.

* * *

Franklin P. Ulrich left the Section area temporarily on February 1st for Washington, D.C., and an extended trip to South America.

* * *

The 74th meeting of the Junior Forum was held at the Engineers' Club of San Francisco on January 27th, with Norman Riffe presiding.

* * *

J. Henry Baird is now president of the Cal-Vada Construction Co., Reno, Nevada, in charge of a large F.P.H.A. housing project in that city.

* * *

Following up the recommendations of the recent Los Angeles meeting of the Society that committees for advance planning for the post-war period of readjustment be appointed by each Section, the following committee has been appointed:

Chairman: Henry Dewell.

Members: Walter Dreyer, Harold B. Hamill, Walter L. Huber, John S. Longwell, Chas. C. Morris, James H. Turner.

* * *

At the January 14th meeting, the California Student Chapter heard an interesting illustrated discussion on Grand Coulee Dam, presented by Professor J. W. Kelly.

Professors C. T. Wiskocil, H. E. Davis and H. D. Eberhart are not teaching during the November, 1943-March, 1944 semester, the last two being engaged in war research work.

NAMED CONSULTANTS FOR MASTER PLAN

Saارين and Swanson, world-renowned architects and town planners, have been engaged by the New Castle, Indiana, Planning Commission as consultants.

This is the result of action taken by the city council when it authorized and requested the planning commission to make a contract with Saارين and Swanson, of Detroit, to make the master plan which will guide the development of the city in all its phases.

The survey on which the new plan will be based will include studies of disease, crime and other social problems of the community. It will take up the matter of traffic, the inadequacy of parking facilities, the dangerous presence of heavy-traffic on residential streets, the failure to provide through streets on which fast traffic can move.

ARCHITECTS AT CAL. TECH.

The following architects are doing educational work at the California Institute of Technology, Pasadena: Palmer Sabin, Garrett Van Pelt, Donald MacMurray, Fitch Haskell, William Stone and Elmer Grey.

World Trade Center For San Francisco



PROPOSED WORLD TRADE CENTER
William G. Merchant, Architect

Much is being heard in San Francisco regarding the city's projected "World Trade Center."

The plan comprises moving San Francisco's wholesale produce district to a larger and more accessible area. No site for the district has as yet been selected, but several locations south of Market Street have been recommended. The new market will require a minimum of fifteen acres.

The World Trade Center to be located on the site of the wholesale produce district would have as its nucleus the Customs House, the new Appraiser's Building and the Federal Reserve Bank. It would be a Rockefeller Center of World Trade. A number of modern office buildings would be constructed to house the offices and display rooms of manufacturers, exporters and importers.

The World Trade Center forms an integral part of a plan to lift San Francisco's face. It can help materially to provide more than a temporary solution for the problems of the post-war era. The March issue of *Architect and Engineer* will describe the proposed center more fully.

OUR LATIN-AMERICAN CONFRES

The following item from Colombia has been translated for publication in *Architect and Engineer* as of special interest to the alumni of the School of Architecture, University of California at Berkeley, since Jose Gnecco Fallon and Alvaro Hermida are graduates of the school and have many friends in the San Francisco Bay region:

"BOGOTA, Jan. 15 (UP, for El Pueblo)—It is confirmed that next Monday the members of the Bogota delegation, composed of 15 architects, will leave for Medellin to attend the Congress of Architects. Among this group are Jose Gnecco Fallon, Dean of the Faculty of Architecture of the National University; Manuel Robayo, Architect of the Department of Cundinamarca; Gabriel Canchez Grillo, Chief of the City Planning Department, and Secretary of Public Works of Bogota, who will inform the engineers of the elaborate ultimate plans for the beautification of the Capital. Alvaro Hermida and Gabriel Serrano, from the construction firm of Cuellar Serrano Gomez, will also attend the Congress."

THE STATE ASSOCIATION OF CALIFORNIA ARCHITECTS

Northern Section

EDITOR

William C. Ambrose

Address all communications for publication in this department to W. C. Ambrose, 369 Pine Street, San Francisco.

STATE ASSOCIATION

Officers for 1944

President.....John S. Bolles
(Northern Section)
Vice-President.....Robert H. Orr
(Southern Section)
Second Vice-President.....Russell G. deLappe
(Northern Section)
Second Vice-President.....Vincent Palmer
(Southern Section)
Secretary.....Adrian Wilson
(Southern Section)
Assistant Secretary.....Malcolm D. Reynolds
(Northern Section)
Treasurer.....Ralph Wyckoff
(Northern Section)
Assistant Treasurer.....George E. Gable
(Southern Section)

Directors: Henry H. Gutterson, Regional Director, A.I.A.; Frederick H. Reimers, State Board of Architectural Examiners (Northern Section); Winsor Soule, State Board of Architectural Examiners (Southern Section).

Northern Section

President.....John S. Bolles
Vice-President.....Russell G. deLappe
Secretary.....Malcolm D. Reynolds
Treasurer.....Ralph Wyckoff

Directors: Norman K. Blanchard (for two years); Philip S. Buckingham (for two years); Henry H. Gutterson, Regional Director, A.I.A.; Andrew T. Hass, Northern Calif. Chapter, A.I.A.; Vincent G. Raney (one more year); Frederick H. Reimers, State Board of Architectural Examiners; Peter L. Sala, Central Valley Chapter, A.I.A.; Francis Ward (one more year); Alfred C. Williams (one more year).

Southern Section

President.....Robert H. Orr
Vice-President.....Vincent Palmer
Secretary.....Adrian Wilson
Treasurer.....George E. Gable

Directors: Henry H. Gutterson, Regional Director, A.I.A.; E. Keith Lockard, William P. Lodge, Charles O. Matcham, Captain E. Allen Sheet, Winsor Soule, State Board of Architectural Examiners.

BREAKDOWN AND BUILDUP

That a new era is dawning in the relations of the architects to one another was confirmed at the joint meeting in San Francisco of the State Association of California Architects, Northern Section, and the Northern California Chapter, American Institute of Architects, on the evening of the 31st of January. The reason for the joint meeting was to break bread together and listen to what was heralded as a very important message to be delivered by C. Julian Oberwarth, chairman of the Institute committee on membership.

It was an important message delivered with a good natured and impressive sincerity that proved Mr. Oberwarth the ideal ambassador. His mission, briefly, was to give a picture of the possibilities of improvement in the profession by co-operative effort. We had all heard of co-operative effort before, but too often the co-operation which was expected was the "or-else" kind which the private is expected to give to the Colonel. The difference in this case was that Mr. Oberwarth, who is a Director of the Institute, had been sent to the Coast to urge the Institute Chapters to do some co-operating and to invite all reputable members of the profession to membership in the Institute.

The fact is there has long been a feeling among many architects that the Institute considers itself an elite corps, and that its principal activity has been that of basking in its own radiance. Whether the diagnosis has been accurate or not, the feeling has been fostered by an "exclusive" policy in regard to Institute membership, and has retarded the effectiveness of its work.

Mr. Oberwarth brings the message that the Institute directors have concluded that an exclusive policy is not in the best interests of the profession, that the interests of the profession must be paramount, and that the "exclusive" attitude must be replaced by dynamic action by the profession.

The social revolution through which the world is going is terrifying to those who have lost the capacity for a new idea. For those conservatives who are still resilient, it is a challenge to their ability to assume leadership in making the revolution orderly and beneficial. We are glad that the Institute is not confused.

The joint meeting above referred to also reached a high mark in the manner of presentation of ideas. **Improvement** The report of Warren Perry for the Committee on Post-war City and Regional Planning was not only a record of unusual activity on the part of a committee under the leadership of architects, but was a carefully prepared document, read from a manuscript, to be sure, but interesting on account of solid content and intelligent reading.

John Bolles, in his maiden speech before his home folk as President of the State Association, was clear and concise in his language and positive in his manner of stating his convictions.

Mr. Oberworth held the attention of the large assemblage for the better part of an hour with a well organized exposition of his subject. His talk was given rich color by his simple, unaffected sincerity, and lightened by the best kind of American grass-root humor.

The introducers (Ted Spencer and Abe Appleton) deserve applause for introducing the guests and letting the programmed speakers do the speaking. Altogether the meeting was an adult one to which one might have taken a guest without apology.

Dues The new dues schedule of the State Association had not been determined upon when we wrote, a couple of months ago, about why the architects should pay their dues. What we said then still applies. A lot of work has to be done for the benefit of all. If it is not done well, if the investment is not sufficient, then the work is a failure. We have confidence in our officers—we can't let them fail.

A. I. A. Officers Eldridge T. Spencer, was re-elected as President of the Northern California Chapter of the American Institute of Architects at the Chapter meeting held on January 31st at the Engineers Club. Elected to serve with President Spencer for the coming year were:

- Vice-President—E. Geoffrey Bangs;
- Secretary-Treasurer—Andrew T. Hass;
- Directors—Wm. Clement Ambrose (3 years); A. Appleton (2 years); Irwin Johnson (1 year).

The complete Board of Directors for 1944 consists of the above listed newly elected members, and Hervey P. Clark who is serving an unexpired term.

F. EUGENE BARTON

F. Eugene Barton, until commencement of World War II, a practicing architect in San Francisco, died the latter part of January at the home of his sister at Bel Air, Los Angeles, following several months' illness. Mr. Barton for a number of years maintained an office in the Crocker Building in San Francisco, and during that time designed quite a number of fine homes in the Bay area, particularly Piedmont. He was also architect of a string of warehouses for the Bekins Van and Storage Company in San Francisco and Southern California. A native of Salt Lake City, Utah, Mr. Barton is survived by a widow, daughter, a sister, Mrs. Dorothy Bekins of Bel Air, and brother, Claude B. Barton, architect, of Oakland.

OPEN NEW OFFICES

H. L. Gogerty and Associates, architects and engineers, are occupying new offices at 6353 Yucca Street, Hollywood.

Paul R. Williams, architect, has opened new offices for the practice of the profession at 3757 Wilshire Boulevard, Los Angeles.



QUALITY AND DEPENDABLE *Service*

are the factors that influence architects and contractors when selecting lumber and mill work — Quality of merchandise — Integrity and Ability of the firm—Service in physical equipment — Experience and Personnel — All these factors contribute to a speedy and satisfactory completion of construction with minimum of time and expense.

MANUFACTURER OR DEALER IN

Douglas Fir—Redwood—Sugar and Ponderosa Pine — Plywood and Concrete Form Panels — Sash and Doors — Millwork — Insulation — Builders' Hardware.

E. K. WOOD LUMBER CO.

"Goods of the Woods" ©
LOS ANGELES • SAN FRANCISCO • OAKLAND

CORROSION

U. S. REGISTERED TRADE MARK

an acid resisting alloy for

**Pumps • Valves • Chemical
Coatings • Drain Pipe & Fittings**

ARCHITECTS AND ENGINEERS
ENGAGED IN WAR HOUSING
AND POST-WAR PLANNING MAY
CONSULT OUR ENGINEERING
DEPARTMENT WITHOUT
OBLIGATION



PACIFIC FOUNDRY COMPANY LTD.
Engineers and Metallurgists

3100 - 19th Street
SAN FRANCISCO

NEW YORK

SAN FRANCISCO

LOS ANGELES

PRODUCERS' COUNCIL PAGE

Northern California Chapter

The National Organization of Manufacturers of Quality Building Materials and Equipment

Affiliated with the AMERICAN INSTITUTE OF ARCHITECTS



GANO BAKER

Up—up.

Gano R. Baker climaxed years of enthusiastic and faithful service in the Chapter by ably leading the gang in 1942, a year marked by transition of industry to a full war-time basis. Again with the picture before him as an active

Past President, Gano has this past year served as liaison with various planning groups.

Gano first made his appearance in Denver, Colorado, in 1898. A little too young for the Spanish-American War, he almost made the next one, served his country in the SATC. Graduated from University of Colorado BS (EE) in 1920. Gano started right up the trail with Westinghouse, a trail that has led from Pittsburgh, Pa., to San Francisco, where he has spent the last 20 years, more or less. During that time, Gano has identified himself with the civic life of the community. He was a member of the original Board of Directors of the San Francisco Junior Chamber of Commerce, and is an enthusiastic Scouter.

Home is 968 Grosvenor Place, Oakland, where he lives with his wife and two daughters, young ladies of 14 and 16.

As would be expected, his hobbies pertain to outdoor life, camping, fishing and skiing.

Fellowship Again was stressed at the annual meeting of the Northern California Chapter, A.I.A. As emphasized by Mr. C. Julian Oberwarth of Frankfort, Kentucky, chairman of the Institute's Membership Committee and guest speaker on that occasion, "the No. 1 object of the A.I.A. is to promote fellowship between all architects.

Commodity, firmness and delight were listed by Mr. Oberwarth as the three essentials that architects must keep in mind to guide them through all the welter of ideas revolving around post-war planning.

In an aside to the producers, he also pointed out that any company that likewise fails to incorporate

these three essentials in their products, were flirting with economic death.

He Said It . . . Horace Pickett is the first one to try to reduce to words as a statement of policy the guiding thought that all of us Past-Presidents have had in mind in conducting our respective administrations, but which we either couldn't adequately express or else would have taken all meeting to do it.

"To continue to encourage and perpetuate the good will and friendship between architects, engineers and producers of quality building and construction materials to the end that the principals in the industry who are responsible for specifying and using our products may do so with confidence. Also, that we may at all times merit such confidence and relationships rendering them mutually beneficial to the firms we represent and all principals concerned in a building project where our products or services are employed."

Hard working Horace Pickett represents the second member company to be honored with a double shot at the Presidency, being preceded by Fred Scott in that organization.

Precedent breaker was Otis Elevator with Ray Kingsland, Founder-President and himself a precedent breaker (three times). Later came Vic Anderson in 1940, now in Otis' Los Angeles Office.

Chapter Organization is announced by President Horace. But don't forget you're all on one big committee, so don't hold back; he can use your help. And incidentally—you get out of the Council in proportion to what you put in. So let's go, it's your party, too! Here they are:

Membership & Attendance—Chairman, Harry Lemos, P. G. & E.; Norman Brown, Bell & Gossett Company, and Jack Peelle, The Peelle Company and Dahlstrom Metallic Door Company.

Program—Chairman, Nick Nicholas, Crane Co. That's it boys, the human dynamo.

Fellowship—Chairman, Jim Turner, Westinghouse Electric & Manufacturing Co.; Lou Saylor, Vermont Marble Co.; and "Scho" Schofield, Libbey-Owens Glass Company.

Post-War Planning—Chairman, Chuck Kraft, Kraftile Company; Ray Brown, Gladding, McBean & Co., liaison with Technical, Marketing and Finance developments; Dan Anzini, General Electric Co., liaison with

(Turn to Page 46)

USE QUALITY PRODUCTS . . . CONSULT AN ARCHITECT

HOW RED CROSS SERVES MAN IN UNIFORM

By JUSTINE WOODRUFF

Home can wear many fronts—according to taste, available supplies, geographic location, bank balance, an architect's training and skill. For one and all, however, the reigning spirit of home is one of ease and relaxation, and is dependent upon one quality—the desire to make and have a home.

Providing places all over the world where every American service man may relax and be at ease, where he can talk things over and meet his friends, is the achievement of the American Red Cross. To maintain this record, the goal for the 1944 Red Cross War Fund Drive is \$200,000,000. Of the national quota, thirteen per cent will be devoted to activities on the home front; all of the remaining eighty-seven per cent will carry Red Cross services to the man in uniform.



THE RED CROSS CLUB

Sometimes it looks like this . . .



and sometimes like this.

High on the list of these services is "building" him a home away from home. Undertaking to provide a home for 10,000,000 service men is undoubtedly the largest order ever to come across a contractor's desk. It is a particularly difficult order when one member of the firm works in a South Pacific jungle, a second battles desert sands for a site, and still another contends with Alaskan tundra.

A Red Cross club or recreation room is born under widely varying conditions. Sometimes an adequate building is available. Then the problem arises to present the most attractive setting for the service man's off hours. Furniture, in every stage of disrepair, is donated to the Red Cross. Earnest, enthusiastic volunteers, with an eye for line and color, re-upholster and finish the pieces, which are then sent, through the Red Cross Camp and Hospital Council, to embellish sparsely furnished day rooms, sun rooms in hospitals, camp recreation rooms, and clubs.

In other theaters of war, however, easily convertible structures are few and far between—all too often, there are no buildings at all.

The story goes that one seasoned outfit, already familiar with Red Cross services, was transferred—somewhere in the South Pacific. Several of the men were asking for the Red Cross Club. After inquiring without satisfaction among their fellows, one of them tracked down the Red Cross field director.

Busy with the thousand details that always confront a field director, he nevertheless found time to listen to the boys.

"Look, fellows," he said, after hearing their story, "we're going to have a club just as soon as our supplies get here. You know what transportation is now. But don't worry, we'll have a Red Cross building."

"But what are we going to do until the stuff arrives?" asked one lad. "Gee, everywhere we've been, there's always been a Red Cross Club."

Realizing that he was face to face with another of those situations which test a field director's ingenuity, the Red Cross man said, "Well, just a minute, boys, don't lose heart yet. The Red Cross has solved tougher problems than this—and will again. Stick around, and I'll see what can be done."

Approval from the commanding officer was the first step on the program. That obtained, the field director enlisted native and GI assistance. In record time, the men cleared a space of luxuriant but unco-operative jungle vegetation. The site for the Red Cross club was established. And presently, a building rose. With split trunks for joists and studs, bamboo poles for beams, and grass for a roof, this particular Red Cross Club came into being.

Still, there remained the problem of furniture. Wooden crates served as tables and chairs; cardboard boxes, placed one upon the other, acted as book and file cases; more split tree trunks provided not too comfortable benches. And for draperies and extra decorative details, mosquito netting took over for more conventional fabrics.

These members of the armed forces had "found"

(Turn to Page 45)

ARCHITECT AND ENGINEER

Estimator's Guide

Giving Cost of Building Materials, Etc.

AMOUNTS GIVEN ARE FIGURING PRICES AND ARE MADE UP FROM AVERAGE QUOTATIONS FURNISHED BY MATERIAL HOUSES TO SAN FRANCISCO CONTRACTORS. 2½% SALES TAX ON ALL MATERIALS BUT NOT LABOR

All prices and wages quoted are for San Francisco and the Bay District. There may be slight fluctuation of prices in the interior and southern part of the state. Freight cartage, at least, must be added in figuring country work.

BONDS—Performance—50% of contract.
Labor and materials—50% of contract.

BRICKWORK—

Common Brick—Per 1M laid—\$50.00 to \$60.00 (according to class of work).
Face Brick—Per 1M laid—\$120 to \$150 (according to class of work.)
Brick Steps—\$1.60 per lin. ft.
Brick Veneer on Frame Bldg.—Approx. \$1.30 per sq. ft.
Common Brick—\$19.00 per M, truckload lots, f.o.b. job.
\$19.00 per M, less than truckload, plus cartage.
Face Brick—\$40 to \$80 per M, truckload lots, delivered.
Cartage—Approx. \$4.00 per M.

BUILDING PAPER—

1 ply per 1000 ft. roll.....\$3.50
2 ply per 1000 ft. roll..... 5.00
3 ply per 1000 ft. roll..... 6.25
Brownkin, Standard, 500 ft. roll..... 5.00
Sisalkraft, 500 ft. roll..... 5.00
Sash cord com. No. 7.....\$1.20 per 100 ft.
Sash cord com. No. 8..... 1.50 per 100 ft.
Sash cord spot No. 7..... 1.90 per 100 ft.
Sash cord spot No. 8..... 2.25 per 100 ft.
Sash weights, cast iron, \$50.00 ton.
Nails, \$3.42 base.
Sash weights, \$45.00 per ton.

CONCRETE AGGREGATES—

The following prices net to Contractors unless otherwise shown.

Gravel, all sizes—
\$1.95 per ton at Bunker; delivered.....\$2.50

	Bunker	Del'd
Top Sand	\$1.90	\$2.50
Concrete Mix	1.90	2.45
Crushed Rock, ¼" to ¾"	1.90	2.50

Crushed Rock, ¾" to 1½"	1.90	2.50
Roofing Gravel	2.25	2.80
River Sand	2.00	2.45

Sand—

River Sand	2.00	2.45
Lapis (Nos. 2 & 4)	2.85	3.15
Olympia (Nos. 1 & 2)	2.85	3.10
Del Monte White84c per sack	

Cement—

Common (all brands, paper sacks), carload lots, \$2.42 per bbl. f.o.b. car; delivered \$2.72.
Cash discount on carload lots, 10c a bbl., 10th Prov.; less than carload lots \$3.20 per bbl. f.o.b. warehouse or delivered.
Cash discount 2% on L.C.L.

Atlas White	} 1 to 100 sacks, \$2.50 sack warehouse or del.; \$7.65 bbl. carload lots.
Calaveras White	
Medusa White	

Forms, Labors average \$200.00 per M.

Average cost of concrete in place, exclusive of forms, 35c per cu. ft.; \$10 cu. yd.; with forms, 60c.

4-inch concrete basement floor30c per sq. ft.
Ret-proofing7½c
Concrete Steps.....\$1.25 per lin. ft.

DAMP-PROOFING and Waterproofing—

Two-coat work, \$3.50 per square.
Membrane waterproofing—4 layers of saturated felt, \$7.00 per square.
Hot coating work, \$2.50 per square.
Medusa Waterproofing, \$3.50 per lb. San Francisco Warehouse.
Tricocel waterproofing.
(See representative.)

ELECTRIC WIRING—\$12 to \$15 per outlet for conduit work (including switches).

Knob and tube average \$3.00 per outlet. (Available only for priority work.)

ELEVATORS—

Prices vary according to capacity, speed and type. Consult elevator companies. Average cost of installing a slow speed automatic passenger elevator in small four story apartment building, including entrance doors, about \$6500.00.

EXCAVATION—

Send, 60 cents; clay or shale \$1 per yard. Teams, \$12.00 per day.

Trucks, \$22 to \$27.50 per day.

Above figures are an average without water. Steam shovel work in large quantities, less; hard material, such as rock, will run considerably more.

FIRE ESCAPES—

Ten-foot galvanized iron balcony, with stairs, \$150 installed on new buildings; \$160 on old buildings.

FLOORS—

Composition Floor, such as Magnesite, 33c to 50c per square.
Linoflor—2 gages—\$1.25 to \$2.75 per sq. yd.
Mastapay—90c to \$1.50 per sq. yd.
Battleship Linoleum—available to Army and Navy only—⅞"—\$1.75 sq. yd.
⅝"—\$2.00 sq. yd.
Terrazo Floors—50c to 70c per square.
Terrazo Steps—\$1.75 per lin. ft.
Mastic Wear Coat—according to type—20c to 35c.

Hardwood Flooring—

Standard Mill grades not available.
Victory Oak—T & G
⅝" x 2¼".....\$143.25 per M. plus Cartage
⅞" x 2"..... 122.00 per M. plus Cartage
½" x 1½"..... 113.50 per M. plus Cartage
Pretinished Standard & Better Oak Flooring
⅝" x 3¼".....\$180.00 per M. plus Cartage
½" x 2½"..... 160.50 per M. plus Cartage
Maple Flooring
⅝" T & G Clear \$160.50 per M. plus Ctg.
2nd 153.50 per M. plus Ctg.
3rd 131.25 per M. plus Ctg.
Floor Layers' Wage, \$1.50 per hr.

GLASS—

Single Strength Window Glass	20c per	□ ft.
Double Strength Window Glass	30c per	□ ft.
Plate Glass, under 75 sq. ft.	\$1.00 per	□ ft.
Polished Wire Plate Glass	1.40 per	□ ft.
Rgh. Wire Glass	.34 per	□ ft.
Obscure Glass	.27 per	□ ft.
Glazing of above is additional.		
Glass Blocks	\$2.50 per	□ ft. set in place

HEATING—

Average, \$1.90 per sq. ft. of radiation, according to conditions.
Warm air (gravity) average \$48 per register.
Forced air, average \$68 per register.

IRON—Cost of ornamental iron, cast iron, etc., depends on designs.

LUMBER—All lumber at O.P.A. ceiling prices—

No. 1 Common	\$49.00 per M
No. 2 Common	47.75 per M
Select O. P. Common	52.75 per M

Flooring—

V.G.-D.F. 8 & Btr. 1 x 4 T & G Flooring	Delvd. \$80.00
C 1 x 4 T & G Flooring	75.00
D 1 x 4 T & G Flooring	65.00
D.F.-S.G. 8 & Btr. 1 x 4 T & G Flooring	61.00
C 1 x 4 T & G Flooring	59.00
D 1 x 4 T & G Flooring	54.00
Rwd. Plastic—"A" grade, medium dry	82.00
"B" grade, medium dry	78.50

Plywood—

	Under \$200	Over \$200
"Plyscord"— $\frac{3}{8}$ "	\$49.50	\$47.55
"Plywall"— $\frac{1}{4}$ "	45.15	43.30
3 ply— $\frac{2}{8}$ — $\frac{1}{4}$ "	48.55	46.60
"Plyform"— $\frac{5}{8}$ "—		
Uncoiled	126.50	121.45
Oiled	127.90	122.75

Above prices delivered if quantity is sufficient to warrant delivery.

Shingles (Rwd. not available)—

Red Cedar No. 1—\$6.75 per square; No. 2, \$5.75; No. 3, \$4.45.
 Average cost to lay shingles, $\frac{3}{8}$ " per square.
 Cedar Shakes—Tapered: $\frac{1}{2}$ " x $\frac{3}{4}$ " x 25"—\$8.95 per square.
 Resawn: $\frac{3}{4}$ " to $1\frac{1}{4}$ " x 25"—\$10.65 per square.
 Resawn: $\frac{3}{4}$ " to $1\frac{1}{4}$ " x 25"—\$10.65 per square.
 Average cost to lay shakes, \$4.00 per square.

MILLWORK—Standard.

O. P. \$100 per 1000. R. W. rustic \$100.00 per 1000 (delivered).
 Double hung box window frames, average with trim \$6.50 end up, each.
 Complete door unit, \$10.00.
 Screen doors, \$3.50 each.
 Patent screen windows, 25c a sq. ft.
 Cases for kitchen pantries seven ft. high, per lineal ft., \$9.00 each.
 Dining room cases, \$9.00 per lineal foot.
 Rough and finish about 80c per sq. ft.
 Labor—Rough carpentry, warehouse heavy framing (average), \$40.00 per M.
 For smaller work average, \$40.00 to \$55.00 per 1000.

MARBLE—See Dealers

PAINTING—

Two-coat work	per yard 50c
Three-coat work	per yard 70c
Cold water painting	per yard 10c
Whitewashing	per yard 8c

PAINTS—

Two-coat work 50c per sq. yd.
 Three-coat work 70c per sq. yd.
 Cold water painting per yard 10c
 Whitewashing 8c per sq. yd.
 Turpentine \$1.03 per gal. in drum lots.
 \$1.08 per gal. in 5-gal. containers.
 Raw Linseed Oil—not available.

Boiled Linseed Oil—\$1.38 per gal. in drums. Available only to work with high priority—\$1.48 per gal. in 5-gal. containers.

Use replacement oil—\$1.86 per gal. in 1-gal. containers.

Replacement Oil—\$1.20 per gal. in drums. \$1.30 per gal. in 5-gal. containers.
 A deposit of \$6.00 required on all drums.

PATENT CHIMNEYS—

6-inch	\$1.20 lineal foot
8-inch	1.40 lineal foot
10-inch	2.15 lineal foot
12-inch	2.75 lineal foot

PLASTER—

Neat wall, per ton delivered in S. F. in paper bags, \$17.60.

PLASTERING (Interior)—

3 Coats, metal lath and plaster	1.50
Keene cement on metal lath	1.80
Ceilings with $\frac{3}{4}$ hot roll channels metal lath (lathed only)	1.20
Ceilings with $\frac{3}{4}$ hot roll channels metal lath plastered	2.20
Single partition $\frac{3}{4}$ channel lath 1 side (lath only)	1.20
Single partition $\frac{3}{4}$ channel lath 2 inches thick plastered	3.20
4-inch double partition $\frac{3}{4}$ channel lath 2 sides (lath only)	2.20
4-inch double partition $\frac{3}{4}$ channel lath 2 sides plastered	3.85
Thermax single partition; 1" channels; $\frac{2}{4}$ " overall partition width. Plastered both sides	3.30
Thermax double partition; 1" channels; $\frac{4}{4}$ " overall partition width. Plastered both sides	4.40
3 coats over 1" Thermax nailed to one side wood studs or joists	1.65
3 coats over 1" Thermax suspended to one side wood studs with spring sound isolation clip	1.90
Note—Channel lath controlled by limitation orders.	

PLASTERING (Exterior)—

2 coats cement finish, brick or concrete wall	per yard \$1.00
3 coats cement finish, No. 18 gauge wire mesh	2.00
Lime—\$3.00 per bbl. at yard.	
Processed Lime—\$3.10 bbl. at yard.	
Rock or Grip Lath— $\frac{3}{8}$ "—20c per sq. yd.	
$\frac{1}{2}$ "—19c per sq. yd.	

Composition Stucco—\$1.80 to \$2.00 sq. yard (applied).

PLUMBING—

From \$100.00 per fixture up, according to grade, quantity and runs.

ROOFING—

"Standard" tar and gravel, 4 ply—\$8.00 per sq. for 30 sqs. or over.
 Less than 30 sqs., \$9.50 per sq.
 Tile, \$30.00 to \$40.00 per square.
 Redwood Shingles, \$7.50 per square in place.
 5/2 # 1-16" Cedar Shingles, 4/2" Exposure \$8.00 square

5/8 x 16"—# 1 Cedar Shingles, 5" Exposure \$9.00 square
 4/2 # 1-24" Royal Shingles, 7/2" Exposure \$9.50 square
 Re-coat with Gravel \$4.00 per sq.
 Asbestos Shingles, \$23 to \$28 per sq. laid.
 1/2 x 25" Resawn Cedar Shakes, 10" Exposure \$10.50
 3/4 x 25" Resawn Cedar Shakes, 10" Exposure 11.50
 1 x 25" Resawn Cedar Shakes, 10" Exposure 12.50
 Above prices are for shakes in place.

SHEET METAL—

Windows—Metal, \$1.75 a sq. ft.
 Fire doors (average), including hardware, \$2.00 per sq. ft.

SKYLIGHTS—(not glazed)

Copper, 90c sq. ft. (flat).
 Galvanized iron, 40c sq. ft. (flat).
 Vented hip skylights 60c sq. ft.

STEEL—STRUCTURAL (None available except for defense work).

\$150 ton (erected), this quotation is an average for comparatively small quantities. Light truss work higher. Plain beams and column work in large quantities \$140 per ton.

STEEL REINFORCING (None available except for war work).

\$150 to \$200 ton, set.

STONE—

Granite, average, \$6.50 cu. foot in place.
 Sandstone, average Blue, \$4.00. Boise, \$3.00 sq. ft. in place.
 Indiana Limestone, \$2.80 per sq. ft. in place.

STORE FRONTS (None available).

TILE—

Ceramic Tile Floors—70c to \$1.00 per sq. ft.
 Cove Base—\$1.10 per lin. ft.
 Glazed Tile Wainscot—\$1.25 per sq. ft.
 Asphalt Tile Floor $\frac{1}{8}$ " & $\frac{3}{8}$ "—\$.18 to \$.35 per sq. ft. Light shades slightly higher.
 Cork Tile—\$.40 to \$.75 per sq. ft.
 Mosaic Floors—see dealers.
 Lino-Tile, \$.35 to \$.75 per sq. ft.

Wall Tile—

Glazed Terra Cotta Wall Units (single faced) laid in place—approximate prices:
 2 x 6 x 12 \$1.10 sq. ft.
 4 x 6 x 12 1.25 sq. ft.
 2 x 8 x 16 1.20 sq. ft.
 4 x 8 x 16 1.40 sq. ft.

VENETIAN BLINDS—

40c per square foot and up. Installation extra.

WINDOWS—STEEL—

30c per square foot, \$5 for ventilators.

RED CROSS SERVICE

(Concluded from Page 42)

their Red Cross club. If purpose could erect a building out of tree trunks, bamboo, grass, and mosquito netting, that same purpose could make it a place of good fellowship, where the order of the day is "at ease," a home away from home. "Call it what you like," remarked one lanky soldier stretched out on a tree trunk—turned bench, "'pre-primitive orange crate period"—still, it's got what it takes."

CONSTRUCTION FORECAST 1944

(By Market Analysis Committee, Producers' Council)

Estimate of the cost of new construction during 1943, and in 1944, based on the assumption: (I) that there will be no post-German armistice construction during 1944, and (II) that post-German armistice construction will occur after July 1, 1944.

Type	Total	1943			1944	
		No Armistice Basis		Total	Armistice Basis (c)	
		1st Half	2nd Half		2nd Half	Total
Private Construction						
Residential	792	225	175	400	400	625
Industrial	126	30	20	50	120	150
Farm	125	65	80	145	120	185
Public Utility	485	170	170	340	300	470
All Other	65	30	30	60	100	130
Total Private	1,593	520	475	995	1,040	1,560
Public Construction						
Residential	800	240	220	460	175	415
Industrial	2,150	388	332	720	302	690
Military & Naval (Continental U. S.)	2,860	710	595	1,305	460	1,170
Highways	400	180	205	385	350	530
Other Pub. Const.	215	80	80	160	120	200
Total Public	6,425	1,598	1,432	3,030	1,407	3,005
Total Construction (b)	8,018	2,118	1,907	4,025	2,447	4,565

Notes: (a) The statistics given in the table represent an extension of the new construction series compiled by the Department of Commerce and reported in the Survey of Current Business.

(b) Does not include maintenance and repairs.

(c) In developing the estimate Total II it was assumed that a German armistice would have occurred prior to July 1st, and that a rise in construction would be possible after that date. This estimate has been made for the sole purpose of indicating how much of a rise in construction might be expected after a German armistice occurring at the time indicated. It was assumed that the war with Japan would be continued.

NEW BRITISH BUILDING CODE

The first draft standard under the British Building Codes and Practices program is now being circulated by the British Standards Institution before consideration for final approval. It recommends the minimum loads which should be taken into account in the designs of buildings, for use with working stresses based on the properties of the various materials. No account has been taken, however, of constructional loads. One section of the proposed standard makes recommendations for dead and superimposed loads and forces induced by wind, and is for conditions that are normal for Great Britain. The effect on buildings of enemy action in time of war is considered in the second section, and buildings are classified in terms of their resistance to such action.

HOGAN LUMBER CO.

Wholesale and Retail

LUMBER

MILL WORK • SASH & DOORS

Office, Mill, Yard and Docks

SECOND AND ALICE STREETS • OAKLAND, CALIF.

Telephone GLencourt 6861

CLINTON CONSTRUCTION CO. OF CALIFORNIA

General Contractors

923 FOLSOM STREET • SAN FRANCISCO

SUtter 3440

FORDERER CORNICE WORKS

Manufacturers of

Hollow Metal Products • Interior Metal Trim

Elevator Fronts and Cabs

Metal Plaster Accessories • Sanitary Metal Base

Flat and Roll Metal Screens

Metal Cabinets • Commercial Refrigerators

269 POTRERO AVE.

SAN FRANCISCO, CALIF.

HEMLOCK 4100

STRUCTURAL STEEL

For Class A Buildings,
Bridges, etc.

JUDSON PACIFIC CO.

1200 SEVENTEENTH STREET
SAN FRANCISCO

Plants: San Francisco - Oakland

**The Most Complete Line of
STEELS and BUILDING MATERIALS
Made by a Single Producer**



See Sweet's Catalog File or write us for full information.

REPUBLIC STEEL CORPORATION
GENERAL OFFICES: CLEVELAND, OHIO

DENVER, COLORADO CONTINENTAL OIL BUILDING
LOS ANGELES, CALIFORNIA EDISON BUILDING
SALT LAKE CITY, UTAH WALKER BANK BUILDING
SAN FRANCISCO, CALIFORNIA RIALTO BUILDING
SEATTLE, WASH. WHITE-HENRY-STUART BUILDING

**PACIFIC
MANUFACTURING CO.**

HIGH CLASS INTERIOR FINISH
QUALITY MILLWORK

142 SANSOME ST., SAN FRANCISCO
GArfield 7755

6820 MCKINLEY AVE., LOS ANGELES
THornwall 4196

BUILDERS EXCHANGE, OAKLAND

**"AMERICAN MARSH"
Redi-Vac Vacuum Heating Pump**



Send for
Bulletin 441

SIMONDS MACHINERY CO.

San Francisco
816 Folsom St.

Los Angeles
455 East Fourth St.

**VERMONT
MARBLE COMPANY**

Producers and Finishers
of
Domestic and Imported Marbles

Write for new pamphlet describing our
Marble Tablets and Showers

San Francisco and Los Angeles
San Francisco phone: SUtter 6747



PRODUCERS' COUNCIL

(Concluded from Page 41)

Industrial, Consumer and Governmental Relationship phases.

Some comment in passing might be of interest on our Post-War Planning set-up. Your Executive Committee feels that the subject offers a very effective public relations approach. Post-War Planning has advanced to the stage where we have a double duty—to keep the public informed on what we are doing about it.

Building Industry Conference Board representative is Past President '39, Ken Pinney, Armstrong Cork Company, alternate is Ture Tulein, Johns-Manville Sales Corporation.

AND This is a good place to remind you to encourage your prospects to . . .

Interesting programs are in prospect with a continuation of the interesting member talks of past years interspersed by talks from representatives of other organizations with whom we maintain liaison, relative to the set-up and workings of their groups.

D. H. BURNHAM'S SON KILLED

Lieutenant Spencer Otis Burnham, son of Daniel H. Burnham, was killed while on maneuvers near Scottsville, when a car in which he was riding overturned.



SISALKRAFT

REG. U. S. PAT. OFF.

"More than a building paper"

THE SISALKRAFT CO.

205 West Wacker Drive
Chicago, Ill.

55 New Montgomery Street
San Francisco, Calif.

BASALITE

CAMBERED SHINGLE TILE

PERMANENT • FIREPROOF • STORM-SAFE • COLORFUL • ECONOMICAL

Manufactured by
BASALT ROCK CO., INC.
NAPA, CALIFORNIA

N. CLARK AND SONS

Manufacturers of
Quality
Architectural
Clay Products

During this stage of the war, our principal energy is to manufacture products required by the various war agencies. We still can supply some pre-war materials for civilian needs.



401 PACIFIC AVENUE
ALAMEDA, CALIFORNIA

San Francisco • Los Angeles
Salt Lake City • Portland

LIGHTING CALIFORNIA SCHOOLS

Of interest to architects, as well as educators, is a new 19-page illustrated bulletin, entitled "Recommended Practices for Lighting California Schools," recently issued by the California State Department of Education, Division of Schoolhouse Planning.

It was prepared by the research committee of Sight Conservation Council of Northern California, consisting of Dr. R. S. French, president of the Council and principal of California State School for the Blind, Berkeley; Dr. Charles Bursch, chief, Division of Schoolhouse Planning, State Department of Education, Sacramento; Dr. Leland H. Brown, associate professor of electrical engineering, Stanford University; John Lyon Reid, associate architect, Ernest J. Kump Company, San Francisco; and Clark Baker, executive secretary, Sight Conservation Council of Northern California, and lighting counselor, Northern California Electrical Bureau, San Francisco.

Broad in scope, the bulletin includes comprehensive discussions of such subjects as the severity of the seeing tasks in the classroom; sustaining the efficiency of the eye to see during classroom hours; the quantity of the light; desired levels of illumination for the several parts of the school plant, such as class and library rooms, auditoriums, corridors and stairways, laboratories, sewing, drafting and art rooms, etc.; object brightness and surround brightness and its close relation to the subject of glare, which is more or less a sensation of discomfort resulting from over-brightness in the two fields of seeing; evenness of illumination throughout the classroom, which discusses clearly orientation of windows for natural light and installation of artificial lighting equipment; classroom furniture and seating arrangements are effectively discussed; a goodly part of the bulletin is devoted to maintenance, with one or two concrete examples of losses of light which in reality are losses in the ability of the class student to perform his seeing tasks effectively and efficiently.

USE
Mailway Banking

FOR BUSINESS AND PERSONAL ACCOUNTS

Merchants, professional people, office workers . . . all types find our Mailway service the most convenient way of banking. They make deposits any time, night or day, Sundays or holidays. Our special Mailway envelopes and passbook assure quick and safe service.

Open a Mailway account by mail

CROCKER FIRST NATIONAL BANK
OF SAN FRANCISCO
California's Largest National Bank

Member Federal Deposit Insurance Corporation
ONE MONTGOMERY STREET

ABBOT A. HANKS, INC. Engineers & Chemists

INSPECTING — TESTING — CONSULTING
CONCRETE — STEEL — MATERIALS
CHEMICAL AND TESTING
LABORATORIES
• RESEARCH AND INVESTIGATION •

TESTS OF STRUCTURAL MATERIALS
DESIGN OF CONCRETE MIXES
SHOP AND ERECTION INSPECTION OF
STRUCTURES AND EQUIPMENT
INVESTIGATION OF STRUCTURES
AND MATERIALS
TESTS AND INVESTIGATION OF
FOUNDATION SOILS
FIRE RESISTANCE AND INSULATION
TESTS

624 Sacramento Street, San Francisco

Robert W. Hunt Company ENGINEERS

Inspection • Tests • Consultation
Schools and Other Structures
Are Built as Designed

*When Construction Materials are
Inspected at point of Manufacture
and during Erection by*

ROBERT W. HUNT COMPANY

*Cement, Concrete, Chemical, Metallurgical,
X-Ray and Physical Laboratories*

Chicago • New York • Pittsburgh
Los Angeles • All Large Cities
San Francisco, 251 Kearny Street

Independent Iron Works

Structural Steel
Ornamental Iron
Steel Service Stations
Steel Tanks
Standard Steel Mill Buildings
Bridges

821 Pine Street Oakland

A L A D D I N Heating Corp.

Specializing in
QUALITY HEATING
EQUIPMENT

2222 San Pablo Avenue

OAKLAND

TWinoaks 1022

MULLEN MFG. COMPANY

BANK, STORE AND OFFICE
FIXTURES—CABINET WORK
OF GUARANTEED QUALITY
CHURCH SEATING

Office and Factory:
40-60 RAUSCH ST., Bet. 7th and 8th Sts.
San Francisco
Telephone UNderhill 5815

THE TORMEY COMPANY

GENERAL PAINTERS
AND DECORATORS

Phone UNderhill 1913

563 FULTON STREET
San Francisco

G. P. W. JENSEN & SON

Building Construction

320 Market Street, San Francisco
Phone: GARfield 2444

JOHN CASSARETTO

—Since 1886—And Still Active—

Building Materials

READY MIX CONCRETE
ROCK - SAND - GRAVEL - LIME
CEMENT - PLASTER - MORTAR
METAL LATH - WOOD LATH
STUCCO - WIRE NETTING

Service Unexcelled

Bunkers
Sixth and Channel, San Francisco
Phones: GARfield 3176, GARfield 3177

INDUSTRY'S POST-WAR OBLIGATION

After pointing out the ability of American industry to meet all expected demands, Clyde G. Conley, president of the American Institute of Steel Construction, said: "As I believe it is the obligation of industry to think and plan now in terms of meeting both this domestic and foreign demand, I believe that it is the obligation of Government to recognize the compatibility between its own humanitarian aims and our desire to make the fullest use of our resources and abilities. To a certain extent the leaders of democracy have articulated what they feel to be the needs of the future. Industry can meet these needs. For this reason I think it is clear that excessive taxation and other handicapping legislation which would hamper and put obstacles into the way of this development, are not in accordance with this program."

BANKERS TO URGE THRIFT

"The banks of the country are working on a plan to induce millions of Americans who are now saving regularly for the purchase of war bonds, to continue the same schedule of thrift when peace comes," according to Glenn Griswold of the Griswold News Service, 299 Madison Avenue, New York.

"The idea is to continue without interruption the program of payroll deductions, the proceeds to be used for the creation of life estates under the guidance of the individual banks in which savers have their accounts," Mr. Griswold revealed. "Despite low interest rates prevailing today, leading bankers feel that the government is now taking over the job of creating a real sense of thrift in America on which banks have spent millions without too much success in the past. When interest rates return to normal, a tremendous volume of business will be made to order for them."

A. F. MATTOCK CO. Builders

212 CLARA STREET
SAN FRANCISCO

DINWIDDIE CONSTRUCTION COMPANY BUILDERS

CROCKER BUILDING
SAN FRANCISCO



HERRICK IRON WORKS

STRUCTURAL STEEL
REINFORCING STEEL

16TH AND CAMPBELL STS.
OAKLAND, CALIF.
Phone GLencourt 1747

Phone GARfield 1164

Thomas B. Hunter

Consulting Engineer

DESIGNER OF HEATING
AIR CONDITIONING
VENTILATING AND WIRING
SYSTEMS, MECHANICAL
AND ELECTRICAL EQUIP-
MENT OF BUILDINGS

41 SUTTER STREET
ROOM 710
San Francisco California

ANDERSON & RINGROSE

General Contractors

320 Market Street, San Francisco
Phone GARfield 2245

ARCHITECT AND ENGINEER



Your RED CROSS is at his s

MARCH, 194





Congratulations

ON A FINE JOB, WELL DONE!

THE Treasury "Star" Flag—the bond-buying counterpart of the Army-Navy "E"—marks plants with at least 90% of personnel participating in the Payroll Savings Plan to at least 10% of gross payroll, and also having reached, or topped, a War Loan Drive quota!

The successful close of the 4th War Loan Drive finds many more "Star" Flags than ever before flying over the industrial plants of America. To all these, go the heartiest thanks of the nation, and the deep appreciation of the Treasury Department for a great job! And to those who may not quite have qualified for the "Star," go equally sincere thanks—and the confidence that soon they, too, will join the ranks of the "Star" fliers.

One thought that many concerns have

found helpful in stepping up the intake from their Payroll Savings Plans is this. In many cases the Treasury Representative in a plant has been able to point out the fact that during *Loan Drive* periods the employees have found it possible to spare much more than they had counted on when setting up their original subscription, and that—when properly approached—a very substantial fraction of such employees will decide they can well afford a distinct increase in their current Payroll Savings Plan.

Talk this over with your Treasury Representative—it offers important possibilities when correctly handled. And again accept the Treasury Department's congratulations for your fine work in helping to put over the 4th War Loan.

The Treasury Department acknowledges with appreciation the publication of this message by

**LET'S ALL KEEP
BACKING THE ATTACK
WITH WAR BONDS**

ARCHITECT AND ENGINEER

ARCHITECT AND ENGINEER

Volume 156 No. 3

FRED W. JONES
Editor

MARK DANIELS
Associate Editor

L. H. NISHKIAN
Consulting Editor

MICHAEL GOODMAN
Post-War Planning

E. N. KIERULFF*
Ass't Editor
*In the Service

MARCH CONTENTS

COVER: Administration Building for Kaiser Co., Inc., Fontana, California
Birge M. and David B. Clark, Architects

PHOTOGRAPHY:

Waters & Hainlin Studios: St. Margaret's Church and Residence of Stuart Hawley, Piedmont

Murray Knowlton: Kaiser Co. Buildings, Fontana, California

ARTICLES:

- Running Fire** 3
Mark Daniels, Architect
- News and Comment on Art** 4-5
- Design of Pre-War Church Has Post-War Possibilities** 14
- Kaiser Builds Steel Plant and New Hospital** 18
- New Ideas Should Not Be Discounted in Future Building Plans** 20
Bror Dahlberg
- Rebuilding Devastated Areas of Soviet Union** 23
- Russian Art Treasures Destroyed by Nazis** 28
Dorothy Newman
- Post-War Heating and Air-Conditioning** 31
Samuel R. Lewis, M. E.
- Structural Steel Standard** 33

ILLUSTRATIONS:

- St. Margaret's Church, Oakland** 14-16
Wm. E. Schirmer, Architect
- House for Mr. and Mrs. Stuart Hawley** 17
Wm. E. Schirmer, Architect
- Architect's Sketch of Proposed Additions to Permanente Hospital, Oakland** 18
Birge M. and David B. Clark, Architects
- Buildings for Kaiser Co., Inc., Fontana, California**
Birge M. and David B. Clark, Architects
- Russian Architecture** 22-29

NEXT MONTH

AN Eastern architect who has designed a number of fine homes in New York State has come to California to live. Although he has been here less than three months, despite transportation difficulties, he has been around. Architect and Engineer has asked for his impressions of what he has seen thus far of California domestic architecture. You will be interested in reading his observations which are both flattering and condemning. For example:

The newcomer is keenly aware of the cleanness of California towns.

Laguna Beach in normal times has more smart architects per square inch than any place in the West.

Los Angeles is too much of an octopus city.

Santa Barbara is intriguing . . . its court house is the epitome of the city's architecture.

Monterey and Carmel are spotty with a surprising amount of work that seems mediocre.

The East Bay, beyond the tunnel, offers some unique homes. There are houses in Orinda, Lafayette and Walnut Creek that appear to have been designed by "architects with ideas."

ARCHITECT AND ENGINEER (Established 1905) is published on the 15th of the month by The Architect and Engineer, Inc., 68 Post Street, San Francisco. President, K. P. Kierulff; Vice-President, Fred'k W. Jones; Secretary-Treasurer and Business Manager, L. B. Penhorwood; Advertising Manager, V. E. Atkinson, Jr.

Los Angeles Office: 403 W. 8th Street, Robert W. Walker, Manager.

Entered as second class matter, November 2, 1905, at the Post Office in San Francisco, California, under the Act of March 3, 1879. Subscriptions, United States and Pan America, \$3.00 a year; \$5.00 two years; foreign countries \$5.00 a year; single copy 50c. ARCHITECTS' REPORTS are published daily from this office, Vernon S. Yellop, Mgr.

THE DOCTOR'S RESPONSIBILITY
CONTINUES AFTER HE PERFORMS
A SUCCESSFUL OPERATION.



THE ARCHITECT'S, THE BUILDER'S
RESPONSIBILITY GOES BEYOND
DESIGN AND CONSTRUCTION.



**BOTH
MUST THINK AHEAD—**

THE surgeon's goal is *lasting* recovery. The architect's and builder's goal is *permanent* liveability. So many thousands of home owners are happy with their gas heating, cooking, hot water service and refrigeration, who can doubt that the most popular post-war specification will be "All Gas"? ☆ *Meanwhile, War Bonds!*

THE PACIFIC COAST GAS ASSOCIATION

GAS FUEL

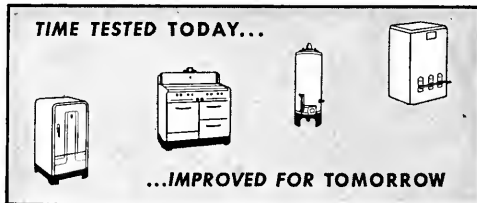

☆ SERVING THE WEST IN WAR AND PEACE

RUNNING FIRE — by MARK DANIELS

• FRANK C. WALKER, *ESQUIRE*?

That would hardly be the way to address Mr. Walker these days, would it? If such a grouping of words were to be found in the mails it might create the impression that Mr. Walker had struck a compromise with "ESQUIRE," which would appear about as logical as Mr. Walker's ruling out that magazine from second class postage. But absurd and silly as is Mr. Walker's action in the ruling against "ESQUIRE" there is encouragement in it for some. If he can make it stick he may be persuaded to rule out from second class mail all but one in each class of publications. What an honor it would be to contribute to the only journal of its class in Americal (ARCHITECT AND ENGINEER manfully refrains from raising subscription rates.)

• EXTREMES

The top sergeant had been trying for several days to report to the colonel the amounts of priorities that had been preliminarily approved in the technical office. Finally he cornered him in the cafeteria.

"That eight million order for cement; is it O.K.?" he asked.

The colonel grunted.

"How about the three million dollars on steel I-beams?"

"O.K.," said the colonel.

"And the three hundred and fifty thousand dollars of one-inch W.I. pipe?"

"Oh, don't bother me with items under a million," the colonel said, impatiently.

"Well, I hate to do it," said the sergeant, slowly. "But can you lend me fifty cents to buy my lunch with?"

I had already ordered an extra piece of pie.

• THE ARCHITECTURAL CART

Too many architects are getting the cart before the horse. Not that that may not be a good idea, sometimes, depending upon the horse, but they ask themselves, "How can I design a house so that I will use all the new materials, gadgets and wrinkles that are coming out?" It would be the better method to determine what the problems are and then decide whether new devices would best serve the purpose. A sleeping porch would be more useful than radiant heat in every room in the tropics, and I fear that refrigerators will not be at a premium at the north pole.

• ANOTHER LATE CLOSING

For the small sum of twenty cents sent to the Superintendent of Documents in Washington anyone may get a copy of the export control bulletin that will tell what may be exported. The last one published is particularly interesting and encouraging, for it adds a very long list of edibles and other commodities that now may not be exported in quantities valued at more than one dollar, except to the armed forces or under special license. Without the aid of a slide rule it can be figured that most of these are on our lists of rationed goods.

The exportation of such goods as edible fats, dried fruits and processed meats to our allies and armed forces is a necessity, but why we should have been doing it for Mexico, Central and South American countries for so long while the O.P.A. continued to boost the cost of our home supplies, has been a puzzle to many of us. But much of that has been stopped—the door is closed. It remains to be seen whether the horse is gone.

• HOW ABOUT BOOKS?

If modernism makes a clean sweep of it, if styles of architecture of the past are done away with, if period furniture is abandoned, if ornament becomes purely functional, and if the house does become just "a machine for living," what will become of those beautiful books such as Pugin's Gothic, Anthony's Mosaics, Foley's "Period Furniture," Macquoid's & Edwards' beautiful three volumes on English Furniture, and the hundreds of other works that go to make up an architect's reference library? Of course, monuments to the past will probably be built now and then and museums may be erected to show what fools the world has tolerated for the past several thousand years, but the publishers will be put to it to get out an entirely new reference library. Histories of architecture, such as Banister Fletcher's and F. M. Simpson's, will go by the boards; Church Woodwork and Church Symbolism may appear occasionally in a large public library and the works of great architects of the past hundred years may be found on the shelves of friends or descendants of those men; but I fear that Nick Carter is on his way back.

• THE LITTLE MAN

The Little Man elbowed his way through the small throng that cluttered the bar. He was quite disheveled as he absent-mindedly tossed off my old fashion before I could order one for him.

"War is very trying," he said as he helped himself to my olives. "Before you know it we are using the jargon of the press in every-day conversation. I just told my friend there (he pointed to a tattered specimen who stood teetering from heel to toe at the doorway), why I was late. I told him that I launched into Geary Street, followed a fat woman who spearheaded through the mob, pincered an opening at the corner, annihilated two beers at Sam's and slaughtered a newsboy who blocked my way. Now I shall dig in," he finished and he did, with gusto and my knife and fork.

• NOT ON THE RACE

I can understand the feeling of a soldier at the front who is trying to write a letter home just before he goes over the top. His mind certainly cannot be on descriptions of the scenery or the opera he saw in London on the way over. Just how to write something that might be of interest to a bunch of architects when the papers are full of raids in the south seas, the advance of the Russians in Poland, the critical position of American troops in Italy

(Please turn to Page 6)

NEWS AND COMMENT ON ART

NEWS NOTES FROM THE PORTLAND ART MUSEUM

The major exhibition this month presents the Art of the Indians of the Pacific Coast who comprise a multitude of tribes representing many groups and cultures: the Eskimos of the far north, the hunting and fishing people of the west Canadian coast, the mixed cultures of Oregon and Washington, and the basketmakers of northern California. Since each of these groups has its characteristic expression, essentially based on its way of living, and expressed through the available and indigenous material, the exhibition has great variety, both in objects and spirit. . . .

Almost everything shown was made for the use of the people in their daily life, or for their winter ceremonies and dances. But the objects in the exhibition have been carefully selected from many hundreds of similar types so that the show might truly be an exhibition of art. There are exquisite bone carvings from the Eskimos, as well as some of their fantastic and delicate masks; fine slate and wood sculptures from the Northwest coast people, as well as the masks, horn spoons, pipes, rattles and blankets used in their ceremonies; baskets of fine craftsmanship, and those remarkable stone sculptures from the Columbia



De Young Memorial Museum
SILVER TANKARD, made in 1790-1791 by Charles Aldridge
It is part of the Albert Campbell Hooper Collection.



OIL: CLAUDINA VAN GROENENDIJK

By Paulus Moreelse (1571-1638)

This is one of the newest additions to the Museum of the California Palace of the Legion of Honor, San Francisco. The author was distinguished as a painter, architect and engraver. He died in 1638.

River basin (which still confound archaeologists as to their date and origin) representing Oregon and Washington; and, finally, the extraordinary and delightful baskets made by the Pomo Indians of northern California. . . .

The core of this exhibition is the Museum's own carefully acquired Indian collection. This has been supplemented by objects from the important collection of the University of Washington State Museum, and from the fine collection of the Heerman Gallery in New York, as well as by a number of isolated items from local private collections.

The Museum has purchased a number of fine animal sculptures to be the foundation of a projected Children's Collection, for which an anonymous fund of \$5000 was donated last year. Acquisitions include a splendid mediaeval aquamanile in the form of a Lion; a small bronze Greek Horse (about 8th century); a number of ancient Chinese sculptures—a terra cotta Dragon, a bronze Hare, a terra cotta Sow, and a pair of early terra cotta Swine.

N AN EVER CHANGING WORLD

Also showing in March are an exhibition of War Posters, circulated by Artists for Victory, and a group of photographs, "Our Navy in Action," sponsored by the War Department.

An exhibition on City and Regional Planning will be held at the museum from April 1st to May 15th.

CERAMICS AND SILVER BY CARLTON AND KATHRYN BALL

Ending March 20 at the San Francisco Museum of Art, after a successful run of nearly a full month, the exhibition of Ceramics and Silver by Carlton and Kathryn Ball, has resulted in fresh praise for these two native-born Californians, who are doing so much to cultivate interest in the two crafts.

Kathryn Uhl and Carlton Ball met each other as students at the Sacramento Junior College. After their marriage they began working together in ceramics, her interest in drawing adapting itself to the decoration of the forms created by Carlton Ball in clay and glass.

Their work at Mills College as teachers motivates their investigation into varied forms of expression and methods in the use of media. To encourage art participation amongst a great number of people they have worked to establish a craft service, with the support of Mills College Administration and Mr. Ball's students in occupational-therapy and recreation. With a station wagon filled with equipment and volunteer students, they give art-in-action demonstrations before neighborhood groups, USO centers, military hospitals and in co-operation with the American Red Cross.

ARTIST BAND RETURNS EAST AFTER CALIFORNIA SOJOURN

Max Band, whose work has not been shown in New York for three years, has returned from a sojourn in California and is now holding an exhibition of paintings at the Lilienfeld Galleries (through Feb. 19). This artist, whose canvases have been included in public and private collections in America, Europe and Palestine, continues to paint with the verve that has previously distinguished his work, so that one feels he is constantly drawing on new, inexhaustible sources of inspiration. Yet while there is a passionate intensity in Band's paintings, which makes itself felt as a reflection of his own delight in creative work, there is sound structure in his designs and significance in his forms.

In the landscapes of California orchards and in many of the still lifes, he uses a heavy impasto of pure, jewel-like color employed with tact and discretion in its relations, for all its brilliance of swept-up surfaces, Snapdragon, Double Petunias, Early Spring or the thrusting branches and rich greens of The Tree are examples of the artist's ability to combine lyricism and simplified, powerful design. Woman in Red with its smoothly brushed surfaces and clarity of definition is in a completely different form of expression, but the arrangement of the figure and the latent richness of the color display the same personal usages of design and color pattern.

The majestic figures of Day of Atonement or the emotional fervor of Sinai convey deep spiritual significance, in which the religious content and the pictorial expression are completely congruous. —Margaret Breuning in Art Digest.

JEAN GATES HALL HOLDS A ONE-MAN SHOW AT DE YOUNG

On exhibit at the de Young Museum throughout the current month is a group of watercolors and oils by the young California artist, Jean Gates Hall. Mrs. Hall, though born in Tennessee, received most of her art training at the Chouinard School in Southern California, later to work for the motion picture cartoon studios in Hollywood. Since her marriage six years ago, the artist has made her home in San Francisco where she is known through numerous group and one-man shows held at the San Francisco Museum, Paul Elder Gallery and "Art in Action" section at the City of Paris. Also,



STILL LIFE: FLOWERS AND PRICKLY PEARS, 1884

Oil on canvas by Pierre August Renoit

San Francisco Museum of Art



San Francisco Museum of Art

OIL: TO SAN FRANCISCO

By Tom Lewis

This painting, now on exhibition, is included in the William L. Gerstle Gift to the Museum. The painting is by a young Californian, now a resident of San Francisco, who has achieved distinction for his water colors as well as oils.

her work was on exhibition during the World's Fair on Treasure Island.

The present exhibit is full of variety, both as to style and subject matter. Since the war, the artist's husband, a recruiting officer for the U. S. Maritime Service, has had to travel extensively, and Mrs. Hall has followed him "from transfer to transfer, painting the changing scene as she goes." Landscapes of the San Francisco Bay region, the Nevada deserts, the Puget Sound country and Canadian lakes and rockies, still lifes, figure studies and portraits, in watercolor and oil, are included.

ARTHUR BEAUMONT WATERCOLORS AT DE YOUNG G. G. PARK MUSEUM

Recently painted for the National Geographic Magazine were a group of twenty-four watercolors showing the U. S. Army and Navy in action during maneuvers. These works by Arthur Beaumont, which have received a favorable showing so far in Los Angeles, San Diego, Long Beach and Seattle, now are to be seen at the de Young Museum.

WIDENER GIFT TO NATIONAL GALLERY APPRAISED AT \$7,141,000

A. S. W. Rosenbach, Philadelphia art and rare book expert, has appraised the Joseph E. Widener collection which was given to the National Gallery at \$7,141,000. The appraisal, which was made for tax transfer purposes, was commissioned by the Commonwealth of Pennsylvania. Mr. Rosenbach valued Raphael's "Small Cowper Madonna" at \$400,000 and Rembrandt's "The Mill" at \$350,000.

LIONEL BARRYMORE HONORED BY ARTISTS PROFESSIONAL LEAGUE

The American Artists Professional League has elected Lionel Barrymore to its National Executive Committee. In making the announcement at the League's Annual Dinner at Salmagundi Club in New York, Albert T. Reid, its National Vice-President, recalled Barrymore's intentions to follow a career in art. Mr. Reid said

"It is my honor to make this formal announcement that Lionel Barrymore, an outstanding figure of the American stage and screen, who with his brilliant and talented family has won everlasting fame in the theatre of the world, has graciously accepted a place on your Executive Board of the American Artists Professional League.

"It is because he has achieved outstanding skill in the profession of art—his first great love and ambition that he had to relegate to a second place in order to make a living.

"Comparatively few of his millions of admirers are aware of his art and most of those who knew anything about it looked upon it as a hobby. So, the League, fully conscious of Mr. Barrymore's ability in the line of his greatest ambition, and with a desire to help point the finger of recognition to his art, is now doing honor to him—though we feel in all humility, he is honoring us."

STAN PORAY, CALIFORNIAN, HAS NOTABLE NEW YORK EXHIBITION

Stan Poray, having established himself firmly in California art circles and before that won esteem in Europe, is now making his debut in America's artistic Big League, on 57th Street, New York—in a March exhibition at the Grand Central Galleries. Dominated largely by colorful still lifes and lush Western landscapes, the show has as its common denominator sound craftsmanship supported by a love of subtle color harmonies and an imaginative mind.

RUNNING FIRE

(Concluded from Page 3)

and the raids of the R.A.F. over Germany, has me stumped. But after all, why worry. The entire architectural profession is in about the same boat. With priorities still to be met, with the government paying less and less attention to the needs of the profession and with a fat income tax staring us in the face, anything I could say would be of little interest, if it ever was.

• **THE NEW JOURNAL**

The first issue of the Journal of the American Institute of Architects in its new format has my O.K. I like its shape, size, style and contents. I have always missed good illustrations, particularly in a journal of a profession which deals so much in the creation of the beautiful.

About thirty years ago The Octagon, which then held a place beside the large magazines dealing with similar subjects, published some of a series I was writing under the title of "Antique America." Quite naturally at that time I predicted a bright future for the journal and at last it seems to be on the way. I don't know how they did it, but now that they have secured the services of Mr. Henry H. Saylor to direct the destinies of the Octagon we will all start reading it again.

Sakes alive!

NOBODY SEEMS TO KNOW WHEN THIS HOUSE IS COMFORTABLE...



Grandma's complaint will have a familiar ring to Architects and Builders. Central heating cannot satisfy all members of the family. But, after the war, you can specify PAYNE ZONE-CONDITIONING.

Pioneered by PAYNE, improved for tomorrow, Zone-Conditioning is *flexible*. Healthful circulation of filtered fresh air, gas-heated in winter, controlled by *zones or individual rooms*. ★ Not available now; we're concentrating on war production. But PAYNE Dealers have the facts for you. Remember *Zone-Conditioning*.

PAYNEHEAT

NEARLY 30 YEARS OF LEADERSHIP

HELP BATTER THE AXIS . . . WITH BONDS



36 Years Experience + Vision for Tomorrow

Make "American Rubber" Products Timed for Today's Needs

It's this long experience . . . plus our practice of always looking ahead . . . that have enabled us to meet the emergencies brought about by this global war. Experience plus Vision have enabled us to develop Ar-Polene, the American synthetic, and to use it in such a manner that, in many cases, it is superior to natural rubber.

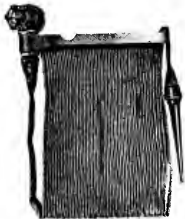

Now, just as in normal times, you can depend upon "American Rubber" products for today's needs, and for tomorrow's.

Lighting Hose Racks, Reels, and Cabinets, and hose made by The American Rubber Manufacturing Company, provide the measure of protection required by law and business sense.

The AMERICAN RUBBER

Factory and General Offices: **Manufacturing Co.**

Park Avenue and Watts Street, Oakland, 8, California

SATISFY YOUR CLIENTS WITH...

it's PENNVERNON
FLATTER flat drawn WINDOW GLASS
.. CLEARER ..
.. BRIGHTER ..

It costs no more!

Next time specify Pennvernon

Distributed by

W. P. FULLER & CO.

PAINTS • GLASS • WALLPAPER

IN THE NEWS

DAILEY SUCCEEDS STONE



DAILEY

Gardner A. Dailey, architect, has been appointed by Mayor Lapham, of San Francisco, to succeed Douglas Dacre Stone, as member of the San Francisco City Planning Commission. Stone, an appointee of the Rossi Administration, was Chairman of the Commission.

Mr. Dailey has practiced architecture in San Francisco for 17 years. As noted in these columns last month, he recently returned from Brazil where

he was head architect and engineer for the Rubber Development Corporation (R.F.C.). His most recent works in the Bay area were housing projects at the Presidio of San Francisco, and the United States Merchant Marine Cadet Basic School in San Mateo.

STATE BOARD APPOINTEES

Governor Warren has reappointed Frederick H. Reimers, of San Francisco, a member of the California State Board of Architecture. Mr. Reimers served as President of the Board under the last Administration. The Governor also appointed William C. Ambrose, of San Francisco, and Herbert J. Powell, of Los Angeles, new members of the Board. The two are well known to the profession, both having been active in Chapter and Association affairs for some time. Powell is President of the Southern California Chapter, while Ambrose is a Director of Northern California Chapter, A. I. A.

Holdover members of the Board are Louis J. Gill, of San Diego, and Richard J. Neutra, of Los Angeles. The latter is not practicing in the State at the present time.

PROMOTES SLUM CLEARANCE

Catherine Bauer (Mrs. William W. Wurster) is vice-president of the National Public Housing Conference, devoted to slum clearance and low-rent public housing. The Conference maintains an office at 122 East 22nd Street, New York.

The Housing Conference is expected to assume a leadership in post-war housing plans which will vitally affect labor, builders, contractors, producers, finance institutions, local and Federal governments and organized citizens. All of these groups are urged to keep war production records in mind when estimating the potential scope of post-war housing. For example, in 1943 the nation produced about 10 times as much merchant shipping as in the entire four years preceding Pearl Harbor.

(Turn to Page 10)

Index to Advertisers

*Indicates Alternate Months

A	
ALADDIN Heating Corp.	47
AMERICAN Rubber Mfg. Co.	7
ANDERSON & Ringrose	48
B	
BASALT Rock Company	46
BAXTER & Company, J. H.	12
C	
CASSARETTO, John	48
CLARK, N., & Son	47
CLINTON Construction Company	45
COLUMBIA Steel Company	9
CROCKER First National Bank	47
D	
DINWIDDIE Construction Company	48
DOUGLAS Fir Plywood	13
F	
FIAT Metal Mfg. Co.	10
FORDERER Corncice Works	45
FULLER, W. P., Co.	7
G	
GUNN, Carle & Company	12
H	
HANKS, Inc., Abbot A.	47
HAWS Drinking Faucet Company	Back Cover
HERRICK Iron Works	48
HOGAN Lumber Company	45
HUNT, Robert W., Company	47
HUNTER, Thos. B.	48
I	
IMPERIAL Brass Co.	47
INDEPENDENT Iron Works	*
J	
JENSEN & Son., G. P. W.	48
JOHNSON Company, S. T.	*
JUDSON Pacific Company	45
K	
KAWNEER Co.	*
KRAFTILE Company	11
M	
MULLEN Mfg. Co.	48
N	
NORTHERN California Electrical Bureau	38
P	
PACIFIC Coast Gas Association	2
PACIFIC Manufacturing Company	46
PACIFIC Portland Cement Company	*
PARAMOUNT Built-In Fixture Company	42
PAYNE Furnace & Supply Co., Inc.	7
R	
REMILLARD-Dandini Co.	48
REPUBLIC Steel Corporation	46
S	
SANTA Maria Inn	46
SIMONDS Machinery Company	46
SISALKRAFT Company	46
SOULE Steel Co.	*
STANLEY Works, The	12
T	
TORMEY Company, The	48
U	
U. S. STEEL Company	9
V	
VERMONT Marble Company	46
W	
WESTERN Asbestos Company	12
WESTERN Lighting Fixture Co.	41
WOOD, E. K., Company	42
WAR Bonds	2nd & 3rd Covers

ARE YOU THINKING

ABOUT THE FUTURE?

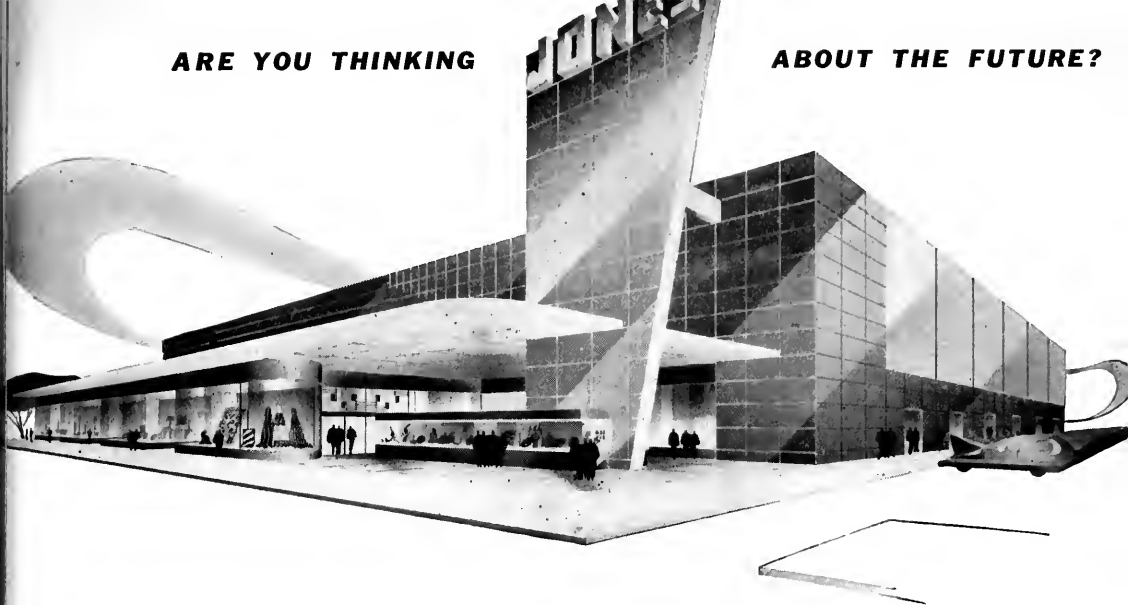

What STEEL has to offer the building industry

EVERY ARCHITECT, engineer and builder fully understands the fundamental qualities of steel, its importance to structural strength, its ease of fabrication, its reinforcing qualities, its use as a foundation material, but—

Only in recent years has the exceedingly wide versatility of steel for prefabricated applications been realized. Witness the immense acceptance of steel window sash, the wide adoption of porcelain enamel on steel for indoor and outdoor use, steel kitchen cabinets and equipment, light steel movable partitions, one-piece complete steel closets, steel staircases—even the successful employment of steel for insulation.

The reason for this development and why new uses will continue to multiply, is the almost limitless variety of properties and forms in which steel may be had. The building designer needs no curb on his imagination when it comes to the employment of steel.

To the building industry, which one day soon will face great and diverse construction opportunities, we of Columbia Steel Company, offer services for which we are peculiarly fitted. For we are not only the greatest producer of steel in the West, but as a subsidiary and distributor in the United States Steel family, we can share with you the benefits of unparalleled resources and facilities.

COLUMBIA STEEL COMPANY

San Francisco

United States Steel Supply Company, Chicago, *Warehouse Distributors*

United States Steel Export Company, New York

U-S-S BUILDING STEELS

PLATES
STRUCTURAL SHAPES
HOT ROLLED SHEETS
REINFORCING BARS
MERCHANT BARS
GALVANIZED SHEETS
PIPE AND TUBING
CASTINGS
HOT ROLLED STRIP
COLD ROLLED SHEETS
ELECTRICAL WIRES
WIRE AND WIRE PRODUCTS
SHEET PILING
WIRE ROPE
STAINLESS STEEL
NAILS
FABRICATED STRUCTURAL WORK



UNITED STATES STEEL

FIAT'S Volunteer

Approved by the Army,
Navy and Federal Public
Housing Engineers
for war housing and
military cantonments.

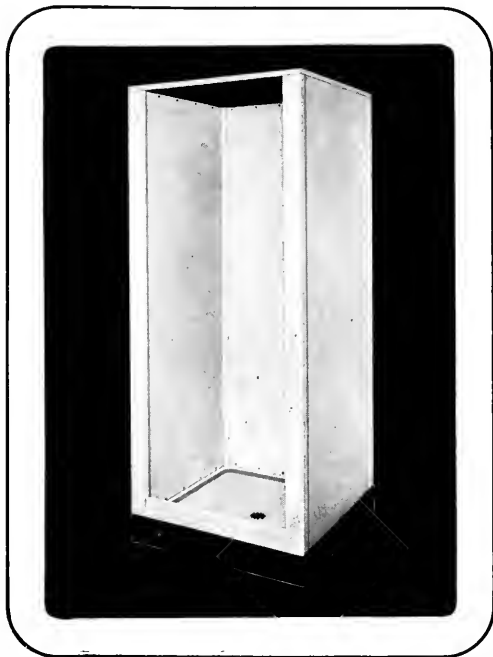

A truly prefabricated shower cabinet that can be set up in 18 minutes—has spring tension corner joints of rigid steel leakproof construction. The Volunteer meets war housing requirements and still retains all the trim beauty characteristic of a genuine Fiat Shower. Available through plumbers on adequate priorities.

SPECIFICATIONS

Walls: Tempered, hard pressed treated fibre-board, conforming to Federal Specification LLL-F-311, Class B, coated inside and out with waterproof, baked-on enamel, grey or white. All assembly pieces, including tension corner joints, front stiles (pilasters) threshold and headrail, rust-proofed steel—use allowed by government. All parts formed to eliminate raw edges within

the interior of the compartment.

Receptor: Pre-cast reinforced concrete. Non-slip, leak-proof, non-absorbent and sanitary. Drain cast integral with receptor.

Size: Overall dimensions, thirty-two by thirty-two by seventy-five inches high (32" x 32" x 75"). On special request 30" x 30" x 75" can be furnished.

FIAT METAL MANUFACTURING CO.

32 South San Gabriel Boulevard, Pasadena, California
1205 Roscoe Street, Chicago, Illinois
21-45 Borden Avenue, Long Island City, New York

IN THE NEWS

"Surely if only a due share of this mind and muscle is turned to the housing job after the war, we can produce 1,000,000 or 1,500,000 new houses each year, we can make them better houses than we have ever had before, and we can make them available at prices serving the needs of all groups within the American people," is the belief of Administrator John B. Blandford, Jr., of the National Housing Agency.

The Wursters are expected to return to San Francisco soon from Cambridge, Mass., where Mr. Wurster has been taking post-graduate work at Harvard.

COURSE IN TIMBER DESIGN

The University of California War Training Center offers a 14-week, every Thursday, two-hour evening course in timber structural design, under the tutelage of Henry J. Degenkalb, structural engineer with the Summerbell Roof Structures of Northern California. The course will start at 7:30 p.m., March 23, in the Engineering Building, Berkeley Campus. For further information call or write the War Training Center, U. C., California Hall, Berkeley, or 20 Second Street, San Francisco.

KINLEY MEMORIAL FELLOWSHIP

The trustees of the University of Illinois announce the 13th annual consideration of candidates for the Kate Neal Kinley Memorial Fellowship, 1944-45, and requests that applications be filed not later than May 1, 1944. The fellowship, valued at \$1,000, is open to graduates of the College of Fine and Applied Arts of the University of Illinois and to graduates of similar institutions of equal educational standing. Applicants should not exceed 24 years of age. Blanks are available by addressing Dean Rexford Newcomb, Room 110, Architecture Building, Urbana, Illinois.

COLLEGE OF ENGINEERING

Early opening of the new College of Engineering at the University of California, Los Angeles, is foreseen by President William Sproul, who is quoted as saying:

"A special committee under Dean Gordon S. Watkins of the College of Letters and Science has been examining the qualifications of distinguished engineers whose names have been presented in connection with the deanship of the new college, and its recommendations are to be submitted in the near future."

According to Dean Watkins, the task of selecting a dean for the college is proving extremely difficult.

\$1600 POST-WAR HOUSES

Architects are always interested to learn what the buildings they design after the war will look like, feel like, and impress as architecture as well as function practically. Here is another man who tells us. He is Doctor James Shelby Thomas, one time economist on the faculty of the University of Chicago; a past presi-

(Turn to Page 13)

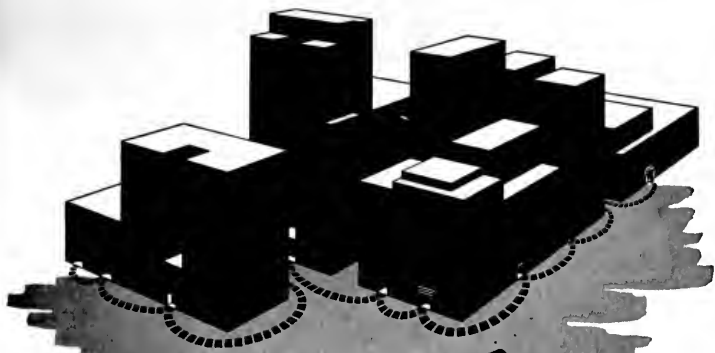

We made a Survey and is our Face RED!

HERE'S WHY . . . We wanted to find out what you architects, contractors, and engineers know about Kraftile products and service. Well, we found out! We know now, that Kraftile structural clay products are held in high regard by the building industry. But here's why we're a little embarrassed:

We just assumed that you know as much about Kraftile special construction products . . . MINWAX . . . MIRACLE ADHESIVES . . . R-MIR-DEK . . . RAYBESTOS . . . and NUKEM products as you do about *Kraftile*. And we just took it for granted that you knew of Kraftile's "consulting service" . . . designed to

help answer special construction problems.

It looks like we were wrong . . . and we want to remedy that situation right now! We want you to know that the whole Kraftile organization is ready to *produce for you!* So to start it off . . . if you wish information on any of these subjects . . . just jot down the corresponding number on the attached coupon, send it in and receive a *free* booklet answering your questions.



1. STRUCTURAL CLAY PRODUCTS
2. FIRE PROOFINGS
3. WATER PROOFINGS
4. DAMP PROOFINGS
5. CAULKING COMPOUNDS
6. WOOD FINISHES AND WAXES
7. PROTECTIVE COATINGS
8. TILE ADHESIVES
9. NON-SLIP FLOOR COATING
10. WEATHER DECKING
11. ACID PROOF COMPOUNDS
12. ACID RESISTANT ENAMELS

**KRAFTILE COMPANY
NILES, CALIFORNIA**

Please send me free material
to answer question Nos. _____

Name _____

Firm _____

Address _____

City _____ State _____



SINCE 1925 Western Asbestos Co. has made over three thousand installations of Celotex Sound Conditioning. This extensive experience is available to architects and engineers.

WESTERN ASBESTOS CO.
Acoustical Engineers and Contractors
 SAN FRANCISCO, OAKLAND, SACRAMENTO, RICHMOND, CALIFORNIA
 SALT LAKE CITY, UTAH

The New Weapon Against Fire
 IS
FIREPEL "S"

A TIMELY CHEMICAL ACHIEVEMENT FOR THE TREATMENT OF UNFINISHED INTERIOR WOOD AFFORDING A PRACTICAL METHOD OF SUCCESSFUL FIRE RETARDATION

IN
 Homes

Industrial Plants - Schools

THE ONLY FIRE RETARDANT COATING MATERIAL ON THE MARKET LISTED AND APPROVED BY

UNDERWRITERS LABORATORIES INC.

DISTRIBUTED BY



GUNN, CARLE & CO.
 20 POTRERO AVE.
 SAN FRANCISCO
 Underhill 5480

War Workers are Planning Real Homes!

War-workers living in trailer or temporary-housing "projects" are planing to make their dreams of an after-victory home a reality. Many of these war-workers swear that they'll spend weeks in bed, once peace is declared. This promises a good crop of future customers for bedroom hardware.

And that's where you can helpfully do your share by specifying Stanley Hardware. You may depend on it — there will be a wealth of Stanley items which will cater pleasantly to appearance, efficiency, neatness and comfort in the 194x bedroom.

No, we won't neglect those time-proved standard items that always sell and sell. After the war, Stanley will be out in front as usual with smart, smooth-functioning types and styles that will meet every requirement of architecture and interior design. The Stanley Works, New Britain, Connecticut.

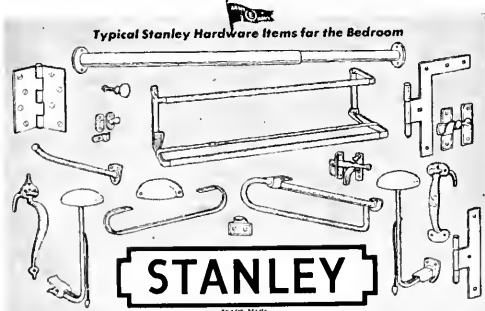

BAXCO
 CHROMATED ZINC CHLORIDE

PTG

PRESSURE TREATED LUMBER
 ● **PROTECTS AGAINST DECAY AND TERMITE ATTACK**

Specify it in your home
 Available through Lumber Dealers

LOS ANGELES 601 W. 5th Street Phone Michigan 6294	SAN FRANCISCO 333 Montgomery Street Phone DOugles 3883
---	--

J.H. Baxter & Co.

AGENTS FOR WEST COAST WOOD PRESERVING CO. SEATTLE, WASH

IN THE NEWS

dent of Clarkson College of Technology; past president of the Chrysler Institute of Engineering, and now he is called simply technologist.

Doctor Thomas tells us that soon after the war there will be millions of new houses that cost only \$1600 apiece and contain dozens of new developments. Among these developments he enumerates unbreakable glass plumbing; filters that transform noises outside into music inside; refrigerators that have everything including murals; and a living room that can be re-decorated completely by pressing a button. (A lot of baloney, we'd say!)

RADIO-NEWSPAPER BUILDING

The Chicago Tribune has announced that after the war it will build a six-story newspaper plant combined with a 2000-seat radio theater to be operated by station WGN. Plans for the building, which with equipment, will cost several million, are now being prepared and will be ready for contractors to figure with the declaration of peace.

The National Broadcasting Company has announced it will build a million-dollar short wave station in the San Francisco Bay area after the war.

ILLINOIS ENGINEER'S ACT VOID

A decision of prime importance, especially to the Engineering and Architectural groups of Illinois was handed down by Judge Victor Hemphill, November 30, 1943, in which the present Illinois Professional Engineer's Act was declared unconstitutional.

This decision indicated that laws passed by the State Legislature must have sufficient clarity and conciseness to enable their proper administration. It has also made clear that administrative bodies can not indulge in their own expedient law making to interpret acts that are vague, indefinite, and uncertain in their content.

In addition, it gave the opinion that the qualifications in one particular field of engineering would not give licensed rights to engage in other engineering fields that by schooling, training, and experience are entirely foreign to such qualifications.

ENGINEERS HOLD JOINT SESSION

The annual joint meeting of the Member Societies of the San Francisco Engineering Council was held at the Pacific Gas and Electric Company auditorium in San Francisco, Thursday evening, February 24. Ralph R. Beal delivered an address on "Radio-Electronics in the Post-War World." He cited post-war possibilities and applications of the new broadcast services of FM and Television, also electron microscope and industrial applications, electronics and radio thermics. Preceding the open meeting, members and their guests dined at the Engineers' Club.

DOUGLAS FIR PLYWOOD

cuts cost of building
Troop Sleepers

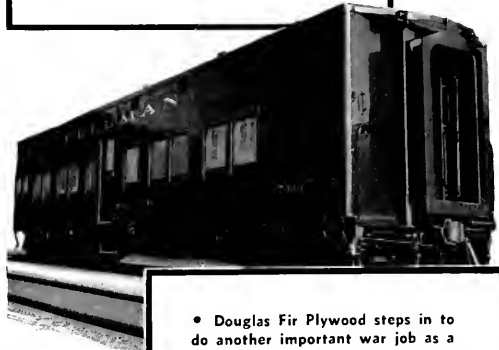

- Douglas Fir Plywood steps in to do another important war job as a smooth, durable, economical ceiling and wall paneling for Uncle Sam's new-type Pullman troop sleeper.

- Designed to carry 30 fighting men in triple-deck berths, these cars were produced at a small fraction of a standard sleeper's cost . . . are the first in U. S. history to be built exclusively for carrying troops.

- Such war-time applications broaden the post-victory uses of versatile Douglas Fir Plywood. In YOUR future planning consider this modern miracle wood's many outstanding advantages. Write for information to Douglas Fir Plywood Association, Tacoma 1, Wash.

- Workmen apply 3/8 inch Douglas Fir Plywood to the interior walls of the new Pullman sleeper.

- A Pullman port makes up a berth on the sleeper. The new cars were produced at a rate of 12 to 18 a day. Emphasis was on comfort and efficiency.



DOUGLAS FIR PLYWOOD

Real Lumber
MADE LARGER, LIGHTER
SPLIT-PROOF
STRONGER

POUND FOR POUND STRONGER THAN STEEL.

DESIGN OF OAKLAND CHURCH

This pre-war church and parochial residence for St. Margaret's Parish in Oakland, was designed for the needs of a growing congregation of 500 people in a well populated neighborhood in that city. Post-war church planners will find it a well studied ecclesiastical structure possessing many features applicable to present and future needs. Built of reinforced concrete of graduated thickness, the structural material is of the type that architects are most likely to favor in their post-war church plans, especially where funds are available for fire and 'quake resistant structures. The Norman-English style of architecture chosen by Architect Schirmer, may be simplified or modernized, but the general plan and materials used are quite suitable for the post-war era.

Annexation of the parochial house to the church has its advantages, is especially convenient for parishioners who may wish to consult the pastor before or following services or on week days. Entrance to the house from the church is by a cloistered passageway.

A graduated concrete wall along one of the two street frontages gives a certain amount of privacy yet, at the same time, is not high enough to obstruct a view of the landscaped grounds in front of the two buildings.

The ecclesiastical feeling is carried out in the timber truss design of the auditorium ceiling and



ST. MARGARET'S CHURCH, OAKLAND, CALIFORNIA
William E. Schirmer, Architect

HAS POST-WAR POSSIBILITIES



ST. MARGARET'S CHURCH AND PAROCHIAL HOUSE, OAKLAND, CALIFORNIA

the Gothic treatment here is further accentuated in the design of the cement cloisters and leaded glass windows. The nave is acoustically treated and air conditioned and, besides excellent window lighting, bracket lights are provided on the sides. Pews and pulpit are hand-carved oak.

* * *

Mr. Schirmer's Hawley house in Piedmont, is a fine example of early California architecture—a style that was as popular five years ago as Spanish was in the late twenties.

The owner desired generous outdoor living areas and to this end the architect provided abundant yard space, featuring an outdoor barbecue pit, flowers, shrubbery and sheltered garden furniture.

The plan, as will be seen by referring to the cut, has a loggia off the spacious living room, the loggia and second story balcony contributing largely to the attractive appearance of the street frontage of the house. Besides the living

room, the ground floor contains dining and breakfast rooms, kitchen, pantry, study and maid's room. There are three bedrooms on the second floor.

Exterior of the house is rustic, brick and plaster with French windows and stationary green painted blinds for decorative effect. Roof is shingled shake.—F. W. J.

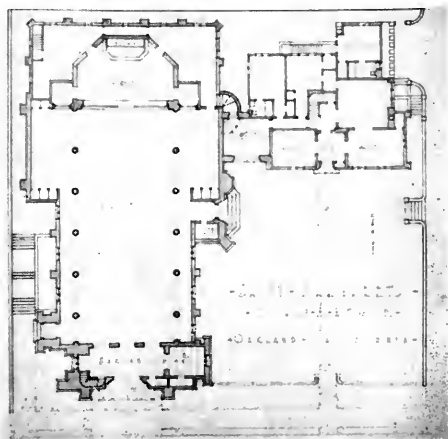

Plan, St. Margaret's Church and House, Oakland

Editor's Note—Henry Worthman, Chicago architect, in his new book, "The Advent of Church Architecture According to Bible History," holds there are three and only three styles of architecture for Christian churches—Byzantine, Romanesque and Gothic—and Gothic, he adds, is THE style of church architecture.



Baptistry, St. Margaret's Church, Oakland



Nave, St. Margaret's Church, Oakland

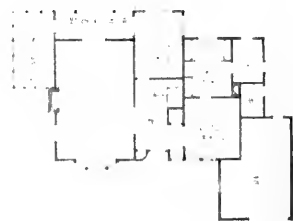
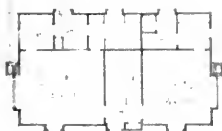

PROPOSED SIX-ROOM HOUSE IN PIEDMONT, CALIFORNIA
William E. Schirmer, Architect

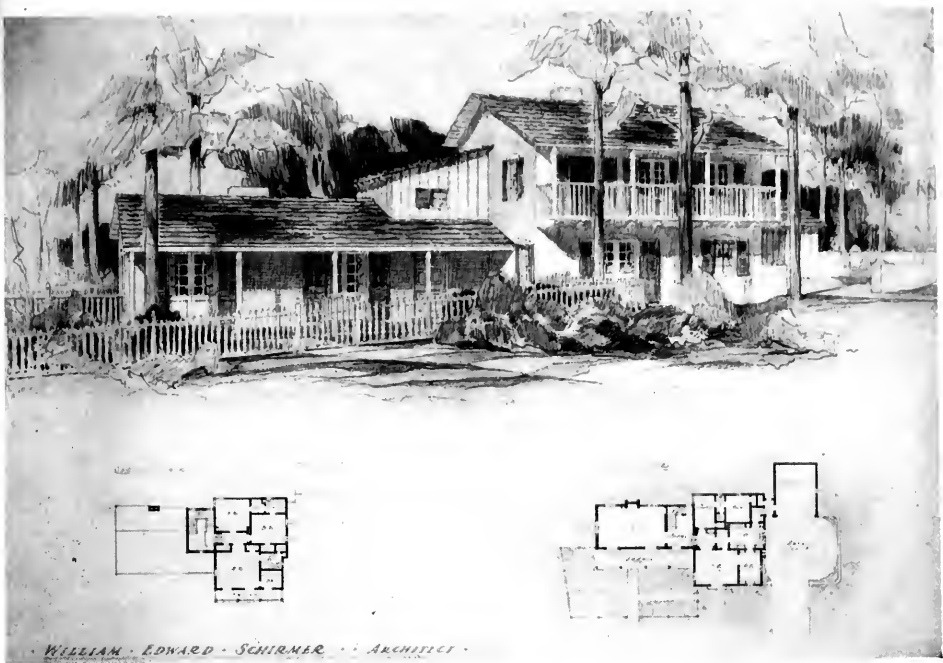

HILLSIDE HOUSE FOR MR. AND MRS. STUART HAWLEY, PIEDMONT
William E. Schirmer, Architect

KAISER BUILDS STEEL PLANT AND

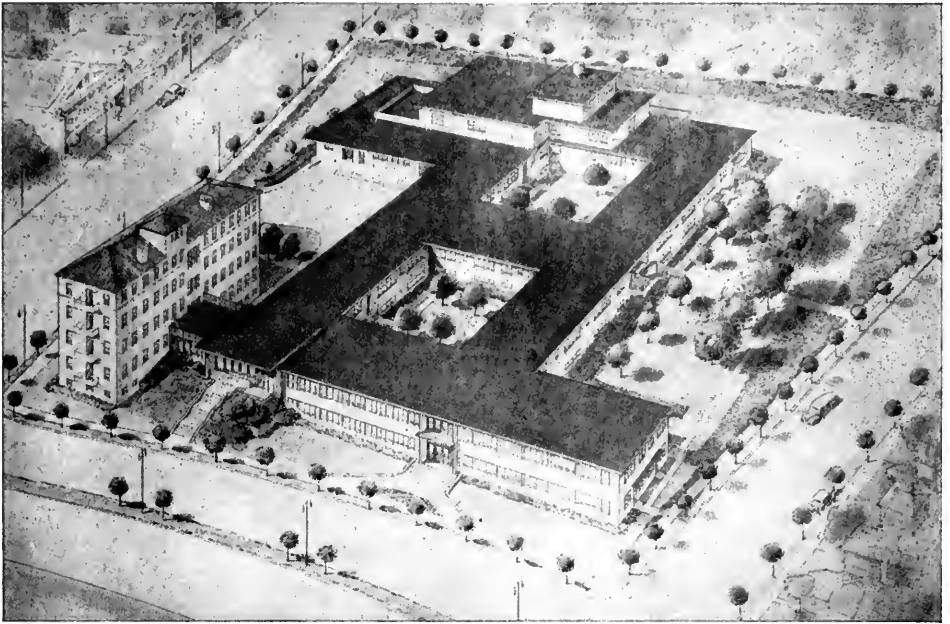

ARCHITECT'S SKETCH OF PROPOSED EXTENSIONS TO PERMANENTE HOSPITAL, OAKLAND, CALIFORNIA
Birge M. and David B. Clark, Architects

Present hospital (a four story building) is pictured in left foreground. The new two story wings will provide 110 additional beds.



PHYSICAL TESTING LABORATORY, KAISER STEEL PLANT, FONTANA
Birge M. and David B. Clark, Architects

NEW HOSPITAL

The photograph shown below is one of several excellent views just released of the Administration Building at Fontana, California, for the Henry J. Kaiser Company, Inc. Designed by Birge M. and David B. Clark, architects of Palo Alto, the building is one unit of a group of eight or more major structures erected since the war began for the manufacture of steel.

The one-story office building (see cover) is built around a central patio in which a Roman brick fountain was dexterously worked into the landscaping plan. The main entrance is flanked with a brick pylon and pilaster which, with slightly overhanging cornices around the entire building and liberal window space, reflect a dignified handling of modern trends.

Some idea of the size of the building may be had from the statement that more than 4,000 cubic yards of concrete were poured

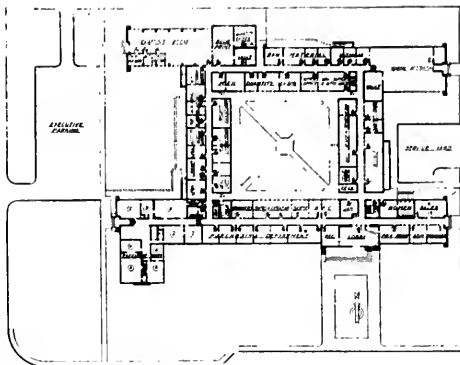

**Plan, Administration Building
Kaiser Plant, Fontana**

into 260,000 feet of form work. Irregular in shape, its extreme dimensions are approximately 312 x 244 feet. All windows have steel sash and the building is completely air conditioned and fluorescently lighted.



**PATIO, ADMINISTRATION BUILDING, KAISER STEEL PLANT
FONTANA, CALIFORNIA**
Birge M. and David B. Clark, Architects



**STREET VIEW OF ADMINISTRATION BUILDING, KAISER STEEL PLANT
FONTANA, CALIFORNIA**

NEW IDEAS SHOULD NOT BE DISCOUNTED IN FUTURE BUILDING PLANS

by **BROR DAHLBERG**

The greatest opportunity in history is about to drop in the building industry's lap.

The equivalent of 15 to 20 million housing units will be needed in this country during the next ten years, and Europe, to repair the ravages of war, will require something like 100 to 125 million new homes. The United States, of course, will not build these, but undoubtedly will do a fair share in supplying some of the materials and manufactured parts.

Along with the new housing which the United States will require will be the need for new stores, schools, theaters and a multitude of other facilities, as well as factories and production plants, all of which will call for a tremendous amount of construction and reconstruction. The late Albert Kahn, industrial architect, estimated that more than half the factory buildings in this country will have to be rebuilt or reconverted if the companies operating them are to maintain their place in the competitive race.

There will be more than enough building business for everyone—manufacturers, builders, craftsmen and architects.

Yet, in certain quarters, the future is viewed with foreboding. Repeatedly voiced is the dread that the public, hypnotized by stories of miracles, will stage a buyers' strike unless it gets a so-called "Miracle House" within sixty days after the end of hostilities.

It is time to pull this bogey-man from under the bed and look at him in the clear light of common sense.

To fear a buyers' strike after the war is misjudgment of the public's buying habits. The public has been subjected for years to the most skillful advertising magic. It takes wonder stories in stride, separates the wheat from the chaff and forms its own judgment. It will no more hold back from buying a home because it lacks all the miracles that have been described than it will hesitate to buy a 1942 model automobile after the war, even though it knows there may be radical improvements in motor car design within a couple of years. The stories of television never cut down radio sales.

The so-called housing "miracles" have played a major part in capturing and holding public attention. The tremendous interest aroused

during the past year did not grow like Topsy. A nation with its mind fixed on winning a war does not dream about a future home unless stimulated to do so. That stimulus has been supplied by thousands of magazine and newspaper stories about better and less costly dwellings.

Now the public is being told that all such miracles are "fantastic figments of the imagination." There have been statements that home costs would be 25% to 35% higher after the war, and that there will be few if any improvements for years to come.

Such statements are untrue when applied to homes for the people who really need homes and can result only in mental confusion. If anything can hold back home building after the war, which I do not believe, such confusion and uncertainty will do it.

Furthermore, fantastic ideas should not be discounted except with extreme caution. Ideas have built our modern world.

Bring to mind just a few one-time fantastic impossibilities:

Motion pictures, radio, television, radar, the electric eye, the radio guiding beam and the radio controlled rocket bomb.

Surface cultivation of the soil and synthetic cattle breeding.

Radium, insulin, the sulphur drugs, penicillin.

Aluminum, magnesium, plastics, synthetic rubber, wool from rock, silk from wood.

The automobile, the airplane, stratosphere flying, the jet propulsion plane.

Automatic refrigeration and air conditioning.

And, most fantastic of all, the thing that has brought all these miracles within reach of all the people, the American system of mass production.

The man who first invented mass production was stoned by his neighbors. Yet, every time you step in your car, or snap on your radio, or make a long distance telephone call, you should salute that man. For without his contribution these wonders might have been invented, but they would never have been produced on a scale so that you and I would have been able to enjoy them.

Likewise, a great part of the American people can never afford substantial, comfortable homes until these same methods produce them. Some day the building industry will learn which side of the railroad track its bread is buttered on. It will adapt the mass production technique to its needs and become, for the first time, America's No. 1 industry.

Some say such methods cannot be used for homes. The same was said of aircraft three years ago, yet mass production of planes by assembly line methods today is carrying us to an earlier victory. For every 100 workers needed to build a Douglas A-20 in 1940, only nine were needed in 1943. In 1940, it took 444 workers a year to build a Liberator; today it requires only 17.

Since Pearl Harbor, we have begun to learn the difference between building one or two houses at a time and building 100 or 500 or 1000. We have found that we can build more economically on the quantity basis, which should come as no great surprise because every other American industry has long known and practised that method.

None of us need fear the advent of new methods. It will occur gradually, starting with low-cost homes which the industry has never before supplied. It will continue to evolve for ten, twenty-five, a hundred years, so long as men are free to progress.

Those of us who prefer doing things the traditional way will have full opportunity to do so. Home owners' tastes will not change over night; it took years to get the buggy front off the automobile.

But those who wish to continue the old traditions should not interfere with the progress of others. It is particularly important that all artificial hindrances be removed before the industry takes up its post-war task. The vigor of new blood and new ideas must be pumped into the industry if it is to reach the peak of activity that will represent for it the difference between full employment and prosperity or unemployment and want.

The future of free enterprise and democratic government may well be advanced or hampered by the performance of the building industry in the next ten years.



FRUNZE MILITARY ACADEMY, MOSCOW
THE WEST POINT OF SOVIET RUSSIA

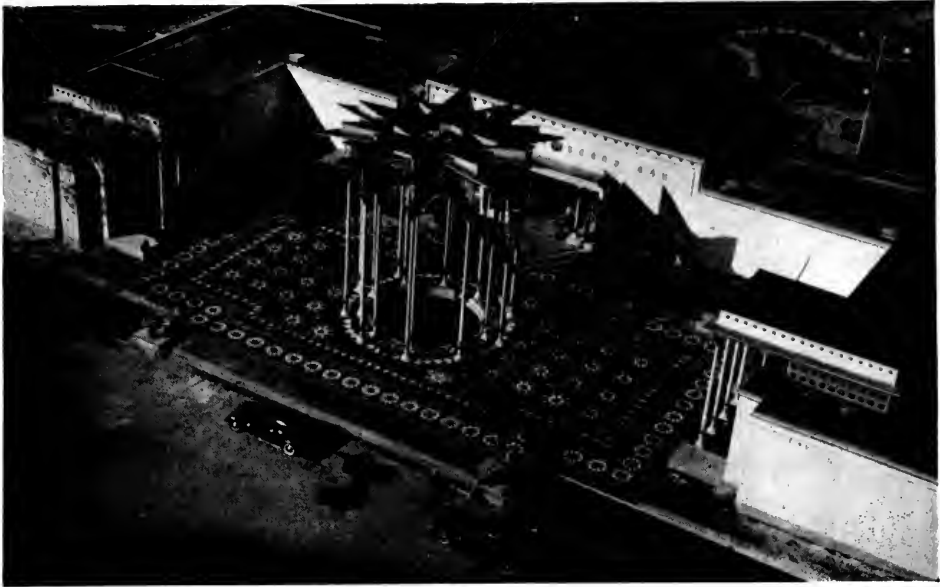

ALL-UNION AGRICULTURAL EXPOSITION IN MOSCOW, 1939-41
Pavillon of the Republic of Uzbek

REBUILDING DEVASTATED AREAS OF SOVIET UNION

As revealed recently to the American public concerning the growing importance of the constituent Republics of the Soviet Union, the accompanying designs based on regional motifs, are particularly illuminating.

Soviet architecture is confronted with extremely difficult problems in the restoration of cities destroyed by the German invaders. Some idea of the quantitative amount of devastation caused by the enemy may be had in the statement that each of the ravaged Soviet Ukrainian and Byelorussian regions is equal in territory to one of America's largest states.

The year 1943 began, as everyone knows, with one of the greatest battles in the history of wars—the Battle of Stalingrad. Despite the fact that the Germans suffered a crushing defeat, the damage done to the city was appalling. But the Russians faced the emergency with confidence. The Academy of Architecture immediately began work on a new general plan for rebuilding the city and that plan is now being carried out as speedily as it is possible considering the shortage of stone masons, carpenters and laborers, to say nothing of en-

gineers and technicians, plus difficulties in obtaining building materials, particularly lumber, which must be shipped from far distant points.

To coordinate the work of architectural planning, a Committee on Architecture, exercising the rights of a special People's Commissariat, was recently established by a decision of the Soviet Government. This new government organ is charged with coordination of the work of the various organizations dealing with city planning and architectural design, approval of the general city plans, the providing of architects for rehabilitation work, exercising architectural supervision and control, confirmation of standard designs for residential and public buildings, and the protection and restoration of historic architectural monuments.

The Soviet's decree on the establishment of this new committee particularly emphasizes its primary task—to insure superior architectural



BEFORE AND AFTER, SHOWING

work in all new construction and in the restoration of demolished cities.

The Union of Soviet Architects, with 4000 highly-qualified members — all of whom are ready and eager to devote their energies to the rehabilitation of cities and communities devastated by the enemy—is rendering great assistance to the Committee on Architecture and other government bodies engaged in the preliminary work of restoration. On its own initiative, and by commission from the government, the Union is now working on a whole series of special problems dealing with architecture and engineering.

Competitions for designs of projects have been programmed by the Architects' Union. Public showings of the work of its members are held, at which the work is subjected to friendly criticism. Special courses for advanced study in certain branches have been arranged. The Union also assists in the proper distribution of architectural personnel and has been active in

sending groups of architects to newly-liberated cities. These groups enter a city immediately after the Red Army, help the population to carry out urgent rehabilitation measures, and then proceed with the further planning and rebuilding of the city.

A conference of leading Soviet architects held in Moscow recently discussed the two main problems of war construction—new housing and reconstruction of liberated towns. It was stated that although the main work of Soviet architects during the first year of the war was concerned with camouflage and construction of military facilities, more than 10,000 new buildings have been built in the Soviet Union since the beginning of the war. All architectural colleges and the building industry in general are studying United States methods of construction of apartment blocks.

The cities of the U.S.S.R. have stood the test of war supremely well. The wisdom of many



CITY PLANNING OF MOSCOW

previously questioned decisions has become apparent. The spacious marble-lined subterranean stations of the Moscow subway have proved themselves as the world's best air-raid shelters; not only safe, but also healthy and cheerful. On the wide asphalt-covered surfaces of the great boulevards, which several years ago replaced the tree-shaded promenades, the motorized searchlights and A. A. guns move freely. Concussion from explosions has demonstrated that it loses its force in the wide open spaces of the squares and super-blocks, and that it is easier to clear the roof of one 8 story apartment house from incendiary bombs than four roofs of four 2-story houses.

For the design of the small house of the future the architects and planners of the U.S. S.R. are looking to American precedents. They feel that there is much that they can learn from the United States.—F. W. J.



Red Army Sanatorium in Sochi on the Caucasian Coast of the Black Sea



MOSCOW HOTEL, MOSCOW
An Example of Modern Classical Interpretation by
Russian Architects

ALL-UNION AGRICULTURAL EXPOSITION, MOSCOW, 1939-41

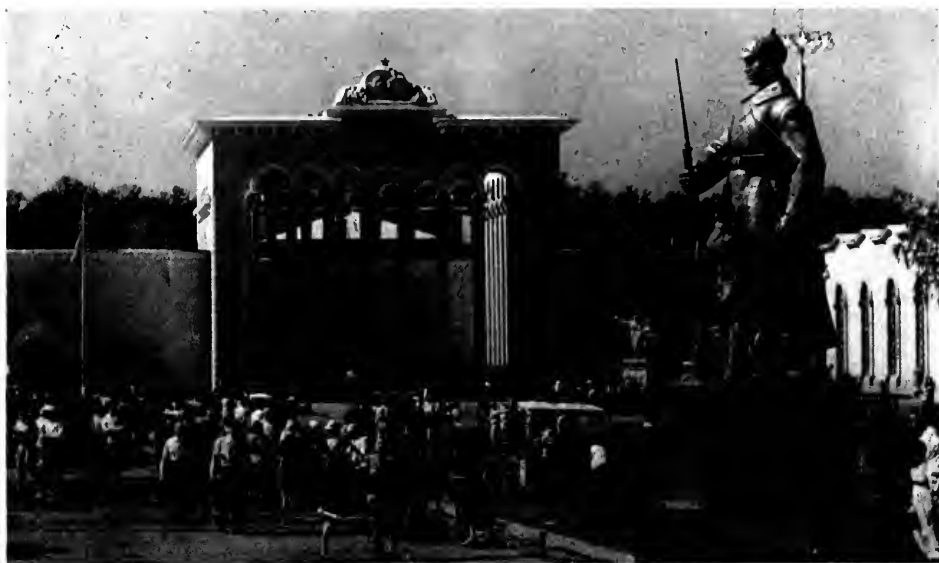

PAVILION OF THE GEORGIAN REPUBLIC

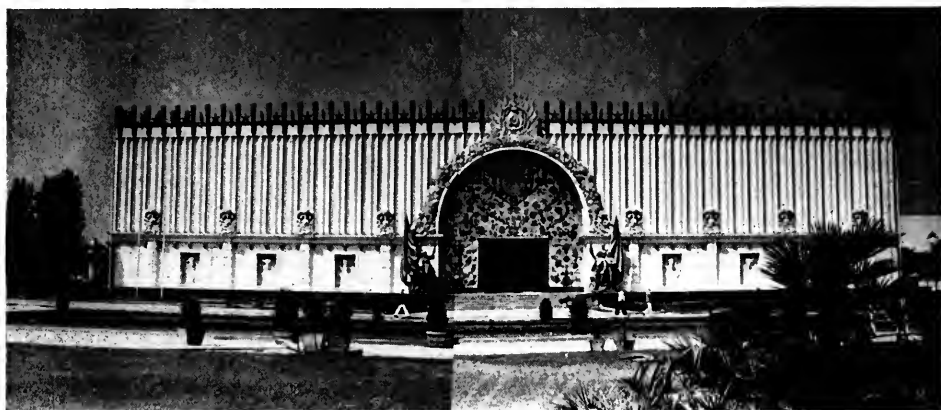

PAVILION OF THE UKRAINIAN REPUBLIC



PAVILION OF THE CENTRAL REGIONS: KALININ, SMOLENSK, OREL, YAROSLAVE, IVANOV



**ZNAMENSKY
CATHEDRAL**
1682-1688

and the Spas-na-Ilmene Cathedral, 1374. One of the finest examples of the prime of Novgorod architecture. The interior of the cathedral was decorated with frescoes by Theophanes the Greek, the great painter of Russian medieval times.

RUSSIAN ART TREASURES DESTROYED BY NAZIS

by **DOROTHY NEWMAN**

In these days of World War II, when human life seems of little value, the deliberate and purposeless desecration of the great monuments of history appear even more fantastic than the killing of people. In sheer vandalism the Nazis have surpassed any possible competitors. With true efficiency and thoroughness Fascist soldiers have carried out their directives to shatter and destroy some of the world's

most valuable and best preserved architectural and artistic treasures.

According to German war prisoner Forster, "... before leaving for Russia, Major von Kunsberg gave us the order of Ribbentrop—thoroughly to 'comb' all scientific institutions, libraries and palaces, properly to leaf all archives and lay hands on anything of definite value." And on December 10, 1941, General Reichenau stated that "historical artistic treas-



**VOSKRESENSKY
CATHEDRAL**

from the southwest side. The Hitlerites destroyed the tent of the rotunda, the cupola of the cross-like church and the belfry.



**CHEMENSKAYA
GALLERY**

One of many exquisite halls completely demolished by the Nazis.

ures in the East are of no consequence whatsoever." It was through their adherence to these slogans that the German armies systematically destroyed the most outstanding examples of architecture in the occupied territories.

At the Peterhof Palace which Peter the Great built and which stands outside of Leningrad, every Czar left his predecessor's room as he had found it—and added one more of his own. Fountains and statuary graced the outside—water flowing over gold-plated steps. All this had been preserved by the Soviet Government as part of Russian history and culture and was visited by thousands of people every year.

Now the palace is a burned shell—the rooms plundered, original bas-reliefs and statues stolen, the inlaid floors pulled up, the many beautiful mosaics, ornaments and works of art sent to Germany.

Magnificent churches and cathedrals in Novgorod, Pskov, Kiev and Chernigov, some of them dating back to the 12th and 13th centuries, were razed and looted. One of the finest examples of 14th century Novgorod architecture, the Spas-na-Ilmene Cathedral, whose interior was decorated with frescoes by Theophanes the Greek, the great painter of medieval time, and the 17th century Znamensky Cathedral which once stood beside it, are



TSCHAIKOWSKY'S HOUSE AFTER GERMAN OCCUPATION

now heaps of rubble. Only the shell of the Voskresensky Cathedral remains, the dome of the rotunda, the cupola of the cross-like church and the belfry having been completely destroyed (see cuts). The great Cathedral of St. Sophia, erected in the 11th century; the Spas Nereditsy Church, the interior walls of which were covered with frescoes executed by Novgorod masters in 1199; the Cathedral of St. George; and the Novgorod Kremlin, built in 1443, now lie in ruins.

The famous Pechora Abbey in Kiev, one of the oldest Russian monasteries, has been demolished. In it was the Cathedral of the Assumption built in 1073, and considered by many to be the crowning achievement of Russian baroque architecture. The monastery buildings contained the collection of several museums—priceless icons, pieces of embroidery, books and manuscripts. The New Jerusalem Monastery had stood since the 17th century. Before retreating from Istra, the Nazis bombed the parts of the monastery that were the most priceless from an architectural and historical viewpoint. Explosives were placed under those parts of the building which supported the whole structure.

The homes of the greatest of Russian writers

and composers have been preserved through the years as libraries and museums for visitors from all over the world. The names of Tolstoy, Chekov, Pushkin and Tschaikowsky occupy important places in the cultural heritage of the world. Their homes and studies have now been destroyed (see cut). Not only shrines to literature and music have been desecrated, but great works of art, and the galleries which housed them, have not been spared. A. M. Gerasimov, Chairman of the Organization Committee of the Union of Soviet Artists, reveals the feeling of the Russian people regarding these art treasures and their worth: "Works of art are our weapons! They are not only records of our national glory and the genius of our people; they are also formidable and potent weapons in the fight against the dark forces of fascism. . . . Nobody has yet succeeded, or will succeed in destroying Russian culture, the culture of the Soviet people. . . ." The Chesmenskaya Gallery, pictured here, is one of many such exquisite halls now completely demolished.

Editor's Note—During the month of January, through the courtesy of the American-Russian Institute of San Francisco, the de Young Museum displayed on its walls many excellent photographs which vividly showed these historic monuments, churches, shrines and other buildings both before and after Nazi destruction. In conjunction with the exhibition, the Institute has published a well-illustrated booklet, "Vandalism," which is obtainable through its offices at 101 Post Street, San Francisco.

POST-WAR HEATING AND AIR-CONDITIONING

by SAMUEL R. LEWIS, M. E.

Most engineers have been so very busy on design of war plants and the housing facilities for the employees of such plants that there has been little time to consider what changes there will be in heating after the war ends. One does experience a primary impression that changes may be due more particularly to use of new construction materials, such as plastics, developed under stress of substitution for critical metals.

It will be a distinct relief to engineers when a reasonable factor of safety, now prohibited by Washington authorities, again may be applied; particularly as to pipe sizes, boiler output capacity, electric motor horsepower, etc.

The restriction on Freon, the refrigerant used in most medium size air cooling plants, has terminated the construction of refrigerated air ventilating systems except for ultra special precision manufacturing plants.

All competent designers of such systems will be kept exceedingly busy serving the dammed-up needs of offices and homes, theaters and public buildings with year around air conditioning for several years after the war.

There seem to have been no radical new discoveries in air conditioning for comfort except perhaps in condensing unit details. The tendency in design is toward provision of better control and toward maintenance of a reduced dry bulb temperature differential. That is, to have the indoor air delivered at a higher temperature but less damp than was the tendency before the war.

Thousands of small houses have been built for war workers. Many of these designs show the effect of intensive architectural study. The tendency during the war is to heat these homes with mechanically circulated warm air. The furnace, really a good sized, jacketed stove with an electric fan to force air around it, usually is placed in a small room on the ground story.

Air supply ducts usually have been run overhead, concealed within a furred-down ceiling. This construction has caused plenty of fire department trouble. Domestic hot water preferably is heated by gas or electricity.

I have fought to get at least the furnace room of fireproof construction, with a cement floor and masonry walls and ceilings. The furnace rooms in the charming small houses I have inspected, after being occupied for a short time, become the repository for brooms, old newspapers, mops, empty cardboard boxes, extra groceries and the thousand articles which are demanded by modern living, but space for which is very short in these little compact houses. The door between the kitchen and the utility room usually is of wood. The fire menace is obvious.

Even when gas or oil is burned in the furnace, the fire hazard in these utility rooms is serious. (Richmond, California, has had at least six bad fires in its war housing projects.) I suggest that the heating apparatus always should be below the first story, with enough room to handle the fuel, leaving the first story utility room for its inevitable function of store room and catch-all.

In many of the small homes I have observed, where oil is the fuel, the oil tank is exposed above ground out of doors near the outside door of the utility room. There wasn't enough space within the house for the oil tank, and there wasn't enough money, or not enough something else, to bury and protect it.

In many cases the promoter has attempted to foist on the purchaser a gravity oil burner, in which the oil is supposed to trickle down a hot plate and somehow keep from clogging with carbon.

I sincerely hope that the small house of the future may have its heating plant in the basement. When the war is over the present restrictions attempting to limit the heating of such buildings to hot air will be lifted. Then the more efficient and more easily controlled

* From the Monthly Bulletin, Illinois Society of Architects.

heat transmission via a liquid, such as water, largely will supersede hot air.

The common, free standing, cast iron radiator probably will not return to universal acceptance. Installations employing radiant heating by means of piping imbedded in the floor or ceiling construction and carrying water at relatively low temperature, undoubtedly will increase. This method has been used extensively in buildings of various types, with entire satisfaction.

Our clients like a room which is delightfully comfortable at 65 degrees while the outside temperature is —10 degrees, with the baby crawling anywhere without being subjected to a draft, and without any dirty and unsightly radiator or convector or warm air register. Tests in such rooms indicate a knee-high temperature warmer than that around the feet or head, an interesting phenomenon, but one which attends radiant heating.

The fact that radiant heat acts in a manner similar to the heat which accompanies bright sunlight has led to consideration of utilization of solar energy to warm houses. There is no question but that the air in a room or a greenhouse receiving brilliant sunlight on even a very cold day will get warmer than the outside air even if no heat is delivered by the installed heating plant. Houses have been designed with large glass areas capable of receiving solar energy in winter and careful observations have been made of the very considerable heat thus obtained. The weakness of the scheme is that the sun shines only during daylight hours, that its intensity varies with the angle of light impact and with clouds and dust and fog, and that the angle of reception changes continually.

Thus the room receiving solar heat often will become too warm and the storage of heat in the walls, floor, contents, etc., may be so great as to continue the excess temperature long after the rate of reception has been reduced. Again the room may be too cool, and the sunlight in its constant traverse may not linger for a time long enough to increase the temperature. Since the solar reception is not present at all hours there must in any event be an adequate auxiliary heating plant, so that

the only good that seems to be available about solar heating through windows is a possible reduction in seasonal fuel cost.

It is evident that any room having windows except those facing north always has received heat in winter from the sun and the fuel saving due to this reception has been realized, if automatic devices or careful humans, throttle the fire and thus prevent over-heating.

There has always been some difficulty in heating and cooling rooms, as to control of the temperature. The building keeps turning a different face to the sun and to the wind, so that constant readjustment of the heat input or removal is necessary for the rooms on each orientation. The basic answer to this situation is to provide a heating and cooling plant capable of varying the rate of heat supplied to or removed from any room independently of the rate of heat at the same time for any other room. Then if every room has a thermostat to do the controlling, reasonably satisfactory results can be attained.

However it is not commercially feasible, especially in residence heating and cooling, to have a separate thermostat in every room. The tendency is to install apparatus for these smaller plants which can deliver air or can transfer heat only at one temperature for the whole house. Then comes the fun of deciding where in a house to locate the all-important thermostat that controls the boiler, furnace or refrigerating system. Sometimes there is a central hall, never exposed to direct sunlight, in which a reasonably successful thermostat can function. Frequently, however, the condition of heat input which suits the hall causes one or more of the other rooms to be too warm in the forenoon and too cool in the afternoon.

The best answer to this difficulty, and one which is receiving increasingly favorable attention, is to control the heating plant by a thermostat placed in the shade, or out of doors, perhaps hitched up electrically with another thermostat against a radiator or in a warm air duct. Then if the distribution of heat to the various rooms is reasonably well balanced, there will be little overheating in any room.

In the general heating of buildings there will be, I hope, an end to the built-in convectors made of finned or gilled sheet metal, circulating air within the room and depositing the dust on the walls above the warm air outlets. These unfortunate devices lack the virtues of the old sectional cast-iron exposed radiators in that the latter give off beneficial radiant heat and continue to do so even if the surface temperature approaches that of the air in the room. The dirty convector, however, commences to lie down on the job as soon as the temperature of the tubes and gills falls below 212 degrees

and this type of heat transmitter might as well not be present with water at 150 degrees. This is because there remains not enough temperature difference to bring about an adequate thermally induced air circulation in the room.

There will doubtless be increased employment of mechanical air circulation as exemplified in convectors combined with electric fans, popularly spoken of as unit heaters. The facility with which unit heaters can be controlled with relatively inexpensive electric thermostats and the high rate of transmission inherent to their design militate strongly in their favor.

STRUCTURAL STEEL STANDARD

by T. R. HIGGINS, C. E.

Approval of the American Standard for Structural Steel (Riveted, Bolted, or Welded Connections), A57.1-1943, as one of a related series of basic standards having to do with building code requirements, marks an important milestone towards the goal set by the American Standards Association to develop standards for all the subjects commonly included in municipal building regulations.

Most post-war programs assign such an important role to new construction that the modernization and standardization of all of these building regulations is highly deserving of early attention. Nearly all students of our national economy are in agreement that lack of uniformity among the hundreds of building codes now in force and, in many cases, failure to keep abreast of modern trends and developments have placed a serious handicap on the construction industry. Now that we appear to be approaching a period in which a large volume of construction will be required—almost all of which will come within the jurisdiction of local building codes—action is imperative.

Oddly enough, the movement for greater standardization in the structural steel fabricating industry, the fruits of which have been given recognition by the American Standards Association in the midst of World War II, owes its beginning largely to experience gained in World War I. For it was the pressure for more and more production during that emergency which focused attention upon the handicaps resulting from a lack of uniformity in design and fabricating practice. To be sure, considerable progress had been achieved in the field of bridge engineering. But it was obvious that, in a number of ways, the practice with respect to buildings was, of necessity, far from analogous with that which had been developed for bridges.

In view of the industrial climate which existed at the close of the last war and which was so largely responsible for the Institute's Specification for the Design, Fabrication, and Erection for Structural Steel—a climate in which all important industrial practices were being studied with an eye to insuring the maximum industrial output in the event of a future war emergency—it may at first seem strange that when the present emergency did arise it was

Condensed from an article on "Structural Steel Standard Its Milestone in Building Program."

not the Standard Specification which was finally to govern the use of structural steel but a National Emergency Specification. Yet, when all the facts are considered, it will be seen that the objective fixed in those early post-war years did, in fact, fulfill expectations when the emergency arose.

In the first place much of the construction required in this war had already been engineered prior to the developments requiring the adoption of the War Production Board's Emergency Specifications. And, thanks to the standardization which had been achieved in the intervening years, none of the confusion with respect to design and fabricating practices, experienced in the earlier emergency, existed at this time.

STRESSES CHANGED TO CONSERVE STEEL

As a matter of fact, in only one important respect does the Emergency Specification differ from the Institute's standard specifications. Because of the unprecedented demand for steel generated by the gigantic war program, it became necessary to conserve this vital material wherever possible. The established working stresses for structural steel, therefore, were increased in the Emergency Specification, in some cases by as much as 20 per cent, so that, by assigning more work to a given amount of steel, an over-all saving would be realized. Such a contingency could hardly have been antici-

pated prior to the war; in fact it did not arise until the construction part of the war program was well advanced. And, even had it been foreseen, it is debatable whether any widespread support would have been given a proposal to adopt the higher stresses in advance of the emergency which dictated their use.

It may be of interest to note that, when this situation became apparent, the War Production Board, acting through the organization already set up by the American Standards Association and assisted by the affected branches of the armed services, was able to provide emergency regulations in a remarkably short space of time. Only because of the vast amount of study which had already gone into the development of nation-wide standards to cover the activities of this vital industry was such speed made possible. And, only because the quality of the product of this industry had been enhanced through unification of practice was there sufficient assurance of safety when, in order to economize to the utmost on the use of this precious commodity, working stresses were increased to a limit some 50 per cent higher than that which was in use during the last war.

Thus, in a period of but two decades, this movement for standardization had made a truly great contribution in making America strong.

WHAT'S ON YOUR MIND?

ARCHITECTS—YOUR OPPORTUNITY

Editor,

Architect and Engineer:

One of our clients, a large paper manufacturer, is preparing a series of very elaborate booklets on post-war developments.

Their next book in the series will be on Buildings—Public and Institutional—such as hospitals, libraries, office buildings, museums, etc., and will include therein all of the advancements that will be made in such buildings in the future.

We have been given the assignment of collecting the material for this publication. If you have photographs of buildings you would like to have appear, please send same with a short description and credit line you wish used.

If you could make any suggestions as to where we would obtain materials of this type, we would greatly appreciate sources.

Thanking you in anticipation of your cooperation, we are

Sincerely yours,

The National Research Bureau, Inc.

V. PLESSCHER, Research Director.

320 N. LaSalle Street,

Chicago, Illinois.

COMPETITION DATE EXTENDED

Editor,

Architect and Engineer:

Your January issue contained an advertisement entitled "Competition for Sanatorium in Ireland." The advertisement stated that "applications should be received not later than the 13th of March, 1944."

I am now informed by my Government that the date of application for conditions has been extended to May 31, 1944. I am also advised that the closing date for the receipt of drawings is June 30, 1945.

I should be glad if you would give publicity to the above change of dates in your next issue.

Yours very truly,

MATTHEW MURPHY,

Consult.

San Francisco.

CREDIT FRANK L. HOPE, ARCHITECT

Editor,

Architect and Engineer:

In reading over the February issue of Architect and Engineer, to which I have been a subscriber for some time, I notice an article regarding the long span wood roof trusses for the Ryan Aeronautical Company, San Diego, California.

I was quite surprised to notice that the names of the architect and engineer were not mentioned, especially as your magazine is supposed to represent the architectural and engineering profession. I think that if you will check on the information as origi-

nally received you will find that Frank L. Hope, Jr. was the architect and Stanley Burne was the engineer.

Sincerely yours,

FRANK L. HOPE, JR.,

Architect/Engineer.

San Diego.

END "OR EQUAL" CLAUSE

Editor,

Architect and Engineer:

I would like to take this opportunity to call your special attention to the work of the Producers' Council in developing and publicizing an improved Bidding Practice for Building Materials. This new procedure was approved at the annual meeting held in Detroit in 1942, and following that was placed before the American Institute of Architects' Committee on Contract Documents, which concurred with the idea and brought it before the A.I.A. convention in Cincinnati last year, where they adopted the plan. The whole idea has been wrapped up and packaged in the form of a pamphlet, important passages of which are:

"1) All basic bids are to be based on exactly the same materials and equipment, thereby being truly competitive.

"2) The specifier may name one or several makes of a particular building product, but if more than one, he indicates which one is to be used as the basis for the regular bid.

"3) The specifications also permit any bidder to submit an alternative price on any other named or unnamed material or equipment which he thinks will meet the requirements. He does so by submitting what additions or deductions from his basic bid should be made if such alternates are used."

Members of the local Chapters of the A.I.A. and the Producers' Council have expressed themselves as being interested in seeing something like this used in place of the time-worn—and shop-worn "Or Equal" method.

Yours very truly,

C. W. KRAFT.

San Francisco.

Editor's Note—To put the plan in operation, meetings will be sponsored by local Chapters of the Council in twenty-one Council cities so that the details may be considered by architects, engineers, contractors and others.

AIR RAID SHELTERS

Editor,

Architect and Engineer:

I think Helen Stewart has something when she suggests that architects, in their post-

war apartment house planning, make provision for a glassed-in soundproof room in every apartment. Such provision should sound the death-knell for the "no children wanted" rent signs.

And permit me to add another suggestion for architects. In the years after the war, when new buildings, houses, subways, etc., are being built, why not incorporate air raid shelters and first aid stations as a part of this new construction? The added expense would be small and we would at least have the satisfaction of feeling prepared in case of another Pearl Harbor.

ROSS THOMAS,

Oakland.

DISAPPOINTED IN THE JOURNAL

Editor,

Architect and Engineer:

Your question regarding what happens to the Weekly Bulletin under the unification plan is one that has been asked by several people. The Bulletin will continue just as before, as will the Michigan Society of Architects, except that the Society will be made up of directors from Chapters of the Institute instead of from Divisions of the State Society.

What do you think of the new Journal of the A.I.A.? Frankly, I was greatly disappointed, as this subject had been one of great interest to me, and I had made some definite recommendations for it. After serving on a committee to formulate it, the Board did just about everything that I didn't want done. I see that they are now issuing separate Bulletins to inform the members of official matters. Why this should be necessary is more than I can see.

Very truly yours,

TALMAGE C. HUGHES.

Detroit, Michigan.

ARCHITECT'S PRESENT QUALIFICATIONS

"There is of course every reason for the architect to be a good citizen and, particularly at present, that means study of all of the problems of these changing times. He needs to know something of the character and cost of municipal services as affected by real estate development, something about taxation. He needs to have a detached, informed and fair point of view as to the best way to spend public money. He should not be too much influenced by reformers and "better world" advocates who do not care where the money comes from. An illiterate and civically inexperienced architect is not likely to be very effective as a leader in bringing forth a better society by mere assertion of his importance."

—CHARLES W. KILLAM.

ENGINEERS AND ARCHITECTS ASSOCIATION

Frank A. Mouritsen, associate director of disputes of the War Labor Board, was the principal speaker at the February 24th meeting of the Engineers and Architects Association in Los Angeles. His subject was "Collective Bargaining Processes, Present and Future."

Much discussion has followed the recent talk on "Materials For the Post-War Era," by Dr. David E. Adelson, research chemist for the Shell Oil Company and International vice-president of the Federation of Architects, Engineers, Chemists and Technicians, C.I.O. affiliate.

Dr. Adelson suggested plant adaptation for our Western aluminum and magnesium metal production where the process cannot compete, to produce oxide paint fillers and alloy material. He recommended that organizations turn a part of their effort to channelling the thought of their members to place the emphasis on our present basic material output to convert the supply to beneficial uses. Dr. Adelson also outlined the benefits accruing to organized employees of certain companies through participation in the pooling of their patent rights by virtue of collective bargaining contracts.

Mr. Green, chairman of the qualifications committee of the local section of the American Society of Civil Engineers, outlined the Society's present position in collective bargaining to date. He stated that the Los Angeles Section had voted 337 to 16, in favor of the Section embarking upon some plan of collective bargaining. The Section is now endeavoring to determine a line of procedure to solve the economic problem of the engineer.

* * *

The Federation of Architects, Engineers, Chemists and Technicians, Chapter 25 (CIO) was named bargaining agent for employees of the Cutter Laboratories, Fourth and Parker streets, Berkeley, at a consent election held February 20. The vote was 308 for the union to 112 for an open shop.

STRUCTURAL ENGINEERS MEET

Regular meeting of the Structural Engineers Association of Northern California was held at the Engineers' Club, San Francisco, March 7, with a good attendance. The speakers were Rex Nicholson, Western Regional Director, Federal Works Agency, whose subject was "The Construction Industry Can Lead the Way," and Louis Lundberg, General Manager of the San Francisco Chamber of Commerce. Mr. Nicholson is from Texas and is a general contractor. He is well informed on problems pertaining to the construction industry in the Western States, as his address indicated. Mr. Nicholson has recently been invited to head the post-war program for the Federal Works Agency for the entire United States. Mr. Lundberg's talk had to do with post-war markets and conditions in the Bay

area. An enjoyable evening was rounded out with a few remarks by John Reeber who presented an exhibit of the Reeber plan.

WHO WAS THE ARCHITECT?

The following notice appeared recently in several issues of the San Francisco Chronicle:

INFORMATION NEEDED

Regarding whereabouts of lady who wore a silver fox scarf together with a BIZARRE TULLE HAT with a large feathered bird between the hours of 8 and 11 P. M., on the evening of DECEMBER 10.

She spent this time at a popular bar and at a legitimate theatre in the company of a prominent architect.

She has information of the most extreme importance to our client without being aware of this.

This man guarantees that the utmost discretion will be used and that it is not his purpose to in any way do anything which will be embarrassing to her.—BOX 667.

Our guess: A publicity stunt for the new moving picture "Phantom Lady."

ARCHITECTS MOVE

John S. Butler has moved from 8920 Olympic Boulevard, Beverly Hills, to 555 Tigertail Road, Los Angeles.

Roland E. Coate has moved from 701 Architects' Building, Los Angeles, to 305 Canterbury Lane, Birmingham, Alabama.

Nathan Coleman, from 2088 Mountain Boulevard, Oakland, to R.F.D., Lafayette, California.

Mario F. Corbett, from 11 Star Route, Redwood City, to 50 Edwards Avenue, Sausalito.

Arthur Froehlich, from 441 North Beverly Avenue, to 2244 Beverly Glen Place, Los Angeles.

Edward Glass, 1350 Filbert Street, San Francisco, has moved to 965 Union Street, same city.

C. Harold Hopkins has moved from 416 West Eighth Street, Los Angeles, to 1707 East Bay Avenue, Balboa, California.

Albert O. Treganza, from 25 Kemp Street, San Diego, to Box 97, Lemon Grove, California.

Walter E. Wagner, from 1221 Blake Street, Berkeley, to 775 Vincente Avenue, Albany, California.

TESTING MATERIALS ENGINEERS MEET

Members of the Northern California District, American Society for Testing Materials, gathered at the Engineers' Club, San Francisco, Wednesday evening, March 15, to welcome Dean Harvey, president, and C. L. Warwick, secretary-treasurer of the Society. Harvey made a splendid talk on "The Place of the National Engineering Society in Industry," citing some of the new accomplishments in the field of materials and their post-war possibilities. Mr. Warwick reported on general activities of the Society. Theo P. Dresser, Jr., is secretary of the Northern California District Committee.

**MEMBERSHIP DRIVE
BY SO. CALIF. CHAPTER
E. T. SPENCER HONORED**



At the February meeting of Southern California Chapter, A.I.A., the following committee was named to conduct a three-year membership drive in line with a national movement of the Institute to increase the corporate membership of the A.I.A. to at least 80 per cent of all qualified architects: Charles Matcham, Henry Withey, Warren Dedrick, Richard Farrell, Stanley Gould, Vincent Palmer, Byron J. Tharaldson, Henry Eggers, Breo Freeman, Howard Morgridge, and Herbert Riesenberg.

Herbert J. Powell, assuming the office of president of the Chapter, had his baptism under parliamentary fire and came through with flying colors. With the intent of adding more interest and practical value to the meetings, Mr. Powell suggested the reading of selected papers on technical subjects related to architecture, such as "Standard Details, Specifications, Drafting Room Short Cuts, etc."

The annual convention of the Institute will be held this year at Indianapolis, Indiana, on May 3, 4 and 5. Members nominated by the executive committee, from which eight or nine will be selected to attend the convention, are: Herbert J. Powell, Paul R. Hunter, John C. Austin, Welton D. Becket, Theodore Criley, Jr.; Henry Eggers, Stanley Gould, John Landon, Samuel Lunden, Earl Heitschmidt, Winston Risley, Whitney Smith, Paul R. Williams, and Adrian Wilson.

The speaker of the evening was C. Julian Oberwarth, Institute membership secretary. Among other things, Mr. Oberwarth said that membership in the American Institute of Architects is now over 4000, raised from 3000 in the last two years.

NORTHERN CALIFORNIA CHAPTER

Northern California Chapter showed its appreciation of the fine leadership of its 1943 president, Eldridge T. Spencer, by holding him for another year. The Chapter is gaining in membership and its meetings are being well attended.

President Spencer is a native of California and a graduate of the University of California in Berkeley. He served as a first lieutenant in the Army Air Corps in World War I. Other honorary positions to which Mr. Spencer has been called includes the presidency of the board of directors of the San Francisco Art Association. Mr. Spencer is married to Jeanne Dyer, well known in San Francisco art circles.

STAY PUT, YE ARCHITECT!

A doctor can move to a brand new town,
Buy out a practice and settle down;
When a minister moves from one spot to another
All whom he meets just call him "Brother."

An author can live in most any place,
His troubles are not with the human race,
('Course a banker or lawyer would never dream
Of walking away from a moneyed stream!)

Plumbers, carpenters, or chaps from the farms
Are welcomed anywhere with open arms.
It's only the architect, so far as I know,
Whose moving can deal him a body blow.

Why did he change? What building fell down?
Why should he leave the old home town?
Has he run off with somebody's wife?
His clients' funds? Oh, rumors are rife!

It surely could never, never be
That he would just like California to see!
The lure of the sun, the charm of the new
Might teach him better houses to do.

And if California does him beguile
So he decides to stay quite a while,
We hope that you will help us pray
For the soul of an architect . . . gone astray!

SEWALL SMITH, A. I. A.

Editor's Note—Cornell University graduate, Sewall Smith recently moved to California from Niagara Falls, N.Y., where he practiced architecture for eight years. Besides many fine homes, Smith designed the Niagara Falls transmitting station and studios for WHLD. Following a brief stay in Palo Alto, Mr. Smith and Mrs. Smith, who is a sister of Major General Sibert, Stillwell's first assistant, have permanently settled in Lafayette where they have purchased a home. Mr. Smith expects to divide his time between Lafayette and San Francisco.

S. F. ARCHITECTURAL CLUB

At the April 5th meeting of the San Francisco Architectural Club, Fred Barss, architect, will speak on the subject, "Housing with Relation to City Planning." Mr. Barss, formerly in the office of William Wurster, has delved deep into the study of this vital subject and invites discussion.

Leland Hyde, designer with Henry Kaiser and recently returned from the East, will relate some of the highlights of his trip.

Club quarters at the Builders' Exchange have been rearranged to the surprise and delight of the membership. Pool and billiard tables are now set up.

THE "SACRED COW" IS DYING

The "Sacred Cow" of the electrical industry—No. 14 wire—long venerated as the answer to any wiring need, seems ready for an early demise.

Adequate a quarter of a century ago, when there were fewer appliances and less demand on electrical service, No. 14 wire today is inadequate to cope with the electrical necessities of modern living. It has been found too small for high voltages of lamps and appliances now being used, a condition which is certain to be aggravated when still higher voltages appear on the postwar markets.

Adequate capacity wiring for maximum electrical convenience will be a "must" on blue prints of the future. Architects and builders who foresee and supply this need will enjoy a reputation for satisfied, enthusiastic clients.

NORTHERN CALIFORNIA ELECTRICAL BUREAU

1355 Market Street
San Francisco

*Electricity is vital for war production.
Use it carefully and without
waste.*



SYRACUSE UNIVERSITY SCHOLARSHIPS

Syracuse University announces the following scholarships available to entering students in the School of Architecture:

One \$400 and four \$200 scholarships to be granted by competition on Saturday, July 15, 1944. The competition will be in two fields—drawing and preparatory school record. (1) Contestants must send to the College of Fine Arts not later than Thursday, July 6th, a portfolio containing not more than 20 examples of their work in free-hand and mechanical drawing, together with three letters of recommendation as to personality, character and general fitness. Judging the drawing by a committee of the Architectural Faculty will take place on Saturday, July 15. (2) The High School records of all contestants will be carefully examined by the Director of Admissions and the Architecture Faculty Committee to determine fitness for a course in architecture. Special attention will be given to ability in high school mathematics.

Each portfolio of drawings, etc., must contain the name and address of the student contestant and a statement from the student's high school principal that the drawings, etc., in the portfolio are the original work of the student submitting them. All portfolios sent in by art and architecture contestants will be returned after the contest by express collect unless other arrangements are made with Dean H. L. Butler.

STRUCTURAL ENGINEERS' NOTES

James E. Mackie, C.E., of San Francisco, recently attended a technical conference of the U. S. Forests Products Laboratory on "Glued Laminated Lumber Standards" at Madison, Wisconsin, and on to Washington, D. C.

D. C. Willett has been in Texas with his family where Mrs. Willett christened a new destroyer, the S.S. Kenneth M. Willett, named in honor of their son.

Frank A. Johnson, of SEAOSC, has returned to Sacramento as supervising structural engineer in charge of design for State institutions, Department of Architecture.

A. L. Enger, also a former member of SEAOSC, is now in the Capital city as office engineer, Structural Section, in charge of the School Section, Department of Architecture.

Harry W. Bolin, member of San Francisco Section on leave, has been with the Navy at San Diego. He was supposed to be returned to the Los Angeles office, State Department of Architecture, on February 1, but the Navy refused to release him.

William Adrian and Mrs. Adrian have been sending some interesting postal cards to their San Francisco friends from Mexico City.

Messrs. Hall & Pregnoff have moved from 350 California Street, to 251 Kearny Street, San Francisco.

H. J. Brunner is not only treasurer and director of the California State Automobile Association, but is secretary of the Commonwealth Club.

PRODUCERS' COUNCIL PAGE

Northern California Chapter

The National Organization of Manufacturers of Quality Building Materials and Equipment
Affiliated with the AMERICAN INSTITUTE OF ARCHITECTS



GEORGE QUAMBY

Vice-President, George Quamby, is no newcomer to Council activities, having served as a committee member in past years on the important Program Committee.

Canuck George was born in Windsor, Ontario, in 1897, where he went to school at Windsor Collegiate Institute. His was another bud-

ding architectural career nipped by World War I. After 18 months' service in France with the 25th Engineers Corps, First Army, George returned home, then got a job across the river as estimator and draftsman in the Fenestra Division of Detroit Steel Products Company.

Upon graduating from the company's specialized school for branch engineers, he was sent to San Francisco in 1921, where he was branch engineer until 1925, when the district office was formed at the plant in Emeryville. George then became district engineer. In 1929 he was transferred to sales in the San Francisco area and at the present time has charge of Fenestra window sales in San Francisco, and marine products in all of the Bay area.

Fighting this war out on the home front, George's outside interests have centered particularly on Civilian Defense activities and American Legion affairs.

Home is in the Parkside District of San Francisco where he lives with his wife and daughter.

Says Gordon Hay, national vice-president of the Council, "After the last war there was such a flood of new materials—some very good, some not so good and some very rotten—that the architects, in their desperation, asked the manufacturers to fashion some instrument through or by which the architect would know the 'wheat from the tares.' And so—the Producers' Council."

How like the situation we are coming into again, when some manufacturer will "reconvert" not to products they manufactured before the war, but to fields new and untried for them, with much experimentation on the public.

The Architects may well be expected to place even greater reliance on the integrity of members of their Affiliate in the days ahead.

What's More, as a practical expression of our foresight, don't forget

Gano Baker leaves the Bay area with the well-wishes of many friends ringing in his ears. Out of sight, but not

out of mind, we expect that Gano will not be long in crowding us from the South and other aggressive Angelenos. On February 18, Gano became manager of the Los Angeles Branch of Westinghouse Electric Elevator Company.

Art Skaife shouldn't be overlooked in the deal, as tolerant and unenviable a boss as a man ever had. Art carries on in San Francisco with expanded duties as Pacific Coast manager for the eleven Western States; in fact, Art isn't just sure how many he has under his wing.

The Annual Meeting has been set for Indianapolis, May 3, 4 and 5, to be held concurrently with the Annual Convention of the A.I.A. More than ever before this gathering will see a merging of the activities of the two groups throughout the meeting. The tentative program calls for a joint dinner as well as a joint session.

Company Channels will be used to acquaint branch office personnel with your company's policy on the new bidding practice for building materials, eliminating the "Or Equal" clause. This has all been buttoned up by the Technical Cooperation Committee and presented in pamphlet form.

Council Doing Something about "Construction In the Post-War Economy." Under that title President Doug Whitlock presented a statement based on the Council's post-war program, to the Committee of Public Buildings and Grounds of the House of Representatives, on January 27.

Congratulations are in order to the entire Chapter on the nice turn-out at our monthly meetings and special mention should be given Harry Lemos on his conscientious and systematic reminder system.

(Turn to Page 40)



USE QUALITY PRODUCTS CONSULT AN ARCHITECT



Are You Interested in whether any one else goes or not? You are asked to make just one phone call. How long since you had an architect, engineer or other guest to a monthly meeting? Share these interesting and instructive meetings with a friend outside the Chapter—bring a guest **every** time.

The Journal of the American Institute of Architects supersedes "The Octagon." Pocket size in format, the Journal differs from its predecessor in that it will accept up to 12 pages of advertising. Dedicated to the conviction that the post-war need for the architect will be greater than ever, Vol. I, No. 1 came out in January to help the architect to a clearer understanding of the road ahead.

We Started to tell you about the Council's definite, tangible 21-point program for Post-War Planning back in December, but since that time it has gotten crowded off the "Page." Following a six-point program to facilitate reconversion to peace time economy, the next section deals with how To Expedite Technical

Advancement—

1. Building Product Development
2. Dimensional Co-ordination
3. Revision of Building Codes
4. Reduction of Costs
5. Merchandising
6. Responsibility for Authentic Information

TO END "OR EQUAL" CLAUSE

As a means of improving competitive bidding practices in the construction of homes, factories, and other building projects and of preventing dissatisfaction on the part of ultimate owners, the Producers' Council, national organization of manufacturers of building materials and equipment, proposed a new "Bidding Practice for Building Materials" to replace the controversial "or equal" clause commonly used in the past. (See Mr. Kraft's communication on page 35.)

The plan has been approved in principle by the American Institute of Architects, according to the announcement by F. J. Plimpton, chairman of the Council's technical co-operation committee, and is recommended for general adoption by architects, engineers, contractors, sub-contractors, material concerns, and others involved in bidding on construction projects.

"Use of the 'or equal' clause," the announcement explained, "has permitted contractors and sub-contractors to figure their bids either on the makes of building products named in the specifications or on other products which they consider acceptable as offering equal quality and value. In many instances, this practice results in differences of opinion as to whether the alternative material or equipment actually is of equal quality and too often results in the use of a lower quality of product than the owner had intended to purchase.

BUILDING PERMITS UP

January building permits in the United States showed an upward swing with a 17 per cent gain over a year ago. According to Dun & Bradstreet, the twenty cities in the U. S. with the greatest permit valuations during January are listed below. Los Angeles with almost \$3,000,000, had the largest amount. Detroit, Long Beach, Chicago, and San Diego followed in the order named.

	January 1944	January 1943
Los Angeles, California	\$2,963,654	\$1,714,039
Detroit, Michigan	2,452,660	1,704,889
Long Beach, California	2,042,275	884,760
Chicago, Illinois	1,500,768	712,730
San Diego, California	1,310,708	105,480
Dallas, Texas	1,217,017	158,921
Oakland, California	1,155,881	920,485
Portland, Oregon	963,495	2,042,905
Seattle, Washington	875,035	350,705
Cleveland, Ohio	858,000	422,700
San Francisco, California	830,080	132,484
Memphis, Tennessee	705,600	80,954
Philadelphia, Pennsylvania	616,600	363,640
St. Louis, Missouri	522,906	137,200
Houston, Texas	488,200	125,565
New Orleans, Louisiana	477,180	67,658
Akron, Ohio	433,074	352,146
Hartford, Connecticut	418,256	119,600
Dayton, Ohio	370,655	97,195
Washington, D. C.	359,770	2,728,718

NEED FORESEEN FOR ARCHITECTS

Plans for expansion and development of the Columbia University School of Architecture in the post-war period have been presented to President Nicholas Murray Butler in the annual report of Dean Leopold Arnaud of the architectural school.

Demands for trained architects for reconstruction work will be hard to meet in view of the 75 per cent drop in registration during the war years, Arnaud said, and will place a heavy burden on all schools for several years after the war.

Though it may be necessary to continue the present shortened course to meet these demands, Arnaud said, the faculty is "unanimous in its belief that this system of instruction is very poor and must be discontinued as soon as possible.

Arnaud recommends that the University plan a new building to house the school and its libraries in view of the anticipated enrollment increase. He also urged that training of landscape architects be included in the regular course and studies to replace the certificate now offered.

HEADS ENGINEERING DEPARTMENT

Dr. Kenneth C. Reynolds of Massachusetts Institute of Technology, nationally known for his studies in hydraulic engineering, has been appointed head of the department of civil engineering at Cooper Union with the rank of full professor, it is announced by Dr. Edwin S. Burdell, director of the Union. He succeeds Professor Edward S. Sheiry, who has resigned.

PLANS POST-WAR EXPANSION

One of the first steps in carrying out the present ambitious post-war expansion plans of the Hammel Radiator Engineering Company of 3348 Motor Avenue, Los Angeles, was the appointment of L. M. Hull as sales manager of the heating division.

Mr. Hull, a heating engineer with long experience in the design and merchandising of gas and oil heating equipment, has been especially assigned to the job of developing post-war heating equipment and laying plans for national extension of the company's sales activities. His previous experience with Payne Furnace & Supply Company and Pacific Gas Radiator Company is well known to the trade.

Hammel Radiator Engineering Company is a co-partnership in which A. S. Martinson and S. D. Crozier are the principals. Recently this company took over the plant facilities and manufacturing business of the Hammel Radiator Corporation of which Mr. Martinson was vice-president and general manager. The company has been active in the manufacture of gas heating equipment in California since 1912. Present activities of the plant are devoted largely to war work plus the manufacture of the Hammel oil burning dual type wall furnace for defense housing.

CHEAP ELECTRIC POWER

At a huge public meeting at Redding, California, Regional Director Charles E. Carey of the U. S. Bureau of Reclamation offered electric power from the Central Valley Project to the city at five mills per kilowatt hour. This figure is 2½ mills cheaper than the price the city now is paying the Pacific Gas and Electric Company.

In outlining the background of the negotiations with the Redding City Council, Mr. Carey said that "from the very beginning the Bureau of Reclamation proposed that Redding adopt the principles of distributing power at cost, first for the benefit of the citizens of Redding and, second, as a base for negotiating a contract with the Bureau of Reclamation for its power supply."

DAVID KNICKERBOCKER BOYD

David Knickerbocker Boyd, member Emeritus and Fellow of The American Institute of Architects, collapsed in his Philadelphia office on February 21, and died shortly afterwards in Hahneman Hospital. He was 72 years old.

Mr. Boyd was a graduate of Friends' Central School in Philadelphia and attended the University of Pennsylvania, the Pennsylvania Academy of the Fine Arts and the Spring Garden Institute.

Mr. Boyd was a lecturer and writer on construction economics, a consultant on building codes and during the last war he was chief of the Materials Information Section of the U. S. Housing Corp., Washington.

Following World War I, he originated and organized the Structural Service Bureau. He was a member of many national and local professional organizations.

Distinctive Lighting Fixtures



CHANDELIER IN CHAPEL OF TEMPLE EMANUEL, SAN FRANCISCO

Michael Goodman, Architect

EXECUTED BY

WESTERN LIGHTING FIXTURE CO.

Designers and Manufacturers of
HIGH GRADE LIGHTING FIXTURES
BRONZE WORK AND MIRROR
FURNITURE

★ ★ ★

**WESTERN LIGHTING
FIXTURE COMPANY**

E. J. FLETCHER

WM. H. HOLLOPETER

**70 IVY STREET
SAN FRANCISCO**



QUALITY AND DEPENDABLE *Service*

are the factors that influence architects and contractors when selecting lumber and mill work — Quality of merchandise — Integrity and Ability of the firm—Service in physical equipment — Experience and Personnel — All these factors contribute to a speedy and satisfactory completion of construction with minimum of time and expense.

MANUFACTURER OR DEALER IN

Douglas Fir—Redwood—Sugar and Ponderosa Pine — Plywood and Concrete Form Panels — Sash and Doors — Millwork — Insulation — Builders' Hardware.

E. K. WOOD LUMBER CO.

"Goods of the Woods" ©

LOS ANGELES • SAN FRANCISCO • OAKLAND

PARAMOUNT Built-In Fixtures

USED IN MANY OF
THE BETTER WAR
HOUSING PROJECTS
ARE DESIGNED TO INSURE
MAXIMUM EFFICIENCY AT MINIMUM
COST

PARAMOUNT FIXTURES are recognized by architects and builders for their distinctive appearance and superior workmanship.

BUILT-IN FIXTURE COMPANY
5107 Broadway, Oakland, California
Phone FIdelmont 8100

BUILDING MATERIALS FOR FARM NEEDS

Building materials for the maintenance and replacement of essential farm structures must be provided in greater quantity in the immediate future if maximum production of food and other vital agricultural products needed in the war program is to be assumed, according to James W. Follin, managing director of The Producers' Council, national organization of manufacturers of building materials and equipment.

Reports from many sections of the country indicate that farm buildings are deteriorating rapidly, owing to difficulties in obtaining materials with which to make repairs, while the construction of new barns, poultry houses, and other needed farm buildings has been held at a low level for two years as a result of limitations placed on non-military construction by the Federal government, Follin said.

To assist in making plans for meeting current farm building needs and to aid in establishing a sound post-war building program for the nation's farmers, the Producers' Council has appointed a Farm Building Committee with Chris L. Christensen, Vice President of the Celotex Corporation and formerly Dean of Agriculture at the University of Wisconsin, as chairman.

STILL MOVING AROUND

Bernard R. Maybeck has moved from 2751 Buena Vista Way, Berkeley, to Twain Harte, Tuolumne County, California.

Earl J. Osborne has moved from 1910 California Street, San Francisco, to 907 Kohl Building, 486 California Street, San Francisco.

Olive K. Chadeayne from Rancho Santa Fe, California, to 14160 Erwin Street, Van Nuys.

William Allen & W. George Lutz have moved from 5655 Wilshire Boulevard to 6112 Wilshire Boulevard, Room 200, Los Angeles.

Henry W. Howell's new address, formerly Box 54, Salt Lake City, Utah, now Box 1273, Santa Barbara.

S. E. Sommichsen from Halethorpe, Maryland, to 7308 Plankinton Building, Milwaukee, Wisconsin.

Julian F. Everett has moved from Vista, California, to 4811 Keniston Ave., Los Angeles.

GLASS TANK USES

One of the most important advances in the glass industry has been the recent remarkable development of glass tanks or vats, for industrial use, according to R. B. Tucker, a director of the Pittsburgh Plate Glass Company. Dozens of industries are turning to glass for their tanks, and the installation of new tanks and the relining of existent units with glass is increasing rapidly, according to Mr. Tucker. Because the glass used for these tanks is tempered and strengthened, making for permanency, he believes the acceptance of readily installed glass tanks will be widespread in the post-war period.

ARCHITECT AND ENGINEER

Estimator's Guide

Giving Cost of Building Materials, Etc.

AMOUNTS GIVEN ARE FIGURING PRICES AND ARE MADE UP FROM AVERAGE QUOTATIONS FURNISHED BY MATERIAL HOUSES TO SAN FRANCISCO CONTRACTORS. 2 1/2% SALES TAX ON ALL MATERIALS BUT NOT LABOR

All prices and wages quoted are for San Francisco and the Bay District. There may be slight fluctuation of prices in the interior and southern part of the state. Freight cartage, at least, must be added in figuring country work.

BONDS—Performance—50% of contract.
Labor and materials—50% of contract.

BRICKWORK—

Common Brick—Per 1M laid—\$50.00 to \$60.00 (according to class of work).
Face Brick—Per 1M laid—\$120 to \$150 (according to class of work.)
Brick Steps—\$1.60 per lin. ft.
Brick Veneer on Frame Bldg.—Approx. \$1.30 per sq. ft.
Common Brick—\$19.00 per M, truckload lots, f.o.b. job.
\$19.00 per M, less than truckload, plus cartage.
Face Brick—\$40 to \$80 per M, truckload lots, delivered.
Cartage—Approx. \$4.00 per M.

BUILDING PAPER—

1 ply per 1000 ft. roll.....	\$3.50
2 ply per 1000 ft. roll.....	5.00
3 ply per 1000 ft. roll.....	6.25
Brownskin, Standard, 500 ft. roll.....	5.00
Sisalcraft, 500 ft. roll.....	5.00
Sash cord com. No. 7.....	\$1.20 per 100 ft.
Sash cord com. No. 8.....	1.50 per 100 ft.
Sash cord spot No. 7.....	1.90 per 100 ft.
Sash cord spot No. 8.....	2.25 per 100 ft.
Sash weights, cast iron, \$50.00 ton.	
Nails, \$3.42 base.	
Sash weights, \$45.00 per ton.	

CONCRETE AGGREGATES—

The following prices net to Contractors unless otherwise shown.

Gravel, all sizes—		
\$1.95 per ton at Bunker; delivered	\$2.50	
	Bunker	Del'd
Top Sand	\$1.90	\$2.50
Concrete Mix	1.90	2.45
Crushed Rock, 1/4" to 3/4".....	1.90	2.50

Crushed Rock, 3/4" to 1 1/2".....	1.90	2.50
Roofing Gravel	2.25	2.80
River Sand	2.00	2.45

Sand—

River Sand	2.00	2.45
Lapis (Nos. 2 & 4).....	2.85	3.15
Olympia (Nos. 1 & 2).....	2.85	3.10
Del Monte White84c per sack	

Cement—

Common (all brands, paper sacks), carload lots, \$2.42 per bbl. f.o.b. car; delivered \$2.72.
Cash discount on carload lots, 10c a bbl., 10th Prox.; less than carload lots \$3.20 per bbl. f.o.b. warehouse or delivered.
Cash discount 2% on L.C.L.

Atlas White	} 1 to 100 sacks, \$2.50 sack	
Calaveras White		warehouse or del.; \$7.65
Medusa White		bbl, carload lots.

Forms, Labors average \$200.00 per M.
Average cost of concrete in place, exclusive of forms, 35c per cu. ft.; \$10 cu. yd.; with forms, 60c.
4-inch concrete basement floor 30c per sq. ft. || Ret-roofing | 7 1/2c |
| Concrete Steps..... | \$1.25 per lin. ft. |

DAMP-PROOFING and Waterproofing—

Two-coat work, \$3.50 per square.
Membrane waterproofing—4 layers of saturated felt, \$7.00 per square.
Hot coating work, \$2.50 per square.
Medusa Waterproofing, \$3.50 per lb. San Francisco Warehouse.
Tricoel waterproofing.
(See representative.)

ELECTRIC WIRING—\$12 to \$15 per outlet for conduit work (including switches).

Knob and tube average \$3.00 per outlet. (Available only for priority work.)

ELEVATORS—

Prices vary according to capacity, speed and type. Consult elevator companies. Average cost of installing a slow speed automatic passenger elevator in small four story apartment building, including entrance doors, about \$6500.00.

EXCAVATION—

Sand, 60 cents; clay or shale \$1 per yard. Teams, \$12.00 per day.

Trucks, \$22 to \$27.50 per day.

Above figures are an average without water. Steam shovel work in large quantities, less; hard material, such as rock, will run considerably more.

FIRE ESCAPES—

Ten-foot galvanized iron balcony, with stairs, \$150 installed on new buildings; \$160 on old buildings.

FLOORS—

Composition Floor, such as Magnesite, 33c to 50c per square.
Linoflor—2 gages—\$1.25 to \$2.75 per sq. yd.
Mastapa—90c to \$1.50 per sq. yd.
Battlefish Linoleum—available to Army and Navy only—1/6"—\$1.75 sq. yd.
3/8"—\$2.00 sq. yd.
Terazzo Floors—50c to 70c per square.
Terazzo Steps—\$1.75 per lin. ft.
Mastic Weer Coat—according to type—20c to 35c.

Hardwood Flooring—

Standard Mill grades not available.
Victory Oak—T & G
3/8 x 2 1/4".....\$143.25 per M. plus Cartage
1/2 x 2".....122.00 per M. plus Cartage
1/2 x 1 1/2".....113.50 per M. plus Cartage
Prefinished Standard & Better Oak Flooring
3/8 x 3 1/4".....\$180.00 per M. plus Cartage
1/2 x 2 1/2".....160.50 per M. plus Cartage
Maple Flooring
3/8" T & G Clear \$160.50 per M. plus Ctg.
2nd 153.50 per M. plus Ctg.
3rd 131.25 per M. plus Ctg.
Floor Layers' Wage, \$1.50 per hr.

GLASS—

Single Strength Window Glass.....	20c per sq. ft.
Double Strength Window Glass.....	30c per sq. ft.
Plate Glass, under 75 sq. ft.....	\$1.00 per sq. ft.
Polished Wire Plate Glass.....	1.40 per sq. ft.
Rgh. Wire Glass34 per sq. ft.
Obscure Glass27 per sq. ft.
Glazing of above is additional.	
Glass Blocks	\$2.50 per sq. ft. set in place

HEATING—

Average, \$1.90 per sq. ft. of radiation, according to conditions.
Warm air (gravity) average \$48 per register.
Forced air, average \$68 per register.

IRON—Cost of ornamental iron, cast iron, etc., depends on designs.

LUMBER—All lumber at O.P.A. ceiling prices—

No. 1 Common.....	\$49.00 per M
No. 2 Common.....	47.75 per M
Select O. P. Common.....	52.75 per M

Flooring—

	Delivd.
V.G.-D.F. B & Btr. 1 x 4 T & G Flooring	\$80.00
C 1 x 4 T & G Flooring	75.00
D 1 x 4 T & G Flooring	65.00
D.F.-S.G. B & Btr. 1 x 4 T & G Flooring	61.00
C 1 x 4 T & G Flooring	59.00
D 1 x 4 T & G Flooring	54.00
Rwd. Plastic—"A" grade, medium dry	82.00
"B" grade, medium dry	78.50

Plywood—

	Under \$200	Over \$200
"Plycord"—3/8".....	\$49.50	\$47.55
"Plywall"—1/4".....	45.15	43.30
3 ply—2 1/2" x 1/4".....	48.55	46.60
"Plyform"—5/8".....		
Uncoiled.....	126.50	121.45
Oiled.....	127.90	122.75

Above prices delivered if quantity is sufficient to warrant delivery.

Shingles (Rwd. not available)—

Red Cedar No. 1—\$6.75 per square; No. 2, \$5.75; No. 3, \$4.45.
Average cost to lay shingles, \$3.00 per square.
Cedar Shakes—Tapered: 1/2" to 3/8" x 25"—\$8.95 per square.
Resawn: 3/4" to 1 1/4" x 25"—\$10.65 per square.
Resawn: 3/4" to 1 1/4" x 25"—\$10.65 per square.
Average cost to lay shakes, \$4.00 per square.

MILLWORK—Standard.

O. P. \$100 per 1000. R. W. rustic \$100.00 per 1000 (delivered).
Double hung box window frames, average with trim \$6.50 and up, each.
Complete door unit, \$10.00.
Screen doors, \$3.50 each.
Patent screen windows, 25c a sq. ft.
Cases for kitchen pantries seven ft. high, per lineal ft., \$9.00 each.
Dining room cases, \$9.00 per lineal foot.
 Rough and finish about 80c per sq. ft.
Labor—Rough carpentry, warehouse heavy framing (average), \$40.00 per M.
For smaller work average, \$40.00 to \$55.00 per 1000.

MARBLE—See Dealers

PAINTING—

Two-coat work.....	per yard 50c
Three-coat work.....	per yard 70c
Cold water painting.....	per yard 10c
Whitewashing.....	per yard 8c

PAINTS—

Two-coat work.....50c per sq. yd.
Three-coat work.....70c per sq. yd.
Cold water painting.....per yard 10c
Whitewashing.....8c per sq. yd.
Turpentine \$1.03 per gal. in drum lots.
 \$1.08 per gal. in 5-gal. containers.
Raw Linseed Oil—not available.

Boiled Linseed Oil—\$1.38 per gal. in drums. Available only to work with high priority—\$1.48 per gal. in 5-gal. containers.

Use replacement oil—\$1.86 per gal. in 1-gal. containers.
Replacement Oil—\$1.20 per gal. in drums. \$1.30 per gal. in 5-gal. containers.
A deposit of \$6.00 required on all drums.

PATENT CHIMNEYS—

6-inch.....	\$1.20 lineal foot
8-inch.....	1.40 lineal foot
10-inch.....	2.15 lineal foot
12-inch.....	2.75 lineal foot

PLASTER—

Neat wall, per ton delivered in S. F. in paper bags, \$17.60.

PLASTERING (Interior)—

3 Coats, metal lath and plaster.....	Yard 1.50
Keene cement on metal lath.....	1.80
Ceilings with 3/4 hot roll channels metal lath (lath only).....	1.20
Ceilings with 3/4 hot roll channels metal lath plastered.....	2.20
Single partition 3/4 channel lath 1 side (lath only).....	3.20
Single partition 3/4 channel lath 2 inches thick plastered.....	3.20
4-inch double partition 3/4 channel lath 2 sides (lath only).....	2.20
4-inch double partition 3/4 channel lath 2 sides plastered.....	3.85
Thermax single partition; 1" channels; 2 1/4" overall partition width. Plastered both sides.....	3.30
Thermax double partition; 1" channels; 4 3/4" overall partition width. Plastered both sides.....	4.40
3 coats over 1" Thermax nailed to one side wood studs or joists.....	1.65
3 coats over 1" Thermax suspended to one side wood studs with spring sound isolation clip.....	1.90
Note—Channel lath controlled by limitation orders.	

PLASTERING (Exterior)—

2 coats cement finish, brick or concrete wall.....	Yard \$1.00
3 coats cement finish, No. 18 gauge wire mesh.....	2.00
Lime—\$3.00 per bbl. at yard.	
Processed Lime—\$3.10 bbl. at yard.	
Rock or Grip Lath—3/8"—20c per sq. yd.	
3/8"—19c per sq. yd.	

Composition Stucco—\$1.80 to \$2.00 sq. yard (applied).

PLUMBING—

From \$100.00 per fixture up, according to grade, quantity and runs.

ROOFING—

"Standard" tar and gravel, 4 ply—\$8.00 per sq. for 30 sqs. or over.
Less than 30 sqs. \$9.50 per sq.
Tile, \$30.00 to \$40.00 per square.
Redwood Shingles, \$7.50 per square in place.
5/2 #1-16" Cedar Shingles, 4 1/2" Exposure.....\$8.00 square

5/8 x 16"—#1 Cedar Shingles, 5" Exposure.....\$9.00 square
4/2 #1-24" Royal Shingles, 7 1/2" Exposure.....\$9.50 square
Re-coat with Gravel \$4.00 per sq.
Asbestos Shingles, \$23 to \$28 per sq. laid.
1/2 x 25" Resawn Cedar Shakes.
 10" Exposure.....\$10.50
3/4 x 25" Resawn Cedar Shakes.
 10" Exposure.....11.50
1 x 25" Resawn Cedar Shakes.
 10" Exposure.....12.50
Above prices are for shakes in place.

SHEET METAL—

Windows—Metal, \$1.75 a sq. ft.
Fire doors (average), including hardware, \$2.00 per sq. ft.

SKYLIGHTS—(not glazed)

Copper, 90c sq. ft. (flat).
Galvanized iron, 40c sq. ft. (flat).
Vented hip skylights 60c sq. ft.

STEEL—STRUCTURAL (None available except for defense work).

\$150 ton (erected), this quotation is an average for comparatively small quantities. Light truss work higher. Plain beams and column work in large quantities \$140 per ton.

STEEL REINFORCING (None available except for war work).

\$150 to \$200 ton, set.

STONE—

Granite, average, \$6.50 cu. foot in place.
Sandstone, average Blue, \$4.00. Boise, \$3.00 sq. ft. in place.
Indiana Limestone, \$2.80 per sq. ft. in place.

STORE FRONTS (None available).

TILE—

Ceramic Tile Floors—70c to \$1.00 per sq. ft.
Cove Base—\$1.10 per lin. ft.
Glazed Tile Wainscot—\$1.25 per sq. ft.
Asphalt Tile Floor 1/8" & 3/8"—\$.18 to \$.35 per sq. ft. Light shades slightly higher.
Cork Tile—\$.40 to \$.75 per sq. ft.
Mosaic Floors—see dealers.
Lino-Tile, \$.35 to \$.75 per sq. ft.

Wall Tile—

Glazed Terra Cotta Wall Units (single faced) laid in place—approximate prices:
2 x 6 x 12.....\$1.10 sq. ft.
4 x 6 x 12.....1.25 sq. ft.
2 x 8 x 16.....1.20 sq. ft.
4 x 8 x 16.....1.40 sq. ft.

VENETIAN BLINDS—

40c per square foot and up. Installation extra.

WINDOWS—STEEL—

30c per square foot, \$5 for ventilators.

POST-WAR TRANSITION FOR CONSTRUCTION

The construction industry of the United States will be able to swing into the transition from wartime to peacetime economy without difficult conversion problems, and will be able to provide a volume of activity in the years of the first post-war decade even greater than that experienced during the boom that followed the first World War, according to the F. W. Dodge Corporation which has made an extensive analysis entitled, "Construction Potentials; Postwar Prospects and Problems," under the direction of Thomas S. Holden.

"There is no conversion problem for the construction industry as such," the report declares. "Quick adaptation of techniques and facilities to new types of projects is part of the regular stock-in-trade of the industry. Architects, engineers and contractors engaged on the war construction program were able to expand their organizations overnight and to carry out the largest construction program in the history of this or any other country with the utmost speed, overcoming unusual difficulties and in a vast number of cases completing projects ahead of schedules."

It is estimated that total construction volume in the ten years following the war will average approximately double the average volume of the 1930-39 decade (the decade of depression and slow recovery). This would be an increase of about 5 per cent over the prosperous 1920-1929 decade. The estimate expresses post-war volumes in terms of pre-war cost levels.

Within this increase, residential building volume is expected to average three times the average residential building volume of the 1930-39 period; non-residential building would increase about 70 per cent over its 1930-1939 average; heavy engineering construction would increase about 50 per cent.

The rate at which the industry will swing into its full peace-time volume will be conditioned by several factors, principal among which are time-schedules for release of critical raw materials to building-product manufacturers; the reconversion problems of some building product manufacturers; manpower problems; release of price, wage and rent controls and the disposal by the government of surplus property.

WATERCOLOR AND PASTEL ANNUAL

The Eighth Annual Watercolor Exhibition of the San Francisco Art Association at the Art Museum, although small in size is broad in scope and fairly representative of contemporary American watercolor painting. Watercolor painting as a medium because of its very nature can but inadequately represent contemporary art of the western states, but it has become closely associated with this region since so many watercolorists

HOGAN LUMBER CO.

Wholesale and Retail

LUMBER

MILL WORK • SASH & DOORS

Office, Mill, Yard and Docks

SECOND AND ALICE STREETS • OAKLAND, CALIF.

Telephone GLencourt 6861

CLINTON CONSTRUCTION CO. OF CALIFORNIA

General Contractors

923 FOLSOM STREET • SAN FRANCISCO

SUtter 3440

FORDERER CORNICE WORKS

Manufacturers of

Hollow Metal Products • Interior Metal Trim
Elevator Fronts and Cabs
Metal Plaster Accessories • Sanitary Metal Base
Flat and Roll Metal Screens
Metal Cabinets • Commercial Refrigerators

269 POTRERO AVE.

SAN FRANCISCO, CALIF.

HEMLOCK 4100

STRUCTURAL STEEL

For Class A Buildings,
Bridges, etc.

JUDSON PACIFIC CO.

1200 SEVENTEENTH STREET
SAN FRANCISCO

Plants: San Francisco - Oakland

**The Most Complete Line of
STEELS and BUILDING MATERIALS
Made by a Single Producer**



See Sweet's Catalog File or write us for full information.

REPUBLIC STEEL CORPORATION
GENERAL OFFICES: CLEVELAND, OHIO

DENVER, COLORADO CONTINENTAL OIL BUILDING
LOS ANGELES, CALIFORNIA EDISON BUILDING
SALT LAKE CITY, UTAH WALKER BANK BUILDING
SAN FRANCISCO, CALIFORNIA RIALTO BUILDING
SEATTLE, WASH. WHITE-HENRY-STUART BUILDING

**PACIFIC
MANUFACTURING CO.**

HIGH CLASS INTERIOR FINISH
QUALITY MILLWORK

142 SANSOME ST., SAN FRANCISCO
GARfield 7755

6820 MCKINLEY AVE., LOS ANGELES
THornwall 4196

BUILDERS EXCHANGE, OAKLAND

**SANTA MARIA INN
SANTA MARIA, CALIFORNIA**

FRANK J. McCOY, Owner
ORVILLE E. SAMMAN, Manager

On the
Coast
Highway
between
San
Francisco
and
Los
Angeles



American
or
European
Plan
•
Old
Tap
Room

**"AMERICAN MARSH"
Redi-Vac Vacuum Heating Pump**



Send for
Bulletin 441

SIMONDS MACHINERY CO.

San Francisco
816 Folsom St.

Los Angeles
455 East Fourth St.

SISALKRAFT

REG. U. S. PAT. OFF.

"More than a building paper"

THE SISALKRAFT CO.

205 West Wacker Drive
Chicago, Ill.

55 New Montgomery Street
San Francisco, Calif.

**VERMONT
MARBLE COMPANY**

Producers and Finishers
of
Domestic and Imported Marbles

Write for new pamphlet describing our
Marble Toliets and Showers

San Francisco and Los Angeles

San Francisco phone: SUTTER 6747



BASALITE

CAMBERED SHINGLE TILE

PERMANENT • FIREPROOF • STORM-
SAFE • COLORFUL • ECONOMICAL

Manufactured by
BASALT ROCK CO., INC.
NAPA, CALIFORNIA

live here and some of the best work in this medium is produced by them.

The medium may well become a good means of introduction to the more profound art expression of western artists because of its general use among artists of all schools and more specifically its popular appeal to the small home and apartment-house dweller who can better afford to own a watercolor than an oil painting. Also the characteristics of the medium, its lightness and clarity of color, its spontaneous and perhaps its gayer approach to painting has a more direct appeal to the average public.—F. W. J.

N. CLARK AND SONS

Manufacturers of
Quality
Architectural
Clay Products

During this stage of the war, our principal energy is to manufacture products required by the various war agencies. We still can supply some pre-war materials for civilian needs.



401 PACIFIC AVENUE
ALAMEDA, CALIFORNIA
San Francisco • Los Angeles
Salt Lake City • Portland

ABBOT A. HANKS, INC. Engineers & Chemists

INSPECTING — TESTING — CONSULTING
CONCRETE • STEEL • MATERIALS
CHEMICAL AND TESTING
LABORATORIES

• RESEARCH AND INVESTIGATION •

TESTS OF STRUCTURAL MATERIALS
DESIGN OF CONCRETE MIXES
SHOP AND ERECTION INSPECTION OF
STRUCTURES AND EQUIPMENT
INVESTIGATION OF STRUCTURES
AND MATERIALS
TESTS AND INVESTIGATION OF
FOUNDATION SOILS
FIRE RESISTANCE AND INSULATION
TESTS

624 Sacramento Street, San Francisco

Robert W. Hunt Company ENGINEERS

Inspection - Tests - Consultation
Schools and Other Structures
Are Built as Designed

When Construction Materials are
Inspected at point of Manufacture
and during Erection by

ROBERT W. HUNT COMPANY

Cement, Concrete, Chemical, Metallurgical,
X-Ray and Physical Laboratories

Chicago - New York - Pittsburgh
Los Angeles - All Large Cities
San Francisco, 251 Kearny Street

MEXICO'S ARCHITECTURE

"Building activity started in 1521, immediately after the Conquest, and lasted until the beginning of the disturbances which terminated in the independence of Mexico in 1821. The province enjoyed a period of unexampled prosperity, free from war or civil dissension of any kind, for nearly three centuries, which may be designated as the Vice-Regal period, during which its wealth increased to an astonishing extent. . . .

"The Cathedral of Mexico City is probably the largest church in America, (387 feet long and 177 feet wide), and, all in all, perhaps the finest. Its rather low and heavily buttressed facade and majestic towers seem to express the very essence of Latin American spirit. The church deserves to be better known; I question if a more satisfying Renaissance cathedral exists in the world. The original design, laid out by Castaneda, was supplemented after the corner stone had been laid, in 1573, by a new project, the work of Juan Gomez de Mora, who was sent from Spain by Philip II.

"The introduction of glazed faience was followed by its use for the decorations of domes, towers and walls, and its brilliant coloring, seen against the intense blue of the sky, added another note to the already dazzling scheme. The surprising fact is that throughout all this riot of elaborate decoration and color, the innate Spanish good sense always retained ample surfaces of plain masonry as a background and frame for the ornament, even in the most extravagant buildings, and the particolored domes invariably rose above a base of severely plain stone, so that the effect of the whole was never confused. In this respect alone, Mexican architecture is worthy of the most careful study. Even such structures as the "House of Tiles" in Mexico City, or the Casa del Alfenique at Puebla, which are among the most beautiful buildings in the world, show a balance of elaboration which could only have been conceived in an atmosphere of architectural sanity.

"But after all matters of detail have



FOR BUSINESS AND PERSONAL ACCOUNTS

Merchants, professional people, office workers . . . all types find our Mailway service the most convenient way of banking. They make deposits any time, night or day, Sundays or holidays. Our special Mailway envelopes and passbook assure quick and safe service.

Open a Mailway account by mail

CROCKER FIRST NATIONAL BANK

OF SAN FRANCISCO
California's First National Bank
Member Federal Deposit Insurance Corporation
ONE MONTGOMERY STREET

Independent Iron Works

Structural Steel
Ornamental Iron
Steel Service Stations
Steel Tanks
Standard Steel Mill Buildings
Bridges

821 Pine Street Oakland

A L A D D I N Heating Corp.

Specializing in
QUALITY HEATING
EQUIPMENT

2222 San Pablo Avenue
OAKLAND
TWINOAKS 1022

MULLEN MFG. COMPANY

BANK, STORE AND OFFICE
FIXTURES—CABINET WORK
OF GUARANTEED QUALITY
CHURCH SEATING

Office and Factory:
40-50 RAUSCH ST., Bet. 7th and 8th Sts.
San Francisco
Telephone UNderhill 5815

THE TORMEY COMPANY

GENERAL PAINTERS
AND DECORATORS

Phone UNderhill 1913

563 FULTON STREET
San Francisco

G. P. W. JENSEN & SON

Building Construction

320 Market Street, San Francisco
Phone: GARfield 2444

JOHN CASSARETTO

—Since 1886—And Still Active—

Building Materials

READY MIX CONCRETE
ROCK - SAND - GRAVEL - LIME
CEMENT - PLASTER - MORTAR
METAL LATH - WOOD LATH
STUCCO - WIRE NETTING

Service Unexcelled

Bunkers
Sixth and Channel, San Francisco
Phones: GARfield 3176, GARfield 3177

been taken into consideration, the distinguishing fact remains that the one dominant feature of Mexican Colonial architecture is the dome, which was universally utilized and of which literally thousands exist, all built of solid masonry. Placed over the crossing of nave and transept churches, or roofing the innumerable chapels and shrines, its use imparts a singular sweetness and beauty to the skyline of the cities, almost unique in the world. . . .

"A Mexican town house of the older type is approached from the street by a great iron-studded door and a cavernous 'zaguan,' reminiscent of Toledo or Segovia, which led to the 'patio.' The lower portions of the house are devoted to service, storage, and habitation of a sort for the porter, and maybe several turkeys. Under the arcades, which once sheltered the family coach, Felipe or Vicente will perhaps be found washing the car. A stone stairway swings nonchalantly up to the balcony which is gay with flowers, vines, red peppers, and colored rugs. Brilliant colored birds in wooden cages hanging from the roof add to the life of the scene. From the balconies, open lofty, possibly rather bare chambers, running through to the street. If the house is in the plateau country another stair leads to the brick paved 'azatea' or roof. In the country the house is likely to be even more picturesque and the flowers more profuse. . . ."

—From Walter H. Kilham's "Mexican Architecture of the Vice-Regal Period."

REMILLARD-DANDINI Co.

Brick and
Masonry Products

*

633 BRYANT ST., SAN FRANCISCO
569 THIRD ST., OAKLAND

DINWIDDIE CONSTRUCTION COMPANY BUILDERS

CROCKER BUILDING
SAN FRANCISCO



HERRICK IRON WORKS

STRUCTURAL STEEL
REINFORCING STEEL

18TH AND CAMPBELL STS.
OAKLAND, CALIF.
Phone GLencourt 1747

Phone GARfield 1164

Thomas B. Hunter

Consulting Engineer

DESIGNER OF HEATING
AIR CONDITIONING
VENTILATING AND WIRING
SYSTEMS, MECHANICAL
AND ELECTRICAL EQUIP-
MENT OF BUILDINGS

41 SUTTER STREET
ROOM 710

San Francisco

California

ANDERSON & RINGROSE

General Contractors

320 Market Street, San Francisco
Phone GARfield 2245



