

ART DEPARTMENT
ART MAGAZINE

ART MAGAZINE X

BOOK No. _____ ACCESSION _____

*720.5 Ar24 160 559767

NOT TO BE TAKEN FROM THE LIBRARY

FORM 2627 BM-10 41

C



Digitized by the Internet Archive
in 2010 with funding from
San Francisco Public Library

ARCHITECT AND ENGINEER



JANUARY

1945

WESTERN ASBESTOS CO.



A complete source of supply

**. . . for building materials, insulation,
packings and friction materials, refractory
products, Transite conduit and korduct,
expansion joint material, industrial
products and acoustical materials**

WESTERN ASBESTOS CO.

Building Materials • Industrial Products

SAN FRANCISCO, OAKLAND, SACRAMENTO, RICHMOND, CALIFORNIA
Main Office: 675 Townsend Street • San Francisco • HEMlock 4884

• ARCHITECT

Vol. 180 No. 1

AND ENGINEER

ARCHITECTS' REPORTS—Published Daily

MARK DANIELS
Editor

E. H. WILDER
Associate Editor

MICHAEL GOODMAN
Post-War Planning

L. H. NISHKIAN
Consulting Editor

E. N. KIERULFF*
Ass't Editor
*In the Service

Contents for



x720.5

Ar 24 ¹⁶⁰

559767

JANUARY

COVER: ENTRANCE TO SOUTHERN CALIFORNIA HOME

ARTICLES AND MISCELLANEOUS TEXT

	Page
RUNNING FIRE	4
NEWS AND COMMENT ON ART	7
GOLDEN GATE WEAVERS EXHIBITION	8
IN THE NEWS	10
THE LUCIAN LABAUDT MEMORIAL	12
A CIVIC CENTER FOR LAKE MERRITT	14
OAKLAND, CALIFORNIA E. GEOFFREY BANGS, A.I.A.	
A CALIFORNIA ARCHITECT IN MEXICO CITY	23
By WM. ARTHUR NEWMAN, Architect	
NORMANDY INVASION, THOSE PORTABLE PORTS	30
(Illustrations)	
THE OUTLOOK FOR RESIDENTIAL CONSTRUCTION	32
By W. C. BOBER, Economist	
THE OUTLOOK FOR FARM CONSTRUCTION	35
By SANDFORD B. TAYLOR, Economist	
TREES IN ARCHITECTURAL DRAWING	36
By MARK DANIELS, A.I.A.	
A.I.A. ACTIVITIES	37
PRODUCERS' COUNCIL PAGE	40
BOOK REVIEWS	37
ESTIMATORS' GUIDE	43
INDEX TO ADVERTISERS	48



LEONARDO DA' VINCI

ARCHITECT AND ENGINEER (Established 1905) is published on the 15th of the month by The Architect and Engineer, Inc., 68 Post St., San Francisco. President, K. P. Kierulff; Vice-President and Manager, L. B. Penhorwood; Treasurer, E. N. Kierulff; Advertising Manager, V. E. Atkinson, Jr.

Los Angeles Office: 403 W. 8th Street.

Entered as second class matter, November 2, 1905, at the Post Office in San Francisco, California, under the Act of March 3, 1879. Subscriptions United States and Pan America, \$3.00 a year; \$5.00 two years; foreign countries \$5.00 a year; single copy 50c. ARCHITECTS' REPORTS are published daily from this office, Vernon S. Yallop, Manager.



RUNNING FIRE — by MARK DANIELS

CLASSIFICATIONS

There are Architects and ARCHITETKS, but whatever the classification in which the public puts them, we should stand together and refrain from disparaging or descriptive appellations. If one of us has a job that calls for a sort of an Elizabeth Arden architect, we should turn it over to one, if we can find one still living and can't do the job ourselves. There is the architect who tears into the job and gets it done. Wrong or right, he gets it done. He is called the Jack Dempsey type. In opposition is the man who spends a month changing the details of a bath room window. Generally he suffers from a mild form of paresis. Then there is the Abattoir type who slaughters every precept of style or taste and puts the heating plant in the kitchen to save pipe or the elevator in the manager's office to save steps. Whatever these classifications may be (and you, no doubt, can think of legions), we all should accept them without comment and help where possible with professional courtesy.

In my own experience I once had a prospective client who had style complexes. She wanted the entrance hall Elizabethan, the living room Persian, the dining room Chinese and the rest of the house a potpourri of mid-Victorian, Italian, Russian and Mayan; the nut! Since my Knowledge of Mayan was limited, I looked around and found what I thought was one of those Eau de Cologne architects who would just eat (or smell) this sort of thing up; the crack-pot! He took the job and made good; the bone-head! He took his handkerchief out of one sleeve and rolled up the other. After a full session of client-education, he built a house that was beautiful inside and out and was admired by all who saw it. Dumb Cluck? He was an artist in disguise.

All of which is an argument against hasty classifications.

THE DISTANT DRUM

Steps for unification among the architects were taken none too soon. Perhaps they are too late. Problems that can be solved only by concerted action are besetting the members of the profession and are arising in increasing numbers. Some threaten the very existence of the architectural profession, while many point to a possible change of the practice into an unrecognizable form.

For example, there is the rapidly growing practice among the larger building organizations of employing certified and licensed architects to

form an architectural or designing bureau under whose signatures the city may issue permits. There is nothing wrong or illegal in this procedure and yet, if it is carried to extremes, it is conceivable that all architects, except in rare instances, will become salaried employees, which same may be welcome to the younger architects on the basis that a small salary is better than no income at all. If architects are unable to forestall the destruction of architecture as a profession, they may find themselves on a production basis, with little or no consideration given to talent or genius. The next step would be unionization.

The engineers are going through phases of this struggle at the present time. Mr. T. J. Corwin, Jr., president of the regional Local Section of the Am. Soc. C.E., warned that the C.I.O. was working vigorously on the inclusion of engineers whose salaries brackets included \$7,500. He warned that "The problem is growing and it is possible that all professional engineers will be dominated by the C.I.O. and the A.F.L. The society is opposed to such group action and has three times attempted to obtain an amendment to the Wagner Act. . . . The professional standing of the engineer is endangered when he enters a trade union." His report further states that many of the western organizations have already organized. Among these are Los Angeles, Seattle and Oregon. San Francisco, Sacramento and New Mexico have passed enabling acts but have not organized. Stone and Webster appealed to the N.L.R.B. to decide whether C.I.O. or A.F.L. should represent their engineer employees. When the matter was referred to W.L.B., a court of five decided that professional men should be separated from the trades.

Whether the picture of a unionized membership of the architectural profession looks well to you or not depends upon where you sit. It might, and probably would, result in there being no opportunity to secure remuneration for long and painstaking study of a problem in design or for the creation of works of great, but only, aesthetic value. Russia has worked out a system of a sort largely on their system of government, but until we have abandoned our principles of individual enterprise and freedom, and adopted their more communistic principles, I doubt if it will work in the United States.

Any type of labor that is not injured by regimentation and standardization may be aided by unionism, but to unionize art is as illogical as unionizing poetry or preaching.

(See Page 28)

The Forest Industries Blaze New Trails

Opening of TECO
Wood Products Development Shop
AND
Wood Chemistry
Laboratory

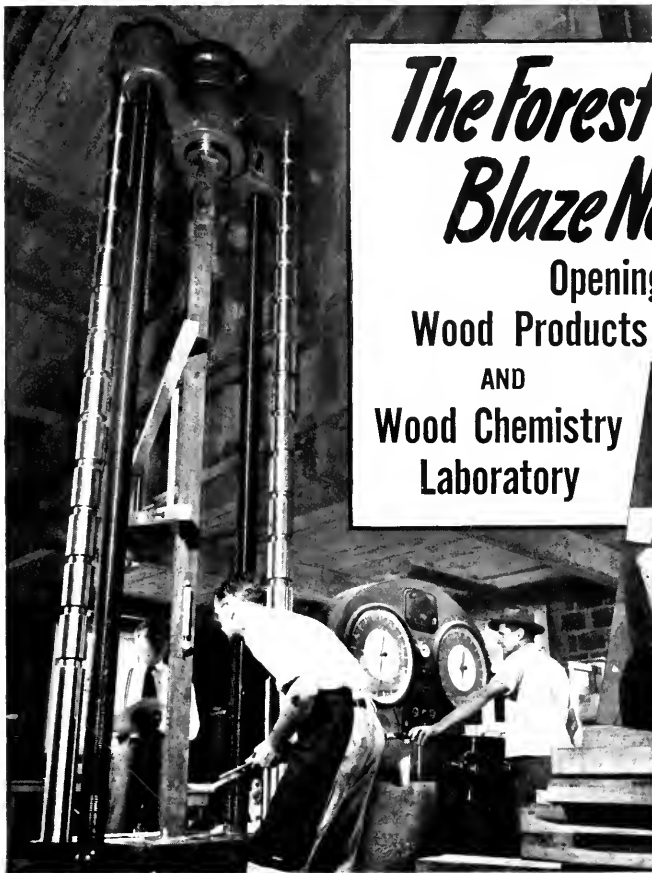

↑ TECO Chemistry Laboratory. TECO chemists are here shown working on lignin derivatives.
← 200,000 lb. Baldwin-Southwark testing machine in the TECO Shop. Material undergoing test is a small wood column being tested in compression.

Timber Engineering Company announces the opening of its Wood Products Development Shop and Wood Chemistry Laboratory located in Washington, D. C.

The Wood Products Development Shop has a full scale testing rig equipped to handle trusses up to 50' span; auto-claves and other equipment used in pressure treating; dry kiln and high pressure steam equipment for impregnating; and other facilities for determining the physical and mechanical properties of wood and wood products.

The Wood Chemical Laboratory has modern equipment for investigations in wood chemistry and wood derivatives research. It is giving spec-

ial attention to lignin research including adhesives, synthetic plastics, etc.

If you have any problems in respect to the physical, mechanical and chemical properties of wood, the technical staff of the Timber Engineering Company may be of assistance on a moderate fee basis. If its own facilities will not solve your problem, it will assist you in locating sources which can.

Consultations at our Washington office may be made by appointment and without obligation on your part. Write us on your business letterhead stating your wood utilization problem.

Timber Engineering Co., Inc. of Washington, D. C.

Manadnock Building, 681 Market Street, San Francisco • Telephone Garfield 6296

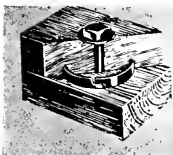

**SPECIFY TECO CONNECTORS
SPLIT RINGS • SHEAR PLATES
GROOVING TOOLS**

KEEP ME POSTED

Alden K. Smith,
Monadnock Building,
681 Market St., San Francisco

AE

Put my name on your mailing list.

Name _____

Firm _____

Business _____

Street _____

City _____ State _____

NEWS AND COMMENT ON ART

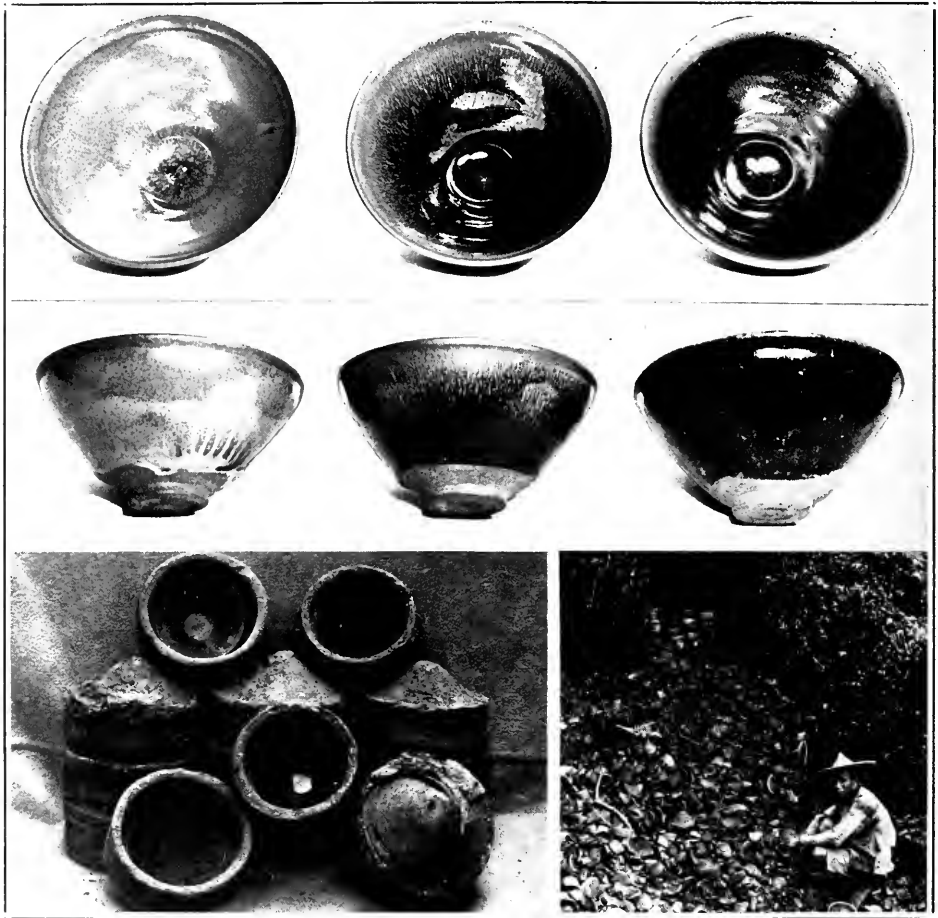

Top: Temmoku tea bowls from the Chien-an kilns at Fukien; left to right, autumn leaf brown, hare fur and purplish with brown mouth rim.

Bottom: Left, group of saggers or firing cases; right, wastrels at recently discovered kiln site at Fukien. Courtesy, the Chinese Digest.

CHINESE PLEBIAN STONWARE

By CHINGWAH LEE

(In the last issue Mr. Chingwah Lee, in his article, "The Age of Stoneware," described ceramics which were made essentially for the aristocrats. In this issue he concludes the survey of Chinese stoneware of the Sung dynasty by describing ceramics which were made especially for the common people.)

While the makers of celadons, tings and chuns were busy during the Sung dynasty (959-1278 A.D.) making choice articles for the emperor and members of the nobility, other kilns were occupied with the production of rustic wares for the common people. Among the wares produced by these work-a-day kilns are the temmoku, the graffiato, the underglazes and the enameled polychromes—products mostly of the Tzu chou, the Chien and the Chi chou kilns. Though held in relatively low esteem during the Sung dynasty these wares are now greatly treasured by collectors in the East and the West alike.

A brownish-black or temmoku glaze was produced in Fukien, first at the village of Chien-an and later at Chien-yang. The term temmoku is the Japanese equivalent of t'ien-mu shan (heavenly-eye mountain, location of a Buddhist monastery where they first came across this ware) and it is used to cover similar wares made outside of Fukien. The Chinese term, Chien, is a happy one, for it not only stands for Chien-an or Chien-yang, but is an abbreviation for Fu Chien (Fukien).

The Chien glaze, which covers a coarse darkish red stoneware, has many interesting variations, brought about by controlling the oxidation-reduction process during the firing, by changing the iron concentration of the glaze, by controlling the acid-alkalinity content of the glaze, etc. The hare fur effect, for example, probably results from the partial oxidation of the iron in the glaze which is basically black. The glaze near the mouth-rim of a bowl—and Chien potters apparently hardly made anything else—would be the first to be oxidized, turning a rusty brown. The downward flow of the brown color streaks the black glaze with fur-like striation—resulting in the famous

hare-fur glaze. If this process is continued until the black is completely obliterated an autumn-leaf brown is achieved. This color varies from a café-au-lait to an iron-rust brown, but some, made in other kilns, is a decided plum red.

Temmokus produced in many centers in Honan, called Honan chien, have buff-white bodies. Here are produced the famous "oil spot" (yu tien) temmoku glaze. This glaze is not unlike the familiar "thousand island" salad dressing except that the ground is black and the globules silvery. According to A. L. Hetherington, the silvery spots are ferric oxide crystals formed within the glaze. There



COLONIAL WEAVING—de Young Museum

**GOLDEN GATE WEAVERS' EXHIBITION
FEATURED AT DE YOUNG MUSEUM
THIS MONTH**

are also temmokus with metallic speckles, probably the result of precipitation of excess iron from a solution which is near saturation at the time it is ready for firing. If the surface of the glaze is touched here and there with the tip of a brush dipped in a saturated solution it is conceivable that the precipitation would take place about the points touched. This is probably how those with speckles in the shape of various designs were produced.

In the figured temmokus a design is seen on the glaze. This is not an on-glaze decoration but a design which is "born" of the glaze. Various theories have been advanced for these figured thienes, such as the scraping off of the glaze to yield a design and then filling the cleared areas with a glaze having ferric oxide of another concentration. I believe there is a simpler method for making these figures. If we recall that ferric oxide enters into solution only in an alkaline medium, turning black in an acid one, it is possible that all the potter need do is to trace the design with a brush dipped in acid—and the area so treated would turn black in the kiln.

"A wide range of glaze effect was produced by the Chinese potter over the long period of time extending from the Han dynasty down to the time of the Manchus, and it is well to record at the outset the great technical knowledge displayed by the Chinese potter. The more the glaze effects produced in early days are examined scientifically, the more impressive becomes his knowledge. He may not have used the jargon of the scientist of today but he obviously approached his task in a scientific method, and his close repetition of previous process, arising from observation, helped him to produce what we admired so much." (A. L. Hetherington in "Chinese Ceramic Glazes, 1937.")

The pattern center which goes by the name of Tzu Chou (Crockery Town) is situated in southern Chih-li and has a continuous existence since the Sui dynasty in the sixth century. The ware produced has a buff-grey body, and the potters were masters of the use of slips. A slip is a creamy solution of the paste, generally one more refined than that used in making the body. By coating a white slip over a buff-grey vessel a smoother surface and a white appearance is obtained. This slip is then protected with a clear glaze. The Ting-type bowls of this region are made in this manner. Or the slip may have glazing material mixed with it, producing a slip-glaze. The brown-black temmoku-type glazes of this kiln are produced in this manner.

Besides a Ting type and a temmoku type the Tzu potters produced a painted ware for which it is most noted. This is done by coating the vessel

(See Page 37)

The annual exhibit of hand-woven textiles by the Golden Gate Weavers is being displayed at the de Young Memorial Museum, Golden Gate Park, San Francisco, California, from December 12, 1944 to February 1, 1945.

This exhibit is grouped in three divisions; namely, Colonial type of traditional weaving, Modern weaving for the modern home, and hand-weaving from present-day salvage materials, both for hospital work in war times and for the weaver's personal use.

The Colonial type of weaving is illustrated in the accompanying photograph. From left to right is shown (1) a table cover done in European traditional pattern, the linen thread used therein was grown, spun, dyed and woven by Mrs. Lisa Lepik of Berkeley; (2) a white coverlet woven by Mrs. C. A. Altman of Berkeley, using an early New York coverlet pattern for the design; (3) an adaptation of the M. Ferris coverlet woven on an eight-harness loom by Mrs. Ada Dykes of Oakland; (4) a coverlet woven in the "Sorrel Blossom" pattern with a "Pine Tree" border by Mrs. Altman; (5) a table runner woven in an Early Colonial pattern by Mrs. Louise Rowell of Oakland. The additional Colonial hand-woven articles exhibited at this time were woven by members who have Colonial homes and furnishings and desire to blend the simplicity of hand-woven textiles with that of the Colonial architecture.

The Modern weaving is produced by members who have modern homes, although it is often found that a Colonial hand-woven article will harmonize beautifully in a modern home and vice versa. The Modern pieces include hand-woven drapery and upholstery materials, hangings, table linens and yardage.

The salvage materials used in the third section are silk stockings, rags, discarded hat braids, leather, tire linings and others. Several articles featured are hand-woven by men in the United States Armed Forces who are interned in hospitals in the Bay area but who are being supervised by Golden Gate Weavers through the Arts and Skills Unit of the American Red Cross.

This exhibition is representative of a year's work of the Golden Gate Weavers who have a membership of approximately seventy-five from the Bay area and vicinity, who design their textiles and weave, as a hobby, for originality in their homes.

SPECIFY AND INSTALL HAWS



MODEL 7A

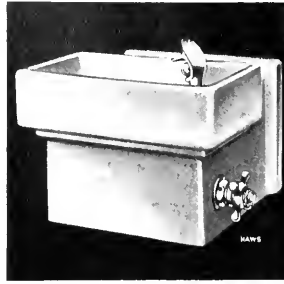

MODEL 7D



MODEL 7F

DRINKING FOUNTAINS AND

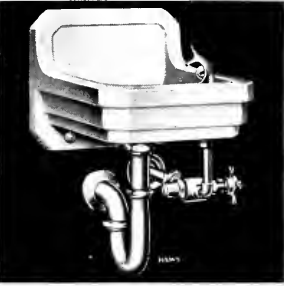

MODEL 14D2



MODEL SC2



MODEL 8

FAUCETS NOW! Write for CATALOG



MODEL 1500



MODEL 9R2



MODEL 1700

Haws DRINKING FAUCET COMPANY

1808 HARMON STREET • BERKELEY 3 • CALIFORNIA

Agents in the following cities:

CHICAGO • LOS ANGELES • SAN FRANCISCO • SEATTLE • PORTLAND • SALT LAKE CITY • NEW ORLEANS
HOUSTON • ATLANTA • PHILADELPHIA • WORCESTER, MASS. • NEWARK, N. J. • RICHMOND, VA.
ST. LOUIS, MO. • GRAND RAPIDS, MICH. • DETROIT • CHEVY CHASE, MD. • EL PASO, TEXAS • NEW YORK CITY

OUR NEW COVER

On the cover used by Architect and Engineer during the year of 1944 in the cuts illustrating the work of various engineers, architects and artists it was not possible to do justice to the contributors with such small cuts. Also it seemed about time to change the format in the same sense that a change is always desirable if it improves some condition. So it was decided to use a cover design that would permit a better showing of some professional works, on a scale that would bring out more graphically its merits.

We were particularly fortunate in getting for this issue one of H. Roy Kelley's houses in Los Angeles. It is really a detail of the bay window and entrance of the Houston residence in Los Angeles but, while it does not show the entire house, it is of an unmistakable quality that does not require the signature of H. Roy Kelley, A.I.A., to identify it.

It is true that the planting, the foliage of the Jacaranda and the art of the photographer did much to make a beautiful picture of the ensemble but any other architecture might not have made such a lovely composition. But, then, that is one of the characteristics of homes designed by Mr. Kelley.

The photography was done by Mr. George B. Haight, of Pasadena.

BUYS SIGNAL SYSTEM

Faraday Electric Corporation, Adrian, Michigan, announces the purchase of the signal system business of the Holtzer-Cabot Electric Company of Boston, Mass., effective December 31, 1944.

Operations will continue in the Holtzer-Cabot Boston plants through January and February, after which they will be transferred to the Faraday plants in Adrian and Chicago. The rigid standards of efficiency and quality which have been established by each of these organizations in the past will be maintained.

The Faraday Electric Corporation is a consolidation of Stanley & Patterson, Inc., of New York and Schwarze Electric Company of Adrian, and further expansion of Faraday activities will make the corporation one of the leaders in the signal systems business.

IN THE NEWS

WE are advised by the United States Chamber of Commerce in "BUSINESS ACTION" to "watch for a flood of delayed Administration orders, directives and regulations after the election." Well, "there is a tide in the affairs of men which, taken at the FLOOD leads on to fortune," if you are not swamped in the FLOOD.

PERMUTIT ELECTS NEW OFFICERS

The Permutit Company of New York, manufacturers of water conditioning equipment, have announced the election of W. Spencer Robertson as Chairman of its Board of Directors and Henry W. Foulds as President. Mr. Robertson has been President of the company for the past 15 years while Mr. Foulds has been Executive Vice-President and Director of Goulds Pumps, Inc., and a Vice-President of Servel, Inc.

Both officers assume their new duties at a time when the company is about to resume production of household water softeners. In the municipal and industrial field, Permutit produces a variety of types of equipment.

Recently, the Company developed a seawater desalter which has been adopted as standard life-saving equipment aboard Army Air Force, Navy and Air Transport Command aircraft.

A WINDOW WITH BRAINS

One practical answer to many of the "dream homes" that architects have put on drawing boards for post-war building may be found in a device now doing vital duty on every plane that is in the air today.

From the heaviest bombers to the lighter fighters and small scouting planes, a device is serving to control engine cowl flaps, landing gear, wing flaps, trim tabs, and ailerons.

Known as the LEAR actuator it consists of a small power unit, capable of transmitting its power to any part of the plane, accessible or inaccessible, performing unflinchingly tasks which previously were subject to failure, and required a great deal of real physical force from the flyers.

One of these actuators has been adopted for opening and closing windows in the LEAR plant at Piqua, Ohio.

A moisture switch outside the window promptly shuts the window while a pushbutton switch on a nearby table furnished independent control of the device when desired.

IN THE NEWS

NEW BOOKLET OFFERED BY TIMBER ENGINEERING CO.

Alden K. Smith, manager of the Western Service and Sales office of Timber Engineering Company of Washington, D.C., announces that they are now offering a new booklet gratis to architects and engineers in the eleven western states. This booklet, entitled "Wood As an Engineering Material," by L. J. Markwardt, is based on the Edgar Marburg lecture before the annual meeting of the American Society for Testing Materials. Mr. Marburg was the first secretary of this society. Copy of this publication may be secured by addressing Mr. Smith's office, Monadnock Building, 681 Market Street, San Francisco 7, California.

W. D. PEUGH is busy trying to complete his F.P.H.A. jobs without sacrifice to his enviable, and well earned, independent older practice. His project, California 4893 N, for 400 family dwelling units in Pleasanton, bids well to be one to command notice.

THE PRODUCTS OF TOMORROW EXPOSITION is sailing along under the able guidance of Marcus W. Hinson, chairman of the planning committee. They have made a thoroughgoing survey among the manufacturers to determine what, and who, can be exhibited. "Kitchens of Tomorrow" will be on every lamp post, if they can get rid of the dogs. Use of glass in home construction and interior decoration will play a large part as will the products of the deep freeze industry. Well, it is to be hoped that civilian travel will be restored by next March.

TIMOTHY L. PFLUEGER has not reported how far he has gone in completing his plans for the 435 family dwelling units project, California 4896 N, but if it is as big as it sounds, he will be at it for some time.

WESTERN BUILDING reports that November's permit valuation in 25 leading western cities fell from \$11,053,066 in October, 1944, to \$10,420,364 in November. The permit valuation of San Francisco rose from \$473,854 to \$506,501 in the same period, while the report for Los Angeles showed a decline from \$3,670,498 to \$2,865,088. The total for the 25 cities during the month of November, 1943, was \$19,382,048.

ADEQUATE WIRING ... A "MUST" IN FUTURE HOMES

Acute housing problems today are making people more than ever "home conscious" and millions are dreaming of the time when they will live in homes of their own — homes with electrical conveniences lacking in present living quarters.

When the war is over and home builders start converting war bonds into new homes, they are going to be far more critical of architectural plans than ever before. Electrical service adequate to take care of increased demands will be one of the prime items of consideration.

Experience has proved that nothing so thoroughly irritates a client as to move into a new home and find insufficient electrical outlets, misplaced outlets and switches, or poor lighting — all shortcomings that make a house obsolete before it is used.

Electrical living is the future way of living and architects today are putting adequate wiring at the top of the list of "must" items in planning postwar homes.



NORTHERN CALIFORNIA ELECTRICAL BUREAU

1355 Market Street
San Francisco



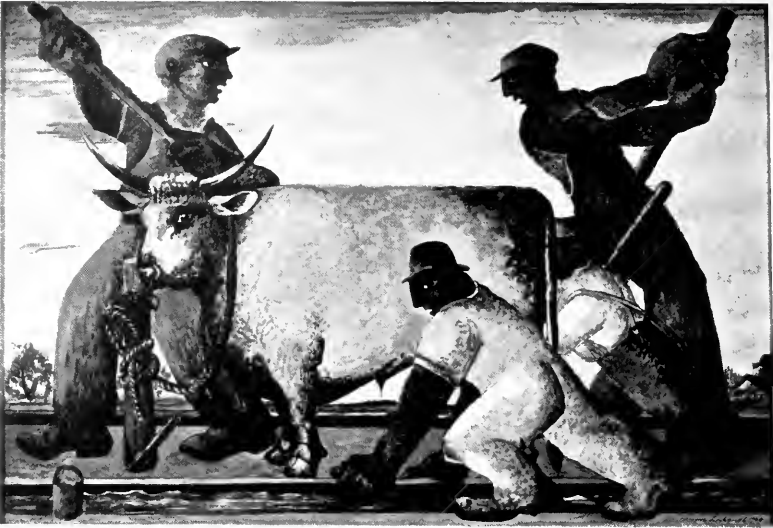

BULL ON THE RAFT—1940

Tempera on Board 43 x 33

The Lucian Labaudt Memorial

THE LUCIAN LABAUDT MEMORIAL might have well been carried on through December if reports of the interest it has aroused may be considered. His hearty greetings and cheerful attention were warm notes in the frequently cool atmosphere of the streets of San Francisco. Now that he is gone many of us would like to revive the memory of him by time spent without haste in the contemplation of his work. At least a few hours spent in company with some of his paintings at the San Francisco Museum of Art would bring back to many of us memories of happy hours spent with an artist who gave his life in devotion to his country and his work.

The S. S. Lucien Labaudt was launched on April 7, 1944. To have a ship christened after one's name is an honor but as a memorial it can be only transitory. A more lasting one would be the establishment of a permanent exhibit of his work in some museum or gallery. Not that those who knew him and his art need anything to keep fresh in their minds the memory of him but that they may view repeatedly his work that they may keep alive the memory of it.

Since 1910 students of art have been familiar with his work and later his teachings. His bounding energy, his tolerance for convictions other than his own and his brave fearlessness will be remembered by the students of the California School of Fine Arts where he taught so enthusiastically.

Henry Varnum Poor wrote of Lucien from New York in September, 1944, an item on Lucien's character that deserves repetition. He said, "He was, of course, profoundly influenced by French Art, as every intelligent man with his eclectic background must be, but this influence was not imitation. The fundamental logic of cubism, and the whole necessity of imposing a studied order upon realism, was native to his mind and part of the maturity of his cultural background. His work has this great charm inherent in the eternal conflict and fusion of the logic of maturity with the fresh vision of a child."

It is with the hope of carrying on with the work of perpetuating the art of Lucien Labaudt that two of his paintings are produced on these pages.

NEWS AND COMMENT ON ART

A Return Engagement at the De Young Museum will include further exhibition of the paintings of Professor Chang Shi-Chi. It includes many landscapes painted in the traditional Chinese manner.

Lest We Forget, the permanent exhibitions at the California Palace of the Legion of Honor in Lincoln Park still invite a visit. Prominent among these is the Alma de Bretteville Spreckels collection of drawings and sculptures by Auguste Rodin. They are surpassing and worthy of repeated visits. AND don't forget the organ recitals of Uda Waldrop at 3 p.m. on Saturdays and Sundays.

The California School of Fine Arts is carrying on its laudable work in offering instructive courses in art and photography for professionals and laymen. Unfortunately the announcement of the course given by Ansel Adams was not received by ARCHITECT AND ENGINEER at a date that was timely but those interested may still be able to get in on some of his talks.

(See Page 33)

PRIVATE CONSTRUCTION IN 1945 DEPENDENT ON WAR IN EUROPE

Unless the war with Germany continues into the summer, the volume of new private construction is expected to turn upward during 1945, thus ending a sharp three-year decline, James W. Follin, Managing Director of the Producers' Council, national organization of manufacturers of building materials and equipment, has predicted.

Estimates prepared by the Council's Market Analysis Committee indicate that new construction by private enterprise should reach a volume of about \$2.8 billion, or practically double the 1944 level, if the European war ends early in the year and if restrictions on civilian construction are liberalized promptly after Germany is defeated.

However, if the war in Europe is prolonged, the volume of private building during the new year will show relatively little increase and may fail to rise above the low mark of \$1.4 billion reached in 1944.

Should the progress of the war be favorable, residential construction in 1945 is expected to account for more than half the increase in the volume of private building. Under such conditions it is

(See Page 21)

SHAMPOO AT MOSS BEACH—1935

Oil 70 x 60

Carnegie International
Exhibition—1936





PLATE "I"

A Civic Center For Lake Merritt Oakland, California

By E. GEOFFREY BANGS, A.I.A.

The local papers have been carrying news items recently which indicate a revival of interest in the development of a civic center for Lake Merritt in Oakland. As this subject has been of interest to local architects and planners for a long time, it has been suggested that some of the background of the project might be of interest at this time.

Circumstances and the enterprise of early Oaklanders gave the City a golden opportunity to develop one of the finest civic centers in the country. Unfortunately full advantage has not been taken of it to date. Oakland's experience in this respect is probably not unique.

It is proposed to outline what has been done so far in the growth of a civic center and to show by

means of studies how the lack of a plan has constantly jeopardized the success of an ultimate scheme.

The accompanying plan studies, with the exception of the model, were produced in my office at intervals of about two years during the time I was a member of the City Planning Commission of Oakland because of my interest in the problem and of my desire to implement my opinions as a commissioner, with some measure of analytical investigation.

The sketches had no official significance nor did they, when presented for discussion, meet with the unanimous acceptance even "in principle" of the commissioners.

Each study in turn attempted to assimilate in the design, features which had been built or for which the community was committed and in a measure record progress as well as illustrate the need for a flexible and carefully studied plan even when "all outdoors" is available.

Back in the early 50's when Oakland was still a sparsely settled oak-covered plain adjoining the mud flats of San Francisco Bay, the local authorities contracted for a bridge to connect the eastern and western sides of an inlet which was then nothing more than a slough which extended from the estuary to what is now Lakeside Park. As the County could not meet its obligations, the contractors retained title to the bridge and operated it as a toll bridge. About 10 years later Dr. Samuel Merritt promoted the first Twelfth Street Dam, contributing generously to its cost. The body of water thus confined was thereafter called "Merritt Lake" by an appreciative populace. The toll bridge went into the discard soon after and the dam became the major means of traffic between Oakland and Brooklyn Township.

Comprehensive dredging operations about the turn of the century not only changed the lake from a Gargantuan mudhole to a beautiful aquatic park, but reclaimed acres of useless slough south of the "dam" in what later became known as Peralta Park. Shortly thereafter the exodus occasioned by the San Francisco fire and earthquake of 1906 initiated a period of tremendous growth for Oakland, and as much of this new population settled east of the lake, the Twelfth Street Dam which for so many years had accommodated carriages, horse-cars, and finally electric cars, suddenly became an exceedingly busy thoroughfare. This, if no other reason, directed public attention to the necessity of solving what had become one of the worst bottlenecks in the State. The solution, in the opinion of some people, meant merely widening the roadway on the dam; to others it called for a comprehensive program including the development of the entire area in which the traffic problem became the "piece de resistance". It was then that talk of a Civic Center in this area frequently became heard.

When in 1913 the people voted municipal improvement bonds which included funds for a new City Hall and a Civic Auditorium, the advocates of a Civic Center on the lakeshore had high hopes of early and substantial accomplishment in this direction. The new City Hall, unfortunately, was erected on the outmoded site of its predecessor.

The Auditorium, luckily, was located south of the dam facing out over the great aquatic park which is Lake Merritt. The site was well chosen. The alignment of the structure disregarded the eccentric and uncertain bearing of the roadway

along the dam and recognized the east west street system of the Kellersberger Tract, the original portion of the City lying immediately west of the Lake. The full realization of the importance of the site selected in suggesting a pattern for the grouping of the future building cannot be over-estimated although the opportunity thus implied has frequently been overlooked. Dr. Werner Hegemann, in his report on Oakland and Berkeley in 1915, recognized the situation in referring to the Auditorium when he wrote: "This costly monument of civic enterprise . . . may become the nucleus of the future Civic Center." Then he adds a warning which has gone unheeded too often: ". . . the mere placing of buildings symmetrically established no architectural unit."

The potential Civic Center received little attention during the next decade. The few public buildings erected were built on detached sites around the periphery of the Lake. The Veterans' Memorial

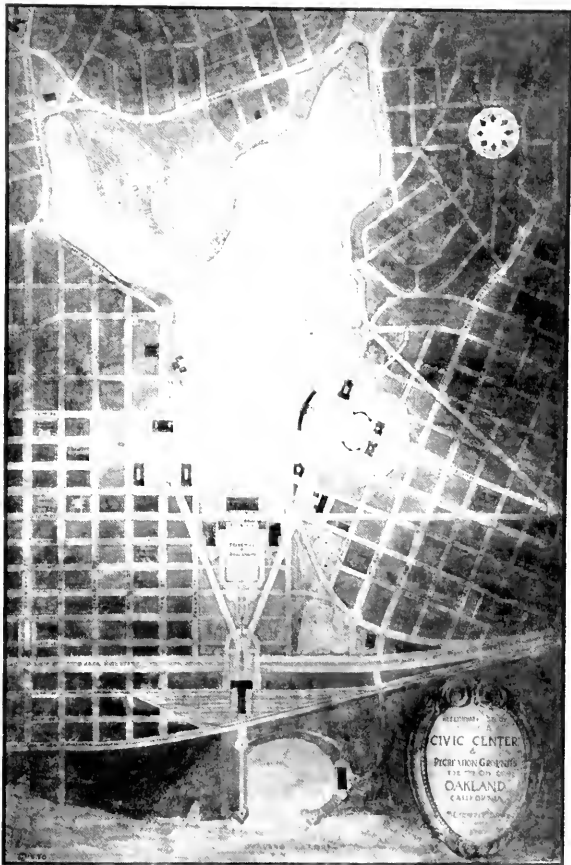

PLATE "E"

Building, the Ethel Moore Memorial and the Board of Education Administration Building were in this group.

In 1926 a group of enterprising citizens organized the "Major Highway and Traffic Committee of One Hundred" and employed Harland Bartholomew and Associates to undertake a comprehensive traffic study and recommend a major street plan for Oakland. The Report published in 1927 not only set up a commendable program, but created a general awareness of civic needs and civic possibilities. The City Council under popular pressure revived an apparently moribund Planning Commission. New commissioners were appointed and late in 1927 the Commission was re-organized. The Commission selected as one of its first tasks a review of the Bartholomew Report to ascertain which recommendations seemed most urgent and possessed promise of early consummation. High on the list was the Twelfth Street Dam traffic problem which for years had been getting worse and worse. To quote from the Report, "It is the crux of Oakland's present traffic problem."

Although the Report as a whole was admirable, it dealt with traffic problems and not with those of civic design, and the proposed treatment of "the dam" emphasized the solution of a puzzle than the development of a plan. (Plate A.) The

two traffic circles which were proposed might, if constructed, freeze the architectural plan of this area as well as the traffic pattern. The circles were rather large and unfortunately were not related to the Lake, the major street system or to the Auditorium. This lack of relationship and relocation of streetcar tracks as proposed would, if adopted, add difficulties in the development of an over-all design for the area.

As the Commission had almost no funds and practically no staff there seemed little chance of carrying on serious investigations of even this one problem in civic planning beyond the conversation stage, and by way of encouragement the City Council in January 1928 transferred the sum of \$175,000, which had been allocated for the improvement of the Twelfth Street Dam, to another fund.

In an effort to sustain interest in the Civic Center idea, I began some studies of the problem in my office during spare time—of which unfortunately there was plenty—and in February presented a scheme (Plate B) to the City Planning Commission for discussion and criticism. The scheme provoked some discussion and much criticism. There were many who could not conceive condemning so vast an area just to "beautify the Lake District" particularly as it lay on the east bank, and the mayor was incensed at the thought of a design which



PLATE "H"

contemplated "filling in the Lake". A photographic copy of the scheme, however, was requested by Mr. Bartholomew's local office and I was later informed the disposition of car lines indicated served as the basis for the "Proposed Permanent Solution of 12th Stream Dam Problem" published in the local papers the following October.

This scheme had two main objectives.

It contemplated clearing the shores of the Lake of small-scale congested developments and applying preventive measures to the problems of traffic and transit congestions by affording "elbow room". The design envisioned the development of a mall a block in width and flanked by public and quasi-public buildings which would debouch on a large place or court overlooking the Lake and the business district beyond. (Plate C.) In this great court, traffic could be easily segregated and controlled.

The development of new and realigned roadways over the dam would allow adequate regulation of traffic and would permit the development of a lagoon to afford the desired transition in scale from the Auditorium and its entourage to the larger composition dominated by the Lake.

Two radial streets comprising an extension of Tenth Street easterly to East Twelfth Street and a new street to the north would serve to disburse west traffic. To provide for a smooth flow of traffic it was proposed to route the streetcar lines along the southerly "leg of Thirteenth Street extension thence through the great place taking them underground into solid ground as they approached First Avenue beyond the old shore line.

By utilizing portions of newly created open spaces, a plan of underground distribution was contemplated so that each "line" could be brought to the surface in the center area of the streets which were destined to carry transit traffic. The plan would provide solid building ground on the east shore leaving the filled marsh land adjacent to and south of the Auditorium for much needed park and recreation areas. The scale of design was such that regardless of how details of its development were modified in execution, the basic plan could be retained and would afford visitor and commuter alike an inspiring approach to the City's center through its Civic Center.

Interest in civic centers waned until the papers announced the early construction of a new Post Office Building and an Exposition Building. Seeking safety in numbers, a group of local architects were invited to my office toward the end of 1928, and the general problem of a Civic Center together with what studies and data I had assembled were presented and the group was urged to undertake the preparation of a plan for a Civic Center as a public contribution of the Society of Architects of Alameda County.

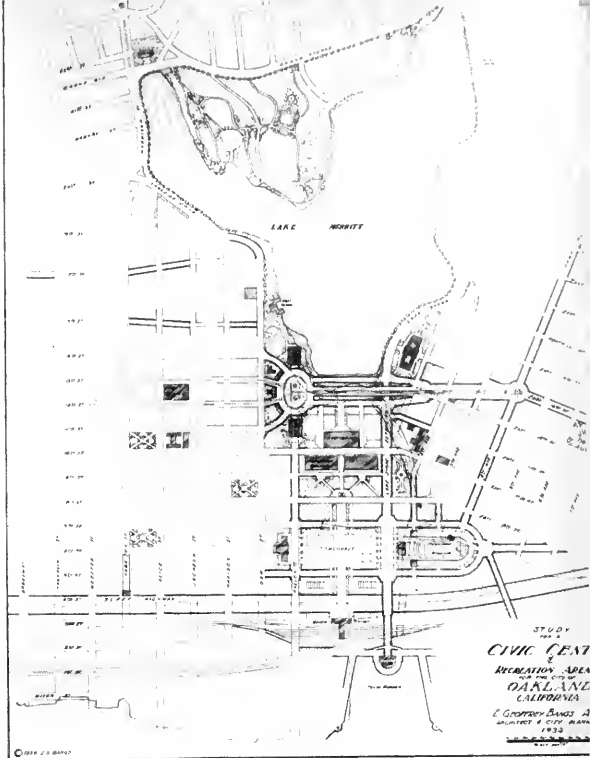

PLATE "G"

Before much could be accomplished the site of the Post Office was selected "without benefit of plan" which was doubly regrettable in the face of the Post Master General's attitude who, that same year (1929), in a letter confirming the site for the post office in St. Louis, wrote, "It is my belief that when the citizens of any of our great American cities evolve a definite plan for rebuilding their city in whole or in part and contribute their own money generously to the enterprise, the Federal Government should co-operate to its fullest extent consistent with public interest."

Work on the Society of Architects' plan was finally concluded and as the design fell so far short of early hopes and aspirations, it was decided to submit the scheme in the form of a model. (Plate D.) Miss Julian C. Mesic was engaged to prepare it and following presentation to the City Planning Commission, it occupied a prominent if innocuous berth in the offices of the Commission for several years.

The model was beautifully executed but as a design showed many of the weaknesses inherent in compromise plans which while seldom bad, rarely rise above the plane of mediocrity. The

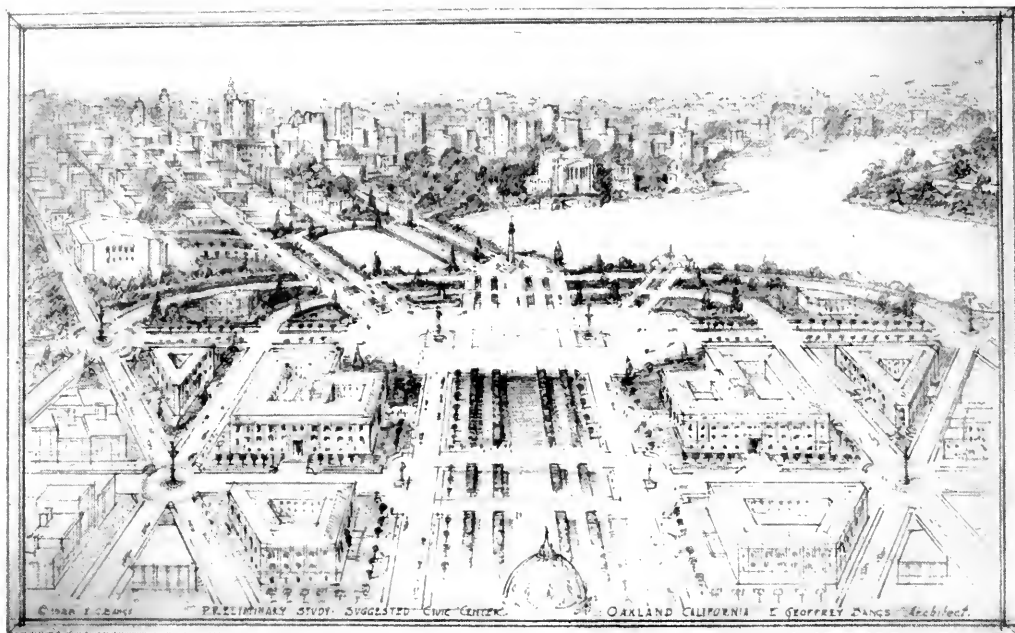

PLATE "C"

chief weakness lay in the fact that much traffic would be compelled to travel parallel to the major axis of the Civic Center and thus the Civic Center became a glorified divided thoroughfare. The arrangement of plan also tended to emphasize the division in the composition created by the Auditorium and the adjacent buildings with a noticeable change of scale between the area to the north of Twelfth Street and that to the south. The model had the inestimable value of developing a "plan consciousness" among some officials and citizens even at the risk of accepting it as THE plan.

More "spare time" prompted me to undertake the study of a new design in an effort to overcome some of the features of the Architects' Plan which were not appealing.

The new study was developed at a smaller and more elaborate scale than the earlier studies and was designed more around the principle of a series of nuclei of buildings and courts. (Plate E.) It also retained the thought originally suggested in Scheme A (Plate B) of dispersing the maximum amount of westbound traffic by radial streets originating at about Seventh Avenue.

The use of "nuclei" or clusters of buildings grouped around open courts which in turn were integrated into a larger cluster grouped around a court made by the Lake itself seemed to offer a flexibility not found in other studies. In each

nucleus were grouped buildings of similar types or functions. For example, the "Auditorium Group" in the center was considered to consist of one or more Exposition Buildings whose functions and use would be complementary.

These buildings, with the Auditorium, were so grouped around an open court or drill ground to permit their use jointly or individually for exhibitions and fairs of all sorts where large numbers of participants and spectators would be involved. To the west of this group and nearer the business and financial center of the City was located a somewhat formal composition, the "Political Nucleus" consisting of County, State and Federal buildings.

(The present Court House, incidentally, is almost in the center of the court of this group.) Along the east shore of the Lake, as a counterpart to the political group, was arranged a somewhat less austere composition which might be called the "Cultural Nucleus", consisting of, from left to right, an art gallery, a library and a museum. (Plate F.)

In the case of the museum it was suggested that outdoor as well as indoor space be provided for obvious display reasons. The design also attempts to embrace the Ethel Moore Memorial and Board of Education Administration Building in what might be considered an educational or social service nucleus.

As in the case of the Architects' Plan, a union station is indicated. This station would be reached from the primary centers of radial avenues passing over the much discussed super highway at Fifth Street. In this plan an attempt was made to provide approaches to the several civic groups which would not only give significance to the groups themselves but would afford a recognition of the dominant composition from a human or ground level.

In contrast to the Architects' Plan, it was felt that a "Parti" such as this might withstand the rigors of radial modification and still permit realization as a unified composition.

Recent improvements, including the newly erected Exposition Building, had created new shifts in emphasis in the over all pattern that was developing. With the selection of a site for the new Court House reaching the "free-for-all" stage, it was difficult to keep out of the fight, and in the summer of 1933 new studies were begun. As the opportunity for expansive planning was being constantly curtailed, effort was now directed toward determining sites for the impending new buildings which might enhance rather than cripple a monumental treatment of the dam.

The result of these studies is shown in the accompanying line drawing. (Plate G.) The heavy lines indicate either new streets or widening, as it was desired to indicate in part how little new work well placed would be necessary to provide some degree of order in the amorphous growth which was slowly encroaching on the precious breathing space so close to the heart of the City. Here again an effort was made to reduce traffic



PLATE "B"

PLATE "D"



congestion over the dam by separating the street-car lines from the other traffic as quickly as possible and again on the east side of making final distribution underground. Traffic disbursement and collections on the west side of the Lake would be achieved by a large court (Plates H & I) flanked on the south and north by a proposed Court House and Library (the general locations for which had been given in campaign literature).

A grade separation at Lakeshore extension would eliminate practically all left turns and permit a gradual disbursement or convergence of traffic rather than a precipitate and intense concentration as is implied by traffic circles.

The severance of the south portion of the site by the unfortunate orientation and location of the Exposition Building has been acknowledged in the design by reorienting the "Exposition Building Annex", and relegating the entire area south of Tenth Street to a rather independent composition connected only by Lakeshore Boulevard.

This plan differs markedly from the earlier ones of 1930 in that it emphasizes the importance of traffic routes rather than the design and grouping of open spaces.

There has recently been prepared by the East Bay architects a new model which varies only slightly in part from its predecessor. It is up to date in that it shows the Court House and the Exposition Building in their actual positions but it has lost some of the simplicity and unity apparent in the first model, while south of the Audi-

torium the indecisive overlay of roads or streets would, if constructed, be a source of acute traffic confusion.

By slow time and accretion, Oakland is developing her precious heritage—the Lake and its environs. History and experience have shown that such a process begets too many costly and permanent errors to make a continued program of planless planning worth while.

It must never be forgotten that a Civic Center is not an agglomeration of public buildings any more than a pile of bones is a human skeleton, nor can the appropriation of park lands and other open spaces for the erection of tax free structures be dignified by such a name.

A Civic Center is the assemblage of structures of accepted monumental character whose masses are suitably disposed in an arrangement which gives unity, scale and grandeur to the composition. It is the embodiment of that elusive phantom called civic pride. Without these qualities the mere grouping of buildings affords only convenience, and the fountains and landscaping become merely window dressing.

A Civic Center is the embodiment of that elusive phantom called civic pride and can not be acquired by conversations, committees and reports.

Only by imagination and a stubborn adherence to high principles of design, implemented by popular support and money can any significant success in this expression of civic aspirations and enterprise be attained.

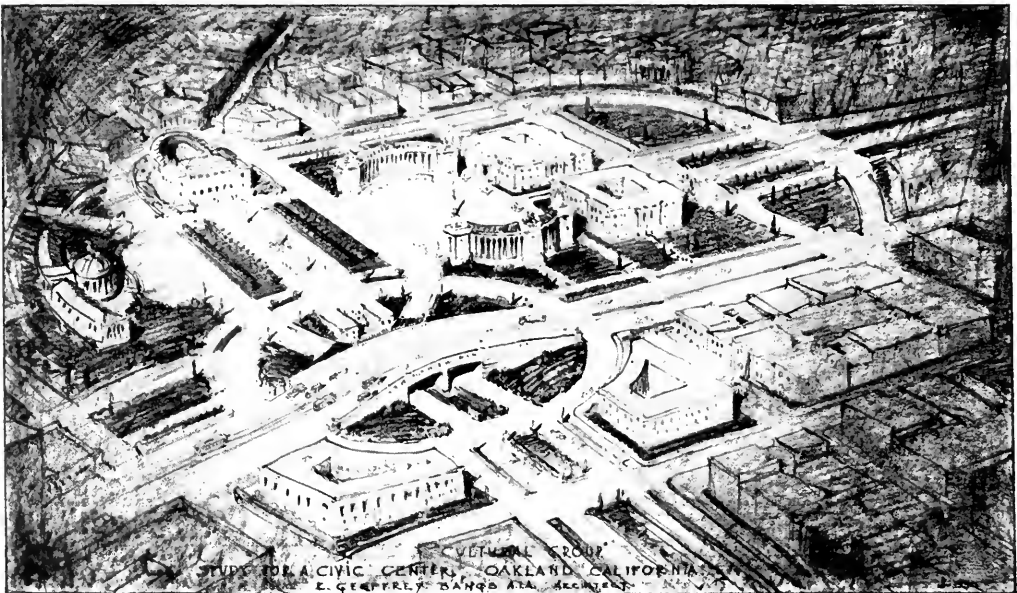

PLATE "F"

IN THE NEWS

Mark Falk and Ernest J. Kump, Structural engineer and architect, respectively, both of San Francisco, were decorated with the Navy Meritorious Civilian Service Emblem for their aid in the design and expansion of air bases involving \$35,000,000 worth of construction. Vice Admiral Moreell did the awarding.

NEW SYNTHETIC RUBBER USES

With announcement of a new compounding ingredient, The Goodyear Tire & Rubber Company expanded synthetic rubber's range of usefulness to a host of products formerly confined to natural rubber.

One definite result of the new development, a resin obtained from a special type of synthetic rubber, is to increase the availability of the nation's natural rubber stockpile to products for which synthetic rubber is still unfitted. Another is to enable production of items heretofore considered impossible with synthetic rubber.

This synthetic rubber resin imparts rigidity to synthetic rubber itself and is important for wire and cable insulation, safety helmets, golf ball covers and similar products where an extremely rigid, lightweight, impact-resistant product is desired.

Replacing carbon black, heretofore considered solely feasible for synthetic rubber compounding, the new resin permits production of synthetic rubber products where colors are desired, as in household and decorative items, toys and kitchen equipment, and where the high resistance to electrical currents is required.

OPA SPEEDS GOODS PROCESSING

With the vesting of pricing of new civilian goods in the San Francisco District office of O. P. A. much of the delay in the processing formerly done in Washington, D. C., has been eliminated. The District Director, Robert B. Parks, is bending every effort to speed up the pricing of building materials such as plumbing fixtures, roofing materials, paints and varnishes, etc., manufactured on the coast.

GIVES APPROVAL

Secretary of the Interior, Harold L. Ickes, has announced through Charles E. Carey, Director of Region No. 2 of the Bureau of Reclamation at Sacramento, that he is in favor of the plan of River

Authorities and that each should operate autonomously, but should be integrated into a national program. Since the Department of the Interior is the custodian of so many lands it seems the logical coordinator of the program.

NEW "STOP-ALL" GREASE INTERCEPTOR

Designed to offer protection against clogged drain lines, a new low-cost grease interceptor has been announced by the Wade Manufacturing Company, of Elgin, Illinois.

Manufacturers of plumbing specialties since 1865, Wade has long supported the plumbing industry in pointing out the need for grease interceptors in modern plumbing practice.

Now offered as an answer for those many, many homes where initial cost has been a barrier the "STOP-ALL" is made of finest cast iron with baffles cast right in place. Large 1½" tapped openings make it easy to install; wing nuts on cover make it easy to clean.

PRIVATE CONSTRUCTION IN 1945

(From Page 13)

likely that the H-2 housing program, now designed to permit the building of 100,000 housing units in congested war production areas, would be expanded considerably, and that the total volume of new private residential construction would rise to about \$1,240,000,000 as compared with \$500,000,000 in 1944.

The Council's Committee estimates that private industrial building should increase from \$170,000,000 in 1944 to \$460,000,000 in 1945, if restrictions are liberalized fairly early in the year, and that construction by public utilities should rise from \$490,000,000 in 1944 to about \$620,000,000 in the new year.

The volume of construction by the Federal and local governments is estimated at just short of \$2 billion, a drop of about \$400,000,000 from the 1944 total, if the war in Europe ends during the first half of the year. The major declines would probably occur in the volume of government-financed war housing and of military and naval construction.

However, those declines would be accompanied by increased expenditures for highway construction, which might reach a total of \$665,000,000 or more than double the 1944 figure, if developments in the war make it possible to release sufficient manpower, materials, and construction equipment for this purpose early in the year.



Apartment Building, Mexico City, D. F.

MARIO PANI, Arquitecto

A CALIFORNIA ARCHITECT IN MEXICO CITY

By WM. ARTHUR NEWMAN, Architect*

Will Rogers once said: "The thing that strikes me is that we go away over to Europe and prowls all around hunting for odd and different things, and here they are at our very doorstep. There is more quaintness and different things to see here in Mexico than I saw in the whole of Europe."

Although we are close neighbors, many of us confess that our former acquaintance across the Border consisted in the rather unattractive border cities. On arriving in Mexico City, however, you will be greeted with a real surprise.

Today this metropolis has the opportunity of developing into one of the most beautiful capitals in the world. As you drive about the city among the numerous lovely parks and well paved boulevards, you may recall that 400 years ago many of these same *avenidas* were canals where the Aztec Indians paddled their canoes.

It was here the Spanish Conquistador Cortes in 1520 found Montezuma's capital of 25,000 Indians, named by them Tenochtitlan, located on a small island in Lake Texcoco, 7500 feet above sea level. This lake was later drained to make space for the expansion of that village, now renamed Mexico City, having a population of nearly 2,000,000.

*When Mr. Newman opened his architectural offices he was one of the first tenants to occupy the Hewes Bldg., at Sixth and Market Sts., San Francisco. Later, for eighteen years he supervised the construction of all U. S. Public Buildings in the seven western states, Alaska and Hawaii. For the past two years he has been living in Mexico.

Some beautiful morning, and most of them here are beautiful, you, as an architect or engineer, will enjoy a stroll along Paseo de la Reforma,—the Champs Elysee of America. You pass along two miles of trees, lawns and shrubbery interspersed with monuments to Mexico's historic figures. Glancing left and right among the trees you discern well designed stone palaces and stately residences,—a bit of transplanted Europe,—France, Spain and the Mediterranean.

Yes, there are odd and different things here. Your attention is distracted from the beauty of your surroundings by hundreds of racing automobiles, by vendors of fruits, lottery tickets, shoe-shine boys, and by the barefoot Indian men, women and children; each woman usually with a baby wrapped in her *rebozo*.

Here and there on the Paseo you observe the beginnings of a transformation. Older buildings are being replaced by stores, apartments and offices, much to the dismay of lovers of the architecture of former times.

Passing the equestrian statue of Charles IV, of Spain, you reach Avenida Juarez and Alameda Park,—a center of the new business district, where twelve to twenty story office buildings and modern hotels are under construction.

You pause to admire the new steel structures going up all about you, and the completed edifices with their broad marble and bronze entrances and inviting lobbies.

Across the Avenida in the Park is the hemicycle marble monuments to former President Juarez, crowds gather to celebrate special events. From the shadow of the Park you see the noted Carrara marble Palace of Fine Arts, a community center

for drama and the arts. To the east is the main Post Office and Banco de Mexico (the federal reserve bank), the Guardiola and other principal office buildings in the city.

All about you are busy crowded thoroughfares. You note temporary board fencing. You hear air drills on buildings being wrecked for street widening. As an architect and engineer you are gladdened by the steady thump of the piledriver, the noisy rattle of the riveter, the shrill whistle of the derrickmen, and you concede that in the construction industry, here is prosperity.

Entering narrow Avenida Madero and the main shopping district you find yourself in the midst of old Spanish Colonial palaces, today remodeled for commercial purposes. Shortly you reach the Zocolo—the great Plaza de la Constitution, surrounded by the Cathedral, the Palacio Nacional

(offices of the President of the Republic), Palacio Municipal and el Portal de Mercades. All of these are of architectural interest and will be described later.

You now turn to the quieter residential district where many storied new apartment buildings attract attention. Architect Mario Pani has designed some interesting ones,—with a freedom from the conventional that intrigues you. Perhaps this is due to his Paris training at the Ecole des Beaux Arts, or from his more than ten years' experience interpreting the Mexican and modern trend. He is a young man of pleasing personality, and while busy as an architect, still has time to publish a creditable magazine "Arquitectura," issued six times a year.

A typical example of Senior Pani's work is Calle Balsas 37, on a small corner lot (illustrated



Distinctly modern

is this new

Apartment Building in

Mexico City, D. F.

Designed by

Mario Pani, Arquitecto

ARCHITECT AND ENGINEER

Looking out of roof garden,
Calle Balsas Apartment building,
Mexico City, D. F.

Mario Pani, Arquitecto



herein). The exterior is faced with light cream artificial stone slabs, except the circular motif of the living rooms, where flat buff tile are laid on edge; balconies are finished in light stucco.

Apartments consist of a living room, with dining section above, and open in the living room,—a library, bar alcove, two bedrooms, each with bath, and a kitchen. All have modern equipment; living rooms with indirect lighting, and the apartments beautifully furnished. With garage space, maid service and telephone, the minimum rental is 90 pesos, or \$18.00 a day.

Another apartment building by this architect is Reforma 334, on a small lot where somewhat similar exterior treatment is used. The light circular feature on the front is for fireplaces and chimneys in the living rooms.

Rincon del Bosque 25 is a three-story apartment building of unique interest, designed also by Mr. Pani, with the facade faced with light stucco and a similar flat tile wall treatment over main entrance and garage.

You may wonder why so many of the lots on which these apartments are constructed are small and irregular in shape. Not infrequently the answer lies in the fact that many a Mexican owner is disinclined to adopt the American businessman's point of view in the accumulation of wealth. You may wish to round out your property by including a neighbor's piece, and you offer the Mexican owner a reasonable price.

It is quite possible he will decline to sell. You make him a better offer considerably above its value. This offer may again be respectfully de-



Left is view in typical living room
looking towards circular windows—
new apartment building,
Mexico City, D. F.

Mario Pani, Arquitecto



Left: View in private study
or library of apartment building
in Calle Balsas, Mexico City, D. F.

Lower: Detail of main entrance
to same building.

Mario Pani, Arquitecto



Right:

Mexico City looking northeast towards the business center, showing Paseo de la Reforma in the foreground.

Photo by
Wm. A. Newman
November, 1944



Left:

Rear view of Rincon Del Bosque
Apartment Building in
Mexico City, D. F.

Mario Pani, Arquitecto



Right:

Main Front of Rincon Del
Bosque Apartment Building
in Mexico City, D. F.

Mario Pani, Arquitecto



clined. He doesn't need the money. His requirements are provided for. He doesn't wish to be disturbed. So there is nothing you can do about it, and you get along without it.

In our western states we use much frame construction, but this is not permitted in Mexico City for permanent buildings. Prices of lumber are high, and each piece of staging is carefully handled and preserved. Builders have found other materials available. In the suburbs are immense fields of durable dark gray volcanic stone. Brick and tile are burned within the city limits. Lime is plentiful in adjacent mountains, and the local cement plant works overtime. Much reinforced concrete construction has been adopted for all classes of work.



Apartment Building, Paseo De La Reforma, Mexico City, D. F.

Mario Pani, Arquitecto

Adobe buildings, not only for the poorer classes of dwellings, but for almost all others, have been erected and used here from the beginning of the settlement. Many such buildings can be found in use today that are 200 and 300 years old.

Mexico City is practically fireproof construction and has fairly well withstood the elements, earthquakes and settlement due to foundations in the soft mud of the old lake.

While prowling around among the new buildings, hunting for those unusual and different things, the other day there sounded down the street the tread of marching feet. A parade appeared a block away, winding its way among trucks loaded with building materials.

Cheerily these braceros (or farmers) from the country, clad in overalls, headed for the Presidential Palace carrying banners lettered in Spanish "We love our country, Senor President, but desire permission to go to the United States to assist in war work." I was spotted as an American by a dozen or more, who passed friendly remarks in Spanish: "Americans are O. K.", enthusiastically I responded: "Viva Mexico!" Like an electric shock instantly grins lighted 500 faces, and back came the shout: "Viva Estados Unidos!"

In the following issue there will be described opportunities offered the architect and engineer, and more odd and interesting things seen by a California architect, in Mexico City.

RUNNING FIRE

(From Page 4)

CLICHE'

On just what basis the philologists determine that an expression is cliché is doubtful, or why it should become so. Some think it is a result of a lack of vocabulary and others that the users are too lazy to think of the right word to use. Certain it is that the cliché phrases have shrunk to single words. "Outstanding" is one that has been worked to death, and "definitely" is another, although these are not misleading in meaning. Now come two and three word clichés, mostly oral, which are becoming a real curse. "You know," is now an oral habit with many people and, finally, "SMART" has got most of us down. In architecture, that word "smart" is "throwing us off the beam". The room must be "SMART". Red drapes would be "SMART". A pink bow on the ash can would be "SMART". The living room has **got** to be "SMART". There was a time when we said of an intelligent child that he was smart, bright, quick or clever. Now it is different. We mean that he is—oh, "you know", "SMART".

IN THE NEWS

CALIFORNIA STATE BOARD OF ARCHITECTURAL EXAMINERS

At a recent meeting of the State Board of Architectural Examiners, the following having passed the examination for architects' licenses, were granted provisional certificates:

Gregory Ain, 7964 Willow Glen Road, Los Angeles, Certificate No. P-337; Wallace John Alexander, 2109 Vee St., Sacramento, P-338; Clarence Barton Alford, 216 Pacific St., Bakersfield, P-339; Benjamin Hall Anderson, 1527 N. Hoover, Los Angeles, P-340; S. Robert Anshen, 2512 Leavenworth St., San Francisco, P-341; Andrew N. Balfour, 826 Garfield Ave., So. Pasadena, P-342; Joseph Cyril Berry, P. O. Box 66, Inyokern, P-343; Clifford Watson Branson, 124 Melrose Ave., Monrovia, P-344; A. MacKenzie Cantin, 704 Market St., San Francisco, P-361; Norman Burns Entwistle, 1948 Juanita, Pasadena, P-345; W. Roland Gibs, 6144 Rockridge Blvd., So., Oakland, P-346; Edward Francis Glass, 965 Union St., San Francisco, P-347; Henry John Jefferson, 8126 Harcourt Ave., Canoga Park, P-348; Oram A. Jenkins, 277 Pine St., San Francisco, P-336; Robert Charles Kaestner, Jr., 76 Broadmoor, San Anselmo, P-349; John Gregory Kelley, 246 Gravilla St., La Jolla, P-350; Walter Nathan Montgomery, 3039 Mayfield Ave., La Crescenta, P-351; Clarence Joseph Paderewski, 1849 Lyndon Road, San Diego, P-352; Ulrich Hermann Plant, 850 N. Kenmore Ave, Los Angeles, P-353; William H. Porter, 7449 Herschel St., La Jolla, P-354; Rodney Thoburn Robinson, 2634 Myrtle Ave, San Diego, P-355; Nicholas A. Tomich, Rte. 5, Box 7978, Sacramento, P-358; Van Lee Schmidt, 2622 Harcourt Ave., Los Angeles, P-356; Louis Carl Simmel, Jr., 2601 E. California St., Pasadena, P-357; Peter Joseph Weber, Rte. 3, Box 58, Riverside, P-359; C. Day Woodford, 2040 El Arbolita Drive, Glendale, P-360.

OF INTEREST TO THE ENGINEERS will be the announcement that Carl E. Nelson and George E. Skaggs of the San Francisco office of the Donald R. Warren Company, were recently presented with meritorious service medals by Captain Schneider of the Twelfth Naval District, at a dinner given in their honor at the Athens Athletic Club.

Captain Schneider expressed a deep appreciation for the services of these men and stated that undoubtedly there were many more in the organization who had given service which would warrant such commendation but that the Navy was limited as to the number of awards it could make

The reward was made for engineering designs prepared for the San Francisco area of the Bureau of Yards and Docks.

AND THAT WALTER S. DUNKER has been appointed assistant treasurer of the American Steel and Wire Co., subsidiary of the U. S. Steel Corporation.

SHASTA LAKE, created by Shasta Dam, now contains 1,283,000 acre-feet, so we can drink for a long time (Water, of course).

Storage at Shasta Lake during the late winter and spring months of 1944, made it possible to generate 255 million kilowatt-hours of electric power and energy and to supply from storage Sacramento Valley irrigators during the past summer with 258,000 acre-feet of water which otherwise would have been lost into the ocean. Late summer and fall releases retarded the encroachment of sea water and, therefore, held salinity in the upper Delta channels to a safe minimum.

The combined storage of Central Valley Project reservoirs on December 13 amounts to 1,470,000 acre-feet or 490,000 million gallons, which is sufficient water to furnish a city the size of San Francisco with its entire supply for approximately 17 years.

Dean LEOPOLD ARNAUD of the COLUMBIA SCHOOL OF ARCHITECTURE, in his report to President Nicholas Murray Butler, states we may look for a stupendous building program which may require two generations to complete which, if true, means that none of us will live to see it through. He goes on to say that the launching of this program is a young man's job, requiring a new and fresh approach. He goes on to say: ". . . all the European countries will be in tragic condition in so far as professionals are concerned. For over five years their schools have been closed, or virtually so, and their youth has been called for duties far removed from their schooling."

EDW. L. SOULE, president of the Soule' Steel Company, has announced the retirement from active duty of Vice President and Los Angeles General Manager, Mr. N. E. Dawson, who has served at Los Angeles as manager for 20 years. Mr. E. B. McClure has been elected to succeed Mr. Dawson and will be in complete charge of Los Angeles operations.

Normandy Invasion Those Portable Ports

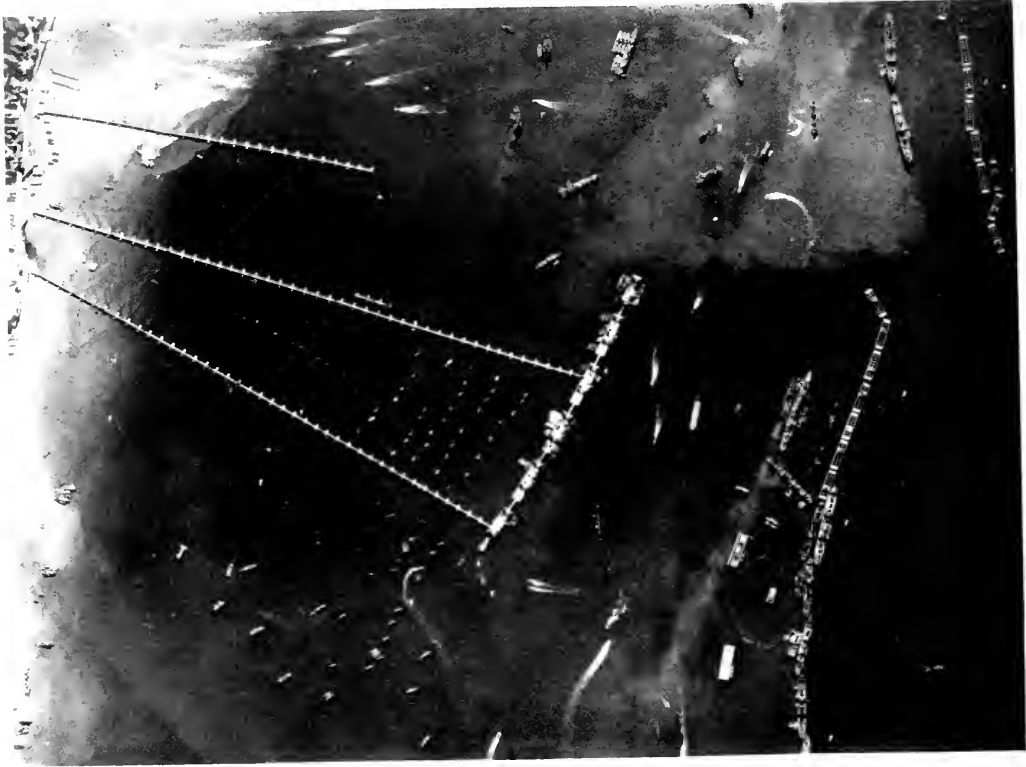

British Official Photo

Aerial view of a section of the British prefabricated harbor on the Normandy coast. Two steel roadways supported on special floats lead from the shore to a wharf formed by spud pierheads. In front of the wharf is a breakwater of concrete caissons and blockships.

At the prefabricated harbour on the Normandy coast, ambulances move along one of the pier roadways leading to the wharf. This steel roadway, hundreds of feet long, is a series of small bridges joined together by special means to give flexibility and supported on floats so that it can rise and fall with the 20 foot tide.



One of the most remarkable engineering feats of all time was the provision of two prefabricated harbors on the coast of Normandy without which the liberation of Western Europe would not have been possible. To provide the invasion forces with the necessary stream of supplies and reinforcements two synthetic harbors, each the size of Dover, were prefabricated in Britain, towed across

the Channel and set down on the coast of Normandy. Concrete caissons, floating breakwaters and piers, all component parts of these harbors, were made in Britain. Final setting-up of the American harbor was the responsibility of the U. S. Navy while that of the British harbor was a combined Royal Navy and Army responsibility



Ambulances bring casualties to a hospital ship tied up at the LST pierhead at prefabricated harbour on the Normandy coast while Army Fire Service vehicles are being discharged from landing craft (tank) in right foreground. By fitting a false beach onto which the LST runs its bow and lowers its ramp the same type of spud pierhead used to form the wharf was converted for use by landing craft.

The Outlook for Residential Construction

By **W. C. BOBER, Economist**

Johns-Manville Sales Corporation

Here is an analysis more in detail and more exhaustive than most and one that justifies full presentation.—EDITOR.

The long-term outlook for home building is more favorable than at any time in our history. The short-term outlook, however, naturally depends on the progress of the war. The outlook for the year 1945 is only fair for reasons I will discuss herein.

Just before we entered the war, in 1941, single family home construction was proceeding at almost boom proportions and we built in that year the greatest number of homes since 1928. I well remember that in the summer of 1941 predictions were widespread throughout the entire building industry that the boom would continue and it was widely forecasted that home building would make new all-time highs in the succeeding two or three years. Building men were loath to believe that it was possible that events in Europe and Asia could abruptly bring an American home building boom to a standstill. Yet it happened. Instead of an all-time high of home building in 1944, we experienced almost an all-time low. Private home construction is at present around the level of the deep depression of 1933 and 1934.

We must not again make the mistake of underrating the effect of events abroad. There is nothing more important right now to the American building industry than a realistic appraisal of the progress of the war. The excessive optimism of last August and September that found expression in the widespread belief that Germany would collapse in October and the European war come to an end before the end of 1944 has largely evaporated. Weather plays a tremendous part in military operations, particularly in Western Europe where fog, rain, and mud deprive us of many of the advantages that come from our great superiority in military equipment and manpower. For all most of us know, Germany may now be a hollow shell and a collapse of the will to fight may come any day. But one cannot count on that and certainly our Armed Forces aren't. There is still the decided possibility that the European war may require a spring and even summer campaign in 1945. If that should be the case, we cannot expect anything but an insignificant volume of home building next spring. As long as the European war continues labor and lumber, in particular, will be very scarce. After Germany's defeat, there is Japan and Winston Churchill has already warned

us against those imaginative strategists who would transfer fleets and armies and the whole gigantic paraphernalia of war from the Atlantic theatre to the Pacific as easily as they would help themselves to a plate of soup. It will take time and involve a great strain on our transportation system and we must not expect that all lights will at once turn green the moment Germany is defeated. Nevertheless, the end of the German war will result in very large cutbacks in war production and unemployment unless reconversion gets under way rapidly and assuredly one of the most effective industries to mop up unemployment is homebuilding. This will be recognized by the whole country in due time.

As regards the short-term building outlook, if military operations against Germany should require a major spring campaign extending perhaps into the summer, it is unlikely that homebuilding volume will be materially different from the very low level of this year. From the close of the war on, the rise would begin but we cannot, of course, immediately jump back to the over 700,000 home units volume of 1941.

As to the long-range outlook for homebuilding after the war, the prospects are brighter than in any period of our history unless we allow ourselves to be overwhelmed by depression and defeatism. In the quarter century after the First World War, that is, from 1920 to 1944, we had a great homebuilding boom, a great depression, a very mild recovery, and then again an almost unprecedented decline in normal homebuilding as a result of a second great war. The net result of these ups and downs since World War I is that, although a total number of very roughly 13,500,000 new families were formed from 1920 to 1924 inclusive, the total number of **permanent** usable homes built in the non-farm areas in this quarter of a century was only about 11,750,000. But from this latter figure, we must deduct at least 600,000 homes that were built in the early years after World War I, not to house the current increase in families, but to make good the shortages produced by that earlier conflict. We must also deduct at least 200,000 permanent homes that were built in the latter part of this quarter century, that is in the World War II period, not to house the current increase in families in places where they would ultimately dwell in

NEWS AND COMMENT ON ART

(From Page 13)

peacetime, but as emergency war housing in localities where they are almost certain not to be needed for current family formation after the war. Thus, in effect, we built appreciably less than 11,000,000 useful and usable non-farm homes to really serve the needs of 13,500,000 new families, the great majority of whom are non-farm. Hence, we have a great housing shortage today, amply proved not only by current observation, but by vacancy ratios that in many areas have dropped to levels almost unprecedented in American history.

We have a quarter-century-long housing shortage to make up that can hardly be much below 2,500,000 homes. Over a ten-year period that requires the building of 250,000 homes annually. Then we need approximately 550,000 new homes currently each year for a sustained period for current new family formation after the war. We also need approximately 100,000 new homes each year to replace those destroyed by fire, flood and other natural calamities, and by demolition—a factor which has grown importantly in the last ten years or so. Moreover, we need a reserve of homes so as to reestablish the normal approximately 5% vacancy ratios as the present excessively abnormal ratios in many localities permit no choice whatsoever for home-seekers. Thus, we need at a minimum close to a million homes a year for a sustained period if we are not to have excessive overcrowding and a state of affairs in regards to the supply of homes that the people of this country are certain not to tolerate for very long after the war. Keep in mind, however, that I am here talking of housing **needs**, not of commercial demand, which is a very different thing and which depends basically on the national income level we will get after the war.

But this estimate of needs makes no allowance for two highly important factors: (1) **The automobile revolution has far from run its course.** The desire on the part of great numbers of people in the centers of towns and cities, to move out to the periphery and well into the suburbs, is certain to continue. It is one of the most striking features of the age, the product of the great revolution in transportation methods. We probably need a quarter million homes a year for some sustained period to enable people to live where they can best use their cars. (2) **The replacement of existing homes.** The unsatisfactory condition of a large part of our housing plant is too well known and has been sufficiently brought out by the Housing Census of 1940. My limited time does not permit going into details, but one thing is certain and is receiving almost universal recognition and that is—that a large replacement market is coming into sight for the homebuilding industry for the first time in its history.

SAN DIEGO ACQUIRES AN EPSTEIN. The Fine Arts Gallery of San Diego, by virtue of the Towle Fund, is now the proud possessor of a bronze portrait of the Russian dancer Pola Narenska, a really fine and typical Jacob Epstein portrait. The sculptor considers his portrait work every bit as important and worthy as any of his other work, which would make the acquisition of the curly-lipped Russian bachante a lure to the museum.

Jan Reiner, two of whose articles appeared in *Architect and Engineer* during the latter part of last year, will deliver a series of illustrated lectures on Modern Architecture at the San Francisco Museum of Art in the Civic Center. They will be given as follows:

January 24	From Pyramid to Skyscraper
January 31	The Language of the Architect
February 7	How Old Are the Modern Cities?
February 14	The Modern House and the Interior

Bronzes by Arthur Putnam will be on exhibition at the California Palace of the Legion of Honor, opening January 15th. They are from the Spreckels Collection which contains many works that we who knew Arthur in the years he worked in San Francisco will delight in seeing again. Re-viewing the work of one of the world's great sculptors, much of which was done in our own city, is made possible to most of us through the Spreckels collection.

During the month of January the **California Palace of the Legion of Honor** in San Francisco will have on exhibition a collection of "British Woodcuts," 56 prints by members of the Society of Wood Engravers.

Bay Region Exhibitors in San Francisco Art Association Annuals, 1935-1944, will hold an exhibition of works selected by vote of fellow exhibitors.

CASH CATALOG READY

Featuring detailed information and specific data on the complete line of CASH-ACME Automatic Valves and Pressure Controls for use with water, air, steam and oil, and containing the information that production facilities are now geared to make prompt shipment, a new catalog for 1945 has been issued by the A. W. Cash Valve Manufacturing Co., Decatur, Illinois.

IN THE NEWS

HEAVY DUTY TEST CLAMPS

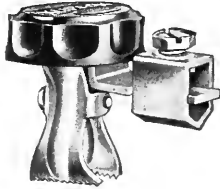

A new test clamp line, employing tremendous jack-screw gripping action for making heavy duty temporary connections — motor and meter testing, jumpers, cable and bus-bar taps, battery charging, welding and many other shop and laboratory purposes—has just been announced.

A slight twist of the finger-tip safety nob exerts tremendous pressure, supplying large carrying capacity of 20 to 350 amperes on constant and intermittent duty.

Solderless lugs provide perfect and quick electrical connections without the use of special tools or cutting into wire.

This new product is available in sizes to fit across ferrule and knife blade fuse clips, switch blades, round or flat bus-bars and cables.

Complete details may be secured from Trico Fuse Mfg. Co., Milwaukee, Wisconsin.

MARBLE SIZE FLUORESCENT LAMP

A new type of glow lamp which is about the size of an average marble, puts out continuously more light than a quarter watt neon glow lamp with an energy input that in a year's continuous burning does not add up to one kilowatt hour. In a year, at average domestic power rates, it will consume less than three cents' worth of energy.

The glow lamp actually is a miniature fluorescent lamp.

The light emitted by this lamp falls in the region of night sensitivity of the eye. For example, held beside a neon glow lamp of the same wattage in the daytime, the two lamps would be judged of equal brightness. However, to eyes dark adapted, the green glow lamp would be said to be four times brighter, and is ideally suited as a night light in bathrooms, stairways, and halls.

It is possible that later larger sizes, up to one watt, may be made for use as markers and indicators on panels and other industrial applications. Civilians must wait for the war's end before these lamps will be available to them, according to the Westinghouse Electric and Manufacturing Company, developers of the lamp.

PROMOTIONS AT STANLEY WORKS

Important promotion of high ranking executives at The Stanley Works, effective January 1, 1945, as announced by President Richard E. Pritchard, included:

John C. Cairns, who has been vice president in charge of the Hardware Division, will direct the Hardware, Hand Tools, Electric Tools, Pressed Metal and Steel Strapping Divisions.

Patrick F. King, Vice President in charge of hardware sales, will become Vice President in charge of the Hardware Division.

Rodman W. Chamberlain, Assistant General Sales Manager of the Hardware Division, will become General Sales Manager of all hardware sales under Mr. King, and W. Ronald Morse is promoted to Plant Superintendent in charge of all hardware manufacturing.

All of the officials promoted are well known citizens of New Britain, Connecticut, and widely known in the builders' hardware industry.

WILL DESIGN NEW BUILDING

The Board of Regents of the University of California has selected Miller and Warricke of Oakland, California, to design the new Forestry Building on the Berkeley Campus which will cost \$600,000. Arthur Brown, Jr., will be the supervising architect.

ROMANTIC STORY OF MISSIONS

"California Missions," by Kenneth C. Adams, Editor of "California Highways and Public Works," is as good reading as can be found on the subject of this ever fascinating topic. The article in the current issue is the second in the series; the first one came out in the Sept.-Oct. 1944 issue.

Mr. Adams handles his subject with a freedom and ease that tells you he knows what he is writing about. Without going into tiresome detail he tells you accurately the history of the famous missions and recites the important historical events and facts that form the background of his subject.

As a better guide to the motoring tourist Mr. Adams has taken up the descriptions of the missions "in the order of their locations from south to north, rather than in the sequence of their founding." In his second article he has reached Mission San Juan Capistrano, just south of Santa Ana and we are all looking forward impatiently for the next issue which will undoubtedly deal with the old missions north of Los Angeles with which most of us are familiar.

Unquestionably Mr. Adams' "California Missions" will hold a high place in any collection of Californiana.

The Outlook for Farm Construction

By **SANFORD B. TAYLOR**
Economist

Any astrologer has just about as much of a chance of predicting the exact date on which the war will end as the Market Analysis Committee has of **exactly** forecasting expenditures for new farm buildings and the maintenance of existing structures. The necessity of some "crystal gazing" is anything but satisfactory to the committee and every effort is being made to improve the situation. Let me give you a glimpse of the facts in the case.

We have few, if any, reliable guideposts or factual data on the volume of farm construction in past years. Census of Agriculture Reports, for instance, have rarely asked questions on current expenditures for construction or for building materials. Even the data on existing buildings has been almost completely estimated and other sources of basic information are generally incomplete in coverage.

This is a serious situation hampering adequate analysis of the market for building materials and equipment. The problem is one with which the Farm Buildings Committee of the Council is also fully aware and, as a result, has set up a Sub-committee on Marketing and Statistics to work toward the improvement of the collection of all statistical information on farm construction.

As chairman of that subcommittee, as well as a member of the Market Analysis Committee, I am on the "spot" today because I am now going to forecast the farm construction expenditures for this year despite the fact that we are not sure of how much was done last year or 10 years ago. The committee is reasonably certain, however, that the relative amounts are worth serious consideration and that the farm market for building

products is large with the future possibilities favoring a great expansion.

The Market Analysis Committee estimates that new farm construction in 1945 will be about \$275,000,000 as compared with the \$160,000,000 that probably was completed in 1944. This contrasts with the recent peak in 1941 of \$315,000,000. In addition, the farmer is expected to spend about \$350,000,000 on repairs and maintenance in 1945 against \$250,000,000 estimated for last year and \$222,000,000 in 1943.

On the whole the first six months of 1945 should show a moderate gain over the last half of 1944. The last six months of 1945 are expected to improve sharply over the first six months, if, as now anticipated, the restrictions on farm construction are removed.

1944 is regarded as the turning point in the downward movement in farm construction and from now on there is likely to be a steady gain each year towards the post-war 5-year average of \$585,000,000 of new farm construction previously estimated by this committee last November. (It should be pointed out that this volume of new farm construction is far above the previous record of \$425,000,000 made in 1919 and compares with the low of \$85,000,000 in 1932.)

On this same basis, maintenance and repairs are expected to average about \$725,000,000 per year or 10% above 1919. Thus the total annual expenditure for all new farm buildings and improvements to present buildings will amount to over \$1,300,000,000 on the average during the 5-year period 1947-1951.

These new all-time high figures are anticipated despite the fact that farm income appears likely to start a downtrend from the peak reached in 1944. Supporting factors are: the exceptionally high income in recent years and the farmers' evident ability to retain a substantial part thereof; the promise of continued governmental support of farm prices; and the probability

that many returning veterans will be able to make generous use of government loans for farm construction purposes. The farmer, the building product manufacturer and the builder are all beginning to realize the necessity for functional design in farm buildings. For the first time, the possibility appears that the purchase of farm buildings will receive consideration from an efficiency standpoint much as the manufacturing industries take advantage of new developments and techniques to improve production and lower costs. The market under such conditions for farm building products could be enormous if the building industry can design, fabricate, and distribute economically the items that will really meet the farmer's needs.

The author of this article, Sanford B. Taylor, is Director, Economic Research Division of the Great Lakes Steel Company, and member of the Market Analysis Committee of the Producers' Council, Inc.

Built-In Fixtures for the Post-War Home

Paramount Fixtures will fit your post-war needs . . . investigate our new kitchen ideas which make for convenience and efficiency.

Paramount Built-in Fixtures meet the most exacting requirements. Our "Deluxe," "Moderne" and "Economy" cabinet fixtures are distinctive in design and construction and may be had in stock sizes or built to order.

Catalog for the asking

The logo features the word "Paramount" in a large, stylized, serif font. Above the "o" in "Paramount" is a small circle containing the word "Cabinets". Below "Paramount" is the word "BUILT-IN FIXTURE COMPANY" in a smaller, sans-serif font. At the bottom, the address "5107 Broadway, Oakland, California" and phone number "Phone PLedmont 8100" are listed.

Paramount
BUILT-IN FIXTURE COMPANY
5107 Broadway, Oakland, California
Phone PLedmont 8100



by Angelo Hewetson

Trees in

Architectural Drawings

By MARK DANIELS, A.I.A.

Many a presentation of a good plan is weakened by a poorly rendered tree. I do not imply that if a tree is prominent in the rendering or sketch elevation it should be handled as a gallery canvas, displaying the beauty of a tree, but that it should look like a tree and not like a feather duster. Further, it should be easily recognized as the kind of tree it is supposed to be. Of course, this cannot be carried out for all the trees in the plant kingdom, but a familiarity with some of the fundamental characteristics of the more common trees of a district may enable the draughtsman to indicate, with a few well chosen strokes, the kind of tree intended.

For instance, the Canary Island date palm, so common throughout California and one which is so often allowed to remain, is often rendered to look more like an up-ended shaving brush than

anything that bears fruit, even though that fruit is unedible. And there is the eucalyptus that, like "the poor, we have with us always". I will acknowledge that it is not as easily rendered, but it can be done. I can't, but Ralph Owen can, and how! But, of course, he can render about anything, sometimes in a twinkling.

Angelo Hewetson's drawing of the good old Monterey pine is a good case in point. The tree is a rapid grower, hardy, will thrive in almost any part of the state, and nearly always takes on character with beauty. For that reason it is profusely used. In the Monterey country there are forests of them, and if you are doing a house anywhere along the coast in that region, you will have to show it in your sketch. Not that you would use any such detail, but a study of Mr. Hewetson's lovely drawing may throw much light on what constitutes the real character of the Monterey pine.

A. I. A. ACTIVITIES



A. I. A. ACTIVITIES

UNIFICATION is progressing slowly and steadily; that is, unification of activities among the organizations and their conduct of affairs important to group action. A letter from Mr. Spencer, president of the local chapter of the A.I.A., sets forth to the members some of the matters settled upon between the A.I.A. and the State Association. The letter marks considerable progress since last spring.

Now is the time to work up the form of UNIFICATION amongst the architects individually. A unification of purpose, of principles of practice, of loyalty to the profession, and of help for one another would be a real backlog to support any group action decided upon by those directing such action.

SUBDIVISION OF THE ARCHITECT'S FEE:

Payments on account of the architect's base fee shall be made on the basis of progress at follows:

Upon completion of the preliminary studies, a sum equal to 20% of the basic rate computed upon a reasonable estimated cost.

Upon completion of specifications and general working drawings (exclusive of details) a sum sufficient to increase payments on the fee to 75% of the rate or rates of commission arising from this agreement, computed upon a reasonable cost estimated on such completed specifications and drawings, or if bids have been received, then computed upon the lowest bona fide bid or bids.

GROUP ONE—MINIMUM FEE 6%

Lofts
Factories (Simple)
Exposition and Fair Buildings (Temporary)
Market Buildings
Buildings of like nature and complexity

GROUP TWO—MINIMUM FEE 7%

Industrial Buildings (Complex)
Hotels, Apartments and Multiple Dwellings
Banks
Store Buildings
Office Buildings
Buildings of like nature and complexity

GROUP THREE—MINIMUM FEE 8%

Schools
Churches

Theaters and Auditoriums
Governmental Administrative Buildings
Hospitals, Children's Homes and Home for the Aged and Indigent
Libraries and Museums
Clubs, Lodges and Fraternity Houses
Buildings of like nature and complexity

GROUP FOUR—MINIMUM FEE 10%

Residences
Swimming Pools
Tennis Courts
Shop Fronts
Fixtures
Combined Shops and Residences
Monuments
Buildings of like nature and complexity
Partial services are not recommended.

Kenneth S. Wing, Chairman
Architectural Professional Charges
Committee.

NEWS AND COMMENT ON ART

(From Page 8)

with a white or buff slip and then painting designs on it with a brown or black slip. The whole is then protected with a clear glaze—unless slip-glazes were used—in which case the clear slip is not necessary.

Of great significance is the occasional use of enamels on ware which were covered with a white slip-glaze. A strong leaf-green, a muddy-yellow and a tomato-red were used. These colors were apparently fixed in a muffle kiln with low temperature (*petit feu*). This is the earliest instance of decoration with enamels, and all hand-painted porcelain could be traced to this center.

The graffiti or carved slip process of decoration is an inheritance from the Tang dynasty but were used almost solely by the Tzu Chou potters at this time. There are two kinds of graffiti decorations, the carved slip type and the carved glaze type. In the first type, grey bodied wares coated with a white slip are carved down to the biscuit to yield a design and then covered with a clear or buff glaze, resulting in a two-tone effect in either case. In the second type the vessel is given a thick brown-black slip-glaze and then carved to the biscuit to yield a design and then fired. These latter are often called carved *temokus*. Both types are exceedingly popular among collectors today.

At the present time we know very little of the provenience of either the underglaze black or the underglaze blue wares of the Sung dynasty. There

**IT COSTS NO MORE
TO GIVE YOUR CLIENT**

the best ...

NEXT TIME SPECIFY

Pennvernon Glass

its
FLATTER
... CLEARER
... BRIGHTER ...

PENNVERNON
flat drawn
WINDOW GLASS

Distributed by ...
W · P · FULLER & CO.
PAINTS • GLASS • WALLPAPER



QUALITY AND DEPENDABLE
Service

are the factors that influence architects and contractors when selecting lumber and mill work — Quality of merchandise — Integrity and Ability of the firm — Service in physical equipment — Experience and Personnel — All these factors contribute to a speedy and satisfactory completion of construction with minimum of time and expense.

MANUFACTURER OR DEALER IN

Douglas Fir — Redwood — Sugar and Ponderosa Pine — Plywood and Concrete Form Panels — Sash and Doors — Millwork — Insulation — Builders' Hardware.

E. K. WOOD LUMBER CO.

"Goods of the Woods" ©
LOS ANGELES • SAN FRANCISCO • OAKLAND

are attractive incense urns and mei-pings (prunus vases—tall vases with slender basis, broad shoulders, short narrow necks and small mouth intended to receive a single branch of the prunus blossom) which have painted black designs under a brilliant turquoise or leaf-green glaze. The style of the painting and potting is akin to those of the Tzu Chou potters, but the pate is a reddish clay and hence may represent wares made by Tzu Chou potters who have migrated elsewhere. Or the red biscuit may indicate a differently controlled kiln to bring out the bright turquoise or leaf-green color. A brilliant turquoise glaze is developed in an oxidizing atmosphere, and this would bring out the red color in any clay which has traces of iron. At any rate, the underglaze blacks are generally classified as a form of Tzu Chou stoneware.

Painting in under-the-glaze blue ware described in the T'ao Lu and other Chinese writings as coming from Yung Ho Chen (where the Chi chou ware was made), from Nan-fe Heien and from Ching-te Chen, all in Kiangsi. In all probability the Chi Chou potters were the first to employ the under-glaze blue, for Chinese connoisseurs associate the first blue with the Chi chou ware. While a few blue and whites were undoubtedly made during the Sung dynasty it was not until the succeeding Yuan dynasty that the wares were produced in large number.

The Sung dynasty came to an end when the Mongols over-ran the empire, establishing the Yuan dynasty. During this period the wares produced is a continuation of the Sung tradition, but the quality is poor, for the best of the Sung potters refused to work under an alien ruler. The decline in ceramics continued until the Chinese regained their empire and started the great Ming dynasty—when a new ceramic, porcelain, was achieved. The production of porcelain reached great height during both the Ming and the Ch'ing dynasties. (Next issue: The Age of Porcelain.)

NEW "STOP-ALL" GREASE INTERCEPTOR

Designed to offer protection against clogged drain lines, a new low-cost grease interceptor has been announced which sells for the low price of \$14.00.

As a manufacturer of plumbing specialties since 1865, and in support of the plumbing industry need for grease interceptors in modern plumbing practice applicable to many homes where initial cost has been a barrier, this new product is known as No. 5710 "STOP-ALL": Manufactured by WADE, Elgin, Illinois.

IN THE NEWS

\$3000 POST-WAR HOMES

At least 70 per cent of the post-war houses will cost only \$3,000 to \$6,000, Irving W. Clark predicted recently in an address before the Edison Electric Institute in Chicago.

Developments in the past five years, particularly the past two years, make the \$3,000 home not only a possibility but an actual fact. From the standpoint of equipment, appearances and livability, the finished product is comparable to houses costing considerably more ten years ago.

SYMBOLS

The standardization of symbols to be used on architectural and engineering plans has been a headache, not only to the group in Washington who have been working on Graphic Symbols, but to the engineers and architects who have to use them and those who have to read them. The works on "Architectural Graphic Standards" have gone a long way toward helping to unify the methods of representation, but it can only become universal by further publication and pounding.

Under the sponsorship of the American Institute of Electrical Engineers and the American Society of Mechanical Engineers, the work of revising the American Standard Graphic Symbols for Telephone, Telegraph and Radio Use, was accomplished. An American Standard Graphic Electrical Symbols for Architectural Plans is available, probably through "Industrial Standardization," 70 East 45th St., N. Y.

As the number of symbols grows, and it must grow to keep pace with invention, they must be reclassified and re-standardized. They must also be re-studied in order that they may be intelligently used. They must be so used in order that plans may convey a clear meaning.

SMOOT-HOLMAN

The Smoot-Holman name on commercial and industrial lighting equipment means quality...quality today (even in the face of production restrictions)...quality tomorrow, when with many new names entering the field, a good name will more than ever be your protection.

SMOOT-HOLMAN COMPANY

SMOOT-HOLMAN

INGLEWOOD, CALIFORNIA

MADE IN U.S.A.

Offices in Principal Western Cities—Branch and Warehouse in San Francisco

PRODUCERS' COUNCIL PAGE

Northern California Chapter

The National Organization of Manufacturers of Quality Building Materials and Equipment
Affiliated with the AMERICAN INSTITUTE OF ARCHITECTS



ART SKAIFE

work. And nobody's attendance could be better. Other big companies please copy!

Local boy makes good . . . right at home, tells Art's story. He was born in Alameda. With the exception of one year at sea as a Marine Electrician, and two in the oil fields as a Machine Shop Manager, his entire business career has been in the elevator business! The way up led through various elevator companies to Vice-President of the Spencer Elevator Co. until it was purchased by Westinghouse Electric Elevator Company, when he became San Francisco District Manager for Westinghouse. Early this year, Art's duties were expanded two ways . . . to include the nine Western States, Hawaii and Alaska, and to include air conditioning equipment.

Art's pride and joy are three grown children, two sons and a daughter and two grandsons. Characteristic of kindly Art, "What more can a man want?" he asks.

YOUR "PAGE" completes two years of reporting on the activities of the Northern California Chapter of the Producers' Council, Inc., and the personalities who have played leading roles in its service. We hope this effort has contributed something to the understanding of the Architectural and Engineering professions of the place of the Council in their picture.

A. F. Skaife, Pacific Coast Manager of Westinghouse Electric Elevator Company, is our ideal of a Division or Branch Manager who chooses to delegate active Chapter work, but who retains personal interest in Chapter affairs. Both his Alternate and the Chapter feel at all times that we have the understanding and backing of Art in our

NOW we have a lot of steady, loyal members without whose support Chapter officers could not function. We want you to know them better. So next comes a get-acquainted series with the boys in regular attendance, which, for want of a better idea, we will tackle on an alphabetical basis.

We are sorry to announce the death on November 22, 1944, of Harry J. Lemos, of the Pacific Gas & Electric Company, after a prolonged illness.

Harry served his Chapter well as Treasurer in 1943, and his swell job as Chairman of the Membership and Attendance Committee last year will be long remembered. His enthusiasm and interest inspired us to a new high in attendance at our October meeting. He will be missed.



HARRY LEMOS

IT'S INTERESTING to note that out of 35 member companies, the representatives of 20 presently in the Chapter have served as officers or committee chairmen. And 25 individuals or about half the members and alternates of the present membership have served.

THAT MEANS two things, 1) cooperation and a widespread willingness to accept responsibility and, 2) a continual infusion of new blood in the Chapter leadership.

Maybe it's cause and effect, but it has certainly had the right effect.



USE QUALITY PRODUCTS CONSULT AN ARCHITECT



BOOK REVIEWS

ESTIMATING BUILDING COSTS. By Charles F. Dingman. Published by McGraw-Hill. Price \$3.00.

This is a practical handbook, based on accurate methods of analyzing any construction project into component operations and determining proper cost price to assign to each. The book, which is not a new one, it's in the third edition, covers estimating on all building construction operations, from excavating to roofing and waterproofing. As such it gives both new and experienced estimators helpful methods of determining quantities of labor and lists of materials to produce complete work in practically every branch of building construction.

This new edition takes into account many important developments that have taken place in the manner of doing construction work, particularly in the handling of excavation and related work. New methods of handling concrete work have likewise dictated revision of the relevant text.

Throughout the book the treatment presented was made possible by the cooperation of several manufacturers as well as by men actually engaged in the work. You, as an architect, or a general contractor, may not have a recognized interest in estimating, say, your plumbing or heating work, but there are some who do, or who may, profit by the knowledge of methods of estimating.

Review by Michael Goodman.

PLASTIC MOULDING and Plant Management. By D. A. Deaole. Published by Chemical Publishing Company, Inc., Brooklyn, N.Y. Price \$3.50.

Plastics being an article in a general stage of romantic allure and promise, is bound to produce much writing on the subject. I suppose the true story is yet to be written, say, after the war, in an ever-accelerating pace.

In presenting this book on the plastic molding, the author intends that the information compiled will be helpful to those who are confronted daily with the many-faceted problems arising in producing compression and injection molded plastics at a profit. The context is somewhat advanced and is based on the assumption that the reader has attained a working knowledge of compound molding.

The part of the book dealing with plant management is suggested by the fact that not much is consistent in plastic molding technique. The

STANLEY HARDWARE

First In Modern School Construction

Stanley Hardware has always passed "with honor" the severe tests imposed by use in schools. In future school construction, Stanley Hardware will meet not only the usual requirements of doors and windows, but also the many built-in features characteristic of modern design.

The building of schools

promises to be a major post-war project. This provides you with an exceptional opportunity to supply from the complete Stanley line, the right design, type and size together with the individual efficiency of performance for which Stanley Hardware has long been famous. The Stanley Works, New Britain, Connecticut.

Typical Stanley Hardware Items for Schools

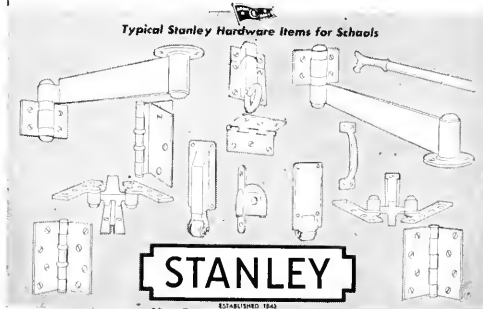

BAXCO

CHROMATED ZINC CHLORIDE

GLC

PRESSURE TREATED LUMBER
● **PROTECTS AGAINST DECAY
AND TERMITE ATTACK**

Specify it in your home
Available through Lumber Dealers

LOS ANGELES
601 W. 5th Street
Phone MIchigan 6294

SAN FRANCISCO
333 Montgomery Street
Phone DOugles 3883

J. H. Baxter & Co.

AGENTS FOR WEST COAST WOOD PRESERVING CO. SEATTLE, WASH.

various chapters and the one on Questions and Answers furnish many fundamentals to be adhered to, and point to precautions to be taken in order to save time and money in production, to meet the ever-increasing competition in the industry employing plastic molding techniques. Color and future possibilities are also discussed.

Review by Michael Goodman.

MODULAR STRUCTURAL CLAY



Gathered around this exhibit demonstrating modular structural clay products, brick, glass blocks and steel window frames are, left to right: J. B. Crawford, vice-president of Kraftile Company; Sherman M. Hathaway, C. W. Kraft, director of Producers' Council, Inc.; A. Appleton, past president of the Northern California Chapter of the A.I.A.; Vincent Raney, A.I.A.; C. W. Williams, president of the Central California Chapter, A.G.C., and Architect R. G. DeLappe.

ANYONE who can get in to see the plans for the \$4,000,000 Apparel Buildings, being planned by J. FRANCIS WARD and JOHN S. BOLLES, will see something worth while.

THE PRODUCERS' COUNCIL reports through their chairman of the Council's residential committee that, "At no time in the Nation's history have mortgage funds been so plentiful and funds for equity payments by prospective home owners or investors so readily available." The trick is to find anything the government has left us that is mortgageable.

HOGAN LUMBER CO.

Wholesale and Retail

LUMBER

MILL WORK • SASH & DOORS

Office, Mill, Yard and Docks

SECOND AND ALICE STREETS • OAKLAND, CALIF.

Telephone GLencourt 6861

SANTA MARIA INN

SANTA MARIA, CALIFORNIA

FRANK J. McCOY, General Manager

FERNAND E. PIMENTEL, Manager

*On the
Coast
Highway
between
San
Francisco
and
Los
Angeles*



*American
or
European
Plan
•
Old
English
Tap
Room*

**CLINTON
CONSTRUCTION CO.
OF CALIFORNIA**

General Contractors

923 FOLSOM STREET • SAN FRANCISCO

SUtter 3440

MALOTT & PETERSON

**ROOFING AND FLOORING
CONTRACTORS**

20TH AND HARRISON STREETS

SAN FRANCISCO

Phone ATwater 1600

ARCHITECT AND ENGINEER

Estimator's Guide

Giving Cost of Building Materials, Etc.

AMOUNTS GIVEN ARE FIGURING PRICES AND ARE MADE UP FROM AVERAGE QUOTATIONS FURNISHED BY MATERIAL HOUSES TO SAN FRANCISCO CONTRACTORS. 2½% SALES TAX ON ALL MATERIALS BUT NOT LABOR

All prices and wages quoted are for San Francisco and the Bay District. There may be slight fluctuation of prices in the interior and southern part of the state. Freight cartage, at least, must be added in figuring country work.

BONDS—Performance—50% of contract.
Labor and materials—50% of contract.

BRICKWORK—

Common Brick—Per 1M laid—\$50.00 to \$60.00 (according to class of work).

Face Brick—Per 1M laid—\$120 to \$150 (according to class of work.)

Brick Steps—\$1.60 per lin. ft.

Brick Veneer on Frame Bldg.—Approx. \$1.30 per sq. ft.

Common Brick—\$19.00 per M, truckload lots, f.o.b. job.

\$19.00 per M, less than truckload, plus cartage.

Face Brick—\$40 to \$80 per M, truckload lots, delivered.

Cartage—Approx. \$4.00 per M.

BUILDING PAPER—

1 ply per 1000 ft. roll.....	\$3.50
2 ply per 1000 ft. roll.....	5.00
3 ply per 1000 ft. roll.....	6.25
Brownkin, Standard, 500 ft. roll.....	5.00
Sisalcraft, 500 ft. roll.....	5.00
Sash cord com. No. 7.....	1.20 per 100 ft.
Sash cord com. No. 8.....	1.50 per 100 ft.
Sash cord spot No. 7.....	1.90 per 100 ft.
Sash cord spot No. 8.....	2.25 per 100 ft.
Sash weights, cast iron, \$50.00 ton.	
Nails, \$3.42 base.	
Sash weights, \$45.00 per ton.	

CONCRETE AGGREGATES—

The following prices net to Contractors unless otherwise shown.

Gravel, all sizes—	\$1.95 per ton at Bunker; delivered.....	\$2.50
	Bunker	Del'd
Top Sand.....	\$1.90	\$2.50
Concrete Mix.....	1.90	2.45
Crushed Rock, ¼" to ¾".....	1.90	2.50

Crushed Rock, ¾" to 1½".....	1.90	2.50
Roofing Gravel.....	2.25	2.80
River Sand.....	2.00	2.45

Sand—

River Sand.....	2.00	2.45
Lapis (Nos. 2 & 4).....	2.85	3.15
Olympia (Nos. 1 & 2).....	2.85	3.10
Del Monte White.....	2.84c per sack	

Cement—

Common (all brands, paper sacks), carload lots, \$2.42 per bbl. f.o.b. car; delivered \$2.72. Cash discount on carload lots, 10c a bbl., 10th Prox.; less than carload lots \$3.20 per bbl. f.o.b. warehouse or delivered.

Cash discount 2% on L.C.L.

Atlas White } 1 to 100 sacks, \$2.50 sack
Calaveras White } warehouse or del.; \$7.65
Medusa White } bbl. carload lots.

Forms, Labors average \$200.00 per M.

Average cost of concrete in place, exclusive of forms, 35c per cu. ft.; \$10 cu. yd.; with forms, 60c.

4-inch concrete basement floor.....

Ret-roofing.....7½c per sq. ft.

Concrete Steps.....\$1.25 per lin. ft.

DAMP-PROOFING and Waterproofing—

Two-coat work, \$3.50 per square.

Membrane waterproofing—4 layers of saturated felt, \$7.00 per square.

Hot coating work, \$2.50 per square.

Medusa Waterproofing, \$3.50 per lb. San Francisco Warehouse.

Tricoat waterproofing.

(See representative.)

ELECTRIC WIRING—\$12 to \$15 per outlet for conduit work (including switches).

Knob and tube average \$3.00 per outlet. (Available only for priority work.)

ELEVATORS—

Prices vary according to capacity, speed and type. Consult elevator companies. Average cost of installing a slow speed automatic passenger elevator in small four story apartment building, including entrance doors, about \$6500.00.

EXCAVATION—

Sand, 60 cents; clay or shale \$1 per yard. Teams, \$12.00 per day.

Trucks, \$22 to \$27.50 per day.

Above figures are an average without water. Steam shovel work in large quantities, less; hard material, such as rock, will run considerably more.

FIRE ESCAPES—

Ten-foot galvanized iron balcony, with stairs, \$150 installed on new buildings; \$160 on old buildings.

FLOORS—

Composition Floor, such as Magnesite, 33c to 50c per square.

Linoleum—2 gauges—\$1.25 to \$2.75 per sq. yd.

Mastapey—90c to \$1.50 per sq. yd.

Battleship Linoleum—available to Army and Navy only—1/8"—\$1.75 sq. yd.
3/8"—\$2.00 sq. yd.

Terazzo Floors—50c to 70c per square.

Terazzo Steps—\$1.75 per lin. ft.

Mastic Wear Coat—according to type—20c to 35c.

Hardwood Flooring—

Standard Mill grades not available.

Victory Oak—T & G

¾" x 2¼".....\$143.25 per M. plus Cartage

½" x 2".....122.00 per M. plus Cartage

½" x 1½".....113.50 per M. plus Cartage

Prefinished Standard & Better Oak Flooring

¾" x 3¼".....\$180.00 per M. plus Cartage

½" x 2½".....160.50 per M. plus Cartage

Maple Flooring

¾" T & G Clear \$160.50 per M. plus Ctg.

2nd 153.50 per M. plus Ctg.

3rd 131.25 per M. plus Ctg.

Floor Layers' Wage, \$1.50 per hr.

GLASS—

Single Strength Window Glass.....20c per □ ft.

Double Strength Window Glass.....30c per □ ft.

Plate Glass, under 75 sq. ft.....\$1.00 per □ ft.

Polished Wire Plate Glass.....1.40 per □ ft.

Rgh. Wire Glass......34 per □ ft.

Obscure Glass......27 per □ ft.

Glazing of above is additional.

Glass Blocks.....\$2.50 per □ ft. set in place

HEATING—

Average, \$1.90 per sq. ft. of radiation, according to conditions.

Warm air (gravity) average \$48 per register.

Forced air, average \$68 per register.

IRON—Cost of ornamental iron, cast iron, etc., depends on designs.

LUMBER—All lumber at O.P.A. ceiling prices—

No. 1 Common	\$49.00 per M
No. 2 Common	47.75 per M
Select O. P. Common	52.75 per M

Flooring—

V.G.-D.F. 8 & Btr. 1 x 4 T & G Flooring	Delvd. \$80.00
C 1 x 4 T & G Flooring	75.00
D 1 x 4 T & G Flooring	65.00
D.F.-S.G. 8 & Btr. 1 x 4 T & G Flooring	61.00
C 1 x 4 T & G Flooring	59.00
D 1 x 4 T & G Flooring	54.00
Rwd. Plastic—"A" grade, medium dry	62.00
"B" grade, medium dry	78.50

Plywood—

	Under \$200	Over \$200
"Plycord"— $\frac{3}{8}$ "	\$49.50	\$47.55
"Plywall"— $\frac{1}{4}$ "	45.15	43.30
3 ply— $\frac{2}{8}$ s— $\frac{1}{4}$ "	48.55	46.60
"Plyform"— $\frac{3}{8}$ "—		
Unoiled	126.50	121.45
Oiled	127.90	122.75

Above prices delivered if quantity is sufficient to warrant delivery.

Shingles (Rwd. not available)—

Red Cedar No. 1—\$6.75 per square; No. 2, \$5.75; No. 3, \$4.45.

Average cost to lay shingles, \$3.00 per square.

Cedar Shakes—Tapered: $\frac{1}{2}$ " to $\frac{3}{4}$ " x 25"—\$8.95 per square.

Resawn: $\frac{3}{4}$ " to $1\frac{1}{4}$ " x 25"—\$10.65 per square.

Resawn: $\frac{3}{4}$ " to $1\frac{1}{4}$ " x 25"—\$10.65 per square.

Average cost to lay shakes, \$4.00 per square.

MILLWORK—Standard.

O. P. \$100 per 1000. R. W. rustic \$100.00 per 1000 (delivered).

Double hung box window frames, average with trim \$6.50 and up, each.

Complete door unit, \$10.00.

Screen doors, \$3.50 each.

Patent screen windows, 25c a sq. ft.

Cases for kitchen pantries seven ft. high, per lineal ft., \$9.00 each.

Dining room cases, \$9.00 per lineal foot.

Rough and finish about 80c per sq. ft.

Labor—Rough carpentry, warehouse heavy framing (average), \$40.00 per M.

For smaller work average, \$40.00 to \$55.00 per 1000.

MARBLE—See Dealers

PAINTING—

Two-coat work per yard 50c

Three-coat work per yard 70c

Cold water painting..... per yard 10c

Whitewashing per yard 8c

PAINTS—

Two-coat work 50c per sq. yd.

Three-coat work 70c per sq. yd.

Cold water painting.....per yard 10c

Whitewashing 8c per sq. yd.

Turpentine \$1.03 per gal. in drum lots.

\$1.08 per gal. in 5-gal. containers.

Raw Linseed Oil—not available.

Boiled Linseed Oil—\$1.38 per gal. in drums. Available only to work with high priority—\$1.48 per gal. in 5-gal. containers.

Use replacement oil—\$1.86 per gal. in 1-gal. containers.

Replacement Oil—\$1.20 per gal. in drums. \$1.30 per gal. in 5-gal. containers.

A deposit of \$6.00 required on all drums.

PATENT CHIMNEYS—

6-inch\$1.20 lineal foot

8-inch 1.40 lineal foot

10-inch 2.15 lineal foot

12-inch 2.75 lineal foot

PLASTER—

Neat wall, per ton delivered in S. F. in paper bags, \$17.60.

PLASTERING (Interior)—

3 Coats, metal lath and plaster Yard 1.50

Keene cement on metal lath 1.80

Ceilings with $\frac{3}{4}$ " hot roll channels metal lath (lath only) 1.20

Ceilings with $\frac{3}{4}$ " hot roll channels metal lath plastered 2.20

Single partition $\frac{3}{4}$ " channel lath 1 side (lath only) 1.20

Single partition $\frac{3}{4}$ " channel lath 2 inches thick plastered 3.20

4-inch double partition $\frac{3}{4}$ " channel lath 2 sides (lath only) 2.20

4-inch double partition $\frac{3}{4}$ " channel lath 2 sides plastered 3.85

Thermax single partition; 1" channels; 2 1/2" overall partition width. Plastered both sides 3.30

Thermax double partition; 1" channels; 4 1/2" overall partition width. Plastered both sides 4.40

3 coats over 1" Thermax nailed to one side wood studs or joists 1.65

3 coats over 1" Thermax suspended to one side wood studs with spring sound isolator clip 1.90

Note—Channel lath controlled by limitation orders.

PLASTERING (Exterior)—

2 coats cement finish, brick or concrete wall Yard \$1.00

3 coats cement finish, No. 18 gauge wire mesh 2.00

Lime—\$3.00 per bbl. at yard.

Processed Lime—\$3.10 bbl. at yard.

Rock or Grip Lath— $\frac{3}{8}$ "—20c per sq. yd.

$\frac{1}{2}$ "—19c per sq. yd.

Composition Stucco—\$1.80 to \$2.00 sq. yard (applied).

PLUMBING—

From \$100.00 per fixture up, according to grade, quantity and runs.

ROOFING—

"Standard" tar and gravel, 4 ply—\$8.00 per sq. for 30 sqs. or over.

Less than 30 sqs. \$9.50 per sq.

Tiles \$30.00 to \$40.00 per square.

Redwood Shingles, \$7.50 per square in place.

5/2 #1-16" Cedar Shingles, 4 1/2"

Exposure \$8.00 square

5/8 x 16"—#1 Cedar Shingles, 5"

Exposure\$9.00 square

4/2 #1-24" Royal Shingles, 7 1/2"

Exposure\$9.50 square

Re-coat with Gravel \$4.00 per sq.

Asbestos Shingles, \$23 to \$28 per sq. laid.

1/2 x 25" Resawn Cedar Shakes,

10" Exposure \$10.50

3/4 x 25" Resawn Cedar Shakes,

10" Exposure 11.50

1 x 25" Resawn Cedar Shakes,

10" Exposure 12.50

Above prices are for shakes in place.

SHEET METAL—

Windows—Metal, \$1.75 a sq. ft.

Fire doors (average), including hardware \$2.00 per sq. ft.

SKYLIGHTS—(not glazed)

Copper, 90c sq. ft. (flat).

Galvanized iron, 40c sq. ft. (flat).

Vented hip skylights 60c sq. ft.

STEEL—STRUCTURAL (None available except for defense work).

\$150 ton (erected), this quotation is an average for comparatively small quantities. Light truss work higher. Plain beams and column work in large quantities \$140 per ton.

STEEL REINFORCING (None available except for war work).

\$150 to \$200 ton, set.

STONE—

Granite, average, \$6.50 cu. foot in place.

Sandstone, average Blue, \$4.00. Boise, \$3.00 sq. ft. in place.

Indiana Limestone, \$2.80 per sq. ft. in place.

STORE FRONTS (None available).

TILE—

Ceramic Tile Floors—70c to \$1.00 per sq. ft.

Cove Base—\$1.10 per lin. ft.

Glazed Tile Wainscot—\$1.25 per sq. ft.

Asphalt Tile Floor $\frac{1}{8}$ " & $\frac{3}{8}$ "—\$.18 to \$.35 per sq. ft. Light shades slightly higher.

Cork Tile—\$.40 to \$.75 per sq. ft.

Mosaic Floors—see dealers.

Lino-Tile, \$.35 to \$.75 per sq. ft.

Wall Tile—

Glazed Terra Cotta Wall Units (single glazed) laid in place—approximate prices:

2 x 6 x 12\$1.10 sq. ft.

4 x 6 x 12 1.25 sq. ft.

2 x 8 x 16 1.20 sq. ft.

4 x 8 x 16 1.40 sq. ft.

VENETIAN BLINDS—

40c per square foot and up. Installation extra.

WINDOWS—STEEL—

30c per square foot, \$5 for ventilators.

**PRIVATE ENTERPRISE MUST
PLAN FOR FULL EMPLOYMENT
IN POST-WAR PERIOD**

WASHINGTON, D. C.—Despite campaign promises in regard to private enterprise, free enterprise is safe from Government interference only so long as people are employed, William Muirhead, president of the Associated General Contractors of America, warned.

"If widespread unemployment occurs after the war," he explained, "people will demand that something be done by the Government—which may be contrary to the spirit of free enterprise."

Mass unemployment in the large war industry centers would seem to be inevitable when war production is reduced, he continued. Cuts in any of the major war industries will necessarily result in thousands of workers losing their jobs.

"Construction is often cited as the industry which can provide employment and stimulate business activity in emergency periods. It is true that construction is susceptible of an enormous increase—far beyond the volume of any pre-war year. It can also be started quickly. But construction must be planned in advance, and construction, other than public

works, depends on business conditions and prospects."

As a means of stimulating business activity in the post-war period, Mr. Muirhead advocated revision of wartime taxes. A reduction in excess profits tax should be made after the collapse of Germany, he said, together with elimination of most "nuisance" taxes. He also advocated the use of incentive taxes to stimulate business activity, particularly depreciation of new industrial and commercial structures and of new machinery and equipment.

Mr. Muirhead said that the Executive Committee of the AGC had approved a plan for accelerated depreciation of new structures for taxing purposes, and supports a similar plan for depreciation of new machinery and equipment. Both these plans, he added, are in line with the proposal for tax allowances in the post-war period suggested by President Roosevelt in his recent speech in Chicago.

Under the AGC plan for accelerated depreciation, owners of structures built after the war would be permitted to depreciate one-half of the cost of the structure in the first quarter of its useful life. On a building costing \$100,000 with a useful life of 40 years, for

**Read building
blueprints**



**quickly
accurately**

Here is a book to give men in the building trades an intensive training in blue-print reading. Covers the building trades as a whole and is organized on the self-instruction, question - and - answer plan.

Just Out!

**BLUEPRINT READING
for the
BUILDING TRADES**

By Joseph E. Kenney
Architect; Instructor in Drafting,
South Boston High School,
100 pages, 8 1/2 x 11, \$2.00

This book explains what blueprints are, their importance, how the architect prepares working drawings, who uses them, and how to go about learning to read them. It shows the meaning and use of the various symbols and conventions and how they fit into the working drawings for an entire building.

**ORDER A COPY FROM
ARCHITECT AND ENGINEER
68 Post Street, San Francisco, 4**

example, a depreciation of \$5,000 a year would be allowable during the first 10 years, or one-half of the total cost.

1945 BUILDING TRADES WAGE SCALES (JOB SITE) NORTHERN CALIFORNIA

Six- and seven-hour day eliminated on all Government Work. A. F. L. - O. P. M. Agreement calls for eight-hour day.

NOTE: Predeterminations by the Department of Labor, as of July 1, 1944 (the wage-freezing date) have not yet been made in all of the counties listed. The wage scales shown are those being paid and in effect mostly by agreement between employers and their union.

CRAFT	Alameda and Contra Costa		Fresno	Marin	Sacramento	San Jose	San Mateo	Vallejo	Stockton
	San Francisco	Contra Costa							
ASBESTOS WORKERS	1.50	1.50	1.25	1.50	1.50	1.25	1.50	1.50	1.25
BRICKLAYERS	1.87 1/2	1.87 1/2	1.75	1.87 1/2	1.75	2.00	1.79-1/4	1.75	1.50
BRICKLAYERS, HODCARRIERS	1.40	1.40	1.05	1.40	1.05	1.50	1.35	1.50	1.14
CARPENTERS	1.50	1.50	1.25	1.50 3/4	1.37 1/2	1.37 1/2	1.43 3/4	1.50	1.37 1/2
CEMENT FINISHERS	1.50	1.50	1.50	1.50	1.50	1.50	1.50	1.50	1.50
ELECTRICIANS	1.70	1.70	1.70	1.70	1.70	1.70	1.70	1.70	1.70
ELEVATOR CONSTRUCTORS	1.75 1/2	1.75 1/2	1.75 1/2	1.75 1/2	1.75 1/2	1.75 1/2	1.75 1/2	1.75 1/2	1.75 1/2
ENGINEERS: MATERIAL HOIST	1.50	1.50	1.25	1.50	1.50	1.50	1.50	1.50	1.25
PILE DRIVER	1.75	1.75	1.40	1.75	1.75	1.75	1.75	1.75	1.60
STRUCTURAL STEEL	1.75	1.75	1.60	1.75	1.75	1.75	1.75	1.75	1.60
GLASS WORKERS	1.40	1.40	1.12 1/2	1.40	1.12 1/2	1.21	1.40	1.40	1.40
IRONWORKERS: ORNAMENTAL	1.60	1.50	1.25	1.60	1.50	1.31 1/4	1.50	1.50	1.60
REINF. RODMEN	1.50	1.50	1.60	1.50	1.50	1.60	1.50	1.50	1.25
STRUCTURAL	1.75	1.75	1.75	1.75	1.75	1.75	1.75	1.75	1.37 1/2
LABORERS: BUILDING	1.00	1.00	.90	.87 1/2	.95	.90	.93 3/4	.90	.90
CONCRETE	1.00	1.00	.90	.87 1/2	.95	.90	.93 3/4	.90	.90
LATHERS	1.75	1.75	1.50	1.75	1.60	1.75	1.75	1.75	1.75
MARBLE SETTERS	1.50	1.50	1.90	1.50	1.50	1.50	1.50	1.50	1.50
MOSAIC & TERRAZZO	1.25	1.25	1.12 1/2	1.25	1.15 S/B	1.12 1/2	1.25	1.25	1.37 1/2
PAINTERS	1.50	1.50	1.28-4/7	1.50	1.43	1.50	1.50	1.50	1.50
PILEDRIVERS	1.54	1.54	1.54	1.54	1.54	1.54	1.54	1.54	1.54
PLASTERERS	1.75	1.83 1/2	1.75	1.75	1.75	2.00	1.42-6/7	1.44-2/7	1.54
PLASTERERS' HODCARRIERS	1.50	1.60	1.40	1.50	1.18 1/4	1.50	1.50	1.50	1.50
PLUMBERS	1.70	1.70	1.53-1/8	1.70	1.68 3/4	1.62 1/2	1.70	1.70	1.50
ROOFERS	1.50	1.50	1.37 1/2	1.50	1.37 1/2	1.37 1/2	1.25	1.37 1/2	1.37 1/2
SHEET METAL WORKERS	1.50	1.50	1.50	1.50	1.50	1.50	1.37 1/2	1.50	1.50
SPRINKLER FITTERS	1.58	1.58	1.53-1/8	1.70	1.68 3/4	1.62 1/2	1.70	1.70	1.50
STEAMFITTERS	1.75	1.75	1.53-1/8	1.70	1.68 3/4	1.62 1/2	1.70	1.70	1.50
STONESETTERS (MASONRY)	1.87 1/2	1.87 1/2	1.50	1.75	1.75	1.75	1.75	1.75	1.50
TILESETTERS	1.50	1.50	1.37 1/2	1.50	1.37 1/2	1.50	1.37 1/2	1.50	1.37 1/2

Prepared and compiled by

CENTRAL CALIFORNIA CHAPTER, ASSOCIATED GENERAL CONTRACTORS OF AMERICA

with the assistance and cooperation of secretaries of General Contractors Associations and Builders Exchanges of Northern California.

THE TORMEY COMPANY

GENERAL PAINTERS
AND DECORATORS

Phone UNderhill 1913

563 FULTON STREET
San Francisco

IN THE NEWS

NEW GROUTING AND PATCHING AID

The Building Products Division of L. Sonneborn Sons, Inc., New York, has introduced Ferrolith "G", a new compound for use in concrete grouting and patching, re-pointing mortar joints, sealing pre-cast pipe joints and similar functions.

The material, it is announced, when mixed with cement and applied as grout, expands upon oxidation and overcomes the natural tendency of the concrete toward shrinkage. As a result of this action, it eliminates vibration and shifting of machinery by providing a level contact between the concrete and the machine base, provides a secure anchorage for bolts to be placed in concrete by forming a non-shrink bond between the bolt and concrete, and strengthens structural and other supporting columns by producing a strong, load bearing foundation that is resistant to high compression and impact.

COMMEMORATIONS

Elsewhere in the press is noted the growing tendency in American cities to abandon the old custom of erecting statues of men with their right hands in the bosoms of Prince Albert coats, while they waive the left, for variety with a sheaf of documents in the other, to commemorate the winning of a war, or something. We went through a period of cast iron shafts and what not, but now we are erecting buildings, all of which is good, if for no other reason than that it gives work to laborers. But if we are going to commemorate the winning of this war by erecting a building, an auditorium or an operahouse, let's try to make sure that it will be something that can be used, for an empty building is a heck of a commemoration.



HERRICK IRON WORKS

STRUCTURAL STEEL
REINFORCING STEEL

18TH AND CAMPBELL STS.
OAKLAND, CALIF.
Phone GLencaurt 1747

G. P. W. JENSEN & SON

Building Construction

320 Market Street, San Francisco
Phone: GARfield 2444

Phone GARfield 1164

Thomas B. Hunter

Consulting Engineer

DESIGNER OF HEATING
AIR CONDITIONING
VENTILATING AND WIRING
SYSTEMS, MECHANICAL
AND ELECTRICAL EQUIP-
MENT OF BUILDINGS

41 SUTTER STREET
ROOM 710
San Francisco California

JOHN CASSARETTO

—Since 1886—And Still Active—

Building Materials

READY MIX CONCRETE
ROCK - SAND - GRAVEL - LIME
CEMENT - PLASTER - MORTAR
METAL LATH - WOOD LATH
STUCCO - WIRE NETTING

Service Unexcelled

Bunkers
Sixth and Chennel, San Francisco
Phones: GARfield 3176, GARfield 3177

ANDERSON & RINGROSE

General Contractors

320 Market Street, San Francisco
Phone GARfield 2245

MULLEN MFG. COMPANY

BANK, STORE AND OFFICE
FIXTURES—CABINET WORK
OF GUARANTEED QUALITY
CHURCH SEATING

Office and Factory:
60-88 RAUSCH ST., Bet. 7th and 8th Sts.
San Francisco
Telephone UNderhill 5815

DINWIDDIE CONSTRUCTION COMPANY

•
BUILDERS
•

CROCKER BUILDING
SAN FRANCISCO

ARCHITECT AND ENGINEER

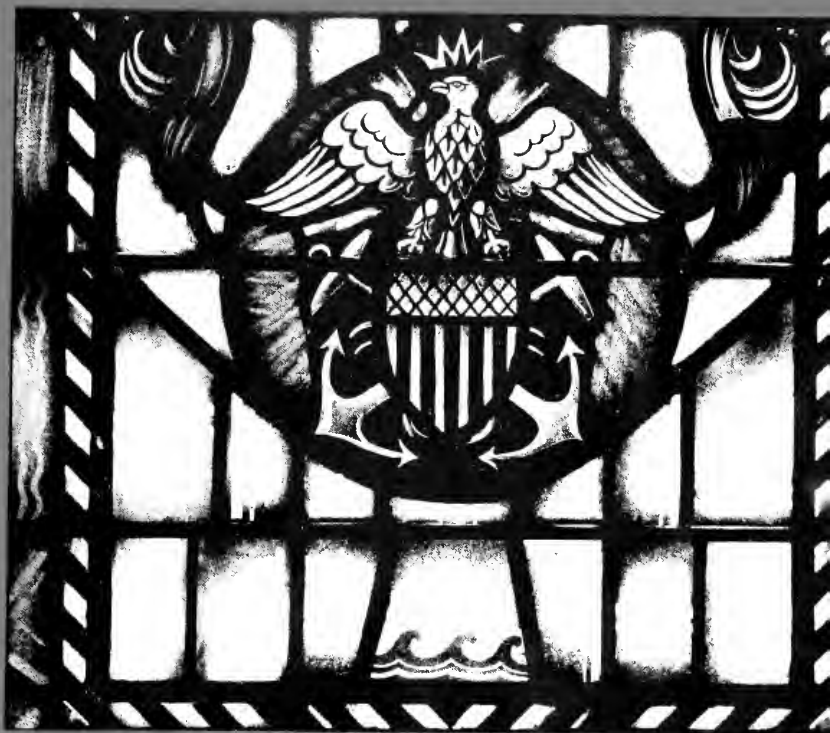

FEBRUARY

1945



TORTURED... BY NOISE!

CENTURIES AGO, it was discovered that constant noise drove people crazy. It was called "torture."

Today, in offices and factories, we are exposed to similar torture... the concentrated bombardment of hundreds of little noises. This irritating noise barrage produces fatigue, decreases efficiency, impairs hearing and creates emotional disturbances. Furthermore, getting accustomed to noise doesn't lessen its harmful effects.

Practically the entire medical profession agrees that modern-day noise constitutes a grave menace to the physical and mental life of all office and factory workers.

Noise problems for thousands of firms have been successfully solved by Western Asbestos Co. Using Acousti-Celotex, the most widely used of acoustical

materials, noise is transformed into a gentle hush. It reduces nervous fatigue, aids production, steps up efficiency. Morale improves... absenteeism and employee turnover are sharply reduced.

Acousti-Celotex can be quickly applied to ceilings and other surfaces without disturbing office or factory routine. It can be painted repeatedly without impairing its efficiency.

Western Asbestos Co. offers a complete sound conditioning service... from design to complete installation. Counsel and recommendations of a sales engineer are at your service—without obligation.

WESTERN ASBESTOS CO.

Acoustical Engineers and Contractors

675 TOWNSEND STREET, SAN FRANCISCO 3, CALIF.
OAKLAND • RICHMOND • SACRAMENTO

• ARCHITECT

Vol. 160 No. 2

AND ENGINEER

ARCHITECTS' REPORTS—Published Daily

MARK DANIELS
Editor

E. H. WILDER
Associate Editor

MICHAEL GOODMAN
Post-War Planning

L. H. NISHKIAN
Consulting Editor

E. N. KIERULFF*
Ass't Editor
*In the Service

★
Contents for

FEBRUARY

COVER: Portion of the Great Window, U. S. Navy Chapel,
Treasure Island

ARTICLES AND MISCELLANEOUS TEXT

	Page
RUNNING FIRE	4
AGE OF PORCELAIN	6
By CHINGWAH LEE	
NEWS AND COMMENT ON ART	6
GOODMAN EXPLORES THE FUTURE	11
By MICHAEL GOODMAN	
WITH THE ENGINEERS	19
STAINED GLASS IN ARCHITECTURE	20
By HAROLD W. CUMMINGS	
WHAT IS MODERN ARCHITECTURE	24
By JAN REINER	
IN THE NEWS	36
PRODUCERS' COUNCIL PAGE	40
BOOK REVIEWS	41
ESTIMATORS' GUIDE	43
INDEX TO ADVERTISERS	48

★
ARCHITECT AND ENGINEER (Established 1905) is published on the 15th of the month by The Architect and Engineer, Inc., 68 Post St., San Francisco. President, K. P. Kierulff; Vice-President and Manager, L. B. Penhorwood; Treasurer, E. N. Kierulff; Advertising Manager, V. E. Atkinson, Jr.

Los Angeles Office: 403 W. 8th Street.

Entered as second class matter, November 2, 1905, at the Post Office in San Francisco, California, under the Act of March 3, 1873. Subscription United States and Pan America, \$3.00 a year; \$5.00 two years; foreign countries \$5.00 a year; single copy 50c. ARCHITECTS' REPORTS are published daily from this office, Vernon S. Yallop, Manager.



RUNNING FIRE — by MARK DANIELS

One of the reasons why some designs fail of physical accomplishment is that they are conceived in materials that are not capable of construction within economic or practical limits. One may create the design of a beautiful building but if it cannot be expressed in the lasting materials of today the chances are that it will never be built. In discussing this subject with Mr. Arthur Brown, Jr., F.A.I.A., he held that many of the fine designs that were not built of materials in harmony with the design failed aesthetically. Efforts to change plans to accommodate them to materials other than those in which the building was conceived only seem to make things worse.

It is true that we can build anything in any form, out of any material we choose, but at what cost and to what end! It would be better if the structure were built in a straight forward material and to the best of our knowledge. In other words, if a building is designed as a wooden structure but calls for members of a size that is beyond the size of economical wooden members, it is better to re-design the whole job.

I was once associated with a man who designed a palatial residence. It was to be of timber construction, presenting a sort of primitive massiveness. But there were corbels, overhangs, cantilevers and braces that could not, within the most optimistic estimates, be expected to stay in place without shrinkage or deviation in line for ten years. By the time the plans for big timbers had been changed to concrete, and similar alterations had been made in the plans, the building was neither "fish, flesh nor fowl," unless you want to spell the last word with a "u." As Mr. Brown said, "An architect should always think of a building in the material of which it should be built."

GOVERNMENT IGNORES PRE-NATAL INFLUENCE

Most of us know little or nothing about the theory of pre-natal influence. Perhaps there is nothing in it; perhaps a pregnant mother may be visited by a tax collector and give birth to a son who has an abhorrence for paying his income tax; perhaps it is all tommy rot and perhaps it isn't. But that is no good reason for the Government leaving, for an indefinite time, a fright in color, or lack of it, in the center of an otherwise beautiful city—a fright that would throw a pregnant woman into a series of pre-natal vision that might result in

the birth of anything from a sun fish to an octopus. But that is just what our Government has done to our beloved city of San Francisco.

Back in the days of threats of bombing in the city, the new mint out on Market Street was a white and shining invitation to an aerial attack. It stood out from the air like a white nose on a red face. To paint it out of the landscape, or at least to give it a less conspicuous color was logical, although they did not have to paint it that execrable purplish black. However, it was done, back some years ago. Now this dignified and well designed building on a lofty rock promontory stands out in black horror dominating the surrounding area with a sense of impending disaster.

While casting about in search of a worthy cause for spending money to improve conditions in the City of San Francisco many of us are praying that the Federal Government will restore the Mint Building to a proper color that it has awaited so long before the community mothers blast it down without awaiting the visitation of the Japanese.

BARGAINING AGENTS

Elsewhere in this issue is an item about the steps the Engineers are taking in anticipation of the need of a bargaining agent to represent engineer employees in their negotiations with employers. It is really tantamount to unionizing such employees and when considered as such should be a guide-post for future action among the architects.

Since many architects employ both architectural designers and draughtsmen along with structural engineers the time will soon come when the architect may find himself confronted with a bargaining agent for his engineers and not for his other employees. Not that such a condition would be serious but it might offer complications. The principle difference lies in the fact that the more or less unionized engineer employees usually work for a large concern with whom they may negotiate over a period of some time while with a small architect the delay of a week or two may be fatal.

This whole question of unionizing amongst architectural employees, architects, and in fact among all professional people has been discussed casually and often but no fruit has been born. The problem is confronting us in increasing insistence and, since it has to be settled sooner or later, it would seem that this is a good time to begin at the bottom.

SHE WILL BE PROUD OF HER KITCHEN IF....

*it's Modern,
Beautiful, Practical.*

"ALL GAS"-Equipped

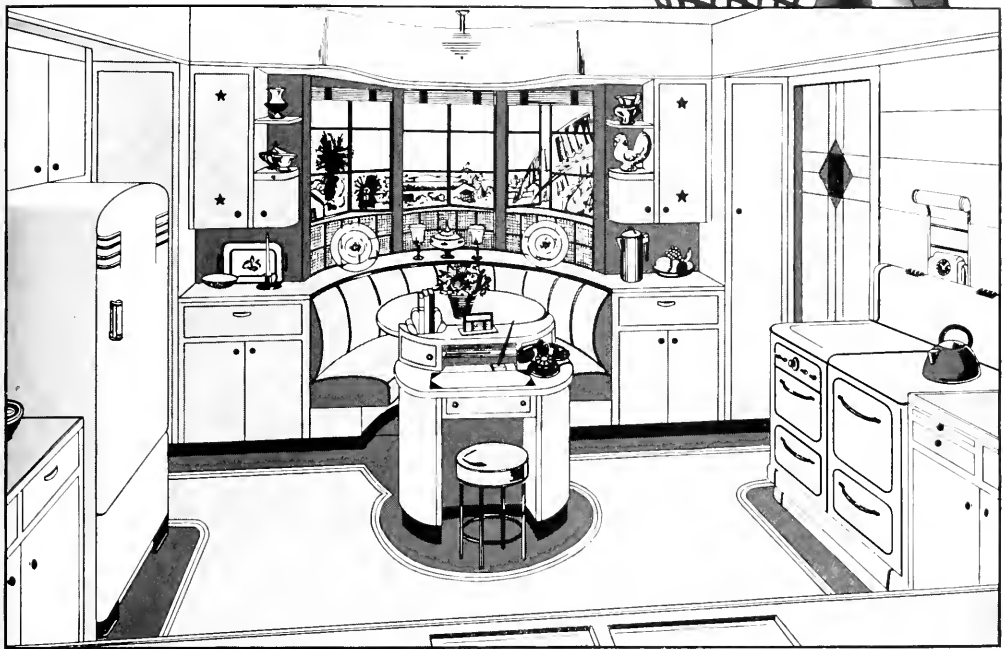

PLAN the kitchen for its modern role as housewife's headquarters, gay party-rendezvous, rival to the dining room for family meals. ★ This design, practical as it is appealing, features step and work-saving arrangement. The mechanical servants are all-gas: CP (Certified Performance) gas range; silent gas refrigerator; automatic gas water heater; a gas-fired heating system that fills this and every room with clean, uniform, healthful warmth. ★ Your gas company will gladly collaborate in your kitchen planning . . . and in preparing "all-gas" specifications, the West's first choice.

THE WEST PREFERS



GAS

QUICK • CLEAN • DEPENDABLE
FLEXIBLE • ECONOMICAL

THE PACIFIC COAST GAS ASSOCIATION



MING DYNASTY blanc de chine porcelain. Satiny white incense urn, figurine of Kuan Yin or Goddess of Mercy and libation cup, from the Te Kau Kilns of Fukien.

Photo, Courtesy De Young Museum.

The Age of Porcelain

By **CHINGWAH LEE**

(In previous articles, Mr. Chingwah Lee, noted ceramic expert, outlined the development of pottery and stoneware in China. The present and forthcoming articles deal with the production of porcelain in all its interesting manifestation. Mr. Lee, art consultant for Hollywood, is currently appearing in M.G.M.'s "Thirty Seconds Over Tokyo.")

The Age of Porcelain in China falls upon two periods, the Ming dynasty (1368-1643 A.D.) and the first half (up to 1795 A.D.) of the Ching dynasty

(1644-1911 A.D.). The Ming potteries witnessed the installation of a rather nationalistic regime, the gradual decline of nearly all the Sung monochromes and the rise of the vogue for polychromes. The imperial kilns were installed at Ching-te Chen and soon master potters from all the famous kilns of China were at work in this great ceramic center. The exchange of ideas on the one hand and the competitive spirit on the other must have inspired the potters to great heights of endeavor. The Ming potters—improving on the white stoneware of the Ting kilns, by increasing the kaolinic

NEWS AND COMMENT ON ART

content of the paste, by intensive purification of all ingredients used and by firing their wares at a higher temperature—soon produced a glistening white, semi-translucent and highly resonant ware we call porcelain or chinaware.

Ming productions may roughly be divided into three classes: blue and white, monochromes and polychromes. The blue and white constituted a large and important class of Ching-te Chen porcelain. This blue is derived from cobalt and appears in many shades, the best being an intense sapphire blue. Painting in this blue is applied on the unglazed ware and then permitted to dry before glazing and firing. The blue, blending with the glaze, has a depth which is best described as pulsating.

Those of the Yung Lo period (1403-1425 A.D.) are said to have a soft greyish blue, but available specimens are few and far between. The blue was imported from the near-East and are called hui

hui ching or Mohammedan blue. The true hui ching is that of the Hsuen Te period (1426-1435 A.D.) when artists worked with uninhibited inspiration and when a superior type of hui hui ching called *su ni po* was imported. The blues of both periods are said to be "heaped and piled," which is to say that it has a vibrant undulating quality. The glaze has a limpid, lard-like smoothness; a few being pitted here and there with dark spots or pin holes—the "beauty spots" of Chinese porcelain. The potters of the Cheng Hua period (1465-1484 A. D.) failed to obtain all the imported blues desired and native blues were used on the commoner wares. Most Cheng Hua blues have a soft grey tone. The painting and potting remained at a high order.

In general, the blue and white of the latter Ming periods are inferior to those of the earlier periods. Fresh supply of a deep shade of Mohammedan blue was available during the Cheng Te (See Page 9)



MING DYNASTY PAINTED PORCELAIN. Blue and white jar, 16th century, blue and white covered jar, 17th century, and saucer with decoration in five colors, 17th century.

Photo, Courtesy De Young Museum.

Ready to Serve You...

TECO Wood Products Development Shop and TECO Wood Chemistry Laboratory

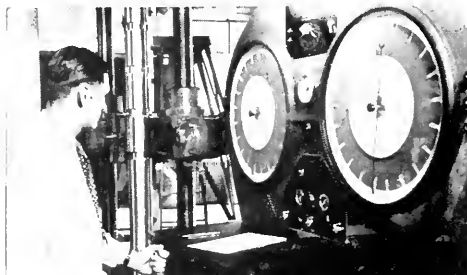

• 200,000 lb. Baldwin-Southwork Hydraulic Testing Machine for tension compression and bending tests on wood.

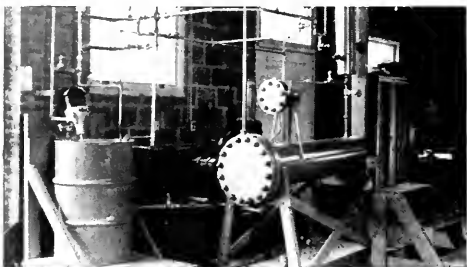

• Autoclave for Pressure Treating Woods with chemicals and preservatives, Automatic Mixer at left.



• Director of Research and Chief Chemist discuss wood chemistry problem in Teco Chemistry Lab.

More than 200 government officials, engineers, architects, building officials and representatives of the lumber industry attended the formal opening of Timber Engineering Company's Wood Products Development Shop and Wood Chemistry Laboratory at Washington, D. C.

The Wood Products Development Shop has a 200,000 lb. Baldwin-Southwork testing machine; a testing rig equipped to handle trusses up to 50' span; autoclaves and other equipment used in pressure treating; dry kiln and high pressure steam equipment for impregnating; and other facilities for determining the physical and mechanical properties of wood and wood products.

The Wood Chemical Laboratory has modern equipment for investigations in wood chemistry and wood derivatives research. It is giving special attention to lignin research including adhesives, synthetic plastics, etc.

If you have any problems in respect to the physical, mechanical and chemical properties of wood, the technical staff of the Timber Engineering Company may be of assistance on a moderate fee basis. If its own facilities will not solve your problem, it will assist you in locating sources which can.

Consultations at our Washington office may be made by appointment and without obligation on your part. Write us on your business letterhead stating your wood utilization problem.

Watch for announcement of our new book, **THE FOREST INDUSTRIES BLAZE NEW TRAILS.**



• Teco chemist working on chemical derivatives of wood.

Timber Engineering Co., Inc. of Washington, D. C.

Manadnock Building, 681 Market Street, San Francisco • Telephone Garfield 6296



**SPECIFY TECO CONNECTORS
SPLIT RINGS • SHEAR PLATES
GROOVING TOOLS**

KEEP ME POSTED

Alden K. Smith,
Manadnock Building,
681 Market St., San Francisco

AE

Put my name on your mailing list.

Name _____

Firm _____

Business _____

Street _____

City _____ State _____

period (1506-1522 A.D.). This blue, the fo tou ching or Buddha Head Blue, has a tendency to run, unless a little native blue is mixed with it. The blue of the Chai Ching period (1522-1567 A. D) is also imported, and it has a violet hue of great intensity. The ware of the Wan Li period (1573-1620 A.D.) varies greatly in paste, glaze and the color of the blue.

Generally associated with the underglaze blue is an underglaze red derived from copper and, in fact, the two are often seen together on one article. A famed ware of the Yung Lo period is the white tazza cup with three fishes in hsiung hung or fresh red, the red being applied as an underglaze wash. A delicately pencilled red, called yu li hung or underglaze red, often takes on a peach bloom tinge.

The red monochromes are also derived from copper. Two types are produced, the pao shih hung or precious stone red and the hsiung hung or fresh red. Both are used for the worship of the sun and are known as chi hung or sacrificial red. Other high fired monochromes produced at this period include several shades of black, blue, subergine, and white. A very fine white eggshell bowl with an hua (subtle decoration) was made during the Yung Lo period. The bowl, called ya shou pei (hand fitting cup), has incised decoration of birds, animals or flower, so lightly etched into the biscuit that unless held before a strong light they cannot be seen. Lower fired monochromes were also produced in large number, and they will be considered later. Practically all the monochromes of the Sung potters continued to be made. Some Sung glazes were reproduced by the Ching-te Chen potters and applied on a porcelain base.

Polychromes may be divided into two main types, the an glaze and the sur biscuit. The sur biscuit polychromes are fired in a medium-fired kiln (edmi grand feu) and constitute a very bold and highly decorative type of ware, well suited to the temperament of the time. They are known in China as san ts'ai (three colors) because usually three only of the following colors were used on any one piece: violet blue, turquoise, leaf green, yellow, aubergine and a colorless white made by coating a clear glaze over the biscuit. The ground color is usually violet-blue or turquoise. The glazes are applied over a "bisque" (porcelain which has been fired previous to glazing) and then stoved in a kiln with a moderate tempera-

(See Page 31)



SELF PORTRAIT by Rixier

During the month of February the CALIFORNIA PALACE OF THE LEGION OF HONOR is holding a number of exhibits that bid well to keep the footsteps of art lovers warm between downtown and the museum. There will be seven different exhibits, all of which will offer more than usual attraction as will the usual permanent exhibits. The list embraces:

- Art on the Home Front
- One Hundred Years of Portraiture Photography
- Oils by a Group of Ten Artists
- Thirteen Watercolorists
- Bronzes by Theodore Riviere and Arthur Putnam From the Spreckels Collection
- Old Masters From the Museum's Permanent Collection
- Study Exhibition of the Art of Greece.

Plan it in STEEL...

STEEL IS BASIC FOR BUILDING

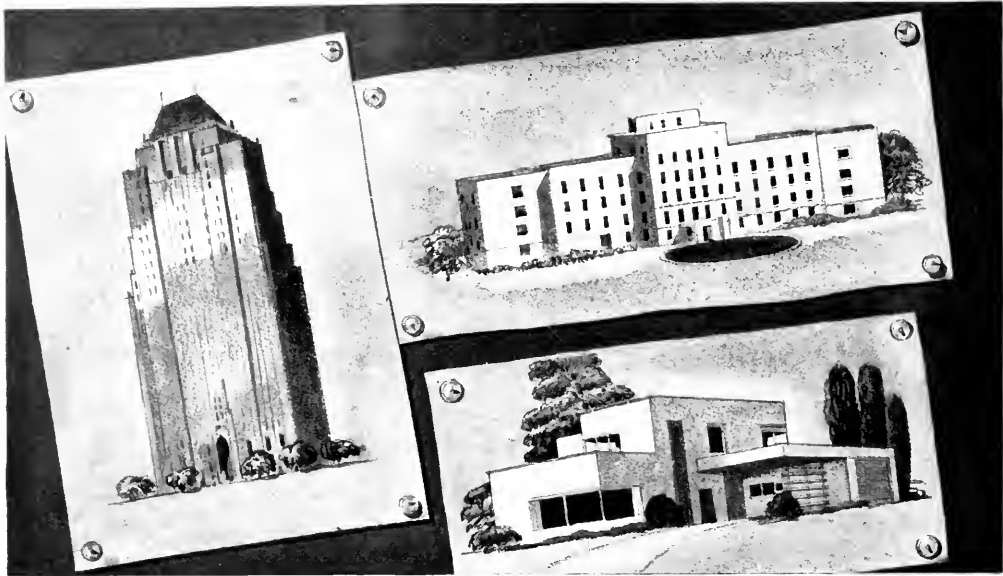

WHAT an opportunity postwar building holds for you men with ideas.

STEEL, proved more practical than ever through magnificent wartime performance, will be available to help you bring refreshing newness to tomorrow's structures.

Schools, churches, hospitals, public and industrial buildings and dwellings offer possibilities for the use of steel that challenge the imagination of practical engineers and designers.

Steel's versatility, speed of construction, greater durability and ultimate economy will reflect your good judgment and simplify the contractor's job.

Go ahead with your blueprints now. Specify more steel than ever in your postwar plans. When we get the "green

light." Columbia Steel Company's great Pacific Coast mills and Columbia's strategically located branches will make available the quality steels your plans call for.

In the meantime, Columbia's experienced building steel engineers are ready now to discuss the many new uses of U-S-S Building Steels.

POSTWAR CONSTRUCTION FORECAST

Mainland and Pacific States

	1938-40 Average	1947-51 (Current Prices)
Mainland	\$ 54,008,000	\$ 144,201,000
Pacific	364,680,000	973,695,000
Total	\$ 418,688,000	\$ 1,117,896,000

From Labor Department Data

U-S-S BUILDING STEELS

PLATES
WIRE RODS
STRUCTURAL SHAPES
HOT ROLLED SHEETS
REINFORCING BARS
MERCHAND BARS
GALVANIZED SHEETS
PIPE AND TUBING
CASTINGS
HOT ROLLED STRIP
COLD ROLLED SHEETS
ELECTRICAL WIRES
WIRE AND WIRE PRODUCTS
SHEET PILING
WIRE ROPE
STAINLESS STEEL
NAILS
FABRICATED STRUCTURAL WORK

COLUMBIA STEEL COMPANY

San Francisco · Los Angeles · Portland · Seattle · Salt Lake City

Pacific Coast Distributors for

American Bridge Company

American Steel & Wire Company · National Tube Company

Carnegie-Illinois Steel Corporation · Tennessee Coal, Iron & Railroad Company

United States Steel Export Company, New York



UNITED STATES STEEL

MICHAEL GOODMAN

Explores the Future

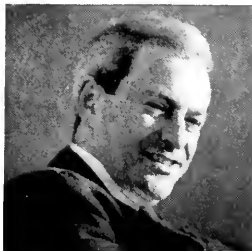

MICHAEL GOODMAN
Architect

Editor's Note: The following article is based on the highlights of talks given by Michael Goodman on behalf of the California State Association's sponsored Home Planning Institute. It treats a realistic approach to functional planning of the house.

In the excitement of preparing for post-war work, we must not overlook new problems arising as a result of changing conditions. In this issue are some examples of work occupying the designers' talents in the country at large and Michael Goodman's work in progress in particular. A few more designs may be published in a forthcoming issue.

It is true that we need millions of average new homes as quickly as they can be produced after controls have been lifted. It is also true that while alterations and conversion may occupy architectural talent for some time to come after the war, the problem of special purpose areas or rooms in the house will challenge the more original minds of the designing profession. At present these possibilities for post-war living are little explored; the tendency had been evident and their emergence is beyond dispute. Lay and professional periodicals have kept a weather eye on the future of popular average house needs and

are setting out to blaze paths and influence public acceptance.

Social and occupational interests at home are having a revival as a result of war emergency. It has undoubtedly affected the future planning of the home in part. It is reasonable to expect that more attention should be given to occupational needs of members of the family group in order to plan a more contemporary house or home. What with the blackout stay-at-home and the Victory garden, renewed attention will be given to the siting of the house as well as to new ideas of sizing the lot. The rumpus room, recently invented and the loan bankers' delight, will become more of a hobby room than just a gathering place and more thought will be given the livable rather than to the gadget-ridden kitchen. The feeling of reclining posture peculiar to the congenial domestic architecture of the pre-Munich design days should be revised in future planning. Emphasis on out-of-door living must not be the sole consideration in design. Leisure must be more than wasteful and its use should generally tend to be more occupational or even therapeutic in our troubled times.

The crux of the problem is to have less theorized prefabrication and standardized miracle equipment to go with "post-baloney" but rather sensible planning for useful inter-changeability to meet family trends. The smugly labeled modern American home conjured up by designers for the distributors will have to be revolutionized. It seems that the primary object of the after-the-war home should be simple living for which houses should be planned to strip housekeeping to essentials. Hence, for instance, is the emphasis on utility rooms. This means that a closer collaboration with manufacturers must be established.

The house can be more useful if one plans to make each room serve as many purposes as feasible. For those who had their homes planned with foresight by architects, places could be found to create an isolated spot; or use can be made more intensively of other house areas for

(Continued on Page 18)

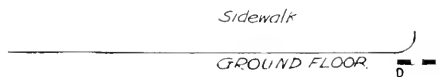
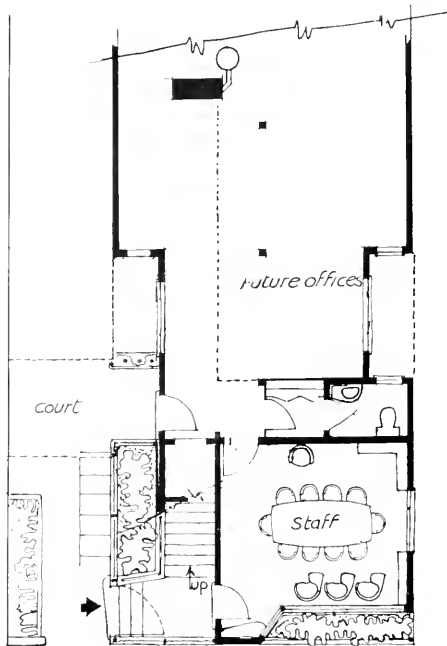

date. It is proposed to extend the premises to the sidewalk property line.

Entrance from the court side is to be screened off with glass against exposure.

Rooms on both floors are for various consultation offices, some of which are to be made sound-resistant.

Note an unusual feature of providing excessive waiting space, including that for parents accompanying their children. Files are generally kept out of sight, except for those in immediate use.

Project I:

ALTERATIONS FOR PSYCHIATRIC OFFICES

By MICHAEL GOODMAN, Architect

There are still many persons who have a marked aversion to entering a hospital. It may be this or some other reasons why there is a tendency of some psychiatrists to occupy residential premises for consultation work.

The present residential structure is to be connected to the adjacent one at a future

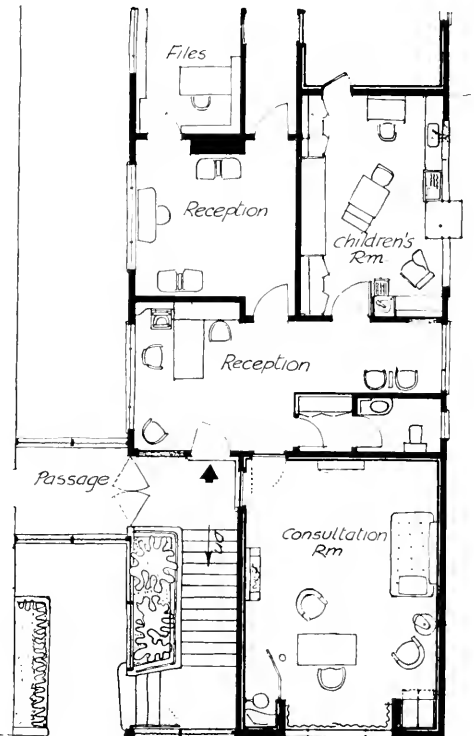

SECOND FLOOR

The children's room rather explores some possibilities of arrangement of furniture aids for play and observation. Much storage space is essential to keep models and toys. Note aviary, fishpond, wash-up sink, paint center and music facilities next to doctor's corner. The play table is level-adjustable.

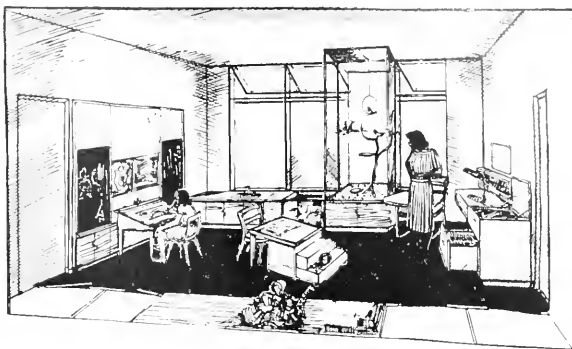

CHILDREN'S ROOM

The arrangement of the adjoining room will vary with kind of treatment.

The adult consultation room provides for ample light, yet a feeling of closed-in wall arrangement. The furniture is arranged in the preferred working manner in relation to light. It was brought out that the interior treatment and furniture should be personalized from the doctor's point of view, rather than the patients', since it is the psychiatrist who spends most of his time here.

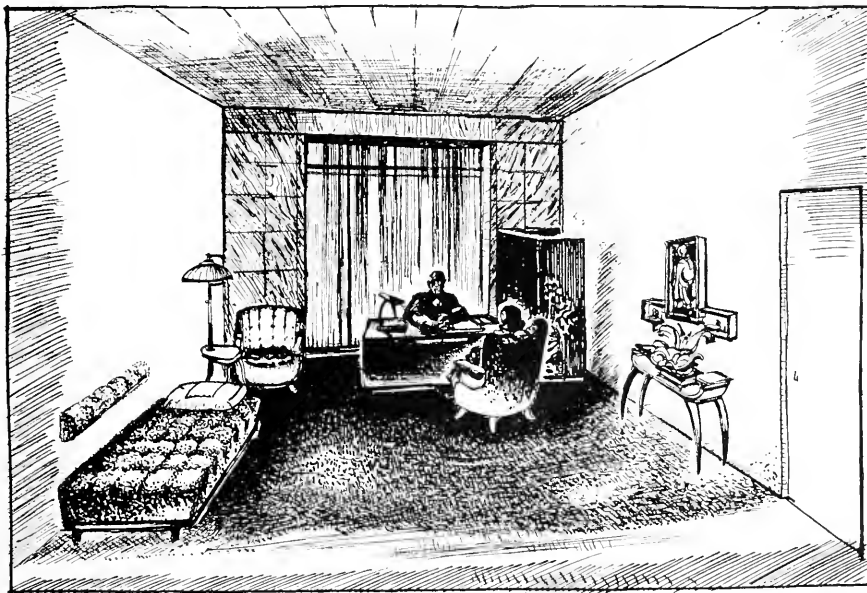

ADULT CONSULTATION ROOM



ALTERATIONS FOR PSYCHIATRIC OFFICES

By MICHAEL GOODMAN, Architect

A "before" view of the residence in the vicinity
of a hospital chosen for the purpose.

The "after" view
of the project,
showing added
building area and
entrance treatment.

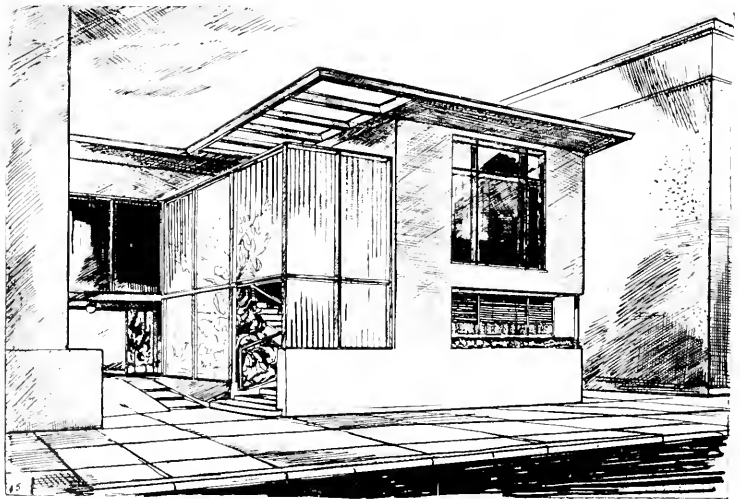

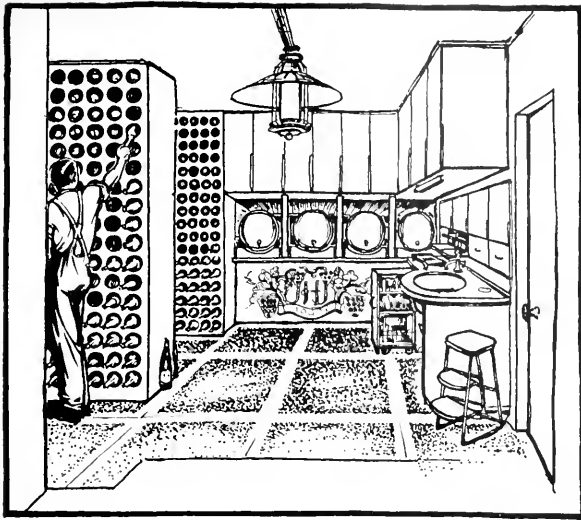

Project II:

ALTERATIONS FOR A WINE CELLAR

Deep below the street level of one of Berkeley's picturesque lots is a space reserved for alteration of a wine cellar. The client, a bookman,

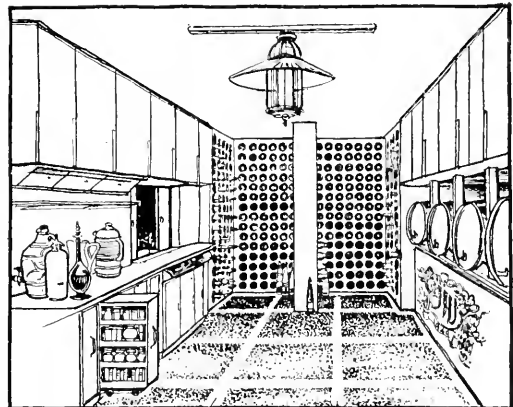

Photo
as before.

View of the
present.

not only collects first edition books, but also sports "first edition wines."

Hinged around the "before view" are proposed alteration views of the wine cellar, the description of which follows on the next page.



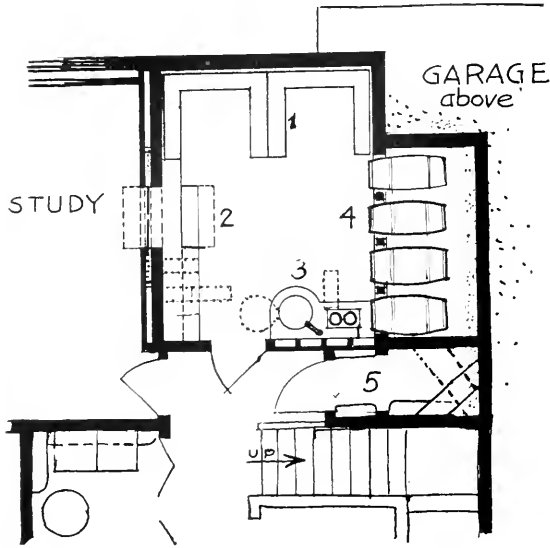

WINE CELLAR

By MICHAEL GOODMAN
Architect

Referring to numbers on the "after" plan:

1. Shows light weight concrete slabs for holding bottles.
2. The modest bar-counter with sliding doors to the large adjoining study.
3. Circular sink and gas burner with work top of chop blocks. Cabinets are for storage and equipment. Much is made of spaces between studding for shallow storage. Some drawer-cabinets are rolled out on coasters.
4. Wine barrels are placed against area under the garage.

Floor is finished with colored shasta pebbles. The decoration on the concrete foundation is in encaustic combined with colored pebbles by Dorothy Pucinelli.

BEFORE

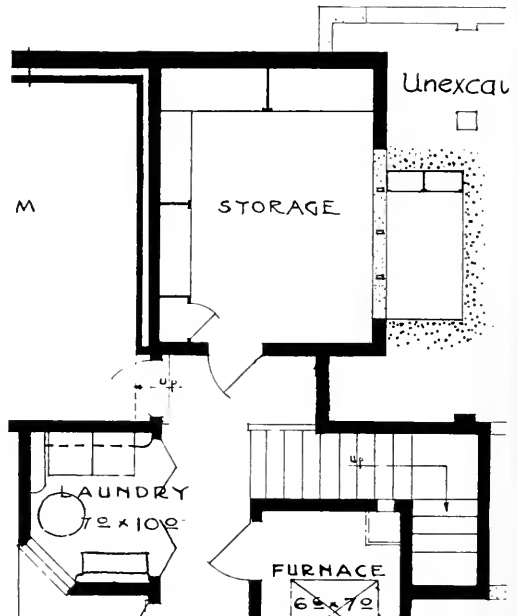

ARCHITECT AND ENGINEER

Project III:
RESIDENTIAL
OFFICE

MICHAEL GOODMAN
Architect

Upper pictures:

View as is.
Proposed alteration.



(Sturdevant)

For those who had their homes planned right in the first place, specially provided space will accommodate a post-war office to rival the convenience of a down-town location, and in addition furnish pleasant surroundings for entertainment of business friends.

Referring to the "after plan" below the numbers are identified as follows:

1. Added balcony to "extend" the view, containing plants and glass case for exotic plant growing.
2. The business side of the office, which is to take in the old study and the open porch, contains office equipment, files, etc.
3. A ping pong table can be unfolded from the nearby storage space and
4. A folding bar complete with stools and alcove containing sink and a hot plate.

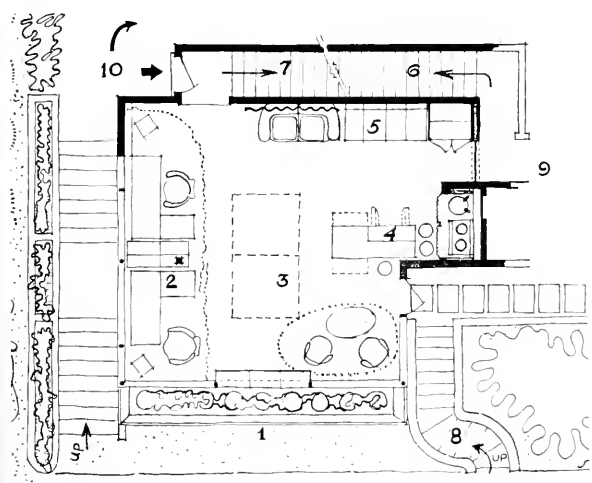

5. There is a projection screen, file space and closet provided.
6. Private stair to garage below and another
7. Leading to the house floor above. Thus establishing a particularly convenient relationship to the rest of the house with
8. The service stair climbing a steep bank to the kitchen side of this very small lot.
9. Shows the heating plant, the maid's room and bath adjoining.
10. Leads to the office and to the main entrance stair of the house half a story higher.

PROPOSED PLAN OF INTERMEDIATE FLOOR
FOR RESIDENTIAL OFFICE

**RESIDENTIAL
OFFICE**

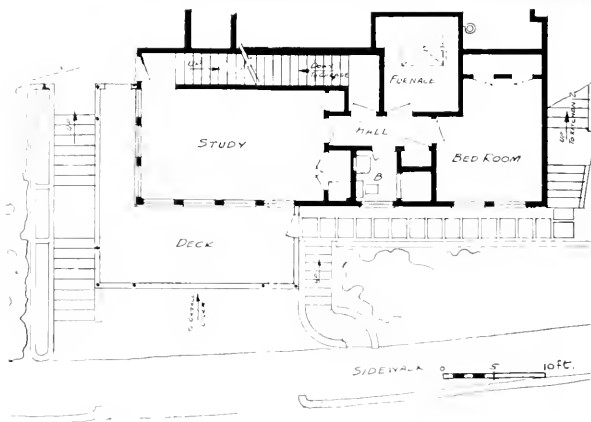

BEFORE PROPOSED ALTERATIONS

any of the countless avocations of the family group. These may be called double-duty rooms. Little used living rooms have been worked to death by designers over-doing glass and furnishings (to the loss of the manufacturer) and remaining insensible to the rest of the house.

Among planning techniques a way to make a room serve a multitude of uses is to separate it into sectional spaces. Depending on social conditions, dining rooms can be parts of recreation and study rooms. The living-kitchen can have more play space for children and be part of a patio scheme. Laundries combine with kitchens and, depending on workways, the utility room is a kind of an omnibus.

The question before the house is, "Who is going to get possession of the living room tonight, parents or children." Shall we have two parlors as in the days of Victorian yore, to solve the situa-

tion, or shall we see the teen-aged with their disturbing problems use the home only as a base to come to "refuel, refurbish and realight again"? The garage just recently admitted to the family of rooms is being used for all purposes and only incidentally for car storage. There is evidence, as in the past, that some rooms or spaces in the house may tend to take on a new nomenclature.

How shall we plan for the tendency of some business folk to establish offices in residences? What about the spatial requirements of psychiatric offices which need exploration? A bookman plans not only for a library-study in which he has first editions, but also for a wine storage of "first editions." Those are, in short, the problems an architect will have to meet.

—MICHAEL GOODMAN.

Acknowledgement is made to Henry Lagorio and Miss Jane Moorehead, School of Architecture students, for their assistance in preparing the drawings.

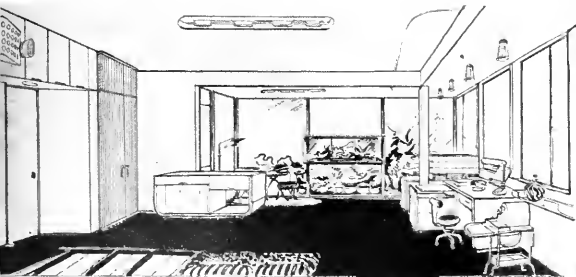

WORDADAY VIEW OF THE PROPOSED ALTERATION

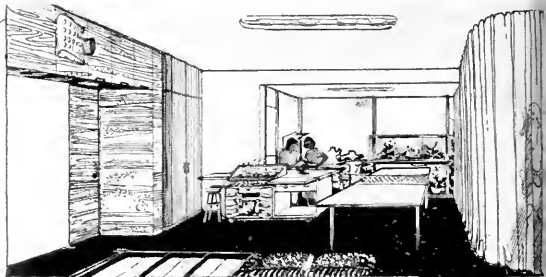

VIEW OF ROOM SET FOR ENTERTAINMENT

ARCHITECT AND ENGINEER

WITH THE ENGINEERS

The professionally trained engineers have organized a group known as the "San Francisco Group of Professional Engineering Employees" which, it is planned, shall act as bargaining agent for engineer employees. The plan is that this bargaining agent shall take up with employers all disputes involving wages, hours, etc., in a purely ethical manner and also represent the employees before the proper government authorities such as the WLB.

In the makeup of the organization no member who has the power of hiring or firing professionally trained engineers shall have a vote. Of course, a member might acquire the hiring or firing power at some date subsequent to his joining, in which case he would have no vote in the action of the body as a whole.

It is also contemplated that there shall be no coercion used in the action of the group in their negotiations with employers. If an action of the employers is requested by the employees and refused by the employers the bargaining agent will take the matter up with the WLB for settlement.

The whole plan is one of amicable and ethical settlement of a dispute, in which the group becomes a bargaining agent for the Engineering Employees.

At the meeting of the Structural Engineers Association of Northern California, held January 8th at the Engineers Club, a program was presented that should have been held for the public at large, could the authority of the War and Navy Departments have been secured. The Engineers have a way of presenting subjects that are worth while, aided by the good judgment of their officers.

Most of the evening was given to an illustrated talk on the salvage operations conducted on the U.S.S. Oklahoma at Pearl Harbor by the Pacific Bridge Company. The program led off with a succinct paper by Mrs. George Noe, Chief Engineer of the Pacific Bridge Company, and was followed by talks of two eminent San Francisco engineers, Mr. Thompson and Mr. Lee, who had assisted Mr. Noe in research work in connection with the salvaging.

The problems of such an heroic task are legion, but these three men made it so clear that all who left the room carried with them a clear picture of what they were and how they were solved.

The slides of the actual salvaging were precluded by a motion picture of the attack by air on Pearl Harbor, presented under the authority of the Navy Department, by Lieut. Commander W. L. Dickey. All in all, it was a program to remember for a long, long time and one of great credit to the out-

going president (as have been many others), Mr. Clarence Seage.

Vice-President J. G. Wright was elected a president to succeed Mr. Seage and Harold M. Ewert was elected vice-president to succeed Mr. Wright. No doubt those who were elected to offices will remember the meeting for that reason but I shall always remember that evening as one wherein I learned something about salvaging.

The final location of the Delta Cross Channel of the Central Valley Project, which will transfer irrigation water from the Sacramento to the San Joaquin Valley, has just been announced by the Regional Office of the U. S. Bureau of Reclamation in Sacramento.

The route of the channel across the Sacramento-San Joaquin Delta, selected after exhaustive studies both in the field and by means of extensive model tests in the bureau's hydraulic laboratory in Denver, follows in general the plan recommended by State Engineer Edward Hyatt, and later approved by the Legislature and the people of California in the special election of 1933.

The Sacramento River water made available by storage behind Shasta Dam will be diverted into the Mokelumne River through an enlargement of Snodgrass Slough. Thence the water will be introduced into the delta through the two main forks of the Mokelumne River. Finally the water will reach the intake of the Delta-Mendota Canal near Tracy by being drawn through the existing channels in the southern portion of the delta, the main flow being through Old River and Middle River of the San Joaquin. Through the Delta-Mendota Canal it will be carried to Mendota Pool some 110 miles south and turned into the San Joaquin River in exchange for the "cropland" water stored at Friant Dam and delivered into the Madera and Friant-Kern Canals.

To study the project, a model was made.

In connection with the model, a machine capable of reproducing any tide of record in Suisun Bay and the delta channels was built to permit study of the effects and currents of salt water invasion of delta channels under the variable conditions likely to occur in the future.

By operating the model, bureau engineers were able to study both salt water intrusions and also the pathways of Sacramento and San Joaquin River water enroute to the sea through the maze of delta channels. In this manner, bureau studies determined the practicability of the original state plan for repelling salt water and for delivering water of the required quality to the Delta-Mendota canal intake.

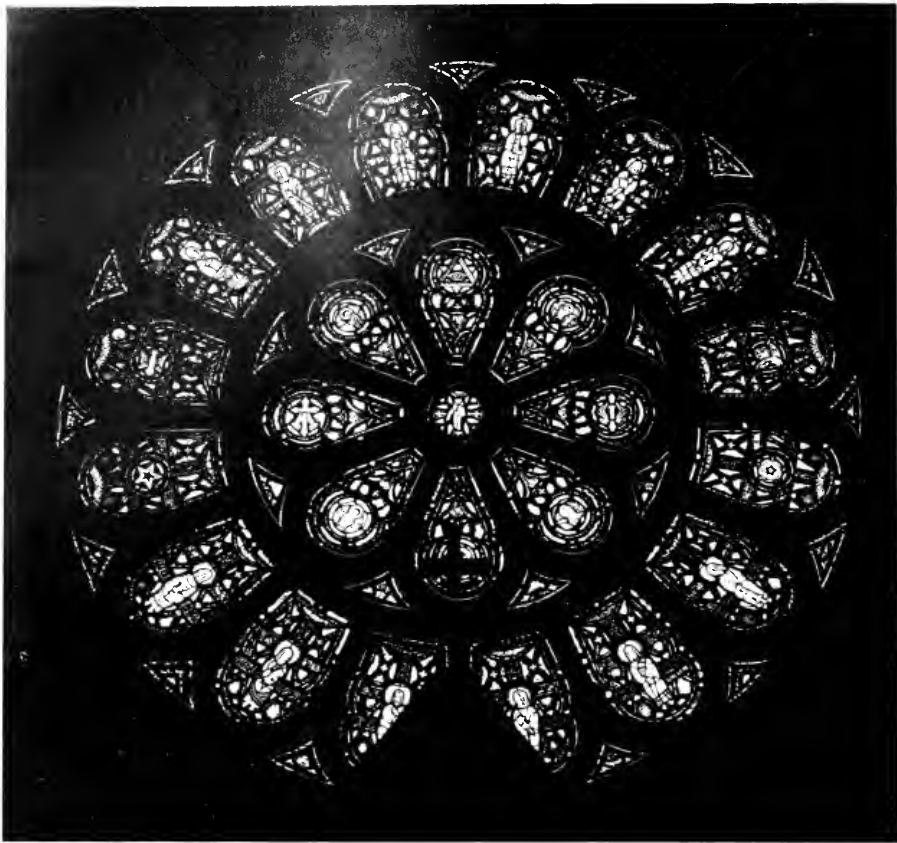

GREAT ROSE WINDOW, SAINT CECILIA'S CATHOLIC CHURCH, LOS ANGELES
(See Page 30)

Stained Glass in Architecture

By **HAROLD W. CUMMINGS**

Stained glass is the beautiful servant to a great mistress, architecture.

The design of the stained glass artist and craftsman is not to make a transparent picture, but to make a window beautiful; not to exclude light, but to capture in it the essential qualities of light

coming through glass, its charm and its changefulness, to make the window sing, pulsate, carol an ever-changing song of joy and inspiration.

Stained glass, in proportion to its adherence to its own principles of design and color centuries old, provides architecture with some of its richest

ornament or its greatest blemish.

Akin to music, and most closely related to the symphony, stained glass loves to be lived with: intimacy brings appreciation. One revels in the rich, harmonious colors, singing in vibrant light.

A stained glass window is an area of translucent wall possessing neither linear nor aerial perspective. Stained glass is not a pictorial or a realistic art, but a decorative art. The subject matter primarily provides a pattern to which the mosaic of colored glass conforms, and is given definite discipline and a meaning which intensifies the meaning of the building which it adorns.

Stained glass is an ideal medium for patterning, but not for painting as we understand it on canvas. Therefore, if we would employ the full genius of glass, we must keep faithfully within the laws of its being and achieve our effect by patterning color in active light. It was the failure to understand these principles which caused the decadence of stained glass; and it is the re-discovery of these principles within the last decades which explains the miraculous rise of the craft and the excellence of some of the stained glass of our own time.

It is becoming more and more widely recognized that the finest stained glass windows since the 12th and 13th centuries are being made today by a few craftsmen in our own country and a few abroad.

As one looks at a stained glass window at close proximity, it may appear almost crude, with its heavy leads and deep-toned glass. But at the distance from which it is intended to be viewed, it is glorious and inspiring in its vibrant, living color. One must see a stained glass window in place—in performance—to appreciate it. A good artist will go to see the place where his window is to be set before the window is designed, not merely to take dimensions, but to consider its orientation, the individual requirements—utilitarian, artistic, and devotional.

A stained glass artist should be chosen on the basis of his own achievement, even if possibly it may mean some effort in travelling to see his finished work. A little colored design on paper may look very pretty; but it is easier to make an exquisite drawing on paper than an even tolerable stained glass window. If, however, you have seen the finished work of an artist, you can trust that even if his paper design is sketchy.

Stained glass through the centuries has been largely a child of the church. The ideal for every church is a series of windows carefully planned

in advance, so as to make an ordered and consistent use of this glorious ornament for didactic, devotional and artistic purposes alike. Individual windows, given as memorials or arbitrarily selected, sooner or later become a matter of regret.

Through centuries of religious fervor, colors have been given definite spiritual meanings. In stained glass the colors are often significantly employed to express qualities. Blue, for instance, symbolizes faith, loyalty, wisdom. Red represents love. Gold signifies achievement. Green implies hope, victory. White is a symbol for purity. Thus, in stained glass we often see the figure of the Lord clothed in white for purity, with an outer-garment of ruby to express His love.

The oldest stained glass window extant is believed by some authorities to be in Dijon, France, and dates from the middle of the 8th century. The 11th century, however, saw the first basically excellent stained glass windows; and examples are to be found in the Cathedral of Augsburg, Germany. The next 300 years in France saw the finest windows ever produced. Le Mans, Poitiers, Sens, Bourges, Chartres (particularly the west windows), St. Chapelle, and Notre Dame in Paris contain exquisite stained glass of this period.



GREAT ROSE WINDOW
Chapel of the College of the Pacific,
Stockton, California

(See Page 30)

During the same time in England beautiful windows were made and include those at York Minster, Canterbury and Salisbury Cathedrals.

The stained glass guilds of the middle ages were often families, generation after generation, producing everything used in their creative work. The guild made the glass and mixed the color that went into it. It designed the window, painted, fired and glazed it.

The very fact that perfect glass (as judged in a mechanized age) was impossible for a guild to achieve, working with simple tools, was a shining advantage. Molten glass was cooled on crude stone slabs from which it took a characteristic texture. As the cooling stones were irregular, the glass would be thicker in some places than in others; and the thicker the glass through which the light had to pass, the darker would be the color. Thus in one piece of glass a range of color value would inevitably be produced. Bubbles, swirls, lines, were imprisoned in the cooling process, giving individuality to each jewel-like piece of glass, and causing an infinite number of angles of refraction which made the stained glass window to sing with active, vibrant color.

Today, the raw glass (called "antique") used in stained glass windows is still made in much the same way as it was in the middle ages: it is still hand blown and still cooled on the characteristic stone slabs.

The color effects created by a stained glass window are entirely different from those produced in a static medium, because a stained glass window is active color, forever "moody" because of the change produced with every variation of light passing through it. When painting on canvas, line and color are produced as they will be finally seen. But no one has ever seen the "final" effect of a fine stained glass window, so responsive is it to ever-changing light. The direct sun, a shifting shadow, the gentle rays of dawn, the bright high noon, the slanting shafts from the setting sun play on the window with infinite variation like the precious change wrought on the theme of an old Bach fugue.

The monochromatic tracing lines in stained glass which depict pattern and detail are obtained by the application of an opaque brownish silica-base paint which, when fired on, becomes permanent. Later, the glass is matted with the same type of silica paint. This mat is rubbed, picked, or brushed away for a specific effect, before it, too, is fired, leaving clearings through which the light can shine, revealing the glorious nature of the glass. These "high lights" play an important part in the ultimate beauty of the window. Each piece of glass is treated individually, and no two effects are identical.

The color in the finest windows is in the glass itself. Colors applied to the surface of the glass by enamels are not permanent, but flake off in a few short years due to the difference in the coefficient of expansion between glass and enamel paints. Enamels are comparatively low in price to use but the result is not good and the work is not permanent. In "picture windows" any applied color effects such as the blue of the eye, the pink of the cheeks, and other humanistic effects must be produced by the use of enamels.

In medieval times, the guild spent much devotion obtaining colors in small pieces of glass. Each piece was almost priceless, and was so used. A very small piece was cut out, and a lead line was run; another small piece of glass, another lead line, and so on.

Today, as then, the lead lines, or lead "came," hold each small piece of glass, necessarily at a slightly differing plane, each plane varying at a slight angle to the general surface of the window itself. These additional angles of refraction help to give to stained glass windows their jewel-like quality. The texture and surface irregularities, together with these angles, produce refraction of light that make stained glass windows vibrate or scintillate in active color.

The fine old school of stained glass craftsmen was not made up of portrait and landscape



**SAINT IVES WINDOW, SAINT IGNATIUS
CHURCH, UNIVERSITY OF
SAN FRANCISCO**

(See Page 30)

painters. They represented their backgrounds and borders, their figures and faces all on one plane, thus producing a flat tapestry effect. As a result their portrayal of Saints and scenes took on a character peculiar to stained glass. They were symbolic, meaningful, inspirational. Their meaning was enhanced by painting on the glass formalized designs symbolic of Christian characters and religious allegories. The fine old windows that have so strongly appealed to critics of stained glass through the years are these conventionalized symbolic windows, not "picture" windows.

This brings up the question: Why should stained glass windows be made with the idea of imitating the realism in which canvas painting excels when no other art can approximate its own power to pattern tapestry effects of active color in light? Why not abide by the inimitable law of its own being and continue to explore the realm of beauty in radiant color harmonies?

With the passing of the old guild craftsmen, their sons turned away from a field which had become inactive, to newer pursuits; and there followed a period of dormancy for the craft of stained glass. This was true of many essentially ecclesiastical craft. However, the time for church architecture to flourish came again; and the only artists available, portrait and landscape, were commissioned to design stained glass windows. That was the beginning of the decadence of true stained glass design. Light shining onto a canvas comes from the front and sides to a non-lucent material. This permits perspective, modelling. However, shining through glass, light comes from behind, actually through the medium. Therefore any attempt to portray realism is pulled up flat. The Renaissance glass painters attempted to produce realistic effects, using glass in the manner of canvas, thus straying from the very nature of their medium. They covered the surface of their glass and reduced irradiation. This mis-use of glass in the manner of canvas was the Burne-Jones error. He excluded the light in the interest of his design, and sacrificed the prime function of a window.

At the height of the early stained glass era, the 12th and 13th centuries, great wealth was available for church construction and beautification. Individuals willingly made sacrifices so that the work might be carried on. Consequently, the stained glass craft was active. With the religious unrest culminating in the Reformation, funds for church construction and ornamentation were scarce and the art of stained glass began to disappear.

Nevertheless, the principles of stained glass have remained through the centuries; and it is



U. S. NAVY CHAPEL ON TREASURE ISLAND
(See Page 30)

the revival of the methods employed by the old craftsmen which is making its appeal today.

In modern architecture the use of stained glass is being widely extended. Once almost exclusively cloistered in the church, stained glass today has emerged to share its glory with the world. Public buildings, mausoleums, schools, homes, army and navy chapels, all have taken to themselves this vitally joyful expression. Throughout the country, colleges are becoming stained glass conscious; and college chapels and memorial buildings on several campi have notable modern stained glass windows. This is particularly gratifying and important, as the unfolding appreciation of fine stained glass by these young men and women carried back to their own communities, raises the

(See Page 30)

What Is Modern Architecture

By **JAN REINER, Designer**

The task of contemporary architecture is to raise the standard of dwelling according to contemporary science and technology. While centuries ago the architect planned monuments to house Gods and Kings, today the architect is planning communities to house free and healthy people. Architecture—a mirror of a civilization—is perhaps the most durable document of a civilization. Buildings convey the idea of security, permanence, and continuity within the everchanging world. "Architecture," to quote Frank Lloyd Wright, "is a bridge over which the past reached the present and the present will reach the future." Just as a civilization is constantly evolving, so is architecture. As a style, architecture does not repeat itself; on the contrary, developing from within, it is always new and alive. That is why architecture has always been "modern."

An architectural style develops from social and economic conditions, geographical locations, and building materials and methods. Each style, therefore, is appropriate to its own times and conditions. It is not necessarily appropriate a hundred years later, even in the same geographical location. At any given time the available building materials and the current building methods partly determine the appearance of the buildings—the rest is determined by the artistic and technical skill of the designer. In our times there are about six building materials which, together with our way of living and working, determine our—the "modern"—style. They are: steel, concrete, wood, stone, brick, and in the near future the plastics.

It has often been said that this is an age of steel. Since the construction of the Crystal Palace at the Industrial Exhibition in London, in 1851, a new way of building—the skeleton system—was developed. It allowed for a quicker, safer, and cheaper construction, as well as for more light for interiors. The Crystal Palace was the first example of a huge hall built of glass and metal, supported

by small and relatively few columns. Some years later, the Hall of Machines at a Paris Fair demonstrated that even larger spans can be produced without supporting columns, and from that time on almost every World's Fair contributed some new structural innovations to a new way of building. A hundred year story of steel engineering and production is written between the first steel and cast iron bridges of England and the gently curved suspended highway of Golden Gate Bridge. The scientific design of the engineer influences the academic thinking of the architect. Perhaps the most valuable lesson that the engineering calculation taught the architect at the beginning of this century was to eliminate unnecessary building material, which, in turn, resulted in the elimination of unnecessary decoration—and gradually "the form followed the function."

The possibilities of large scale steel constructions are beginning to be realized. Let us suppose that we space six towers of the Golden Gate Bridge two hundred feet apart and widen its six suspended highways into one huge platform. Fig. 1. Then let us suppose this platform were the roof (or landing field) of a vast space underneath—a vast space without columns. This is a way that the future assembly halls, factories, auditoriums, and the like, may be built. (The para-



Fig. 1

bold arch from which Le Corbusier proposed to suspend the roof of a large assembly hall of the Centrosojus in Moscow is an example of such construction.)

Future architectural design will partly be determined by methods in which various metals can be cast, formed, and stamped, or combined with

plywood, plastic, glass and other materials. The roomettes of the American Pullman car, and the British "Villa Churchill"—the fabricated all metal house—are just a foretaste of what the converted war industries may offer.

If steel extends our buildings and cities vertically, concrete extends them horizontally. Like steel, reinforced concrete lends itself to large scale spans and cantilevers. One usually thinks of three outstanding examples of reinforced concrete constructions: industrial buildings, bridges by Maillard, and the hangars, notably the one of Orly, France. The simple geometric forms of American silos and industrial buildings inspired some European architects to a new esthetic theory called purism. Le Corbusier, one of the creators of purism in architecture, called the prisms and cylinders of American silos the masterpieces of the twentieth century. "These structures," he wrote in his "Toward a New Architecture" (Published in 1922) "were created by engineers whose minds and building methods are free from academic conventions." In reality, many of the simple industrial buildings of the last century were the "unknown pioneers" of modern architecture.

Cantilevered construction, made possible by the use of steel in concrete, was soon accepted for its structural and esthetic advantages. A classic example is Le Corbusier's dormitory for Swiss students at the University of Paris, where a three-story structure cantilevers over its concrete supports.

This should, however, not be explained for esthetic reasons only; the "elevated" building is a small-scale documentary of the "Ville Radieuse,"



Fig. 2

his city planning theory. Fig. 2. In residential architecture of this country, one thinks of the Kauffman house by Frank Lloyd Wright, where the cantilevered balconies and platforms integrate the indoor-outdoor living spaces.

A new vocabulary of forms may be developed by taking advantage of the fact that concrete construction is a monolith. A thin, fireproof monolithic shell of a house may be poured or sprayed onto any shape; its thin walls may be either solid slabs or slabs combined with glass blocks to form translucent shells. The Army, for example, de-

veloped an interesting standard of a monolithic shell sprayed by a concrete gun into an inflated, balloon-like form, with windows and ventilation "sprayed in." We may perhaps refer to this baroque style of reinforced concrete, though the style developed from structural properties rather than like a sculpture (Einstein Tower by Mendelsohn).

A great use of reinforced concrete should be in the forthcoming urban redevelopment; it should be made obligatory that in larger communities the dwelling and office structures be fireproof. Concrete floors and stairs, with steel, plastic, or glass partitions may be the answer. And, of course, one cannot omit mentioning the tremendous use of concrete in the present and future Dnieprostroys and Grand Coulee Dams that are helping to transform steam power into the noiseless and smokeless electrical power.

Glass is one of the oldest and at the same time one of the most modern of man-made building materials. In ancient times glass was produced in small pieces and cherished as a precious stone. In the Middle Ages, glass was manufactured in slightly larger sizes, stained and exposed to the passage of light to form the light-paintings of Gothic windows. The first large-scale use of glass and mirrors was made in the Palace of Versailles, and a really gigantic use of glass was demonstrated in the walls and roofs of the Crystal Palace of London.

Today glass is one of the most important factors of architectural planning, and there is a great variety of glass products. There are sheets of glass which let through only certain sun rays; sheets that insulate from heat, sound, and cold without forming the usual fogginess through condensation; glass that reduces glare and is unbreakable, and even strong enough to form structural members. There are shatter-resistant sheets of glass to which hardware may be soldered; these sheets do not need wood or metal frames. Glass blocks of various sizes and colors are another material at the architect's command.

Polarized glass, thus far, has seldom been used in residential work. Glass fibre is successfully used for heat insulation. The Army, for instance, used a quilt-like waterproof shell in its arctic shelters; these light weight structures saved tons of freight, fuel, and transportation in the early days of the war. In peace time, this war experience should be a welcome lesson for the fabrication of light-weight portable houses, especially since some of them may be delivered by air.

The fourth of our building materials is stone. From ancient times, stone has symbolized per-

manency. Practically all monumental buildings built through the ages are of stone. Today, however, massive stone walls may become unnecessary because a steel or concrete skeleton is a better, safer, and quicker way of building. Today stone is used mainly as veneer to protect the outside of buildings. However, the time may come when in the search for more daylight, stone veneer will be replaced by transparent or translucent panels. Then the facades will have the appearance of huge mirrors reflecting the sky and the park of which they will be a part.

It is interesting to note the connection between the "stone facades" and the "academic orders." There are still some architects—and they are mostly official ones—who think in terms of stone facades, center lines, etc. To them the "facade" is a slip-cover tailored over a skeleton of an otherwise contemporary building. Fig. 3.

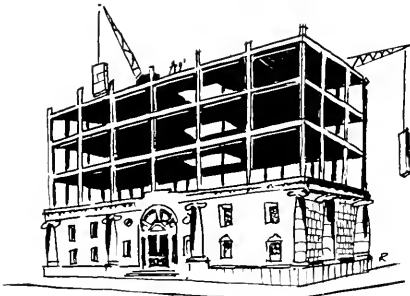

Fig. 3

Perhaps one should not judge them too harshly, for the Greek architects did the same thing and influenced the world for almost two thousand years.

The architectural vocabulary of a Greek Temple was devised from wood construction; centuries later, when stone made the temples fireproof, the original wooden appearance was transferred into stone, and it was a "hit." It may be that our contemporary "appeasers" are designing monumental slip-covers, in the hope that their work will one day become a "hit." (The new Administration Building, University of California, just to mention one example.)

Solid walls of stone will retain their use in country homes where they form a natural link between the building and its site. Both of Mr. Wright's Taliesins offer perfect examples of the use of stone in relation to the site. Into this category one should list other fireproof materials, such as brick and abode.

Wood, the earth's greatest natural renewable raw material, is perhaps the oldest of building materials. It is inexpensive, easy to work with, and easy to care for. It has a warm appearance

desirable for exterior and interior walls, as well as for furniture.

The present scarcity of metals advanced research in wood preservation and construction. For instance, a way of fixing the moisture content of wood, and at the same time a way of protecting the wooden surface with a metallic or plastic skin, has been devised.

Advantage of this has been taken by the war industries, and undoubtedly it will play an important role in the future. With the development of metal connectors and impregnable glues, small pieces of wood can be used to form trusses to span large areas and thus replace steel needed for new ships or guns.

The modern byproduct of wood—plywood—which can be made water-proof and fire-resistant, has diversified uses. Aside from its obvious use in prefabricated houses and furniture, we see its application in various war equipment. The airplane industries, for instance, have developed various processes whereby plywood is molded in hot steam or cooked together with frames to form a rigid fuselage.

We have heard of various wood alloys, where several layers of wood have been impregnated and compressed to form a hard substance which can be polished like stone. All these war time inventions will contribute to the development of peace-time architecture.

The youngest of our building materials are the plastics. They have immensely diversified uses. They can be poured or moulded in practically any shape and color, thus making ideal material for standardized mass production. Up to now, plastics have been used for a variety of smaller objects, though there are thermoplastic barges moulded out of one sheet, now used by the Navy.

One also should mention the recently developed plastic foam, which weighs less than rock wool, glass fiber, or cork, and has a low heat conductivity. It should be an excellent heat insulator in peace time homes.

If in the future plastic panels can be produced at low cost, the building and furniture industries will profit accordingly. While the appearance of a masonry house is essentially based upon the geometry of the right angle, with horizontal and vertical lines expressing the girders and posts, the appearance of a plastic house may differ considerably.

The shell of a molded house may look more like an airplane fuselage or a car body; its fire-proof and insulated roof and wall sections may be solid, translucent or transparent. In the plastic house, we may be dealing with luminous walls and roofs, rather than with windows in today's sense.

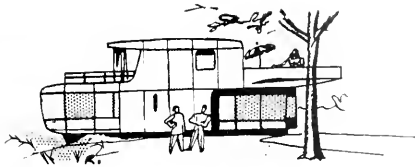

Fig. 4

After outlining our building materials and some of their uses, the question arises: "How can we make the best use of them for the benefit of the most people?" As it is now, only about one-third of the nation can afford a custom-built house.

If we wish to think beyond this one-third—the two-thirds of the population who live in city or rural slums or semi-slums—our efforts should be channeled toward:

(1) A new city plan designed for healthy living and working. This plan must supercede the outmoded street and block gridiron based upon commercial exploitation of land, which did not allow sufficiently for parks and recreational areas.

(2) Building industries must be mechanized; buildings must be fabricated and assembled by sections rather than built brick by brick. This is the only way that the cost of building can go down.

There are several ways of working toward a better city plan. One effective way, it seems to me, would be the voice of the people. The vast portion of the population which now lives in slums or semi-slums should demand that cities be rebuilt. The people through their representatives should ask for a legislature that would foster the planning of quiet and smokeless neighborhoods, with parks and playgrounds. But no matter how necessary the rebuilding of some cities may be, it could hardly be realized without the full support of civic groups, labor unions, consumers' cooperatives, newspapers, radios, magazines, universities, and above all, the revitalized building industries.

"The house cleaning" of our cities would hardly come from people who live comfortably out of town, or from architects who make handsome incomes designing custom-built residences, but from socially-minded planners working with the people. I do not know of a universally acceptable recipe for a painless rebuilding of slums; it will vary between Neutra's Channel Heights War Housing project and Le Corbusier's Ville Radieuse. In its essence, however, a planned community represents a balance between housing, work, recreation, and transportation.

In a planned community the houses (and apartment houses) are properly oriented toward the sun, view, and to each other. A well kept common park, containing recreational facilities, is at a walking distance from each dwelling. In the old days almost every community had its common park—the commons for public gatherings and games.

As the communities grew in population, the buildings encroached upon the commons, and soon nothing was left but a "cafe" with a juke box, glaring light, and cigar smoke.

We have lost contact with nature; most of the city population has to travel to see "Nature" on Sundays and holidays.

The present street, which often is a canyon of noisy traffic, must be segregated into (a) walks for pedestrians planned in a park-like manner through the city grounds and separated from (b) the net of highways for speedy traffic (in larger cities, if possible, elevated some 20 feet above the common park), and (c) streetcar, bus, and truck-lines, either below the elevated highways or underground.

Properly sized and spaced parkings for surface and air traffic would eliminate the traffic congestions. Traffic will cease to be a public menace, and yet be within reach of each dwelling and office.

Schools and nurseries, combined with medical and first aid stations, should be located in the common park of each residential district. Even in the poorest district (should there still be some in the economy of abundance) the children should not "play" on the streets.

What a good school means to children, a well directed Community Center could mean to the adults.

The Community Center, together with shopping center, administration building, restaurants, auditorium, hotels, library, should be located in the center of each neighborhood unit, and form a local "down-town."

It should be accessible both by pedestrian walks and by traffic roadways.

The industrial zone should be separated from other zones by parks, but still within walking distance. Electricity can make the industries and the cities smokeless.

Community planning was welcomed in Russia, Austria, Germany, and Scandinavian countries. There is a great deal of interest in organized planning in today's England; it is most interesting to follow the architectural battles over the future of some English cities—London, in particular.

In the United States a great many new communities were built around the war industries. While many of these communities are temporary and far from beautiful, their basic planning idea is sound, and should be taken over by private and public funds after the war. When building materials and funds will be again available organized planning should have preference over any other "planning."

For our larger cities the answer is possibly this: Instead of building more satellite communities around them, let us establish and enforce by law a new land-use-legislation which could justly estimate the land value within the cities. This is particularly necessary for cities where the downtowns are encircled by blighted areas.

This is where the human and financial waste is unchecked! Juvenile delinquency—poverty—disease make up the architectural style! And yet, underground, there are often perfectly good and serviceable utilities which could become a welcomed starting point for renovation of these districts.

The crowded slum buildings should be replaced by reasonably tall, fireproof apartment houses spaced in a common park. I am well aware of the tremendous technical, financial, legal, and administrative difficulties involved in such undertaking, but I am also aware of the social and financial

benefits that may be shared by the inhabitants as well as the owners of such projects

What the post-war architect-planner needs is not only technical and artistic ability, but an overall picture of a social order, and to know what part he is supposed to take in it.

It is not up to the architect to formulate social, economic, and political ideas of a region, any more than it is up to an economist to formulate a city planning layout. However, an architect-planner should be familiar with the work of his contemporary economist, sociologist, social worker, etc.

One of the reasons that some of our war housing projects were not fully successful was that they were designed by architects who lived and designed in and for a different social stratum!

Let me repeat that only a relatively small proportion of the population can afford the services of an architect, the rest—the majority—is left to the "services" of a speculative developer, or become a more or less permanent resident of slums.

This is the time for the architect to realize that his work could be a real contribution to a better world. He should enlighten people—from the worker to the banker—for unless the majority of people asks for better housing, we can hardly expect socialized architecture.

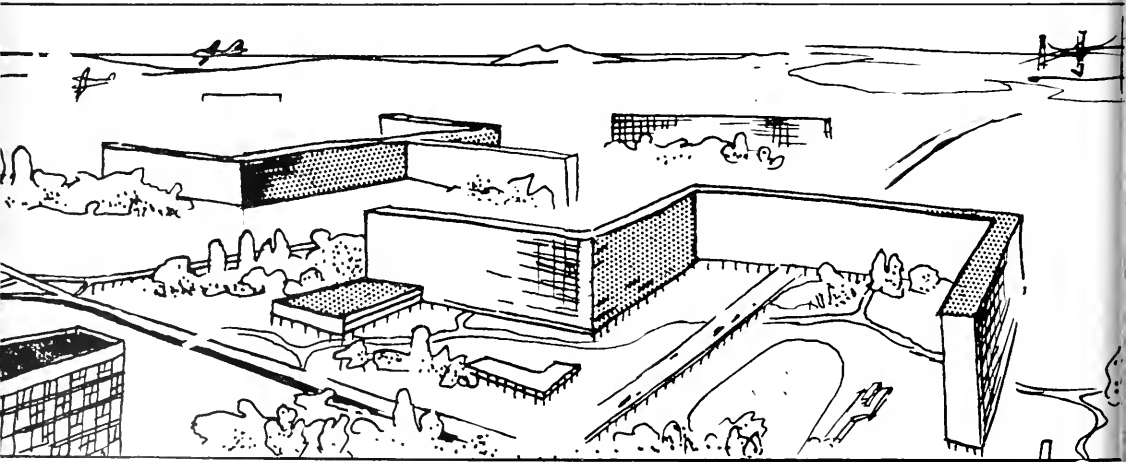

Fig. 5

*
*
*

*The Closing Date
for the*

* **ARCHITECTS' COMPETITION**

SPONSORED BY COLOTYLE CORPORATION
IS OFFICIALLY EXTENDED TO MIDNIGHT

* *March 10, 1945* *

THIS TIME EXTENSION WAS PUT INTO EFFECT TO *
ENABLE THE MANY WHO REQUESTED AN EXTEN- *
SION AN OPPORTUNITY TO COMPETE. IF YOU *
ARE AMONG THOSE WHO DID NOT ENTER BE- *
CAUSE THE PREVIOUS TIME LIMIT CONFLICTED *
WITH PREVIOUS COMMITMENTS, IT IS SUGGESTED *
THAT YOU WRITE IMMEDIATELY FOR DATA AND *
YOUR ENTRY NUMBER. THE PROBLEM, DESIGNING *
A BATHROOM WITH COLOTYLE WALLS FOR A *
MODERATELY PRICED HOME, IS AN INTRIGUING *
ONE, AND GIVES YOU AN EXTENSIVE RANGE FOR *
YOUR IDEAS. THE REWARDS, \$1500.00 IN CASH, *
ARE GREAT, CONSIDERING THAT THE COMPETI- *
TION IS LIMITED TO ARCHITECTS AND DRAUGHTS- *
MEN IN THE WEST. MATERIAL WILL BE SENT TO *
YOU PROMPTLY. *

*This competition, A.I.A. authorized,
is under the supervision of Rob't. McClelland, A.I.A.* *

COLOTYLE CORPORATION

The West's Largest Manufacturer of Prefinished Wallboards

700 MERCER STREET • SEATTLE 9, WASHINGTON

STAINED GLASS

(From Page 23)

level of appreciation and discrimination throughout our country.

To conclude the whole matter, stained glass windows are areas of translucent wall and should be so treated. As we consider correct stained glass design, we find that all-over composition is of foremost importance. Truly stained glass is the handmaid of architecture, and can justify herself only through loyal service to her mistress. Realism in stained glass is both bad manners and bad art. But the principles of stained glass adhered to, produce a power of expression, a glorious eloquence of appeal, a dynamic symphony of vibrant color in light capable of the richest ornamentation and of infinite inspiration.

Cover Illustration And Detailed Illustration Of Glasses Shown

This month's cover design is a reproduction of a portion of the Great Window of the United States Navy Chapel on Treasure Island in San Francisco Bay. Done by the Cummings Studios, San Francisco, all work in the designing and production of stained glass windows is directed by Harold W. Cummings, President of the Stained Glass Association of America.

A great many well known, and some famous, creations in stained glass have been produced by Mr. Cummings. Among these are Windows of the Saint Ignatius Church; United States Army Chapel at the Presidio; Fifth Church of Christ, Scientist, San Francisco; First Congregational Church in Oakland; Chapel for the Infirm in the Saint Joseph's Catholic Cathedral in San Diego; Gold Star Memorial Chapel in the Iowa State Sollege, and the Community Church at Honolulu, T. H.

Mr. Cummings has spent many years and great thought on the elusive art of stained glass and his article in this issue is most enlightening.

United States Navy Chapel on Treasure Island in San Francisco Bay

The text of this window, "He Maketh the Storm a Calm," is expressed by the full figure of Our Lord standing upon the water. The white of His garment symbolizes His purity; and the ruby of His outer-garment symbolizes His love. His dominion is expressed by the sun, the moon, and the stars. Flanking the symbolical water at the feet of Our Lord are decorative fish, ancient symbols of Christianity. In the base of the window is the insignia of the United States Navy, for whom the window was made.

The St. Ives Window in St. Ignatius Church, University of San Francisco, San Francisco

This is one of a series of eighteen companion windows. St. Ives, patron saint of Christian advocates or lawyers, is clad in the medieval pelisse together with the barret cap which as official garb of the law still survives in some continental countries. The color of his gown is naturally a rich purple, a combination of the symbolic colors of red for charity or love, and blue for wisdom, the resulting virtue of which is justice. At the feet of St. Ives are a pair of balances and a sword, the balances being the particular emblem of justice, and the sword the symbol of truth.

The Great Rose Window in the Chapel of the College of the Pacific, Stockton, California

The climactic central medallion of the Great Rose Window contains the Cross, the Crown of Thorns, and the Crown of Jewels. Surrounding it are six quatrefoils, telling successively the allegorical story of the Life of Christ. At the bottom of the window, in the six o'clock position, is the dove symbolic of the Descent of the Holy Spirit, or the Annunciation. In the eight o'clock position, the Star of Bethlehem symbolizes the birth of Jesus. In the ten o'clock position, the Open Book or Word of God symbolizes His ministry. In the twelve o'clock position, the Son of Righteousness, or the greatest earthly recognition of the Master. In the two o'clock position, is the Communion Cup, symbolic of the Lord's Last Supper. In the four o'clock position, the Crown of Thorns, telling of the Crucifixion.

This Great Rose Window is one of the entire stained glass window program in the Chapel at the College of the Pacific.

The Great North Rose Window, St. Cecilia's Catholic Church, Los Angeles

The Great North Rose in the Sanctuary of St. Cecilia's Church is highly individual in its predominantly ruby coloring, with striking contrasts in blues, golds, greens, etc., making the ensemble powerful in its appeal. It is fitting that it is so, for the central medallion shows the Hand of God superimposed upon the cruciform, symbolic of Omnipotence. Around this central thought circle two rows of petals or cusps, enriched with tracery. The eight cusps of the inner circle alternate in Old and New Testament symbols: the winged ox, man, eagle and lion of the four evangelists, alternating with Hebrew emblems of the Almighty, the Alpha, the All-seeing Eye, and the Omega.

Of the sixteen outer cusps, the top six and the lower six contain seated figures of the twelve apostles.

This Rose Window is one of several recently created for St. Cecilia's Church.

NEWS AND COMMENT ON ART

(From Page 9)

ture. The designs are on a bold scale, the colors appearing as patches and are kept from running into each other by means of raised thread outline, modelling in relief or varying in openwork. What is called the cloisonne style is very popular by the time of Ching T'ai (1450-1457 A.D.). This is the period when metal cloisonne wares were very popular, and the style of one may have influenced the style of the other. San ts'ai having a pottery base is called fa hua.

The soft glazes of the san ts'ai palette are also used separately to produce monochromes. Each single color varies greatly in shade, intensity, and texture, depending on whether it is applied over pottery, stoneware or porcelain as well as on many other factors. Many glazed pottery in the form of roof tiles, garden ornaments and temple figurines—are coated with glazes of the demi grand feu. From countless provincial kilns scattered all over China they are among the most vigorous Ming wares produced.

The polychromes one usually encounter outside the museums are of the an-glaze class—porcelain with white ground on which are painting in colored enamels. This is an inheritance from the Tzu Chou potters of the Sung dynasty, but by Ming time five colors are used: leaf green, turquoise, yellow, aubergine, a tomato red and a dull black. The last two are essentially pigments, so we call them pigmental enamels. The palette, called wu tsai (five colors) is supplemented by an underglaze blue. Guilding is used occasionally. The drawings are generally outlined in red or black.

During the Cheng Hua period a different kind of enamelled polychrome was made. The design was first outlined in underglaze blue and the colors were filled into areas outlined. The enamels are always pale and clear while the red is a vivid crimson. This type is known to Chinese collectors as tao ts'ai. The word tao has been translated as "fighting" or "clashing," but the term also means "filling in," and I believe the latter to be the correct meaning—the enamels were filled into areas outlined in blue. The enamels were also used single as monochromes, either directly on the biscuit or over a clear glaze.

Several provincial kilns gained such fame during the Ming dynasty they should be noted. In Te Hua, Chuan Chou district, Fukien province, a very warm white porcelain with a soft, lustrous, creamy-white glaze was produced. The white is of a creamy rather than a milky white—indicating the use of an oxidizing kiln—and the finest grade often has a pinkish tinge, known to adoring Chinese collectors as shrimp meat white. This

porcelain is known to the French as blanc de chine, to the Chinese as Te Hua porcelain. Te Hua (Virtue transformation) is a Buddhist metaphysical term and refers to the transforming power of virtue-in-practice. A great deal of the ware appeared to be inspired by religious zeal, the articles made being most of deities, immortals, libation cups, incense burners, etc. A large number of European porcelain figurines were inspired by such Te Hua deities as the Goddess of Mercy and bodhisattvas.

In Yi Hsing, west of the Great Lake in Kiangsu, the kilns produced pottery of many colors: cinnabar red, bronze brown, pearskin green, chestnut buff, stone grey, etc. The general run is a terra cotta red and they are typically unglazed. They are known to Europeans as buccaro. It is here that the Ou Chun was produced, a ware very similar to the Sung Chun except for its terra cotta pate. The Ma Chun, Ko and Kuan glazes were also reproduced here.

In the region near Fatshan in Kwangtung many interesting glazes of the Chun type were produced, and they have characteristics of their own: sealing wax red, mottled brown, brown and blue-grey striation, dappled grey and blue, sky blue, etc. A pale celadon glaze was also produced.

Several Sung types continued to be made. The Lung Ch'uan potters, having moved to Ch'u chow, now produced a glassy watery-green celadon. The Chun potters continued to produce their wares throughout this period. The Ting potters moved with the court southward at the time when China was invaded by the Mongols and set up kilns in several regions south of the Yantze River. Here they developed derivatives with new characteristics: brown Ting, Ting with crackles, Ting with underglaze blue, and others.

CELLULOSE PLASTICS

Illustrating the properties of the cellulose plastics a four-page folder printed in color has been issued by the Hercules Powder Company, Wilmington, Delaware.

The folder illustrates the tough, clear, flexible, lightweight, colorful, stable and economical characteristics of a selection of end products made from cellulose acetate, ethyl cellulose, and cellulose nitrate.

Many post-war uses are indicated for the cellulose plastics family.

Fred W. Crocker has also moved. He is now reached through the Kaiser Engineers, Kaiser Building, 1920 Broadway, Oakland, California.

Hyman Rosenthal has moved his offices to 617 Montgomery Street, San Francisco 11. He got a telephone with it, number SUtter 2768.

WINNERS OF \$10,000 W-G-N STUDIO DESIGN CONTEST

Winners of the \$10,000 W-G-N studio theater design contest for the most beautiful and efficient radio-television studio were announced February 3. The theater, seating 2,000 persons, will be the chief feature of a new building which will be known as "The W-G-N Chicago Theater of the Air" and will be constructed after the war just south of Tribune Tower. The contest for the theater's interior design was announced July 15, 1944. Entries received from competent architects and designers throughout the United States and from members of the armed forces were judged by Colonel Robert R. McCormick, president of W-G-N, Inc.; Frank P. Schreiber, station manager; and Henry Weber, W-G-N's director of music. John W. Park was professional adviser to the jury of awards.

The two winners of the \$5,000 first prize were Arthur Frederick Adams, 6510 North Glenwood Avenue, and William F. Clark, 5920 Kenmore Avenue, worked together on the winning design which consisted of four elaborate drawings showing the main floor plan, the balconies, the proscenium arch, and a perspective of the stage.

The two men are specialists in architectural design and mechanical engineering of theaters and public buildings. Mr. Adams received honorable mention in the contest for a design for Tribune Tower in 1922. Adams is a graduate of Columbia University, studied at Beaux Arts, New York and was the prize holder in 1910 to the Ecole des Beaux Arts, Paris.

Mr. Clark, a graduate of the University of Kentucky school of engineering, was associated with the Rapp firm for many years, with Graven and Mayer in Chicago, and with the State of New York.

Second prize of \$2,500 went to

Hyland Dinion and Irving H. Merritt of the firm of Dinion & Merritt, 627 West 115th Street, New York City. Dinion is a graduate of Yale University and Merritt of Syracuse university.

Third prize of \$1,000 went to Joseph T. Gemmi, 1666 Buena Vista Avenue, Decatur, Illinois. Gem-

mi is a graduate of the Carnegie Institute of Technology.

Among the 15 who received honorable mention awards of \$100 were two in California. They are Alexander Ban, 116 South Berendo Street, Los Angeles, and Frederick Hodgdon, 825 Plymouth Road, San Marino.



The tough resiliency of Brownskin waterproof paper overcomes stress and strain and it is moisture resisting. It S-T-R-E-T-C-H-E-S. No shrinking. No tearing.

STANDARD BROWNSKIN for sheathing assures protection from water or moisture. And its S-T-R-E-T-C-H-E-S keeps it intact for permanent protection.

For concrete curing and protection and for use as temporary partitions, a stock of reinforced waterproof papers is available.

BROWNSKIN VAPOR-SEAL provides absolute protection for insulation. It prevents condensation from forming in the insulation.

ECONOMY BROWNSKIN forms a permanent barrier against dust, dirt, moisture and vapor under finished floors, and also can be used as an economical sheathing and protective covering.



(Quality products since 1895)

ANGIER SALES CORPORATION

Framingham, Massachusetts

PACIFIC COAST OFFICE: 116 NEW MONTGOMERY STREET, SAN FRANCISCO 5, CALIFORNIA

DISTRIBUTORS

WESTERN ASBESTOS CO., SAN FRANCISCO
MASONS SUPPLY CO., PORTLAND
BUILDING SUPPLIES, INC., SPOKANE

WARREN & BAILEY CO., LOS ANGELES
LOCKWOOD WAREHOUSE CORP., SEATTLE
R. W. FRANK & CO., SALT LAKE CITY

THE PINE TREE

Although I think all trees sublime,
I now address the noble pine,
Whose soft, green cloak the winds caress
While cones play hide and seek with us.
You feed the squirrel, lodge the thrush
As graceful limbs you outward push.
With added years, your comely air
The more becomingly you wear.

And if, as very often happens,
Another work for you now opens,
And you are felled and later dressed,
Your life completely here expressed—
That is to say, life as a tree
To be admired by those who see—
In an entirely different form
You may yet gain the more esteem
If someone, who senses your solid worth,
Should use you as a structural beam.

Arrived at this now certain juncture
You may be used in Architecture;
If firmly placed and strongly held
You, as a timber, will not yield
Provided, of course, that you are not stressed
By greater burden than is expressed
In the now, quite general "Uniform Code"—
I refer to the "Safe Allowable Load."

—Angelo Hewetson.

WHEN THE BONDS START PAYING

—more and better homes will top the list of "wants" — homes with complete electrical facilities for every comfort and convenience.

The construction of each home must be planned accordingly with prime consideration for wiring adequate to meet all future demands.

There must be plenty of convenience outlets, switches and circuits, and the wiring must be of sufficient size to provide continuous, satisfactory service from a variety of appliances and from new lighting equipment.

The difference in cost between a first-class wiring job and an inadequate one is extremely small—but may measure the difference between satisfied and dissatisfied clients.

Insure the full measure of comfort and convenience for the postwar homes you plan by specifying completely Adequate Wiring.



NORTHERN CALIFORNIA
ELECTRICAL BUREAU
1355 Market Street
San Francisco



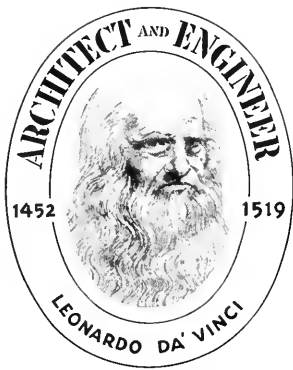

LEONARDO DA VINCI

Many of the adages that we have come to consider as axiomatic are doing more harm than good, particularly those that can be defined ad lib. The cliché, "a single track mind," has persuaded many a capable young man to monotony or even banality. As a youth he was probably taught that "a single track mind" was essential to success when what was meant was that singleness of purpose was what he should cultivate. We have too many "single track minds" now, most of whom are also bores.

We have no record of any great man who had less of a single track mind than Leonardo da Vinci, but he had the singleness of purpose of unearthing the truth about all things. In his youth he first took up music and then drawing and modeling. In his search for the fundamentals of these arts he was lead into other and wider channels. Painting, sculpture, architecture, mechanics, hydraulics, military and civil engineering all came into his life through search for the truth about all natural laws with which he had to deal.

The discovery of the capillary phenomena is accredited to Leonardo, which seems to be a far cry from the art that so many people think was his sole province. The same might be said of his brief writings on flying and his development of the theory of fossils or the designing of the six locks uniting the canals on Milan. Dr. Sidney Colvin, LL.D., in writing on Leonardo da Vinci, says "he was ardently feeling his way in the work of experimental study and observation in every branch of theoretical or applied science in which any beginning had been made in his age as well as some in which he himself was the first pioneer . . . His architectural and engineering projects were of a daring which amazed even the fellow-citizens of Alberti and Brunelleschi."

This brief item is not meant as biographical in

any sense, even biographical notes, but merely to show a few of the reasons why a journal for Architects and Engineers can reasonably use a famous portrait of a great man as a symbol of the work they should follow. For a work in detail, "The Romance of Leonardo da Vinci," by Dmitri Merejkowski will furnish many hours of delightful reading.

ED.

In the exhibit of Portrait Photography, which is being circulated by the Museum of Modern Art in New York, are such groups as those of Matthew B. Beady—portraits of Abraham Lincoln, Robert E. Lee, Ulysses S. Grant, Walt Whitman and Horace Greely; Edward Steichen—Portraits of Jose Iturbi, Charles Sheeler and Bernard Shaw; May Ray—Portraits of Constantin Brancusi, Marcel Duchamp and Jean Cocteau. There are about twenty photographers represented, all of whose work will present the last word in portrait photography.



GIVE NOW...KEEP RED CROSS AT HIS SIDE

RUSSIA RESUMES RECONSTRUCTION IN MOSCOW

Before the Russians got well into the present war twenty-five hundred town planning experts and as many architects were working energetically on the reconstruction of Moscow. They were working along at great speed, designing large apartment houses, erecting bridges and developing underground railways with palatial stations, but while the war did not stop this work entirely it diverted these architects and engineers to defense work and the work was materially slowed up. Finally to coordinate this work an architectural board was set up under a sub-committee of the Moscow Soviet and a general revision was begun.

The work is now divided into two parts, a general plan or long range plan, and a current plan. The general plan is particularized into detailed plans of districts, city blocks and squares and transportation. The offices working on the current plan are devoting their attention to designing groups of small dwelling houses and numer-

ous blocks on Khoroshevsky Chaussee and this year extensive plans will be completed in this and other outlying districts of Moscow. In the center of the city the University and the Moscow Soviet are being enlarged. The external ornamentation of the Moscow Soviet has been entrusted to chosen artists.

The designs for Gorky Street reconstruction are being developed by Mordvinov, who started that work before the war. This and the plan for the remodelling of Pushkin Square will set the keynote for the reconstruction of the entire of Moscow. The basic idea of these plans is to avoid the creation of fine facades with only mazes of unattractive byways and alleys behind them. Each square or artery is to form a center, but architecturally integral with the whole, embracing side streets, gardens, etc., to meet the actual conditions and needs of the district. The plans include monuments, gardens, parks and green squares. One of the major boulevards is being converted into a playground for children with a central fountain and pond ornamented with statuary illustrating the famous Russian fable of the fire bird.

(The brief outline came in to ARCHITECT AND ENGINEER by wire from Russia. When it is amplified further we will pass it on to our readers.—Ed.)





FLOOR FURNACES



FORCED AIR FURNACES

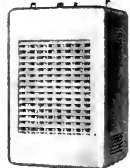

FORCED AIR UNIT HEATERS

You are invited to investigate the complete line of Utility evaporative air coolers, centrifugal blowers, propeller fans, floor furnaces, circulating heaters, unit heaters and forced air furnaces. Catalogs and illustrated literature will show you the outstanding features of these truly modern appliances.

Utility coolers, blowers and fans are now available under WPB regulations and priorities. Heating equipment will be available when war restrictions are lifted to permit manufacture.

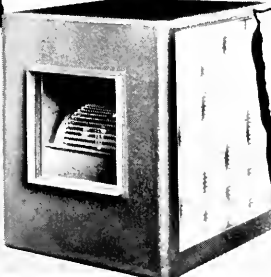

EVAPORATIVE AIR COOLERS



DUAL OUTLET FLOOR FURNACES



UTILITY Appliance Corp.

Formerly Utility Fan Corporation

4851 S. ALAMEDA STREET • LOS ANGELES 11, CALIFORNIA

IN THE NEWS

APPOINTED TO NEW WORK ART COMMISSION

Otto R. Eggers, F.A.I.A., whose surpassing renderings in pen and ink have fascinated all of us for decades, has been appointed for a three year term to the New York Municipal Art Commission by Mayor La Guardia. It is really a small reward for an artist and architect of such international fame. The firm of Eggers and Higgins have designed many of the most noteworthy structures on the east coast.

SAMUEL E. LUNDEN and LOUISE C. DICKERSON have been awarded the first prize of \$1,000 for their design for a community health center by the Modern Hospital Publishing Company who sponsored the competition.

THE SAN FRANCISCO ARCHITECTURAL CLUB will continue to hold its monthly meetings at the Builders' Exchange, 666 Market Street, on the first Wednesday of each month.

STEEL HOUSES

Dr. J. B. Austin, assistant director of the United States Steel Corporation's Research Laboratory in Kearny, New Jersey, predicts that the advances in so-called "powder metallurgy" offers a golden opportunity for fabricating houses and housing units. He says "The mechanical problem of prefabrication does not offer insurmountable difficulties, since a house is essentially far less intricate than an automobile."

THE COLUMBIA SCHOOL OF ARCHITECTS

Proposes to offer a sort of refresher course for those who have graduated from a recognized school of architecture, but were taken into the armed forces before they had had a chance to practice or work at their chosen profession. A similar refresher course, explains Dean Arnaud, will be opened for those whose practice was interrupted by the war and who have become rusty in the practice of the profession.

MYRON HUNT and H. C. CHAMBERS, Fellows of the American Institute of Architects, have moved from their offices at 816 West Fifth Street in Los Angeles to 677 I. W. Hellman Building at 124 West Fourth Street in the same city.

Perfection IN A SMALL "PACKAGE"

Now PAYNE introduces the successor to old-fashioned central heating:

ZONE-CONDITIONING

Gas heating and ventilating, controlled by zones or rooms. For large or small houses.

Write today for new booklet

Mere size does not determine a home's capacity to give pleasure and comfort to the owner. Witness this "gem" of a house, designed by architects *W. J. Varner* and *Herbert Mann* and built by *Noland Morris* ... for Mrs. Louise Bergman, Los Angeles. ★ Its heating system equals, in quality and performance, that of any mansion: a compact PAYNE

Forced Air Unit, one of many models for every heating need.



PAYNEHEAT
30 YEARS OF LEADERSHIP

GAS FUEL
HAS
EVERYTHING

Payne FURNACE & SUPPLY CO., INC.
Beverly Hills, California

© 1946 PAYNE FURNACE & SUPPLY CO., INC.

ADVOCATES ACCELERATED DEPRECIATION

The Associated General Contractors of America is pounding away at their plan for accelerated depreciation which would permit the owner of a building built after the war to depreciate one-half of its cost in the first quarter of its life. In other words, if the building cost \$100,000 with a life expectancy of 40 years, \$50,000 would be written off in depreciation during the first 10 years. It seems to be an excellent plan, one that would encourage building of commercial and industrial structures very materially.

JAMES G. DAY, Architect, has moved from Patterson, California, to 1513 Park Street, Alameda.

C. M. BLOODGOOD, who has been serving as sales manager of the Pacific Coast Division of Air Reduction, is appointed assistant to the vice-president in charge of sales.

PRESIDENT SAN FRANCISCO ART COMMISSION

At a meeting of the Art Commission of the City and County of San Francisco, held at the City Hall January 17, 1945, MARK DANIELS was unanimously elected as president of that body. SPENCER MACKY was elected vice-president.

HUNTERS POINT DEVELOPMENT

A great deal of money has been spent by the government to bring the Hunters Point Naval Drydocks to the point desired by the Navy Department. For additional facilities a further sum of \$78,175,000 is contemplated by a bill which has been passed by Congress only and which is to be spent for additional facilities only. Apparently the department does not intend to stop until the Hunters Point Naval Drydocks suit them, for which all are thankful.

FRANK L. HOPE, JR., A.I.A., has moved his offices from 1008 San Diego Trust & Savings Building, San Diego, California, to 935 Bank of America Building in the same city.

PROFIT-PENSION PLAN FOR EMPLOYEES

A retirement pension plan and a profit-sharing plan for employees has been placed in operation by the Utility Appliance Corporation of Los Angeles.

Ben B. Brestlow, president, revealed details of the two plans, cost of which will be borne entirely by the company. A pension trust provides for fixed benefits upon retirement, and life insurance protection for the worker. A profit-sharing trust provides for benefits which depend on the future prosperity of the company.

The firm has nearly 500 employees, most of whom will be immediately eligible.

ARMSTRONG'S QUAKER WALL COVERING

A new low-cost product of the Armstrong Paper Company is a durable, flexible, yet inexpensive wall covering manufactured on a lightweight, fresh-fiber felt backing with an easy to clean enamel finish.

Quaker Wall Covering is applicable for bathrooms, kitchens, laundries and commercial establishments such as restaurants and food shops, requiring low-cost walls safe from dirt, grease, smoke, and water.

TERMITE LOSSES EQUAL U. S. FIRE LOSSES

Estimated at \$300,000,000 each year, the loss to building owners of the United States through damage by subterranean termites and dry rot is about equal to the fire loss which was \$303,895,000 in 1941 according to the latest figures published by Statistical Abstract of the United States. Much of the fire loss, however, was covered by insurance while property owners were unprotected against the ravages of infestation.

Through the Termitrol Patent, a new invention just patented by the Hollywood Termitrol Company, Inc., of Los Angeles, it is possible to safeguard the investment of builders for a small percentage of the total cost of the structure.

The purpose is to use pressure-treated lumber at those points in the structure most vulnerable to attack and at the same time place this lumber in such strategic positions that any infestation that might occur in other parts will be isolated and confined to a small area that can be replaced with a minimum of labor and cost. Any approved pressure treated lumber can be used provided it is treated with 8#, #1 A.W.P.A. creosote or approved equal.

"It is impractical to use pressure treated lumber throughout the framing of an entire structure," said Gunn, company president, "as the cost would be prohibitive. However, we have perfected this method of affording maximum protection against subterranean termite, dry wood termite, and dry rot attack so every new building can use it economically. Private loan agencies as well as the F. H. A. have accepted the Termitrol Patent as an additional cost that is completely justified because it will enhance property values and safeguard investments."

The patent is the result of 10 years study by Gunn, a civil engineer and well-known figure in the Pest Control Field and a member of the Board of Directors of the National Pest Control Association.

**IT COSTS NO MORE
TO GIVE YOUR CLIENT**

the best ...

NEXT TIME SPECIFY

Pennvernon Glass

it's
FLATTER
... CLEARER
... BRICHTER ...

PENNVERNON
flat drawn
WINDOW GLASS

Distributed by ...

W · P · FULLER & CO.
PAINTS • GLASS • WALLPAPER



QUALITY AND DEPENDABLE
Service

are the factors that influence architects and contractors when selecting lumber and mill work — Quality of merchandise — Integrity and Ability of the firm — Service in physical equipment — Experience and Personnel — All these factors contribute to a speedy and satisfactory completion of construction with minimum of time and expense.

MANUFACTURER OR DEALER IN

Douglas Fir — Redwood — Sugar and Ponderosa Pine — Plywood and Concrete Form Panels — Sash and Doors — Millwork — Insulation — Builders' Hardware.

E. K. WOOD LUMBER CO.

"Goods of the Woods" ©
LOS ANGELES • SAN FRANCISCO • OAKLAND

IN THE NEWS

COLOTYLE SPONSORING CONTEST

The Colotyle Corporation, of Seattle, is sponsoring a competition in bathroom design, under the supervision of Robert McClelland, A.I.A. professional advisor. Only western architects and draughtsmen are eligible to submit designs which must use Colotyle Plastic-Coated walls. Judges will be four members of the American Institute of Architects from the four districts of San Francisco, Los Angeles, Seattle and Portland, and one architectural editor. Total awards of \$1,500 will be made.

The action of Colotyle Corporation in thus encouraging architects in designing a section of a house has met with hearty approval of the profession, not only for generous action of the Colotyle Corporation but because it encourages designers to work on this most important detail of a house. The Colotyle Corporation plans to build the winning design.

ARCHITECT C. A. CAULKINS has opened offices in the Rosenberg Building, Santa Rosa, after serving three years in the Navy. He is already busy on a number of post-war projects, including the large Mendocino Hospital job. He appreciates receiving building material catalogues and bulletins.

FUEL SAVING INFORMATION

Manufacturers who wish to get maximum efficiency with mineral wool insulation will be interested in new thirty page booklet based on more than two years of research and study and recently promulgated by the Bureau of Standards.

It tells how to apply mineral wool in blocks, blankets, insulating cement and pipe insulation for all types of heated industrial equipment.

A free copy of Commercial Standard CS 117-44 may be secured by writing to Industrial Mineral Wool Institute, 441 Lexington Avenue, New York 17, N. Y.

TIM PFLUEGER is working on the plans of the new department store of the I. Magnin & Co. at the corner of Geary and Stockton Streets, which most people interested have known for some time, but which was announced only recently. The building is being planned in structural steel and reinforced concrete, fully air conditioned, with white marble and black granite exterior.

IN THE NEWS

The California Palace of the Legion of Honor

Lincoln Park,

San Francisco, California

Office of the Director

February 2, 1945.

Mr. Mark Daniels,
Editor,

Architect and Engineer,
San Francisco 4, California.

Dear Mr. Daniels:

May I take this opportunity to congratulate you on the re-designing of "Architect and Engineer"? The placing of the very fine photographs and the new set-up of the articles have made the magazine much more pleasing in appearance. The changing of the cover has likewise made it a much more attractive piece of goods.

Sincerely your,

JERMAYNE MacAGY,

Director.

MERGER OF BAY AREA STEEL FIRMS

Judson-Pacific Company, one of San Francisco's pioneer steel fabricators, has merged with the J. Philip Murphy Corporation under the name of the Judson-Pacific-Murphy Corporation, with plants in San Francisco and Oakland. Paul F. Gillespie, C. E., who has been with the Judson Company for many years, becomes president of the new corporation, with Carlos J. Maas, vice president, and J. Philip Murphy, vice president and general manager. A. E. Wilkens, formerly general manager of the Judson-Pacific Company, retires from active management.

CLAY TILES FOR FLOORS AND WALLS. Printed copies of Simplified Practice Recommendation R61—44 are now available from the Superintendent of Documents, Government Printing Office for 10 cents each. It now includes wall tile trimmers, flat quarry tiles, quarry tile trimmers and quarry tile colors. No change is made in the sizes of glazed wall tiles, but in ceramic mosaic there are a number of additional sizes and shapes listed.

BUY U. S. WAR BONDS AND HOLD THEM!

QUANTITY Limited

War production still limits our output of commercial

and industrial lighting equipment. We're sorry we

can't make enough fixtures to meet present demands,

but we're glad we've stuck to the principle of limiting

quantity rather than quality. Every SMOOT-HOLMAN

fixture, whether made before, during, or after the war,

will always carry our label of quality.

QUALITY Unlimited



Offices in Principal Western Cities — Branch and Warehouse in San Francisco

PRODUCERS' COUNCIL PAGE

Northern California Chapter

The National Organization of Manufacturers of Quality Building Materials and Equipment
Affiliated with the AMERICAN INSTITUTE OF ARCHITECTS



L. F. "FRANK" BAKER

includes the Program Committee.

Many talents and varied training has been brought to the Chapter by members, but Frank is the first we have uncovered with law training. Born in Wichita, Kansas, he went through high school there, moved to Omaha and attended the University of Nebraska. Came to California in 1924, and went straight to W. P. Fuller & Co., where he started in the Los Angeles plant. Frank's trail lead from shipping clerk to floor salesman to outside salesman in various capacities and territories until in January, 1944, he was made Manager of the Paint Department, San Francisco District.

In addition to the Council, Frank is a member of the Engineers' Club and the Builders Exchange. Frank is proud to mention a wife and two sons, 9 and 13, and for hobbies he enjoys golf most.

We are very sorry to announce the death of Frank O'Connor, of the E. L. Bruce Co., Inc. Frank died suddenly, November 29, while on a business trip to his Memphis office.

Frank was one of our newer members who quickly got the Council spirit and enjoyed his Council friendships. This news will come as a shock to all to whom the information has not already been conveyed.

We are doubly grieved as we go to press to learn of the death of Allen Turner of the Masonite Corp. Allen died January 9, after a short illness.

Kindly Allen was one of our members of long standing and we will miss him.

Quiet Frank Baker describes his voice and not the absence of motion. Although W. P. Fuller & Co.'s alternate member in the Chapter, Frank has been the active member since as far back as most members recall. His attendance is regular and his service

Here They Are, new officers for 1945: President, George B. Quamby, Detroit Steel Products Corp.; Vice-President, E. E. Cathcart, Johns-Manville Sales Corp.; Secretary C. J. Nicholas, Crane Co.; Treasurer, E. S. Banta, H. H. Robertson Co.

Off In High Gear, George came to the Annual Meeting with his Committee assignments in his pocket.

Program: Chairman, Ed Cathcart, Johns-Manville Sales Corp.; E. P. Larson, Celotex Corp.; F. A. Mangan, General Electric Co.

Membership & Attendance: Chairman, Ward C. Schafer, Pacific Gas and Electric Co.; Art Skaille and Herb Galez, Westinghouse Electric Elevator Co.; Lou Saylor, Vermont Marble Co.

Fellowship: Chairman, "Scho" Schofeld, Libbey-Owens-Ford Glass Co.; Chet Cook, H. H. Robertson Co.; Frank Nugent, Certain-teed Products Corp.

Public Relations & Technical Information: Chairman, Chuck Kraft, Kraftite Co.; Ray Brown, Gladding, McBean & Co.; Ken Pinney, Armstrong Cork Co.

Building Industry Conference Board: Representative, Ken Pinney, Armstrong Cork Co.; Alternate, Bob Teller, Western Asbestos Co.

San Francisco Planning & Housing Association: Citizens Master plan Committee Representative is C. E. Berry, Mueller Brass Co.

No President of the Chapter ever took over better qualified in experience than George Quamby, after holding down the fort for Horace Pickett last year as Vice-President and later as Acting President, when Horace was unable to resume. Pitchforked into the job, George handled it nicely.



PRESIDENT GEORGE QUAMBY

(See Page 41)

USE QUALITY PRODUCTS



CONSULT AN ARCHITECT

BOOK REVIEWS

COACHING ROADS OF OLD NEW ENGLAND. Their Inns, Taverns, and Their Stories. By George Francis Marlowe. The MacMillan Company. \$3.50.

Confining himself to no particular period, the author, Mr. Marlowe, an architect, carries us back over the history following 5 of the principal routes of earlier days of New England.

He gives us glimpses of the life of the towns, villages on the way, of the old houses and odd characters. In no way, perhaps, can one know New England better than by traveling some of her old coaching roads, which to us would have seemed all but impossible now, and to our ancestors not devoid of hardships and sometimes actual danger.

The author, Mr. George Francis Marlowe, is not only an architect but an artist and writer and belongs to various historical societies. In this book he takes us by means of local story through the old towns of Middlesex to Jaffrey and north following the Groton Road. In addition, he provides sketches, in the best traditional manner, of the charming farming country of Massachusetts, then into the high region of lower New Hampshire and upper Connecticut Valley. The Upper Post Road takes us via Springfield, while the Lower goes through Newport through old Lyme and the historic towns along the shore of Long Island Sound. I only wished there was a map included in the set of illustrations. Pardon, I found one on the back fly-leaf with the roads radiating from Boston. A list of references attached is standing proof to the amount of research and authenticity of the yarns, jokes and spicy anecdotal comment on the "politicks" of the time in and out of the country.

—Review by Michael Goodman.

METALS & ALLOYS DICTIONARY. By M. Merlus-Sobel, Ph.D. Chemical Publishing Co., Inc., Brooklyn, N. Y. \$4.50.

Of course, a dictionary is a dictionary and, at first glance, a review seems to be a bit tautological. But in the case of this dictionary the matter is quite different. That such a book is an essential to men working in the higher branches of metallurgy is quite obvious, as is the need of it to almost any man studying or writing about metals. But there is another group who also need it, the editors. There are many words that have one meaning in conversational English which have quite another meaning in connection with metals and alloys. If you should run across the word

(See page 42)

(From Page 40)

And to Horace, who had a promising illustration nipped in the bud, best wishes for a speedy recovery.

A Tough Year this has been on Council members. Another casualty is Ed Cathcart, who owes his recovery to PENICILLIN. Ed will heartily approve the use of capital letters here after his bout with a serious infection. He is convalescing nicely now.

Now that he's President, George will have to do without a Vice-President for awhile! Hurry back Ed!

A Bouquet was tossed to the Producers Council, Inc., by Industrial Publications, Inc., on the position of leadership it has assumed in the building industry on broad questions that affect all building material manufacturers alike.



BAKCO

CHROMATED ZINC CHLORIDE

GLC

PRESSURE TREATED LUMBER
● **PROTECTS AGAINST DECAY AND TERMITE ATTACK**

Specify it in your home
Available through Lumber Dealers

LOS ANGELES	SAN FRANCISCO
601 W. 5th Street	333 Montgomery Street
Phone Michigan 6294	Phone DOugles 3883

J. H. Baxter & Co.

AGENTS FOR WEST COAST WOOD PRESERVING CO. SEATTLE, WASH.

BOOK REVIEWS (Continued)

"Radionite" you would have a hard time finding out what it might mean in an ordinary Webster's. The same is true of "Cladding" and "Spangle", and hundreds of other words. Most dictionaries are erroneously considered as dull reading, but you will find this particularly untrue in the Metals and Alloys Dictionary of Dr. Merlus-Sobel. If you doubt it, just buy a copy and look up "Spangle", for instance, or "Radianite".

—M.D.

IN THE NEWS

WESTERN ASPHALT ASSOCIATION ELECTION

Adoption of the slogan, "keep war planes flying" and re-election of incumbent officers and directors for 1945 marked proceedings of the annual meeting of the Western Asphalt Association held recently in Los Angeles.

Officers included J. R. Keane, president; J. R. Pemberton and R. M. Blodget, vice-presidents; C. W. Powell, treasurer, and Frank L. Mark, managing engineer. Directors, re-elected, are S. M. Griffith, A. F. Brough, Keane and Powell of Los Angeles, and G. R. Daley of San Diego.

In his address to the meeting, President Keane said California has ample asphaltic surfacing materials to provide floors for airports on Pacific islands wherever Allied landings are made, and to build landing strips and highways throughout the southwest in the post-war era.

MR. S. HEIMAN, after serving two years and ten months as a major in the U. S. Army Engineer Corps, is opening his office for the resumption of architectural practice at 605 Market Street, San Francisco. He is now on the inactive list and would like to receive catalogues and other literature.

HERCULES ISSUES NEW BOOKLET

A new booklet listing Hercules chemicals, industrial explosives, and approximately fifty industries which they serve, has been issued by Hercules Powder Company.

An indication of many post-war applications for chemicals in plastics, paints, textiles, film, adhesives, and paper is given by the booklet.

Chemicals in the cellulose family, rosin and modifications, rosin esters and synthetic esters, terpene solvents and chemicals, explosive, blasting supplies and sporting powders, and special products are discussed in the booklet.

CLINTON CONSTRUCTION CO. OF CALIFORNIA

General Contractors

923 FOLSOM STREET • SAN FRANCISCO

SUffer 3440

MALOTT & PETERSON

ROOFING AND FLOORING CONTRACTORS

20TH AND HARRISON STREETS

SAN FRANCISCO

Phone ATwater 1600

HOGAN LUMBER CO.

Wholesale and Retail

LUMBER

MILL WORK • SASH & DOORS

Office, Mill, Yard and Docks

SECOND AND ALICE STREETS • OAKLAND, CALIF.

Telephone GLencourt 6861

SANTA MARIA INN

SANTA MARIA, CALIFORNIA

FRANK J. McCOY, General Manager

FERNAND E. PIMENTEL, Manager

On the
Coast
Highway
between
San
Francisco
and
Los
Angeles



American
or
European
Plan
•
Old
English
Tap
Room

ARCHITECT AND ENGINEER

Estimator's Guide

Giving Cost of Building Materials, Etc.

AMOUNTS GIVEN ARE FIGURING PRICES AND ARE MADE UP FROM AVERAGE QUOTATIONS FURNISHED BY MATERIAL HOUSES TO SAN FRANCISCO CONTRACTORS. 2 1/2% SALES TAX ON ALL MATERIALS BUT NOT LABOR

All prices and wages quoted are for San Francisco and the Bay District. There may be slight fluctuation of prices in the interior and southern part of the state. Freight cartage, at least, must be added in figuring country work.

BONDS—Performance—50% of contract.
Labor and materials—50% of contract.

BRICKWORK—

Common Brick—Per 1M laid—\$50.00 to \$60.00 (according to class of work).
Face Brick—Per 1M laid—\$120 to \$150 (according to class of work).
Brick Steps—\$1.60 per lin. ft.
Brick Veneer on Frame Bldg.—Approx. \$1.30 per sq. ft.
Common Brick—\$19.00 per M, truckload lots, f.o.b. job.
\$19.00 per M, less than truckload, plus cartage.
Face Brick—\$40 to \$80 per M, truckload lots, delivered.
Cartage—Approx. \$4.00 per M.

BUILDING PAPER—

1 ply per 1000 ft. roll.....	\$3.50
2 ply per 1000 ft. roll.....	5.00
3 ply per 1000 ft. roll.....	6.25
Brownskin, Standard, 500 ft. roll.....	5.00
Sisalcraft, 500 ft. roll.....	5.00
Sash cord com. No. 7.....	\$1.20 per 100 ft.
Sash cord com. No. 8.....	1.20 per 100 ft.
Sash cord spot No. 7.....	1.90 per 100 ft.
Sash cord spot No. 8.....	2.25 per 100 ft.
Sash weights, cast iron, \$50.00 ton.	
Nails, \$3.42 base.	
Sash weights, \$45.00 per ton.	

CONCRETE AGGREGATES—

The following prices net to Contractors unless otherwise shown.

Gravel, all sizes—		
\$1.95 per ton at Bunker; delivered	\$2.50	
	Bunker	Del'd
Top Sand	\$1.90	\$2.50
Concrete Mix	1.90	2.45
Crushed Rock, 1/4" to 3/4".....	1.90	2.50

Crushed Rock, 3/4" to 1 1/2"	1.90	2.50
Roofing Gravel	2.25	2.80
River Sand	2.00	2.45

Sand—

River Sand	2.00	2.45
Lapis (Nos. 2 & 4)	2.85	3.15
Olympia (Nos. 1 & 2)	2.85	3.10
Del Monte White	84c per sack	

Cement—

Common (all brands, paper sacks), carload lots, \$2.42 per bbl. f.o.b. cart; delivered \$2.72
Cash discount on carload lots, 10c a bbl., 10th Prox.; less than carload lots \$3.20 per bbl. f.o.b. warehouse or delivered.
Cash discount 2% on L.C.L.

Atlas White	1 to 100 sacks, \$2.50 sack
Calaveras White	warehouse or del.; \$7.65
Medusa White	bbl. carload lots.

Forms, Labors average \$200.00 per M.
Average cost of concrete in place, exclusive of forms, 35c per cu. ft.; \$10 cu. yd.; with forms, 60c.
4-inch concrete basement floor30c per sq. ft.
Rat-proofing7 1/2c
Concrete Steps.....\$1.25 per lin. ft.

DAMP-PROOFING and Waterproofing—

Two-coat work, \$3.50 per square.
Membrane waterproofing—4 layers of saturated felt, \$7.00 per square.
Hot coating work, \$2.50 per square.
Medusa Waterproofing, \$3.50 per lb. San Francisco Warehouse.
Tricel waterproofing.
{See representative.}

ELECTRIC WIRING—\$12 to \$15 per outlet

for conduit work (including switches).
Knob and tube average \$3.00 per outlet.
{Available only for priority work.}

ELEVATORS—

Prices vary according to capacity, speed and type. Consult elevator companies.
Average cost of installing a slow speed automatic passenger elevator in small four story apartment building, including entrance doors, about \$6500.00.

EXCAVATION—

Sand, 60 cents; clay or shale \$1 per yard.
Teams, \$12.00 per day.

Trucks, \$22 to \$27.50 per day.

Above figures are an average without water. Steam shovel work in large quantities, less; hard material, such as rock, will run considerably more.

FIRE ESCAPES—

Ten-foot galvanized iron balcony, with stairs, \$150 installed on new buildings; \$160 on old buildings.

FLOORS—

Composition Floor, such as Magnesite, 33c to 50c per square.
Linoflor—2 gages—\$1.25 to \$2.75 per sq. yd.
Mastapay—90c to \$1.50 per sq. yd.
Battleship Linoleum—available to Army and Navy only—1/8"—\$1.75 sq. yd.
3/8"—\$2.00 sq. yd.
Terrazo Floors—50c to 70c per square.
Terrazo Steps—\$1.75 per lin. ft.
Mastic Wear Coat—according to type—20c to 35c.

Hardwood Flooring—

Standard Mill grades not available.
Victory Oak—T & G
1 1/2" x 2 1/4".....\$143.25 per M, plus Cartage
1/2" x 2".....122.00 per M, plus Cartage
1/2" x 1 1/4".....113.50 per M, plus Cartage
Refinished Standard & Better Oak Flooring
1 1/2" x 3/4".....\$180.00 per M, plus Cartage
1/2" x 2 1/4".....160.50 per M, plus Cartage
Maple Flooring
1 1/2" T & G Clear \$160.50 per M, plus Ctg.
2nd 153.50 per M, plus Ctg.
3rd 131.25 per M, plus Ctg.
Floor Layers' Wage, \$1.50 per hr.

GLASS—

Single Strength Window Glass	20c per	□	ft
Double Strength Window Glass	30c per	□	ft.
Plate Glass, under 75 sq. ft.....	\$1.00 per	□	ft.
Polished Wire Plate Glass	1.40 per	□	ft.
Rgh. Wire Glass34 per	□	ft.
Obscure Glass27 per	□	ft.
Glazing of above is additional.			
Glass Blocks	\$2.50 per	□	ft. set in place

HEATING—

Average, \$1.90 per sq. ft. of radiation, according to conditions.
Warm air (gravity) average \$48 per register.
Forced air, average \$68 per register.

IRON—Cost of ornamental iron cast iron, etc., depends on design.

LUMBER—All lumber at O.P.A. ceiling prices—

No. 1 Common	\$49.00 per M
No. 2 Common	47.75 per M
Select O. P. Common	52.75 per M

Flooring—

V.G. D.F. 8 & 8tr. 1 x 4 T & G Flooring	Delvd.	\$80.00
C 1 x 4 T & G Flooring		75.00
D 1 x 4 T & G Flooring		65.00
D.F.-S.G. 8 & 8tr. 1 x 4 T & G Flooring		61.00
C 1 x 4 T & G Flooring		59.00
D 1 x 4 T & G Flooring		54.00
Rwd. Plastic—"A" grade, medium dry		82.00
"B" grade, medium dry		78.50

Plywood—

	Under \$200	Over \$200
"Plyscord"—3/8"	\$49.50	\$47.55
"Flywall"—1/4"	45.15	43.30
3 ply—2/s—1/4"	48.55	46.60
"Flyform"—5/8"—		
Unoiled	126.50	121.45
Oiled	127.90	122.75

Above prices delivered if quantity is sufficient to warrant delivery.

Shingles (Rwd. not available)—
 Red Cedar No. 1—\$6.75 per square; No. 2, \$5.75; No. 3, \$4.45
 Average cost to lay shingles, \$3.00 per square.
 Cedar Shakes—Tapered: 1/2" to 3/4" x 25"—\$8.95 per square.
 Resawn: 3/4" to 1 1/4" x 25"—\$10.65 per square.
 Resawn: 3/4" to 1 1/4" x 25"—\$10.65 per square.
 Average cost to lay shakes, \$4.00 per square.

MILLWORK—Standard.

O. P. \$100 per 1000. R. W. rustic \$100.00 per 1000 (delivered).
 Double hung box window frames, average with trim \$6.50 and up, each.
 Complete door unit, \$10.00.
 Screen doors, \$3.50 each.
 Patent screen windows, 25c a sq. ft.
 Cases for kitchen pantries seven ft. high, per lineal ft., \$9.00 each.
 Dining room cases, \$9.00 per lineal foot.
 Rough and finish about 80c per sq. ft.
 Labor—Rough carpentry, warehouse heavy framing (average), \$40.00 per M.
 For smaller work average, \$40.00 to \$55.00 per 1000.

MARBLE—See Dealers)

PAINTING—

Two-coat work	per yard	50c
Three-coat work	per yard	70c
Cold water painting	per yard	10c
Whitewashing	per yard	8c

PAINTS—

Two-coat work 50c per sq. yd.
 Three-coat work 70c per sq. yd.
 Cold water painting.....per yard 10c
 Whitewashing 8c per sq. yd.
 Turpentine \$1.03 per gal. in drum lots.
 \$1.08 per gal. in 5-gal. containers.
 Raw Linseed Oil—not available.

Boiled Linseed Oil—\$1.38 per gal. in drums. Available only to work with high priority—\$1.48 per gal. in 5-gal. containers.
 Use replacement oil—\$1.86 per gal. in 1-gal. containers.
 Replacement Oil—\$1.20 per gal. in drums. \$1.30 per gal. in 5-gal. containers.
 A deposit of \$6.00 required on all drums.

PATENT CHIMNEYS—

6-inch	\$1.20 lineal foot
8-inch	1.40 lineal foot
10-inch	2.15 lineal foot
12-inch	2.75 lineal foot

PLASTER—

Neat wall, per ton delivered in S. F. in paper bags, \$17.60.

PLASTERING (Interior)—

3 Coats, metal lath and plaster	Yard	1.50
Keene cement on metal lath		1.80
Ceilings with 3/4 hot roll channels metal lath (lathed only)		1.20
Ceilings with 3/4 hot roll channels metal lath plastered		2.20
Single partition 3/4 channel lath 1 side (lath only)		1.20
Single partition 3/4 channel lath 2 inches thick plastered		3.20
4-inch double partition 3/4 channel lath 2 sides (lath only)		2.20
4-inch double partition 3/4 channel lath 2 sides plastered		3.85
Thermax single partition; 1" channels; 2 1/4" overall partition width. Plastered both sides		3.30
Thermax double partition; 1" channels; 4 3/4" overall partition width. Plastered both sides		4.40
3 coats over 1" Thermax nailed to one side wood studs or joists		1.65
3 coats over 1" Thermax suspended to one side wood studs with spring sound isolation clip		1.90

Note—Channel lath controlled by limitation orders.

PLASTERING (Exterior)—

2 coats cement finish, brick or concrete wall	Yard	\$1.00
3 coats cement finish, No. 18 gauge wire mesh		2.00
Lime—\$3.00 per bbl. at yard.		
Processed Lime—\$3.10 bbl. at yard.		
Rock or Grip Lath—3/8"—20c per sq. yd.		
5/8"—19c per sq. yd.		

Composition Stucco—\$1.80 to \$2.00 sq. yard (applied).

PLUMBING—

From \$100.00 per fixture up, according to grade, quantity and runs.

ROOFING—

"Standard" tar and gravel, 4 ply—\$8.00 per sq. for 30 sqs. or over.
 Less than 30 sqs. \$9.50 per sq.
 Tile, \$30.00 to \$40.00 per square.
 Redwood Shingles, \$7.50 per square in place.
 5/2 #1-16" Cedar Shingles, 4 1/2" Exposure \$8.00 square

5/8 x 16"—#1 Cedar Shingles, 5" Exposure \$9.00 square
 4/2 #1-24" Royal Shingles, 7 1/2" Exposure \$9.50 square
 Re-coat with Gravel \$4.00 per sq.
 Asbestos Shingles, \$23 to \$28 per sq. laid.
 1/2 x 25" Resawn Cedar Shakes, 10" Exposure \$10.50
 3/4 x 25" Resawn Cedar Shakes, 10" Exposure 11.50
 1 x 25" Resawn Cedar Shakes, 10" Exposure 12.50
 Above prices re for shakes in place.

SHEET METAL—

Windows—Metal, \$1.75 a sq. ft.
 Fire doors (average), including hardware \$2.00 per sq. ft.

SKYLIGHTS—(not glazed)

Copper, 90c sq. ft. (flat).
 Galvanized iron, 40c sq. ft. (flat).
 Vented hip skylights 60c sq. ft.

STEEL—STRUCTURAL (None available except for defense work).

\$150 ton (erected), this quotation is an average for comparatively small quantities. Light truss work higher. Plain beams and column work in large quantities \$140 per ton.

STEEL REINFORCING (None available except for war work).

\$150 to \$200 ton, set.

STONE—

Granite, average, \$6.50 cu. foot in place.
 Sandstone, average Blue, \$4.00. Boise, \$3.00 sq. ft. in place.
 Indiana Limestone, \$2.80 per sq. ft. in place.

STORE FRONTS (None available).

TILE—

Ceramic Tile Floors—70c to \$1.00 per sq. ft.
 Cove Base—\$1.10 per lin. ft.
 Glazed Tile Wainscot—\$1.25 per sq. ft.
 Asphalt Tile Floor 1/8" & 3/8"—\$.18 to \$.35 per sq. ft. Light shades slightly higher.
 Cork Tile—\$.40 to \$.75 per sq. ft.
 Mosaic Floors—see dealers.
 Lino-Tile, \$.35 to \$.75 per sq. ft.

Wall Tile—

Glazed Terra Cotta Wall Units (single faced) laid in place—approximate prices:
 2 x 6 x 12 \$1.10 sq. ft.
 4 x 6 x 12 1.25 sq. ft.
 2 x 8 x 16 1.20 sq. ft.
 4 x 8 x 16 1.40 sq. ft.

VENETIAN BLINDS—

40c per square foot and up. Installation extra.

WINDOWS—STEEL—

30c per square foot, \$5 for ventilators.

IN THE NEWS

DAVID D. BOHANNON, first vice president of the National Association of Home Builders, stated, in his opinion of policies to be fol-

N. CLARK AND SONS

Manufacturers of

Quality
Architectural
Clay Products

During this stage of the war, our principal energy is to manufacture products required by the various war agencies. We still can supply some pre-war materials for civilian needs.



401 PACIFIC AVENUE
ALAMEDA, CALIFORNIA

San Francisco • Los Angeles
Salt Lake City • Portland

lowed out in 1945, "We must have no illusions concerning the coming showdown between private enterprise and public housing. As a democracy, this nation is rapidly approaching the time when the American people are going to have to choose between the philosophies of freedom of enterprise and government-guided socialism. The tremendous post-war housing requirements of our country have placed us home builders in a position of strategic importance that I do not think we, as individuals, as yet fully realize."

WILLIAM A. EDWARDS has moved from 114 East de la Guerra Street, Santa Barbara, to 2311 Santa Barbara Street in the same city.

PAUL J. VAN TREES has moved from 560 South Main Street, Los Angeles, to 626 North Berendo Street in the same city.

JOHN BOLLES, architect, and MAURICE SANDS, interior designer, spoke at the third session of the Home Planning Institute in the Little Theatre of the Palo Alto High School last month. Mr. Bolles spoke on Functional Planning and Mr. Sands on Furnishing and Color.

Read building blueprints



quickly
accurately

Here is a book to give men in the building trades an intensive training in blueprint reading. Covers the building trades as a whole and is organized on the self-instruction, question - and - answer plan.

Just Out!

BLUEPRINT READING for the BUILDING TRADES

By Joseph E. Kenney

Architect; Instructor in Drafting,
South Boston High School

100 pages, 8 1/2 x 11, \$2.00

This book explains what blueprints are, their importance, how the architect prepares working drawings, who uses them, and how to go about learning to read them. It shows the meaning and use of the various symbols and conventions and how they fit into the working drawings for an entire building.

ORDER A COPY FROM
ARCHITECT AND ENGINEER
68 Post Street, San Francisco, 4

J. S. GOULD, Kohl Building, San Francisco, is very busy on plans for post-war building in Colusa County.

1945 BUILDING TRADES WAGE SCALES (JOB SITES) NORTHERN CALIFORNIA

Six- and seven-hour day eliminated on all Government Work. A. F. L. - O. P. M. Agreement calls for eight-hour day.

NOTE: Predeterminations by the Department of Labor, as of July 1, 1944 (the wage-freezing date) have not yet been made in all of the counties listed. The wage scales shown are those being paid and in effect mostly by agreement between employers and their union.

CRAFT	San Francisco	Alameda and Contra Costa	--es--	Marin	Sacramento	San Jose	San Mateo	Vallejo	Stockton
ASBESTOS WORKERS	1.50	1.25	1.50	1.50	1.50	1.25	1.50	1.25	
BRICKLAYERS	1.87 1/2	1.87 1/2	1.75	1.87 1/2	1.75	2.00	1.79-1/6	1.75	1.50
BRICKLAYERS, HODCARRIERS	1.40	1.40	1.05	1.40	1.05	1.50	1.35	1.50	1.14
CARPENTERS	1.50	1.50	1.25	1.43 3/4	1.37 1/2	1.37 1/2	1.43 3/4	1.50	1.37 1/2
CEMENT FINISHERS	1.50	1.50	1.50	1.50	1.50	1.50	1.50	1.50	1.50
ELECTRICIANS	1.70	1.70	1.70	1.70	1.70	1.70	1.70	1.70	1.70
ELEVATOR CONSTRUCTORS	1.75 1/2	1.75 1/2	1.75 1/2	1.75 1/2	1.75 1/2	1.75 1/2	1.75 1/2	1.75 1/2	1.75 1/2
ENGINEERS; MATERIAL HOIST	1.50	1.25	1.25	1.50	1.62 1/2	1.62 1/2	1.50	1.37 1/2	1.75
PILE DRIVER	1.75	1.75	1.60	1.75	1.75	1.75	1.75	1.75	
STRUCTURAL STEEL	1.75	1.60	1.60	1.75	1.75	1.75	1.75	1.75	1.60
GLASS WORKERS	1.40	1.12 1/2	1.40	1.12 1/2	1.40	1.40	1.40	1.40	
IRONWORKERS; ORNAMENTAL	1.60	1.50	1.60	1.50	1.60	1.31 1/4	1.50	1.50	
REINF. RODMEN	1.50	1.50	1.60	1.50	1.50	1.60	1.50	1.50	1.25
STRUCTURAL	1.75	1.75	1.75	1.75	1.75	1.75	1.75	1.75	1.37 1/2
LABORERS; BUILDING	1.00	1.00	.90	.87 1/2	.95	.90	.93 3/4	.90	.90
CONCRETE	1.00	1.00	.90	.87 1/2	.95	.90	.93 3/4	.95	1.00
LATHERS	1.75	1.75	1.50	1.75	1.60	1.75	1.75	1.75	1.75
MARBLE SETTERS	1.50	1.50	1.50	1.50	1.50	1.50	1.50	1.50	1.50
MOSAIC & TERRAZZO	1.25	1.75	1.12 1/2	1.25	1.15-5/8	1.17 1/2			
PAINTERS	1.50	1.50	1.28-4/7	1.50	1.43	1.50	1.42-6/7	1.64-2/7	1.37 1/2
PAINTERS	1.54	1.54	1.54	1.54	1.54	1.54	1.54	1.54	1.54
PILEDRIVERS	1.75	1.75	1.75	1.75	1.75	2.00	2.00	2.00	1.83-1/3
PLASTERERS	1.50	1.60	1.40	1.50	1.18 1/2	1.50	1.75	1.50	1.50
PLASTERERS' HODCARRIERS	1.50	1.60	1.40	1.50	1.18 1/2	1.50	1.75	1.50	1.50
PLUMBERS	1.70	1.70	1.53-1/8	1.70	1.68 3/4	1.62 1/2	1.70	1.70	1.50
ROOFERS	1.50	1.50	1.25	1.37 1/2	1.37 1/2	1.37 1/2	1.25	1.37 1/2	1.37 1/2
SHEET METAL WORKERS	1.50	1.50	1.50	1.50	1.50	1.50	1.50	1.50	1.50
SPRINKLER FITTERS	1.58	1.58	1.53-1/8	1.70	1.68 3/4	1.62 1/2	1.70	1.70	1.50
STEAMFITTERS	1.75	1.75	1.53-1/8	1.70	1.68 3/4	1.62 1/2	1.50	1.70	1.50
STONESETTERS (MASON)	1.87 1/2	1.87 1/2	1.50	1.75	1.75	1.50	1.75	1.75	1.50
TILOSETTERS	1.50	1.50	1.37 1/2	1.50	1.37 1/2	1.50	1.50	1.50	1.37 1/2

Prepared and compiled by

CENTRAL CALIFORNIA CHAPTER, ASSOCIATED GENERAL CONTRACTORS OF AMERICA

with the assistance and cooperation of secretaries of General Contractors Associations and Builders Exchanges of Northern California.

G. P. W.
JENSEN & SON

—
Building Construction
—

320 Market Street, San Francisco
Phone: GARfield 2444

JOHN CASSARETTO
COMPANY

—Since 1886—And Still Active—

Building Materials

READY MIX CONCRETE
ROCK - SAND - GRAVEL - LIME
CEMENT - PLASTER - MORTAR
METAL LATH - WOOD LATH
STUCCO - WIRE NETTING

Service Unexcelled

Bunkers
Sixth and Channel, San Francisco
Phones: GARfield 3758 - 3760

THE TORMEY
COMPANY

GENERAL PAINTERS
AND DECORATORS

—
Phone UNderhill 1913
—

563 FULTON STREET
San Francisco

MULLEN MFG.
COMPANY

—
BANK, STORE AND OFFICE
FIXTURES—CABINET WORK
OF GUARANTEED QUALITY
CHURCH SEATING
—

Office and Factory:
60-80 RAUSCH ST., Bet. 7th and 8th Sts.
San Francisco
Telephone UNderhill 5815

IN THE NEWS

COMPETITION CLOSES MAY 14th, 1945, for the design of a memorial to Dr. Elmer A. Sperry. The Sperry Gyroscope Company and the Alumni Association of the American Academy in Rome are collaborating in the competition which is open to teams of not less than two, or more than four, in the arts of architecture, landscape architecture, painting and sculpture. One prize of \$1,000, one of \$200 and three of \$100 will be awarded. The programs may be had by application to the American Academy in Rome, 101 Park Avenue, New York 17, N. Y.

—
ALTON S. LEE has moved from 1423 Bay Street, Alameda, California, to 3006 Thompson Avenue in the same city.



**HERRICK
IRON WORKS**

STRUCTURAL STEEL
REINFORCING STEEL

18TH AND CAMPBELL STS.
OAKLAND, CALIF.
Phone GLencourt 1767

Phone GARfield 1164

Thomas B. Hunter

Consulting Engineer

DESIGNER OF HEATING
AIR CONDITIONING
VENTILATING AND WIRING
SYSTEMS, MECHANICAL
AND ELECTRICAL EQUIP.
MENT OF BUILDINGS

41 SUTTER STREET
ROOM 710

San Francisco

California

We Thank You...

To the many Architects and Engineers who have recommended our products and services to their clients, may we express our appreciation for past favors.

As an aid to future service, you will find a list of our commodities on the back page of the January number of Architect and Engineer. If you would like a copy printed on heavy stock to hang in your office for ready reference, just ask for a PIN UP. We'll see that you get it promptly.

Please consider us always
at your service.

GUNN, CARLE & CO.

20 Potrero Avenue
San Francisco 3
UN 5480

ANDERSON
&
RINGROSE

—
General Contractors
—

320 Market Street, San Francisco
Phone GARfield 2245

**DINWIDDIE
CONSTRUCTION
COMPANY**

•
BUILDERS
•

CROCKER BUILDING
SAN FRANCISCO

ARCHITECT AND ENGINEER

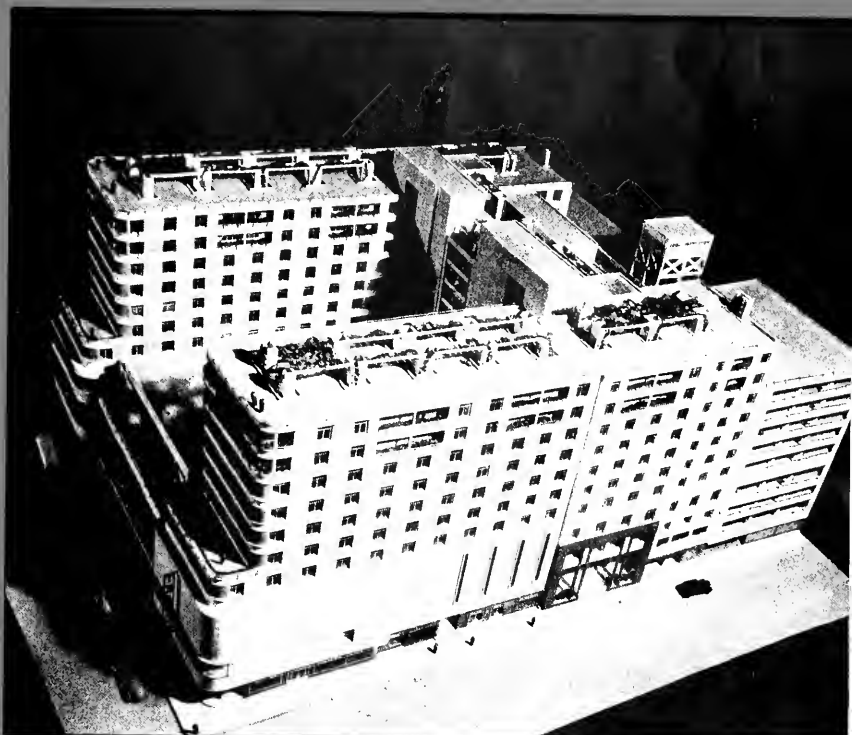

MARCH

1945



THE INDIANS KNEW HOW TO GET

FIGHTING MAD!

WHEN the Indians wanted to work up a "peeve", they called on the steady beat of war drums to drive the bucks fighting mad.

Today, it's the steady bombardment of hundreds of *little* noises that preys on nerves and ruins dispositions. In offices and factories, this irritating noise barrage produces fatigue, decreases efficiency, impairs hearing and creates emotional disturbances.

Practically the entire medical profession agrees that modern-day noise constitutes a grave menace to the physical and mental life of all office and factory workers.

Fortunately, something *can* be done to reduce

noise. That something is Sound Conditioning with Acousti-Celotex. This famous perforated fibre tile transforms noise into a gentle hush. It can be quickly applied to ceilings and other surfaces, and painted repeatedly without impairing its efficiency.

Western Asbestos Co. offers a complete Acousti-Celotex Sound Conditioning service . . . from design to completed installation. The counsel and recommendations of a sales engineer are at your service—without obligation.

WESTERN ASBESTOS CO.
Acoustical Engineers and Contractor

• ARCHITECT

Vol. 160

No. 3

AND ENGINEER

ARCHITECTS' REPORTS—Published Daily

MARK DANIELS
Editor

E. H. WILDER
Associate Editor

MICHAEL GOODMAN
Post-War Planning

L. H. NISHKIAN
Consulting Editor

E. N. KIERULFF*
Ass't Editor
*In the Service

Contents for



MARCH

COVER: Model of New Alameda Hotel, Mexico City

Page

ARTICLES AND MISCELLANEOUS TEXT

RUNNING FIRE	4
ERNEST KUMP SPEAKS FRANKLY	5
By ERNEST J. KUMP, A.I.A.	
CHINESE "BAROQUE" PORCELAIN	6
By CHINGWAH LEE	
WHAT MEXICO OFFERS THE ARCHITECT AND ENGINEER	10
By WM. ARTHUR NEWMAN, Architect	
HOTEL ALAMEDA AND OTHER MEXICO CITY PLATES AND PHOTOGRAPHS	10-11-12-13-14-15-16
WOOD MOSAIC	17
By J. FRANK PORTER	
WITH THE ENGINEERS	18
HAVE ARCHITECTURAL SCHOOLS MET THEIR RESPONSIBILITY?	19
By LIEUTENANT (J.G.) LAWRENCE A. BENENSEN, U.S.C.G.R.	
IN THE NEWS	21-22-27-29-30-38
TREES IN ARCHITECTURAL DRAWINGS	23
By MARK DANIELS, A.I.A.	
PUBLIC HOUSING, A FALLACY	25
By W. P. LAUFENBERG	
A. I. A. ACTIVITIES	37
PRODUCERS' COUNCIL PAGE	40
BOOK REVIEWS	41
ESTIMATOR'S GUIDE	43
INDEX TO ADVERTISERS	48



ARCHITECT AND ENGINEER (Established 1905) is published on the 15th of the month by The Architect and Engineer, Inc., 68 Post St., San Francisco. President, K. P. Kierulff; Vice-President and Manager, L. B. Penhorwood; Treasurer, E. N. Kierulff; Advertising Manager, V. E. Atkinson, Jr.

Los Angeles Office: 403 W. 8th Street.

Entered as second class matter, November 2, 1905, at the Post Office in San Francisco, California, under the Act of March 3, 1879. Subscriptions United States and Pan America, \$3.00 a year; \$5.00 two years; foreign countries \$5.00 a year; single copy 50c. ARCHITECTS' REPORTS are published daily from this office, Vernon S. Yallop, Manager.



RUNNING FIRE — by MARK DANIELS

A CHANGE OF SLOGAN

The government has now given us a new slogan, or perhaps only Congress has. It comes as a sort of relief, if it can be taken seriously. The slogan now is, WORK OR FIGHT. In days gone by it was WORK AND FIGHT. Work unceasingly AND fight for your right to keep what you have earned, to enjoy the freedom you have earned. Now it would appear that you can substitute fighting for working but I am inclined to think that OR should still remain AND, war or no war.

NOSTALGIA

Perhaps it is the war, but if the war sets the background, Kenneth C. Adams' third of his series of "CALIFORNIA MISSIONS" sent the floods of nostalgia racing through me. The sunlight that is everywhere in the illustrations is in the text as well and I, for one, am fired anew with the longing to follow this trail again.

KNOWLEDGE DEMANDS FREEDOM

So long as we are ignorant of the tribulations ahead of us we may remain contented. Many people contend that we should remain so and let it go at that on the old theory that "what we don't know, won't hurt us". But that, unfortunately or otherwise, is the old contention that "ignorance is bliss", which has been argued and debated in every organization from high schools up. Applied to every day life, as well as the practice of architecture, the inference is that so long as we do not know what is going on we will be satisfied with our lot.

For decades we have fought for a free press and the rights of private enterprise which are really a battle against the theory that "ignorance is bliss". Without free press and private enterprise there is little chance for the genius to get to the top, which often necessitates the freedom of movement that allows a man to change his occupation, which is not so easy in countries outside the United States. If we are not satisfied with the work we are doing we can get out and into another.

This is not meant in the same insolent way that some say, "if you don't like this country, why don't you get out," but in the sense that, in this country at least, we can change our occupation or enterprise without losing self respect. Each of us can do some one thing a little better than the next fellow, so why not shift about a little until we find it and not waste time envying the

success of one who has found himself? The opportunity to make such changes is one of the reasons for the long fight for freedom of press and private enterprise that we have fought so long for, the right to do our own work our own way and to say what we think as, for instance, in ARCHITECT AND ENGINEER and even in RUNNING FIRE, Q.E.D.

THE PRESS

For a while the Daily Press was replete with articles that opened with "It is rumored—", "From reliable sources we hear—", "It is reported that—" and similar indeterminate phrases, but of late the publishers have cut that sort of thing to a minimum. But, unfortunately, the trade and professional journals have begun the same sort of thing with a different slant. They take up an article purporting to be informative in a more or less technical way and fill it with such phrases as "It appears to be—", "I am inclined to recommend—", "May give strong support—", "Seems to belong—".

It is difficult to demonstrate the indefiniteness of an article that is filled with such expressions without giving actual examples, but "I am inclined to recommend" that their continued use "may give strong support" to the belief that they "seem to belong" where "I am inclined to recommend" they be kept (IN THE ASH CAN).

A RUSSIAN REQUIREMENT

For sweet ingeniousness, a condition handed to the Russian architects, as set forth in the cabled third Ostrovsky, has few equals in this country. After going to some length on the subject of the conditions that must be met by the architects in their monumental task of rebuilding the bomb-torn and ruined cities of Russia, cities and towns that have been utterly wrecked by the Germans, the instructions state that "Typical designs for houses must be BOTH BEAUTIFUL AND COMFORTABLE AND AT THE SAME TIME ECONOMICAL".

I would not be surprised if that requirement, BEAUTIFUL, COMFORTABLE AND ECONOMICAL, would have a familiar sound to architects in America even if it were spoken in Russian. Was there ever an architect who received a commission to design a house who was not told in several languages that it had to be BEAUTIFUL,

(See Page 29)

ERNEST KUMP SPEAKS FRANKLY

By ERNEST J. KUMP, A.I.A.

(An address given the Conference on Architectural Training and Practice at the University of Michigan, February 4, 1945.)

Being asked to discuss a subject so controversial in our profession brings to mind a story:

Once three professional men—a Doctor, a Lawyer and an Architect—were discussing the age of their respective professions. The Doctor said, "But of course, Gentlemen, my profession is the world's oldest. When Eve was made from the rib of Adam, that was surgery."

"That is undoubtedly true," said the Lawyer, "but, when the world began, order was created out of chaos, and that's law!"

"That's all very well," interrupted the Architect, "but who do you think created all the chaos—**why an Architect of course!**"

It seems there is still some order to be achieved out of chaos concerning the general understanding of the practice and scope of architecture.

In this respect we have certainly reached an interesting era in the design and planning of buildings. It is remarkable the number of cousins, and I say "cousins" advisedly, with different names the Architect has, all able to offer the same service.

At present, building programs are being planned and designed by architects, contractors, engineers, designers, consultants, draftsmen, and even complete building service companies.

The Building Service Company, by the way, offers all professional, creative and technical services, complete in a package—**as popularly advertised.**

Now, how about the public concerning this variety of "synonym-architects?" What is its attitude?

As far as I can discern, there is quite a separateness in thought concerning who is capable of doing what.

It seems to be a popular concept of late that the Engineer makes the structure comply with the building codes—the Contractor, "our respected cousin in overalls," well he is the practical man

who "delivers the goods" so to speak, and controls the cost—while the Architect, well he is the distinguished gentleman with the smock who gives the building a beauty treatment called design or something—and for an extravagant fee too!

In addition, it seems an Architect may be selected personally by the owner, if deemed necessary, or his services can be furnished by the Contractor or Engineer—at a slight additional cost, of course.

If there is agreement in the profession that this public concept exists to some degree, we should certainly be curious as to why. In fact, we should be downright interested.

For quite a while in the distant past there was little question as to the ability and position of the Architect or the Master Builder, as he was formerly known. If public confidence in the Architect has diminished, it can only represent an inherent flaw in his own services. It points to the fact that the Architect has neglected a part of his training and experience, which in relation to modern building practice is of the utmost importance.

This unfortunate situation can only be remedied by the Architect himself **but not by popular propaganda on the value of aesthetics.**

Unfortunately for our respected cousins, confidentially, I do not believe that they have suddenly been imbued with a stroke of creative genius and become architects under another name—as many of them sincerely believe.

Now, what are these achievements in efficient service offered by others than architects that is so impressive—so impressive, in fact, that the head of the family is being relegated to a minor role?

It, of course, is not in design or planning, for even the Contractor and Engineer will admit the trained Architect is the more imaginative. In fact, it is usually their ambition to retain that "distinguished gentleman in the smock" when they build their own home. It isn't entirely engineering,

(See Page 16)

NEWS AND COMMENT ON ARCHITECTURE

Chinese "Baroque" Porcelain

By CHINGWAH LEE

The Ch'ing dynasty (1644-1911 A.D.) was established by the Manchus who conquered Ming China and established their imperial throne in

Peking, but they proved such great devotees of Chinese civilization that internal China was practically unaffected so far as local government, the



CHINESE "BAROQUE" PORCELAIN—Left to Right: Blue and white bowl of Ch'ien Hung period; blue and white vase of the Kang Hsi period; and a famille juan mei ping (prunus blossom gallipot) of the Kang Hsi period. Illustration courtesy of the De Young Museum.

NEWS AND COMMENT ON ART

civil service system and the development of art and culture were concerned. Three wise and enlightened emperors, ruling under the reign titles of K'ang Hsi, Yung Cheng and Ch'ien Lung, together with three great superintendents of the royal kilns at Ching-te Chen, Ts'ang Ying-hsuan, Nien Hsi-yao and T'ang Ying resulted in a period of production the like of which the world has never seen. Besides the reproduction and refinement of Sung and Ming types the Ch'ing potters evolved many new creations of their own, bringing the porcelain art to the apex of technical excellency.

The best blue and white of the Ch'ing dynasty were made during the K'ang Hsi period (1664-1723 A.D.). By intensive refinement of the native blue they succeeded in developing a brilliant sapphire blue which is a worthy rival of Hsuen Te Mohammedan blue, and Chinese collectors honor this color by calling it K'ang Hsi lan or the blue of K'ang Hsi. The milk-white ground and the excellent potting also contribute to the merit of this blue and white. A very effective form of blue and white has blue ground with white design in reserve. Probably the best known example of this type is the famous "Blue Hawthorn Jar" whose ascending and descending branches of prunus (erroneously called "hawthorn" in the West) against a blue ground of cracked ice symbolize the approaching of spring. Both types are known as Ch'ing hua pai ti (blue design on white ground), but those with blue grounds are sometimes specifically designated as lan ti pai hua (blue ground with white design).

The blue is often combined with an underglaze red (yu-li hung), and the Chinese term for this is ch'ing hua tzu (blue design with brown). The word tzu (brown, purple, aubergine) is used because the red often takes on a brownish or peach bloom tinge, and in fact is known to most Western collectors as underglaze peachbloom.

Another modification of the blue and white is done by coating the white ground with a yellow enamel, resulting in a hwang ti ch'ing hua or blue design on a yellow ground. Or the process may be reversed, the white design, reversed on a blue ground, being covered with yellow enamel, resulting in a ch'ing ti hwang hua or blue ground with yellow design. Instead of yellow sometimes a green enamel is used.

The attention of the potters of the Yung Cheng period (1723-1735 A.D.) was focused on the reproduction of early Ming forms, and some excellent

specimens, worthy on their own merit, were produced. Throughout the early part of the Ch'ing dynasty excellent soft paste blue and white were made, those of the Yung Cheng period being excellently good. The design is pencilled in a very delicate manner, and the articles made are small in size, for the larger ones crack easily in the kiln. The glaze is very soft and crazes easily—a hard glaze is not used, for the ware will not stand too high a temperature. They are called hua shih ch'ing hua (slippy-smooth stoneware with blue design); sometimes ch'ing hua fen ting (rice colored Ting with blue design).

The san ts'ai or sur-biscuit porcelain of this period is highly refined and are quite different from their Ming predecessors. They resemble sur-biscuit monochromes with incised design except that two or more colors are present. The colors are now generally separated by delicate incised lines rather than raised threads or carving in openwork, and instead of rugged potting and bold decoration we have highly refined porcelain with dainty design. The reign mark in six characters is generally incised in the area within the foot-rim, although painted mark in aubergine is not unknown toward the end of the dynasty. Typical san ts'ai of the period are the plates and bowl with yellow ground and dragons in green and aubergine.

One type of sur-biscuit, called tiger skin (or "spinach and egg" by the early Dutch importers) is very popular during the K'ang Hsi period. It consists of splashes of yellow, aubergine and green applied "helter-skelter" over the entire surface. A large number of K'ang Hsi figurines and statuettes of birds and animals are decorated with colors of the demi-grand feu; they are distinguished from muffle kiln enamels by being slightly thicker and darker.

The Wu Ts'ai (five color) of the Ch'ing dynasty is known to the French connoisseurs as famille verte or the green family, because the green color predominates. There are now new shades of green, and a blue enamel is developed which to some extent replaced the underglaze blue. The red is now a vermilion-coral rather than a darkish tomato color. We may divide the famille verte into two main classes, the an-glaze and the sur-biscuit. The an-glaze class may again roughly be divided into two kinds, those which are typically K'ang Hsi and those which are essentially of the Ming style. The latter type makes full use of the underglaze blue and are again of two kinds, those with underglaze blue outlines on the de-

sign, imitating the tao ts'ai (filled-in colors) of the Ming dynasty and those with red or black outlines, imitating the wu ts'ai of the Ming dynasty.

It will always be hard to tell whether a good tao ts'ai is of Ming or Ch'ing origin. There are a few cups with chicken and plant design and a Ch'eng Hua mark which are generally attributed to the Ming by European connoisseurs, but there are similar specimens, having all the Ming characteristics, which have a Yung Cheng mark. As a rule the crimson red on a Ming tao ts'ai has a golden lustre lacking in the Yung Cheng ware. Also the Ming drawing was done in a freer style, and the blue not as carefully controlled.

It is much easier to identify a Ming we ts'ai. The makers of the Ming polychromes lavished more attention on the glazing than the potting, and we find many Ming wares with irregular foot-rims and slightly distorted bodies. Some have flat bottoms, in which case they are unglazed, smooth, and without the concentric wheel marks found in later productions. The Ming foot-rims are generally slovenly trimmed. "After having trimmed the edge with a knife the potter uses a thick wet brush to make the surface smooth and round off the sharp edges. This appears to be an innovation of the K'ang Hsi period and is one detail which forms a dividing line between the Ming and Ch'ing dynasties (A.D. Brankston in "Early Ming Wares of Ching-te Chen"). We may also say that Yung Cheng and Ch'ien Lung foot-rims have characteristics of their own.

It may be well to mention here that there is a large group of transitional polychromes which are labelled as "Either late Ming or early K'ang Hsi" because they share characteristics of both periods. Brave souls might label them "circa Shun Chih" and they would probably be closer than those who gave them a Ming or a K'ang attribution, for while few existing specimens have the Shun Chih reign mark possibly because the potters were still rebellious to an alien ruler—we cannot overlook the fact that porcelain was made during this reign of two decades, as witness the imposing orders sent from the capital in 1564 and later.

The K'ang Hsi potters probably carried on very much in the Ming tradition and did not develop a style of their own until about 1680 A.D., when the wise emperor, well aware of the potters' indifference to an alien rule, threatened to install

an imperial kiln at the capital on the one hand and installed an able superintendent at Ching-te Chen on the other hand (Ts'ang Ying-hsuan was superintendent from 1680 to 1723 A.D.). The strictly K'ang Hsi style which follows is very elaborate. They have brocaded ground of seed, floral scroll, diapers, circlets or other geometrical patterns, often strewn with butterflies, flowers, medallions, Buddhist or Taoist symbols, etc. The ground invariably has panel reserves for painting of figures or landscape. Gilding is used sparingly.

The famille verte decoration was often applied to colored ground, either directly on the self-colored glazes or, what is more often, on white reserves. Such high-fired glazes as celadon, mirror black, cafe-au-lait (resulting in what is called Batavian ware), precious stone red, powder blue, and even crackled stoneware were often so decorated.

The other major division of the famille verte are the sur-biscuits or so san ts'ai (simplified three colors). These are the aristocrats of the famille vertes and command enormous prices in the galleries. They have French names which describe their ground colors: those with yellow, aubergine and black ground being known as famille juan, famille aubergine and famille noir respectively. They are also often called yellow, aubergine and black "hawthorns," and perhaps this is the best way to differentiate the green ground sur-biscuits (lu ti so san ts'ai) from the rest of the famille verte family—the green hawthorn. We should also note that the black used on the famille noir is a composite glaze, produced by coating a green enamel over a black pigmental wash. The black is applied with an intriguing unevenness and the green used is a very iridescent enamel, resulting in a ground which is dazzlingly beautiful. All K'ang Hsi painted porcelain are done with a well-controlled brush which tends to be a bit too well mannered. The graceful, masculinely distended forms and the florid design put most K'ang Hsi porcelain within the class of the baroque.

HARVARD COLLEGE ENROLLMENT

As of January, 1945, the civilian enrollment in the various branches of the University was 1,986, compared with 1,826 for 1944, and a pre-war total of 8,078.

There are some 358 in Army special schools, and 3,754 in Navy special schools, making a total enrollment in excess of 7,639.

Every _____ needs **HAWS** Drinking Fountains!

* Office, factory, hospital, school, hotel, theatre, warehouse, terminal building, public building, stadium, playground and wherever people gather to work or play.

Drinking water must be made available to assure healthy bodies in growing children, and thirst quenching satisfaction for the workers who must efficiently keep up production.

HAWS Drinking Water Fountains and Faucets, and Electric and Ice Water Coolers dependably dispense cool and refreshing water with utmost sanitation, because . . . the HAWS Drinking Faucet projects the stream of water at an angle and the bubbler is shielded. The mouth cannot touch the orifice, and drippings from the mouth cannot fall back on the drinking fountain head.



Install HAWS Sanitary Drinking Fountains and Faucets, and Electric and Ice Water Coolers NOW! Specify and insist upon HAWS in your post-war planning. Write for our latest catalog R 1940-44.



HAWS Model No. 7F

Stream controlled, with raised shielded anti-squirt angle stream drinking fountain head, No. R2.

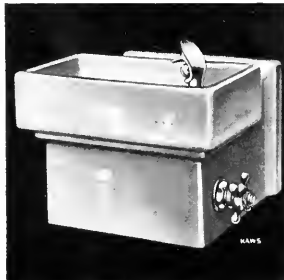

HAWS Model No. 7D

Stream controlled, with raised shielded anti-squirt angle stream drinking fountain head (locked to bowl), No. M.



HAWS Model No. 7A

Stream controlled, with raised anti-squirt angle stream drinking fountain head No. R6, placed under cowl. Orifice one inch above overflow.

HAWS DRINKING FAUCET COMPANY

Designers and Manufacturers of Drinking Fountains and Faucets since 1909

1808 HARMON STREET • BERKELEY 3 • CALIFORNIA

Agents in the following cities:

CHICAGO • LOS ANGELES • SAN FRANCISCO • SEATTLE • PORTLAND • SALT LAKE CITY • NEW ORLEANS
HOUSTON • ATLANTA • PHILADELPHIA • WORCESTER, MASS. • NEWARK, N. J. • RICHMOND, VA.
ST. LOUIS, MO. • GRAND RAPIDS, MICH. • DETROIT • CHEVY CHASE, MD. • EL PASO, TEXAS • NEW YORK CITY



HOTEL ALAMEDA—Mexico City

Carlos Obregon Santacilia, Architect

What Mexico Offers The Architect and Engineer

By Wm. ARTHUR NEWMAN, Architect

Suppose 23 million pesos, nearly 5 million dollars, were available and you were selected as architect to design the largest and most modern hotel in Mexico City, to contain 550 rooms, ample accommodations for conventions, and be a center of community life in the metropolis, how would you handle it?

That was the contract given architect Carlos Obregon Santacilia. His excellent solution has resulted in the 12 story Alameda Hotel, occupying half a city block, and now nearing completion.

It was with keen interest that I accompanied

the architect over the building, amid scores of workmen busily engaged. He explained his plan—placing on the ground floor, entrances to the hotel on three streets, shops, such as pharmacy, barber, beauty parlor, perfume shop, cabaret and night club, etc.

In the center of the floor above is the great marble lobby, daylighted through glass ceiling prism lights. It has two grand staircases close to four passenger elevators. From this lobby there is an unobstructed vista clear through glazed partitions to the rear, where ramps lead taxis

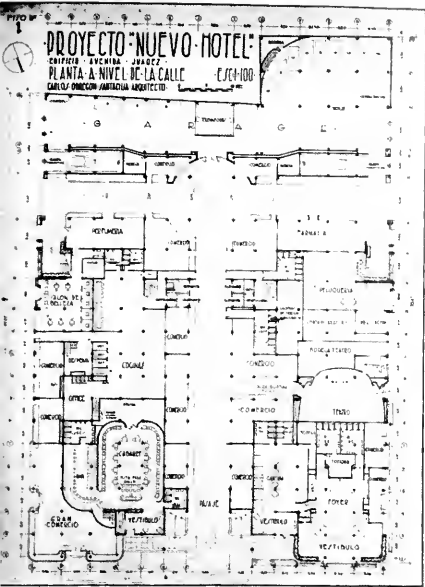

Left

Ground Floor — three-street entrance—shops, pharmacy, beauty parlor, cabaret and night club.

Lower Left

Great marble lobby on second floor, taxi ramp, main dining room, bar, intimate theater, and miscellaneous small service agencies.

Lower Right

Rooms, banquet halls, and multi-story garage, promenades and open terraces, occupy the upper floors.

Santacilia

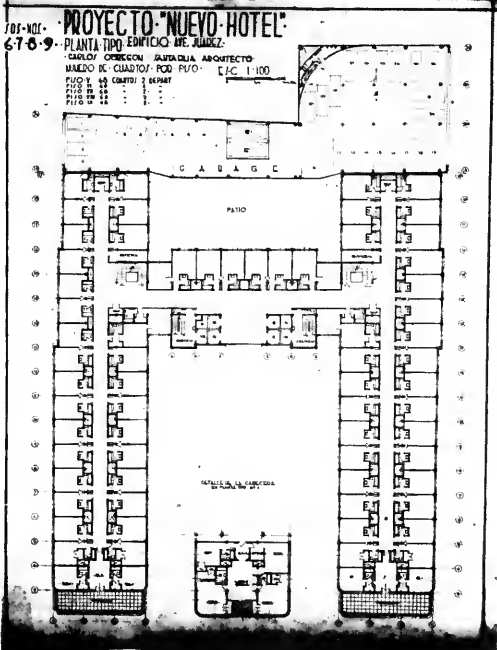
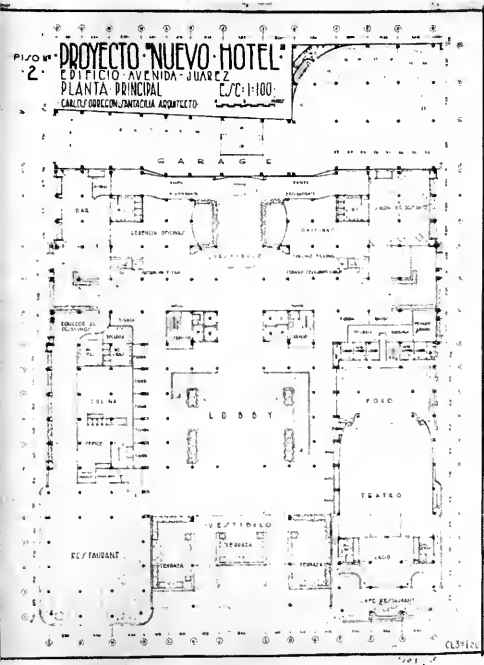



**Entrance to Guardiola Office Building
Mexico City, Mexico**

Architect CARLOS OBREGON SANTACILIA

to and from the lobby floor. Spaced all around this floor will be palms, potted plants, and flower boxes.

To the left of the lobby is the main dining room or restaurant; air conditioned and indirect lighted, of course, with a large balcony above for additional diners and orchestra. Connected with the dining room is the coffee shop or "Desayuno." All supplied with latest equipment. Not overlooked at the side entrance is a bar of ample size for parched and thirsty patrons.

Near the lobby desk, where guests are registered, are small shops, a newsstand, telegraph office, telephone booths where connections can be had around the world, a ticket booth for concerts, theaters, bull-fights and a travel bureau agency.

Two waiting rooms, "Terrazas," are located on the main front overlooking beautiful Alameda Park and Avenida Juarez, and another "Salon de Descanso" to the right in the rear. There are salons for conventions, exhibits, conferences, banquet rooms and a ball room on the upper floors. A multi-story garage in the rear, with two freight elevators, provides for the easy parking of nearly 400 cars.

Promenades and numerous flowered balconies, open terraces, porches, and pergolas on the roof add to the pleasure and comfort of the guests.



GUARDIOLA OFFICE BUILDING—Fourth Floor Lobby

Mexico City, Mexico

ARCHITECT AND ENGINEER

DISTINCTLY MODERN

is the eight-story stone
GUARDIOLA office
building in Mexico
City, Mexico.

View into elevator lob-
by shows modern
bronze and marble
construction with mu-
rals by a celebrated
artist on wall.

Santacilia



A small intimate theater, seating about 500, with revolving stage and provision for motion pictures, is located in the right wing, with entrance on Juarez.

Among the many other commissions Arquitecto Santacilia has received is the eight-story stone Guardiola office building at Avenida Madero and San Juan de Latran, with entrances on four streets. This is a pleasing, straightforward design, in simple lines, well balanced on all facades. Marble and bronze lobbies are handsomely finished. Murals by a celebrated artist adorn appropriate wall spaces in the main lobby. Three banks occupy the first floor, while businesses of international scope and the Bankers' Club are in offices above.

Senor Santacilia has had many years' experience in Mexican practice. He gives one a friendly feeling of confidence in his ability, which is undoubtedly one of the reasons he is now Presidente

de la Sociedad de Arquitectos Mexicanos.

As we chatted during lunch at the University Club, he confided that one of his first commissions was a monument given by the Mexican government to the people of Brazil at Rio de Janeiro. While supervising this work at "Rio" he also received the commission to design the Mexican building for the International Exposition in that city.

Returning to Mexico City he found that a large public building project had been given up, after much of the steel was erected. A change in the government had occurred. Architect Santacilia suggested a great stone "Monument of the Revolution," of massive proportions be erected in its place. The suggestion was approved, and the commission given him. Today this outstanding structure can be seen many miles distant. It is faced with buff lava stone; base and trimmings of black volcanic stone.

The architect was fortunate in obtaining the necessary cooperation to interpret in stone sculpture his conception of the spirit, majesty and power of the Revolution, intended to free men from mental and physical slavery.

Two elevators, one above the other, carry the visitor to the top of the dome which towers well above city buildings. Here one has a marvelous view of Anahuac Valley and snow capped Popocatepetl and Ixtaccihuatl in the distance. With its extensive setting and approaches, this monument also serves as a center for civic expositions.

There are, indeed, signs that Mexico is awakening to better progress. Increasing demand is for more and better roads, schools, buildings and better living conditions. The influx of tourist dollars, the profits from sales of war materials, etc., have given added impulse to the building industry. Large numbers of business, industrial and residential types have been erected, and many more are needed.



Great Stone "Monument of the Revolution", with buff lava stone face and black volcanic base and trimmings.

SANTACILIA

13,000 new schools have been built since the Revolution. Fireproof hospitals by the dozen are nearing completion all over the country. A large budget for public works has been appropriated and architects and engineers are busy. President Camacho reports 144 new industrial enterprises were established during the past year, and industrialization is growing. New power plants and additions are under construction.

If this sounds like Chamber of Commerce propaganda, we may turn to the statistics. These show 220,000 tourists arrived the past twelve months. They show a long list of exports, and an excellent credit balance of the government in New York banks. American banks have loaned millions of dollars for improvements here.

It is interesting to note that commercial business profits are high in relation to capital invested, and interest rates correspond. Bank loans and good bonds are from 7% up. A new enterprise must show a probable profit of from 25% to 100% to interest the Mexican capitalist.

Present prosperous conditions have created a demand for new building projects, including increased facilities for the large assembly plants of General Motors, Chrysler and Ford, the petroleum and rubber industries, public and private garages and service stations.

Other types needed are new shopping centers, banks, theaters, stores, restaurants, bus terminals, churches, post offices, motor camps for tourists and for the 140,000 registered autos and trucks. There is also urgent demand for additional alterations, repairs and new facilities, as well as for modern heating, sound conditioning and air conditioning.

Thousands of miles of new highways are increasing urbanization and consequent population movements; all of which increase the demand for new buildings.

Warning is given by old timers to be careful about contracts until one is familiar with local customs and practices. Mexicans have their own ways of doing things, and some of them lack speed. You may notice the slow motion group of stone cutters in the next block. They are doing a pretty fair job, but progress seems to drag. Why is it that every stone cutter stops work to look, as you pass by—and you're no lady? Well, what do you want for \$1.75 a day? It's no use getting excited, or trying to change these customs. It gets you nowhere. With a little tact and patience, all will be completed in its own good time.

A young Irish contractor from the States took a recent stone contract. Dissatisfied with the slow progress, he attempted to speed up progress in

the customary American manner. The workers objected to this sort of intrusion. Oh, yes, he went broke!

Quite naturally the average Mexican objects to foreigners interfering in his affairs, or in those of his country, especially capitalists, whose only desire is to exploit the natural resources of his nation. His attitude is different toward the professional man, who has something of value to give, and whose experience and ability are a real asset.

One hears glowing prophecies of the future of Mexico, and then again, just the opposite. Time and the aspirations and energy of the youngsters of today will provide the answer.

American investments here have been restricted, possibly due to lack of confidence in the stability of the government—racial, religious and political hatreds. If and when these are adjusted the growing importance of Mexico in the world will begin to appear.

Little by little this country is developing its own culture and architecture. Starting from the Indian Toltecs and Aztecs it received Spanish civilization—sometimes the hard way; then came intellectual inspiration from France, which has been followed lately by some enthusiasm from the United States.

When we consider the low scale of wages paid, viz. \$1.50 a day for carpenters, bricklayers, sheet-metal workers, etc., is it any wonder that there is a constant struggle between the old and new commercial and social systems?

This low cost of labor is looked upon as a satisfactory substitute when machinery is expensive, or is not available; hence the urge to keep the lowest wage scale.

The other day a deep excavation job was proceeding on a large lot adjoining the exclusive Reforma Hotel. There was no machinery on the site. Heavy sticky mud was being excavated with a shovel by hand, carried up a cleated plank in baskets on the backs of laborers and dumped at the street curb, where trucks were waiting. Forty barefoot men plodded in a continuous line—up and down. Each had slung on his back a wicker basket, holding a hundred pounds, attached by a strap to his forehead. All day long this line kept moving—using their heads to carry the load, instead of to lighten it. How would you like that job at 80 cents a day?

A national book fair was held in November, extending five blocks about the Monument of the Revolution. Scores of firms exhibited books of all nations, including architectural and engineering publications. Thousands were sold to the attend-



Another view of the Guardiaola Office Building looking down Avenida 5 de Mayo—Mexico City, Mexico.

SANTACILIA, Architect

ing crowds. Copies of this magazine are searched for improvements in design and construction. Advertisements are eagerly scanned for new materials and methods.

One cannot fail to note characteristic evidences of the love of the Mexican for his family, for beauty, entertainment, music, the movies, for sports of all kinds and the outdoor life. These offer opportunities to the building industry. American specialties, supplies and equipment are valued for their uniformly high quality.

Mexico has benefited by the financial and technical assistance extended by the United States, and in return our country has been supplied with thousands of trainloads of strategic and vital materials of war, such as minerals, fibres, hardwoods for landing craft, lumber, foodstuffs and many thousands of laborers, etc.

As the French people, through the Ecole des Beaux Arts welcomed architectural students from all over the world, creating closer bonds of friendship with their respective countries, in like manner have some American architects, engineers and architectural schools extended instruction to young Mexicans, who today express their regard and admiration for the great nation to the North.

Nelson Rockefeller, Assistant Secretary of State, is quoted as saying that the development of Mexico's resources and industry will provide greater opportunities for millions of people; opportunities for the future south of the border are



Banco Internacional branch building and the equestrian statue of Charles IV of Spain—Mexico City, Mexico.

Photo by Newman

limitless. Development of these resources and industry and improvement of transportation will provide fuller employment, a rising standing of living, increased buying power, more travel and general prosperity. Surely there are problems ahead—and grave problems—but most important, there are great opportunities.

Later, I shall tell you of the building boom South of the Border, and more of what Mexico offers the architect and engineer.

ERNEST KUMP SPEAKS

(From Page 5)

either, because architects as a rule certainly have a good fundamental knowledge of engineering and retain competent consultants.

That leaves us then with a final consideration—the building process itself, consisting of construction methods and construction economics.

Sounds extremely technical and solely of the province of the Contractor—but is it? Not entirely.

At this point possibly many will say, "But the building process should not be the concern of the Architect—that is the business of the Contractor"—and perhaps also, "It isn't ethical—we must uphold the **dignity** of the profession."

That, I think, is only a half truth. The other half may well be the quotation of Elbert Hubbard: "**Dignity is the mask behind which we hide our ignorance.**"

It is true that it should not be necessary for an Architect to be able to make a detailed cost estimate to show a construction superintendent how to organize his job, or to show a carpenter in the field how to lay out the cut of a hip rafter with

a steel square—this even taxes the ability of our cousin, the General Contractor himself!

In fact, it definitely is not even necessary for an Architect to be a Contractor, in the common sense of the term, or work for one.

What is important, however, is **the recognition of the extreme importance today of a good fundamental knowledge of the practical and economical aspects of construction and their application in the design and planning of buildings.**

The profession must shake off its lethargy and awaken to the realization of the broad scope of modern building planning, and what it includes—the practical as well as the aesthetic.

And why is this knowledge of the building process so important? For many obvious reasons—and because most of the general criticism of architects centers around seemingly minor practical considerations.

Public confidence has waned to such a degree concerning the Architect's ability to co-ordinate practical building processes in his planning that a certain stigma has developed in relation to the very term "Architect."

Let me recite from actual experience.

At the start of the present war, most Government bureaus including the Army and Navy brought this stigma pointedly home to the architectural profession.

As many architects well known, their volume of work sharply decreased while the work of planning by construction companies and engineers sharply increased. In fact, many Government agencies went so far as to tell architects "that they wanted a practical job done in a hurry" and therefore could not use architects. They were interested solely in our respected cousins, the "synonym-architects."

Throughout California, and I presume elsewhere, dozens upon dozens of architectural offices closed and many competent architects went to work for engineers and building companies. Others rushed for the veiled seclusion of higher education.

At this time, sensing this stigma connected with the name "Architect," and our curiosity having the best of us, our firm decided to take a "long shot" concerning future work. We were not convinced that our ability in the field of practical planning was less than that of our many respected cousins. As the outlook was extremely gloomy, we decided to take off the smock and put on the overalls.

We discussed war work with several Government bureaus that were earnestly in need of competent technical help in the construction field. We even added the word "company" to our firm name, and in discussing projects with contracting officers

(See Page 24)

WOOD MOSAIC

By J. FRANK PORTER

Ten or twelve years ago, a simple design was cut from a piece of mahogany veneer and sunk into a square of balsa wood in my shop. The effect was pleasing enough to inspire further efforts with more complicated designs and increasing varieties of wood. Later, this led to making designs which entirely covered chosen surfaces. Here, the design spread over the surface, where before it had been injected into the surface. Later, I executed a num-

ber of murals, one of which included lifesize figures in the design. Recently an art gallery paid this work the honor of accepting a number of pieces for a special exhibit. The subjects included marines, landscapes, armed service men in action, structural workers, still life and the head of a Chinese boy, which might be termed a portrait.

These creations have been referred to as inlay, mosaic, intarsia and marquetry. They were correctly named in each case with the exception of marquetry. Mosaic, of course, is the original medium, a classification which embraces the other three.

Mosaic is one of the earliest forms of cultural expression. Anthony, in his "History of Mosaic," declares the medium to be almost as ancient as art itself. It was in use five thousand years ago in southern Mesopotamia, where designs were exe-

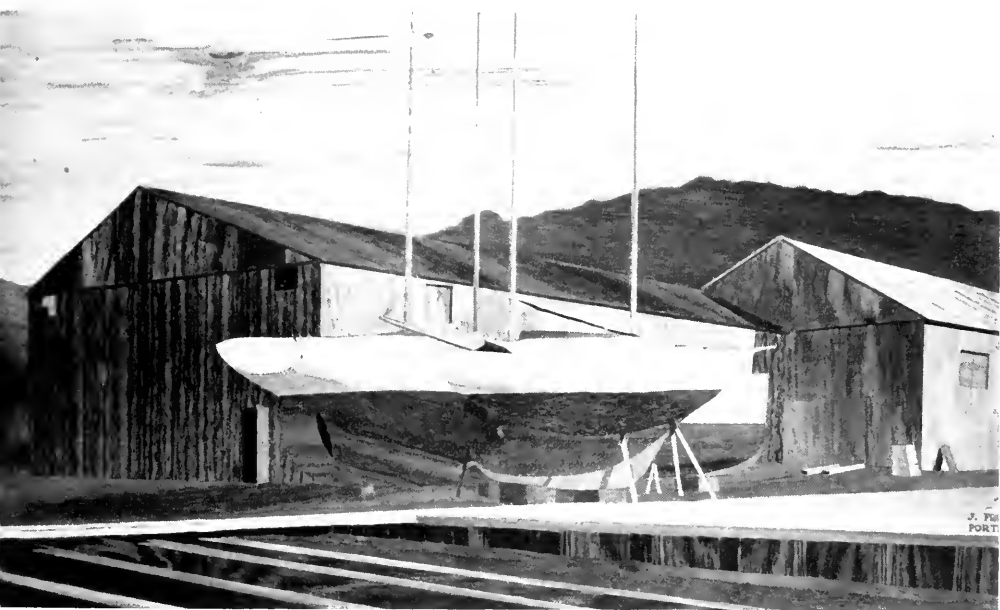

cut with cones of baked clay set in a paste or cement, to achieve decorated pavements. Artists viewed it as a medium of expression of culture. Their designs executed in a colorful assortment of materials established it as a medium of art, rather than a paving craft.

Mosaic is credited with being one of the greatest mediums of artistic expression in the Early Christian period and the Middle Ages. The Persians

These creations have been referred to as inlay, mosaic, intarsia and marquetry. They were cor-

Mosaic is credited with being one of the greatest mediums of artistic expression in the Early Christian period and the Middle Ages. The Persians

WITH THE ENGINEERS

INDUSTRIAL STANDARDIZATION

and Mesopotamians developed ceramic materials and the Egyptians brought into use earthenware, ivory, colored stones and glass. The Chaldeans and Babylonians contributed glazed bricks and enamelled tiles. The Mohammedans combined wood, ivory and mother-of-pearl for wall and furniture decoration. Ancient mosaics found in Mexico and Central America were made with turquoise, garnet, gold and other precious materials.

The Mohammedan furniture mosaics were probably the beginning of the inlay classification, in that they were some of the earliest examples of the design being injected into a background. When the design entirely covers a selected panel or surface, it becomes an intarsiated surface and is called an intarsia. Marquetry is a method of cutting veneers multiple fashion, thereby providing a choice from several pieces of material, identical in size, for each part of the design. Dyed wood seems to be common in marquetry. Since marquetry is a method of cutting the design, the finished work will result in either an inlay or an intarsia. Usually this technique indicates that wood is used, while inlay and intarsia indicate no particular material. The designs that I execute I have chosen to call wood mosaic. In this way the medium enjoys the freedom of being inlay or intarsia.

In our modern era, with vast distances minimized by improved transportation, we find hundreds of beautiful woods, from remote and mysterious lands, augmenting our domestic supply. A comprehensive collection of these woods offers an exciting array of color, flashingly alive and bright or deep and mellow. Some are particularly desirable due to color markings and tone variations which make them more expressive. Others are blessed with "action"—movement in grain texture. With such beauty at hand it seems a sacrilege to contemplate dyeing or bleaching.

Wood mosaic is particularly adapted to wall decoration in our present time. It is possible that many artists will succumb to the allure of wood and join with those who are, even now, carving paintings in wood.

HENRY H. GUTTERSON, A.I.A., has set up his new offices at 85 Second Street, San Francisco, Room 203, Phone EXbrook 3247, where he will continue his enviable practice of architecture. During his absence his files of catalogs and samples have no doubt run down and we are sure he would be glad to receive recent ones.

In London in 1930 it was next to impossible to get what we in the United States call a "coat shirt," one that buttons all the way down the front. The British simply could not see any advantage; you could pull them on over the head so why change. No doubt the problem of standardizing "screw threads" has been in a similar jack pot until recently, but the British have been making screws longer than we have, have many good reasons for their type of thread, and still are now working with us and Canada on a standardization plan. During his Presidency, Herbert Hoover brought about several conferences on the standardization of screw threads with little immediate results. According to "Industrial Standardization," the lack of unification of screw threads has already cost \$100,000,000 in this war.

If the disagreement were only the difference between flat sides at an angle of fifty-five degrees with rounded tops and bottoms, and a thread with flat sides at an angle of sixty degrees with flat tops and bottoms, the controversy could easily be settled; but the problem is very complicated and of a highly technical nature. But it is not a matter of merely reconciling the earlier British Whitworth thread with the later American Sellers thread for it involves pipe threads, valve threads, buttress threads, acme threads and a score of instrument threads. Reports and documents on this very fascinating problem may be had from the AMERICAN STANDARDS ASSOCIATION, 70 East 45th Street, New York 17, N. Y.

WITH THE ENGINEERS

Following the regular section meeting held at the Engineers Club, the organization meeting of the San Francisco Group of Professional Engineering Employees was held and the following committee on employment conditions was elected: Walter N. Frickstad, chairman; C. Martin Duke, secretary-treasurer, and L. Standish Hall, vice-chairman. There are now 72 members of the group, 16 employed by the State of California, 32 by the United States and 16 by cities and utilities. Although the Wagner Act does not provide for or protect public service employees, such employees can and do participate successfully in collective bargaining.

HAVE THE ARCHITECTURAL SCHOOLS MET THEIR RESPONSIBILITY?

by

LIEUTENANT (J.G.) LAWRENCE A. BENENSON

United States Coast Guard Reserve

Back in architectural school, not so long ago, we were taught that the basis of modern design was the functional approach. Although decorative treatment was stressed, it was subordinate to the principle that the building must "work." The motto, as it were, was "Form follows function," and the well-designed building had its aesthetic basis in the truthfulness of its forms. In other words, our plans were to fulfill the purpose for which they were supposedly designed, as well as to look the part. Some called it "organic;" some called it "functional," although this term was later decried; others thought of this sort of planning as simply "modern."

We did our best with these principles. Unfortunately, not knowing why a building wouldn't "work," we were in a poor position to plan one that would. There were a wide variety of interpretations on the functions of the rooms which we arranged. Therefore our designing was very often vague and ill-defined. If a solution agreed with the Jury's it was given a high mark—if not, it received scathing criticism.

Although our designs were elastic, the programs we worked from were rigid to the point of petrification. Many building types were described, and various conditions postulated, but they all had this in common: each contained a set of rooms, or space requirements, which were to be rearranged into a semblance of architectural unity. The student was expected to group the whole into a building which would be at once workable, structurally possible, and aesthetically satisfactory. As the program was handed to us on a sheet

of paper for us to read and interpret, so we returned our arrangement of rooms, carefully rendered and properly lettered, on paper, for advice and criticism. It was a neat little cycle, complete, intact, and quite enjoyable. Of the stuff of which buildings are made, we were uninformed. Of the problems, uncertainties and details of architecture, we were unaware. The fun of competition, with the possibility of winning prizes, blinded us to the fact that these were merely paper buildings.

Whatever the merits of this form of instruction in ordinary times, recent graduates of architectural schools have found it so unsatisfactory as to be useless in the present emergency. For when they joined the Service, they didn't bring their belongings. Their formal education was impedi-menta, to be forgotten throughout the war, since it was no preparation for actual construction work. While older men had acquired sufficient experience to be of real value in the construction program, the newcomers in the profession found their education by itself of little value to a nation at war. As the architect had discovered many times before, scant use could be made of his professional training.

Here then is a grave responsibility that has been overlooked by the schools, a responsibility indeed, concerning the needs of the entire country. The least to be expected of a professional school graduate is mastery of the fundamentals of his own profession. Instead, the architect completes his course with grandiose ideas for large scale design, but with abysmal ignorance of the essentials of even a small building operation. Had he

at least been taught to draft working drawings, he might have served his purpose today. But this is no time to labor the limitations of the young graduate. The fact remains that he can be of little use to the Service because of his lack of proper preparation.

Construction work is a vital part of any military operation. Bridges, gun emplacements, airplane hangars and runways all have their strategic importance, equalling actual combat tactics. Speedy construction, ingenious use of native materials, clever design, are formidable weapons in the hands of the Army Engineers, the Navy Seabees, or the Coast Guard Construction detachment. And consider the vast number of other projects necessary to the strength of our Forces: Hospital units, barracks, training schools, supply bases, and thousands of other jobs requiring the talents of our best construction men. Can the architect be satisfied to admit there is no room for himself and his training in this vast program? The pitiful fact is that he has given little evidence of adaptability in work other than "program design;" he is surrounded by an aura of aestheticism.

In another sense, is it fair to any man to be inducted into military service and find that the best part of his education has been a waste of time? He can see on every hand the need for trained technical men in the new construction for our armed forces. Yet, reflecting back on his curriculum, how few courses were devoted to the practical aspects of building construction, and how many to theoretical principles of design? What possible application can there be in the present emergency for those courses which have been taught in the cloistered halls—and which, in most cases, are still being given.

The academic mind approaches education as the cultivation of good taste. In the words of Frederick Murphy, of the Catholic University, for the *Journal of the A.I.A.*, "We still carry on with stylistic studies . . . which . . . tend to develop a sense of form, solid and void, color, texture, and the proper placement of ornament." (Boldface mine.) This presumably leaves the graduate to learn the practical, seamy side of architecture when he faces the hard world. The school expects its men to round out their training by experience in the years spent in architect's offices. It is assumed, no doubt, that young graduates will sample all the varieties of professional experience and be equipped to practice in the not too distant future. The fallacy of this theory is almost too obvious to be repeated: but under the circumstances, it might

be well to summarize the situation.

There are many reasons why it is a difficult and long process for the beginner to acquire his training from experience, as any draftsman would tell you. For one thing, his first few jobs will be in specialized offices, doing specialized work. Either by choice or necessity, many architectural firms are so highly standardized as to concentrate on but few building types. This prevents the young draftsman from obtaining a comprehensive view of buildings, since he is circumscribed by the nature of the work in his office, not to speak of the limitations of his own position. Another factor against the furtherance of his education, is the economic one. Most young men, after four or five years of college, must earn a living at the work, and therefore are not in the position to seek out the most advantageous jobs merely to improve their knowledge. On the contrary, they try for the most remunerative positions, regardless of other considerations.

Thus it takes a long time under present conditions for the beginner to obtain his full education. So long, in fact, that the draftsman is well on in years (architects are notoriously the oldest of all professional men) before he can really carry through a job. Therein lies the worst disappointment of all. For the Services need **young** men; they cannot stand by idly waiting for architects to pick up practical experience. The blind temporizing of the schools has insured their students against acquiring their education while they are young and receptive.

Educators might justify their curricula by replying that they did not intend to train men for a military career, and the application of the studies is for peacetime work. Yet architectural schools have not fulfilled even this function, according to their own graduates. The consensus of opinion is that the courses should be revised to help the graduates earn a livelihood at their own profession. In a pre-war survey made by the *Architectural Record*, 86% of graduates suggest changes in college curricula; the overwhelming proportion in favor of more "practicality." Some 25% were employed in fields entirely outside of building construction, and all of 13% of those surveyed were unemployed at that time (1940). No wonder that these men were dissatisfied with the fruits of their learning. They demanded changes in architectural education so that future students would not fall into the same abyss.

Our country needs youth, and it needs them

trained. The student should, on graduation, be capable of designing simple structures completely, have a working knowledge of engineering principles, and grasp intelligently the related aspects of his profession, which are so important to the practice of architecture. But how, you might ask, can the practice of an architect help the man going into uniform? Will he set up an office after induction? Hardly. But if the schools had taught what is their peacetime responsibility to teach, those men would have entered the Armed Forces better prepared and in all likelihood would have been assigned to construction work. That they have not, they have the incubus of academic design to blame.

No one would argue seriously that the architectural school concern itself with duplication of instruction of Military Engineers. The finest preparation it could give its students for war would be nothing more nor less than its normal, everyday obligation. The course of study might well conform to the same standards applied to the design of buildings. The curriculum should be **organic** and **functional**. Since the student is most likely to go into the practice of architecture some day, what could be more natural than the study of the practice of an architect? All the elements which go into the construction of successful buildings should be taught him in college as a preparation for his lifework. He should be given a comprehensive view of his profession and the correlation of the various artisan trades, professional responsibilities, and commercial practices which combine to make up "architecture." The institutions are in a particularly advantageous position for research in good practice, simplification, and improvement in all phases of building. Knowledge of construction, in its larger sense, is the firmest foundation on which the young architect can build, as well as the prime essential in earning a living.

Besides the impact of the war, which has been felt by every architect in uniform or out, the profession faces other problems, and with them, new challenges. Can the small house be brought into the domain of the professional man? What about prefabrication, does the architect face further inroads into his field through standardization? Possibly he, too, can contribute to the furtherance of low-cost housing by mass-production. And the competition of the designing contractor—can the architect remain aloof while his bread and butter are being snatched away?

(See Page 35)

IN THE NEWS

FROZEN FOOD SELF-SERVICE DISPLAY

Development of a Self Service Frozen Food Display Refrigerator which permits display of perishable foods of all types, meats, vegetables, and dairy products under proper conditions and refrigeration has recently been announced by



Hussman Refrigerators, Inc., manufacturers of commercial food refrigeration for stores, hotels, restaurants, cafeterias, hospitals, locker plants and other large uses.

Frozen foods by means of this new unit can be displayed within clear view and easy reach of customers, as the merchandise may be seen through a glass front from any part of the store and the product removed by merely moving slide doors or lift type doors.

Production of this new food display refrigerator is dependent upon W.P.B. restrictions.

OIL FIRED SPACE HEATERS

Designed to prepare the average person with information relative to types, function, and application of domestic space heaters, a booklet entitled "A Primer on Space Heaters" has just been published by the Evans Products Company, Michigan.

IN THE NEWS

(From Page 21)

Purely technical factors have been omitted and the booklet is purposely simplified to give the non-technical reader a practical understanding of the space heater as a modern home appliance.

A. LEWIS KOUE, A.I.A., announces the opening of his office in the Easton Building, 428 Thirteenth Street, Oakland 12, California. His telephone is TWinoaks 0967.

NEW HORIZONS FOR GLASS

Glass which will transmit a substantially greater amount of ultraviolet light and its accompanying Vitamin D, will be manufactured in the post-war era from aluminum metaphosphate, it was announced recently by engineers of the Monsanto Chemical Company of Saint Louis.

Aluminum metaphosphate is derived largely from aluminum and elemental phosphorus and represents a radical departure from such glass bases as lead, sand, soda, ash, and lime.

Post-war fluorescent lights may utilize phosphate glass due to its ultraviolet permeability, and it may be found useful in windowpanes of hospitals and solariums.

VERNON W. HOUGHTON, Architect, has moved from 240 Lemon Street, Arcadia, to 628 Palm Drive in the same city.

"LUMINOUS INDIRECT" LIGHTING

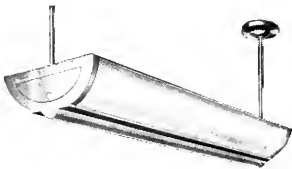

A new lighting development, designed to provide best seeing conditions for critical eye tasks in offices, drafting rooms, schools, and reading rooms, is the new Guth Cadet luminaire.

Suspended 24" to 30" beneath the ceiling in individual or end-to-end lighting arrangements, translucent cream white deflectors deliver in ratio

of 90 per cent upward and 10 per cent downward, thereby assuring correlated relations of brightness throughout an entire installation.

The overall efficiency in light output is exceedingly high. Illumination on the vertical simulates that of the horizontal which insures ease of reading on inclined as well as on flat planes.

MR. DAVID H. HORN, Architect, has changed his address from Claremont Hotel, Berkeley, to 601 Rowell Building, Fresno 1, California.

U. S. DEPARTMENT OF LABOR. BUREAU OF LABOR STATISTICS.

Expenditures for labor and material and man-hours of labor created per \$1,000,000 of contracts awarded for water and sewerage projects (based on 1940 prices) show:

Expenditures for labor at the construction site	\$318,000	31.8%
Material	492,000	49.2%
Other expenses and profits	190,000	19.0%

Number of man-hours created at construction site

330,000

In mines, forest, factories, in transportation and in administration

430,000

MR. RUSSELL G. CREVISTON, chairman of the post-war committee of the PRODUCERS' COUNCIL, stated "The well established conservatism of the home buying public offers the best assurance that there will be no revolutionary changes in the design or construction of new dwellings built in the early post-war years." He went on further to say, "It is significant that numerous new products and methods perfected for use in homes during the last 10 or 15 years are not yet in general use, although their worth and soundness have been well established. The public is not sure it wants them or else is not prepared to pay for them—most of the innovations in home building during the early post-war years will consist of equipment and materials that have been continuously improved through careful research, plus a few distinctly different products developed and tested thoroughly during the war.

Post-war homes will be sounder and better than those built before the war, but there will be few, if any, radical departures from past standards."

China and the Engineers

By MARK DANIELS, A.I.A.

As O. Henry would say, if he were living. When this war between Douglas MacArthur and the Japanese Empire is over the American Engineers are going to have a field day in China. Architects will be needed and some will go. Those that do need not be bothered over whether they are of the modern or traditional learning in their own schools, for I doubt whether the question of the "ORERS" will often arise. The Chinese are essentially a very thrifty and practical people and are concerned with the practical working of their houses and structures and the cost of maintenance and operation.

There is no reason why a well trained engineer cannot lay out as good a floor plan as an architect. It is only the aesthetic consideration of how that floor plan will appear when expressed as a structure that requires the additional training in architecture, plus a knowledge of details and structural materials. Nearly all of the problems of re-housing the millions of homeless Chinese will be erecting simple shelters quickly and practically, problems of drainage and sanitation, and problems of earth moving, nearly all of which fall within the scope of training of the well trained engineer.

There will be undoubtedly many calls for the electrical, mechanical and sanitary engineer. An electrical engineer in China some years ago sold fluorescent fixtures as fast as he could get them merely by proving to his customers that they consumed less electricity than the incandescent filament type. His experience taught him that any method that showed a saving was in demand.

It is true that the population is immense and labor readily at hand, but time is of the essence and, while earth can be moved in baskets, that takes time, and road making and earth-moving machinery will be in great demand. Mechanical devices that save labor and time will also be in demand, not only because of the labor saving element but because skilled labor of the kind wanted may not be at hand. Some of the forms of equipment that will be needed to rebuild the villages and cities of China are earthmoving equipment, steel pipe, motors and pumps, plywood, heating, electrical and plumbing equipment, wood preservatives and a great many other products that we produce in the United States that cannot be obtained in China. It may readily develop there as it did in Honolulu after the Japanese bombardment and it was decided to raise the U.S.S. Okla-homa. The Pacific Bridge Company was on the ground and had the equipment so they got the

(See Page 35)



Trees in Architectural Drawings

By MARK DANIELS, A.I.A.

The statement in the January issue in my article under the above title, a tree "should be easily recognized as the kind of tree it is supposed to be" is certainly one that all architectural renderers should always bear in mind, but "the kind of a tree" does not mean that a representation of a pine tree, for instance, should be so detailed that the drawing will show whether it is *pinus insignis*, *pinus radiata*, or *coulterii* or any of the many other botanical subdivisions. In other words, if the tree is of the pine family, don't draw it in a form that could be mistaken for an oak or a pepper or a poplar. Above all, don't resort to a wiggly outline filled in with a few vertical strokes with a 6B pencil, if the tree is any way a part of the foreground.

Most tree families have a sort of general appearance that is characteristic of the group. Most pines can be made to look like A PINE without showing whether it is a monocot or a di-cot or any other strictly botanical fact. Just make it look like A PINE, no matter what variety it is. A list of the trees most common to the Pacific coast might help, such as the oak, Monterey pine, the eucalyptus, the deodar (a cedar), the black acacia, the Lombardy poplar, the pepper, the orange. There are, of course, a host of others but if a draughtsman will give a little thought of just how to represent each of these in a manner that will give them the stamp of their particular individuality, he will get artistic results and save time.

ERNEST KUMP . . . Speaks Frankly

(From Page 16)

of the bureaus, we referred to ourselves as consultants in engineering, planning, and construction. We thought that this was not a bad synonym for the word "Architect." Of course, we also stated in a very blasé manner that we had five or six licensed architects in the firm, which type of service we could also furnish in the event it was **absolutely** necessary.

It was very interesting to find that within a short time we were overwhelmed with essential war construction projects consisting of complex air bases, Army camps, waterfront work, technical reports involving millions of dollars, large housing projects, school facilities, and believe it or not, we were finally even asked to construct some buildings. In fact, we were exceedingly gratified, after two years of diligent work on essential war construction, by the receipt of a meritorious commendation from a branch of the service for excellence in work in the construction field—and all this time we were really practicing architecture without a smock. What a great difference it seems a synonym can make. How well our cousins seem to know!

Now this practical side of architectural practice brings to mind the philosophy of a colored Parson who was once preaching a sermon on wisdom. He said, "It ain't de tings you know dat causes you de troubles; it's de tings you know dat ain't so!"

I am of the unquestioned opinion that many competent architectural firms well qualified to handle essential war work were denied the opportunity of direct participation in the war program for no more important reason than the name "Architect" which they carried. This fact alone is most impressive.

One of our deepest concerns should be a determined effort to restore the dignity and confidence of the public to the practice of architecture. It can be done and must be done.

Now let us consider what is involved in the building processes which concern us so deeply.

First, we have "economics of construction." What does this imply? For one thing, preliminary cost estimates of the building program—for another, the ability to design a building within a fixed budget—and finally, realizing as much building value as possible in terms of space, quality and function.

Second, we have the actual construction methods used in the building industry. What does this include? Several important items, and among them are: Field practice in construction, manufacturing techniques, and the physical properties of materials and their use.

Now, why should the thought of a sound insight into these items create a complex in the minds of most architects? Has the builder or engineer any mysterious sixth sense or unusual intelligence regarding this information? I think not.

Investigation will show that few general contractors or builders have a detailed knowledge of the work of the various trades and subcontractors under them. They do, however, have a rather sound fundamental general understanding of what makes building processes "tick," or if not, they know where and how to find out.

Strange as it seems, this information is not being rationed and is also available to architects, but it isn't easy. It has to be earned—it can't be learned. We must knock the "L" out of "learn" and earn it.

Our respected cousins have learned from experience and from the nature of their work to apply diligent attention to these important factors. Serious attention to these small factors will most certainly make the Architect again the master of the construction process as well as of design.

Let us now consider some of the practical details of the building process and how they relate to architectural practice.

Certainly most architects have a vivid picture of their experience concerning preliminary cost estimates. The client desires a building planned with some assurance of the cost being reasonably close to the estimate; it is being done and he is entitled to it.

Now I know of no better way to disillusion, discourage and diminish the confidence of a person than to prepare plans for a building upon which he has built fond hopes, desires and expectations—only to have it cost more than he can afford. This is commonly known as "the old build up and let down." It isn't healthy.

Why our respected cousins should have gained public confidence in their ability to prepare a more reasonable preliminary estimate than the Architect does not bear very close scrutiny.

There is another minor detail to be considered—that of keeping the design within the estimated budget.

It goes without question that keeping the building project within the Owner's budget is as important to the success of the objective as good planning, design, or any of the other considerations.

It must be realized that the objective in the Owner's mind is to be able to have a building within his financial limitations to satisfy certain real needs.

(See Page 31)

PUBLIC HOUSING A FALLACY!

By W. P. LAUFENBERG

I understand that for the purpose of arriving at an organization conclusion with regard to certain phases of Public Housing, it is your desire that I discuss it from the capitalistic point of view.

I deeply appreciate the opportunity to do so, because I recognize that the conclusion of the American Institute of Architects will have a profound bearing upon the final overall conclusion upon a subject so woven into our social and political economy as will be that of housing for the people of our communities—public or private.

Through what little I may say here, it is my hope that I may contribute something, to influence or support your conclusion.

I believe that housing, and particularly public housing, cannot be considered or discussed without relating it to other elements of community life in which urban, suburban and even rural community planning must be one of the first considerations. The two must be woven into a general pattern, formed and molded by a massed public opinion, which you will so definitely influence. It is therefore your particular responsibility to think clearly, all the way through to the end, before your final conclusion is passed along.

I do not want it to appear that I speak as an expert on housing, either public or private, or on community planning, and actually, I know nothing of politics or economics. I speak merely as a member of an industry closely related to, and most vitally interested in some sane solution of the problem—call it housing, public housing, planning—or by any other name—because that problem is one of the most serious now confronting us here in America.

Therefore, with those proposing to change our urban, suburban and even our rural communities, and to a considerable degree the mode of life therein, ours is common ground, because they, who would change our patterns, work with ground and we, as realtors sell it, and deal in it. You, as architects, develop and improve it. Therefore, as

practical realtors and practical architects, our approach to the problem must be practical, because it has come to us through years of experience in dealing with the commodity, real estate and improvements.

Our problems in common with those of the planners and the social housers, always many, have increased many fold with the war. Under wartime conditions and restrictions they are not subject to normal solution.

As to housing, all of our American communities—particularly those wherein wartime industries abound—continue to have a 100 per cent ratio of occupancy. San Francisco and our East Bay communities, in common with all of our American war industry communities, have long since passed the saturation point in occupancy, with every day more immigrants coming, who must be absorbed, if the community's services are to be used, to the full, in the production of materials necessary to prosecute and win the war. Normal planning and peacetime standards have had to be relaxed to meet the urgent war needs.

After a time, and we pray that it may be a short time, this war with all its emergency and disruption, will pass, but until it does pass and we are doing things which must be done quickly, awkward and costly mistakes will be made, and they will be difficult to correct. War is an expensive business, executed, naturally, with waste and abandon. War very properly makes regulation and restriction imperative, but even these should have at least some design in economy and practicability, so that whatever has to be done may be done easily, simply and with all the speed possible. Recovery of whatever of value which may remain, must be undertaken when the war is won.

With this in mind, we should not be much concerned about war housing and planning as such, but rather, we should be concerned with permanent housing, and planning over the long range.

You no doubt have heard housing and planning discussed many times. I shall therefore attempt, not to again cover familiar grounds.

I think, as a general condition, that all of our American cities and communities, even including our particular own, suffer from bad business management; that our community's greatest asset—its lands—has in almost every case been dissipated. It has been allowed to become marginal or blighted, and has lost most of its value in utility and in earning power. That is poor planning, bad business; bad sociology; and bad politics.

Your industry organization together with all of the others no doubt has an active committee working on the problem of community planning, and of housing, in the sincere effort to effect a solution as to your particular community, and thereby a solution for all communities. These committees, and yours in particular, must have in mind considerable planning and reconstruction, which will inevitably follow the war, if only as a result of pressure by public demand. The realtors' concern—and yours should well be the same—is what pattern that planning and reconstruction will follow.

The individual property owner has never been able to do very much towards raising the standard of housing in his community because working alone, he can do no more than keep his property up to the standard established in its own immediate neighborhood. If he proposes to improve his single holding, he finds, even though he spends the money, his income return just continues to drop. The tenant does nothing, because he has absolutely no stake in the neighborhood. When the standard set in his particular district becomes lower than his own scale of living, he just moves away. Another tenant, of a lower social stratum, replaces him, simply accelerating the depression. Now, the realtor—and I speak as one of them—The real estate man cannot hope to do much about it, because after all he is only an agent, and as such, acts only for and under the instruction of his principal, the property owner. And the architect can't do more because he is in about the same position as the realtor. Government has never done much, because the people have not wanted Government to spend the large sums of money required to accomplish adequate results.

Therefore, this is not a problem for any one element alone. It is a joint enterprise, one that all must carry out together, combining in the common interest the individual community, its citizens, its industries and its professions.

In doing the job together, it must not be concluded that the dealing is with physical values alone. The community planner oftentimes has the concept that his problem is one, only of building free ways of transportation, having master planners continue zoning, expand convenient retail business areas, construct new and sanitary or standardized housing, and provide expensive educational, recreational, religious and all of the other community services. Others are prone to think of slum clearance, only as a means of removing blight and sub-standard housing units or conditions.

They must be brought to realize that this whole concept goes much deeper than the surface of our streets, the configuration of the land and the design of the structures or buildings thereon. We are dealing with more elemental values than just appearance and form. We are actually changing the social, the economic and the political philosophies of our society. Thereby we can, and very easily may completely change our entire American system.

Take an example: No program for the planning or reconstruction of our cities or communities can have a possible hope for success, without liberal application of the law of eminent domain. That, I think, is conceded by everyone who thinks in terms of city or community planning. That law has long been very properly used, as a means by which government acquired lands needed for essential public use.

But during the few years just preceding the war, and now during the war period, there is some pretty definite indications that the right of condemnation by Government is being abused. War emergencies may well justify the taking by Government of private lands and buildings and private wealth at a price the owner might not under other circumstances be willing to accept.

But even before the outbreak of the war, large parcels of land were, under that law, acquired by governmental agencies, for the furtherance of projects which were purely social, even perhaps unsound in their conception and not economic in their application.

The lands were taken and the housing projects were built, without the slightest regard as to whether or not, the project fitted into the community's plan for growth or development. With such broad application of the law of eminent domain or condemnation, it is not at all difficult to see how all rights to common property might easily come into peril. The right of determination by an owner over his private property, which is one of

the basic planks of our heritage, might be removed. Even the security afforded the owner of homes, the owner of assets and investments and the owner of farms might be taken away.

We are told that Government already owns at least 46 per cent by area, of our land in California. Under Government ownership this 46 per cent by area of all land in California, is either tax free, or is subject only to a tender in lieu of taxes, at the pleasure of the Federal Government or its bureau, and not at the pleasure of the local assessor or tax collector.

It just goes on from there. The realtors are concerned over the information, well substantiated, that since the promotion of federal public housing projects within our country, there has come into being, a strong and well entrenched group of individuals, many of them occupying positions of considerable influence, and almost all of them working for bureaus or agencies of the federal, state, county, municipal or other local governments. These were establishing a foothold even before the start of the war. They were active in almost every state, in practically all large cities and in many of the smaller communities.

Since the beginning of the war and during its progress, the inter-migration of large masses of population, from one war industry area to another, has created housing shortages in many of these areas, just as we have them in almost every community in California. To provide housing for these "in-migrants," tremendous housing projects have been created. Government has taken upon itself through its bureaus and agencies, the acquisition of land, the clearing of properties and the planning and construction of huge housing projects upon these lands, and Government and its agencies are now managing these projects.

Naturally, there was a great deal of work to be done in planning, in the construction of the buildings, and in arranging for the services therefor. The Government organized and created vast bureaus and agencies to do this work. None of these bureaus and agencies, even though their particular part in the projects may have been completed, have ever been eliminated. They have been multiplied and their personnel has been increased, time after time, until now they are large, strong in their influence and very active in their several fields.

These bureaus and agencies are beset by the fear, that after the termination of the war emergency, many of the housing projects will have

(See Page 28)

IN THE NEWS

VERNON W. HOUGHTON, ARCHITECT, has moved from 240 Lemon Street, Arcadia, to 628 Palm Drive, in the same city.

FARR COMPANY GETS "E" AWARD



Award of the coveted Army-Navy "E" to the Farr Company, manufacturers of Far-Air filters, Los Angeles, has just been announced by the Western District headquarters of the Air Technical Service Command.

War production activities of the firm have been concerned chiefly with the manufacture of Farr Carburetor Air Filters for airplanes, which are unique in that the filtering element is of herring-bone crimped wire screen which produces high air cleaning efficiency with low pressure drop and large dust holding capacity.

In connection with the award it was announced that in three years production had tripled. As a result one out of every three airplanes produced is equipped with Farr Carburetor Air Filters. They have proven their worth amid dust and sand of North Africa by increasing the life span of an airplane motor 300%.

FRANK L. HOPE, JR., ARCHITECT, has moved from 1008 San Diego Trust & Savings Bank Building to 935 Bank of America Building, same city.

NEW GYPSUM LATH AND WALL BOARD

That much greater fire protection is available for the average cost home as a result of wartime developments in fireproof gypsum boards, was recently revealed by the Gypsum Association.

IN THE NEWS

(From Page 27)

At a cost no higher than old-style exterior walls and with a saving in critical lumber, an all gypsum protected wall that will afford structural strength, insulation and a vapor barrier in addition to gypsum's natural fire resistance has been perfected.

Tests have shown that placing metal foiled gypsum lath or metal foiled gypsum wallboard on the inside face of studs prevents passage of moisture in the air of a room thereby effecting an efficient insulation against condensation and also serves as an added protection against fire.

Gypsum manufacturers have been conducting extensive research to achieve the goal of an average cost home, adequately fire retarded, and thereby saving annually in lives and money.

W. HERBERT, ARCHITECT, has moved from 1033 Longwood Avenue, Los Angeles, to 1031 Longwood Avenue in the same city.

PLANTING BOXES ADDED

To relieve the severity of contemporary style of architecture, United Air Lines is including planting boxes and structural glass panels as integral parts of its new Age of Flight traffic office design.

Instead of placing the plant boxes "just anywhere" after the offices are constructed, they are made a part of the general design—usually arranged in front of glass panels or structural glass partitions. Plants look better in front of glass.

Sansevieria or mother-in-law's tongue, rubber plants, ferns and other indoor plants are used because they are easy to grow and do not need much attention.

Traffic offices in major coast-to-coast and Pacific Coast cities are being redesigned functionally and architecturally to handle anticipated air traffic increases of tomorrow's Age of Flight.

J. LLOYD CONRICH, ARCHITECT, has moved from 188 Beaumont Avenue, to 558 33rd Avenue in San Francisco, California.

PUBLIC HOUSING

(From Page 27)

served their purpose and may be no longer required. They realize that if the housing projects are no longer required and are dispensed with, the bureaus and agencies will also, be no longer required, and may be dispensed with.

It naturally follows that the personnel of these bureaus and agencies, executive and employee, have as their principal concern, the perpetuation of these bureaus and agencies. To perpetuate and to maintain them, they promote the ideology and the philosophy that the ideal housing in America, is that created by Government and operated by Government, at the expense of the community in which the housing exists, and that they be perpetuated and retained, as social projects of semi-charitable character.

In that I refer to the various public housing authorities, federal, state, county and municipal, which have already been organized in almost every large community in the nation. We have excellent examples of their exploits in the San Francisco Bay Area—in San Francisco, in Oakland, Richmond, Alameda and everywhere, where there is public housing.

There are several things, serious in their nature entirely beside the physical structures and the land of configuration that these bureaus, agencies and authorities stand for in our country.

They promote the operation of a capital subsidized and tax subsidized venture, in direct competition with private capital, tax paying enterprise. That very basis is in direct opposition to all of the theories of our form of Government. It is a definite swing to the left. It tends to discourage the purchase of homes and farms by the people of America, thereby creating a tenant class, rather than an independent owner class. That is in direct contradiction to our accepted thought, that one of the greatest towers of strength in our nation, is the percentage of American families who either own, or are purchasing homes and farms of their own.

I wish that I might now diverge, just a little, from the topic directly under discussion, get off the reservation so to speak, and talk a little bit about, just how bureaucracy works. But since it would take perhaps twelve or fifteen minutes, without giving the detail, assuring you at the same time, that if the detail thereof is interesting, I can give it to you.

I might tell you of the formation, under international labor organization influence, of federal housing project tenants' unions.

Of the plan to so regulate private building by way of material and price control and priorities that real and camouflaged housing shortages be built up all over the country, so that even after the war the federal agencies, as opposed to private industry, may expand themselves to provide that housing.

Of the realtors' belief that they, the realtors, as private enterprise, could administer and manage the existing federal housing projects at a charge of twenty or thirty per cent of what it is now reputed to cost under bureau management.

Of the philosophy propounded by those in charge of and employed by public housing and other federal bureaus and agencies, that home ownership in our country should not be encouraged.

And I might tell you about how the National Association of Real Estate Boards carried forward such a fight against one prominent bureaucratic member for his expression of that philosophy that this bureaucratic member was released by shifting him to another bureau, and, out of this other bureau, evidently to "spunk" the realtors of America, there was almost immediately proposed a directive which would have imposed a price ceiling on farms and homes. This happened some months ago. Just during the last two or three days I have been told, though I have not been able to verify the report, that the real reason that proposal was not made effective was because the farm bloc, one of the strongest pressure groups in America, spiked it at least until after election this fall.

I could go on almost without end, because the brief against all governmental bureau or agency operation of private industry, be it public housing or otherwise, from the capitalistic point of view is voluminous.

There is advanced only one justification for the expansion of public housing. It is the charge that private enterprise has not solved the housing problem for the lower income group. Why should it? Private enterprise and private industry cannot undertake the providing of housing or shelter for those in income, too low to pay a proper rent or charge for it. Certainly private enterprise and private industry should not be called upon to provide housing or shelter for those unable to make such provision for themselves, any more than private industry or private enterprise should be called upon to provide food, clothing, medical care or other services for the same group. There should be a general agreement that the providing

(See Page 30)

RUNNING FIRE

(From Page 1)

COMFORTABLE AND ECONOMIC. In Russia, sometimes leave out the conditions, and if so, which one? There may have been some reason for tacking these three conditions onto the requirements, other than a specific item directed to the Russian architects. It is quite possible that the shoe is on the other foot and the authorities in Russia who sent the cables thought that we in America, with our usual lavishness, ignored these conditions as requirements for a house, for although they are always a condition, not many of those built in this country live up to the requirements.

IN THE NEWS

BUILDING PERMITS ARE UP

New construction valuation for January in the twenty-five leading cities of the West increased 80.37 per cent above December, according to WESTERN BUILDING'S Monthly Statistical Survey. With a December recording for the twenty-five leading cities of \$6,770,963, January's figures were up to \$12,212,830.

25 Leading Cities

	Jan. 1945	Dec. 1944	Jan. 1944
Los Angeles	\$ 3,706,428	\$ 1,952,352	\$ 2,963,654
Denver	1,304,445	258,330	232,860
Vancouver, B.C.	1,000,575	413,350	561,265
Seattle	956,520	697,495	875,035
Tacoma	789,072	106,335	156,285
San Diego	439,412	243,916	1,310,708
Portland	439,325	563,255	963,495
Long Beach	421,735	464,815	2,042,275
San Francisco	403,596	532,967	830,080
Oakland	313,514	268,461	1,155,881
Richmond	256,803	66,100	333,814
Burbank	229,014	297,038	412,748
Sacramento	219,047	64,818	25,379
Pasadena	217,703	99,698	84,502
Vernon	184,447	82,150	130,362
Victoria, B. C.	171,376	164,907	63,765
Vancouver, Wash.	162,986	50,483	72,925
Monrovia	154,080	43,929	14,709
Walla Walla	140,905	21,908	12,225
Torrance	130,765	51,385	69,300
Tucson	126,539	49,901	52,451
Berkeley	117,461	114,426	255,700
Bremerton	113,290	20,240	57,050
Glendale	107,102	72,117	169,109
Astoria	104,690	70,587	11,210
	\$12,212,830	\$ 6,770,963	\$12,856,787

PUBLIC HOUSING

(From Page 29)

of housing and shelter for those unable to provide it for themselves, is neither an obligation of the federal government through any of its public housing agencies or projects, or for private industry in any community. It should be an obligation carried directly by the local charitable organizations in every community, just the same as are all other local charities.

Perhaps private enterprise is responsible in a measure for the slums and blighted areas, but it is not private enterprise alone. It is lack of coordination between Government—state, county, city and local Government—on one side and private ownership, private enterprise and private capital on the other. Private capital may do for itself those things which are necessary to restore reduced values and substandard housing, except for the reason that there are property owners in every community just as there are individuals in every society who will need considerable pressure to bring them to any action. But let the local governments give the proper tools, by way of legislation, and the job can be done, without losing to our people the basic rights and independence of action, which has made this country the greatest industrial nation, with the highest standard of living, in all the world.

City planning and urban and suburban rehabilitation are not reflected in housing alone. They are evidenced by new community plans, streets, sewers, free way, highway and park systems, and other projects in the interest of utility and civic beauty. These things are indeed laudable. Even a most conservative capitalist will endorse them when the cost is somewhere in keeping with the aim.

But herein lies the danger. Since the depression of the twenties and early thirties there has been a trend under which states, counties and municipalities plan large and expansive and expensive programs, and then appeal to a paternalistic federal government, for the money to put them into execution. The planners feel these improvements excellent, and they are excellent, and the planners further feel pride in their accomplishment, regardless of the means employed to finance them.

Well, history tells us that when our American Constitution was framed, there was in the constitutional congress, a faction which believed in a federal centralized Government, with practically no state autonomy. This basic theory, however,

(See Page 33)

IN THE NEWS

NEW PHOTO STENCIL FILM

A new and simplified photo-stencil film designed especially for silk screen printing processes has been announced by the Craftint Manufacturing Company, 210 St. Clair Avenue N. W., Cleveland, Ohio.

Pre-sensitized, the new stencil permits a high degree of standardization in exposure times and stencil film depth, and is protected from finger marks, scratches, dust and other damage by a thin laminated cover film.

NEW FAN UNITS ANNOUNCED

Two new high efficiency axial flow fan units have just been announced by Dynamic Air Engineering, Inc., of Los Angeles.

Equally unique in size from the mighty 60 inch to the midget 2 inch they are believed to be the



largest low pressure and smallest high pressure propellers engineered and produced on the Pacific Coast.

Performance by ASH & VE standard code of test shows the 60 inch low pressure propeller driven with a 10 H.P. 1150 R.P.M. motor delivers approximately 60,000 C.F.M. free air and 5,000 C.P.M. at $\frac{1}{2}$ inch S.P.

The midget 2 inch propeller developed for a complete fan unit will be powered by a tiny motor of approximately two-thousandth H.P. and will deliver 30 C.F.M. at .30 inches S.P.

In addition to highly specialized fan units, Dynamic Air Engineering, Inc., manufactures a complete range of low and high pressure fans designed to operate at speeds from 870 R.P.M. through the normal range of A.C. speeds and into series wound and high cycle speeds up to 14,000 R.P.M. or more.

NEW BAKELITE RESIN GLUE

Bakelite Corporation announces the introduction of XC-17613, a cold setting pheno-resorcinol resin glue for wood bonding which provides maximum water resistance for exterior plywood applications.

The properties of this new adhesive, which supplements Bakelite hot and warm setting glues, are described in detail in an 8-page Technical Data booklet, "Bakelite Cold Setting Phenolic Resin Glue XC-17613," and may be obtained from Bakelite Corporation, 30 East 42nd Street, New York 17, N. Y.

A NATIONAL WEEKLY FOR ALL ARCHITECTS

The Weekly Bulletin of the Michigan Society of Architects will function as the official publication of the National Council of Architectural Registration Boards and will be mailed to all architects in the United States. Just to think of it staggers one; every architect in the United States. It is not that there are so many, but their addresses are so transitory in these war times.

It is a grand idea, one that will present a real unity in the profession, but it is an heroic undertaking.

ERNEST KUMP SPEAKS

(From Page 24)

Our "synonym-architects" will produce a building within the estimated cost even though it may fall far short of what is desired in design and planning. It is very natural. That is their business.

The distinguished gentleman in the smock therefore must come to realize that many owners will continue to sacrifice the aesthetic requirements, if necessary, in order to realize a building.

It seems that our respected cousins give primary attention to the practical considerations in a building and minor emphasis to design or effect—except as a sales medium. The Architect, on the other hand, puts his primary attention to the design and planning and gives minor consideration to the building processes, in which he is usually disinterested—I think that they are both exactly half wrong.

In reality, the Architect should put equal em-

phasis on all factors involved. **The practice of architecture cannot be divided into separatenesses—the objective must include the entire picture, the practical as well as the aesthetic.** That is the Architect's job as I understand the practice of architecture.

It is interesting to note that the Architect today has come to accept certain of the technical and practical processes as an important part of his procedure. These consist of the use of consulting engineers and manufacturer's agents as a source of technical assistance.

In most cases, however, the Architect has been slow and even reluctant to recognize the integral part played by a detailed specialized knowledge of the building process in the successful planning of the modern building. As a result many "architect-engineered" buildings have fallen far short of being creditable examples of building construction—a field in which the public had until recently assumed he was the master.

It is now necessary that we, as architects, go a step further. We must recognize that specialized knowledge of the building processes is also an integral part of our ability to successfully plan and design the modern building—that it is not the exclusive field of our respected cousins, the "synonym-architects."

As a working method in practice we must gather in and co-ordinate all specialized knowledge available in technical and construction processes, and direct them efficiently towards the accomplishment of the objective in design. None can be omitted.

Only the properly trained Architect is fitted and has the broad outlook and approach necessary to successfully accomplish this.

Architects should look to experienced persons in the construction field as consultants in the building process. The same recognition they are gradually giving consulting engineers.

In preparing preliminary estimates, the services of experienced practicing estimators should be retained, and architects should not try to loosely "guesstimate" costs to disadvantage.

Accurate surveys of costs should be prepared before plans and specifications are completed for bidding purposes, in the manner of the General Contractor, and the drawings adjusted to suit the budget.

In this way bidding will resolve itself into a mere formality, any competitive advantage realized being for the client's benefit—as well as for the benefit of the Architect's reputation—this in contrast to putting the plans out with a prayer, as is customary, and hoping for a miracle or mistake on the part of the contractor to preserve the Owner's respect in the Architect's ability.

ERNEST KUMP SPEAKS

Now there seems to be a strange philosophy in the minds of most architects concerning the construction processes which I have mentioned.

When an unusual or outstanding building is constructed, there is extreme interest manifested in the results and the methods used to attain them.

While this interest is sound, there seems to be little curiosity aroused as to whether the methods were practical, economical, or neither. Due to this, the effects resulting in the original example start to "bob up" in many buildings, as well as architectural competitions—regardless of their worth other than effect—the philosophy of "what" not "why."

One day I happened to be talking to a young Architect concerning a recent competition in which he had received fairly high mention, and of which he was justly proud. The competition concerned the design of a post-war manufactured house.

In discussing his design at some length, in the course of conversation, we came upon the manufacturing processes involved and the practical considerations upon which they were based. After some excellent generalities and theories had been mentioned by my friend, all of which were beyond the realm of practical possibility for some time to come, I became curious as to the background, experience and interest concerning manufacturing techniques upon which his convictions were based.

In a casual manner I asked if he had ever researched in, or studied modern manufacturing techniques and their possibilities. The answer was "No." I then asked him if he had ever been in a prefabrication plant, and the answer was "No." Becoming a little impatient, I then asked him if he had ever "walked by" a prefabricating plant, and the answer was still "No."

There is little wonder that few, if any, prefabrication designs developed by architects through competitions, dreaming, or other methods, have been adopted for actual production purposes. There is wonder, however, at the naiveté or great courage manifested in the ability to tackle any problem regardless of what is involved, I don't know which. Our respected cousins use a word for it: "starry-eyed."

In modern architectural practice the building process is a very fundamental detail unless architecture is to be merely "pipe-dreams," projects, and interesting architectural competitions, to a majority of those devoted to it.

There is another point to be seriously considered by the profession. That of specialization and the use of expert consultants concerning complex building problems—many of which exist today.

The average Architect, it seems, considers him-

self unusually qualified to tackle any design or planning problem that confronts him, regardless. He isn't the least bit perturbed even if he has had no practical background or experience concerning the problem he is invited to tackle. That represents real courage and determination, but, of course, at the expense of the Owner.

I know of no other profession that carries this determination to such a point.

It might be well to consider the workings of the legal and medical professions in this instance. Both lawyers and doctors have come to realize that through specialization they are able to offer their clients a much more valuable service than was previously possible—and in addition to increase public confidence in their professions.

Lawyers and doctors also, as a rule, are not hesitant to associate or call upon expert consultants concerning complex cases in which they have had little or no experience, or in which they think it would be to the client's advantage.

It would be well for the architects to take a cue from the experience of these other professions in this respect.

Specialization has many advantages, not only to the client but to the professional man as well.

In our present era of complex planning requirements, scientific mechanical achievements, and intricate construction processes, it would seem to be to the Architect's advantage to abandon the position of "jack of all trades and master of none." Being a qualified expert in a chosen field will certainly increase the dignity and respect of the man as well as of the profession. The public generally seems to have a profound appreciation of the value offered by a specialist in contrast to the general practitioner, even in the field of architecture.

Now I could go on in much more detail concerning my subject, but I'm afraid it might put me in the position of the man who was invited to speak before a business man's club in San Francisco. Having been given the choice of his subject on which to speak, he remarked that he had chosen as his topic his Alma Mater, and what it meant to him. Being a graduate of Yale University, the speaker went on, the meaning in each of the letters in the name "Yale" had come to have a special significance to him. "Y," continued the speaker, stood for "youth," and he talked for forty minutes on the significance of the word "youth." "A," said the speaker, stood for "ambition," and he proceeded to speak for fifty minutes on the word "ambition." "L," continued the speaker, stood for "loyalty," and he spoke for over an hour on the word "loyalty." "Now 'E,' the last letter of the word 'Yale,'" said the speaker, "stood for 'enterprise.'"—and he spoke for over an hour and a half on the significance of the word "enterprise."

(See Page 34)

PUBLIC HOUSING

(From Page 30)

was not finally written into our Government. As a result we have done very well as a strong, unified body of states, each with certain definite state's rights. But in these recent years there has been a tendency on the part of states, counties, cities and local governments to look to Washington for the money with which to do everything these local governments wanted to do, whether it was a proper project for Federal subsidy, or whether it was not. Strangely enough, these states and counties and cities and local Governments almost without exception, got just exactly what they went after. Federal cash seemed always easily available to carry out local community plans.

With every such grant of federal cash, went some measure of local control into the federal government, until now the freedom of the individual state or county or city or local government agency, has been sold to the strong central federal Government. Whenever we see something it is only reasonable to expect, some day to deliver possession of that which has been sold. All of our communities are now, seemingly at the point where they have to pay back, that which has been accepted from our federal Government. Dollars and cents, yes, but much more in local autonomy and the right of independent action, or, shall we say freedom? We have sold our heritage of freedom, and we have paid for it with our own money raised from our own taxes out of our own communities.

Some say they do not believe this, but let them think just a little. Most of the agencies and bureaus in times of peace, and much more in times of war, are local in name, but local in name only, because the employments therein are federal. If you work for a man or a government, and if your pay comes from that employer, he is your boss because he can fire you. If you examine practically all of these local agencies, so-called, you will find that their policies come from Washington where the pay checks come from.

Where does this fit into the housing and planning picture? Well, most if not all of the plans now being developed are going to look to NHA or FPHA or RFC or FDR or some other new agency not yet born, to carry the financial load. Your free ways are to be paid for with federal funds, as well as your bridges, your highways, your parks and your buildings.

(See Page 35)

PICTURE A CITY WITHOUT ELECTRICITY FOR ONE HOUR

Lights off . . . elevators stopped . . . radios and appliances out of commission . . . street cars motionless . . . hospitals and operating rooms desperately handicapped . . . endless confusion in a community dependent on continuous efficient electrical service.

The modern house, on a smaller scale, likewise, is dependent on efficient electrical service for a smooth-running household.

That is why adequate wiring is so important — and it is bound to assume even greater magnitude in the postwar home, when the variety of appliances is increased. Then every homeowner will demand sufficient and conveniently placed electrical outlets and switches and satisfactory illumination throughout the entire house.

Adequate wiring will provide the key to the home of tomorrow — the future way of living. Architects, responsible for the proper planning of wiring service, are keeping abreast of advances in the electrical industry and preparing for exacting postwar demands.



NORTHERN CALIFORNIA ELECTRICAL BUREAU

1355 Market Street
San Francisco



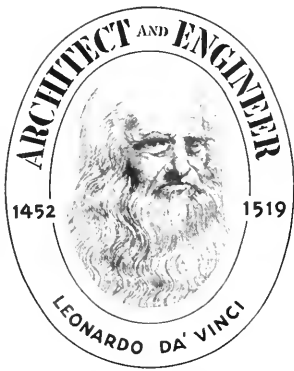

LEONARDO DA VINCI

Maestro da Vinci said: "Little knowledge imparts to people pride; great knowledge imparts humility. Thus, ears empty of grain disdainfully lift their heads to heaven, whereas those full bend theirs low, toward the earth, their mother."

From the diary of Giovanni Beltraffio.

ERNEST KUMP SPEAKS

(From Page 32)

At the conclusion of the address a member of the audience in the back of the room staggered to his feet, securing the attention of the speaker said, "I would like to say something, if it's permissible." The speaker replied, "Why, of course, go right ahead. This is the time for discussion, if you desire to say something."

Whereupon the gentleman in the audience remarked, "Well, I only wanted to say that thank God you didn't go to the Massachusetts Institute of Technology."

In conclusion, what are the net results to the architectural profession as a whole, growing out of the existing situation?

A large proportion of planning and design, which should be done by practicing architects, is being done by persons improperly equipped and trained to do a creditable job.

Young students and architects sincerely interested in the profession, and who have given the best years of their educational training to the subject, have been denied the opportunity to practice it. Innumerable cases in point have been forced to accept work with building companies, contractors, engineers, or with concerns in entirely unrelated fields.

In addition, established and practicing architects are normally planning a very small proportion of the large volume of building construction being done in this country year in and year out.

The normal volume of construction work carried on in this country is well able to absorb the entire services of students trained in our architectural schools as well as that of established practicing architects. That is **if** the architectural profession regains the confidence of the public and takes its rightful role in the scheme of things—a goal well worth the most serious attention that can be given to it.

While the net results to the profession itself are very serious, the most serious side of the situation involves the net results to society and the public generally. Poor planning and design growing out of lack of ability of the Architect to keep his rightful place in the scheme of things has resulted in many of the economic and social problems existing at the present time, and which we are painfully trying to overcome.

Architecture must not be the exclusive plaything of aesthetes, but the vigorous, valiant servant of mankind—it must be made to mean something good and beautiful and helpful, not only to the intelligentsia, but to the commonalty as well—it must be true and good and beautiful—hence useful and practical—it must descend from its ivory tower and become a living, vital, ministering reality to the great mass of "just Folks"—of whom Lincoln said, "God must love them else he would not have made so many of them."

We, as interested parties, certainly can contribute vastly to the correction of the present chaotic understanding of the scope of meaning of architecture.

To accomplish this—"Let us abandon the philosophy of 'separateness' and embrace the philosophy of 'wholeness' concerning our concept of planning—both in our educational processes as well as our practice;

"Let us apply the philosophy of 'why' not 'what' in our insight into the building process as a part of planning and design;

"Let us remove our mask of dignity and earn a sound understanding of the practical considerations involved in the true realization of our efforts;

"And finally, let us strive to be again the 'respected master' of architecture—the Architect as we understand him."

As this issue of ARCHITECT & ENGINEER goes to press it appears from reports that there are seventeen projects of Public Housing, embracing approximately 3,200 Family Dwelling Units, for which the Federal Public Housing Authority has not yet selected architects. It would seem that from this pile of work a few of the struggling architects in the Bay Region, where nearly all the projects are located, should be able to find some much needed work.

PUBLIC HOUSING

(From Page 33)

If therefore we are to advocate in our several communities a program of housing and planning, immediate or post-war, let us advocate one that we can afford, one that we can pay for ourselves, with the gas tax fund, direct tax levies, or in some definite local pay-as-you-go-plan. And let us, just as we have always done throughout the entire history, permit free and private enterprise to provide the shelters for our people, so that as a free people we may own our own, or determine at least, whether such shelters shall be rented or owner occupied. Let us in our communities not represent just one of the chattels of a strong centralized government. Let us preserve the basis of our constitution, and not permit the matter of planning and housing to go further along the road to centralized government control. Let us make it a joint enterprise for local government and private industry to work out together under the political philosophy of private enterprise to actually do the job.

It must actually be done by private enterprise because there are so many things which government cannot do, and will never be able to do if the program is to be successful. There is no place in a governmental program for zoning, because the very basis of zoning is restriction, and under the constitution the Government cannot grant restriction.

It is probably a generally accepted thought among many of our planners, that master plans be based on a checkerboard housing of non-assimilable races. This thought is not compatible with the temper of most of our people, and it does not establish or maintain sound values in any community.

We cannot agree with the thought, that a time may come when infiltration will not immediately cause reduced values and readjustment of neighborhood occupancy. We are not yet ready to fully accept the checkerboard program which government must permit, if it operates housing under our constitution.

The things which may be necessary to the prosecution and winning of the war, may very well be those things which must be changed when the war is won. I repeat, therefore, that in a discussion of this kind, wartime urgencies may be eliminated because they are not subject to normal solutions. We need not be so much concerned in physical values, because mistakes made in planning, in zoning, in building and in housing can be corrected, but the social values behind those mistakes will be almost impossible to correct and must not be overlooked.

American boys are now on foreign soil, warring against the results of just such political pressures and philosophies, while at home we shall be treading the paths which lead to the same ends. May we abandon those paths. May we restore and preserve our individual right and freedoms, that our boy may come back from the battlefronts of a wartorn world, not to be regimented to life in an industrial slum housing project—but that he may come back to—just the America and the kind of a home he all the time knew he was fighting for.

HAVE ARCHITECTURAL SCHOOLS MET THEIR RESPONSIBILITY?

(From Page 21)

Admittedly an enlightened policy of instruction in the schools would not solve these questions by itself. But architectural students could gain the flexibility they'll need so vitally when they emerge, diploma in hand. With a background of knowledge covering the practice of architecture, they would be best fitted for these problems which lie ahead. For then they would be informed and receptive—first requisites in the furtherance of a training that will last all their lives. Here is the "program" for the schools—to formulate a curriculum that will be expressive of the needs of the students, functional in respect to the improvement of architects and architecture, and organically suited to a living, changing world. Only then can the architect, whatever the demands upon him, be assured and proud that he has received the ultimate in professional training.

CHINA AND THE ENGINEERS

(From Page 23)

job, one of the largest salvage projects of record.

City planning with all its complexities as we know them, will, in all probability, be confined to the large cities. In the smaller cities and villages the work will consist mostly of land preparation, drainage, sanitation and small dwelling construction. In the latter case pre-fabrication should play a very large part.

Where is the money coming from? Perhaps lend-lease, it has not been decided. A commission has been sent here and is now working on the problem and it is a fact that several of the largest construction companies in the country are making plans to get into the activity in a big way. But that does not mean that small dealers will not be called upon to furnish equipment for it is going to be a big job.

SOME LETTERS

Journal of The American Institute of Architects, 1741 New York Ave. N. W.
Washington 6. D. C.

January 9, 1945.

Dear Mr. Daniels:

I have belatedly come across a note I made after reading your issue of October. You ask in "Running Fire" whether that department shall be continued.

As for me, its discontinuance would rob contemporary magazine writing of one of the very few reasons for reading. Discontinue it at your peril!

Cordially yours,
H. Henry Saylor.

Mr. Mark Daniels,
San Francisco, California.

Los Gatos, California,
Route 1, Box 574.

February 12, 1945.

The Architect and Engineer,
68 Post Street,
San Francisco, California.

Dear Sirs:

Please continue sending me Architect and Engineer. It's the most

interesting of similar publications today.

Enclosed please find my check.

Yours very sincerely,
Gilbert Hodson.

Henry Wollf, Twelfth and I Street,
Anchorage, Alaska.

January 8, 1945.

The Architect and Engineer,
68 Post Street,
San Francisco, California.
Dear Sirs:

Please find enclosed a check for \$3.00 for a year's subscription to The Architect and Engineer Magazine, and start it with the January issue of this year.

I used to receive your magazine when I was located in Kodiak and always have been very much interested in receiving your copies.

Yours very truly,
Henry Wollf.

TOWN BUILDING AND ARCHITECTURAL WORK IN THE U.S.S.R.

In continuation of the wires received during the past two months comes word from ARKADY MORDVINOV, chairman of the Committee on Architecture for the People's Council of the Commissar of the U.S.S.R., that very extensive restoration work is now under way and that "millions of patriots are working with great enthusiasm carrying out Marshal Stalin's instructions to provide a normal way of life in the shortest possible time for those people who have been freed from Fascist slavery."

His report further states that the old town planning schemes will have to give way to a single architectural idea which must contain solutions in problems in Art and Technology. The old town planning schemes must not be allowed to play a leading part in the work rehabilitation. Preparation for immediate rehabilitation is to be the prime consideration. Apparently any old plan that is "rubber stamped" "Town Plan" will not suffice as it has, so often in this country in the past.

To quote Mr. Mordvinov further,

"Special architectural form MUST be found for each town being rebuilt and its individuality determined by geographical, climatic, national and other considerations which MUST be discovered and MUST find expression in our Art."

To achieve this end, groups of workers were sent out, headed by Soviet architects, to help local people to rebuild their cities. One hundred and forty towns are now in the process of reconstruction with the aid of these organizations. Towns that have been badly wrecked are to be re-planned and old planning faults corrected. Stalingrad is a good example. The view of that once great city on the Volga was formerly shut off from the river by a mass of tall buildings. Under the present plans, boulevards will be built along the Volga embankment opening up the view to and from the river.

Under the latest plans, Novorossisk will become a seaside town which its location on the shores of the Black Sea would call for. Also the town of Smolensk (with its population of 150,000 we would call it a city) will be rebuilt, omitting the ugly houses that cursed the picturesque Dnieper. In all the plans for rehabilitation the landscape is one of the most important conditions to be considered.

All in all, it looks a little as if Marshal Stalin is putting on the heat. The rubber stamp has been consigned to the waste basket and the architects and town planners are going to have to take off their coats. Some idea of the enormity of the job may be had from the seventh OSTROVSKY report from Moscow, which states: "In only twelve towns the Germans burned, blew up or made unfit for habitation fifteen thousand eight hundred sixty-six buildings. They destroyed fifteen theaters, seven hundred schools and three hundred seventy-one medical institutions." So, the architects have their work cut out for them and it is encouraging to learn that old theories of town planning are in the discard.

"KIMSUL" Controlled Insulation!

THERMAL EFFICIENCY 0.27

Compressed in rolls for shipment and to save storage space, it stretches out over 5 times and when fully stretched gives a uniform designated thickness which insures the same maximum insulation value at all points.

**Fire, Moisture and Vermin
Resistant**
**Extremely Light, Clean and
Easy to Install.**

GUNN, CARLE & CO.

20 Potrero Avenue
San Francisco 3
UN 5480

A. I. A. ACTIVITIES



RESOLUTION

The following Resolution was adopted at the January 9 meeting of the Southern California Chapter:

"NOW THEREFORE BE IT RESOLVED: That the members of the Southern California Chapter of the American Institute of Architects, having an especial interest in the development of the Civic Center, respectfully request the State of California, through its authorities in charge, to locate the proposed office building within the Civic Center and that it be designed of materials and in an arrangement, not only to accommodate the department which will use it, but so it will reflect credit on the State and will properly represent it to the citizenry of Los Angeles."

Copies of this Resolution with a recommendation that their support be given this request were sent to leaders of various political, industrial and professional organizations.

SMALL HOUSES

At the January meeting Merrill Baird reported on the work of his Small House Committee. The Committee made a very thorough study of this old problem and have several interesting conclusions to make as follows: (1) Not many Architects are interested in small houses. (2) The next ten years will probably see a great many small houses built. (3) There is no time to educate the public to use the services of an Architect for a small house. (4) Low income bracket cannot afford a 10% architectural fee and (5) that small houses will be built in bunches of 200 or more at one time in planned communities.

UNIFICATION

The Northern California Chapter of the American Institute of Architects has given a concrete example of what can be done when unification is earnestly pursued.

The membership of the Chapter has increased by leaps and bounds during the past few months, and, in addition, the Chapter and the Northern California Association were virtually merged at the January meeting for the election of officers of the Chapter.

Andrew T. Haas, a delegate to the Council and a director of the Northern California Association, was elected president of the Chapter for 1945; E. Geoffrey Bangs, chairman of the Chapter's Unification Committee, was elected vice president; John S. Bolles, past president of the State Association of California Architects, president of the California Council of Architects, and president of the Northern California Association of Architects, was elected secretary of the Chapter.

Hervey Parke Clark, former secretary of the State Association and chairman of the membership committee of the Chapter, was elected treasurer; Norman K. Blanchard, for two years president of the State Association and now a director of the Northern California Association, was elected a director of the Chapter; William Knowles, former secretary of the Chapter, was elected director; Eldridge T. Spencer, retiring president of the Chapter, became a director; and the carry over director of the Chapter, Wm. Clement Ambrose, is also a director in the Northern California Association, as well as a member of the State Board of Architectural Examiners.

It is obvious that under this group unification is secure as far as the relationships between the Council, the Northern California Association and the Northern California Chapter are concerned. At the present time, these three organizations share the same office and with their overlapping boards have no room for disagreement as to policies and duties.

THE PICTURE ON THE COVER

Unfortunately the great Hotel Alameda in Mexico City had not been near enough to completion for Mr. Newman to get a good photograph of it to accompany his article. Our correspondents are that way. They are so alert with their news that they sometimes cannot await the finished product. But it was fortunate that the great and talented architect, Mr. Santacilia, could furnish a picture of a model which is, perhaps, better. It would have been difficult to get so comprehensive a view of the hotel itself. Unquestionably Mr. Santacilia did much of his studying from his model, for the practice of designing in three dimensions is becoming more popular with the greater architects, particularly when their work is of a magnitude that can bear the costs of accurate models in detail. A little later Mr. Newman may send some photographs of the Hotel Alameda in operation. If he does, let us hope that the picture includes a goodly portion of the beautiful Alameda Park, a worthy setting for any masterpiece of architecture.



QUALITY AND DEPENDABLE
Service

are the factors that influence architects and contractors when selecting lumber and mill work — Quality of merchandise — Integrity and Ability of the firm—Service in physical equipment — Experience and Personnel — All these factors contribute to a speedy and satisfactory completion of construction with minimum of time and expense.

MANUFACTURER OR DEALER IN

Douglas Fir—Redwood—Sugar and Ponderosa Pine — Plywood and Concrete Form Panels — Sash and Doors — Millwork — Insulation — Builders' Hardware.

E. K. WOOD LUMBER CO.

"Goods of the Woods" ©

LOS ANGELES • SAN FRANCISCO • OAKLAND

Be sure you're getting the finest window glass obtainable

it costs no more to specify

PENNUERNON

Distributed by...

W. P. FULLER & CO.

PAINTS • GLASS • WALLPAPER

it's **PENNUERNON**
FLATTER *flat drawn*
WINDOW GLASS
.. CLEARER ..
.. BRIGHTER ..

IN THE NEWS

MR. ARTHUR H. MOTLEY, Publisher of the American Magazine and member of the Committee for Economic Development, points out an overgrown weakness in the marketing of residential buildings. He also recommends some good and long over-due remedies and emphasizes the necessity of making it easy to purchase a home and for an owner to dispose of one. He states that "it is twice as hard to buy a home—and not from the financing point, either—than any other individual object necessary for everyday life. We must make it as easy to buy and finance a house as it was to purchase a car before the war.— Valuable time is spent arranging a mortgage, clearing a title, getting surveys, signing papers and completing other legal essentials. This should be remedied so that a purchaser will spend no more time getting the essential deeds and what not for a house than he would in getting title or registration for a car.—Once he is sold all that he should be required to do is produce the necessary cash down payment and then in return for his signature he should be handed such things as title, deed, a detailed schedule of payments, etc. Once things are so simplified for a purchaser—and it can be done by a little thoughtful planning—you'll be able not only to build homes but, what's more important, you'll sell them." Yep, it should be done.

JOHN R. REMPEL, ARCHITECT, has moved from 2227 East Crescent Drive, Altadena, to 3716 Eifengham Place, Los Angeles, California.

THE KATE NEAL KINLEY MEMORIAL FELLOWSHIP for 1945-1946 is announced by the committee in charge. It yields \$1,000 to defray expenses for one year's advance study of Fine Arts in America, is limited to applicants not over 24 years of age and must be either in MUSIC, ALL BRANCHES OF ART, OR IN ARCHITECTURE. Requests for application blanks and instructions should be addressed to DEAN REXFORD NEWCOMB, College of Fine Arts, Room 110, Architecture Building, University of Illinois. Applications should reach the committee by May 1, 1945.

EDWARD W. KRESS, ARCHITECT, has moved from 1047 Camino Ramon, San Jose, to 770 Coe Street, San Jose.

IN THE NEWS

NAMED SALES MANAGER

Roland D. Doane, recently in charge of the amphibious tank program for the Bureau of Ships, U. S. Navy, has been named general sales manager of the Ingersoll Steel and Disc division of Borg-Warner.

Prior to joining the Ingersoll organization in 1939, Doane was connected with the U. S. Gypsum Company, and Eagle-Picher Lead Company.

ELEVATORS AND DUMB WAITERS

An easy-to-read, 24-page booklet, "Sedgwick Standard Specifications For Elevators and Dumb Waiters" will assist the architect and engineer in the specification-writing phase of his work.

This booklet, containing standard electric and hand power elevator and dumb waiter specifications is designed to facilitate the writing of specifications.

APPOINTED PRE-ASSEMBLED HOME AGENT

Standard Equipment Company, Phoenix, Arizona, and affiliated with the Dorris-Heyman Company retail furniture outlet of Phoenix, has been appointed the first distributor for Wingfoot Homes, Inc., pre-assembled house manufacturing subsidiary of the Goodyear Tire and Rubber Company.

An initial allocation of 100 homes has been made for Litchfield Park, Arizona, with production limited under wartime housing regulations to that permitted under government war housing rules.

An innovation in housing, these homes are delivered entirely assembled and may be easily moved on a truck, trailer or railway car. They may be financed with a reasonable down payment and monthly payments.

BUY U. S. WAR BONDS AND HOLD THEM!

PENDING PEACE



Innovations in commercial and industrial lighting, developed by Smoot-Holman engineers, are well past the formative stage, but production awaits "V" day. Men, machines and material are needed now for war work, but when Peace comes we'll again be providing the newest and finest in lighting equipment.

BUY AND HOLD U. S. WAR BONDS

SMOOT-HOLMAN COMPANY

SMOOT-HOLMAN

INGLEWOOD, CALIFORNIA

MADE IN U.S.A.

Offices in Principal Western Cities—Branch and Warehouse in San Francisco

PRODUCERS' COUNCIL PAGE

Northern California Chapter

The National Organization of Manufacturers of Quality Building Materials and Equipment
Affiliated with the AMERICAN INSTITUTE OF ARCHITECTS



DAN ANZINI

Business-like D. I. "Dan" Anzini of General Electric, will be remembered for his neat presentation of his Company's products and services before one of our meetings and will long be remembered by your Editor for his promptness in getting in his picture. This issue would be lacking in human interest without him.

Dan is neither too young nor too old to admit his age. He was born in Palo Alto 45 years ago. After completing high school in 1917, he enlisted and spent 17 months in the U. S. Army Air Corps during World War I. Eleven months were spent overseas, mostly at the U. S. Army Headquarters in London.

Characteristically, Dan got right down to business when it was over, graduated from Stanford in the class of '23, then joined the General Electric Company. With GE, Dan spent about a year on "test" at Schenectady, New York, and Lynn, Massachusetts, returning to the San Francisco office, Commercial Section. Several years were spent as assistant meter and transformer specialist, then direct commercial assignment contacting the P. G. & E. During the last few years when we have come to know him, he has been contacting architects and contractors as well, handling assignments for their Federal and Marine Division.

Mrs. Anzini is also a Stanford graduate and they have a daughter at Stanford. Their home is in San Mateo.

Last year Dan was a member of our Post-War Planning Committee. Currently he is serving as vice-chairman of the San Francisco Section-American Institute of Electrical Engineers. His other activities include membership in the Engineers Club, San Francisco Electric Club and Beresford Country Club in San Mateo. His hobby is philately

and he frankly admits "with as little gardening thrown in as I can get by with!"

VIC ANDERSON RETURNS to San Francisco after a tour of duty at Otis Elevator's Los Angeles office. Vic, a past president of the Class of '40, is certainly a most welcome addition back into the Chapter.

OUR PORTLAND BABY is off to a good start . . . in fact, it's grown up over-night. At the first regular meeting of the Chapter after their Charter Night proceedings, 21 members and 2 alternates were present with 19 architect guests.

READ IT AGIN! We've been hollering about attendance and support from the members in complimenting our speakers. We call, we bawl, we dig and we haul at each other, but if we would each just simply come and **each bring one guest**, how simple it would be. Actually, when we don't bring a guest we are hitch-hiking on the rest of the boys.

ONE OF THE BEST monthly meetings we have had was that held in February when Raymond B. Smith, executive vice-president of the San Francisco Real Estate Board, spoke on the thought provoking subject of Urban Rehabilitation.

WELCOME, JOSAM PACIFIC CO. They are new Chapter members, represented locally by M. Greenberg & Sons Co., with Elmer Ross as their regular member and Harry Fabris, alternate.

MODULAR COORDINATION moves forward. A technical presentation of Dimensional Coordination has been developed by Modular Service Association acting as the Staff Office of ASA Committee A62, sponsored jointly by the AIA and the Producer's Council. Accompanying the lecture material is a slide film presentation that is available at \$2.00 a roll.

WE HOPE when you start an architect on that post-war plan, it will be Modular Planned.



USE QUALITY PRODUCTS



CONSULT AN ARCHITECT

BOOK REVIEWS

MODERN STORES. National Retail Furniture Association, 666 Lake Shore Drive, Chicago, Ill. \$2.50

The so-called book is really a 160-page magazine, eleven inches high by eight and three-eighths inches wide, profuse with illustrations, showing principally plans for furniture stores that have been planned for 1945. Nevertheless, there are many suggestions for stores other than for the sale of furniture. There are also a few building facades which have been well considered and the fact remains that because the store has been designed for the sale of furniture there is not always a good reason why it cannot be used, or slightly modified, for the sale of other materials.

It also has the advantage of being up-to-date in its field. The styles in store fronts pass out faster than they can be printed so that "MODERN STORES" has the advantage of being the last word in its particular field.

ENGINEERING CONTRACTS AND SPECIFICATIONS. By Robert W. Abbett, Member American Society of Civil Engineers. John Wiley & Sons, Inc., New York. Price \$2.25.

In my library is a particular "five foot shelf" that is devoted to works on contracts and specifications for both architectural and engineering work. I usually have to thumb nearly all of them to settle some point in doubt. Of course, such works get out of date, particularly since we entered the war and subjects came up that were seldom thought of before. But after going over Mr. Abbett's "ENGINEERING CONTRACTS AND SPECIFICATIONS" I have a feeling that the length of this shelf of books will remain fixed for some time to come.

So many of the authors of books on contracts and specifications leave the "why" out of their treatises. I don't mean the legal phase but the common sense reasons why certain forms have been adopted. In Mr. Abbett's book the rules, forms and laws are present in addition to which the plain, every day common sense of their uses and adoption are brought out.

Competitive-bid contracts, cost-plus-a-fixed-fee contracts, engineering and architectural service contracts, U. S. Government contracts, are clearly explained. Methods of arriving at a fee for services, tables of construction—oh well, get a copy and see for yourself. The chances are that your shelf of that particular kind of book will stop growing, too.

—M.D.

Base Your New Plans on STANLEY HARDWARE

The leadership of Stanley Hardware for industrial building construction is a worthwhile sales advantage on every project. Match every construction need with the wide variety and unbeatable quality available in Stanley Hardware.

THE STANLEY WORKS
New Britain, Conn.

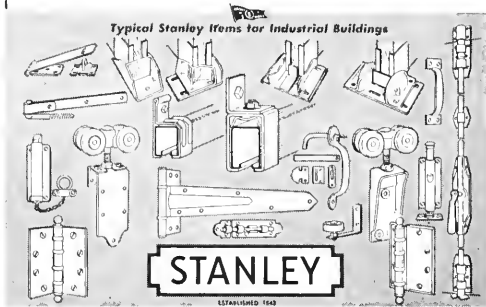

PRESSURE TREATED LUMBER
● **PROTECTS AGAINST DECAY
AND TERMITE ATTACK**

Specify it in your home
Available through Lumber Dealers

LOS ANGELES
601 W. 5th Street
Phone Michigan 6294

SAN FRANCISCO
333 Montgomery Street
Phone DOugles: 3883

J. H. Baxter & Co.

AGENTS FOR WEST COAST WOOD PRESERVING CO., SEATTLE, WASH.

WOOD TECHNOLOGY (New Edition). By Harry Donald Tiemann, M.E., M.F. Pitman Publishing Corporation. \$4.00. 2 West 45th St., New York, N. Y.

Almost any well written book on the subject of a material used extensively in architecture is of interest to architects, but not all such books give information that is of practical use to members of the profession. "WOOD TECHNOLOGY" is one of those books that can help an architect. True, it was written to and for commercial dealers in wood but it has much information that architects should know. For instance there is a chapter on shrinkage, not from the standpoint of the builder, but that of the scientist showing which woods shrink most from the green wood stage to the dry state.

For the landscape architect there is, perhaps, more specific information. Certainly the study of wood and the cellular construction of wood in relation to the family of trees from which it came will throw some light on the problem of variety determinations. Above all, the opening chapters on "What Is Wood," "The Life of a Tree," and "The Structure of Wood," contain information that every man should know, regardless of his profession.

CORRECTION The **TECHNIQUE OF THE TERRAIN**, published by the Reinhold Publishing Corp., is on the market at \$3.95 and not priced at \$3.50 as stated in the Review in the November issue of **ARCHITECT & ENGINEER**. How these errors creep in, no one knows, but we will take all the blame.

—Editor.

LOUIS C. DIXON, prominent southern California architect, announces his association with Lee B. Kline under the name, **LOUIS C. DIXON and LEE B. KLINE ASSOCIATED ARCHITECTS**, with offices in the Rowan Building, 458 South Spring Street, Los Angeles 13, California.

LEAK PROOF AIR GUN

A new line of leakproof air guns for blowing chips, dust, dirt, knocking out finished parts and

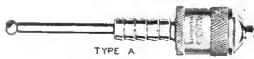

TYPE A

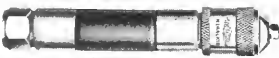

TYPE AB

operating air-tools, such as air vises, clamps, chucks and presses is now being produced by **TRICO FUSE**

Manufacturing Company, Milwaukee, Wis.

Effortless handling saves time and reduces operator fatigue, while operation is instant and positive with substantial savings in air, and compressor maintenance.

MALOTT & PETERSON

**ROOFING AND FLOORING
CONTRACTORS**

20TH AND HARRISON STREETS
SAN FRANCISCO
Phone ATwater 1600

HOGAN LUMBER CO.

Wholesale and Retail

LUMBER

MILL WORK • SASH & DOORS

Office, Mill, Yard and Docks
SECOND AND ALICE STREETS • OAKLAND, CALIF.
Telephone GLencourt 6861

SANTA MARIA INN

SANTA MARIA, CALIFORNIA

FRANK J. McCOY, General Manager

FERNAND E. PIMENTEL, Manager

On the
Coast
Highway
between
San
Francisco
and
Los
Angeles



American
or
European
Plan
•
Old
English
Tap
Room

**CLINTON
CONSTRUCTION CO.
OF CALIFORNIA**

General Contractors

923 FOLSOM STREET • SAN FRANCISCO
SUtter 3440

ARCHITECT AND ENGINEER

Estimator's Guide Giving Cost of Building Materials, Etc.

AMOUNTS GIVEN ARE FIGURING PRICES AND ARE MADE UP FROM AVERAGE QUOTATIONS FURNISHED BY MATERIAL HOUSES TO SAN FRANCISCO CONTRACTORS. 2 1/2% SALES TAX ON ALL MATERIALS BUT NOT LABOR

All prices and wages quoted are for San Francisco and the Bay District. There may be slight fluctuation of prices in the interior and southern part of the state. Freight cartage, at least, must be added in figuring country work.

BONDS—Performance—50% of contract.
Labor and materials—50% of contract.

BRICKWORK—

Common Brick—Per 1M laid—\$50.00 to \$60.00 (according to class of work).

Face Brick—Per 1M laid—\$120 to \$150 (according to class of work.)

Brick Steps—\$1.60 per lin. ft.

Brick Veneer on Frame Bldg.—Approx. \$1.30 per sq. ft.

Common Brick—\$19.00 per M, truckload lots, f.o.b. job.

\$19.00 per M, less than truckload, plus cartage.

Face Brick—\$40 to \$80 per M, truckload lots, delivered.

Cartage—Approx. \$4.00 per M.

BUILDING PAPER—

1 ply per 1000 ft. roll.....	\$3.50
2 ply per 1000 ft. roll.....	5.00
3 ply per 1000 ft. roll.....	6.25
Brownkin, Standard, 500 ft. roll.....	5.00
Sisalcraft, 500 ft. roll.....	5.00
Sash cord com. No. 7.....	\$1.20 per 100 ft.
Sash cord com. No. 8.....	1.50 per 100 ft.
Sash cord spot No. 7.....	1.90 per 100 ft.
Sash cord spot No. 8.....	2.25 per 100 ft.
Sash weights, cast iron, \$50.00 ton.	
Nails, \$3.42 base.	
Sash weights, \$45.00 per ton.	

CONCRETE AGGREGATES—

The following prices net to Contractors unless otherwise shown.

Gravel, all sizes—		
\$1.95 per ton at Bunker; delivered	\$2.50	
	Bunker	Del'd
Top Sand	\$1.90	\$2.50
Concrete Mix	1.90	2.45
Crushed Rock, 1/4" to 3/4"	1.90	2.50

Crushed Rock, 3/4" to 1 1/2"	1.90	2.50
Roofing Gravel	2.25	2.80
River Sand	2.00	2.45

Sand—

River Sand	2.00	2.45
Lapis (Nos. 2 & 4)	2.85	3.15
Olympia (Nos. 1 & 2)	2.85	3.10
Del Monte White	84c per sack	

Cement—

Common (all brands, paper sacks), carload lots, \$2.42 per bbl. f.o.b. car; delivered \$2.72. Cash discount on carload lots, 10c a bbl., 10th Prox.; less than carload lots \$3.20 per bbl. f.o.b. warehouse or delivered. Cash discount 2% on L.C.L.

Atlas White	} 1 to 100 sacks, \$2.50 sack
Calaveras White	

Forms, Labors average \$200.00 per M.

Average cost of concrete in place, exclusive of forms, 35c per cu. ft.; \$10 cu. yd.; with forms, 60c.

4-inch concrete basement floor	30c per sq. ft.
Rat-proofing	7 1/2c
Concrete Steps.....	\$1.25 per lin. ft.

DAMP-PROOFING and Waterproofing—

Two-coat work, \$3.50 per square.
Membrane waterproofing—4 layers of saturated felt, \$7.00 per square.
Hot coating work, \$2.50 per square.
Medusa Waterproofing, \$3.50 per lb. San Francisco Warehouse.
Tricocel waterproofing.
(See representative.)

ELECTRIC WIRING—\$12 to \$15 per outlet

for conduit work (including switches).
Knob and tube average \$3.00 per outlet. (Available only for priority work.)

ELEVATORS—

Prices vary according to capacity, speed and type. Consult elevator companies. Average cost of installing a slow speed automatic passenger elevator in small four story apartment building, including entrance doors, about \$6500.00.

EXCAVATION—

Sand, 60 cents; clay or shale \$1 per yard. Teams, \$12.00 per day.

Trucks, \$22 to \$27.50 per day.

Above figures are an average without water. Fire shovel work in large quantities, less; hard material, such as rock, will run considerably more.

FIRE ESCAPES—

Ten-foot galvanized iron balcony, with stairs, \$150 installed on new buildings; \$160 on old buildings.

FLOORS—

Composition Floor, such as Magnesite, 33c to 50c per square.
Linolite—2 gages—\$1.25 to \$2.75 per sq. yd.
Mastapay—90c to \$1.50 per sq. yd.
Battleship Linoleum—available to Army and Navy only—1/8"—\$1.75 sq. yd.
3/8"—\$2.00 sq. yd.
Terrazzo Floors—50c to 70c per square.
Terrazzo Steps—\$1.75 per lin. ft.
Mastic Wear Coat—according to type—20c to 35c.

Hardwood Flooring—
Standard Mill grades not available.
Victory Oak—T & G
3 1/2 x 2 1/4".....\$143.25 per M. plus Cartage
1/2 x 2".....122.00 per M. plus Cartage
1/2 x 1 1/2".....113.50 per M. plus Cartage
Prefinished Standard & Better Oak Flooring
3 1/2 x 3 1/4".....\$180.00 per M. plus Cartage
1/2 x 2 1/2".....160.50 per M. plus Cartage
Maple Flooring
3 1/2" T & G Clear \$160.50 per M. plus Ctg.
2nd 153.50 per M. plus Ctg.
3rd 131.25 per M. plus Ctg.
Floor Layers' Wage, \$1.50 per hr.

GLASS—

Single Strength Window Glass 20c per □ ft
Double Strength Window Glass 30c per □ ft
Plate Glass, under 75 sq. ft. \$1.00 per □ ft.
Polished Wire Plate Glass 1.40 per □ ft.
Rgh. Wire Glass 34 per □ ft.
Obscure Glass 27 per □ ft
Glazing of above is additional.
Glass Blocks \$2.50 per □ ft. set in place

HEATING—

Average, \$1.90 per sq. ft. of radiation, according to conditions.
Warm air (gravity) average \$48 per register.
Forced air, average \$68 per register.

IRON—Cost of ornamental iron, cast iron, etc., depends on design.

LUMBER—All lumber at O.P.A. ceiling prices—

No. 1 Common	\$49.00 per M
No. 2 Common	47.75 per M
Select O. P. Common	52.75 per M

Flooring—

	Delvd	
V.G.-D.F. B & 8tr. 1 x 4 T & G Flooring	\$80.00	
C 1 x 4 T & G Flooring	75.00	
D 1 x 4 T & G Flooring	65.00	
D.F.-S.G. B & 8tr. 1 x 4 T & G Flooring	61.00	
C 1 x 4 T & G Flooring	59.00	
D 1 x 4 T & G Flooring	54.00	
Rwd. Plastic—"A" grade, medium dry	82.00	
"B" grade, medium dry	78.50	

Plywood—

	Under \$200	Over \$200
"Plyscord"— $\frac{3}{8}$ "	\$49.50	\$47.55
"Plywall"— $\frac{1}{4}$ "	45.15	43.30
3 ply— $\frac{2}{8}$ / $\frac{1}{4}$ "	48.55	46.60
"Plyform"— $\frac{3}{8}$ "—		
Uncoiled	126.50	121.45
Oiled	127.90	122.75

Above prices delivered if quantity is sufficient to warrant delivery.

Shingles (Rwd. not available)—

Red Cedar No. 1—\$6.75 per square; No. 2, \$5.75; No. 3, \$4.45.
 Average cost to lay shingles, \$3.00 per square.
 Cedar Shakes—Tapered: $\frac{1}{2}$ " to $\frac{3}{4}$ " x 25"—\$8.95 per square.
 Resawn: $\frac{3}{4}$ " to $1\frac{1}{4}$ " x 25"—\$10.65 per square.
 Resawn: $\frac{3}{4}$ " to $1\frac{1}{4}$ " x 25"—\$10.65 per square.
 Average cost to lay shakes, \$4.00 per square.

MILLWORK—Standard.

O. P. \$100 per 1000. R. W. rustic \$100.00 per 1000 [delivered].
 Double hung box window frames, average with trim \$6.50 and up, each.
 Complete door unit, \$10.00.
 Screen doors, \$3.50 each.
 Patent screen windows, 25c a sq. ft.
 Cases for kitchen pantries seven ft. high, per lineal ft., \$9.00 each.
 Dining room cases, \$9.00 per lineal foot.
 Rough and finish about 80c per sq. ft.
 Labor—Rough carpentry, warehouse heavy framing (average), \$40.00 per M.
 For smaller work average, \$40.00 to \$55.00 per 1000.

MARBLE—See Dealers)

PAINTING—

Two-coat work	per yard 50c
Three-coat work	per yard 70c
Cold water painting	per yard 10c
Whitewashing	per yard 8c

PAINTS—

Two-coat work	50c per sq. yd.
Three-coat work	70c per sq. yd.
Cold water painting	per yard 10c
Whitewashing	8c per sq. yd.
Turpentine	\$1.03 per gal. in drum lots.
	\$1.08 per gal. in 5-gal. containers.
Raw Linseed Oil	—not available.

Boiled Linseed Oil—\$1.38 per gal. in drums. Available only to work with high priority—\$1.48 per gal. in 5-gal. containers.

Use replacement oil—\$1.86 per gal. in 1-gal. containers.

Replacement Oil—\$1.20 per gal. in drums. \$1.30 per gal. in 5-gal. containers. A deposit of \$6.00 required on all drums.

PATENT CHIMNEYS—

6-inch	\$1.20 lineal foot
8-inch	1.40 lineal foot
10-inch	2.15 lineal foot
12-inch	2.75 lineal foot

PLASTER—

Neat wall, per ton delivered in S. F. in paper bags, \$17.60.

PLASTERING (Interior)—

3 Coats, metal lath and plaster	Yard 1.50
Keene cement on metal lath	1.80
Ceilings with $\frac{3}{4}$ " hot roll channels metal lath (lath only)	1.20
Ceilings with $\frac{3}{4}$ " hot roll channels metal lath plastered	2.20
Single partition $\frac{3}{4}$ " channel lath 1 side (lath only)	1.20
Single partition $\frac{3}{4}$ " channel lath 2 inches thick plastered	3.20
4-inch double partition $\frac{3}{4}$ " channel lath 2 sides (lath only)	2.20
4-inch double partition $\frac{3}{4}$ " channel lath 2 sides plastered	3.85
Thermax single partition; 1" channels; $2\frac{1}{4}$ " overall partition width. Plastered both sides	3.30
Thermax double partition; 1" channels; $4\frac{3}{4}$ " overall partition width. Plastered both sides	4.40
3 coats over 1" Thermax nailed to one side wood studs or joists	1.65
3 coats over 1" Thermax suspended to one side wood studs with spring sound isolation clip	1.90
Note—Channel lath controlled by limitation orders.	

PLASTERING (Exterior)—

2 coats cement finish, brick or concrete wall	Yard \$1.00
3 coats cement finish, No. 18 gauge wire mesh	2.00
Lime—\$3.00 per bbl. at yard.	
Processed Lime—\$3.10 bbl. at yard.	
Rock or Grip Lath— $\frac{3}{8}$ "—20c per sq. yd.	
" $\frac{1}{2}$ "—19c per sq. yd.	

Composition Stucco—\$1.80 to \$2.00 sq. yard [applied].

PLUMBING—

From \$100.00 per fixture up, according to grade, quantity and runs.

ROOFING—

"Standard" tar and gravel, 4 ply—\$3.00 per sq. for 30 sqs. or over.
 Less than 30 sqs. \$9.50 per sq.
 Tile, \$30.00 to \$40.00 per square.
 Redwood Shingles, \$7.50 per square in place.
 5/2 #1-16" Cedar Shingles, $4\frac{1}{2}$ " Exposure \$9.00 square

5/8 x 16"—#1 Cedar Shingles, 5" Exposure \$9.00 square
 4/2 #1-24" Royal Shingles, $7\frac{1}{2}$ " Exposure \$9.50 square
 Re-coat with Gravel \$4.00 per sq.
 Asbestos Shingles, \$23 to \$28 per sq. laid.
 1/2 x 25" Resawn Cedar Shakes, 10" Exposure \$10.50
 3/4 x 25" Resawn Cedar Shakes, 10" Exposure 11.50
 1 x 25" Resawn Cedar Shakes, 10" Exposure 12.50
 Above prices are for shakes in place.

SHEET METAL—

Windows—Metal, \$1.75 a sq. ft.
 Fire doors (average), including hardware \$2.00 per sq. ft.

SKYLIGHTS—(not glazed)

Copper, 90c sq. ft. (flat).
 Galvanized iron, 40c sq. ft. (flat).
 Vented hip skylights 60c sq. ft.

STEEL—STRUCTURAL (None available except for defense work).

\$150 ton (erected), this quotation is an average for comparatively small quantities. Light truss work higher. Plain beams and column work in large quantities \$140 per ton.

STEEL REINFORCING (None available except for war work).

\$150 to \$200 ton, set.

STONE—

Granite, average, \$6.50 cu. foot in place.
 Sandstone, average Blue, \$4.00. Boise, \$3.00 sq. ft. in place.
 Indiana Limestone, \$2.80 per sq. ft. in place.

STORE FRONTS (None available).

TILE—

Ceramic Tile Floors—70c to \$1.00 per sq. ft.
 Cove Base—\$1.10 per lin. ft.
 Glazed Tile Wainscot—\$1.25 per sq. ft.
 Asphalt Tile Floor $\frac{1}{8}$ " & $\frac{3}{8}$ "—\$.18 to \$.35 per sq. ft. Light shades slightly higher.
 Cork Tile—\$.40 to \$.75 per sq. ft.
 Mosaic Floors—see dealers.
 Lino-Tile, \$.35 to \$.75 per sq. ft.

Wall Tile—

Glazed Terra Cotta Wall Units (single faced) laid in place—approximate prices:	
2 x 6 x 12.....	\$1.10 sq. ft.
4 x 6 x 12.....	1.25 sq. ft.
2 x 8 x 16.....	1.20 sq. ft.
4 x 8 x 16.....	1.40 sq. ft.

VENETIAN BLINDS—

40c per square foot and up. Installation extra.

WINDOWS—STEEL—

30c per square foot, \$5 for ventilators.

ROLAND E. COATE, A.I.A., has moved his office from the Union Bank Building, Los Angeles, to 1255 Shenandoah Road, San Marino, California.

DOLLAR VOLUME of building construction increased in Seattle, Portland and San Francisco during the month of December, according to Western Building's Monthly Statistical Survey of building activity in the eleven western states and British Columbia.

The 181 reporting cities have a total construction volume for December of \$11,246,227, as against a December 1943 volume of \$22,143,871.

25 LEADING CITIES

	Dec., 1944	Nov., 1944	Dec., 1943
Los Angeles	\$1,952,352	\$2,865,088	\$5,462,357
Seattle	697,495	631,314	1,480,041
Portland	563,255	215,865	2,752,460
San Francisco	532,967	506,501	935,886
Long Beach	464,815	1,301,170	530,740
Vancouver, B.C.	413,350	819,035	449,325
Bakersfield	382,348	59,885	30,264
Yakima	372,360	40,325	3,725
Salt Lake City	300,687	174,855	340,334
Phoenix	284,405	348,954	41,149
Oakland	268,461	341,265	1,202,632
Denver	258,330	513,965	143,310
Brigham	245,200	24,400	18,300
San Diego	243,916	348,486	451,645
Newport Beach	170,540	67,140	16,180
Victoria, B.C.	164,907	87,350	112,349
Spokane	144,852	144,559	960,992
San Jose	133,050	33,680	56,230
Santa Ana	119,806	139,986	25,414
Berkeley	114,426	78,267	417,266
Tacoma	106,335	103,094	432,330
Compton	102,717	73,990	169,900
Longview	100,080	10,715	68,965
Pomona	93,392	36,710	54,368
Santa Monica	89,606	87,613	312,121

8,319,652 9,053,312 16,468,283

Read building blueprints



quickly accurately

Here is a book to give men in the building trades an intensive training in blueprint reading. Covers the building trades as a whole and is organized on the self-instruction, question - and - answer plan.

Just Out!

BLUEPRINT READING for the BUILDING TRADES

By Joseph E. Kenney

Architect; Instructor in Drafting, South Boston High School

100 pages, 8 1/2 x 11, \$2.00

This book explains what blueprints are, their importance, how the architect prepares working drawings, who uses them, and how to go about learning to read them. It shows the meaning and use of the various symbols and conventions and how they fit into the working drawings for an entire building.

ORDER A COPY FROM ARCHITECT AND ENGINEER 68 Post Street, San Francisco, 4

Following the awards of more sub-contracts in January, revived activity will be seen at Letterman Hospital in San Francisco.

N. CLARK AND SONS

Manufacturers of

Quality Architectural Clay Products

During this stage of the war, our principal energy is to manufacture products required by the various war agencies. We still can supply some pre-war materials for civilian needs.



401 PACIFIC AVENUE ALAMEDA, CALIFORNIA

San Francisco • Los Angeles Salt Lake City • Portland

1945 BUILDING TRADES WAGE SCALES (JOB SITES) NORTHERN CALIFORNIA

Six- and seven-hour day eliminated on all Government Work. A.F.L. - O.P.M. Agreement calls for eight-hour day.

NOTE: Predeterminations by the Department of Labor, as of July 1, 1944 (the wage-freezing date) have not yet been made in all of the counties listed. The wage scales shown are those being paid and in effect mostly by agreement between employers and their union.

CRAFT	Alameda and Contra Costa		Fraser	Marin	Sacramento	San Jose	San Mateo	Vallejo	Stockton
	San Francisco								
ASBESTOS WORKERS	1.50	1.50	1.25	1.50	1.50	1.25	1.50	1.50	1.25
BRICKLAYERS	1.87 1/2	1.87 1/2	1.75	1.87 1/2	1.75	2.00	1.75-1/8	1.75	1.58
BRICKLAYERS, HODCARRIERS	1.40	1.40	1.05	1.40	1.05	1.50	1.35	1.50	1.14
CARPENTERS	1.50	1.50	1.25	1.43 1/4	1.37 1/2	1.43 1/4	1.50	1.37 1/2	1.50
CEMENT FINISHERS	1.50	1.50	1.50	1.50	1.50	1.50	1.50	1.50	1.50
ELECTRICIANS	1.70	1.70	1.70	1.70	1.70	1.70	1.70	1.70	1.70
ELEVATOR CONSTRUCTORS	1.75 1/2	1.75 1/2	1.75 1/2	1.75 1/2	1.75 1/2	1.75 1/2	1.75 1/2	1.75 1/2	1.75 1/2
ENGINEERS: MATERIAL HOIST	1.50	1.50	1.25	1.50	1.37 1/2	1.62 1/2	1.50	1.37 1/2	1.25
PILE DRIVER	1.75	1.75	1.60	1.75	1.75	1.75	1.75	1.75	1.60
STRUCTURAL STEEL	1.75	1.75	1.60	1.75	1.75	1.75	1.75	1.75	1.60
PAINTERS	1.40	1.40	1.12 1/2	1.40	1.12 1/2	1.21	1.40	1.40	1.60
IRONWORKERS: ORNAMENTAL	1.60	1.50	1.60	1.50	1.60	1.31 1/4	1.50	1.50	1.50
REINF. RODMEN	1.50	1.50	1.60	1.50	1.50	1.60	1.50	1.50	1.25
STRUCTURAL	1.75	1.75	1.75	1.75	1.75	1.75	1.75	1.75	1.37 1/2
LABORERS: BUILDING	1.00	1.00	.90	.87 1/2	.95	.90	.93 1/4	.90	.90
CONCRETE	1.00	1.00	.90	.87 1/2	.95	.90	.93 1/4	.95	1.00
LATHERS	1.75	1.75	1.50	1.75	1.60	1.75	1.75	1.75	1.75
MARBLE SETTERS	1.50	1.50	1.80	1.50	1.50	1.50	1.50	1.50	1.50
MOSAIC & TERRAZZO	1.25	1.25	1.12 1/2	1.25	1.15 5/8	1.12 1/2			
PLASTERERS	1.50	1.50	1.28-1/7	1.50	1.45	1.50	1.42-6/7	1.44-2/7	1.37 1/2
PILEDRIEVERS	1.54	1.54	1.54	1.54	1.54	1.54	1.54	1.54	1.54
PLASTERERS	1.75	1.83 1/2	1.75	1.75	1.75	2.00	1.75	1.83-1/3	1.83-1/3
PLASTERERS' HODCARRIERS	1.50	1.60	1.40	1.50	1.18 1/4	1.50	1.25	1.50	1.50
PLUMBERS	1.70	1.70	1.53-1/8	1.70	1.68 1/4	1.62 1/2	1.70	1.70	1.50
ROOFERS	1.50	1.50	1.25	1.37 1/2	1.37 1/2	1.37 1/2	1.37 1/2	1.37 1/2	1.37 1/2
SHEET METAL WORKERS	1.50	1.50	1.50	1.50	1.50	1.50	1.37 1/2	1.50	1.50
SPRINKLER FITTERS	1.58	1.58	1.53-1/8	1.70	1.68 1/4	1.42 1/2	1.70	1.70	1.50
STEAMFITTERS	1.75	1.75	1.53-1/8	1.70	1.68 1/4	1.62 1/2	1.50	1.70	1.50
STONESETTERS (MASONS)	1.87 1/2	1.87 1/2	1.75	1.75	1.75	1.50	1.75	1.75	1.50
TILESETTERS	1.50	1.50	1.37 1/2	1.50	1.37 1/2	1.50	1.50	1.50	1.37 1/2

Prepared and compiled by

CENTRAL CALIFORNIA CHAPTER, ASSOCIATED GENERAL CONTRACTORS OF AMERICA

with the assistance and cooperation of secretaries of General Contractors Associations and Builders Exchanges of Northern California.

JOHN CASSARETTO COMPANY

—Since 1886—And Still Active—

Building Materials

READY MIX CONCRETE
ROCK - SAND - GRAVEL - LIME
CEMENT - PLASTER - MORTAR
METAL LATH - WOOD LATH
STUCCO - WIRE NETTING

Service Unexcelled

Bunkers
Sixth and Channel, San Francisco
Phones: GARfield 3758 - 3760

IN THE NEWS

NEW PRODUCTS AND PRACTICES

A BOON TO ARCHITECTS who type their own specifications or, in any way find it necessary to blueprint any of their typing, is the new "ORANGE" colored blueprint ribbon.

It obviates the necessity of using a carbon on the back of the typed sheet to get a good print. It is now being used by many firms. While made in the east, it can be purchased only from the M. K. S. Company at 681 Market Street in San Francisco. It is really a time and trouble saver and works on every kind of paper.

STEEL REPLACES CORD AND FABRIC

Reputed to be the greatest advance in the last two decades in transmission belts, a new Compass-250 belt which utilizes steel cables instead of cord or fabric for the carcass has been perfected by The Goodyear Tire and Rubber Company.

Special twisted, finely stranded, high tensile steel wire which is 50 per cent twisted to the right and 50 per cent to the left, thereby insuring a neutralized, true running belt, is encased in an envelope of non-load carrying fabric.

Advantages of the new belt were described by company officials as "practically unbreakable", better life under varying climatic conditions, and "strength to spare even under terrific shock loads."

HENRY C. COLLINS, Architect, has moved his office from 502 Underwood Building, San Francisco, to 9 Argon Boulevard, San Mateo, California. In the days when he handled so much of the architectural problems of the San Francisco Housing Authority he could not have moved so far from Market Street.

ANDERSON & RINGROSE

General Contractors

320 Market Street, San Francisco
Phone GARfield 2245

MULLEN MFG. COMPANY

BANK, STORE AND OFFICE
FIXTURES—CABINET WORK
OF GUARANTEED QUALITY
CHURCH SEATING

Office and Factory:
60-80 RAUSCH ST., 8th, 7th and 8th Sts.
San Francisco
Telephone UNderhill 5815

THE TORMEY COMPANY

GENERAL PAINTERS
AND DECORATORS

Phone UNderhill 1913

563 FULTON STREET
San Francisco

G. P. W. JENSEN & SON

Building Construction

320 Market Street, San Francisco
Phone: GARfield 2444

DINWIDDIE CONSTRUCTION COMPANY

BUILDERS

CROCKER BUILDING
SAN FRANCISCO



HERRICK IRON WORKS

STRUCTURAL STEEL
REINFORCING STEEL

18TH AND CAMPBELL STS.
OAKLAND, CALIF.
Phone GLencourt 1767

Phone GARfield 1164

Thomas B. Hunter

Consulting Engineer

DESIGNER OF HEATING
AIR CONDITIONING
VENTILATING AND WIRING
SYSTEMS, MECHANICAL
AND ELECTRICAL EQUIP-
MENT OF BUILDINGS

41 SUTTER STREET
ROOM 710
San Francisco California

ARCHITECT AND ENGINEER

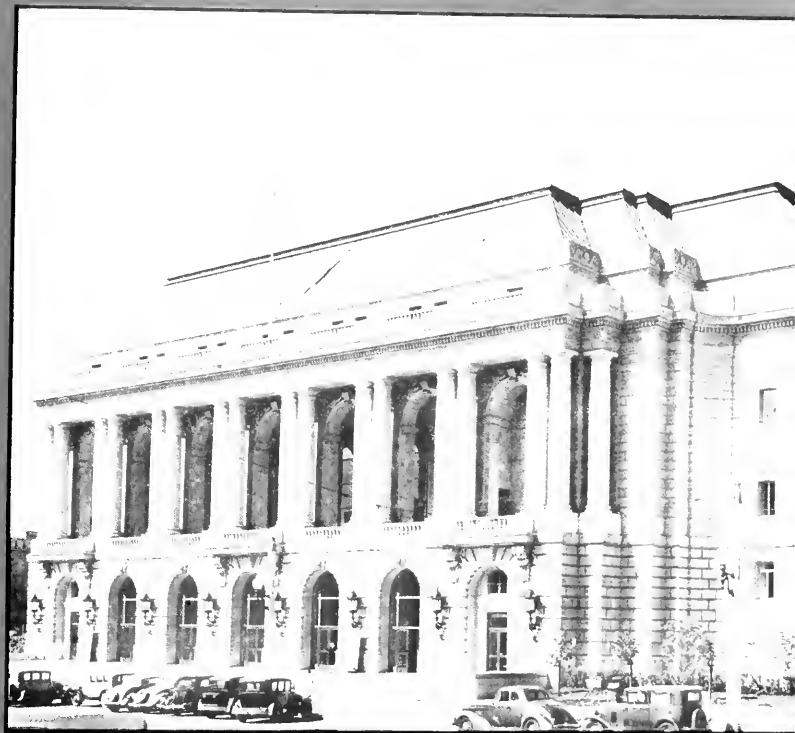

APRIL

1945

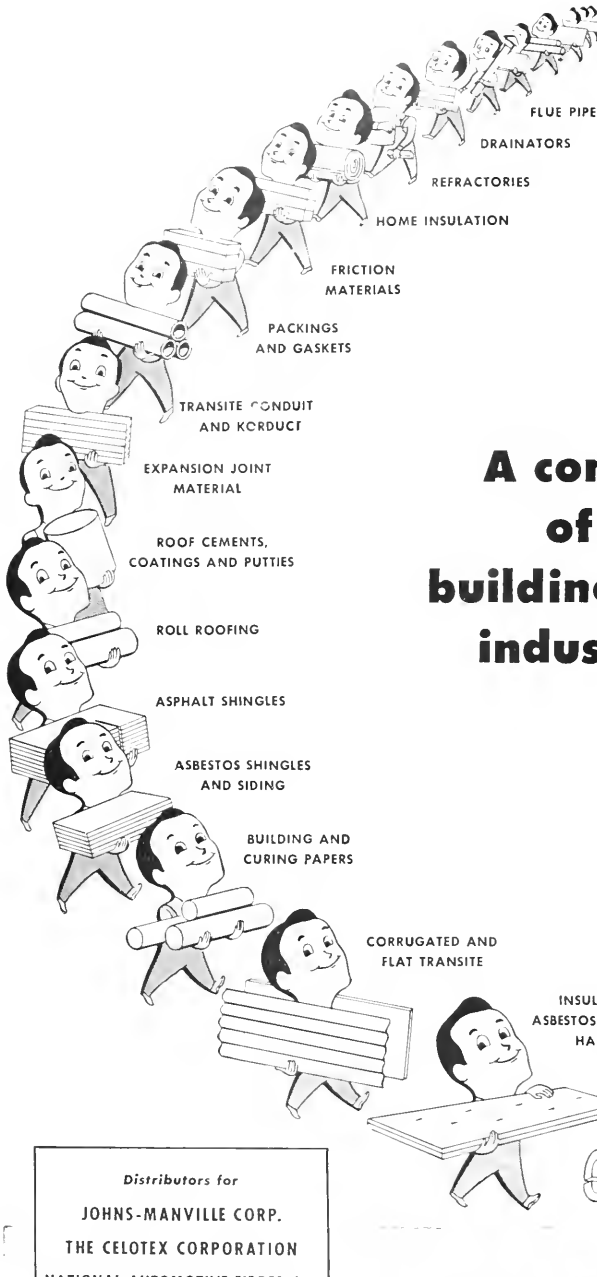

FLUE PIPE

DRAINATORS

REFRACTORIES

HOME INSULATION

FRICTION MATERIALS

PACKINGS AND GASKETS

TRANSITE CONDUIT AND KORDUCT

EXPANSION JOINT MATERIAL

ROOF CEMENTS, COATINGS AND PUTTIES

ROLL ROOFING

ASPHALT SHINGLES

ASBESTOS SHINGLES AND SIDING

BUILDING AND CURING PAPERS

CORRUGATED AND FLAT TRANSITE

INSULATING BOARDS
ASBESTOS-CEMENT BOARDS
HARD BOARDS

INSULATING MATERIALS FOR PIPING, BOILERS, INDUSTRIAL EQUIPMENT AND REFRIGERATION

Distributors for
JOHNS-MANVILLE CORP.
THE CELOTEX CORPORATION
NATIONAL AUTOMOTIVE FIBRES, INC.
THE COE MANUFACTURING CO.
ANGIER CORPORATION

A complete source of supply for building materials and industrial products

WESTERN ASBESTOS CO.
Building Materials · Industrial Products

• ARCHITECT

Vol. 161

No. 1

AND
ENGINEER

ARCHITECTS' REPORTS—Published Daily

MARK DANIELS
Editor

E. H. WILDER
Associate Editor

MICHAEL GOODMAN
Post-War Planning

L. H. NISHKIAN
Consulting Editor

E. N. KIERULFF*
Ass't Editor
*In the Service

★
Contents for

APRIL

COVER: The San Francisco Opera House

ARTICLES AND MISCELLANEOUS TEXT

	Page
RUNNING FIRE	4
NEWS AND COMMENT ON ART	6
HIGH-FIRED MONOCHROMES	6
By CHINGWAH LEE	
SAN FRANCISCO'S WORLD FAMED CITY HALL	10
SAN FRANCISCO, CENTER OF WORLD TRADE	11
RECONSTRUCTION OF PORTSMOUTH, ENGLAND	16
THE GREATER LONDON PLAN	18
IN THE NEWS	20-34-35-37-41-42
COREOPSIS COTTAGE, CARMEL	21
By ANGELO HEWETSON	
OLD WHALING STATION, MONTEREY	22
By ANGELO HEWETSON	
THE FAMOUS BAILEY BRIDGES	23
NEW ALUMINUM FLOATING BRIDGE FOR U. S. ARMY	26
HOW BRITAIN WILL SOLVE HOUSING SHORTAGE	27
By PHILIP MURRAY	
COLOTYLE BATHROOM DESIGN WINNERS	31
TREES IN ARCHITECTURAL RENDERING	33
WITH THE ENGINEERS	36
A. I. A. ACTIVITIES	37
PRODUCERS COUNCIL PAGE	40
BOOK REVIEWS	41
ESTIMATOR'S GUIDE	43
INDEX TO ADVERTISERS	48

★
ARCHITECT AND ENGINEER (Established 1905) is published on the 15th of the month by The Architect and Engineer, Inc., 68 Post St., San Francisco. President, K. P. Kierulff; Vice-President and Manager, L. B. Penhorwood; Treasurer, E. N. Kierulff; Advertising Manager, V. E. Atkinson, Jr.

Los Angeles Office: 403 W. 8th Street.

Entered as second class matter, November 2, 1905, at the Post Office in San Francisco, California, under the Act of March 3, 1879. Subscription United States and Pan America, \$3.00 a year; \$5.00 two years; foreign countries \$5.00 a year; single copy 50c. ARCHITECTS' REPORTS are published daily from this office, Vernon S. Yallop, Manager.



RUNNING FIRE — by MARK DANIELS

SLIP-COVERS

There are many kinds of slip-covers; those that hide the form, those that disguise the truth and those to disguise ignorance, or those to cover dirty clothes or dirty intentions. Now, it seems, we have a new one, the 'architectural slip-cover.' But, after all, it's not so new. Slip-covers, as such, are handy. If you want to be a savant and can't quite make it, just pull on your slip-cover, and possibly a gray beard, and try again.

The February issue of the ARCHITECT AND ENGINEER carried an article by Jan Reiner entitled "What Is Modern Architecture," which had passages that aroused the ire and antagonism of some of our leading architects, a feeling with which I, personally, am in accord. In discussing Mr. Reiner's article with one very scholarly architect whose work has not been seen in this country very much of late, and whom I asked to write to me expressing his views, it developed that he felt that so much of the article was incorrect that any comment would be unnecessary for those readers who knew anything at all about architecture, or were familiar to any extent with Greek architecture in particular.

There were paragraphs in particular to which objections have been made. I quote them. "There are still some architects—and they are mostly official ones—who think in terms of stone facades, center lines, etc. To them the Facade is a slip-cover, tailored over the skeleton of an otherwise contemporary building. Perhaps one should not judge them too harshly, for the Greek architects did the same thing and influenced the world for almost two thousand years.

"The architectural vocabulary of a Greek temple was devised from wood construction: centuries later, when stone made the temples fire-proof, the original wooden appearance was transferred into stone, and it was a 'hit.' It may be that our contemporary 'appeasers' are designing slip-covers, in the hope that their work will one day become a 'hit.' (The new Administration Building, University of California, just to mention an example.)"

The implication of these two paragraphs seems to be that the facade of a Greek Temple did not represent the architecture of its own day, but was a sort of "slip-cover" imposed over the real structure—that the facades of a Greek Temple did not represent the actual building.

Nothing could be farther from the truth. Not only was the Greek Temple always an integral part of the tradition of its day, but it was also one of the most perfect examples of functional archi-

ture that has ever been produced. It represented a temple and nothing else, and was so perfectly suited to the needs and requirements of the temple that its architectural scheme remained virtually unchanged for centuries.

Whatever the origin of the design may have been it had become a perfect expression of the stone and marble, the material used in its construction. So integral was the design with the structure and so much an expression of the materials, that even the ruins of these temples retain the essential idea embodied in them when they were first built.

As to the selection of the Administration Building to point a finger at, free of ulterior motive or not, I feel that I have a slight right to take exception, for in the November issue of 1942 I wrote to some extent on the charm of that building. Whether it is a "slip-cover" building (and heaven only knows just what Mr. Reiner means by that, for I am sure he doesn't) why pick out any single building on the campus of the University of California when all of them are substantially the same style? Why not point to the whole world of the past hundred years for they would furnish equally good illustrations for this chimerical point of view.

In extenuation I would like to point out that many a good article is sacrificed upon the altar of a "bon mot," and I fear that when Mr. Reiner hit upon the "slip-cover" idea he was so taken with it that he pulled one over his own head.

FINANCIAL TRANSACTIONS

When I was a youngster it always fascinated me to watch in wonder the lines of depositors leaving their money at the counters of the banks. It still does, although the wonder has changed to envy. Nowadays one can watch a more complicated financial transaction by observing an elderly woman trying to pay her exact cash fare on a street car. One nickel and two pennies, no more and no less. Three coins that must be unscrambled from the contents of a bag only slightly smaller than a crib. The English "tupence" would be a blessing by reducing the labor of searching for coins. Certainly a nickel and one two-penny piece would save time. In the bank they write in your book that you have left your money there, but on the car when your money drops into the trap that keeps the conductors happy it is gone for keeps. Your only satisfaction is to get a transfer, not as a receipt, but as evidence of payment. Undoubtedly that is why most women take one.

Cooling Tower on Wheels



↑ Completed Foster Wheeler built cooling tower car ready for coupling to rest of power train.

Cooling tower framing with outer sheathing partly applied. Note TECO Connectors are used for joining framing at corners and diagonals. Tower built by Foster Wheeler Corporation, New York. →

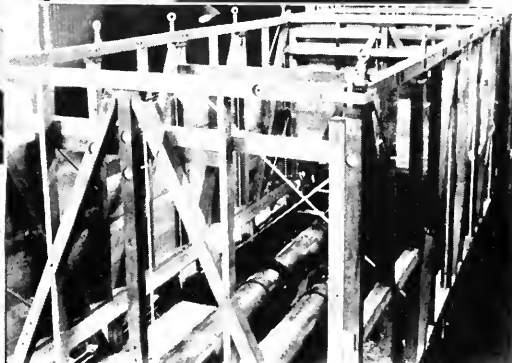

A mobile power and light plant for use in war devastated areas was needed. General Electric Company engineers designed a mobile train to meet the situation. These trains are able to generate power independent of local sources of water, fuel or other necessities. Units of various capacities are built to meet local conditions. One type, the 3000 k.w. train, is equipped with three cooling tower cars with a capacity of 5000 g.p.m.

A 1000 k.w. train has but one cooling tower car.

These cooling towers are pre-fabricated by the Foster Wheeler Corporation with TECO Connectors; match-marked, dis-assembled and shipped abroad, where they are quickly put together again.

In war work or in post-war planning, TECO Connectors play a vital part in timber construction jobs in all fields.

Watch for announcement of the newest TECO book—The Forest Industries Blaze New Trails.

Timber Engineering Co. Inc. of Washington, D. C.

Monadnock Building, 681 Market Street, San Francisco • Telephone Garfield 6296

**SPECIFY TECO CONNECTORS
SPLIT RINGS • SHEAR PLATES
GROOVING TOOLS**

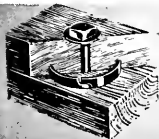

KEEP ME POSTED

Alden K. Smith,
Monadnock Building
681 Market St., San Francisco

AE

Put my name on your mailing list.

Name _____

Firm _____

Business _____

Street _____

City _____ State _____



A GROUP OF MONOCHROMES of the Ch'ing dynasty, left to right: Squat vase with a brilliant crackled apple green glaze, cabinet vase with Lang yao or ox-blood glaze, peach blow vase with dragon relief, camelia-leaf green bottle with the fish-roe crackles, and a clare de lune brush-washer with design faintly incised in the porcelain body.

Author's Collection, in the Old Chinatown Museum

High-Fired MONOCHROMES

By CHINGWAH LEE

The Ching-te Chen potters of the seventeenth and eighteenth century reproduced practically all the earlier monochromes and also developed many which are essentially their own. Some of the most sought-after monochromes were fired in the full heat (*grand feu*) of the kilns.

The ying pai (pure white) and t'ien pai (luscious or warm white), although generally after the style of the white Ting, took on new forms and new styles of decoration, and the same is true of the Fen Ting of this period. The production of white eggshell porcelain was inspired by the t'o t'ai

ya-shou pei (bodiless hand-fitting cup) of the Yung Lo period, a thinly made creamy-white bowl of the t'ien pai class. In general, the ying pai are milky white while the t'ien pai approaches the Te Hua white which are creamy and of a lard-like thickness. White wares are generally decorated with incised, engraved or carved decoration done in the most delicate manner.

White biscuit porcelain are few in number. Some mortar and pestles and covered inkstones are of biscuit porcelain, the latter usually decorated on the border with a few designed in mat-black.

NEWS AND COMMENT ON ART

Figurines of deities and animals are also decorated, the eyes and mouth decorated with black or dry coral red. A type called fan tzu (furner porcelain) consists of bottles or figurines glazed inside but unglazed on the outside. These were used by sleight-of-hand artists who managed to throw a normally glazed ware into the air and retrieve it turned inside out. A type called chen chu yao (pearl decorated porcelain) has a biscuit body covered with dots of pearly white glaze, interspersed here and there with floral or archaic word tracery in the same pearly white slip. Biscuit vases and covered boxes with elaborate carving in relief or openwork and intricate bird cages and pagodas with minute relief decoration were made in fairly large number in the early years of the Republic.

There are a host of high-fired brown and black glazes which are faint reminders of the temmoku glazes in that the two colors are closely linked together. Golden-brown (tzu chin) is known to the early European importers as "Batavian" ware, and has many shades, ranging from old gold or Nanking yellow to an olive-brown which is not unlike the olive colored celadon and which is often crackled. Other names indicative of some of the tones are chamois, cafe-au-lait, chocolate, and feuille morte or dead-leaf brown. The lighter shades are known as chin Huang (golden yellow).

The mirror black is known in China as wu chin or golden black. This glaze originated during the Ming dynasty and has a thick, dense brown-black glaze. By K'ang Hsi time new types are developed, including some with metallic sheen and some which is thinly flecked with tea-dust. But the best of the wu chin, a highly lustrous, slightly translucent brown-black, is often given the specific name wu ching (mirror black). These are usually decorated with golden tracteries (miao chin) and less often, silver tracteries (miao yin). Mirror black with white slip design is called hei-ti pai-hua (white decoration on black). Other blacks are of the lower fired type (see below).

Another temmoku-like glaze is the iron rust, a russet-brown to reddish black glaze with crystalline or metallic speck (t'ieh siu hua) formation. Sometimes the specks take on a golden or coppery sheen, when it is known as chin siu hua (gold flecking) and tun siu hua (copper flecking).

The celadons of Ching-te Chen, unlike their Sung prototypes, have a white porcelain body. The foot-rim is often dressed with a black or brown slip to imitate the Sung wares. They are then

(See Page 8)

THE DE YOUNG MEMORIAL Golden Gate Park is presenting an unusual interest from April 7 to May 1 year. It comprises a series of original portraits of United Nations' Leaders which portraits were originally painted for the covers of Time Magazine.

The plan seems to be a most excellent one and one that will give the people an opportunity to see all these portraits of our great men at one time as well as to see many that we might have missed on the covers of the magazine. Further, with several thousand visitors, many from foreign lands, in conference on matters over which the originals of these portraits exerted the greatest influence, nothing could be more appropriate or timely.

The thought to exhibit these portraits was formulated before the intention to hold the Conference in San Francisco was conceived. As a result some portraits other than the sixty or so actual leaders, were added which really increase the interest of the Exhibit, since they are all of men of importance in the war effort.



GENERAL DWIGHT D. EISENHOWER

by GUY ROWE

On exhibition at the de Young Memorial Museum

referred to as being "iron boned" (t'ieh ku) or "copper boned" (t'ieh ku). A very pale celadon is sometimes called *clare de lune* (yueh pai), although it is more often referred to as t'ien ch'ing (sky blue-green) or luan ch'ing (duck eggshell blue-green). Successively deeper shades are known as tung ch'ing (winter green, a shade deeper than the pale blue-green of the ying ch'ing glaze), fen ch'ing (light blue-green) and tao ch'ing (pea green). Other names applied to celadons are hui se (grey), hui pai (grey-white), hui ch'ing (greyish blue-green), ts'ung ts'ui (onion-tip green), yu lu (oil green, a lustrous pea green), fen ts'ui (the forest-green of mountain tops; olive), and mi se which in this case stands for ch'ao mi se (the brown of roasted rice).

Many excellent high-fired reds were produced during the early part of the Ch'ing dynasty, especially during the K'ang Hsi period. There is a great deal of confusion in the nomenclature of the reds, and we shall attempt to clarify a few of the terms used as we go along.

The general term for all high-fired copper reds is *chi hung* (sacrificial red). Another *chi hung* (pronounced the same but written differently and meaning sky-clearing red) is sometimes used interchangeably. Still another *chi hung* (massed or concentrated red), popular as a general term during the Ming dynasty, has a more limited application today (see below).

The reds are divided at this time into two main types, the monochromes and the painted. The painted red or *rouge de cuivre* is called *yu-li hsien hung* (underglaze fresh red) and are again divided into two classes. Those penciled under the glaze, whether used alone or in combination with underglaze blue or enamels is called *yu li hung* (underglaze red). This red, when combined with an underglaze blue, is called "blue with brown" (ch'ing hua chi tzu) because it invariably takes on a greenish-brown or peach-blow tinge, and in fact, is called an underglaze peach-blow in the West.

Underglaze red painted in broad washes, although it was also called *pao shih hung* (precious stone red) by some writers in the past because of its gem-like quality, is now universally classified as a *hsien hung*. Typical examples of *hsien hung* are the white bowls or *tazza* cups with three fish, animals or fruit applied as broad washes, a type which originated during the Hsuen Te period. *Hsien hung* is sometimes applied to cover an entire vessel, thus bridging the painted variety with the monochrome. It is essentially a *chi hung* (massed red) and is so classified today.

The red monochromes are again of two kinds. The term *pao shih hung* (precious stone or ruby red) is now generally applied to a red monochrome of the ox-blood type. These have a thick glaze which often exhibits faint crackles and which is typically without any foreign colors, such as purple, blue or grey striation or splashes. There is no mark within the foot-rim because either the high temperature of the firing or the nature of the paste does not favor an underglaze blue mark. Some imperial specimens, however, have reign marks impressed into the biscuit.

The precious stone red of the K'ang Hsi period is called *Lang yao*, probably after a family of potters by that name. This wonderful monochrome is known to the West as *sang de boeuf* or ox-blood because the thick glaze with its minute particles of red pigment (which has a tendency to thin out at the top and thicken at the bottom like so many corpuscles) suggests a fresh blood which is coagulating near the foot-rim, but other shades are found: a limpid ruby, a bright cherry, a dappled crushed strawberry, a greyish ashes of rose, etc.

All *Lang yao* have certain characteristics in common: sharp ending of the glaze along the foot-rim, faint crackles in the glaze, a "skin-like" (See Page 32)

AT THE SAN FRANCISCO MUSEUM OF ART

I have a lurking suspicion that Dr. Grace McCann Morley, Director of the SAN FRANCISCO MUSEUM OF ART, was fully aware of the more than mere museum item interest behind the thought of the exhibit of the entrants in the Army Arts Contest. Certain it is that Major General Wm. E. Shedd realized that such an event transcended the mere displaying of paintings and drawings, remarkably good as they were. As the General put it, the purpose was "to stimulate the ever increasing awareness of the value of arts and crafts as one of the significant leisure time activities in the American Army . . ." and as such it was one of the best ventures any museum in this city has undertaken. Such events can be made of great importance and value to all the people.

Aside from the importance of the occasion the exhibits showed the work of many artists who were generally unknown and the number of visitors and their prolonged study was proof of an unusual interest. Most of the items showed a vitality that is often missing in the usual museum exhibit.

WINNERS!

COLOTYLE ARCHITECTURAL COMPETITION

GRAND PRIZE: \$500.00

A. ALBERT COOLING, 154 Acari Drive, Los Angeles, Calif.

FIRST PRIZE, REGION 1: \$250.00

HARRY K. WOLFE, 1048 E. 103rd St., Seattle, Wash.

FIRST PRIZE, REGION 2: \$250.00

GEORGE H. WARDNER, 911 Lewis Bldg., Portland, Oregon

FIRST PRIZE, REGION 3: \$250.00

BURWELL F. HAMRICK, 610 S. Parish Place, Los Angeles, Calif.

HONORABLE MENTION AWARDS, \$25.00 Each

J. SMITH BENNETT, Los Angeles, Calif.

H. R. KEMM, 123 Helenium Drive, W. Los Angeles, Calif.

FREDERICK HODGDON, 825 Plymouth Road, San Marino, Calif.

ROLF SKALREK, 853 N. Sierra Bonita, Los Angeles, Calif.

L. L. EVISON, 2851 Invale Drive, Verdugo City, Calif.

LOUIS A. DIXON, 10355 Lorenzo Drive, Los Angeles, Calif.

RALPH A. VAUGHN, 2171 W. 26th Place, Los Angeles, Calif.

MILTON CAUGHEY, 1772 Glendon Avenue, W. Los Angeles, Calif.

ROBERT L. DURHAM, 4th and Cherry Building, Seattle, Wash.

DONALD F. HISCOX, 706 Republic Building, Seattle, Wash.

... OUR SINCERE CONGRATULATIONS TO THEM ALL

Posing the problem of designing a Colotyle-wall bathroom for the modern home, this competition brought forth many interesting ideas for the bathroom of tomorrow. Full credit goes to each of the prize winners . . . and to each entrant . . . for his skill in designing a practical bathroom for the entire family . . . a bathroom for more than a single person. More than mere utility, however, was accomplished through the use of color . . . bright, cheerful colors of the Colotyle plastic-coated walls.

and to the eminent jury . . .

Our sincere appreciation for the time, study and diligence devoted to the selection of the winners. Hervey Parke Clarke, Victor N. J. Jones, Herman Brookman, Van Evera Bailey and Herbert Mann . . . all prominent architects . . . gave to each entry every consideration, and their decisions were well received. Robert McClelland, professional adviser, supervised the competition.

COLOTYLE CORPORATION

Largest Manufacturers of Prefinished Wallboard in the West

AURORA AT MERCER

SEATTLE 9, WASHINGTON



SAN FRANCISCO'S World Famed City Hall

Center of Governmental activities and "hub" of the "civic center." Location of City, County, State, and Federal office buildings. A portion of the "Opera House" is shown at the right, while on the left is seen a portion of the Veterans Memorial Building.

CENTER of WORLD TRADE

San Francisco - - A Peaceful City

THE SAN FRANCISCO OPERA HOUSE

Since it has been decided (up to date) that the first and last meetings of the April 25th conference shall be held in the Opera House, it may not be amiss to outline its development and the share it has played in the development of the Civic Center.

An opera house has always been the central feature of the plans for the development of a Civic Center around the City Hall. I quote from the November, 1932, issue of THE ARCHITECT AND ENGINEER: "The first proposed plan of October, 1899, to improve the City of San Francisco and establish a great group of monumental buildings at the City Hall (the central feature of which, by the way, was an Opera House) was conceived and made public on a full page of the 'Examiner' for October 8, 1899.

"The second plan, the present Civic Center as finally adopted, was made in 1904. . . ." From that date on, committees and boards were organized and appointed to make detailed studies and plans for the Civic Center. Finally the work was broken down into groups and architects were appointed to prepare plans for them. The War Memorial Group comprised the Veterans' Building and the Opera House. Arthur Brown, Jr., was appointed Chief Architect for the Group and Mr. G. Albert Lansburgh, Collaborating Architect, on the Opera House.

Arthur Brown, Jr., has been an indefatigable worker on the problems of San Francisco's Civic Center since its inception. As a member of the firm of Bakewell and Brown, architects for the City Hall, and since that association, Mr. Brown has done a considerable portion of the buildings (See Page 14)



WAR MEMORIAL BUILDING: The Veterans Building, the Opera House and the Plaza between constitute the War Memorial Group which is administered by a Board of Trustees.



Men of importance in the affairs of the Allies not all of whom will attend the San Francisco Conference in April.

Photos courtesy British Information Service



FEDERAL BUILDING
Civic Center, San Francisco

There are several "Federal Buildings" in the city. This one enjoys the distinction of having been designed by Arthur Brown, Jr. In the background is another Federally owned building, principally occupied by the Internal Revenue and the War Ordnance Departments. This beautiful building was designed by Lewis P. Hobart, Architect.



SAN FRANCISCO'S "LOOP"

Terminal for her Bay Bridge rail traffic.

SAN FRANCISCO

(From Page 11)

that go to make up the Civic Center. He has also done a number of very large buildings for the Federal Government, both here and in Washington, D. C. We of San Francisco feel that none of them surpasses the War Memorial Group.

There are a number of features incorporated on the structure that go to satisfy the adherents of the Beyreuth experiment. In addition to the depression of the orchestra to fifteen feet below the stage, strips of the stage floor about four feet wide can be raised to any height forming tiers for the accommodation of a great symphony or a huge chorus or for scenic spectacles. The acoustical properties have been approved and lauded by many experts and were the result of months of study by acoustical engineers which has resulted in the producer's ability to tell his artists to speak in whispers or sing in full voice and for the oboe to be heard as clearly as the tympani.

This was demonstrated at the first performance held in the Opera House at the opening performance on the evening of October 15, 1932, when Claudia Muzio sang in "La Tosca," and has been demonstrated in every performance since. Not a complaint was recorded from the 3302 seated attendants who filled the building with their plaudits.

The complaint has been made that \$3,500,000 is too much to spend (including land) on a theater, but not by the music lovers, who constitute the great majority of this music-loving city. Most of them feel that we could spend less on movie buildings and more on our municipal music and do still better. The same holds true of the Veterans' Building at a cost of \$3,000,000, including land.

Well, you from foreign lands, what do you think?

THE PICTURE ON THE COVER

The Opera House of the War Memorial Group in the City of San Francisco. Arthur Brown, Jr., Architect; Albert Lansburgh, collaborating Architect.

Since these words may be read by hundreds of people from foreign lands it might be in better taste to eschew bold, exaggerated statements, such as are heard from citizens of this country when they are abroad, and confine them to facts. Fact number one might be that the city is very lucky to have an architect like Mr. Brown to handle such a monumental project as the Opera House. For proof I refer you to "Who's Who in America." But to get to more facts, for there is not space to write all the interesting and romantic details of the Opera House and its relation to the story of the Civic Center.

The Opera House seats 3302 people facing one of (I say one of) the largest stages in the world. A few facts will substantiate this statement. The proscenium is fifty feet high and fifty-two feet wide. Behind it the gridirons rise to one hundred and sixteen feet, about twelve stories high. Wall to wall the stage area in toto measures one hundred and thirty-five feet and from proscenium to back wall is ninety feet. All of this is the best equipped stage in America.

But lest our guests from other countries fear that size was attained at the cost of strength and safety, it should be stated the stage is insulated from the balance of the building by concrete walls. In addition to the fire walls the steel work is thoroughly braced against lateral forces and the granite columns have steel cores.

As to the motifs of design and interior development, those are best left to be studied on the spot. Of course, it will be found that the Wagnerian innovation has had its effect. The orchestra pit has been depressed so that the conductor is substantially out of sight and the grand foyer has been replaced by a modest one, and an intimate foyer on the balcony floor.



★ **BUY** ★
WAR BONDS

**SEVENTH LOAN STARTS
MAY 14th—ENDS JUNE 30th
1945**

WAR BONDS HELP PAY
FOR THE BULLETS,
SHELLS AND BOMBS
THAT WILL SPEED
THE VICTORY

BUY YOUR WAR BONDS TODAY

BASALT ROCK COMPANY, INC.

NAPA, CALIFORNIA

Reconstruction of Portsmouth

CITY OF PORTSMOUTH REPLANNING: Scale model showing a portion of the cleared site in the center of the city awaiting post-war construction. In the center is the tower of the wrecked Town Hall. The model was produced in the city architect's department.

The City of Portsmouth Replanning Scheme shows the central area of the city which it is proposed to rebuild after the war on the site devastated during the big German raids of January 10, March 10, and April 27, 1941. (British Official Photo)

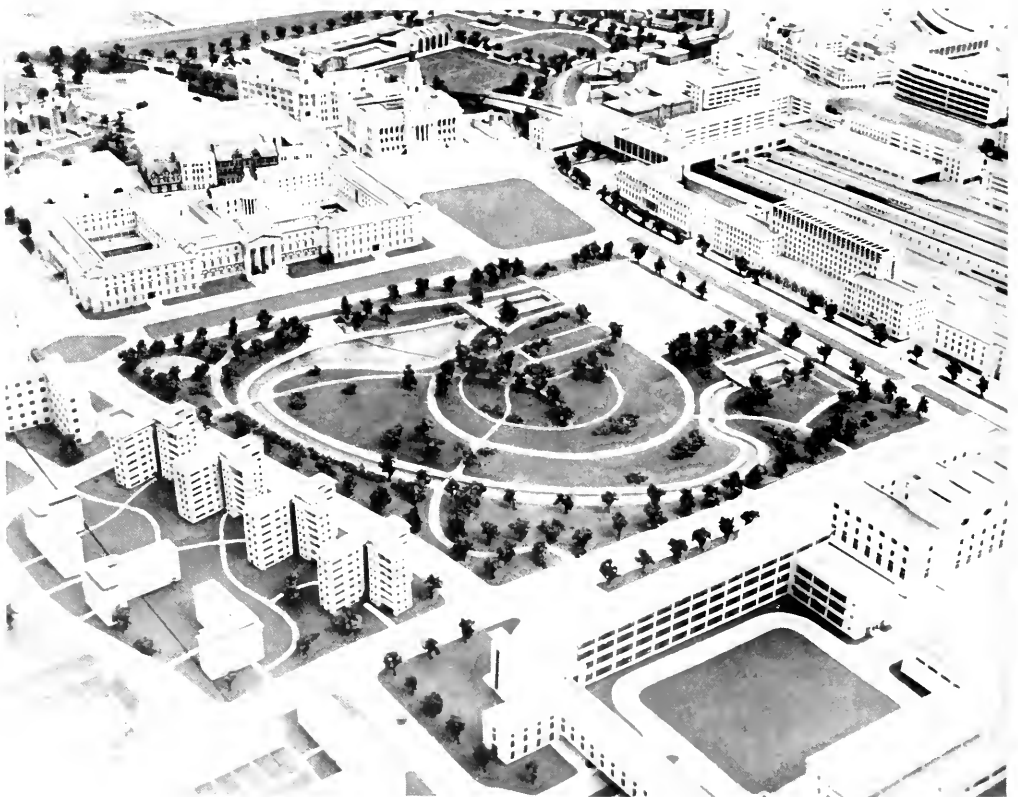

Photo courtesy British Information Service



PORTSMOUTH: The well-known Guildhall is seen in the background.



PORTSMOUTH: After the German raids in 1941.

Photos courtesy British Information Service

The Greater LONDON PLAN

Britain's town-planning expert, Professor Abercrombie, has just published a master plan for the reconstruction and reorganization of the whole of the greater London area in an estimated period of ten years.

The plan, prepared at the request of the Ministry of Town and Country Planning, together with that prepared in 1943 for the London County Council (responsible for the inner area) deals with the area of 2,700 square miles containing in 1938 a population of 10,250,000, over 20 per cent of the population of the United Kingdom.

Following are the main points of the two plans:

(A) Four clearly defined rings must be established:

1. An inner urban ring with an average radius of nine miles, in which there should be a graduated population, with density ranging from 200 per acre (mostly in flats) in a few central residential areas, to 75 per acre (none in flats) on the outer fringes.

2. A suburban ring on an average of nine to twelve miles from the center, with a population of 50 to the acre.

3. A "green belt," between the 12 and 17 mile radiuses containing some outlying towns, but where, since 1935, considerable amounts of open space have been publicly acquired and further building should in the main be banned.

4. An outer country ring, up to a 30-mile radius, mainly farm lands (but also country towns and villages) where the farmer would be encouraged "to perform his unpaid functions as nature's landscape gardener and steward of the countryside," but capable of absorbing as much as necessary of the "overspill" from the central areas.

(B) To achieve reduction of the population in areas (1) and (2) and to implement the Barlow reports is the recommendation that generally no new industries should be introduced into London's urban area. The plan contemplates the removal of over 1,000,000 persons to some 300,000 new

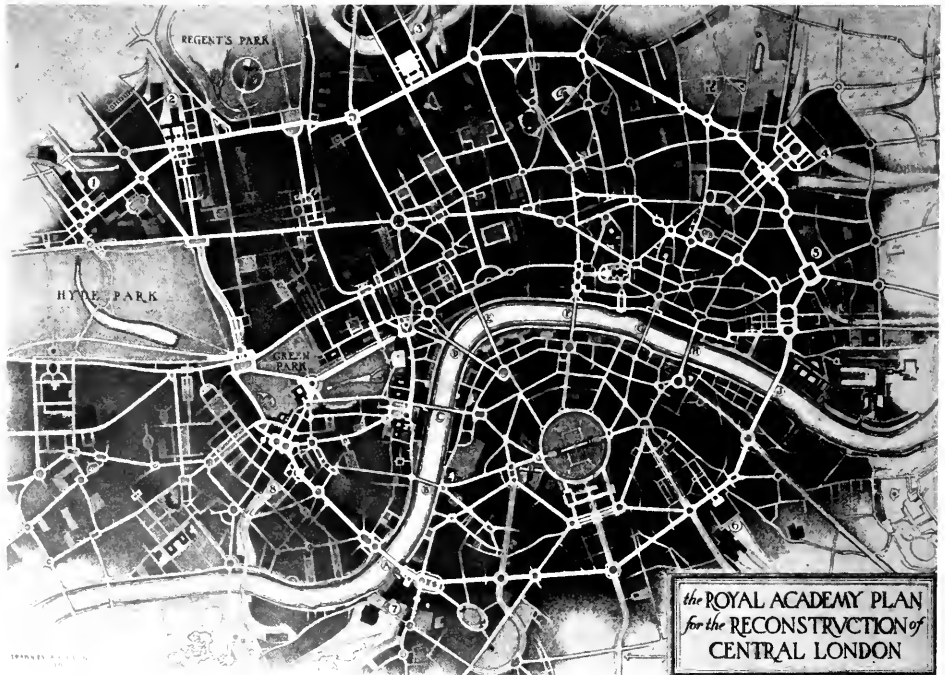
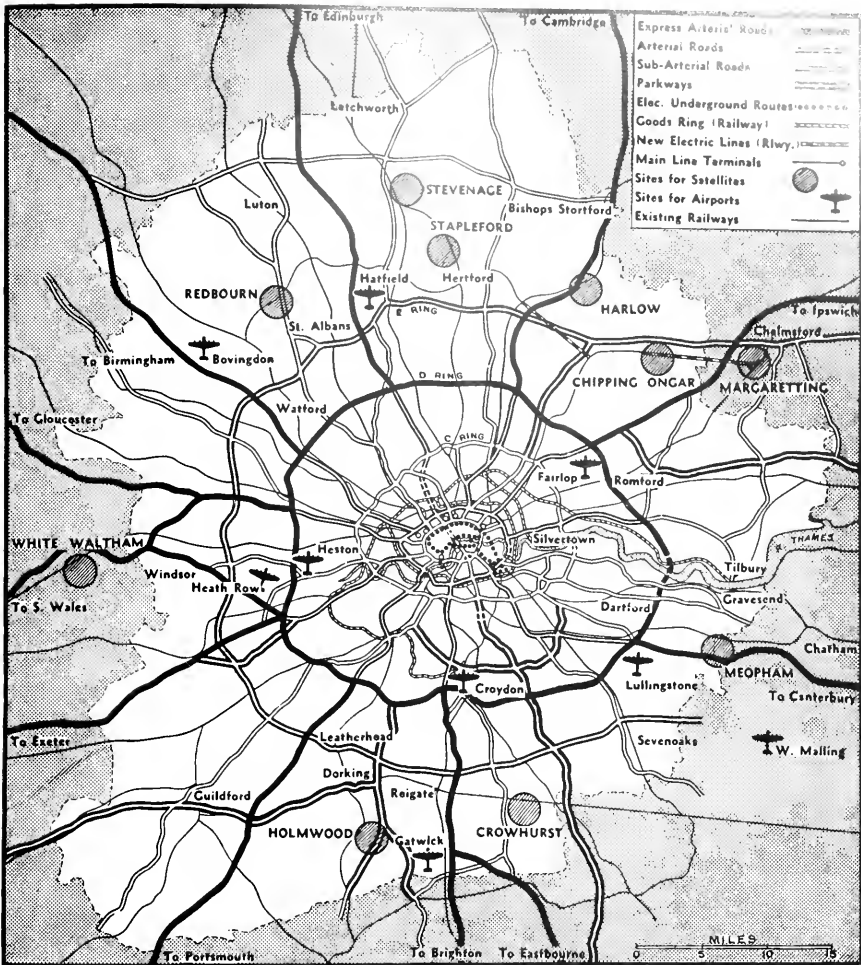

Photo courtesy British Information Service

ARCHITECT AND ENGINEER



PLANS FOR IMPROVEMENT OF "GREATER" LONDON: This map has been compiled by "The Daily Telegraph," famous London news paper, to show the proposed plan for improving London and its immediate suburbs—taken from the book "The Four Rings" advocating the "Greater London Plan."

(Credit "Daily Telegraph")

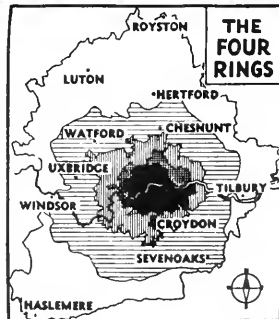

names, and the removal of 2,500 factories. Most people would be rehoused in area (4), in which eight of ten completely new "satellite" towns are proposed, to accommodate 380,000 with adequate industrial sites (with the proposed average of 30 persons per industrial acre). It is pointed out that in the past, industrial and housing developments have not been coordinated, the main industrial expansion having been to the west of London, while most workers live in the east and southeast. The result has been that 86% of the workers living in new housing estates have had a daily journey of eight miles each day, causing inevitable overcrowding on trains and buses. Wartime evacuation of factories and businesses has shown what is possible when removal is essential and there are also prewar examples of successful migration; for instance, the great motor works from Manchester to London, with 3,000 skilled workers and families.

One thing to be avoided is the further establishment of factories on good market-gardening land. To safeguard human interests, the plan suggests "a population director" as well as an officer for the location of industry.

(C) Extensive replanning of communications would include:

1. A "spider web" of ten radial express motor roads.
2. Ten airports, one on each of the radial roads. One of these would be a main airport for world traffic, with runways up to three miles. The plan points out that whereas Britain's road and rail systems have developed haphazardly, there is now an opportunity to devise a full plan for air transport, to enable London to take its rightful place as a world air center.
3. All railways in the inner urban area are to be electrified (this will be helping to eliminate the smoke evil which, the Barlow report said, cost the country millions of pounds annually) and some of the present surface or elevated lines are to be put underground.

(D) Everywhere, roads are to be diverted from the main centers of population, thus enabling these to become self-contained "communities" separated by "parkways," each ideally containing some 600,000 inhabitants with all the necessary dwellings, work-places, shops, public services and open spaces (ten acres per 1,000 persons), schools (one per 1,000 persons) social, religious and recreational facilities, etc. In the inner urban area, the extent of the bomb damage has considerably facilitated the task of rehousing on these lines. This would restore the identity of many towns and villages that have become absorbed into the built-up area of London. Special "pre-

cincts" on "community" lines (i. e., with no through roads) are proposed for the government area of Westminster and for the University area of Bloomsbury.

Conclusion: The rapid and extensive growth of London in the past, originally due to the early disappearance as compared with some foreign capitals of the necessity of keeping within fortifications, has always militated against replanning. Moreover, the British have not had autocratic rulers as in Paris or Berlin to impose new plans on their capital. But war has brought equally great opportunity for reforms in town planning, as in the other types of social legislation, education, health, insurance and employment. To this task is now brought the breadth of vision reflected in Professor Abercrombie's foreword:

"There is now a chance—and a similar one may not occur again—of getting the main features of this program of redistributed population and work carried through rapidly and effectively. War has made migration a familiar habit—courage is needed to seize the moment when it arrives and to make a resolute start."

IN THE NEWS

WESTERN ASBESTOS CO. IS APPOINTED SONNEBORN DISTRIBUTOR

The appointment of Western Asbestos Co., San Francisco, as a distributor for the Building Products Division, L. Sonneborn Sons, Inc., New York, has been announced.

Sonneborn products have been used extensively, and with outstanding success, in the construction of new buildings and in the maintenance of floors, walls, roofs and all exposed surfaces. Sonneborn products now available include concrete floor treatments, cleaners, resurfacing compounds, wood preservatives and finishes, waterproofings and dampproofings, caulking compounds, rust preventive coatings, paints and enamels.

Stocks of Sonneborn products will be maintained by Western Asbestos Co. in their San Francisco warehouse. Descriptive literature is available.

E. L. Robertson moved from Box 433, North Miami, Florida, to Congress Building, Miami, Florida.

Frederick H. Reimers, A.I.A., has moved to 79 Post Street, San Francisco, telephone GARfield 0258, where he will still be glad to receive catalogs and similar material needed by a busy architect.



A foundation upon which to predicate an opinion of the future is a knowledge of the past.

Most parts of our country have districts wherein are to be found examples of homes of former days which carry the mind back to the little red school house, dusty roads and the horse and buggy. This, of course, is true in California, but here and there is a more definite call of the past, a more clear reminder of a life that was specifically appropriate to California and no other country than is found in most other localities.

This nostalgic urge that comes to us in the out of the way places is aroused largely by the simple and direct houses of wood that were built by our fathers and grandfathers on the land before "the wicked cities" came. Some of these houses are being bought by buyers from the cities and with little or no alterations or repairs other than water and leak-proofing, are again being put to the use for which they were built.

Nor is this just the result of housing shortage. Many people are merely sick of the roar and rumble of city life, to say nothing of its hopelessness, and are honestly hoping to return to some extent, at least, to the simple life.

NEW HOME FINANCING

A major change in residential mortgage provisions, designed to aid home owners in improving dwellings, was proposed by Irving W. Clark of The Producers' Council.

"The change would enable a borrower to obtain supplementary loans for the purpose of modernizing or reequipping his home without having to pay the high costs involved in complete refinancing of the mortgage, as is usually required at the present time," Clark stated. "This expense often is substantial and prevents many home owners from keeping their properties in sound, livable condition.

"This proposal is advanced by the Council in the belief that it will promote home upkeep by removing the obstacle of high refinancing costs which tends to discourage families from undertaking major home improvements."



old Whaling Station
Monterey
Calif
Est. 1855.

Angela Hewetson
July 24th 1936.

It was from such old buildings as these that architects coined the phrase, "Monterey Style."

The Old Whaling Station in Monterey is only one of many small buildings and houses in California that retain the so-called Hispano-Mexicano feature of the overhanging front balcony. They will be found in numbers in southern California and all the way up the coast but in the vicinity of Monterey they are most numerous. There it was not long before the "Gringos" saw its particular beauty and the comfort that could be enjoyed on it, looking over the sea or a patio with sabal palms and copa de ora growing over the wall, and new ones, inspired by the old houses with front second story porches, sprang up like mushrooms. Of course it was not just a house with a second story front porch. It had more than that, something further, like the lemon peel in a martini, that made the observer want to live there.

The style became so popular that it was adopted in nearly all parts of the state, but the best examples were still to be found in Monterey. As a result the style became known as the "Monterey House," examples

of which are still being built in San Francisco and Los Angeles. Mr. Hewetson's drawing of the Old Whaling Station is a good example of the Monterey style of house and, as a matter of fact, I wouldn't mind living in one like it, myself.

CLEAN UP AND PAINT UP IN 1945

National offices of the "Clean Up and Paint Up Campaign Bureau" in Washington, D. C., have just released advance proofs of their 1945 window display material.

A considerable amount of activity in "fixing up" together with many plans for extensive "alterations" after the war will result from this year's campaign, is the prediction of Ralph W. Emerson, executive secretary of the bureau.

John S. Siebert moved from 311 Granger Building, San Diego, to 2940 "B" Street, same city.

The Famous Bailey Bridges

Construction details of the British-designed Bailey bridge, quick-assembly spanning device which is now speeding the movement of United States and British armies into Europe, are revealed in these first pictures from London.

Described as the most remarkable bridge in military history, it can cross any gap up to 240 feet without pontoons. With pontoons it can bridge much wider gaps. It is credited already with playing a big part in the Normandy operations, by assisting Allied armies and supplies rapidly to cross rivers and gaps caused by enemy demolitions.

In its lightest form, the Bailey bridge is known as "single Span" and can carry the weight of the heaviest tanks.

Called the "Panel" bridge by Americans, the Bailey bridge is now also standard U. S. Army equipment and component parts manufactured in both Britain and the United States are interchangeable. The bridge fits together like a gigantic jig saw puzzle. There are no nuts or bolts and only one steel pin is needed for each "join." Sections are 10 feet long and composed of 17 parts. Nine other parts are used to make the foundation. Six men can handle the heaviest part with ease.



THE BAILEY BRIDGE AT BATTIPAGLIA: The best answer yet to the enemy's demolitions, which has greatly facilitated the Allied advance in both Italy and the Western Front, is the "Bailey Bridge," named after its inventor, D. C. Bailey, of the British Ministry of Supply. Components, which are made both in the United States and Britain, are interchangeable and can be speedily put together. This, with its great strength and stability, make it ideal for every purpose for which heavy bridging is required. Here is shown the first vehicle crossing the 70-foot Bailey bridge built by British Army Engineers over the Tusciano River at Battipaglia.

British Official Photo

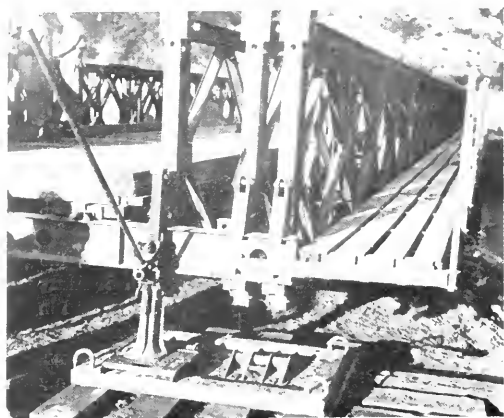

Bailey Bridges have footpaths outside the panels for two files of infantry.

The Bailey bridge is first built on rollers on the bank of a gap and then pushed over by the building crew without mechanical aid. Sections are erected and rolled forward until the gap is completely bridged. The nearest the Germans have to anything comparable is a bridge whose parts in each section have to be fitted together with 24 nuts and bolts.

Invasion forces are making full use of the bridge in Normandy, and it has been employed in Italy with great success, sappers bridging a 300-foot gap across the Trigno River in 36 hours. General Montgomery has praised the Bailey bridge as "Quite the best thing in that line we've ever had." "It does everything we want," he said, "and it will be needed everywhere we operate in Europe."

The Bailey bridge is named after Donald Coleman Bailey of the British Ministry of Supply who played a leading part in its design and development. The story goes back to 1940 when Bailey, who had been contemplating the idea for some time, presented the first plan hastily sketched on the back of an envelope. A War Office official was so impressed that four and a half months later the first experimental bridge was undergoing trials.

The production story behind the bridge is almost as unorthodox as its conception. Firms with capacity for the job were already engaged on equally vital war work. It was imperative that production should get under way at once. The Supply Ministry's only alternative was to ask other firms to do the job, even if they had never built bridges before. The Ministry called on manufacturers of bedsteads, windowframes, paper, a firm of restaurateurs, a mail order business, a greenhouse manufacturer, and a maker of canoe paddles.

Workers loyally kept their pledge to secrecy. Only when it was found that production was failing because some of them thought their work had nothing to do with the war were they shown by secret demonstration that the job was vital to the success of the armies entering Europe.

Also used with outstanding success in the North African campaign, the spanning device proved its worth both as a bridge buildable at night and also as a semi-permanent bridge to carry continuous heavy traffic with little maintenance. The Bailey bridge can quickly be erected to take light tanks and anti-tank guns across river obstacles and later strengthened by adding more girders to enable it to withstand the weight of heavy tanks.

Another important advantage is the ease with which it can be erected and its adaptability to any type of gap. Troops who have never used this bridge soon become experts and learn to launch it by night as well as by day.

Over the tortuous mountain roads of Sicily, Italy and North Africa its successes were first established. Demolitions on hill roads increased until at the end of 1943 an average of two Bailey bridges daily were being constructed by the army in Italy.



One man joins two panels with one 2-inch high-tensile steel pin.

Early in October, 1943, a field company of Royal Engineers was ordered to build over the Bitem River near Termoli. Sixty men accompanied by a subaltern were detailed. The site of a demolished bridge was chosen because the approaching roads had not been badly damaged. The task involved clearance of a vast amount of rubble from the damaged bridge and the restoration of one of the arches. The site was within range of enemy artillery.

The clearing away of the rubble progressed satisfactorily all day. Enemy shells landing close to the bridge reduced the working party to 40 men, who were reinforced at nightfall by 20 more. Lorries brought up bridging equipment during the night and construction began at dawn. Everything prevented speed. Only forty men could be spared

(See Page 26)

THE CHINDWIN AT KALEWA BURMA Spanned by the 14th Army: Less than 12 hours after the capture of Kalewa in December, 1944, 14th Army troops launched assault crossings over the River Chindwin. Later Bengal sappers and miners spanned the river with a 1096-foot long floating Bailey Bridge, believed to be the largest of its kind ever built in any theatre of war. The bridge sections were brought from Calcutta over 320 miles of winding mountain road, assembled up river because of enemy fire, and towed by motor boat to Kalewa. View shows the Bailey Bridge nearing completion. (British Official Photo)

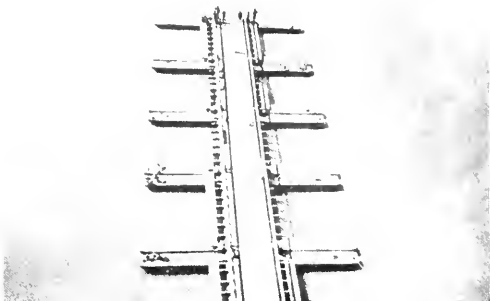
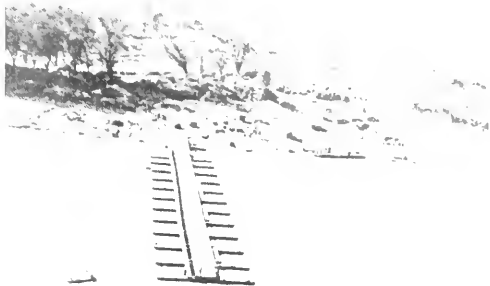

Photos courtesy British Information Service

NEW ALUMINUM FLOATING BRIDGE FOR THE UNITED STATES ARMY

A new all-aluminum, 50-ton floating bridge, lighter, wider and capable of faster construction than any pontoon bridge now in use, is now being made available to Engineer units overseas.

Developed by the Corps of Engineers, Army Service Forces, to handle the increasingly larger and heavier loads on military bridges, the new M-4 bridge is being rushed from tests into action.

Comprising but three main parts, the bridge is so simple in design that a 301-foot section was constructed in two hours and twelve minutes in its first service test, including the time needed to unload from the trucks. "And," says Lt. Colonel Jack Singleton, Chief of the Bridging Equipment Section, Office Chief of Engineers, "we've since knocked 45 minutes off that time."

The three major bridge parts, each of aluminum, are: (1) a hollow deck balk; (2) removable gunwales, and (3) half pontoons.

Two half pontoons, each 30 feet in length and weighing only 1700 lbs., are locked stern to stern with connector pins to form a complete pontoon which alone will safely support 26 tons. The bow of each half-pontoon has been designed to an "ideal curve" to enable it to ride swift currents.

Removable gunwales attached to each pontoon provide a foundation for the deck balk which is fixed in place with lugs and pins.

The hollow aluminum deck balk, which replaces both balk stringers and chess flooring in the older type wooden decked bridges, is in itself an innovation in bridge engineering. Fifteen feet in length, 9 x 9 inches in cross section, and 215 lbs. in weight, a single deck balk may be carried easily by four men; yet afloat, it will support a 300 lb. load. Placed parallel to the flow of traffic, the balks are staggered to distribute the load, making the entire deck a continuous beam. The top surface of the balk is rubbed to minimize the skidding of vehicles. Disabled pontoons may be unfastened from the deck with ease, towed out, and replaced. The decking itself is so buoyant that if every pontoon were sunk, the deck alone could still support a loaded truck.

One M-4 bridge set will provide approximately 436 feet of floating bridge and 180 feet of fixed bridge, or a total of 616 feet. A "set" is carried in 69 trucks and trailers, with each of 64 2½-ton trucks carrying sufficient equipment to build 15 feet of bridge. Two six-ton trucks with semi-trailers transport D-7 tractors while three 4-ton trucks carry

twin-screw power boats. In addition, five Quick-way Cranes accompany each bridge set.

Tactically, the M-4 bridge will be used primarily in the attack, with Engineers constructing the bridge in a rapid follow-up to the assault-boat crossing. In theory, the M-4 will remain in place no longer than four to five days. It will be replaced by either a Bailey bridge or a timber trestle bridge so that it may be moved forward for new attack crossings.

No new types of engineer units will be needed to transport or erect the new bridge. Existing organizations, including Light and Heavy Pontoon units, Engineer Combat Battalions, and Engineer General Service Regiments will be able to construct the M-4 bridge with a minimum of prior schooling.

The deck of the new bridge is 150 inches wide between curbs, nearly two feet wider than present military bridges. Designed and tested to carry with safety a fifty-ton vehicular load in a current as swift as 10 feet per second, the bridge can carry even greater loads in slower currents.

The new bridge will eventually replace several older types. The use of the half-pontoons alone allow the rapid building of a lighter bridge; and trestles and pneumatic floats in each set will permit the construction of bridges over narrow ravines, or in water too shallow to permit the use of the aluminum pontoons.

THE BAILEY BRIDGE

(From Page 25)

to assemble the bridge, the remaining twenty being used to repair the damaged arch. Bridging vehicles were bogged and delayed in entrance to the assembly area. Incessant rain quagmired the ground and made the metal sections of the bridge slippery.

The vehicles were unloaded as fast as they arrived. Neither party had any rest. The bridge had been shelled for a short time in the early morning, but many shells fell short and work continued. At 11 A.M., the enemy, shelling more heavily and accurately, forced the party to take cover.

The position ahead was acute and the bridge had to be completed to allow tanks to go forward. Thereafter, though intermittently shelled, sappers worked incessantly, moving at the run with heavy loads. At 3 P.M., the deadline for the job, the bridge was finished and tanks rolled over to save the position under attack.

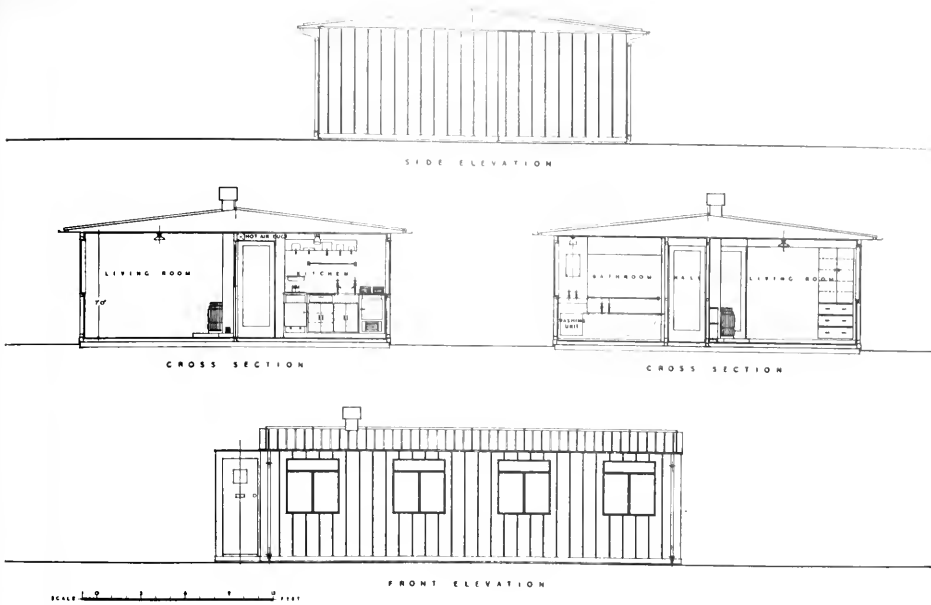

How Britain Will Solve the Housing Shortage

STEEL HOUSES: WE CALL THEM PRE-FABS

By PHILIP MURRAY

In Great Britain today plans are fast materializing for a huge co-ordinated building program which will be put into operation when Germany has been defeated. There will first be an emergency period of two years during which the accumulated and urgent demands will be met, and then a ten-year schedule of rapid building.

The great rehousing plan which the British Government has announced will take some ten to twelve years to carry out. In order to tide over this period, the British Government have decided to build half a million emergency steel houses, which will be mass-produced in factories.

One million homes must be built during the first two years of peace in Europe. Today, however, more than half of Britain's builders are serving in the forces or making munitions. Few of these men will leave their war-time jobs until Japan has been beaten.

The builders that remain will not be able to build more than 300,000 traditional brick houses during this period. A new technique of building was required to bridge the gap, so the British Government has decided that half a million temporary houses must be mass-produced in factories—houses that can be put up quickly by

RIGHT:

PREFABRICATED HOUSE PLANS: Half a million steel prefabricated houses are planned by the British Ministry of Works to meet the immediate post-war housing need. Comprising a living-room, two bedrooms, kitchen, bathroom and shed, the house is made almost entirely of steel with aluminum foil between inner and outer lining which protects against noise and change of temperature. Houses are to be state-owned under a license restricting the period of use, however, private firms are engaged in their own design.

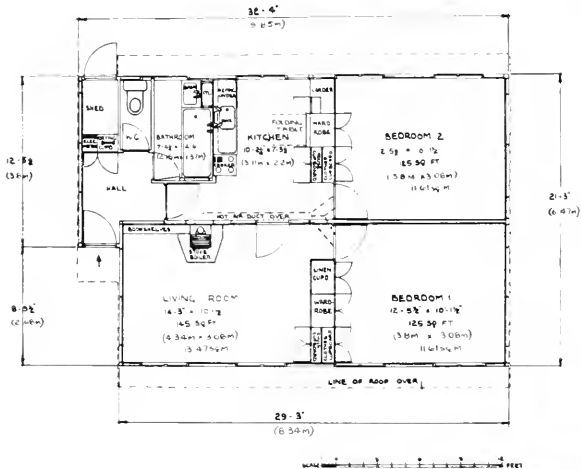
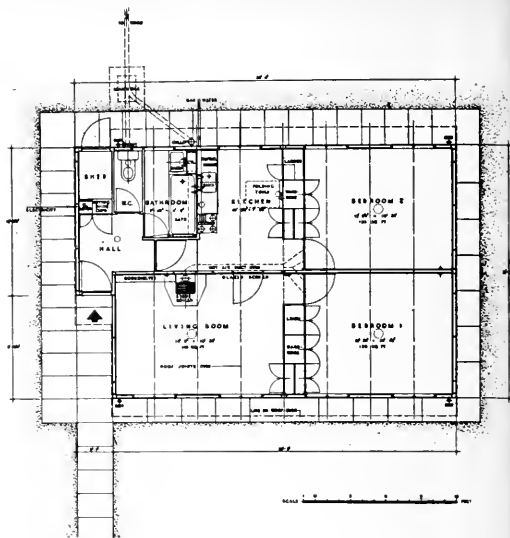

trained men without retarding in any way the twelve-year plan for four million traditional brick houses.

Tens of thousands of men and women have become accustomed during the war to working with steel, of which there will be a surplus as soon as the munitions program is cut. The prototype of the British Government's emergency house has therefore been designed to use steel so that parts can be turned out as quickly as airplane and tank parts have been during the war.

Although families will live in these houses only until they can find more permanent homes, no effort has been spared to provide them with all the benefits of modern science while keeping the rent as low as possible, and well within the means of even the poorest workers.

Above: Plan shows sensible use made of the area affected by the avoidance of corridors and the compact arrangement of the domestic offices.

Right: Bedroom cupboards of pressed steel with mahogany plywood panels. Center cupboard is a hanging wardrobe; the others have steel shelves.





Cooker Unit refrigerator, sink, two drain boards, drawers and cupboards.

Although the house is small—it covers an area of but 616 square feet—it contains a living room 14 feet 3 inches by 10 feet 1½ inches, two bedrooms each 12 feet 5½ inches by 10 feet 1½ inches, a kitchen 10 feet 2¾ inches by 7 feet 3½ inches, a bathroom, separate lavatory, and a storage shed.

The house has been planned to give maximum areas to the rooms by avoiding corridors. Opening off the entrance hall are the kitchen, bathroom and W.C. One of the bedrooms opens off the kitchen, the other off the living room. The living room and kitchen are en suite, separated by a glazed screen in the center of which is a glazed door, giving an impression of space, and light.

Realizing that immediately after the war it will be difficult to obtain furniture, the designers of this house have built in several fittings. Today these fittings would be worth nearly \$400 if they could be bought. Young housewives who have seen the prototype have all praised these fittings, which are, perhaps, the outstanding feature of the house. Indeed, it is in the interior of the house, rather than in the shell, that factory production has rendered its greatest service.

The two partitions between the kitchen and the first bedroom, and between the living room and the second bedroom, are arranged as closets. On the kitchen side there is a larder with divided horizontal shelves. The lower shelves are for dry

goods, and the upper shelves have been ventilated for the storage of perishable food. There is a second built-in closet on the kitchen side for brooms and other loose kitchen equipment. Between the two closets is a hinged table, which folds vertically against the partition when not in use. All these closets are made of pressed steel.

On the bedroom side of this partition there is a full-height hanging wardrobe, with horizontal hanging rail, and a short cupboard, shelved for containing personal linen. The bedroom side of this unit has mahogany plywood panels to the doors, which are framed in steel. The shelves are steel.

The closet unit between the living room and bedroom is also in steel, with plywood panels to the fronts. On the living room side is a shelved china cupboard with three drawers underneath, and on the bedroom side are three cupboards—one for soiled linen, one to serve as a wardrobe and the third for clean linen.

The partition between the bathroom and the kitchen conceals a mechanism which is a miracle of modern science.

On the kitchen side there is a combined assembled cooker, sink with two draining boards, and refrigerator, with drawers and cupboards below. On the bathroom side, the bath and combined clothes-washing boiler and handwashing bowl are



Basin, wash, towel rail and mirror are fitted in steel wall.

built into the steel unit. The hot and cold water pipes and waste pipes are in the middle of this unit, together with the hot water circulating cistern.

Water is heated by a boiler fixed to the back of the heating stove in the living room. This stove burns either coal, coke or anthracite. An electric immersion heater, thermostatically controlled, is also fixed in the cistern to heat about seven gallons (32 litres) of water when the living room fire is not in use. The living room stove also heats the kitchen and bedrooms by hot air ducts between the walls of the various rooms.

The method of construction of these houses has been planned so that over 90% of the work is done in the factory. The wooden floors are in sections, screwed direct to sheet steel joists. The walls are in panels of equal widths (except at the corners) into which are built the steel-framed windows. The panels are set on a sheet-steel sill at the floor level, and between similar vertical corner and middle posts. Three horizontal steel flats, at the top, center and bottom, are in the thickness of the wall. The sections are tightened up by means of steel wedges at the ends of these flats. At the joints of the sections special mastic seatings are inserted to ensure perfectly weathertight joints.



Courtesy British Information Service

on either side with aluminum foil. This gives the wall a resistance to heat equivalent to an 11-inch cavity brick wall.

The roof, pitched at $6\frac{1}{2}$ degrees, has pressed metal joists at centers corresponding to the widths of the wall panels. These joists have their bottom members pressed in angle form at the ceiling level and at the top following the rake of the roof, the angles taking the sheet metal ceiling and roof, respectively. The steel ceiling is plain, but the steel roof is swaged to obtain rigidity. Capping is placed externally at the joints of each section, and adequate longitudinal steel bracings are introduced at the center of the span. Above the ceiling level is placed aluminum foil mounted on timber frames similar to the wall panels.

The steel is bonderized, primed and painted, except the roof, which is bonderized, primed and tar sanded externally, which gives adequate protection from rusting.

The site work of erection is reduced to the minimum. Prior to delivery of the emergency factory-made house, a concrete slab is laid and tarred on the top surface, and the necessary services and drains are put in. Afterwards the floor sections are laid and bolted together on top of the concrete, and the end walls and side walls are positioned, wedged and bolted, working from one end of the structure. The partitions, cupboards and kitchen units are placed in position before the walls are erected. The placing of the roof, bearing on the outer walls and the internal central spine wall, is the last constructional operation.

At wartime prices, this house, with its fittings, is estimated to cost \$2,500, but it is hoped to reduce the cost under peace conditions. The house has been designed to meet an immediate requirement, and its life will be limited by license. The British Government will own the houses and rent them to those in need of shelter.



Interior of a British emergency prefabricated "Portal" house. Kitchen and bathroom appliances, with dividing wall, are turned out as a single unit. Illustration shows kitchen viewed from the living-room, with refrigerator, sink, and gas cooker. *British Official Photo*

The walls are built on the sandwich principle. The external side is sheet steel, swaged to provide stiffness, and coated with flocculent anti-drum material on the inside to prevent noise. Internally, the wall is lined with steel in the kitchen, bathroom, lavatory and hall, and elsewhere designed to receive ply-board or any similar lining. Within the external wall thickness is fixed a sheet of paper, mounted on a light timber frame, and faced

Colotyle Announces Bath Room Design Winners

A jury of five leading Pacific Coast architects have announced the winners in the Colotyle prize competition for bathroom design. The grand prize award of \$500 in cash goes to A. Albert Cooling, of Los Angeles, for his design, which, in the opinion of the jury, "incorporated the greatest number of necessities in the area prescribed with ingenuity of arrangement, simplicity of handling Colotyle, and general good taste in color selection."

Regional prizes of \$250 in cash go to each of

commenting on the problem of the small bathroom, A.I.A., president, J. H. ...
tion, stated: "The bathroom, which has long received little attention in domestic architecture, is no longer to be a mere little space can be devoted to the bathroom, how it can be made more useful for the modern family.

"If there is room for only one bathroom, it must be designed so that more than one member of the family can use it at the same time. The bathroom bottleneck caused by children getting ready for school at the same time that adults are getting ready for the day's work is one which has to be broken, if homes are to be practical."



Colotyle Bathroom Design Contest Board of Judges. Left to right: Victor N. J. Jones, Seattle; Hervey Parke Clark, Chm., San Francisco; Van Evera Bailey, Portland; Herman Brookman, Portland, and Herbert J. Mann, Los Angeles.

(Roger Dudley Photo, Seattle)

the following: Washington, Idaho and Montana: Harry K. Wolfe, Seattle; Oregon, Nevada, Utah: George H. Wardner, Portland; California and Arizona: Burwell F. Hamrick, Burbank.

The competition posed the problem to design a bathroom of not more than 100 square feet for a home costing not more than \$10,000, showing the best and most practical use of Colotyle plastic-coated wall sheets. In the next column is a complete report of the jurying.

If the entries could be taken to indicate any trends in bathroom design, these three treatments were commonly included: (1) Dual lavatory to provide simultaneous use by more than one person; (2) water closet in separate compartment or room; (3) stall shower in addition to bathtub.

The Colotyle Corporation plans to publish a book containing the prize-winning designs. This book will be available to all interested architects.

Following is a list of contestants whose entries won honorable mention, with a \$25 cash award to each:

J. Smith Bennett, Los Angeles; H. R. Kemm, West Los Angeles; Frederick Hodgdon, San Marino; Rolf Sklarek, Los Angeles; L. L. Evison, Verdugo City; Louis Dixon, Los Angeles; Ralph Vaughn, Los Angeles; Milton Caughey, West Los Angeles; Robert Durham, Seattle; Donald Hiscox, Seattle.

REPORT OF THE JURY

Anonymity, of course, was preserved throughout. Before the regions, from which the entries came, were known to the jury, the grand prize was

(See Page 41)

HIGH-FIRED MONOCHROMES

(From Page 8)

texture which the Chinese call "ox-hide surface" (niu-pi mien), and the absence of foreign color. The area within the foot-rim is usually covered with a buff (sometimes a white) cracked glaze or a watery green glaze. Sometimes the glaze on the entire vessel also turned a watery, bubbly green, in which case the ware is called a Lang yao green.

After K'ang Hsi the precious stone red lacks the control exhibited by the Lang yao, the glaze flowing beyond the foot-rim as tear-drops and needs to be grounded even. The glaze is usually of a glassy nature and sometimes foreign colors are found along the edges. The better reds of the Yung Cheng and Ch'ien Lung periods, however, are very lustrous, limpid and of a deep ruby red and there is a growing vogue for them. The area within the foot-rim are often unglazed, exposing a browned surface.

Those red monochromes which have a thin, well-controlled and evenly applied glaze are called chi hung (massed red). The color varies considerably, ranging from maroon to crimson and bordering on the peach-blow and the ox-blood in some cases. It is called sang de pigeon in France, but in America it is usually called liver red. Massed red appears to be fired at a temperature which favors the inclusion of a reign mark in blue within the foot-rim, although it is still within the range of the high-fired glazes. They are generally thin enough so that incised design on the biscuit will show through. Massed red (or fresh red) produced during the early part of the K'ang Hsi period are usually of a pale crimson or plum red color, and there are many indications that by the time of Tsang Ying-hsuan a new type, the peach bloom, was developed from this glaze.

The massed reds of the Yung Cheng and Ch'ien Lung periods are known specifically as Nien hung (Red of Superintendent Nien). The color varies from a crimson and pinkish red to a maroon, and some appear dry and granular. Most of them have a teng-hsin ts'ui or lamp-wick border of white on the mouth-rim, a feature found on all the finer monochromes of this period. There is a group of massed red which has a moist deep ox-blood to wine red glaze which are more fittingly called sang de pigeon and which the Chinese term chi hung (chicken red, meaning chicken blood red).

The peach bloom or peach blow glaze is a rare product of the K'ang Hsi kilns. This glaze is somewhat like the K'ang Hsi massed red but it is generally more lustrous, of a higher saturation and of a more pinkish red, broken here and there with passages of a less limpid russet brown or even a colorless white. The glaze is usually delicately

splashed or dotted with jade or emerald green and is sometimes cracked. The area within the foot-rim is glazed a clear white and there is invariably a six character reign mark in a very fine clear blue.

The Chinese name is chiang tou hung (kidney bean red). T'ai tien lu (spotted moss green) is the name given for a desirable type where the green breaks out as tiny dots, covering the pinkish ground evenly. Other names associated with this glaze should be used with care. P'in-kuo hung (apple red) and p'in-kuo lu (apple green) refer to the red and green areas within the glaze only, and unless the glaze is entirely red or green it is best not to apply these terms. Hsien hung (fresh red) as a name should be avoided unless one specifies that it is a fresh red of the Tsang Ying-hsuan period. Mei jen chi hung (beauty's sacrificial red) is commonly applied to peach bloom, but unfortunately, it is also used to designate massed reds and even rose-pink monochromes of the muffle kiln. The term is an abbreviation of the phrase: "A sacrificial red which is comparable to the blush of a beautiful maiden."

From Yung Cheng period onward a type called yao pien (kiln transmutation) came to be popular. Yao pien were known to be produced by chance during the Ming and the K'ang Hsi period but it is from Yung Cheng onward that they were made deliberately and at will. Called flambé in the West it is a precious stone red which came to be covered in part or in whole with streaks, striation or passages of blue, grey or purple—and sometimes green, yellow or black. The ground within the foot-rim is generally without any reign mark, although imperial specimens often have marks impressed into the biscuit. It resembles but differs from the Chun yao of the Sung dynasty in several respects: the ground color is red or purplish red which came to be covered in part or in whole with blue or blue-grey, whereas with the Chun yao it is just the opposite—and some of the finer Chun yao is just a sky blue without any reddish splashes. The yao pien glazes are more lustrous, of a higher saturation and generally more limpid, though opaque specimens are encountered. The Chun yao glazes are more opaque and opalescent, the glaze generally stopping short of the foot.

There are many well-known types of transmutation glazes. The term flambé rouge is generally applied to those which are predominantly red, the hung yao pien (red transmutation) of the Chinese. Bottle-shaped flambé rouge whose neck has turned dark purple is called "pigeon neck flame" in the West. "Apple red" is a precious stone red which has lost most of its color, leaving a few strands of red on a colorless white ground. "Lang yao

(See Page 34)



Trees in Architectural Rendering

Although it is not so generally realized, there are about as many different kinds of oaks as there are pines and, as with pines, the rendering of oaks can differ widely. However, this is true—there is a general family resemblance amongst oaks as there is amongst pines.

Mr. Hewetson's drawing bears this out clearly. His old oak, with its festoons of moss and mistletoe, is not at all like the native California live oak, yet it is unmistakably an oak. Similarly, a good rendering of a live oak might be quite different and still look like an oak. The temptation to merely outline the tree and fill in the spaces of imaginary foliage with any old lines is strong and it might look well that way. But if the artist wants to convey any impression of a particular type this will not suffice. As Mr. Cole says in his "Artistic Anatomy of Trees," it will be necessary to express, to some extent, the anatomy of the tree drawn. Like swimming, it's easy to do if you know how.

BETTER WIRING for BETTER LIVING

Many homemakers today, doing housework for the first time, are discovering mistakes made in the wiring of their homes—the awkward location and inadequate number of switches and outlets; blown fuses and inefficient operation of appliances and lamps, resulting from wire of insufficient size.

People living in rented quarters blame the shortsighted policy of the owner in neglecting to provide proper electrical service. But those living in homes they have had built are, sometimes unfairly, blaming the architects.

Planners of future homes will put complete and efficient electrical service at the top of the list of important considerations. Whatever else the architect specifies, adequate wiring is certain to head the list of "must" items for it will provide the key to modern living.



NORTHERN CALIFORNIA
ELECTRICAL BUREAU

1355 Market Street

San Francisco 3



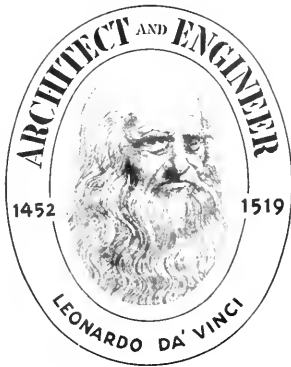

LEONARDO DA VINCI!

In 1482 Leonardo wrote to Duke Moro:

"Most illustrious Signor, having studied and weighted the works of present day inventors of military engines I have found that they contain nothing which would distinguish them from those in general use. . . . During times of peace, I hope to please your Highness by Architecture, by the erection of private and public edifices; by construction of canals and aqueducts."



SELECTING PAINT

A new handy method of selecting the best paint for a given application without detailed technical knowledge of different finishes is provided by the Valdura Paint Guide offered by the American-Marietta Company, Chicago.

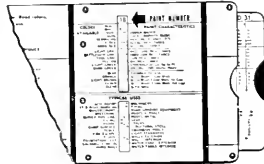
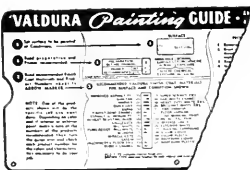

It is of convenient pocket size and works on the principle of a slide rule and with only two settings gives the correct surface preparation, the proper priming and finishing coats.

Information is furnished as to the resistance of the recommended material to heat, acid, alkali, moisture, abrasion, sun and oil. Coverage and drying time data are also furnished. The Guide shows the proper thinner to use as well as the correct proportion.

HIGH-FIRED MONOCHROMES

(From Page 32)

red and green" or "ox-blood and green" are precious stone reds which have turned watery green or pea green in spots.

Lan yao pien (blue transmutation) and lu yao pein (green transmutation) refer to wares whose reddish ground is splashed with blue or green. Tzu yao pien (purple transmutation) generally has a uniform purplish ground. Yu-lu yao pien (oil green transmutation) refers to those which have a green ground with white mottling. A type called "dragon scale" (lung lin) has a celadon or a brown-black ground profusely covered, scale fashion, with splashes of yao pein glaze. A very rare transmutation bud vase, belonging to a friend of the writer, has the upper part a purplish red and the lower part a mottled sage green. The glaze has the same characteristics as the K'ang Hsi precious stone red, exhibiting faint crackles and stopping as an even line at the foot. High officials attached to the Manchu court at Peking said that the Emperor K'ang Hsi had seven or eight pieces and that they were named after their Sung prototype as yu-kan ma-fei (fish liver and horse light).

The color blue is derived from cobalt and may roughly be divided into four types, paralleling the reds. The painted variety, whether penciled or applied in broad washes, is called, not yu-li hsien lan as one would expect, but ch'ing-hua pai-ti (blue decoration on white ground), possibly because the term is more euphonious. Blue monochromes produced by the underglaze method—by painting, sponging or blowing the color on the ground before the final glazing—is the equivalent of the hsien hung or fresh red. There are reasons to believe that with the finer pieces the blue is not deposited on the biscuit but on an initial coating of glaze or glaze-slip. The powder blue or bleu flouetté, called ch-iu lan (blown blue) in China, is made by blowing the pigment through a tube one end of which is covered with gauze. This much-sought-after blue, if used as a monochrome, is usually decorated with gold traceries. On many specimens there is a double ring of blue within the foot-rim, and one notes that the blue, which is of the same quality as the blue on the body, generally rests on a disc of slip-glaze, indicated by its being slightly elevated from the surrounding ground as well as by the whiter color which characterizes the finer blue and white.

The counterpart of the massed red is generally called chiaolan (delicate blue). The glaze is evenly and generally thinly applied, and the finer wares have incised design on the biscuit which shows

(See Page 38)

**PAYNE FURNACE COMPANY
PREPARES FOR GREATER
POST-WAR SERVICE PROGRAM**

Change of the name of the 30-year-old Payne Furnace & Supply Company Incorporated of Beverly Hills (California) to Payne Furnace Company was announced in connection with acquisition of assets by Dresser Industries, Inc.

In a joint statement issued by H. N. Mallon, president of Dresser, and E. L. Payne, president of the Payne Company, it was stated:

"Transfer of the company's assets, business and good will was approved by Payne stockholders at a special meeting on January 31, Dresser directors having previously agreed to the transaction on December 8, 1944."

"Payneheat" will operate as a separate unit of the Dresser Industries, it was stated, continuing to manufacture the well-known, long-established Payne models. No change in management or general policy is anticipated.

It was also revealed that for the past three years Payne has concentrated on essential war production, but when men and materials become available, the company plans to expand its line of products and services.

"These include gravity warm air systems, forced

warm air units for winter and summer ventilation, gas floor and baseboard heaters, gas vent pipe and other accessories. Payne furnaces operate on natural, manufactured and refined petroleum gases, and are used for both commercial and domestic heating.

"The merger with the Dresser Industries will enable Payne to amplify its facilities and resources and expedite the exchange of technical and research information," the joint statement concluded.

OAKLAND BOND ISSUE

The bond election that is to be held in Oakland on May 8, 1945, will be one of considerable importance, not only because it is for more than \$15,000,000, but because it is for money that will pay for buildings and improvements that can greatly enhance the beauty of Oakland, or otherwise.

Exhaustive studies of the needs of the city, both architecturally and from the standpoint of city planning, and many plans have been drawn, some of which were published in ARCHITECT AND ENGINEER, and it is to be hoped that if the bond issue is carried the city will expend the money in one of those comprehensive plans which look forward to a greater city.



A CASTLE? NO!

... APARTMENTS

... and the tenants are grateful for PAYNEHEAT

Unique in exterior design, suggesting a magnificent home, this Southern California apartment building is also noteworthy for its equipment. The PAYNE gas-fired heating installation assures a lifetime of dependable, healthful, economical warmth. ★ Ideal for apartment buildings is the time-tried PAYNE "Unit" system, now progressively improved as . . .

Payne ZONE-CONDITIONING

Circulated winter warmth . . . cooling summer ventilation if desired . . . controlled by zones (individual apartments, groups of rooms or single rooms). Write for new ZONE-CONDITIONING booklet.

PAYNEHEAT

NEARLY 30 YEARS OF LEADERSHIP



CHATEAU COLLINE APARTMENTS, LOS ANGELES
Architect, P. P. LEWIS • Builder, A. W. ZIMMERLE

Payne FURNACE & SUPPLY CO., INC., BEVERLY HILLS, CALIFORNIA

WITH THE ENGINEERS

J. G. (BUZZ) WRIGHT, the 1945 President of the Structural Engineers Society of Northern California, has had twenty-five years of that form of experience that is needed for a president of just that sort of a society.



J. G. (BUZZ) WRIGHT

After his graduation from the University of California with the class of 1920, Mr. Wright sailed right into the work of structural designing and has been hard at it ever since. Since his graduation he was variously with such local consulting engineers as Henry D. Dewell, Knapik & Huber, and Couchot & Rosenwald and others.

In 1938 he was Chief of Plans and Estimates for the California Exposition Company in charge

of structural plans for the State's participation in the Exposition. Before the Exposition opened, Mr. Wright served in a similar capacity for the Pacific Bridge Company on the construction of the Golden Gate Bridge piers. Immediately after the close of the Exposition he became the Structural Engineer for the Permanente Company at Mountain View in the designing of their Cement Plant.

But a further detailed report might be too long.

Suffice it to say that in addition to his work on the staff of A. W. Earl, Consulting Engineer at 233 Sansome Street, Mr. Wright is throwing his boundless energy into the task of directing the affairs of the Structural Engineers Society of Northern California and judging by the success of his first two meetings the society will reap a lasting benefit from his efforts.

Robert H. Orr moved from 724 South Spring Street, Los Angeles, to 5022 Marathon, same city.

Guy L. Rosebrook has moved from 1451 Princeton Ave., Stockton, to 1053 Monterey Ave., Berkeley 6, Calif.

Louis J. Laskin has moved from 316 S. Roxbury Drive, Beverly Hills, to 418 So. Orange Grove Ave., Los Angeles 36.

UTILITY
Appliance Corp.

Air Cooling, Ventilating and
Gas-Fired Heating Equipment

FLOOR FURNACES

FORCED AIR FURNACES

FORCED AIR UNIT HEATERS

DUAL OUTLET FLOOR FURNACES

You are invited to investigate the complete line of Utility evaporative air coolers, centrifugal blowers, propeller fans, floor furnaces, circulating heaters, unit heaters and forced air furnaces. Catalogs and illustrated literature will show you the outstanding features of these truly modern appliances.

Utility coolers, blowers and fans are now available under WPB regulations and priorities. Heating equipment will be available when war restrictions are lifted to permit manufacture.

EVAPORATIVE AIR COOLERS

UTILITY Appliance Corp.

Formerly Utility Fan Corporation

4851 S. ALAMEDA STREET • LOS ANGELES 11, CALIFORNIA

A. I. A. ACTIVITIES



The election of officers for the year 1945 was held at the Chapter meeting of January 29, 1945.

President Hass has announced the standing committees for 1945.

The committees are:

Public Relations and Public Information Committee: Lawrence A. Kruse, Chairman; Ernest J. Kump, Jr., Ernest Born, Robert J. Evans and Oscar Price.

Architectural Practice Committee: Leo J. Sharps, Chairman; Arthur B. Gallion, Elizabeth Boyter, Theodore C. Bernardi, Henry C. Collins and Dodge A. Riedy.

Membership: A. Lewis Koue, Chairman; Irwin M. Johnson, Alfred C. Williams.

Unification: E. Geoffrey Bangs, Chairman; Fred Langhorst and Albert E. Evers.

Education and Registration: Raymond W. Jeans, Carl Schmidts, Wendell R. Spackman, John Bakewell, Jr., Frederick H. Reimers and Ralph N. Kerr.

Allied Arts: Edward L. Frick, Chairman; Russell de Lappe, Timothy L. Pflueger, Ralph N. Pollack and Keith O. Narbett.

Civic Design: Douglas D. Stone, Chairman; Malcolm D. Reynolds, Jotham S. Gould, Carl I. Warnecke and John H. Devitt.

Program Committee: J. Francis Ward, Chairman; Wilbur D. Peugh and Loy Chamberlain.

Construction Industry: Vincent G. Rainey, Chairman; Philip D. Tomasello, Fred Langhorst and Rudolph O. Igaz, Jr.

Building codes have always presented a challenge to the professional man. We all recognize the need for revisions, some minor, some radical. To revive your interest read "Breaking the Building Blockade" in the February "Atlantic."

Jose Moya Del Pino, well-known mural and portrait painter, was the guest speaker at the Chapter's January meeting. He asked the architects to remember the arts in their designs, since it was his opinion that the best art was created for architectural use. Mr. Moya spoke of the works of Mr. Beniamino Bufano, but felt that much of Bufano's art was lacking in greatness because it was created "in a vacuum," without a specific architectural setting.

One of the first to talk in favor of the California Council was the member of the legislative committee. This committee consisted of Earl T. Heitschmidt, Norman K. Ferguson, Harry J. Devine, Edward J. Maher, John T. ... and Adrian Wilson.

The State Board of Architectural Examiners is actively working on a new examination procedure. . . . The State Department of Public Health has issued a new Bulletin on "Standards for Maternity Hospitals and Maternity Homes." These are available at the Chapter office. . . . Have you submitted a portfolio of homes for the office files?

IN THE NEWS

APPOINTED PACIFIC PORTLAND

Robert B. Soldini, for 22 years associated with the building material industry in Southern California, has been appointed District Sales Manager of the Los Angeles office of **Pacific Portland Cement Company**, according to an announcement by J. A. McCarthy, President of the Company.

Soldini will have charge of sales in Southern California, Arizona and Southern Nevada, for all products manufactured by the cement and gypsum divisions of the company.

Soldini's experience includes 17 years in the cement business.

EGGCRATE STYLE LUMINAIRE

Combining the elements of lamp-shielding and glass diffusion, with a strong, efficient down lighting plus diffused side lighting factors, a new fluorescent luminaire is announced by the Edwin P. Guth Company of St. Louis, Missouri.

With paneled and die-cut ends which afford pleasing light window design, the glass panels and "eggcrates" are separately removed for easy maintenance. The unit for individual or continuous installation may be suspended from the ceiling or mounted directly.

ALUMINUM WINDOWS

A new booklet entitled "A Better Sales Outlook" —Aluminum for Moderately Priced Homes" describes low cost stock size windows, both double hung and casement types, and includes installation instructions. These windows will be produced as soon as restrictions are removed by THE ALUMINUM WINDOW CO., 34 - 10th Street, Long Island City, N. Y.

*Be sure you're getting the
finest window glass obtainable*

it costs no more to specify

PENNUERNON

Distributed by...

W · P · FULLER & CO.
PAINTS • GLASS • WALLPAPER

it's
FLATTER
... CLEARER
... BRIGHTER ...

PennuERNON
flat drawn
WINDOW GLASS



QUALITY AND DEPENDABLE
Service

are the factors that influence architects and contractors when selecting lumber and mill work — Quality of merchandise — Integrity and Ability of the firm—Service in physical equipment — Experience and Personnel — All these factors contribute to a speedy and satisfactory completion of construction with minimum of time and expense.

MANUFACTURER OR DEALER IN

Douglas Fir—Redwood—Sugar and Ponderosa Pine — Plywood and Concrete Form Panels — Sash and Doors — Millwork — Insulation — Builders' Hardware.

E. K. WOOD LUMBER CO.

"Goods of the Woods" ©
LOS ANGELES • SAN FRANCISCO • OAKLAND

HIGH-FIRED MONOCHROMES

(From Page 34)

clearly through the glaze. There is usually a reign mark within the foot-rim. Most specimens of this period have either a white or a golden-brown mouth-rim, the latter usually on the stouter or larger wares. The chiao lan produced at the time of Nien hsi-yao, known generally as Nien lan (the blue of Superintendent Nien) usually has a deep blue color and a mat surface. Precious stone blue (pao shih lan) has a thick glaze and no reign mark within the foot-rim. However, the term is loosely used, being often applied to any clear blue, especially one with fish-roe crackles.

More often, blues are named according to the quality of their colors. The lightest blue is almost a white and is called yueh pai (moon white or clare de lune). The imperial grade is said to be coated on both the inside and the outside surfaces and of a pure blue, whereas the ordinary grade generally has a white interior and a lavender cast. There are several shades of light and medium blue which come under the term 'tien (sky blue), and what is known in the West as starch blue is a sky blue of light saturation. The darker blues constitute the chi ch'ing (sky-clearing blue) while the deepest blues are the ta ch'ing (gros bleu or great blue) and the ti lan (abbreviation for ti-yi lan, number one blue). Mazarin blue, a term often erroneously applied to powder blue, is a deep blue.

A few of the blues are crackled. A light sky blue with fish-roe crackles is called pao shih lan (precious stone sky blue) or yu tzu lan (fish-roe blue). A slaty medium sky blue with crackles is called fang kuan (imitation kuan) and a deep blue, crackled or otherwise, is sometimes called fang chi chou (imitation Chi chou ware).

Most blues take on a lavender or violet hue because the minerals for the blues and the aubergines are often found together in nature and the potters did not take the trouble to separate the two. A faint lavender cast is found on the ordinary clare de lune or sky blue. The chi ch'ing of the Ming dynasty has a purplish tone. As the purple increases over the blue they come to be known as tzu ch'ing (pulplish blue), kan ch'ing (purple) and ch'ieh tzu lan (eggplant purple-blue). The purely purple colors are generally known as hiao tzu (light purple), chiao tzu (delicate purple), chan pao ch'ing (purple blanketed blue) and ch'ieh tzu se (aubergine).

(In the next article Mr. Chingwah Lee will describe the lower fired monochromes—those of the medium and muffle kilns.)

IN THE NEWS

ELECTED

W. B. Holton, Jr., President of the Walworth Company, manufacturers of valves and fittings, was recently elected president of the Valve Manufacturers Association at a meeting in New York.

MORE USEFUL—FROM ANY ANGLE

Every person engaged in professional drawing will find many time saving uses in the new Brunning convenient, adjustable triangle.

Made of heavy highly transparent plastic with molded-in calibrations of half degrees it is ideal for all kinds of layout work, including the drawing of screw threads, helical springs, bevel gears, and for any drawings or plans requiring accurate angles from 0 to 90 degrees.

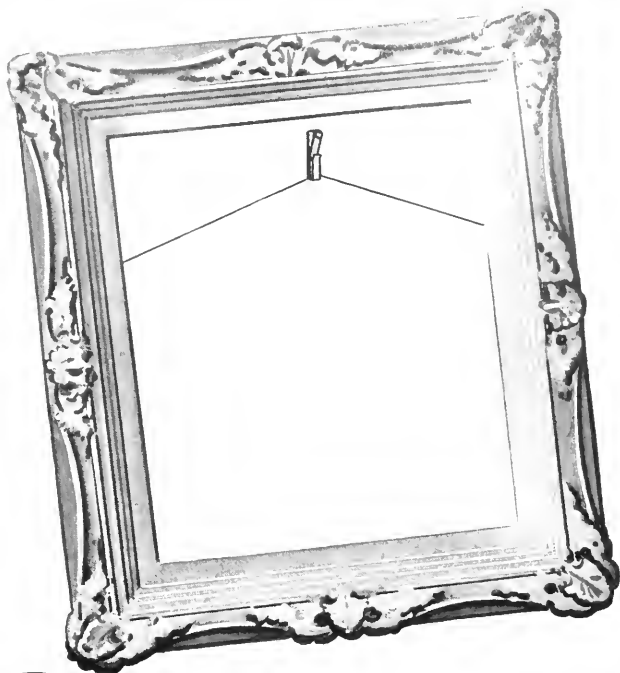

*Rosy pictures are **OUT!***

We're going to wait until victory is a fact before disclosing the Smoot-Holman luminaires-of-the-future. No doubt many of our friends and customers would like to see us start producing more prewar items... but for those who expect the end of the war to bring something new and different we have a few surprises filed away in our blue print cabinet.

BUY U.S. WAR BONDS AND HOLD THEM!



Offices in Principal Western Cities—Branch and Warehouse in San Francisco

N. CLARK AND SONS

Manufacturers of
Quality
Architectural
Clay Products

During this stage of the war, our principal energy is to manufacture products required by the various war agencies. We still can supply some pre-war materials for civilian needs.



401 PACIFIC AVENUE
ALAMEDA, CALIFORNIA
San Francisco • Los Angeles
Salt Lake City • Portland

PRODUCERS' COUNCIL PAGE

Northern California Chapter

The National Organization of Manufacturers of Quality Building Materials and Equipment
Affiliated with the AMERICAN INSTITUTE OF ARCHTECTS



WARD SHAFER

Ward C. Schafer of The Pacific Gas and Electric Company is carrying on this year in the best Harry Lemos tradition as Chairman of the Membership and Attendance Committee.

Modest Ward's chief claim to fame—to hear him tell it—is that he went through grade and high school with Wilbur Peugh back in Modesto and the fact that Russ de Lappe preceded them by a couple of years. Of his college days he advises merely that he graduated with a nominal collection of Greek jewelry, none of which proved to have any quick cash value, so he went to work for P. G. and E. without losing any time.

Until further notice, Ward says he can be located at 447 Sutter Street, 8th floor, rear, on Mondays, Tuesdays, Wednesdays, Thursdays and Fridays and alternate Saturdays, to anyone interested in increasing his industrial gas or electric usage or in joining the Producers' Council.

Home is in Berkeley where he resides with his wife and two children, a boy and a girl, 16 and 12, respectively. His hobby is wood carving and burning which he calls "wasted effort."

AMERICAN CERAMIC SOCIETY, Northern California Section, heard Chuck Kraft spread the gospel of Modular Coordination at their March meeting at the Claremont.

METAL WINDOW BOYS have come out with details on Modular Coordinated windows. If you want to know more about it, President George will be glad to oblige. Detroit Steel Products was one of the first. This development has gone past the idea stage . . . it's here!

TECHNICAL INFORMATION COMMITTEE is prepared to present technical discussion on Modular Coordination. Lecture material and a slide film have been acquired by the Chapter. Other Coast Chapters are similarly getting active on this subject.

WELCOME HOFFMAN SPECIALTY. An old member of the Chapter returns to the fold with R. J. Fuite as Representative.

WE'VE HARPED a lot on attendance and bringing a guest to our monthly meetings. Believing that we all mean well but just don't get around to it, your Executive Committee has evolved a plan whereby invitations will be handled by the Chapter for you, which will also insure that every Bay Area Architect or Engineer has an opportunity to attend our meetings at least a couple of times a year and none will be overlooked. All we need is your cooperation in following through and we've been assured of that.

DON'T LOOK NOW. You don't say "Post-war Planning" out loud these days, but there is going to be an adjustment from War to Peace. Now's the time to get some work on the boards.



USE QUALITY PRODUCTS



CONSULT AN ARCHITECT

BOOK REVIEWS

THE AMERICAN INSTITUTE OF STEEL CONSTRUCTION has issued a brochure on "TECHNICAL AND COMMERCIAL DEVELOPMENTS IN LIGHT GAGE STRUCTURAL STEEL." It is an address by Milton Male, Research Engineer for the U. S. Steel Corp., well illustrated, and contains valuable information for architects and engineers.

ARCHITECTS MOVE

George P. Hales moved from 326 Jackson Street, San Francisco, to 409 Appraisers' Building, 838 Sansome Street, same city.

COLOTYLE CONTEST WINNERS

(From Page 31)

selected. Generally a high degree of thoughtfulness and good taste were displayed by the contestants. The jury could have made a larger number of awards had they been available. Of all the entries only three attempted to solve the problem of simultaneous use by two or more persons. Though this was not the only determining factor, it happens that the grand prize did solve it brilliantly. Few startling innovations were presented. However, walls of obscure glass were used successfully in several premiated designs. Two wash basins were suggested by a number of contestants and were thought to be desirable. Inclusion of a dressing table (not required by the program) in the layout led several competitors into a crowded solution. Some presentations were beautiful renderings, but could not be premiated because they were two dimensional pictures and not serious efforts to solve the problem. Similarly, some were grandiose ideas not appropriate to a \$10,000 house. Mr. Vaughn's design violates this clear restriction of the program, but was awarded an honorable mention on the imaginative quality it displayed. The jury awarded the grand prize to Mr. Cooling for ingenuity of plan arrangement, simplicity of the handling of Colotyle, and the good taste and judgment of the color selection. In the allotted area of 100 square feet, this prize winner managed to incorporate the greatest number of necessary conveniences.

Van Evera Bailey
Herman Brookman
Hervey Parke Clark, Chairman
Victor N. J. Jones
Herbert J. Mann



APPOINTED AGENT

J. Wilfred Gunn, President of the Hollywood Termite Control Company, Los Angeles, has appointed N. T. Chemical Company, Inc., 506 Park Street, San Francisco, as exclusive agent for the Termitrol Patent in the San Francisco Bay Area, according to announcement just received from George G. Aitkenhead, N. T. Chemical's President.

The Termitrol Patent is the invention of Civil Engineer Gunn and is based on the "blockade system" of termite prevention. Applicable only to new building construction, the patent has met with immediate acceptance by F.H.A. officials and executives of the leading lending institutions.

Plans are being made for the appointment of agents on a nationwide scale, as soon as war-time building restrictions are relaxed and new construction gets under way again. Information covering the Termitrol Patent is available to architects, construction firms and lending institutions upon request from the Hollywood Termite Control Company at 2903 Beverly Boulevard, Los Angeles 4, California.

Breo Freeman moved from 303 Markham Place, Pasadena, to 28 South Fair Oaks Avenue, same city.

PRESSURE TREATED LUMBER
● **PROTECTS AGAINST DECAY**
AND TERMITE ATTACK

Specify it in your home
Available through Lumber Dealers

LOS ANGELES	SAN FRANCISCO
601 W. 5th Street	333 Montgomery Street
Phone Michigan 6294	Phone DOuglas 3883

J. H. Baxter & Co.

AGENTS FOR WEST COAST WOOD PRESERVING CO. SEATTLE WASH

IN THE NEWS

CHANGES NAME

A change of name and ownership of the Detroit Brass Foundry, Los Angeles, California, was announced last week by Don Davidson, the General Manager.

Hereafter the company will be known as Los Angeles Brass Company, manufacturing under the trade-mark name "L. A. Brass." Original facilities of the twelve-year-old concern have been more than doubled with addition of new equipment and a complete machine shop. Three new buildings have been added.

At present, full capacity of the plant is being utilized in the production of aircraft and marine parts, but as soon as reconversion is permitted, the Los Angeles Brass Co. will immediately go into production of ultra-modern Swing Spout Faucets for the better plumbing trade.

JANUARY BUILDING PERMITS RISE 31.9 PER CENT ABOVE YEAR AGO

Total value of building permits issued during January moderately exceeded that for December, and rose substantially above the volume for the first month of 1944.

Estimated cost of permits for 215 cities of the United States amounted to \$44,767,043 last month, according to Dun & Bradstreet, Inc. This represented a rise of 13.5 per cent above December with \$39,433,287, and was 31.9 per cent greater than the \$33,942,794 recorded in January last year.

New York permits for January—totaling \$12,962,411—increased 80.8 per cent above the December aggregate, and showed a tremendous gain over last year's sharply reduced sum. In the 214 cities, excluding New York, permits for January were valued at \$31,804,632, indicating small declines from both the previous month and the like month a year ago.

Group totals for 215 cities for January 1945 and 1944, together with percentage changes are shown herewith:

Geographical Divisions	January		P. Ct. Change
	1945	1944	
New England	\$ 1,557,826	\$ 1,953,647	— 20.3
Middle Atlantic	15,208,416	3,176,055	+ 378.8
South Atlantic	4,658,829	1,888,231	+ 146.7
East Central	5,899,265	8,030,831	— 26.5
South Central	4,895,602	4,965,183	— 1.4
West Central	2,130,240	1,968,787	+ 8.2
Mountain	1,943,292	657,167	+ 195.7
Pacific	8,473,573	11,302,893	— 25.0
Total U. S.	\$44,767,043	\$33,942,794	+ 31.9
New York City	\$12,962,411	\$ 700,692	+1,749.9
Outside N. Y. C.	\$31,804,632	\$33,242,102	— 4.3

HOGAN LUMBER CO.

Wholesale and Retail

LUMBER

MILL WORK • SASH & DOORS

Office, Mill, Yard and Docks

SECOND AND ALICE STREETS • OAKLAND, CALIF.

Telephone GLencourt 6861

SANTA MARIA INN

SANTA MARIA, CALIFORNIA

FRANK J. McCOY, General Manager

FERNAND E. PIMENTEL, Manager

On the Coast Highway between San Francisco and Los Angeles



American or European Plan • Old English Top Room

CLINTON CONSTRUCTION CO. OF CALIFORNIA

General Contractors

923 FOLSOM STREET • SAN FRANCISCO

SUtter 3440

MALOTT & PETERSON

ROOFING AND FLOORING CONTRACTORS

20TH AND HARRISON STREETS

SAN FRANCISCO

Phone ATwater 1600

ARCHITECT AND ENGINEER

Estimator's Guide

Giving Cost of Building Materials, Etc.

AMOUNTS GIVEN ARE FIGURING PRICES AND ARE MADE UP FROM AVERAGE QUOTATIONS FURNISHED BY MATERIAL HOUSES TO SAN FRANCISCO CONTRACTORS. 2½% SALES TAX ON ALL MATERIALS BUT NOT LABOR

All prices and wages quoted are for San Francisco and the Bay District. There may be slight fluctuation of prices in the interior and southern part of the state. Freight cartage, at least, must be added in figuring country work.

BONDS—Performance—50% of contract.
Labor and materials—50% of contract.

BRICKWORK—

Common Brick—Per 1M laid—\$50.00 to \$60.00 (according to class of work).
Face Brick—Per 1M laid—\$120 to \$150 (according to class of work.)
Brick Steps—\$1.60 per lin. ft.
Brick Veneer on Frame Bldg.—Approx. \$1.30 per sq. ft.
Common Brick—\$19.00 per M, truckload lots, f.o.b. job.
\$19.00 per M, less than truckload, plus cartage.
Face Brick—\$40 to \$80 per M, truckload lots, delivered.
Cartage—Approx. \$4.00 per M.

BUILDING PAPER—

1 ply per 1000 ft. roll.....	\$3.50
2 ply per 1000 ft. roll.....	5.00
3 ply per 1000 ft. roll.....	6.25
Brownskin, Standard, 500 ft. roll.....	5.00
Sisalcraft, 500 ft. roll.....	5.00
Sash cord com. No. 7.....	\$1.20 per 100 ft.
Sash cord com. No. 8.....	1.50 per 100 ft.
Sash cord spot No. 7.....	1.90 per 100 ft.
Sash cord spot No. 8.....	2.25 per 100 ft.
Sash weights, cast iron, \$50.00 ton.	
Nails, \$3.42 base.	
Sash weights, \$45.00 per ton.	

CONCRETE AGGREGATES—

The following prices net to Contractors unless otherwise shown.

Gravel, all sizes—		
\$1.95 per ton at Bunker; delivered.....	\$2.50	
	Bunker	Del'd
Top Sand.....	\$1.90	\$2.50
Concrete Mix.....	1.90	2.45
Crushed Rock, ¾" to ¾".....	1.90	2.50

Crushed Rock, ¾" to 1½".....	1.90	2.50
Roofing Gravel.....	2.25	2.80
River Sand.....	2.00	2.45

Sand—
River Sand..... 2.00 2.45
Lepis (Nos. 2 & 4)..... 2.85 3.15
Olympia (Nos. 1 & 2)..... 2.85 3.10
Del Monte White..... 84c per sack

Cement—
Common (all brands, paper sacks), carload lots, \$2.42 per bbl. f.o.b. car; delivered \$2.72.
Cash discount on carload lots, 10c a bbl., 10th Prox.; less than carload lots \$3.20 per bbl. f.o.b. warehouse or delivered.
Cash discount 2% on L.C.L.

Atlas White.....	} 1 to 100 sacks, \$2.50 sack	
Calaveras White.....		warehouse or del.; \$7.65
Medusa White.....		bbl. carload lots.

Forms, Labors average \$200.00 per M.
Average cost of concrete in place, exclusive of forms, 35c per cu. ft.; \$10 cu. yd.; with forms, 60c.
4-inch concrete basement floor..... 30c per sq. ft.
Rat-proofing..... 7½c
Concrete Steps..... \$1.25 per lin. ft.

DAMP-PROOFING and Waterproofing—

Two-coat work, \$3.50 per square.
Membrane waterproofing—4 layers of saturated felt, \$7.00 per square.
Hot coating work, \$2.50 per square.
Medusa Waterproofing, \$3.50 per lb. San Francisco Warehouse.
Tricozol waterproofing.
(See representative.)

ELECTRIC WIRING—\$12 to \$15 per outlet for conduit work (including switches).

Knob and tube average \$3.00 per outlet. (Available only for priority work.)

ELEVATORS—

Prices vary according to capacity, speed and type. Consult elevator companies. Average cost of installing a slow speed automatic passenger elevator in small four story apartment building, including entrance doors, about \$6500.00.

EXCAVATION—

Sand, 60 cents; clay or shale \$1 per yard. Teams, \$12.00 per day.

Trucks, \$22 to \$27.50 per day.
Above figures are an average without water. Steam shovel work in large quantities, less; hard material, such as rock, will run considerably more.

FIRE ESCAPES—

Ten-foot galvanized iron balcony, with stairs, \$150 installed on new buildings; \$160 on old buildings.

FLOORS—

Composition Floor, such as Magnesite, 33c to 50c per square.
Linoleum—2 gages—\$1.25 to \$2.75 per sq. yd.
Mastapay—90c to \$1.50 per sq. yd.
BattleShip Linoleum—available to Army and Navy only—1/8"—\$1.75 sq. yd.
1/8"—\$2.00 sq. yd.
Terazzo Floors—50c to 70c per square.
Terazzo Steps—\$1.75 per lin. ft.
Mastic Wear Coat—according to type—20c to 35c.

Hardwood Flooring—

Standard Mill grades not available.
Victory Oak—T & G
3/8" x 2 1/4"..... \$143.25 per M, plus Cartage
1/2" x 2"..... 122.00 per M, plus Cartage
3/4" x 1 1/2"..... 113.50 per M, plus Cartage
PREFINISHED Standard & Better Oak Flooring
3/8" x 3 1/4"..... \$180.00 per M, plus Cartage
1/2" x 2 1/2"..... 160.50 per M, plus Cartage
Maple Flooring
3/8" T & G Clear \$160.50 per M, plus Ctg.
2nd 153.50 per M, plus Ctg.
3rd 131.25 per M, plus Ctg.
Floor Layers' Wage, \$1.50 per hr.

GLASS—

Single Strength Window Glass.....	20c per	<input type="checkbox"/> ft
Double Strength Window Glass.....	30c per	<input type="checkbox"/> ft.
Plate Glass, under 75 sq. ft.....	\$1.00 per	<input type="checkbox"/> ft.
Polished Wire Plate Glass.....	1.40 per	<input type="checkbox"/> ft.
Rgh. Wire Glass.....	.34 per	<input type="checkbox"/> ft.
Obscure Glass.....	.27 per	<input type="checkbox"/> ft.
Glazing of above is additional.		
Glass Blocks.....	\$2.50 per	<input type="checkbox"/> ft. set in place

HEATING—

Average, \$1.90 per sq. ft. of radiation, according to conditions.
Warm air (gravity) average \$48 per register.
Forced air, average \$68 per register.

IRON—Cost of ornamental iron, cast iron, etc., depends on designs.

LUMBER—All Lumber at O.P.A. ceiling prices—

No. 1 Common \$49.00 per M
No. 2 Common 47.75 per M
Select O. P. Common 52.75 per M

Flooring—

	Delvd.
V.G.-D.F. 8 & Btr. 1 x 4 T & G Flooring	\$80.00
C 1 x 4 T & G Flooring	75.00
D 1 x 4 T & G Flooring	65.00
D.F.-S.G. 8 & Btr. 1 x 4 T & G Flooring	61.00
C 1 x 4 T & G Flooring	59.00
D 1 x 4 T & G Flooring	54.00
Rwd. Plastic—"A" grade, medium dry	82.00
"B" grade, medium dry	78.50

Plywood—

	Under \$200	Over \$200
"Plycord"— $\frac{3}{8}$ "	\$49.50	\$47.55
"Plywall"— $\frac{1}{4}$ "	45.15	43.30
3 ply— $\frac{2}{8}$ / $\frac{1}{4}$ "	48.55	46.60
"Plyform"— $\frac{5}{8}$ "—		
Unoiled	126.50	121.45
Oiled	127.90	122.75

Above prices delivered if quantity is sufficient to warrant delivery.

Shingles (Rwd. not available)—

Red Cedar No. 1—\$6.75 per square; No. 2, \$5.75; No. 3, \$4.45.
Average cost to lay shingles, \$3.00 per square.
Cedar Shakes—Tapered: $\frac{1}{2}$ " x $\frac{3}{4}$ " x 25"—\$8.95 per square.
Resawn: $\frac{3}{4}$ " to $1\frac{1}{4}$ " x 25"—\$10.65 per square.
Resawn: $\frac{3}{4}$ " to $1\frac{1}{4}$ " x 25"—\$10.65 per square.
Average cost to lay shakes, \$4.00 per square.

MILLWORK—Standard.

O. P. \$100 per 1000. R. W. rustic \$100.00 per 1000 [delivered].
Double hung box window frames, average with trim \$6.50 and up, each.
Complete door unit, \$10.00.
Screen doors, \$3.50 each.
Patent screen windows, 25c a sq. ft.
Cases for kitchen pantries seven ft. high, per lineal ft., \$9.00 each.
Dining room cases, \$9.00 per lineal foot.
 Rough and finish about 80c per sq. ft.
Labor—Rough carpentry, warehouse heavy framing (average), \$40.00 per M.
For smaller work average, \$40.00 to \$55.00 per 1000.

MARBLE—See Dealers

PAINTING—

Two-coat work per yard 50c
Three-coat work per yard 70c
Cold water painting per yard 10c
Whitewashing per yard 8c

PAINTS—

Two-coat work 50c per sq. yd.
Three-coat work 70c per sq. yd.
Cold water painting per yard 10c
Whitewashing 8c per sq. yd.
Turpentine \$1.03 per gal. in drum lots.
 \$1.08 per gal. in 5-gal. containers.
Raw Linseed Oil—not available.

Boiled Linseed Oil—\$1.38 per gal. in drums. Available only to work with high priority—\$1.48 per gal. in 5-gal. containers.

Use replacement oil—\$1.86 per gal. in 1-gal. containers.

Replacement Oil—\$1.20 per gal. in drums. \$1.30 per gal. in 5-gal. containers.

A deposit of \$6.00 required on all drums.

PATENT CHIMNEYS—

6-inch \$1.20 lineal foot
8-inch 1.40 lineal foot
10-inch 2.15 lineal foot
12-inch 2.75 lineal foot

PLASTER—

Neat wall, per ton delivered in S. F. in paper bags, \$17.60.

PLASTERING (Interior)—

	Yard
3 Coats, metal lath and plaster	1.50
Keene cement on metal lath	1.80
Ceilings with $\frac{3}{4}$ " hot roll channels metal lath (lathed only)	1.20
Ceilings with $\frac{3}{4}$ " hot roll channels metal lath plastered	2.20
Single partition $\frac{3}{4}$ " channel lath 1 side (lath only)	1.20
Single partition $\frac{3}{4}$ " channel lath 2 inches thick plastered	3.20
4-inch double partition $\frac{3}{4}$ " channel lath 2 sides (lath only)	2.20
4-inch double partition $\frac{3}{4}$ " channel lath 2 sides plastered	3.85
Thermax single partition; 1" channels; $2\frac{1}{4}$ " overall partition width. Plastered both sides	3.30
Thermax double partition; 1" channels; $4\frac{1}{2}$ " overall partition width. Plastered both sides	4.40
3 coats over 1" Thermax nailed to one side wood studs or joists	1.65
3 coats over 1" Thermax suspended to one side wood studs with spring sound isolation clip	1.90

Note—Channel lath controlled by limitation orders.

PLASTERING (Exterior)—

	Yard
2 coats cement finish, brick or concrete wall	\$1.00
3 coats cement finish, No. 18 gauge wire mesh	2.00

Lime—\$3.00 per bbl. at yard.
Processed Lime—\$3.10 bbl. at yard.
Rock or Grip Lath— $\frac{3}{8}$ "—20c per sq. yd.
 $\frac{1}{2}$ "—19c per sq. yd.

Composition Stucco—\$1.50 to \$2.00 sq. yard (applied).

PLUMBING—

From \$100.00 per fixture up, according to grade, quantity and runs.

ROOFING—

"Standard" tar and gravel, 4 ply—\$8.00 per sq. for 30 sqs. or over.
Less than 30 sqs. \$9.50 per sq.
Tile, \$30.00 to \$40.00 per square.
Redwood Shingles, \$7.50 per square in place.
5/2 #1-16" Cedar Shingles, $4\frac{1}{2}$ " Exposure \$8.00 square

5/8 x 16"—#1 Cedar Shingles, 5" Exposure \$9.00 square
4/2 #1-24" Royal Shingles, $7\frac{1}{2}$ " Exposure \$9.50 square
Re-coat with Gravel \$4.00 per sq.
Asbestos Shingles, \$23 to \$28 per sq. laid.
1/2 x 25" Resawn Cedar Shakes, 10" Exposure \$10.50
3/4 x 25" Resawn Cedar Shakes, 10" Exposure 11.50
1 x 25" Resawn Cedar Shakes, 10" Exposure 12.50
Above prices are for shakes in place.

SHEET METAL—

Windows—Metal, \$1.75 a sq. ft.
Fire doors (average), including hardware \$2.00 per sq. ft.

SKYLIGHTS—(not glazed)

Copper, 90c sq. ft. [flat].
Galvanized iron, 40c sq. ft. [flat].
Vented hip skylights 60c sq. ft.

STEEL—STRUCTURAL (None available except for defense work).

\$150 ton (erected), this quotation is an average for comparatively small quantities. Light truss work higher. Plain beams and column work in large quantities \$140 per ton.

STEEL REINFORCING (None available except for war work).

\$150 to \$200 ton, set.

STONE—

Granite, average, \$6.50 cu. foot in place.
Sandstone, average Blue, \$4.00. Boise, \$3.00 sq. ft. in place.
Indiana Limestone, \$2.80 per sq. ft. in place.

STORE FRONTS (None available).

TILE—

Ceramic Tile Floors—70c to \$1.00 per sq. ft.
Cove Base—\$1.10 per lin. ft.
Glazed Tile Wainscot—\$1.25 per sq. ft.
Asphalt Tile Floor $\frac{1}{8}$ " & $\frac{3}{4}$ "—\$.18 to \$.35 per sq. ft. Light shades slightly higher.
Cork Tile—\$.40 to \$.75 per so. ft.
Mosaic Floors—see dealers.
Lino-Tile, \$.35 to \$.75 per sq. ft.

Wall Tile—

Glazed Terra Cotta Wall Units (single faced) laid in place—approximate prices:
2 x 6 x 12 \$1.10 sq. ft.
4 x 6 x 12 1.25 sq. ft.
2 x 8 x 16 1.20 sq. ft.
4 x 8 x 16 1.40 sq. ft.

VENETIAN BLINDS—

40c per square foot end up. Installation extra.

WINDOWS—STEEL—

30c per square foot, \$5 for ventilators.

CARLTON A. STEINER has moved his office from 617 Montgomery Street, San Francisco, to 2143 Eunice Street, Berkeley, California.

Built-In Fixtures for the Post-War Home

Paramount Fixtures will fit your post-war needs . . . investigate our new kitchen ideas which make for convenience and efficiency.

Paramount Built-in Fixtures meet the most exacting requirements. Our "Deluxe," "Moderne" and "Economy" cabinet fixtures are distinctive in design and construction and may be had in stock sizes or built to order.

Catalog for the asking



ROOFS DON'T LEAK

Easily applied and backed by a manufacturer's claim that one coat is equal to ten coats of paint, a new synthetic plastic mastic material called "Rubberlike" is being produced by GUARANTEED PRODUCTS of Los Angeles.

Even if the roof buckles, the material will conform to the new shape and effect ample protection against the elements.

A SUBSCRIBER WRITES

C. SUMNER GREENE, Architect
P. O. Box 1955
Carmel, California

March 15, 1945

The Architect and Engineer Inc.
68 Post St., San Francisco.
V. P. and Manager
L. B. Penhorwood.

Dear Mr. Penhorwood: I have not been active for a number of years in my professional work as an architect and this year have not renewed my license. This year sees the end of my career. Some time ago I canceled all subscriptions to other periodicals, but The Architect and Engineer kept coming and I much appreciate its forward looking spirit, its readable letterpress and its admirable and

"KIMSUL" Controlled Insulation!

THEMAL EFFICIENCY 0.27

Compressed in rolls for shipment and to save storage space, it stretches out over 5 times and when fully stretched gives a uniform designated thickness which insures the same maximum insulation value at all points.

Fire, Moisture and Vermin
Resistant
Extremely Light Clean and
Easy to Install.

GUNN, CARLE & CO.

20 Potrero Avenue
San Francisco 3
UN 5480

interesting illustrations. I sincerely wish you all success.

I am taking advantage of your kind offer and enclose check.

Appreciatively yours,
C. SUMNER GREENE.

1945 BUILDING TRADES WAGE SCALES (JOB SITES) NORTHERN CALIFORNIA

Six- and seven-hour day eliminated on all Government Work. A. F. L. - O. P. M. Agreement calls for eight-hour day.

NOTE: Predeterminations by the Department of Labor, as of July 1, 1944 (the wage-freezing date) have not yet been made in all of the counties listed. The wage scales shown are those being paid and in effect mostly by agreement between employers and their union.

CRAFT	Alameda and Contra Costa									
	San Francisco	San Francisco	Fresno	Marin	Sacramento	San Jose	San Mateo	Vallejo	Stockton	
ASBESTOS WORKERS	1.50	1.50	1.25	1.50	1.50	1.25	1.50	1.50	1.25	
BRICKLAYERS	1.87½	1.87½	1.75	1.87½	1.75	2.00	1.79-1/4	1.75	1.50	
BRICKLAYERS, HODCARRIERS	1.40	1.40	1.05	1.40	1.05	1.50	1.35	1.50	1.14	
CARPENTERS	1.50	1.50	1.25	1.43¾	1.37½	1.50	1.43¾	1.50	1.37½	
CEMENT FINISHERS	1.50	1.50	1.50	1.50	1.50	1.50	1.50	1.50	1.50	
ELECTRICIANS	1.70	1.70	1.70	1.70	1.70	1.70	1.70	1.70	1.70	
ELEVATOR CONSTRUCTORS	1.75½	1.75½	1.75½	1.75½	1.75½	1.75½	1.75½	1.75½	1.75½	
ENGINEERS: MATERIAL HOIST	1.50	1.50	1.25	1.50	1.37½	1.50	1.50	1.37½	1.25	
PILE DRIVER	1.75	1.75	1.60	1.75	1.75	1.75	1.75	1.75	1.75	
STRUCTURAL STEEL	1.75	1.75	1.60	1.75	1.75	1.75	1.75	1.75	1.60	
GLASS WORKERS	1.40	1.40	1.12½	1.40	1.12½	1.21	1.40	1.40	1.40	
IRONWORKERS: ORNAMENTAL	1.60	1.50	1.60	1.50	1.60	1.31¼	1.50	1.50	1.50	
REINF. RODMEN	1.50	1.50	1.60	1.50	1.50	1.60	1.50	1.50	1.25	
STRUCTURAL	1.75	1.75	1.75	1.75	1.75	1.75	1.75	1.75	1.37½	
LABORERS: BUILDING CONCRETE	1.00	1.00	.90	.87½	.95	.90	.93¾	.95	.90	
	1.00	1.00	.90	.87½	.95	.90	.93¾	.95	1.00	
LATHERS	1.75	1.75	1.50	1.75	1.60	1.75	1.75	1.75	1.75	
MARBLE SETTERS	1.50	1.50	1.50	1.50	1.50	1.50	1.50	1.50	1.50	
MOSAIC & TERRAZZO	1.25	1.25	1.12½	1.25	1.15-5/8	1.12½	1.42-6/7	1.64-2/7	1.37½	
PAINTERS	1.50	1.50	1.28-4/7	1.50	1.43	1.50	1.50	1.54	1.54	
PILEDRIVERS	1.54	1.54	1.54	1.54	1.54	1.54	1.54	1.54	1.54	
PLASTERERS	1.75	1.83½	1.75	1.75	1.75	2.00	2.00	1.75	1.83-1/3	
PLASTERERS' HODCARRIERS	1.50	1.60	1.40	1.50	1.18¾	1.50	1.75	1.50	1.50	
PLUMBERS	1.70	1.70	1.53-1/8	1.70	1.68¾	1.62½	1.70	1.70	1.50	
ROOFERS	1.50	1.50	1.37½	1.37½	1.37½	1.37½	1.25	1.37½	1.37½	
SHEET METAL WORKERS	1.50	1.50	1.50	1.50	1.50	1.50	1.37½	1.50	1.50	
SPRINKLER FITTERS	1.58	1.58	1.53-1/8	1.70	1.68¾	1.62½	1.70	1.70	1.50	
STEAMFITTERS	1.75	1.75	1.53-1/8	1.70	1.68¾	1.62½	1.50	1.70	1.50	
SETTERS (MASONS)	1.87½	1.87½	1.87½	1.50	1.75	1.75	1.75	1.75	1.50	
TILESETTERS	1.50	1.50	1.37½	1.50	1.37½	1.50	1.50	1.50	1.37½	

Prepared and compiled by

CENTRAL CALIFORNIA CHAPTER, ASSOCIATED GENERAL CONTRACTORS OF AMERICA

with the assistance and cooperation of secretaries of General Contractors Associations and Builders Exchanges of Northern California.

MULLEN MFG. COMPANY

BANK, STORE AND OFFICE
FIXTURES—CABINET WORK
OF GUARANTEED QUALITY
CHURCH SEATING

Office and Factory:
40-80 RAUSCH ST., Bet. 7th and 8th Sts.
San Francisco
Telephone UNderhill 5815

THE TORMEY COMPANY

GENERAL PAINTERS
AND DECORATORS

Phone UNderhill 1913

563 FULTON STREET
San Francisco

G. P. W. JENSEN & SON

Building Construction

320 Market Street, San Francisco
Phone: GARfield 2444

JOHN CASSARETTO COMPANY

—Since 1886—And Still Active—

Building Materials

READY MIX CONCRETE
ROCK - SAND - GRAVEL - LIME
CEMENT - PLASTER - MORTAR
METAL LATH - WOOD LATH
STUCCO - WIRE NETTING

Service Unexcelled

Bunkers
Sixth and Chennel, San Francisco
Phones: GARfield 3758 - 3760

IN THE NEWS

ARCHITECT STUDENTS IN U. S. S. R.

Apparently the Russians have found time to return to attention to the career of the architect, to an extent anyhow, for a decree of the Council of People's Commissar has opened up the Moscow Institute to one thousand students. During the war the students gave a good account of themselves, both in the sphere of learning and the methods of overcoming difficulties engendered by war conditions.

The training in architecture equipped the students to be of great value in camouflage work and in construction work, something that has been somewhat overlooked in this country. It was also learned that these students could orient themselves at a glance and locate desirable military installations where proper camouflage could be installed.

In the work at the Institute a student must now be a builder as well as a designer for in all likelihood he will be called to the front where a large part of his work will be rebuilding, often with their own hands, as was necessary in one instance where the Institute allowed thirty-six hours, in training work, to do the job. They are also put to work cutting fire wood and planting vegetables and gardens.

The digging of trenches, splitting fire wood, planting vegetables, coupled with camouflaging gun emplacements, designing buildings and bridges, boulevards and public squares, would seem like a queer architectural course to an American student, but that the Russian student likes it is proved by the fact that there were several hundred applications for only one hundred and fifty vacancies.

DINWIDDIE CONSTRUCTION COMPANY

•
BUILDERS
•

CROCKER BUILDING
SAN FRANCISCO



HERRICK IRON WORKS

STRUCTURAL STEEL
REINFORCING STEEL

18TH AND CAMPBELL STS.
OAKLAND, CALIF.
Phone GLencourt 1747

Phone GARfield 1164

Thomas B. Hunter

Consulting Engineer

DESIGNER OF HEATING
AIR CONDITIONING
VENTILATING AND WIRING
SYSTEMS, MECHANICAL
AND ELECTRICAL EQUIP-
MENT OF BUILDINGS

41 SUTTER STREET

ROOM 710
San Francisco California

ANDERSON & RINGROSE

General Contractors

320 Market Street, San Francisco
Phone GARfield 2245

ARCHITECTURE AND ENGINEERING



MAY

1945

**The experience of over
4,000 acoustical installations
...is at your service**



Acousti-Celotex installation—office of the Western Pacific Railroad Co., San Francisco



Sound conditioning increases efficiency at The Western Union Telegraph Co., Oakland



Acousti-Celotex provides quiet in these offices, Kraft Cheese Co., San Francisco



Sound conditioned assembly and motor test room, Caterpillar Tractor Co., San Leandro



Acousti-Celotex sound conditioning, general office, Fairbanks, Morse & Co., San Francisco



THE great reservoir of our experience, gained in over 4,000 acoustical installations, is daily solving sound conditioning problems in all types of offices and factories.

This practical knowledge is available to you *only* through Western Asbestos Co., for our organization has analyzed, engineered and installed more sound conditioning in this area than any other firm in the acoustical field.

The combination of this experience with the world's most widely proved and used acoustical materials—Acousti-Celotex products—is your complete assurance of a job well done. The counsel and recommendations of a sales engineer are at your service, entirely without obligation.

WESTERN ASBESTOS CO.

DISTRIBUTORS • ENGINEERS • CONTRACTORS

YOUR BLOOD CAN SAVE LIVES—BE A DONOR TODAY!

• ARCHITECT

Vol. 161 No. 2

ARCHITECTS' REPORTS—Published Daily
Telephone DOuglas 8311

AND ENGINEER

MARK DANIELS
Editor

E. H. WILDER
Associate Editor

MICHAEL GOODMAN
Post-War Planning

L. H. NISHKIAN
Consulting Editor

E. N. KIERULFF*
Ass't Editor
*In the Service

Contents for



MAY

COVER: Entrance to Permanente Foundation Hospital,
Oakland, Calif.

ARTICLES AND MISCELLANEOUS TEXT

	Page
RUNNING FIRE	By Mark Daniels 4
LOWER-FIRED MONOCHROMES	By Chungwah Lee 6
MAJOR CLEMENT R. ATTLEE, Illustration	7
COVER PICTURE	8
WAR TORN CITIES, Illustration	8
IN THE NEWS	9-32-35-39-42-46
THE PERMANENTE FOUNDATION HOSPITAL	By Mark Daniels, A.I.A. 10
Plans and Illustrations	10-11-12-13-28-29-30-31
THREE DIMENSIONAL DESIGNING	By Mardi 14
POST-WAR AIRPORTS	By Frederick Kinsey Dupuy 16
A BUILDING BOOM SOUTH OF THE BORDER	
By Wm. Arthur Newman, Architect	20
TREES IN ARCHITECTURAL RENDERING	33
LEONARDO DA VINCI	34
WITH THE ENGINEERS	36
A.I.A. ACTIVITIES	37
PRODUCERS' COUNCIL PAGE	40
BOOK REVIEWS	41
ESTIMATORS' GUIDE	43
BUILDING TRADES WAGE SCALES	45
INDEX TO ADVERTISERS	48



ARCHITECT AND ENGINEER (Established 1905) is published on the 15th of the month by The Architect and Engineer, Inc., 68 Post St., San Francisco 4; Telephone EXbrook 7182. President, K. P. Kierulff; Vice-President and Manager, L. B. Penhorwood; Treasurer, E. N. Kierulff; Advertising Manager, V. E. Atkinson, Jr.

Los Angeles Office: 403 W. 8th Street.

Entered as second class matter, November 2, 1905, at the Post Office in San Francisco, California, under the Act of March 3, 1879. Subscription United States and Pan America, \$3.00 a year; \$5.00 two years; foreign countries \$5.00 a year; single copy 50c. ARCHITECTS' REPORTS are published daily from this office, Vernon S. Yallop, Manager.



RUNNING FIRE — by MARK DANIELS

CHINATOWN—DELEGATES TAKE NOTE

San Francisco's Chinatown is the largest Chinese city in the world outside of China. If your itinerary does not include a jaunt to our beloved neighborhood's home across the Pacific you may see many places here of charm and interest that equal or surpass their forebears in China.

At 520 Pine Street is the Chinese Temple of Kong Chow, dedicated to Kuan Ti, the god of courage. That temple has exerted a good influence over the residents of Chinatown who have grown in number through the decades to their present population of twenty-five thousand.

At number seven, Old Chinatown Lane, is the studio of Mr. Chingwah Lee where is housed one of the largest collections of rare Chinese porcelains and objects of art to be found in this country. Porcelains and potteries, some over 4,000 years old, are there to be seen but not sold. Though Mr. Lee's priceless collection is not for sale you will find your pleasure in viewing it will be equalled only by that of Chingwah Lee in showing it to you.

And then there is the Mandarin Theater at 1125 Grant Avenue where a traveling troupe, that came to San Francisco from Canton just before Pearl Harbor, produces plays in the old Chinese way. Drop in for a few minutes and don't worry about seeing the play through, for sometimes that takes all night.

By all means visit what might be called the Chinese Community Center, the building and home of the Chinese Six Companies at 843 Stockton Street. The Telephone Exchange also will open your eyes, particularly to the alertness of the operators who are all Chinese girls, and you will see one reason why so many of us employ Chinese girl secretaries. And above all don't think that the universal courtesy with which you are treated in Chinatown is just put on for this Conference. The Chinese are born that way.

TIPS TO VISITORS AND DELEGATES

When in San Francisco look before you leap—from a car on an inside track on Market Street.

If you drive a car it is best to keep to the right no matter what you see others do or what is your custom at home. You may see motorists driving on all sides and in all directions but that is only our way of showing that this is a free country.

Yes, the flowers you see on so many corners of down town streets are real. No. They are for sale.

If you meet a San Franciscan who keeps his eyes centered on the lower part of your face, don't be disturbed. He is not admiring your beard or the lack of one. He is only another one of us who have taken up lip-reading to enable us to carry on a conversation on Market Street.

"I SINK SO: 'SCUSE, PLEASE"

With sweet, kindly and loving thoughts Mr. Samuel H. Wainright, Jr., came out, about ten years ago, with his book entitled, "Beauty in Japan." No one questions that there is beauty in Japan but the book contained implications that one of the beauties of Japan was the love and kindness of the Japanese for all living things. He says, "The Japanese feel that every living thing has a right to its life and are loath to kill even a common enemy." What a lot of "loathing" those dear little Japs, who love all living things, must have done in China and the Philippines since Mr. Wainright wrote his book.

FOR HOME CONSUMPTION

Like so many other government bureaus in California that are operated under the direction of a head three thousand miles away, the O.P.A. in this city must operate under a blanket of orders and regulations that are trucked out from Washington. And "trucked" is about right, for of the M.P.R. list alone there are, as this is written, 481 regulations now operating.

How many other regulations other than Maximum Price there are through which a C.P.A. must wade before he can safely make out a client's income tax, heaven only knows. The amendments to these regulations run into the thousands and they must all be checked. The chief file clerk has a real job.

AUSTRALIAN ARCHITECT VISITS U. C. CAMPUS

Percy E. Everett, chief architect in the department of public works of the State of Victoria, Australia, was a recent visitor to the Medical Center on the San Francisco campus of the University of California.

Everett is touring the United States visiting outstanding clinics and hospital installations. While at the University he has been studying the plans for the new 500-bed teaching hospital which is to be constructed on the campus. He also inspected the dental clinic under the guidance of Dr. Willard C. Fleming, dean of the School of Dentistry.

Get Set Now—To Take Full Advantage of the Postwar Building Boom!

MANY SUBSCRIBERS to Architects' Reports (a daily advance building news service, reporting construction projects for the Northern California area) have told us that for one contract secured through these reports, they have made a profit that would pay for the service for many, many years to come.

THIS SERVICE comes to subscribers in the form of handy, individual slips, giving name of project, location, architect, proposed cost and other pertinent and valuable data. These are mailed daily and the current average is about 500 monthly.

BUILDING MATERIAL DEALERS and contractors in the San Francisco Bay region use Architects' Reports to supply their salesmen with good prospects. The compilation cost of these reports is very expensive, yet the service is available to subscribers at the nominal charge of \$10.00 per month, or about two cents per report.

NOW IS THE TIME for you to get set for the postwar building boom by incorporating this valuable service in your sales program. Order your trial subscription now or telephone EXbrook 7182 or DOuglas 8311 requesting samples.

ARCHITECTS' REPORTS

Published by

THE ARCHITECT AND ENGINEER, INC.

68 Post Street, San Francisco 4



Left to right: Brushwasher with medium fired huang lu huan or tiger skin glaze, four-sided bottle with kua pi lu or cucumber green glaze, rice bowl with chiao lu or delicate green composite glaze, bottle with mi se or mustard fish-roe glaze, brushwasher with painting in underglaze blue, high-shouldered vase with tea dust glaze, brushwater with transmutation glaze, and reclining lion with medium fired turquoise and violet-blue glaze. Seventeenth and eighteenth century porcelain. On display currently at the Chingwah Lee Gallery in Old Chinatown, San Francisco.

Lower-Fired MONOCHROMES

By CHINGWAH LEE

During the seventeenth and eighteenth centuries lower fired monochromes were made in large number in China, especially at the porcelain center Ching-te Chen. These monochromes, usually in the form of dainty eggshell porcelain and constituting most of the "cabinet pieces" of collectors, intrigue us not only with their variety but by their technical excellency. They may be divided into two classes, the medium fired glazes or couleurs de dumei grand feu and the muffle kiln enamels or couleurs du petit feu.

The glazes of the demi grand feu—leaf green, turquoise, yellow, violet-blue and aubergine—are taken from the san ts'ai (medium fired polychrome) palette and are alkali lead silicate glazes

of Ming origin. They are usually applied sur biscuit (glazed directly on the body material) and are typically thicker when used as a monochrome than when used in combination with other colors. Many have a pottery basis, and these latter are usually moulded and constitute the architectural pottery for the exteriors. The Ming glazes often have a cloudy appearance and are applied over vigorously designed wares, while post-Ming productions are limp and lustrous and are applied over trimmer forms. The better ones have incised or carved decoration under the glaze.

The medium fired leaf green and aubergine are called chiao lu and chiao lan; the word chiao meaning "watered," perhaps in the sense of di-

NEWS AND COMMENT ON ART

luted or it may be employed indiscriminately to any clear glaze. Another chiao (delicate) is sometime used on medium fired glazes, but more often it is reserved for the brighter glazes to be described later.

During the Ming dynasty the sur biscuit medium fired yellow is called kan Huang (reddish or deep yellow) and is likened to the surface of steamed chestnuts (cheng li). Two shades appeared to be developed after the Ming period, an egg-yolk or imperial yellow and a lighter straw yellow. Yellow, green and aubergine glazes are sometime applied as a motley of colors on a single piece, resulting in a polychrome called tiger skin or Huang lu huan (yellow and green spotting).

The medium fired turquoise glaze of this period is very beautiful, the majority of them having fish-ro crackles. The turquoise is sometime of a greenish hue when they are known as k'ung ch'iao lu (peacock green) and sometime of a bluish hue, when they are generally called fei ts'ui (kingfisher blue). The finest kingfisher blue of the K'ang Hsi period goes by the name of chi ts'ui (lucky blue), why we do not know. Chinese connoisseurs attribute the blue glazes to the Chi Chou kilns of the Sung dynasty, and this kingfisher may well have been a contraction of the term lang chi chou fei ts'ui (imitation fei tsu of Chi Chou). Some turquoise are splashed with aubergine or violet-blue, and in some rare instances, with a greenish black. Other turquoise develops metallic specks or tieh siu hua. A thinly coated pale turquoise which is without crackles goes by the name of shih ch'ing (stone blue-green).

There is a thick translucent, dark violet blue with fish-ro crackles which is closely related to the turquoise and is called k'ung ch'iao lan (peacock blue) by most collectors. Other medium fired blues are called chiao lan (aqueous blue).

The colors of the muffle kilns are from two palettes, the famille verte palette and the famille rose palette. As noted before the famille verte palette includes several shades of green, a yellow, an aubergine, a deep blue and a coral red and dry black which are not clear enamels but more in the nature of pigments. The clear enamels, if applied sur biscuit are very similar to the medium fired glazes but are generally brighter and lighter. They are named the same as the corresponding medium fired glazes, chiao (aqueous), although they have been known to be called chiao (delicate) and ts'ai (enamelled) also. When applied overglaze (coating the enamel on a vessel which had been covered with a clear glaze and then

fired) the color is a deep brighter turquoise (lustrous). They are invariably called chiao (delicate colors).

The color green received special attention when Tsang Ying-hsuan was the director of the imperial kilns. When used for painting or pencilling the color is called ts'ai lu (green enamel). When used sur biscuit it is called indiscriminately chiao lu (aqueous green) or chiao lu (delicate green), and when used overglaze, chiao lu (delicate green). (See Page 34)

ART OF THE UNITED NATIONS EXHIBITION

As a fitting event during the Conference on International Organizations, the de Young Museum is holding a specially assembled exhibition, "Art of the United Nations," opening the first week in May. Representing each country will be one work, or group of works, from the fine and decorative arts, old and contemporary. A unique and attractive installation has been planned. Museums and private collectors throughout the country, as well as the U. S. State Department and foreign government representatives, are generously cooperating to make the exhibition one of the outstanding offerings of this momentous occasion.



MAJOR CLEMENT R. ATTLEE: Deputy Prime Minister and Lord President of the Council.

Mr. Attlee is leader of the Labor Party in the House of Commons.

COVER PICTURE

The view shown on the cover is one that is familiar to everyone who travels out Broadway in Oakland. The taller building is the old Fabiola Hospital, remodeled, and now known as the PERMANENTE FOUNDATION HOSPITAL. It is the work of Birge M. Clark, Architect, of Palo Alto, as designer. The actual construction work was done by Cahill Brothers whose work is well known to the building industry throughout the West.

But even contractors of Cahill Brothers' known ability cannot erect a building of such beauty and success in the practical field without the aid of first class sub contractors and craftsmen. It must have taken some time to assemble such a group of subs as the MATSON ELECTRIC EQUIPMENT COMPANY, who put in all such equipment AND the communication system, with the SCOTT COMPANY handling the mechanical equipment, the PATTERSON BROTHERS the painting and decorating; the Hollenbeck-Bush Planing Mill Company supplied the mill work. Drinking fountains were installed by HAWS FAUCET CO. Flagstone terrace, steps and walls were supplied and in-

stalled by PERSONS & WIK. Floors in operating rooms and corridor lobbies installed by AMERICAN TERRAZZO CO.

THE WESTERN ASBESTOS COMPANY supplied and installed all that most essential item in a modern hospital, the sound proofing. A walk through the corridors testifies to the effectiveness of the job as do the letters of approval from the management.

And the completion of this hospital, like all other important projects, called for the cooperation of a group of capable sub-contractors even though the general contractor was of the best. The result is the best testimonial that can be desired.

NAVY CONTINUES BUILDING

The Navy Budget for the fiscal year of 1946 for Northern California include the principal items for:

Mare Island	\$ 2,187,000
Hunters Point Drydocks	40,139,000
San Francisco Bay Area	1,034,000
Camp Parks, Shoemaker	1,044,000
Alameda, N.A.S. (Various)	4,702,000

The above partial budget should make a considerable hole on the list of the 1946 unemployed.

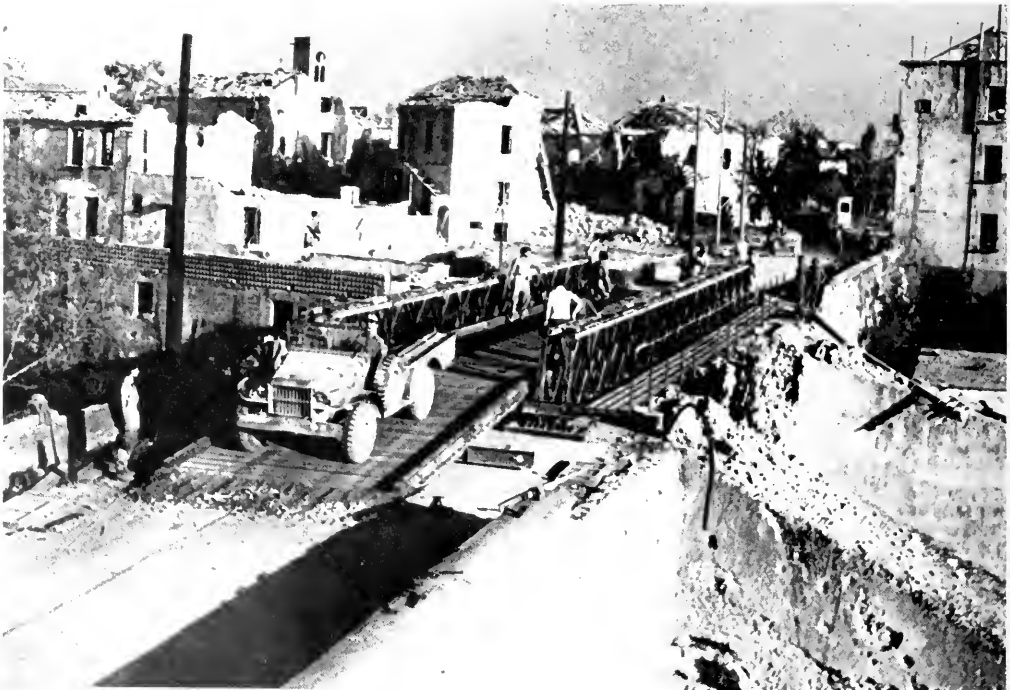

WAR TORN CITIES will have to be rebuilt.

Architects and Engineers the world over have a tremendous post-war responsibility.

Photo courtesy British Information Service

IN THE NEWS

STATE ARCHITECTURAL EXAMINERS

Effective on April 16, 1945, the State Board of Architectural Examiners began operation of a full time office staff at Los Angeles and San Francisco, for the benefit and convenience of the public and the profession.

Offices in Los Angeles are located in Room 907 State Building, while the San Francisco offices are located in Room 611, State Building.

A new policy in examination procedure has been adopted by the board in its endeavor to materially expedite the grading and issuance of the results of written examinations scheduled for June 25-28, 1945.

Amendment of board rules also provides for "Title" of the Architectural design problem to be known to registrants before any schedule written examination.

The subjects in Group I of the written examination have been scheduled for History and Theory, Monday, 1:30 to 5:30 p.m., and Architectural Design Problem, Tuesday, 8:30 a.m. to 8:30 p.m.

THE UNITED STATES CHAMBER OF COMMERCE has come out strongly against labor's efforts to exact a royalty from employers, such as the one proposed in the mining of coal. The Chamber is supporting the proposed legislation of S. 754 by Senator Bailey and referred to the Judiciary Committee.

LEONARD H. FORD, architect, has opened offices at 1350 Main Street, Walnut Creek, California, for the continuation of his practice. His phone number is Walnut Creek 2374.

LOS ANGELES ARCHITECT, MR. K. D. DENNY, who has done many homes for prominent Hollywood stars, has moved to Lafayette, California, to join the forces of Mr. Sewall Smith. He will be joined there in May by Mr. Carl Arras of New York. These additions to the working force should place Mr. Sewall Smith's office in Lafayette in an enviable position for turning out work.

The defeated bond issue of \$820,000 in San Mateo County included a \$70,000 police station and a branch police station for \$68,000. Of course, there is no significance.

HUNTER'S POINT will see another large housing project started soon when the plans of Donald P. Smith, Hyman & Appleton & H. N. Wolfard, which have been bid in by the Midstate Construction Company for \$309,000 are started in construction.

THE COMPLETION of Alameda County plans for the J. C. Penny Company's \$1,000,000 addition and remodeling job in Oakland cost about a half million dollar right in the tremendous post-war program.

THE GENERAL CONTRACT for 216 dwelling units in Concord, Contra Costa County, designed and planned by Reynolds & Chamberlain and Anshen & Narbett was let to MacDonald and Kahn for \$450,000.

LUMBER AFTER THE WAR

Conclusions encouraging to distributors, dealers, builders and architects regarding the future of the logging and lumber manufacturing industries are contained in a new booklet released by the American Forest Products Industries, Inc.

The article was prepared by S. R. Black, vice-president of the Weyerhaeuser Sales Company, St. Paul.

POST-WAR STEEL CASEMENTS

The Soule Steel Company has come out with the first of a series of folders embracing data on post-war types and sizes of residential steel casements as approved and recommended by the Metal Window Institute. These folders, which will appear periodically, include ten different forms of residential windows and casements with scale drawings that will give the architect all the information he may need in planning that form of window, be it in a wood frame, wood and stucco, brick veneer or solid brick. Also shown are screen details and hardware. A collection of these folders will constitute a valuable portfolio on steel windows that any architect's office will find valuable.

ALL ALUMINUM INDUSTRIAL LADDERS

A complete line of industrial ladders in all-aluminum tubular rail and channel construction is being announced by the Duo-Safety Ladder Corp., 809 9th Street, Oshkosh, Wis.

The construction offers the advantages of light weight plus greater strength and safety and is made in single and extension models.

A pamphlet is available by writing the company.

Bids on the general contract have been received for the construction of 36 family dwelling units in Stockton as planned by CLARENCE O. PETERSON & W. R. SPACKMAN, of 604 Mission St., San Francisco.

Oscar G. Knight has moved from 4555 Alabama Street, San Diego, to 2522 Boundary Street of the same city.

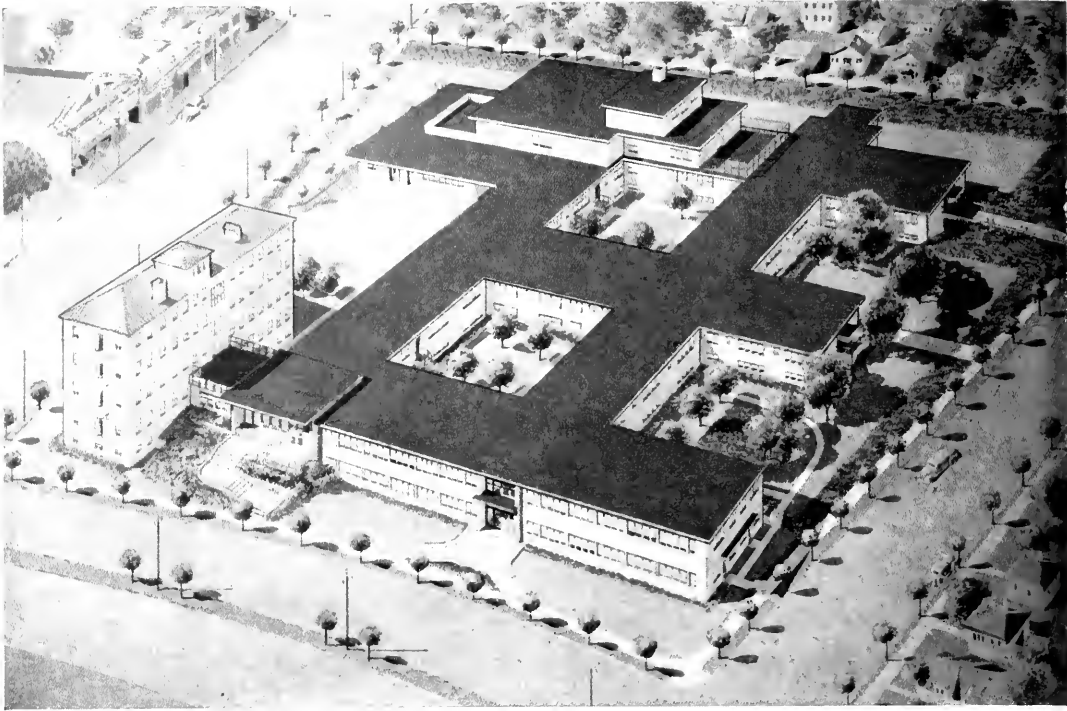

GENERAL VIEW OF THE PERMANENTE FOUNDATION HOSPITAL, Oakland, California
BIRGE M. CLARK, A.I.A., ARCHITECT

The Permanente Foundation Hospital

By **MARK DANIELS, A.I.A.**

At the corner of Broadway and MacArthur Boulevard in Oakland the Kaiser Industries has built their largest hospital. It operates in conjunction with two other units, the field hospital and the seven first aid stations within the shipyards. All are under the able direction of Sidney R. Garfield, M. D.

If, as he has stated, Dr. Garfield's first thought is to prevent illness and keep people well, he has admirably adapted the atmosphere of this institution to that purpose, for on first inspection there is little that is "hospitalish" about the place. The familiar odors that we associate with hospitals are absent.

RIGHT: Front Elevation, . . .
 Second Floor Surgery and
 Partial Roof Plan.

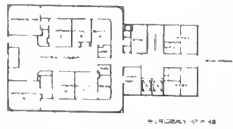

LOWER: First Floor Plan . . .
 a Unit in the Great Health
 Plan of the Kaiser Indus-
 tries.

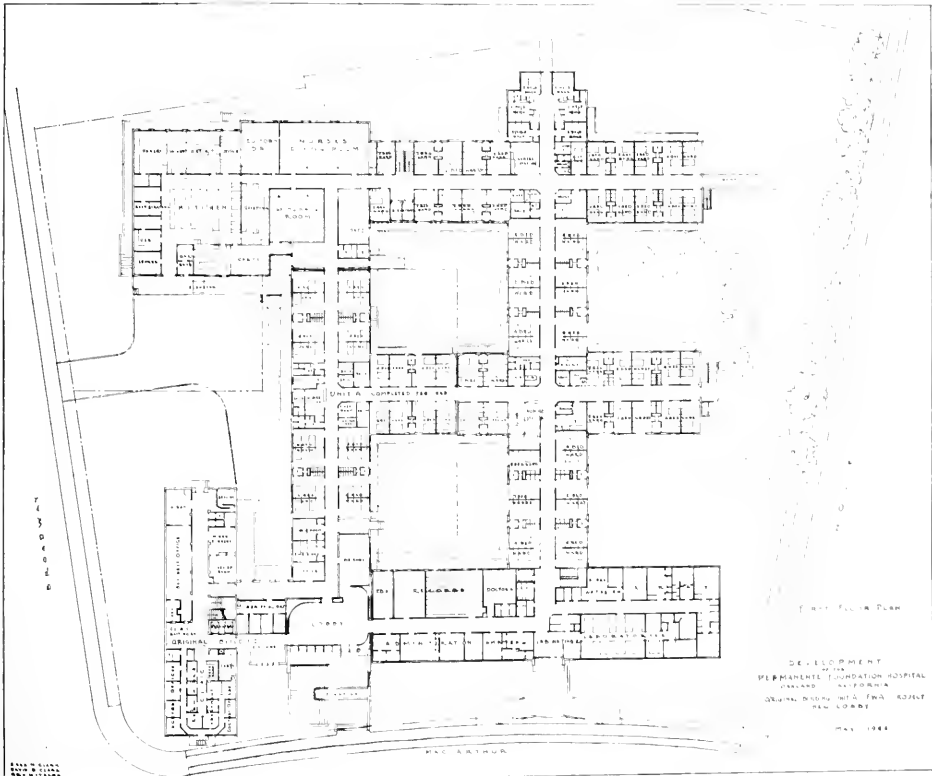
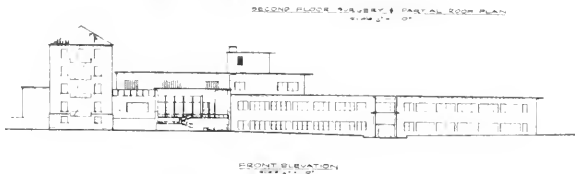

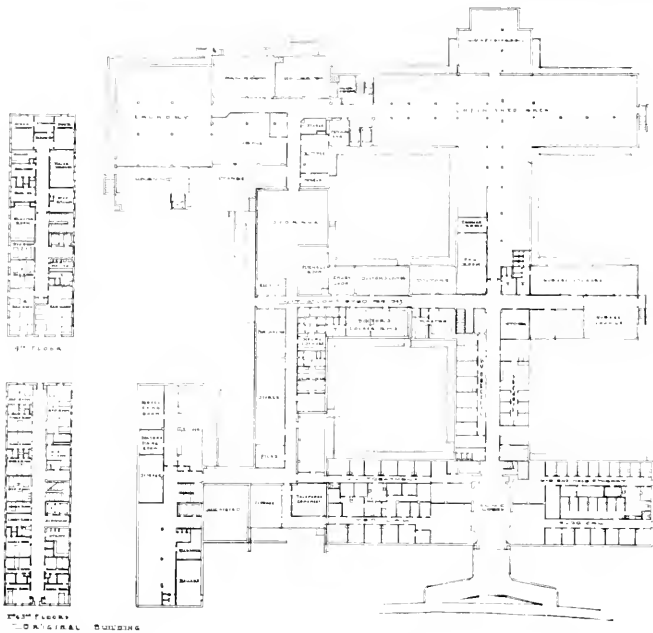

LEFT: Additional Floor Plans.
 Details of Fourth Floor at
 extreme left.

LOWER: Photograph of Mac-
 Arthur Boulevard Entrance
 to Hospital. Showing origi-
 nal building in back and
 new construction in fore-
 ground.

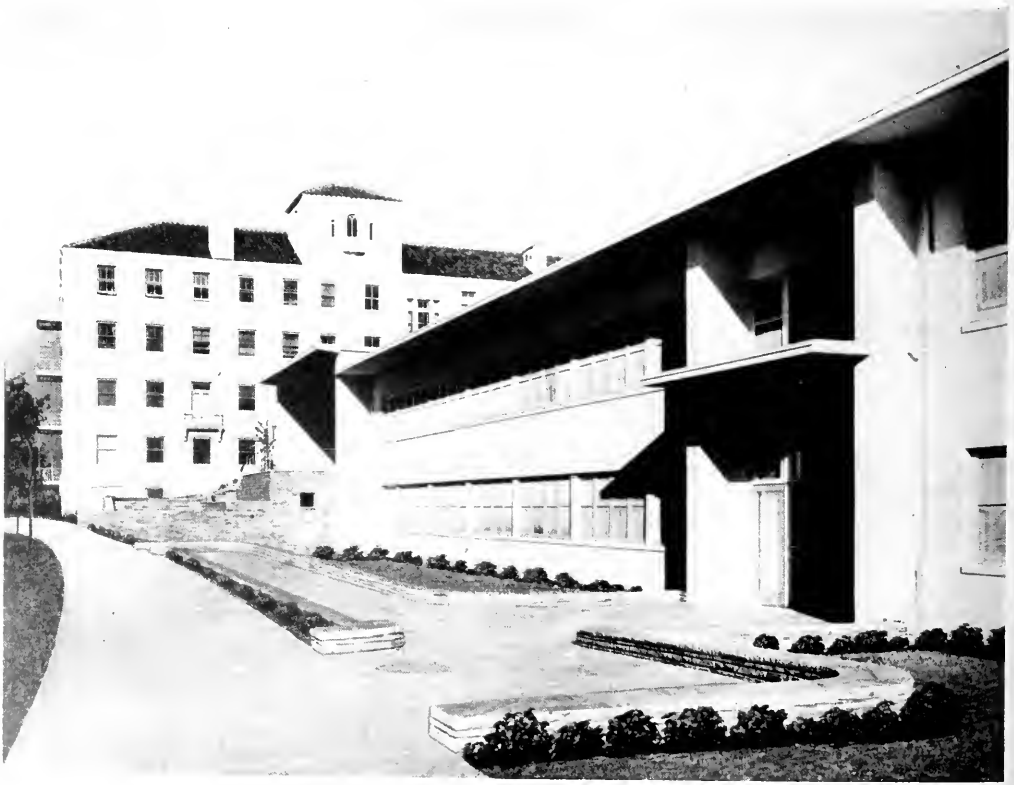

BIRGE M. CLARK, A.I.A., ARCHITECT

Cahill Bros., General Contractors
 ARCHITECT AND ENGINEER

A visit there preparatory to writing this article leaves one in about the same frame of mind as would an Italian kitchen without the use of spices. No antiseptics, no chloride of lime, no artificial acid odors; just sweet, clean pure air that all can smell in any of the public rooms or corridors.

Nor so long ago we would have said, as we did in the days before anesthesia, "Taint right. It's wicked." Nor is the lack of the old time hospital odors all that is missing in the discarded elements of hospitals as we knew them.

The halls are wide, clean and open to outside air and light; the reception rooms are furnished in good taste in a restrained domestic style; the patients' rooms are simple, comfortable and attractive; there are outside, lawn covered courts of

open air, where, when the weather is good, the patients can enjoy the sun and fresh air.

If after a long illness you are able to get out of bed, why not go to the hospital? You will at least, without any special effort, find good hospital care, good food, good nursing, good hospitalization, good treatment, good permanent Foundation Hospital, in California, wherever you are.

An analysis of the principal modern hospital institutions operate in the Kaiser's Institute is too lengthy and more or less outside the scope of this article. Suffice it to say that the plan incorporates the three major principles, patient, patient, group practice, and adequate facilities. During the two years or so that the plan has been functioning the hospital has served the medical needs of over 80,000 in its area, and this was done (See Page 28)



FLAGSTONE STEPS and Porch of MacArthur Boulevard Entrance to Kaiser's Permanente Foundation Hospital at Oakland, California



PHOTOGRAPH OF ACTUAL SCALE MODEL

Harold Wallace, Interior Decorator

Three Dimensional Designing

By MARDI

Many people and most architects feel that one does not need to show a plan in three dimensions, that his T-square and triangles are all that an architect needs to work out his plan. Perhaps he can work out what he has in mind without resorting to anything in a third dimension but, as is said of some bureaucratic offices, you don't have to be crazy to work in them but it helps a lot.

In addition to the help that a third dimension gives to the designer in his effort to see clearly the various elements of his composition it greatly helps to avoid oversights or outright mistakes. For these reasons, and others, many designers are returning to the practice of making models, even of small projects. Large buildings are nearly always produced in models before they are finally approved, but many architects also are making models of small structures including interiors.

The pictures here shown are from photographs of a scale model of an interior made exactly to scale showing the detail of the room as it was planned. Needless to say, they carry a conviction

that no plan and elevation could convey, no matter how well drawn. It is also quite in the cards that such accurate models might show the designer WHAT NOT TO DO.

A story is told of Stanford White and his decision that a model of a building he had planned for New York was needed. He was never a man to do things in a small way so he had a full scale replica of the facade built in New Jersey and completed his design after he had studied the full scale model. If you were requested to design a sixty story building the cost of a full scale model would stump you, in fact it would stump anyone but Stanford White. Just how large a building can be before the size makes a good scale model run the cost of designing out of proportion to the job must be determined by the architect, but the practice of three dimensional designing is rapidly becoming more popular in the major offices in England, France and Russia. Perhaps in this country we yet may see many architects include a model room in their offices. Also see illustration on opposite page.

COLOMBIA-PANAMA TRADE OPPORTUNITY

If you are seeking an outlet for your products in the Pan American countries of Colombia and Panama, the following may interest you:

LUIS FERNANDO PRADA

Manufacturers' Agent

Avenida "A" Esquina Calle 10, No. 70-33

Barranquilla, Rep. of Colombia

Barranquilla, Colombia Rep. February 15, 1945

The Architect and Engineer, Inc.

68 Post Street

San Francisco, California

Dear Sirs:

I have the pleasure in informing you that I am very interested in your publication and please send me subscription rates and if possible a copy of your last edition.

At the same time, please be informed that I am very interested in securing the Sales Agency for Colombia and Panama Republics for some U. S. manufacturers of builders hardware, paints, cement, wall glazed tiles, fiber board for ceiling, reinforcing steel, plumbing and sanitation articles and all allied lines with the construction business.

I will appreciate you very much in giving my address to some of your advertisers interested in the export trade. For information on myself any interested party may apply to The National City

Bank of New York, Panama, Republic of Colombia, through The National City Bank of New York, Foreign Department, New York City.

With my best thanks for any and all information rendered by you and pending with me, I beg to give you valued news. I beg to remain

Very truly yours,

LFP: P. (Signed)

Luis Fernando Prada

HOME PLANNING INSTITUTE

Free guidance of experts in all phases of post-war home planning will be available to thousands who attend the San Francisco Home Planning Institute April 9 to June 14.

Conducted by the Department of Adult Education of the San Francisco Public Schools, the Home Planning Institute will be held in four conveniently located high schools. Weekly lectures, 7:30 to 9:30 p. m., will be given Mondays at Aptos Junior High School, Upland Avenue and Aptos Avenue; Tuesdays at Galileo High School, Van Ness and Francisco Street; Wednesdays at Mission High School, 18th Street between Dolores and Church Streets; and Thursdays, Polytechnic High School, Frederick Street between Arguello Boulevard and Willard Street.

Outstanding authorities and specialists in twenty allied home planning fields will be featured lectures on the Institute programs.



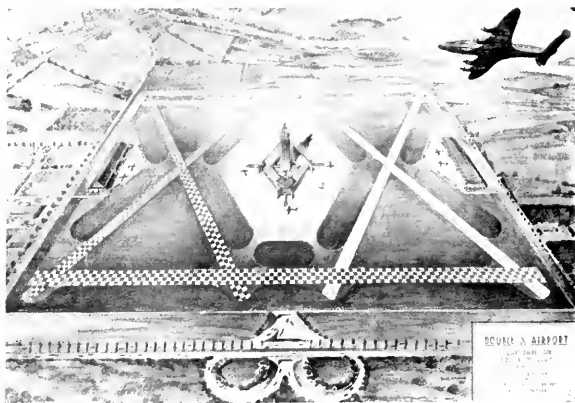

DOUBLE "X" AIRPORT

D. D. STONE, & LOU B. MULLOY, ARCHITECTS

POST WAR AIR PORTS

By **FREDERICK KINSEY DU PUY**

Airport Engineer

Immediately after the war the National Airport Program will expend over \$1,000,000,000 for the construction of several thousand new airfields and for the enlargement of several thousand existing airports throughout the United States. The costs of the land and buildings will be in addition to this \$1,000,000,000. Is even this large amount sufficient to take care of the housing, servicing and operation of our post-war aircraft? Many think that this \$1,000,000,000 program is only a part of the amount really needed for airports.

Obviously, these airports will be located near community centers so that travel time from city to airport may be reduced to a minimum. This basic requirement of close-in airports necessi-

tates large amounts of level and expensive land to increase the size of existing airports and even more expensive land for the new and additional airports.

If post-war civil and commercial aviation increases, as is conservatively expected, the airport problem is going to become serious. Good airport locations, near a city, with all the necessary requirements, are hard to find.

After locating a proposed airport site, we must also acquire, or zone, large amounts of adjacent and surrounding land to preserve a 40 to 1 glide angle. Highways, utilities, drainage and numerous other items make airports very expensive. Therefore, why could we not practice good en-

gineering and endeavor to increase the frequency—that is, try to design an airport which will permit of a higher frequency of landings and take-offs. Obtain the maximum usage out of the certain site under consideration by the use of an efficient design!

As long as land and capital are limited, let us get all the possible traffic in and out of the available acreage. The prime purpose of employing experienced engineers and contractors is to secure maximum results from the minimum capital expended. Could we not really design an airport instead of just constructing makeshift improvements from time to time on a former pasture airport? The majority of our commercial airports have developed in a haphazard manner over a period of years. An intelligent Master Plan would have eliminated many costly mistakes.

Aviation terminology refers to an aircraft landing, unloading, refueling, loading and take-off as a "movement." We are, therefore, interested in the maximum number of safe "movements" that an airport will permit in a given period. We must also design for peak loads and low visibility weather. Consider the movement frequency at any of our present day commercial airports. Obviously, if this frequency per hour could be doubled, we would then double the capacity of our airport. Traffic managers for aircraft, rail, bus, and truck lines are continually endeavoring to increase their movement frequency and lessen their "turn around" time. It is, therefore, the duty of the Airport Engineer to really design an airport

and not to rely upon additional acreage to permit an airport that just grows.

Some of the most important requirements confronting an engineer are on our future airport.

There must be absolutely **no cross-over traffic** either on the ground or in the air at any time and under any possible wind condition. Flight paths must be kept clear at all times for prompt, safe arrivals and departures. Also there should be no possibility of cross-over traffic on the ground between aircraft and vehicles. Keep taxi ways always open. These simple features alone would greatly relieve the congestion and delays at our present airports.

There must be dual or parallel runways, widely separated to permit safe, simultaneous arrivals and departures. The design should contemplate 30-second interval arrivals and, at the same time, allow for 30-second departures. This high frequency must be sustained over an extended period of time during any possible wind or visibility condition. Airlines are endeavoring to maintain prompt departure and arrival times and the engineer, in designing a modern airport, should have the viewpoint of the dispatcher in the control tower during a peak load and low visibility weather.

As aircraft are designed primarily to fly, ground or taxi traffic must be reduced in length and accelerated. Make it a continuous stream of "flow" traffic with no "dead ends" or "bottlenecks." Safe high speed turns help and the engineer should use all his ingenuity to avoid any possible traffic

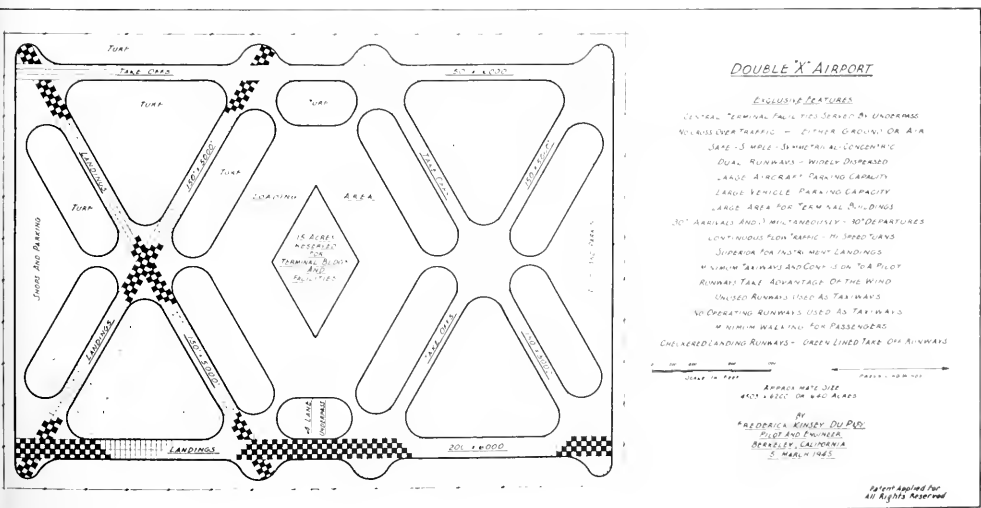

DOUBLE "X" AIRPORT

EXCLUSIVE FEATURES

- CENTRAL TERMINAL BUILDING SPREADS AN UNDERGROUND
- NO CROSS-OVER TRAFFIC - EITHER GROUND OR AIR
- SAFE - 3 WIDE - 30 METERS - CONCENTRIC
- DUAL RUNWAYS - WIDELY SPACED
- LARGE AIRCRAFT - PARKING CAPACITY
- LARGE VEHICLE - PARKING CAPACITY
- LARGE AREA FOR TRAVEL BUILDINGS
- 30° ARRIVALS AND 30° DEPARTURES - NO DEPARTURES
- UNLIMITED TURN TRAFFIC - NO SPEED LIMITS
- SUPERIOR FOR FASTEST LANDINGS
- MINIMUM TAXIWAYS AND GOLF COURSE PILOT
- RUNWAYS TAKE ADVANTAGE OF THE WIND
- UNUSED RUNWAYS USED AS TAXIWAYS
- NO OPERATING RUNWAYS USED AS TAXIWAYS
- MINIMUM WALKWAYS FOR PASSENGERS
- GREEN LINED TAKE OFF AIRWAYS

APPROXIMATE SIZE
400' x 600' ON 100' x 100'

BY
FREDERICA KINNEY DU PLO,
CIVIL AND ENGINEER,
BERKELEY, CALIFORNIA,
5, MAR, 1945.

Patent Applied For
All Rights Reserved

congestion and increase safety. The widely separated parallel runways disperse both incoming and outgoing traffic in the air and on the ground. This wide runway separation increases safety and frequency. The traffic pattern on the ground and in the air should be simplified.

One set of the dual or parallel runways should be long, in order that they may be used for the landings and take-offs during the prevailing winds, calms, negligible winds and instrument landings. When the cross winds become too strong to use the main long runways, then the most suitable shorter runway may be used. All runway ends should be connected for the purpose of accelerating traffic. Calms obviously require the longest runway, but the other runways may be shorter, as they will always be taking advantage of the wind.

The exclusively landing runways should be marked off in some distinctive manner, such as 50 foot alternating black and white squares, for quick identification, depth perception, speed and

course. The exclusively take-off runways could have longitudinal lines, as distinctive markings to help a pilot both on the ground and in the air, just as highway markings help a motorist.

Airport areas not occupied by runways, taxiways or buildings should be planted to a firm, level, deep-rooted turf for occasional taxiing, dust elimination and beauty. Broad turf shoulders will permit taxiing aircraft to by-pass any possible traffic congestion.

Parking areas for aircraft and vehicles must be ample. Consider the congestion now and imagine what it will be in the future. More attention must be paid to a passenger's comfort and convenience, as their fares make this construction possible. There will be strong post-war competition between vessel, rail, air, bus and private automobile. Terminal buildings, ticket offices, waiting rooms and conveniences will be architectural triumphs.

Shown in this issue are two illustrative modern airport designs that incorporate most of the features necessary for a large volume of traffic.

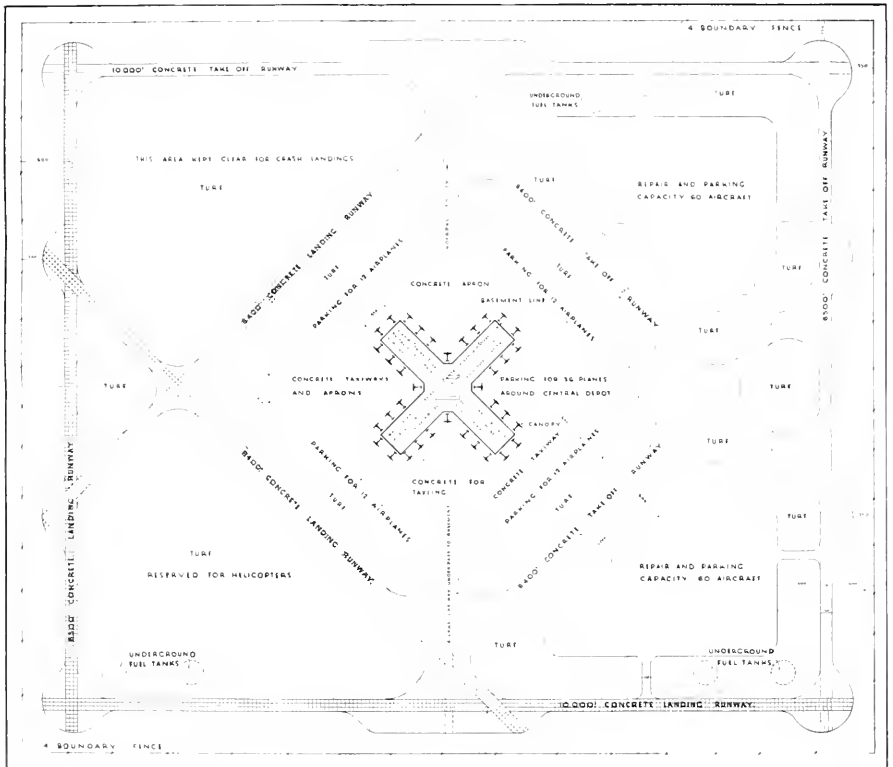

Either of the plans may be greatly improved by decreased in size without materially affecting the fundamental design principle. The larger, "International," plan provides eight runways, with the two long runways each 10,000 feet long. Landing and take-off aircraft will never be more than 22½ degrees off head wind. This type of an airport would only be near large cities, as it requires 2169 acres. Even this acreage is economical when compared to the total acreage of such existing airports as New York or San Francisco. The smaller, or "Double X," plan is worthy of considerable study, as it only requires 640 acres and there are two 6,000-foot runways and four 5,000-foot runways. Landing or departing aircraft will never be more than 30 degrees off wind.

It is believed that the "Double X" airport will receive and dispatch two or three times the amount of traffic of any other design on a comparable area. We are still primarily interested in safe, high movement frequency with no possibility of traffic congestion. Many present day airports have practically idle runways which are used only occasionally. In these two designs all of the runways are in use all of the time, either as operating runways, or as taxiways. Industrial engineers and city planners recognize the efficiency of a good basic design.

The airport plan should be simple, symmetrical, and high speed, so as to assist a pilot and not confuse him. Complicated traffic patterns or engineering designs are always difficult. Engineers and pilots will always debate the question of desirable runway lengths, but the basic plans shown are flexible enough to suit any condition or location and may also be varied in size and runway lengths.

The terminal facilities and buildings should be placed near the center of the airport for fast operation and good control. Terminal facilities on the sides of an airport cause cross-over traffic and a resultant loss in movement frequency, safety and efficiency. Auto, bus, rail and pedestrian traffic to the central terminal facilities is by a simple underpass. Airport engineers should study how railway and highway engineers have greatly increased the volume and safety of traffic by overpasses and underpasses.

Industrial engineers and city planners can do a lot towards increasing airport efficiency. Up-to-date engineering and construction is needed for the airport of the future. The "Topsy" type airports of the 1920 era will not accommodate the traffic of the 1950 era. It is true that an underpass costs considerably, but if it more than doubles the capacity of a busy municipal airport, the added construction cost is certainly worth while. The added safety value cannot be estimated.

An excellent example is provided by a busy existing civil airport where a pilot is now awaiting each permission to land, and another pilot is waiting for a clear runway to take off. These expensive operational delays can be eliminated by design and cooperation between the engineer and operations, as it must always be remembered that safe, fast operation will promote aviation, and the general public will be the ultimate beneficiary.

Aviation history records that the great majority of civil airports out-grow themselves every few years. Therefore, is it not possible to originally design an airport that has a Master Plan and could be progressively developed as future traffic warrants. This is a "MUST" for the airport engineer. Airports must fit in with long range city planning, as the accumulated backlog of both of these types of work is going to be a major problem for years to come. It must always be remembered that an airport that has a capacity of 400 safe movements per day is twice as valuable as an airport with a capacity of 200 movements per day. Increase the efficiency.

* FREDERICK KINSEY DUPUY, Consulting Engineer and Pilot of Berkeley, California, has applied for patents on these Airports. His experience as an Army Air Force Flying Officer in both World War I and World War II, his engineering experience and assignments in Canada, England, Scotland, Africa, South America, all over the United States, Australia, and the Southwest Pacific, have given him a background that few Airport Engineers possess.

DENNELL E. JAEKLE, ARCHITECT, is progressing nicely with his plans for the office building for the Maylair Packing Company in San Jose, California. Also his apartment building, same city.

THE FEDERAL HOUSING AUTHORITY has announced the appointment of John J. Donovan as architect for 150 Temporary Family Units to be built in Benicia, Solano County, California.

ARCHITECTS' POLL ON FLUSH VALVES

To determine trends in the selection of flush valves for various types of post-war buildings, an extensive poll among architects was recently completed by the manufacturers of Watrous Flush Valves, The Imperial Brass Manufacturing Company, 1200 West Harrison Street, Chicago 7, Illinois.

Results of this poll covering hospitals, schools, industrial plants, airports, railway and bus depots have appeared in the form of advertisements and are now available in manufacturer's Bulletin No. 477.



INTERESTING RESIDENCE OVERLOOKING ACAPULCO BAY, MEXICO

Enrique de la Mora y Palomar, Arquitecto

A Building Boom South of the Border

By WM. ARTHUR NEWMAN, Architect

"Mexico will enjoy during the coming decade progress and prosperity undreamed of just a short time ago," stated Eric A. Johnston, President of the Chamber of Commerce of the United States, while attending the recent Inter-American Conference of Foreign Ministers in Mexico City, and added: "We are sure Mexico will have a tremen-

dous social and economic future."

You may recall the Mexico of former years, particularly along the southern California border. There life had a tendency to go on in an easy care-free way. It was a land where time was made for slaves. It was a place warm and balmy, inviting a siesta; with strains of sweet music—and

ARCHITECT AND ENGINEER

business could wait. Here an occasional building was constructed—but there was no hurry to worry.

It is different in Mexico City today. Crowded stores, restaurants, hotels, buses and banks. Eager, active American tourists arriving by plane and train; refugees, thousands of them from Europe; students, from all the Americas; these and many others are here. So many, that suitable accommodations are not always easy to find.

In a comparatively short time Mexico City has grown from a little over a million and a quarter to more than two millions.

When the United States is prosperous, this prosperity is reflected in the Mexican capital, and in turn is radiated to the other cities and towns of the nation.

Since its reconstruction in 1521 the city of Mexico has never seen such activity in its construction industry as now. In the past six years approximately 28,000 buildings have been constructed, enlarged or remodeled. Sixty-four per cent of these are residential types. In addition, in the past five years the Federal District, of which the



APARTMENT BUILDING, Avenida Alpos 1105, Mexico City, Mexico

Living Room Looking



Into Dining Room



RESIDENCE at Calle Aristoteles Mexico City, Mexico

capital is a part, has expended on public works \$7,000,000. \$1,000,000 was for public schools and the balance for park buildings, markets, penitentiary, hospitals and public monuments.

Several thousand buildings under construction are impressive. However, in California a building is completed more quickly; shall we say, in half the time it takes in Mexico; then here there would appear twice the number under construction at any one time, as in California with the same volume of business. When we say it takes longer here to complete, we must remember that these are all fireproof buildings.

In the year ending February 1, 1945, there were 6088 building permits issued in Mexico City. Notwithstanding the number of new buildings being completed, there is a scarcity of all kinds of rentable space.

At the American Club you may hear businessmen relate their experiences in search of suitable

offices; consulting realtors, newspaper advertising, and looking about up and down the main streets. All to little avail; desirable space in new buildings taken, and nothing for lease but rather dark and unattractive offices.

It taxes one's credulity to hear of new buildings in this city rented long before completion, even before elevator service is available; of rent commencing on the date lease is signed, possibly weeks before the space can be occupied. As fast as the new buildings are up, they are occupied, and at advancing rentals. Business transacted without telephones and under such circumstances points to boom conditions.

As numerous older buildings are demolished, to be replaced by new modern structures, the tenants are forced to seek other quarters, which in turn adds to the present demand for more store and office space.

These unusually prosperous conditions have induced some businessmen to look for a setback,

due to the readjustment of the post-war period, and consequent deflation of the present scale of prices, which have risen from 100 per cent to 300 per cent above prewar levels. Others predict the slump in prices will be short lived.

As in the United States, there is more money in circulation here than ever before. This causes some economists to view the danger of the goblins "getting 'em" if they do not watch out. On the other hand, it is asserted the bankers are scrutinizing their loans to eliminate boom-time schemes, war babies, or the results of unhealthy growth.

From even the most casual observation, one sees millions of pesos being invested in new buildings. You are told that these are sound business propositions; and you are asked, how can the bottom drop out when it is all so firmly based on bedrock?

You inquire, where does the money come from for this building boom. Take a look! Every day you can see steamers in the Gulf and Pacific ports, as well as long lines of freight cars leaving for the United States, filled with needed war materials and food. With liberal loans available to the railroads, they plan an expenditure of 50 million dollars for new construction and buildings.

You may recall that in this country are mountains of iron ore, all kinds of metals besides gold, silver and copper—new petroleum fields, coal, untouched forests of hardwoods, marble and onyx, etc.

Along the main streets you see familiar signs, such as W. P. Fuller, Crane, General Electric, Sherwin-Williams, and it makes you, as an architect, feel at home. You meet their representatives who tell of the building boom that has been growing the past four or five years; of new enterprises being established, and large American companies planning business expansion in Mexico.

Mayor Francisco Doria Paz reports great plans for encouraging the tourist trade. New and comfortable hotels and tourist camps are being constructed in towns and cities that dot the Pan-American Highway from the United States to Guatemala. Three million motorists are awaiting the opportunity to make this trip. Work continues on 6500 miles of new highways. All these add impetus to the building industry.

Thousands of Mexican workers have gone to the United States and already many have returned with new ideas for improved living standards and proper housing.

There is a great deal of interest in moving pictures which are largely patronized, and some new "movie" studios are under construction. To meet the needs of the expanding population in Mexico City a number of new moving picture theaters are

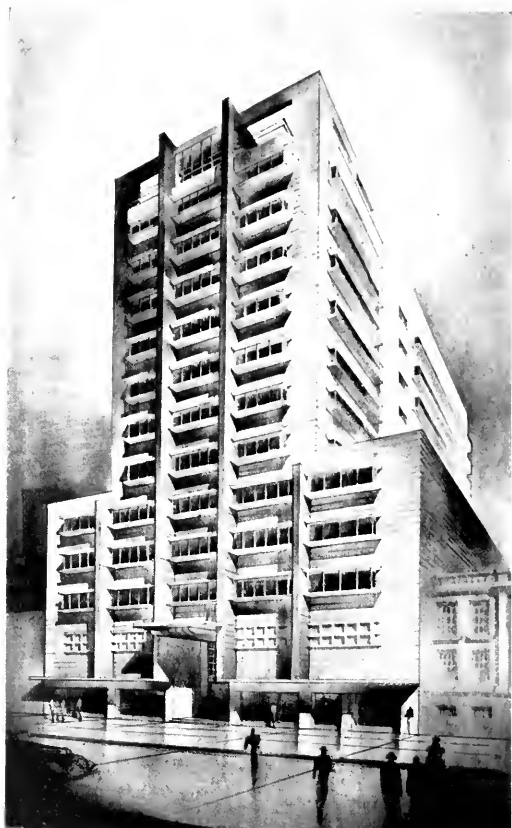

EDIFICIO de la Compania de Seguros la Mutualista de Mexico
Arquitecto Enrique de la Mora Palomar

being erected. The present number is 75. Some of the new ones are as modern as I have seen in the United States.

In one of the large new "movies" under construction, in the latter part of January, while 100 workmen are employed, the greater part of the reinforced concrete roof and some of the walls suddenly fell to the floor, twisting and carrying down structural steel trusses and other members, bending tops of columns almost double. The public is wondering to what extent this is due to a slip-up in design, or to careless supervision on account of boom conditions in the construction industry.



NETHERLANDS LEGATION and Residence in Mexico City, Mexico

being erected, and others being planned at Acapulco and elsewhere.

The federal government committee in charge of planning new public schools has recently reported on the necessity of appropriations totaling 100 million dollars. This amount is in addition to appropriations of the various states, cities and private institutions.

Appropriations for new school buildings this year are the largest yet made, and for the first time education has received more money than the War Department. These schools are to be con-



RESIDENCE, Corner of Aristoteles and Presidente Masarik

Among architects and engineers one learns of the new 15 million dollar refinery to be financed immediately by American capital; of plans for a 28-story office building on Avenida Juarez; of a new hotel at Chapultepec Park, to be larger than any other in the country; of Sears-Roebuck who have purchased the site of the American School; of plans of the School for a new and larger campus and buildings; of the intention of the Masonic Order to build; of the 16-story Bush Hotel under construction; of the \$1,000,000 Emergency Hospital now up to the cornerstone; of new resort buildings

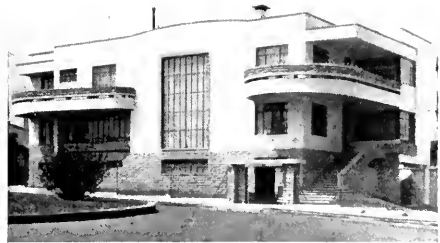

RESIDENCE, Avenida Virreyes 155

structed as fast as funds are provided. Architects and state architects for the new schools have been selected, and are now engaged day and night on the plans. The committee reports 26 new school buildings under construction in the capital, and many more scattered throughout the country.

As you move about the city you notice at windows and doors of the older buildings the ravages of termites, and you see that all new permanent construction, including residential, is fireproof and with metal sash, etc. Practically all residential work erected today has reinforced concrete frame, floor and roof, with brick or tile wall panels, and the exterior walls usually finished in cement stucco.

Overlooking the capital at Calle Juan de Leyva 145, in Lomas de Chapultepec, Arquitecto Ramon Carlos Aguayo has completed an interesting residence. The cream stucco walls harmonize with the lava stone of the entrance stair; black metal

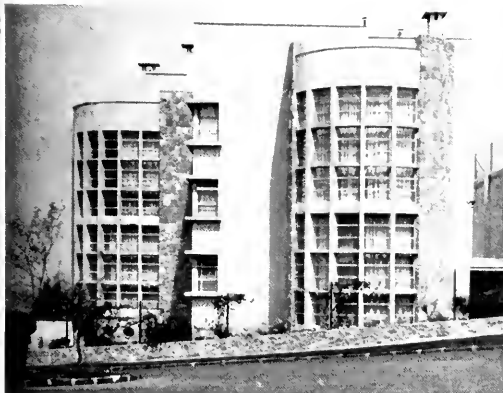

**APARTMENT HOUSE BUILDING
Avenida Esplanada 1645, Mexico City
Mario Pani, Arquitecto**

RIGHT: Residence at Calle Juan de Leyva 145, Mexico City.

LOWER: Details of the Artistic Modern Mexico Casa of which Ramon Carlos Aguayo was the Architect. Basement, First and Second Floor Plans Shown.



CA/A Nº 145 DE LA CALLE JUAN DE LEYVA.
COL. VIRREYES—LOMA/ DE CHAPULTEPEC.

ARQ RAMON CARLOS AGUAYO

E/CALE. 1-100

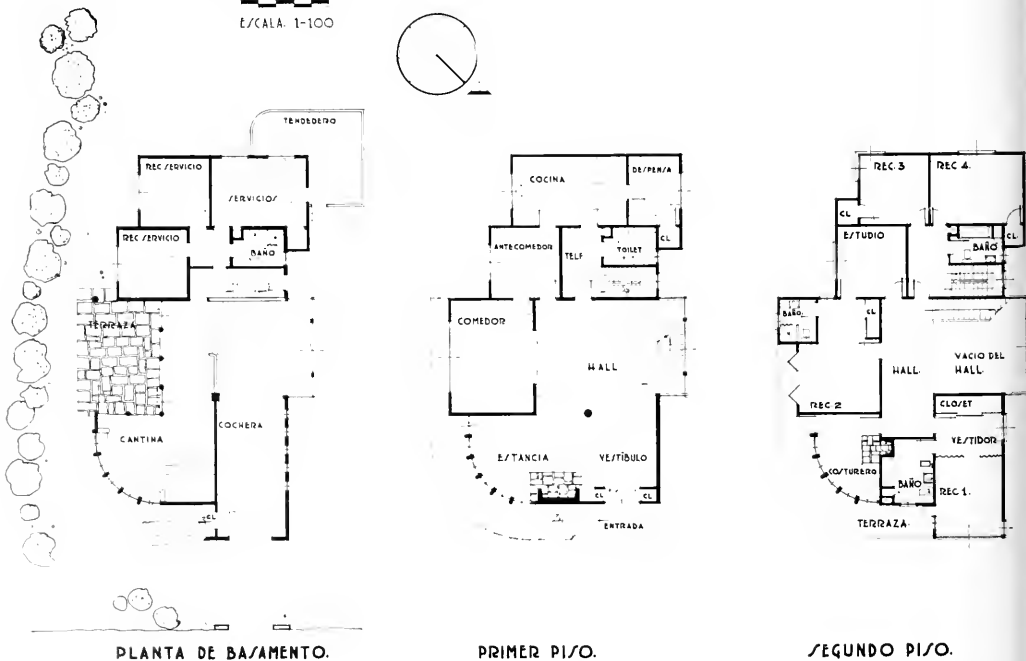

PLANTA DE BASAMENTO.

PRIMER PISO.

SEGUNDO PISO.

window frames outline the openings. Main entrance and garage doors are aluminum finish.

In this city there is a preference for interior stairs to be open underneath. The proportion of circular stairs to straight run is large; and of course the interior stair is made a feature of the living room, as will be seen in this home.

Arquitecto Aguayo has an appreciation of the Greek, as noted in the recessed wall panel in this dining room. In the master bedroom semicircular ornamental plaster ceiling treatment indicates position of the bed.

Large plate mirrors, cut up into rectangles, are popular, and may be found in living and dining rooms, and as placed on this bedroom wall.

Damage by fire is relatively small, and there are fewer fire department stations in consequence. Insurance rates are low. Our Pacific Coast cities may well give consideration to more fireproof construction, in the future, when reflecting on the damage that would have been caused if the



LARGE PLATE MIRRORS feature the bedroom of this Mexico City Casa

enemy had been able to drop incendiaries on the almost total wood frame construction of our residential sections.

It's good sport to take one's camera and go out gunning for snap-shots that interest you for one reason or another, and to see what the architects are doing.

We are just becoming aware, as are many of our Mexican friends, of the worth-while things their architects are creating. Virginia Henslee, one of the most popular editors, writes in Mexico's great daily newspaper "Novedades": "If by chance you haven't seen the January issue of the magazine "Architect & Engineer" it would be really worth your while to try and obtain a copy just to have the pleasure of reading the article entitled "A California Architect in Mexico City." As the article impressed me for the first time with the ultra-modernity of the present Mexican architectural scene, surely it must have created a furore in the



LIVING ROOM . . . Stairway in corner leading to Segundo Piso

States where some benighted souls still cling to the idea that we all live in adobe hovels down here."

Across from the main post office, excavation is proceeding for a new office building for Compania de Seguras, La Mutualista de Mexico, from the plans of Arquitecto Enrique de la Mora y Palomar. The design is distinctive in the modern trend, with plenty of light to eliminate complaints so often made about dark offices. Reflected light from broad window sills and vertical members enhances the attractiveness of interiors. A roof garden is also included in these plans.

While not one of the latest, yet the Edificio Nacional is one of the most successful designs of an office building erected here in recent years; well balanced and presenting a most satisfying appearance from both streets. The store fronts and entrances are trimmed with polished black granite, relieved by the four chromium marquees. The exposed exterior concrete surfaces of the superstructure above have good texture and were left as they came from the forms, with apparently little patching. Ornamental entrance doors are black,



DINING ROOM of Calle Juan de Leyva, Mexico City, Mexico

with stiles, rails and horizontal members of chromium finish.

Acapulco Bay, about 300 miles south of the capital, is a well frequented summer and winter resort. In places the cliffs drop nearly vertical 150 feet (similar to some of our Monterey coast line). This has attracted families from the interior who have built on the rocky bluffs.

One of these interesting homes is the work of Arquitecto Enrique de la Mora y Palomar, who has placed the living and dining rooms on the upper floor, affording inspiring views of the blue Pacific, the Bay and the distant mountains, both from windows and the open porch. Bedrooms are on the floor below.

Perhaps one of the first things the California architect notices is the Mexican's love for the pleasing appearance and beauty expressed in the varying shades and colors of the native stone, which he uses so generously.



EDIFICIO NACIONAL . . . Modern Office Building in Mexico City, Mexico

MEXICO'S NEWER OFFICE BUILDING **Edificio Aztlan of Mexico City**



The mild equable climate of the capital practically the entire year is an inducement to outdoor living. As you will note in the illustrations, architects therefore give expression to the local desire for wide open-air porches with a certain amount of assured privacy; not overlooking the thrill clients get from marvelous views of snow-capped mountains and volcanoes. As we all know these requirements of the owner can add startling surprises in residential design.

More glass wall tile are being used to soften the glare of the bright days, and lighten many otherwise dark spaces in interiors, too frequently found in the houses of former times.

And you will note daylighting with large plate picture windows, overlooking distant valleys. Occasionally is found projecting outside one of these windows a 4' 0" x 7' 0" aviary of plate glass the height of the window, with tile floor and potted plants. You watch the distant scene from the interior through the plate glass of the aviary, as beautifully colored tropical birds disport, and love birds snuggle and coo.

In new residential sections under construction, you will see quite a usual sight—the local method of delivering form lumber, etc. Led by a lad, several burros or horses go to the job with the material hitched to their harness, as in the photograph. This might seem a slow method, but it is surprisingly efficient if the site is not remote; and of course the expense is small. Mexicans are a practical people, and when other methods are not available they make the best of the means at hand. Mass production principles in the building industry have not yet arrived.



Acapulco Bay, Mexico

On a corner lot alongside the Park is the Consulate of the Netherlands and residence, recently completed from the plans of Arquitecto Edwardo Mendez Fernandez, who is successful in pleasing his numerous clientele. Above the stone base the exterior walls are light gray with cream window trim; red pressed brick wall copings and sills. Entrance steps are cream dull glazed tile.

walls. Window trim is dark brown and windows have plate glass. Entrance steps are cast stone.

All properties in the city are protected from intrusion by fences, as was formerly the custom in the United States. Frequently here a covered entrance is provided as a protection from the weather, while you are awaiting the coming of the criado, to be admitted.

A view from the street at Avenida Gutenberg 231 shows a portion of the roof garden covered with a five inch thick slab. Eighteen inch circular perforations pass the sunlight through, and provide a variation from the standard pergola. The exterior stucco of this residence is in a very light tint of green. Red tile trimmings are laid up in white mortar. The front fence wall is a warm gray lava stone in three inch slabs with green mortar joints horizontally recessed.

In addition to living room, dining room, kitchen, servants' quarters and garage, there are four bedrooms. Of course the building is fireproof, and was completed four months ago at a cost of \$20,000. Many similar homes are erected in this district.

In recent years there has been a marked change in residential design. Formerly the European plan prevailed of building on the whole of the city lot, with a patio in the center, where a passage, porch or arcade connected all rooms. Exterior windows were guarded by grilles, and doors were thick and heavy.

More stable governments and better livable types of "the good neighbor country to the North" have brought about the change. Many smartly styled "Hollywood" designs can be seen in the newer sections.

If there is some indication of stone on the exterior walls, especially of a light warm and varied tone, this stone may often be found as a feature on one or more of the living room walls, generally lightly tooled or hone finished. Such walls require little decoration, and enhance the charm of the home.

An upper porch may have a section with cement or rough stone slab floor and wide and irregular joints filled with grass, and sometimes a 5' 0" x 10' 0" lawn space in the remaining section on the same level; the porch protected by a flower box used as an outer rail, as at Calle Alpes 1105.

Regarding relations with the United States, there is an adage: "As Mexico goes, so goes Central and South America."

Is Mexico going forward, you ask? Yes. She has reached the door to advancement and progress, and will continue. The effect of her awakening to higher standards is the Building Boom across the Border.

In a following issue will be described more interesting things about Mexico—a Marvel of Architectural Contrasts.

At Avenida Virreyes 155 is another new residence on a corner lot. The stone base to water-table has 1½ inch wide joints; red brick copings and red tile sills give a touch of color to the gray



Gasoline Shortage Here



LEFT

A MAJOR SURGERY

Containing most modern equipment and the last word in abundant lighting tied in with regular power and emergency stand-by generators.



BELOW

A PRIVATE ROOM

Each bed is equipped with two-way communication by which patients may talk to the head nurse whenever necessary.



THE LABORATORY

The modern equipment enables technicians to carry out their work with the utmost accuracy.



**TERRAZZO
FLOORS**

IN OPERATING ROOMS AND
CORRIDOR LOBBIES OF
PERMANENTE HOSPITAL,
OAKLAND, CALIFORNIA,

By

American Terrazzo Co.

36 Wood St., San Francisco
Phone WEst 4899



THE DINING ROOM, BAKERY AND KITCHEN UNITS

Are developed to a high degree of sanitation and efficiency. The tray carriers are equipped with heating elements to insure delivery to patients at proper temperatures.

FLAGSTONE ENTRANCE STEPS

Porch, Structural Glass and
other Masonry Work

Permanente Foundation
Hospital
Oakland, California, by

PERSON & WIK

BRICK AND STONE
CONTRACTORS

1301 Paloma Avenue
Burlingame

Phone BUrlingame 3-3381
3-3316

Cahill Brothers

General Contractors

of

PERMANENTE FOUNDATION HOSPITAL

Oakland, California

206 Sansome Street, San Francisco

**PAINTING AND
DECORATING**

of the new
Permanente Hospital
Oakland

by

PATTERSON BROTHERS

Painting Contractors

339 Seventeenth Street
Oakland
Phone TWinoaks 0860

*The general contractor of the
Permanente Foundation Hos-
pital, Oakland, says —*

"A FINE JOB OF MILLWORK"

We are proud of that statement

**HOLLENBECK BUSH
PLANING MILL CO.**

Manufacturers of
HIGH CLASS MILLWORK
2206 S. Van Ness, Fresno, Calif.

without increasing the charges to the workers above what was charged for similar services five years ago. Besides the heavy costs in general, the hospital and other physicians have been paid \$5,000 to \$15,000 per annum, net. And so the record bears out Dr. Garfield's contention that it is more profitable to keep the workers well.

There are many features incorporated, and more to be installed in the Permanente Foundation Hospital, which are the last word. The surgeries were built, schematically, in a circle around a central work and sterilizing area, which permits the patients to enter through exterior corridors, thus avoiding cross traffic. This plan was thoroughly tried out at the Kaiser Hospital in Vancouver and improved in this plant. The equipment and facilities include radiographic units, fluoroscopic combination units, mobile units for bedside x-ray, shock-proof dental unit, deep therapy unit, Sisk urological tables and chest fluoroscopic units. As with the hospital in general, much of the clinic atmosphere has been eliminated by giving the patient more privacy and pleasant surroundings through attractive decorations and furniture. At the present time 1500 patients are being handled per day.

Under way is the addition of an obstetrical wing of 50 beds, with nursery facilities, delivery rooms and labor rooms. New innovations will include, to quote Dr. Garfield's report, "Lavatory basins that will swing over the patient's bed and permit washing and shaving without assistance, beds which operate by electric motors,—bedpan units which extend from a bedside cabinet and allow self service," and many other new features. The number of steps that are saved to the nurses by



**NURSES' STATIONS conveniently located for
maintaining quick and efficient service**



DESIGNED for efficient and professional treatment of patients

the operation of a separate switchboard through which a bed-ridden patient can call up his nurse anywhere in the hospital, would give the Simon Legree type of hospital superintendent that we used to know, what might prove a fatal shock. So, also, would the consideration that is paid to what was formerly considered as plain "fakes."

Permanente Foundation Hospital is a happy name. It conveys a sense or feeling that the institution is one of permanence, and it is. No project that has had the thought and experience behind its development that has fathered this hospital can pass out with the end of any emergency.

Mr. Birge M. Clark, A.I.A., who designed this hospital, has had long experience with just such problems. The elaborate sound proofing throughout is really a "master job" and has set an example of quality that all departments have striven to equal, and this high level has been maintained in exterior as well as interior work and detail. The flagstone main entrance and terrace would satisfy the exacting requirements of the designer of a mansion as would details such as the painting, decorating and mill work.

It would be difficult to find any project more intelligently or thoroughly executed and it is inconceivable that it shall pass as soon as high pressure requirement passes. Already the payroll of the Kaiser Industries in this area has been materially reduced and will, of course, go lower. For that reason the Permanente Foundation Hospital is preparing to open the hospital to patients and physicians other than those in the employ of the Kaiser Industries. When that day comes thousands will thank providence that the men who built the Permanente Foundation Hospital worked so faithfully.

ALL ELECTRICAL WORK

including
Nurses' Call and Public Address
System and

LIGHTING FIXTURES

in the new
Permanente Hospital
Oakland

installed by

MATSON ELECTRICAL EQUIPMENT CO.

Industrial Electrical Construction

3781 Broadway, Oakland, Calif.

HUMBLDOLT 1294

Installation in

PERMANENTE MEMORIAL

HOSPITAL OF

**Heating • Plumbing • Air Condition-
ing and Process Piping**

by

Scott Co.

MECHANICAL CONTRACTORS

SAN FRANCISCO

OAKLAND

IN THE NEWS

NATIONAL HOUSING AGENCY BUSY

The Office of War Information National Housing Agency reports that, as of March 1, more than 53,000 units of war housing, both privately and publicly financed, were under construction. Another 60,000 had been authorized and were ready to be placed under construction of which 41,000 will be privately financed and 19,000 built with public funds. It is estimated that several thousand more temporary publicly financed units not yet authorized will be required.

At the end of February, a total of 1,791,822 war housing units or 94 per cent of the assigned program had been completed. In addition, some 2,000,000 other accommodations had been provided through more intensive use of the existing housing supply.

NAVY WORK ANNOUNCED

Admiral Henry C. Bruns, C.E.C.U.S.N. Supt. Civil Engineer, Area 6, announced the Navy Department has authorized the spending of an additional \$9,700,000 at the Naval Supply Annex, Stockton, California.



1. BROWNSKIN S-T-R-E-T-C-H-E-S.

Absorbs stress and strain.

2. BROWNSKIN resists moisture.

No shrinking.

3. BROWNSKIN withstands the elements.

No drying or cracking.

Only BROWNSKIN building paper combines these three vital qualities of protection. Used as sheathing it is impervious to the infiltration of water, air and vapor. Its resilience prevents pulling away from nails and corners. BROWNSKIN is made of laminated, tough sulphite kraft papers, each layer impregnated with bituminous compound, creped, then inseparably bonded together with asphalt. Ask your distributor about STANDARD BROWNSKIN, and also about BROWNSKIN VAPORSEAL and ECONOMY BROWNSKIN.

OPENING DATE POSTPONED

In deference to the official period of mourning for the late President Franklin D. Roosevelt, the California Palace of the Legion of Honor has postponed the date for the opening of its exhibition of contemporary American paintings from May 8 to May 17, according to announcement by Dr. Jermayne MacAgy, acting director.

The exhibition, which has been assembled from all parts of America, includes more than 200 paintings by outstanding living artists. The show will continue through June 17.

MOSCOW EXPERIMENTS

Some of the conditions laid down in Moscow that must be followed throughout the country in the rebuilding work are excellent and should result in a tremendous improvement of the cities, both aesthetically and functionally. For naivete' the group of conditions requiring that houses must be beautiful, comfortable and economical is hard to beat. Shades of Tantalus! Was ever an architect commissioned to build a house without these three conditions!

BRUNNING, Chicago, offer "Dulseal", a tissue thin, transparent film for protecting, preserving and repairing tracings, drawings, blue prints, maps, and other valuable papers.

 Quality Products Since 1895

ANGIER SALES CORPORATION

Framingham, Massachusetts

PACIFIC COAST OFFICE: 116 NEW MONTGOMERY ST., SAN FRANCISCO 5, CALIFORNIA

DISTRIBUTORS

WESTERN ASBESTOS CO., SAN FRANCISCO	WARREN & BAILEY CO., LOS ANGELES
LOCKWOOD WAREHOUSE CORP., SEATTLE	MASON'S SUPPLY CO., PORTLAND
BUILDING SUPPLIES, INC., SPOKANE	R. W. FRANK & CO., SALT LAKE CITY



ANGELO HEWETSON
Del.

Trees in Architectural Rendering

As an illustration of trees in architectural rendering Mr. Hewetson's drawing of an old cypress on Point Lobos, just south of Carmel, serves excellently to show how the character of a tree may be shown in the treatment of the wood, stems, and bole.

There will be little use for such a rendering in a quick or hasty sketch. It requires too much detail. But occasions may arise where that very detail is required. It could easily be necessary to introduce a bit of such detail to show the character of the house that is to be built near it. Anyhow, isn't it a lovely sketch?

Don't Play the Shoemaker's Child



Architects, who have for years been specifying adequate wiring for houses and buildings, have often neglected to install the most efficient wiring systems in their own homes.

They have been so busy planning new homes, with complete electrical service, that they have failed to provide for the most convenient and satisfactory use of their own electrical equipment.

If you have been playing the "Shoemaker's Child," take time out now to plan the rewiring of your own home. Specify enough outlets, enough circuits and wire of sufficient size to provide for present and future lighting and wiring needs.

NORTHERN CALIFORNIA ELECTRICAL BUREAU

1355 Market Street • San Francisco 3

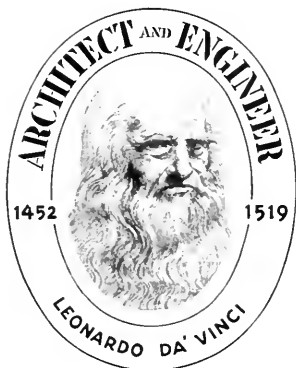

LEONARDO DA VINCI

The First Housing Project

Leonardo Da Vinci was once discussing with his patron, Duke Moro, a plan he had designed for a city with two-tiered streets, a city, according to Merjkowski, "built in accordance with an exact knowledge of the laws of nature." To the Duke's statement that "This is not at all bad," a phrase with which the architects of today are familiar, Leonardo replied, "I have long dreamed of your Excellency's being pleased to make an experiment, even if only with one of the suburbs of Milan. Five thousand houses—for thirty thousand inmates; and the great number who now are huddling one atop another, in filthy and miasmatic squalor, spreading the seeds of infection and death, would be dispersed."

That was nearly five hundred years ago and the Leonardos of the world are still at it.

NEW CATALOG ON TACO WATER HEATERS

Specialties for warm water radiator heating systems and modern water heaters of both tankless and storage tank types are shown and described in a new 20-page catalog.

Detailed information on the "Taco-One" Venturi System of radiator heating includes layout diagrams, design tables and installation data. Also described are Taco two-pipe systems as well as various accessories—circulators, venturi fittings, flow checks, relief and reducing valves, etc., developed to increase warm water radiator system efficiency.

Storage type water heaters, in a range of sizes and capacities suitable for small residence installations up to large apartment houses and commercial buildings, are grouped to show comparison of capacities.

Copies may be secured on application to Taco Heaters, Inc., 342 Madison Avenue, New York 17, N. Y., specifying Catalog D99.

NEWS AND COMMENT ON ART

(From Page 7)

She pi lu (snake skin green), a highly iridescent deep green and ku pi lu (cucumber green), a leaf green with faint mottling of yellowish green, are two highly treasured specimens from the Tsang Ying-hsuan kilns. Hsieh chiao ch'ing (crab claw green) is a limpid, slightly mottled dark green. These interesting glazes were produced by the modification of just one enamel from the famille verte palette, the leaf green.

Fruit green (kuo lu) or apple green (p'in kuo lu) are made by coating a crackled celadon with a translucent green enamel. This composite glaze is breath-takenly beautiful and meets a constant demand, especially if it belongs to the K'ang Hsi period. It is often slightly iridescent, heightened sometime by the presence of minute crystalline fissures formed within the lustrous enamel at the junction of the crackles. These fissures, adding sparkles to the glaze, are called fly wing sparkles in the West; ch'ing y'ing yih (dragon fly wings) in China.

The colors frequently encountered among the kuo lu are a brilliant bluish emerald green (ts'ui lu), a dark cucumber green (kua pi lu) and a light green with which the entire group is often named, apple green (p'in kuo lu).

There is a rare specimen where a green enamel is applied over a peach-blow glaze, resulting in a deep bottle-green with purplish overtone. Crackled celadon coated with a clear yellow gives a clear mustard which is called mi se (huang mi se, millet color).

The clear yellow enamel of the Ming dynasty, applied overglaze, is called chiao huang (delicate yellow) and is likened to a young hibiscus blossom (cho fang k'uei hua huang). The enamel is called ts'ai huang (yellow enamel), especially if it is used for painting or pencilling. When applied sur biscuit it is sometime also called yu huang (vitrified yellow glaze). A rare specimen has painting in black under a yellow glaze, called huang ti hei hua (yellow ground with black decoration).

Eel yellow (shan yu huang) is a famous glaze

(See Page 36)

IN THE NEWS

AIR MAPS PROPOSED

Recommendations for the aerial mapping of California through a cooperative program by the Federal and State governments are contained in a report released as the result of studies made by the State Aerial Mapping Project Committee of the Commission of which Olaf P. Jenkins, State Geologist, is chairman.

In submitting the report Colonel Alexander R. Heron, State Director of Reconstruction and Reemployment said:

"Of California's total of 158,693 square miles, less than one-half is now covered by adequate basic maps. Unmapped and inadequately mapped areas represent nearly two-thirds of the State's area.

"In addition to being useful to all citizens of the State, adequate

topographical maps would invite outside capital to make investments in California, because such maps are the prerequisite of all engineering enterprises.

"Adequate, accurate topographical maps, such as only the modern aerial mapping methods can produce, are absolutely essential in the development of California's natural resources in minerals, forestry, water, agriculture, etc.

"Another advantage of aerial mapping is the time element. If California hopes to take early advantage of post-war development of natural resources, adequate maps must be ready soon. Aerial photography greatly shortens the time necessary to complete the maps."

The report points out that recently many new and practical methods have been developed in mapping from aerial photographs which not only take far less time in constructing topographical maps, but which are more accurate and in greater detail. Such maps can be made on a larger scale for far less money than by former methods.

CHAIN BELT DATA

Bulletin No. 461, a four-page folder on Rex Table Top Chain Belt, has just been published by the Chain Belt Company of Milwaukee. The leaflet shows outstanding points in construction and describes details which make this type chain different than others. The chain has wide application in food handling and bottling or capping processes.

COLOR HARMONY BY ARCO

The use of color to increase visual comfort and student efficiency is the subject of a booklet, "Optonic Colors for Schools," just published by The Arco Company, Cleveland.

The new booklet includes a thorough explanation of underlying principles in color selection and 18 easily understood rules to help those without scientific training in color problems plan for the most effective combinations in school rooms, libraries, drafting rooms, art studios and shops.

**Money Safe
From Loss
or Theft!**

When You Use a Special Checking Account of This Bank



Eliminate the risks of keeping large sums of money at home or on your person. Paying by check is safer than with cash. Open a Crocker First National Bank Special Checking Account. The only cost is for the checks you buy—in books of 10 for \$1—as you need them. Open your account today then use our Mailway Banking Service.

**CROCKER FIRST
NATIONAL BANK**
OF SAN FRANCISCO
California's Oldest National Bank
ONE MONTGOMERY STREET
Member Federal Deposit Insurance Corporation

Built-In Fixtures for the Post-War Home

Paramount Fixtures will fit your post-war needs . . . investigate our new kitchen ideas which make for convenience and efficiency.

Paramount Built-in Fixtures meet the most exacting requirements. Our "Deluxe," "Moderne" and "Economy" cabinet fixtures are distinctive in design and construction and may be had in stock sizes or built to order.

Catalog for the asking

Paramount
BUILT-IN FIXTURE COMPANY
5107 Broadway, Oakland, California
Phone PLedmont 8100

"KIMSUL"

Controlled Insulation!

THERMAL EFFICIENCY 0.27

Compressed in rolls for shipment and to save storage space, it stretches out over 5 times and when fully stretched gives a uniform designated thickness which insures the same maximum insulation value at all points.

**Fire, Moisture and Vermin
Resistant
Extremely Light, Clean and
Easy to Install.**

GUNN, CARLE & CO.

20 Potrero Avenue
San Francisco 3
UN 5480

WITH THE ENGINEERS

The San Francisco section of the A.S.C.E. report that they now have a subscribing membership of 683 of which 113 are serving in the armed forces. This figure includes regular members, associate members, junior members and one affiliate.

Mr. Edgar Bloomster, engineer, carried along the plans for a factory building for the Berkeley Tool & Die Company to a point where the general contract was awarded and when last heard of was awaiting priorities.

ENGINEERS COMPLETE SIX MONTH BRIDGE JOB IN SIXTEEN DAYS

When U. S. Army Engineers headed toward the Rhine, there was one strategic spot on the Moselle River where they needed a heavy railroad bridge with concrete steel piers to handle trains with superweight materiel.

After dumping everything available into the river to make a ford to the pier sites, they had to mix concrete in freezing weather. They built a roaring fire, then piled on hand and gravel. The fire dwindled but the hot embers made the sand and gravel warm enough to mix and pour concrete.

To keep the freshly poured concrete from freezing while it set, the Engineers punched holes in the sides of empty cans and filled them with hot coals. The hot coal "stoves" were stacked around the newly poured piers and tents were erected over each unit. Thus, the concrete was kept from freezing and it had set in twelve hours.

In 16 days, the heavy bridge was completed. Great beams had been installed. The steel work was in. Rails were laid and the heavy freight rolled across where French Engineers said "that it could not be done in less than six months."

PORTABLE STEEL HIGHWAY BRIDGE

A bridge which was in danger of becoming obsolete two years ago is today one of the hottest Engineer items in the Army's mammoth supply program.

Designed originally as a tactical assault bridge, in which role it was practically superseded by the Bailey, the "Portable Steel Highway Bridge, H-20," has now come back to life as a truss member of the fixed bridges which Army Engineers are putting in by the hundreds and thousands all over the world.

NEWS AND COMMENT ON ART

(From Page 34)

from the Tsang Ying-hsuan kilns and is apparently an opalescent olive-yellow, though I have seen reddish brown glazes with a dusty surface not unlike tea-dust which are also called eel yellow. Sometime the green color in this glaze predominates, and it is called eel green (shan yu ch'ing).

The blue enamel is called ts'ai lan. It is rarely used as a monochrome, possibly because the higher fired blues covered practically the whole range, and possibly because it is difficult to use. Some are cracked, and they are called pao shih lan (precious stone blue) or yu tzu lan (fish-roe blue).

A much sought after black of the K'ang Hsi period is the raven wing black or liang hei (lustrous black), a highly iridescent composite black with a greenish overtone.

The dry pigmental black and the iron red of the Ming dynasty finally reached the status of an enamel by the early part of the eighteenth century. By adding a white flux to these two pigments a thick red and a sticky black enamel were produced, and they were hereafter used the same way as all other enamels were used. It is called ts'ai hei (black enamel) or yang hei (foreign black). When used for painting or pencilling on a white ground this color is apparently made thinner and is called shui mo (fluid black). When used as a monochrome it is called hsi yang wu chin (European black) or, if the form is after the style of a Ting ware, fang mo ting (imitation inky Ting). When applied over a bronze form the ware looks deceptively metallic. In the West this enamel is called mat noir or lac black.

The rouge de fer or overglaze iron red is of Sung origin and is really a pigmental wash which, when heated in a muffle kiln, manages to adhere to the glazed surface on which it is painted. The color varies from a pale flesh tint (when thinly applied) through a coral and a tangerine to a deep tomato red. During the K'ang Hsi period it is usually a deep coral (shan wu hung). Coral soufflé, made by blowing the pigment through a tube one end of which is covered with a gauze, is called ch'iu shan wu (brown coral). When mixed with a flux to form an enamel it is called ts'ai hung (enameled red) or tsao hung (jujube red).

The famille rose palette (of which which we will go more into detail in the next article) made its appearance around 1723 A.D. and is capable of producing a limitless variety of hues and shades, either by mixing the colors or by adding white. In
(See Page 45)

A. I. A. ACTIVITIES



AWARDS TO BE MADE IN 1945

By The Committee on Awards and Scholarships
Loring H. Provine, Chairman

The Edward Langley Scholarships

The American Institute of Architects will receive proposals of candidates for Edward Langley Scholarships from January 1 to April 30, 1945. Awards will be announced in May or June.

These scholarships are awarded annually for advanced work in architecture through study, travel, or research, as the candidate elects.

They are open to all residents of the United States and Canada who are engaged in the profession of architecture; that is, architects, architectural draftsmen (including specification writers, supervisors, and executives), and teachers and students in architecture.

Awards are made and grants determined by The Committee on Awards and Scholarships, under authority of The Board of Directors.

Programs must be carefully planned and the candidate should attach a written summary to his proposal giving a clear picture of how his work or study will be developed and reported, a schedule of time requirements, and a statement in reasonable detail of the expenditures to be made from the requested grant.

A proposed candidate may be asked to submit examples of his work or to appear before a representative of the committee.

How to Propose a Candidate

An architect in the United States or Canada may propose any other architect or architectural draftsman residing in the same country.

The faculty or head of any architectural school in the United States or Canada whose standing is satisfactory to the committee may propose any teacher or student in such school.

Form of Proposal. Every proposal shall be made in duplicate on A.I.A. Form S70, which may be obtained from The American Institute of Architects, 1741 New York Avenue, Washington 6, D. C.

Filing Proposals. All information and data required on the proposal form shall be filled in, and both the original and duplicate proposal shall be sent to The Secretary, The American Institute of Architects, at the address given herein, so as to reach there not later than April 30, 1945. Pro-

posals received after that date will not be considered.

Special Note

Programs presented by the candidate must be capable of fulfillment under the increased, difficult war conditions.

In the January issue of *Architect & Engineer*, under the heading of "SUBDIVISION OF THE ARCHITECT'S FEE," the following should now be added to complete the item. It has only recently come in:

DUPLICATION

For buildings classified under groups one and two if they are large projects and involve much duplication of units or of floor arrangement the minimum fee may be reduced not more than 1%.

ALTERATIONS AND ADDITIONS

For alterations the minimum fee for buildings in all groups shall be increased by from 25% to 50%, but this increase shall in general apply only to the cost of the alteration to the existing structures and not to the cost of additions beyond the alterations.

SEGREGATED CONTRACTS

Increased Minimum fees shall be charged in all groups if segregated contracts are required. The minimum increase shall be 2% of the value of the



**HOW
CAN YOU BRING
YOUR Fuel Bills
DOWN**

?
?

AND keep THEM DOWN FOR YEARS

That's no mere \$64 question... it's a question that can run into serious money if you have a big heating job to do. And the answer... whether your problem is big or little... put in Johnson Oil Burner equipment.

If that sounds too simple, remember that for 42 years trained engineers have been perfecting Johnson Burners... making them capture and use more heat from every gallon of oil... making them safer, quieter and more fully automatic. Ask your heating engineer... He knows.

There's a Johnson Burner for every job... house or hotel... hot air, hot water or steam. Some types and sizes are available even now. Let us know what you need.

...*Johnson Oil Burners*...

S. T. JOHNSON CO.
940 Arlington Ave., Oakland 8, Calif.
401 No. Broad St., Philadelphia 8, Pa.



QUALITY AND DEPENDABLE *Service*

are the factors that influence architects and contractors when selecting lumber and mill work — Quality of merchandise — Integrity and Ability of the firm—Service in physical equipment — Experience and Personnel — All these factors contribute to a speedy and satisfactory completion of construction with minimum of time and expense.

MANUFACTURER OR DEALER IN

Douglas Fir—Redwood—Sugar and Ponderosa Pine — Plywood and Concrete Form Panels — Sash and Doors — Millwork — Insulation — Builders' Hardware.

E. K. WOOD LUMBER CO.

"Goods of the Woods" ©

LOS ANGELES • SAN FRANCISCO • OAKLAND

*Be sure you're getting the
finest window glass obtainable*

it costs no more to specify

PENNERNON

Distributed by...

W. P. FULLER & CO.
PAINTS • GLASS • WALLPAPER

it's
FLATTER
... CLEARER
... BRIGHTER ...

Pennernon
flat drawn
WINDOW GLASS

contracts segregated from the general contract but the increase shall not apply to the work remaining in the general contract. Complete segregation of contracts and the elimination of a general contract containing the essential building trades including masonry, carpentry, lathing and plastering, is not recommended. The Architect's function should not be combined with that of the contractor.

WORK INVOLVING MUCH DETAIL

Minimum fees for designing furniture and lighting fixtures; for designing only and not as part of a complete building project, interiors and other of the more detailed parts, or appurtenances, of buildings or structures; shall be 15%.

FEES HIGHER THAN MINIMUM

Fees higher than the minimum are in no wise prohibited and are proper in all cases where the building problem is of greater complexity than the average of its kind, and would result in an increase in the architect's costs; or where special services are required; or where the reputation and ability of the architect command a larger professional fee, or where the building project scope is relatively small.

Approved by the California Council of Architects:

The Washington Representative of the A.I.A. last month sent out an exhaustive list of items with which his office is concerned. Some of them are FEES FOR PUBLIC WORKS; THE ORGANIZATION OF THE BUILDING INDUSTRY; THE ARMY EDUCATIONAL PROGRAM (See March number A. & E.); and the HOSPITAL BILL (S. 191). These items are discussed briefly and cogently and followed by a list of bills and legislation before the Senate and the House.

Twelve of these Senate bills are before various Senate committees and they all concern the architects directly, such as Mr. Downey's introducing an amendment to the October 14, 1940, act concerning the removal and disposition of housing. S. 418 provides for the establishment and maintenance of a National Cemetery in every State.

In the House many bills running along with Senate bills have been introduced. Many of them cover the proposal for National Cemeteries and the construction of military and naval academies. H.R. 1372, by Mr. McDonough of California, calls for an additional Military Academy in the southern district of California.

H.R. 626, calling for an appropriation of \$1,515,623,000 for certain Naval construction, has been signed by the President and is now Public Law No. 13.

This is only a partial brief. There are so many important items in this bulletin of April 5 that it is hoped the members of the A.I.A. will go over it carefully.

IN THE NEWS

POST-WAR BUILDING

Post-war Public Works (Santa Clara County)—The Santa Clara County Planning Commission, Charles Kuhn, chairman, Court-house, San Jose, has disclosed plans for the post-war construction of the following projects in Santa Clara County:

New county office building on Market St., \$600,000.

New wing at the county hospital, \$500,000.

Administration buildings in Los Gatos, Gilroy and Palo Alto, \$90,000.

Horticultural building, \$25,000.

County fair buildings and improvements, (1) poultry exhibit building, \$30,000; (2) cattle barns, \$22,500; (3) horse barns, \$140,000; (4) county hospital building, \$13,000; (5) fire station, police department and first aid building, \$25,000; (6) exhibit building, \$280,000; (7) improve race track, \$10,000; (8) landscaping, \$15,000; (9) grandstand, \$150,000; (10) horse show area, \$50,000; (11) additional lavatory buildings, \$6000; (12) water tank, \$14,000; (13) administration buildings, \$48,000; (14) sewer connection, \$75,000; (15) playground and equipment for children, \$20,000; (16) dance hall and pavilion, \$175,000; (17) parking area, \$76,500; (18) underground electrical system with transformer vault, \$50,000; (19) replace transit water pipe with steel pipe, \$25,000.

Post-war Public Works (San Mateo County)—The San Mateo County Board of Architects, comprised of Architects Hervey P. Clark, Arthur D. Janssen, James H. Mitchell, Leo Sharps and Harry A. Thomsen, Jr., with offices at 210 Post St., San Francisco, are preparing preliminary plans for the post-war construction of the following projects:

(1) a two-story, reinforced concrete addition to the present relief home, located near Crystal Springs Lake; (2) a new county courthouse to replace old portion of present courthouse; (3) addition to administrative office of the county jail; (4) new detention home; (5) veterans' memorial building and new county library building.

THE 3 R'S OF LIGHTING EQUIPMENT

Responsibility
Reliability
Research



Offices in Principal Western Cities—Branch and Warehouse in San Francisco

PRODUCERS' COUNCIL PAGE

Northern California Chapter

The National Organization of Manufacturers of Quality Building Materials and Equipment

Affiliated with the AMERICAN INSTITUTE OF ARCHITECTS



H. A. SCHOFIELD

Genial H. A. Schofield, better known as "Sco," just naturally landed as Chairman of our Fellowship Committee after his first full year in the Chapter. Sco has been in the San Francisco Office of the Libbey Owens Ford Glass Co. since September, 1943.

Good hearted Sco exudes blood for the boys overseas as well as fellowship. He has been active in fraternal organizations and the American Legion. His daughter is a recent bride of "a guy who's been hit" recovering from wounds received in France, and his son is in the Air Corps, ASTP unit, at the University of Utah.

Sco was born in Detroit, across the river from President George, was an engineering student at Ohio University when World War I broke, went through five major engagements with the 37th Division. After the war he entered the cut stone industry which he served for sixteen years as Chief Draftsman and Estimator.

Next came contracting as a Field Engineer and Construction Superintendent until 1943, when he joined Libbey Owens Ford Glass Co. and came West.

The Schofields live in Park Merced and in spite of the fact that it took them eleven months to find a house in San Francisco, Sco "isn't mad at nobody." Ironically, although he likes hunting and fishing, he has had no opportunity to indulge since he came to California. He likes his golf and bowling, too.

The G. E. Program presented to a joint meeting of the Northern California A.I.A. and Producers' Council Chapters was well attended.

Memo. It's open season again on Informational Meetings.

Atlanta becomes Chapter Number 23, being chartered March 5.

New Plan for encouraging greater attendance and more guests at Chapter Meetings works fine.

The April meeting to hear the United Air Lines presentation, "Coming Age of Flight," was the best yet.

Technical Information Committees in all Coast Chapters are working with their opposite number in the local A.I.A. Chapters to further the acceptance of Modular Coordination. Director Chuck Kraft has just completed a swing through the Northwest where he held meetings with the Oregon and Washington State Chapters. Chuck also was guest speaker at a meeting of the Oregon Chapter of the A.I.A. at which he explained the origin, aims and objects of the Producers' Council.

Ernest Flagg, F.A.I.A., was honored at a recent meeting of the New York Chapter, A.I.A. An active practitioner in New York City for over half a century and architect of many famous buildings his citation said in part, "He is distinguished also for his studies in housing and for his research in building materials and methods of construction, forever striving to bring buildings of better design and better construction within the economic grasp of the average citizen."

It is Interesting to note that modular coordination owes its present development to Mr. Flagg's research. Also that Modular Planning through coordination of dimensions of building materials and building layout was foremost pictured by Mr. Flagg as an **aid to design**. Far from fearing standardization he pointed out that standardization of parts did not mean standardization of buildings. "The standardization of parts promotes variety and encourages invention in design."

9 Million Jobs is the title of a booklet published by the American Society of Civil Engineers Committee on Post-war Construction. The Society believes there should be fifteen billion dollars' worth of new construction planned and ready for bids for the first year of peace. Planning takes time. Your post-war jobs and job depends on it, too.



USE QUALITY PRODUCTS CONSULT AN ARCHITECT

BOOK REVIEWS

THE NEW CITY, by Ludwig Hilberseimer; 189 pages, 142 plates, publ. in 1944 by Paul Theobald: \$5.95.

In this book the author presents a series of practical as well as theoretical studies of contemporary city planning. "The New City" is divided into four parts.

In part I, entitled Society and Cities, the author takes us back to the time when the "city" was a settlement of peasants and nomads, and from there he carefully analyzes "the change of pattern" of the city.

Part II deals with the Elements of City Planning; it is a most thorough study of such "elements" as topography, sun and room isolation, prevailing wind and smoke, density, and many others. Theories of various town planners are presented; the author then presents his own idea of an "independent settlement unit."

In Part III, entitled Replanning of Cities, his theoretical "unit" receives three practical applications: two are for industrial communities, and one for a large city—Chicago.

Part IV, the Art of City Planning, is a historical and esthetic survey of town planning from a Stone-Age settlement to the down-town of New York City.

Ludwig Hilberseimer is now Professor of City Planning at the Illinois Institute of Technology, and the "New City" is his fifth book. I shall present a more detailed review of this book in the next issue of Architect and Engineer.

JAN REINER.

GERM KILLING LIGHT

A new 4-page illustrated pamphlet containing answers to the most frequently asked questions of the subject of "air-disinfection" for personal protection has just been issued by the Edwin F. GUTH Company, St. Louis, Missouri. Many special fixtures are shown for wall, ceiling and floor mounting.

HOMOJA HOUSING HUTS

All of the prefabricated "Stran-Steel" construction of the 200 units of Homoja Housing Huts, planned by Ralph C. Flewelling, Architect, will be provided by the government. The Navy has been allocated \$588,000 for the project and all the furniture will be government supplied. One hundred fifty calendar days have been allowed for completion which is a short time, indeed, to erect 200 buildings from scratch, but the prefabricated Stran-Steel framework will save a lot of time.

STANLEY HARDWARE for CHURCH BUILDINGS

More than 4000 Churches are reported to be in project or actual plan stage for peacetime construction throughout the United States.

(F. W. Dodge Co. estimate)

There could be no finer symbol of the return to peace than the nation-wide church building program. And there could be no finer choice of hardware for these splendid buildings than that made by Stanley.

Stanley's traditional durability, fine craftsmanship and wide selection will be a valuable advantage to you in planning the hardware needs of new church construction in your community. The Stanley Works, New Britain, Connecticut.

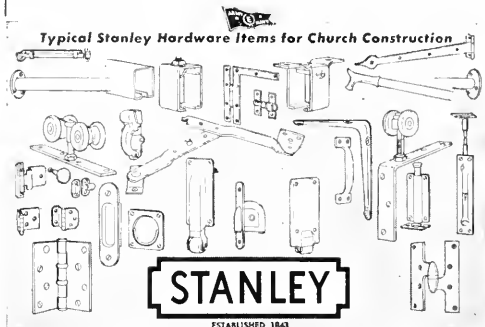

BAXCO

CHROMATED ZINC CHLORIDE

CZC

PRESSURE TREATED LUMBER
● **PROTECTS AGAINST DECAY**
AND TERMITE ATTACK

Specify it in your home
Available through Lumber Dealers

LOS ANGELES
601 W. 5th Street
Phone Mlchigen 6294

SAN FRANCISCO
333 Montgomery Street
Phone DOuglas 3883

J.H. Baxter & Co.

AGENTS FOR WEST COAST WOOD PRESERVING CO. SEATTLE, WASH.

IN THE NEWS

CALIFORNIA SILK

An Assembly Interim Committee has reported on the proposed silk production in California. The report shows astounding possibilities such as the creation of a billion dollar industry in this state made possible by the following facts: we have the climate, the quality of silk produced in California is 60 per cent better than that of Japan, no skill is required to produce silk, we now have a mulberry leaf picking machine to offset Japanese cheap labor and we have a reeling machine to offset the Japanese manual labor. It certainly looks good.

WHAT! NO RADIATOR?

In the home of tomorrow, the radiator will be conspicuous by its absence. At least it won't be seen. The radiator is now reduced to a pipe around which are coiled fins of fine copper sheet that fits behind the baseboard—and goes all around the exposed walls of the room, delivering even heat to every corner.

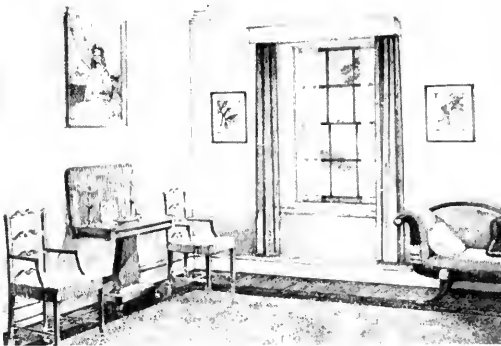

Air comes in at the floor-line, passes over the heating unit and warmed air comes out at the top. Because the warmed air is delivered over the entire length of the exposed walls of the room, there is no concentration of heat and practically no variation in temperature from wall to wall or from floor to ceiling. This new system has been under development by engineers of Warren Webster & Company and will be made available to home owners and home builders when war conditions permit.

CHAS. E. BUTNER is the architect for the Vosa Motor Company's Building in Salinas, the general contract for which has been awarded.

CLINTON CONSTRUCTION CO. OF CALIFORNIA

General Contractors

923 FOLSOM STREET • SAN FRANCISCO
SUtter 3440

MALOTT & PETERSON

ROOFING AND FLOORING CONTRACTORS

20TH AND HARRISON STREETS
SAN FRANCISCO
Phone ATwater 1600

HOGAN LUMBER CO.

Wholesale and Retail

LUMBER

MILL WORK • SASH & DOORS

Office, Mill, Yard and Docks
SECOND AND ALICE STREETS • OAKLAND, CALIF.
Telephone GLencourt 6861

SANTA MARIA INN

SANTA MARIA, CALIFORNIA

FRANK J. McCOY, General Manager
FERNAND E. PIMENTEL, Manager

On the
Coast
Highway
between
San
Francisco
and
Los
Angeles



American
or
European
Plan
•
Old
English
Tap
Room

ARCHITECT AND ENGINEER

Estimator's Guide

Giving Cost of Building Materials, Etc.

AMOUNTS GIVEN ARE FIGURING PRICES AND ARE MADE UP FROM AVERAGE QUOTATIONS FURNISHED BY MATERIAL HOUSES TO SAN FRANCISCO CONTRACTORS. 2½% SALES TAX ON ALL MATERIALS BUT NOT LABOR

All prices and wages quoted are for San Francisco and the Bay District. There may be slight fluctuation of prices in the interior and southern part of the state. Freight cartage, at least, must be added in figuring country work.

BONDS—Performance—50% of contract.
Labor and materials—50% of contract.

BRICKWORK—

Common Brick—Per 1M laid—\$50.00 to \$60.00 (according to class of work).
Face Brick—Per 1M laid—\$120 to \$150 (according to class of work.)
Brick Steps—\$1.60 per lin. ft.
Brick Veneer on Frame Bldg.—Approx. \$1.30 per sq. ft.
Common Brick—\$19.00 per M, truckload lots, f.o.b. job.
\$19.00 per M, less than truckload, plus cartage.
Face Brick—\$40 to \$80 per M, truckload lots, delivered.
Cartage—Approx. \$4.00 per M.

BUILDING PAPER—

1 ply per 1000 ft. roll.....	\$3.50
2 ply per 1000 ft. roll.....	5.00
3 ply per 1000 ft. roll.....	6.25
Brownskin, Standard, 500 ft. roll.....	5.00
Sisalcraft, 500 ft. roll.....	5.00
Sash cord com. No. 7.....	\$1.20 per 100 ft.
Sash cord com. No. 8.....	1.50 per 100 ft.
Sash cord spot No. 7.....	1.90 per 100 ft.
Sash cord spot No. 8.....	2.25 per 100 ft.
Sash weights, cast iron, \$50.00 ton.	
Nails, \$3.42 base.	
Sash weights, \$45.00 per ton.	

CONCRETE AGGREGATES—

The following prices net to Contractors unless otherwise shown.

Gravel, all sizes—	
\$1.95 per ton at Bunker; delivered.....	\$2.50
Bunker	
Top Sand.....	\$1.90
Concrete Mix.....	1.90
Crushed Rock, ¼" to ¾".....	1.90
	2.50

Crushed Rock, ¾" to 1½".....	1.90	2.50
Roofing Gravel.....	2.25	2.80
River Sand.....	2.00	2.45

Sand—
River Sand..... 2.00 2.45
Lapis (Nos. 2 & 4)..... 2.85 3.15
Olympia (Nos. 1 & 2)..... 2.85 3.10
Del Monte White..... 84c per sack

Cement—
Common (all brands, paper sacks), carload lots, \$2.42 per bbl. f.o.b. car; delivered \$2.72.
Cash discount on carload lots, 10c a bbl., 10th Prov., less than carload lots \$3.20 per bbl. f.o.b. warehouse or delivered.
Cash discount 2% on L.C.L.

Atlas White.....	} 1 to 100 sacks, \$2.50 sack
Calaveras White.....	
Medusa White.....	bbl. carload lots.

Forms, Labors average \$200.00 per M.
Average cost of concrete in place, exclusive of forms, 35c per cu. ft.; \$10 cu. yd.; with forms, 60c.
4-inch concrete basement floor..... 30c per sq. ft.
Rat-proofing..... 7½¢
Concrete Steps..... \$1.25 per lin. ft.

DAMP-PROOFING and Waterproofing—

Two-coat work, \$3.50 per square.
Membrane waterproofing—4 layers of saturated felt, \$7.00 per square.
Hot coating work, \$2.50 per square.
Medusa Waterproofing, \$3.50 per lb. San Francisco Warehouse.
Tricocel waterproofing.
(See representative.)

ELECTRIC WIRING—\$12 to \$15 per outlet for conduit work (including switches).

Knob and tube average \$3.00 per outlet. (Available only for priority work.)

ELEVATORS—

Prices vary according to capacity, speed and type. Consult elevator companies. Average cost of installing a slow speed automatic passenger elevator in small four story apartment building, including entrance doors, about \$6500.00.

EXCAVATION—

Sand, 60 cents; clay or shale \$1 per yard. Teams, \$12.00 per day.

Trucks, \$22 to \$27.50 per day.
Above figures are an average without water. Steam shovel work in large quantities, less; hard material, such as rock, will run considerably more.

FIRE ESCAPES—

Ten-foot galvanized iron balcony, with stairs, \$150 installed on new buildings; \$160 on old buildings.

FLOORS—

Composition Floor, such as Magnesite, 33c to 50c per square.
Linoflor—2 gauges—\$1.25 to \$2.75 per sq. yd.
Mastapay—90c to \$1.50 per sq. yd.
Battleship Linoleum—available to Army and Navy only—¼" —\$1.75 sq. yd.
¾" —\$2.00 sq. yd.
Terazzo Floors—50c to 70c per square.
Terazzo Steps—\$1.75 per lin. ft.
Mastic Wear Coat—according to type—20c to 35c.
Hardwood Flooring—
Standard Mill grades not available.
Victory Oak—T & G
¾" x 2¼"..... \$143.25 per M. plus Cartage
½" x 2"..... 122.00 per M. plus Cartage
½" x 1½"..... 113.50 per M. plus Cartage
Prefinished Standard & Better Oak Flooring
¾" x 3¼"..... \$180.00 per M. plus Cartage
½" x 2½"..... 160.50 per M. plus Cartage
Maple Flooring
¾" T & G Clear..... \$160.50 per M. plus Ctg.
2nd..... 153.50 per M. plus Ctg.
3rd..... 131.25 per M. plus Ctg.
Floor Layers' Wage, \$1.50 per hr.

GLASS—

Single Strength Window Glass.....	20c per □ ft
Double Strength Window Glass.....	30c per □ ft.
Plate Glass, under 75 sq. ft.....	\$1.00 per □ ft.
Polished Wire Plate Glass.....	1.40 per □ ft.
Rgh. Wire Glass.....	.34 per □ ft.
Obscure Glass.....	.27 per □ ft.
Glazing of above is additional.	
Glass Blocks.....	\$2.50 per □ ft. set in place

HEATING—

Average, \$1.90 per sq. ft. of radiation, according to conditions.
Warm air (gravity) average \$48 per register.
Forced air, average \$68 per register.

IRON—Cost of ornamental iron, cast iron, etc., depends on designs.

LUMBER—All lumber at O.P.A. ceiling prices—

No. 1 Common \$49.00 per M
 No. 2 Common 47.75 per M
 Select O. P. Common 52.75 per M

Flooring—

Delvd.
 V.G.-D.F. B & Btr. 1 x 4 T & G Flooring \$80.00
 C 1 x 4 T & G Flooring 75.00
 D 1 x 4 T & G Flooring 65.00
 D.F.-5.G. B & Btr. 1 x 4 T & G Flooring 61.00
 C 1 x 4 T & G Flooring 59.00
 D 1 x 4 T & G Flooring 54.00
 Rwd. Plastic—"A" grade, medium dry 82.00
 "B" grade, medium dry 78.50

Plywood—

Under \$200 Over \$200
 "Plyscord"— $\frac{3}{8}$ " \$49.50 \$47.50
 "Plywall"— $\frac{1}{4}$ " 45.15 43.30
 3 ply— $2\frac{1}{2}$ — $\frac{1}{4}$ " 48.55 46.60
 "Plyform"— $\frac{3}{8}$ "—
 Unoiled 126.50 121.45
 Oiled 127.90 122.75

Above prices delivered if quantity is sufficient to warrant delivery.

Shingles (Rwd. not available)—

Red Cedar No. 1—\$6.75 per square; No. 2, \$5.75; No. 3, \$4.45.
 Average cost to lay shingles, \$3.00 per square.
 Cedar Shakes—Tapered: $\frac{1}{2}$ " to $\frac{3}{4}$ " x 25"—\$8.95 per square.
 Resawn: $\frac{3}{4}$ " to $1\frac{1}{4}$ " x 25"—\$10.65 per square.
 Resaws: $\frac{3}{4}$ " to $1\frac{1}{4}$ " x 25"—\$10.65 per square.
 Average cost to lay shakes, \$4.00 per square.

MILLWORK—Standard,

O. P. \$100 per 1000. R. W. rustic \$100.00 per 1000 (delivered).
 Double hung box window frames, average with trim \$6.50 end up, each.
 Complete door unit, \$10.00.
 Screen doors, \$3.50 each.
 Patent screen windows, 25c a sq. ft.
 Cases for kitchen pantries seven ft. high, per lineal ft., \$9.00 each.
 Dining room cases, \$9.00 per lineal foot.
 Rough and finish about 80c per sq. ft.
 Labor—Rough carpentry, warehouse heavy framing (average), \$40.00 per M.
 For smaller work average, \$40.00 to \$55.00 per 1000.

MARBLE—See Dealers

PAINTING—

Two-coat work per yard 50c
 Three-coat work per yard 70c
 Cold water painting..... per yard 10c
 Whitewashing per yard 8c

PAINTS—

Two-coat work 50c per sq. yd.
 Three-coat work 70c per sq. yd.
 Cold water painting..... per yard 10c
 Whitewashing 8c per sq. yd.
 Turpentine \$1.03 per gal. in drum lots.
 \$1.08 per gal. in 5-gal. containers.
 Raw Linseed Oil—not available.

Boiled Linseed Oil—\$1.38 per gal. in drums. Available only to work with high priority—\$1.48 per gal. in 5-gal. containers.

Use replacement oil—\$1.86 per gal. in 1-gal. containers.

Replacement Oil—\$1.20 per gal. in drums. \$1.30 per gal. in 5-gal. containers.
 A deposit of \$6.00 required on all drums.

PATENT CHIMNEYS—

6-inch \$1.20 lineal foot
 8-inch 1.40 lineal foot
 10-inch 2.15 lineal foot
 12-inch 2.75 lineal foot

PLASTER—

Neat wall, per ton delivered in S. F. in paper bags, \$17.60.

PLASTERING (Interior)—

Yard
 3 Coats, metal lath and plaster 1.50
 Keene cement on metal lath 1.80
 Ceilings with $\frac{3}{4}$ hot roll channels metal lath (lath only) 1.20
 Ceilings with $\frac{3}{4}$ hot roll channels metal lath plastered 2.20
 Single partition $\frac{3}{4}$ channel lath 1 side (lath only) 1.20
 Single partition $\frac{3}{4}$ channel lath 2 inches thick plastered 3.20
 4-inch double partition $\frac{3}{4}$ channel lath 2 sides (lath only) 2.20
 4-inch double partition $\frac{3}{4}$ channel lath 2 sides plastered 3.85
 Thermax single partition; 1" channels; $2\frac{1}{4}$ " overall partition width. Plastered both sides 3.30
 Thermax double partition; 1" channels; $4\frac{1}{2}$ " overall partition width. Plastered both sides 4.40
 3 coats over 1" Thermax nailed to one side wood studs or joists 1.65
 3 coats over 1" Thermax suspended to one side wood studs with spring sound isolation clip 1.90
 Note—Channel lath controlled by limitation orders.

PLASTERING (Exterior)—

Yard
 2 coats cement finish, brick or concrete wall \$1.00
 3 coats cement finish, No. 18 gauge wire mesh 2.00
 Lime—\$3.00 per bbl. at yard.
 Processed Lime—\$3.10 bbl., at yard.
 Rock or Grip Lath— $\frac{3}{8}$ "—20c per sq. yd.
 $\frac{1}{2}$ "—19c per sq. yd.

Composition Stucco—\$1.80 to \$2.00 per yard (applied).

PLUMBING—

From \$100.00 per fixture up, according to grade, quantity and runs.

ROOFING—

"Standard" tar and gravel, 4 ply—\$8.00 per sq. for 30 sqs. or over.
 Less than 30 sqs. \$9.50 per sq.
 Tile, \$30.00 to \$40.00 per square.
 Redwood Shingles, \$7.50 per square in place.
 5/2 # 1-16" Cedar Shingles, $4\frac{1}{2}$ " Exposure \$6.00 square

5/8 x 16"—# 1 Cedar Shingles, 5" Exposure \$9.00 square
 4/2 # 1-24" Royal Shingles, $7\frac{1}{2}$ " Exposure \$9.50 square
 Re-coat with Gravel \$4.00 per sq.
 Asbestos Shingles, \$23 to \$28 per sq. laid.
 1/2 x 25" Resawn Cedar Shakes, 10" Exposure \$10.50
 3/4 x 25" Resawn Cedar Shakes, 10" Exposure 11.50
 1 x 25" Resawn Cedar Shakes, 10" Exposure 12.50
 Above prices are for shakes in place.

SHEET METAL—

Windows—Metal, \$1.75 a sq. ft.
 Fire doors (average), including hardware \$2.00 per sq. ft.

SKYLIGHTS—(not glazed)

Copper, 90c sq. ft. (flat).
 Galvanized iron, 40c sq. ft. (flat).
 Vented hip skylights 60c sq. ft.

STEEL—STRUCTURAL (None available except for defense work).

\$150 ton (erected), this quotation is an average for comparatively small quantities. Light truss work higher. Plain beams and column work in large quantities \$140 per ton.

STEEL REINFORCING (None available except for war work).

\$150 to \$200 ton, set.

STONE—

Granite, average, \$6.50 cu. foot in place.
 Sandstone, average Blue, \$4.00. Boise, \$3.00 sq. ft. in place.
 Indiana Limestone, \$2.80 per sq. ft. in place.

STORE FRONTS (None available).

TILE—

Ceramic Tile Floors—70c to \$1.00 per sq. ft.
 Cove Base—\$1.10 per lin. ft.
 Glazed Tile Wainscot—\$1.25 per sq. ft.
 Asphalt Tile Floor $\frac{1}{8}$ " & $\frac{3}{8}$ "—\$.18 to \$.35 per sq. ft. Light shades slightly higher.
 Cork Tile—\$.40 to \$.75 per sq. ft.
 Mosaic Floors—see dealers.
 Lino-Tile, \$.35 to \$.75 per sq. ft.

Wall Tile—

Glazed Terra Cotta Wall Units (single faced) laid in place—approximate prices:
 2 x 6 x 12 \$1.10 sq. ft.
 4 x 6 x 12 1.25 sq. ft.
 2 x 8 x 16 1.20 sq. ft.
 4 x 8 x 16 1.40 sq. ft.

VENETIAN BLINDS—

40c per square foot and up. Installation extra.

WINDOWS—STEEL—

30c per square foot, \$5 for ventilators.

NEWS AND COMMENT ON ART

(From page 36)

practice, however, the number is narrowed to those which have proven most effective and which are easily controlled. These colors are generally indicated by the word fen (powdery or light), fa lang (cloisonne) and yang (foreign). As a rule the word fen, the most general term, is used when the color is of low saturation; fa lang, when it resembles the color of enamelware or cloisonne; and yang, when it is foreign to the Chinese color scheme. All goods from Canton are said to be of foreign origin, hence shades used by Cantonese porcelain painters are generally called yang (foreign) or hsi yang (European).

Such shades as primrose and canary is an opaque yellow enamel from the famille rose palette, the lighter tones being obtained by adding a little opaque white enamel to the glaze. They are called fen huang (light yellow) and yang huang (foreign yellow) and are often used as a surfacing ground color on wares decorated with designs in underglaze blue.

To be distinguished from the translucent composite green are members of a larger and less rare group using opaque enamels. These are applied over fish-roe crackles and so are called yu tzu lu (fish-roe greens). There are several recognizable shades, a yellowish camellia leaf, a dark myrtle leaf, a deep spinach, and a greyish sage green. Some medium fired green glazes, applied sur biscuit over stoneware, also yield fish-roe crackles. There are several shades of opaque mustard with medium sized or fish-roe crackles.

The pink enamel (fen hung) of the famille rose

palette yields mei kuei hung (mei kuei, pinkish hung (rouge pink or carmine) and yang chih shui (pigmental rouge). The white enamel of an apparently implies a tint or a non-lustrous, relatively thin coated glaze. Thus p'ao tao shui (pale purple) is a thin, pale aubergine while fen t'ao shui (purple) is a thicker opaque aubergine.

By mixing the colors of the famille rose palette or by adding opaque white many new shades were produced. The addition of white to green in increasing strength yields successively a foreign turquoise (yang ts'ui), an ancient bronze green (ku tung lu), a French gray (apple, light green) and an opaque clare de lune (yang yueh paia). Pink, blue and white gives ch'ing lien (amaranth lotus, a deep purple), and the addition of white gives a light purple and a lavender. Yellow and green gives ku lu (ancient green) and the addition of white yields eau de nil (Nile green, a pale bright yellowish green).

We note from the above that the hue, brilliance, shade and texture of monochromes are endless, depending on the saturation of the coloring mineral, the nature of the flux, the firing condition and the body material used. The many shades of green from each of the three palettes, for example, may be applied over pottery, stoneware, slip, soft paste, porcelain sur biscuit or porcelain overglaze, giving successively a lighter and brighter tone for any one shade of green used. By using colored paste or slip (grey, buff, brick-red, etc.) or glaze (celadon, golden yellow, sacrificial red, etc.) additional variations are secured. Again the flux may be increased until a jewelled or gem-like enamel (p'ao lai ts'ai) is produced. (The concluding article by Chingwah Lee will appear next month.)

1945 BUILDING TRADES WAGE SCALES (JOB SITES) NORTHERN CALIFORNIA

Six- and seven-hour day eliminated on all Government Work.

A. F. L. - O. P. M. Agreement calls for eight-hour day.

NOTE: Predeterminations by the Department of Labor, as of July 1, 1944 (the wage-freezing date) have not yet been made in all of the counties listed. The wage scales shown are those being paid and in effect mostly by agreement between employers and their union.

CRAFT	Alameda and Contra Costa		Marin	Sacramento	San Jose	San Mateo	Vallejo	Stockton
	San Francisco	Contra Costa						
ASBESTOS WORKERS	1.50	1.50	1.25	1.50	1.25	1.50	1.50	1.25
BRICKLAYERS	1.87 $\frac{1}{2}$	1.87 $\frac{1}{2}$	1.75	1.87 $\frac{1}{2}$	1.75	2.00	1.79-1/6	1.75
BRICKLAYERS' HODCARRIERS	1.50	1.50	1.05	1.40	1.05	1.50	1.35	1.50
CARPENTERS	1.50	1.50	1.25	1.43 $\frac{1}{2}$	1.25	1.37 $\frac{1}{2}$	1.43 $\frac{1}{2}$	1.50
CEMENT FINISHERS	1.50	1.50	1.50	1.50	1.50	1.50	1.50	1.50
ELECTRICIANS	1.70	1.70	1.70	1.70	1.70	1.70	1.70	1.70
ELEVATOR CONSTRUCTORS	1.75 $\frac{1}{2}$	1.75 $\frac{1}{2}$	1.75 $\frac{1}{2}$	1.75 $\frac{1}{2}$	1.75 $\frac{1}{2}$	1.75 $\frac{1}{2}$	1.75 $\frac{1}{2}$	1.75 $\frac{1}{2}$
ENGINEERS: MATERIAL HOIST	1.50	1.50	1.50	1.50	1.50	1.50	1.50	1.25
PILE DRIVER	1.75	1.75	1.60	1.75	1.75	1.75	1.75	1.75
STRUCTURAL STEEL	1.75	1.75	1.60	1.75	1.75	1.75	1.75	1.60
GLASS WORKERS	1.40	1.40	1.12 $\frac{1}{2}$	1.40	1.12 $\frac{1}{2}$	1.21	1.40	1.40
IRONWORKERS: ORNAMENTAL	1.60	1.50	1.60	1.50	1.60	1.31 $\frac{1}{2}$	1.50	1.50
REINF. RODMEN	1.50	1.50	1.60	1.50	1.50	1.60	1.50	1.25
STRUCTURAL	1.75	1.75	1.75	1.75	1.75	1.75	1.75	1.37 $\frac{1}{2}$
LABORERS: BUILDING	1.00	1.00	.90	.87 $\frac{1}{2}$.95	.90	.93 $\frac{3}{4}$.90
CONCRETE	1.00	1.00	.90	.87 $\frac{1}{2}$.95	.90	.93 $\frac{3}{4}$	1.00
LATHERS	1.75	1.75	1.50	1.75	1.60	1.75	1.75	1.75
MARBLE SETTERS	1.50	1.50	1.80	1.50	1.50	1.50	1.50	1.50
MOSAIC & TERRAZZO	1.25	1.25	1.12 $\frac{1}{2}$	1.25	1.15-5/B	1.12 $\frac{1}{2}$		
PAINTERS	1.50	1.50	1.28-1/7	1.50	1.43	1.50	1.42-4/7	1.37 $\frac{1}{2}$
PILEDRIVERS	1.54	1.54	1.54	1.54	1.54	1.54	1.54	1.54
PLASTERERS	1.75	1.83 $\frac{1}{2}$	1.75	1.75	1.75	2.00	1.75	1.83-1/3
PLASTERERS' HODCARRIERS	1.50	1.60	1.40	1.50	1.18 $\frac{1}{2}$	1.50	1.75	1.50
PLUMBERS	1.70	1.70	1.53-1/8	1.70	1.68 $\frac{1}{2}$	1.62 $\frac{1}{2}$	1.70	1.70
ROOFERS	1.50	1.50	1.25	1.37 $\frac{1}{2}$	1.37 $\frac{1}{2}$	1.37 $\frac{1}{2}$	1.25	1.37 $\frac{1}{2}$
SHEET METAL WORKERS	1.50	1.50	1.50	1.50	1.50	1.50	1.37 $\frac{1}{2}$	1.50
SPRINKLER FITTERS	1.58	1.58	1.53-1/8	1.70	1.68 $\frac{1}{2}$	1.62 $\frac{1}{2}$	1.70	1.70
STEELERS	1.75	1.75	1.53-1/8	1.70	1.68 $\frac{1}{2}$	1.62 $\frac{1}{2}$	1.70	1.70
STONESETTERS (MASON'S)	1.87 $\frac{1}{2}$	1.87 $\frac{1}{2}$	1.50	1.75	1.75	1.50	1.75	1.50
TILESETTERS	1.50	1.50	1.37 $\frac{1}{2}$	1.50	1.37 $\frac{1}{2}$	1.50	1.50	1.37 $\frac{1}{2}$

Prepared and compiled by

CENTRAL CALIFORNIA CHAPTER, ASSOCIATED GENERAL CONTRACTORS OF AMERICA

with the assistance and cooperation of secretaries of General Contractors Associations and Builders Exchanges of Northern California.

THE TORMEY COMPANY

GENERAL PAINTERS
AND DECORATORS

Phone UNderhill 1913

563 FULTON STREET
San Francisco

G. P. W. JENSEN & SON

Building Construction

320 Market Street, San Francisco
Phone: GARfield 2444

JOHN CASSARETTO COMPANY

—Since 1886—And Still Active—

Building Materials

READY MIX CONCRETE
ROCK - SAND - GRAVEL - LIME
CEMENT - PLASTER - MORTAR
METAL LATH - WOOD LATH
STUCCO - WIRE NETTING

Service Unexcelled

Bunkers
Sixth and Channel, San Francisco
Phones: GARfield 3758 - 3760

MULLEN MFG. COMPANY

BANK, STORE AND OFFICE
FIXTURES—CABINET WORK
OF GUARANTEED QUALITY
CHURCH SEATING

Office and Factory:
60-80 RAUSCH ST., Bet. 7th and 8th Sts.
San Francisco
Telephone UNDERhill 5815

IN THE NEWS

WAR PLANES TO BE HOUSED IN GLASS CLOTH HANGARS

Glass cloth, woven of glass fiber yarns and coated with either synthetic rubber or resin, has been selected by the U. S. Army Corps of Engineers for curtains, side walls and ends in newly developed airplane hangars installed at advance Army Air Forces bases.

Glass cloth was selected because of its resistance to the effects of mold and fungus, high strength in proportion to its light weight, and ease of handling to fit around plane fuselages. Canvas duck, previously used, was subject to rot from tropical dampness and would not withstand fungus attack.

Coatings used on the glass cloth includes neoprene and vinyl compound. Glass cloth is supplied by Owens-Corning Fiberglas Corporation, Toledo, Ohio.

USING POWER TO REDUCE HANDLING TIME



Handling time of bulky raw material containers from warehouse storage to manufacture is reduced in this instance by utilizing an Elwell-Parker fork type electric industrial truck to propel four containers at one time. These large cans, mounted on casters, hold 400 pounds of material and were formerly pushed individually by hand. Four of them chained together are moved much faster by the power truck which is equipped with a special pusher attachment.



HERRICK IRON WORKS

STRUCTURAL STEEL
REINFORCING STEEL

18TH AND CAMPBELL STS.
OAKLAND, CALIF.
Phone GLencourt 1747

Phone GARfield 1164

Thomas B. Hunter

Consulting Engineer

DESIGNER OF HEATING
AIR CONDITIONING
VENTILATING AND WIRING
SYSTEMS, MECHANICAL
AND ELECTRICAL EQUIP-
MENT OF BUILDINGS

41 SUTTER STREET
ROOM 710
San Francisco California

ANDERSON & RINGROSE

General Contractors

320 Market Street, San Francisco
Phone GARfield 2245

DINWIDDIE CONSTRUCTION COMPANY

BUILDERS

CROCKER BUILDING
SAN FRANCISCO

ARCHITECT AND ENGINEER

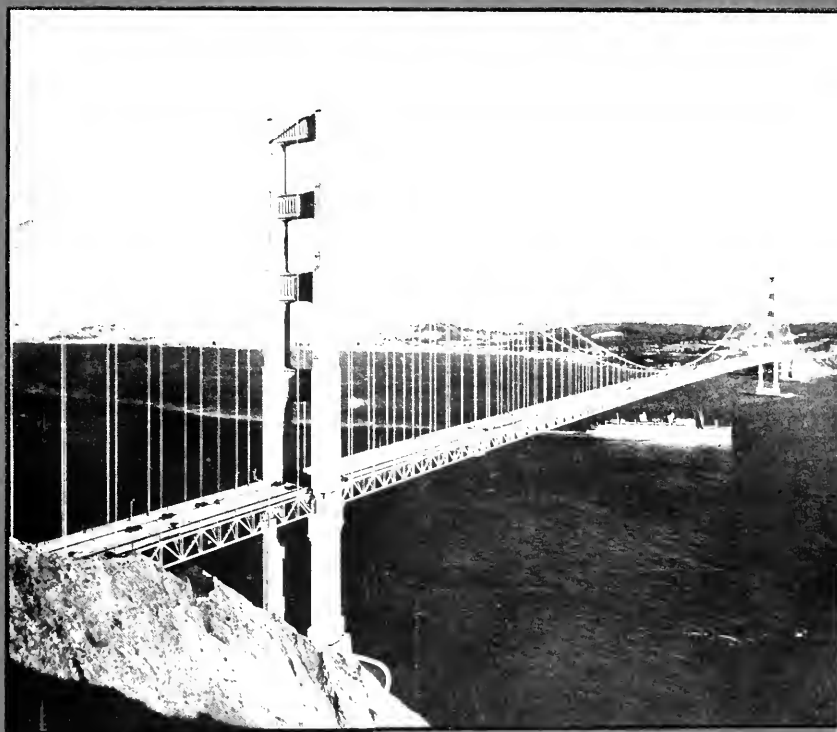

JUNE

1945

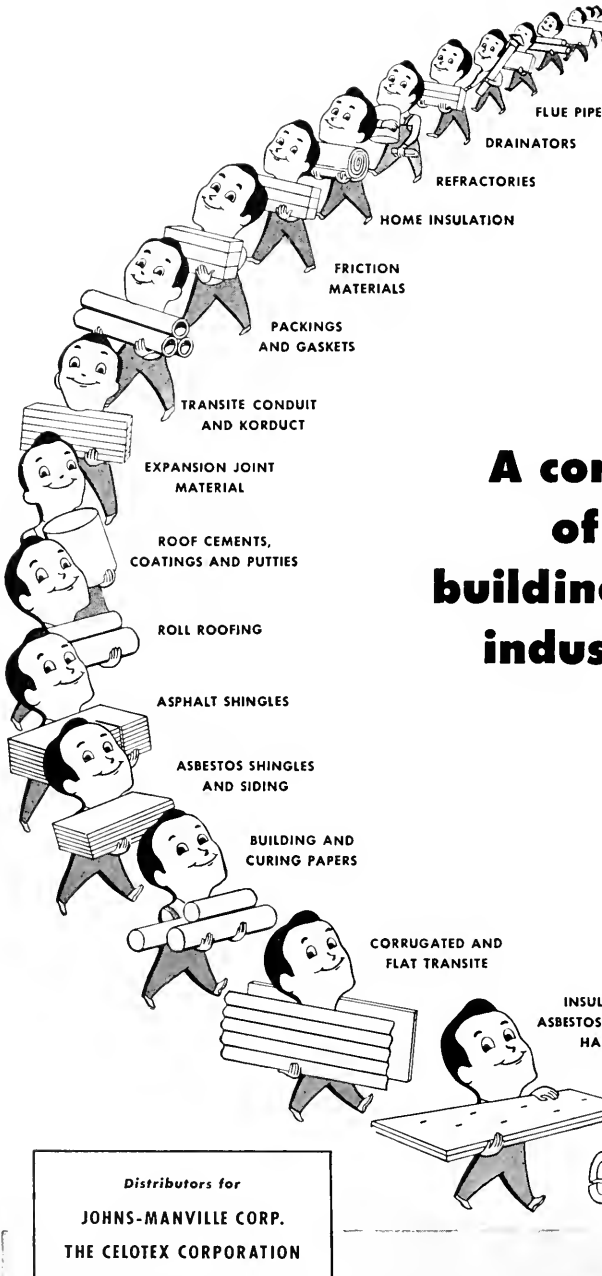

FLUE PIPE

DRAINATORS

REFRACTORIES

HOME INSULATION

FRICTION MATERIALS

PACKINGS AND GASKETS

TRANSITE CONDUIT AND KORDUCT

EXPANSION JOINT MATERIAL

ROOF CEMENTS, COATINGS AND PUTTIES

ROLL ROOFING

ASPHALT SHINGLES

ASBESTOS SHINGLES AND SIDING

BUILDING AND CURING PAPERS

CORRUGATED AND FLAT TRANSITE

INSULATING BOARDS
ASBESTOS-CEMENT BOARDS
HARD BOARDS

INSULATING MATERIALS FOR PIPING, BOILERS, INDUSTRIAL EQUIPMENT AND REFRIGERATION

Distributors for
JOHNS-MANVILLE CORP.
 THE CELOTEX CORPORATION
 NATIONAL AUTOMOTIVE FIBRES, Inc.
 THE COE MANUFACTURING CO.
 ANGIER CORPORATION

A complete source of supply for building materials and industrial products

WESTERN ASBESTOS CO.
Building Materials · Industrial Products

• ARCHITECT

Vol. 161

No. 3

ARCHITECTS' REPORTS—Published Daily

Telephone DOuglas 8311

AND ENGINEER

MARK DANIELS
Editor

E. H. WILDER
Associate Editor

MICHAEL GOODMAN
Post-War Planning

L. H. NISHKIAN
Consulting Editor

E. N. KIERULFF*
Ass'l Editor
*In the Service

★
Contents for

JUNE

COVER: Golden Gate Bridge—Symbol of Western Enterprise

ARTICLES AND MISCELLANEOUS TEXT

	Page
RUNNING FIRE	By Mark Daniels 4
FAMILLE ROSE PORCELAIN	By Chingwah Lee 6
NEWS AND COMMENT ON ART	7
COVER PICTURE	8
TWENTY-FIVE YEARS OF ENGINEERING	By Mark Daniels, A.I.A. 14
HOUSING AGAIN!	By Lawrence E. Mawn, A.I.A. 19
"THE NEW CITY"	A Review by Jan Reiner 21
AMERICAN-SOVIET ARCHITECT CONFERENCE	22
A PLEA FOR THE BURNHAM PLAN	By George S. Hill 23
PROPER TIMING FOR POST-WAR WORK	25
CALIFORNIA HIGHWAYS	By Edwin H. Wilder 27
IN THE NEWS	30, 32, 33, 39, 42
TREES	31
WITH THE ENGINEERS	36
A.I.A. ACTIVITIES	37
PRODUCERS' COUNCIL PAGE	40
BOOK REVIEWS	41
THE A.I.A. IN THE NORTHWEST	46
INDEX TO ADVERTISERS	48

★

ARCHITECT AND ENGINEER (Established 1905) is published on the 15th of the month by The Architect and Engineer, Inc., 68 Post St., San Francisco 4; Telephone EXbrook 7182. President, K. P. Kierulff; Vice-President and Manager, L. B. Penhorwood; Treasurer, E. N. Kierulff, Advertising Manager, V. E. Atkinson, Jr.

Los Angeles Office: 403 W. 8th Street.

Entered as second class matter, November 2, 1905, at the Post Office in San Francisco, California, under the Act of March 3, 1879. Subscriptions United States and Pan America, \$3.00 a year; \$5.00 two years; foreign countries \$5.00 a year; single copy 50c. ARCHITECTS' REPORTS are published daily from this office, Vernon S. Yallop, Manager.

★

RUNNING FIRE — by MARK DANIELS

THE TIME HAS COME

For several years we have waited for the time when we could return to building and construction work with vigor and enough freedom from the restrictions of materials placed there by war emergency. Now the time has come when the liberation of materials for civilian use is going to catch many of us unprepared to use materials that soon will be available because we have not completed our preliminary plans.

The Federal government has made available \$75,000,000 (which many authorities hold is not enough), as an amount of funds with which to start the plans for public improvements.

The Producers' Council announces that three billion dollars is a fair estimate of the money that will be spent on farm buildings of which \$1,850,000,000, will be spent on new farm dwellings during the next five years.

The reports of Engineering Construction jobs are increasing in leaps and bounds.

The estimates, based on sound study, of the amounts of money to be spent on plumbing and heating plants, electric wiring, roofing, and painting and decorating run to more than a billion dollars.

The State of California has issued a partial outline of their highway work that runs into hundreds of millions of dollars.

Materials for building are being liberated for civilian use in greater quantities daily.

The demand for the services of contractors, engineers, architects is rising like a tidal wave. How can this demand be met? Who has the material wanted? Where can we get the equipment in a hurry? These questions can be answered only by the contractors, engineers and architects who are ready to take on the work and supply the demands. In the mad rush that we are facing there will be no time to hunt for supply houses or engineers. Those who are best known will be called on first. This is no time to hide the light under a bushel.

MONUMENTS

In the past we have erected to our own and other heroes, statues that many of our present day artists and sculptors claim are of questionable artistry. Our taste in art, sculpture and architecture are ever changing, or at least we think so, so that what we erect now as a monument may, in the generations to come, be considered as inartistic, clumsy or out of form. (Witness the innumerable bronze statues of men with one hand

thrust in the bosom of the coat and the other hand waving aloft a scroll.)

If the style of representation has changed so much in the past century it is quite possible that it will change again. So, let us do away with the custom of monuments in the form of statues, heroic columns, arches of triumph and the like, and dedicate something wherein the hearts of all the people can give expression to their appreciation of the sacrifices of our departed heroes.

The daily press is becoming more and more loud in the cry for "useful memorials" as against monuments. Gardens, planted groves, auditoriums, swimming pools and beautifully planted boulevards have been proposed but, while each one of them is more desirable than a statue, none seems to carry the ideality of the plan to set aside a great forest grove as the State of California has done in the Redwood Empire. In an area of over five thousand acres the State has set aside a great forest of towering Sequoias to be known as the National Tribute Grove, dedicated to all who served their country during this war. That will be a real monument, one that will not go out of style; thousands of the oldest living things, the tallest living things on earth.

A LITTLE TOO LATE

Most of us feel that Argentina's declaration of war against Germany was, to say the least, a little too late, but, to use one of our own clichés, they might have felt, "better late than never." Should the Japanese adopt the same line of reasoning they may also feel justified in applying for a seat at the San Francisco Conference by declaring war on the Romans even though their progeny were allies.

THE WRITERS DATE THEM

Some sculptors and artists are becoming vociferous in their claims that the major events of history were recorded by their arts. To an extent that is true but it takes the writers to date them. It is also true that much of what the artists of the past have told us would have been better left unsaid. Not that we of today have such clean skirts; God forbid that all that is expressed by the artists and sculptors of today should go down as records of these times.

RUDOLPH A. POLLEY has moved from 824 South McClelland Street, Santa Maria, to 1320 Farris Street, Fresno.



FAMILLE ROSE PORCELAIN: A bowl of the Ch'ien Lung period, a jar of the Yung Cheng period and a saucer of the Ch'ien Lung period. Photograph, courtesy of the de Young Museum.

FAMILLE ROSE PORCELAIN

By CHINGWAH LEE

In reviewing glazes we have ignored for the time being the important role potting plays in the artistry of ceramics. Superior potting is judged by the perfection of form, suitability of the material and texture to the type of ware, correct placing of handles and other protuberances, if any, appropriate weight, appropriate distribution of tooled ornamentation, if any, harmony of form to func-

tion, and efficiency in the utilization of available technics. The following are some of the factors which play an important part in potting:

1. Height and diameter. All artistic wares follow the dynamic law of portion, the taller and more complicated wares having more involved ratios. In general, height gives a note of dignity to the ware, but beyond a certain limit a feeling of

NEWS AND COMMENT ON ART

instability is imparted to the beholder. A wide base gives a feeling of stability, while a wide flaring mouth expresses authority, generosity, etc., depending on the shape.

2. Curvature of lines. Most K'ang Hsi wares, when studied from the standpoint of contours, show a predominance of straight lines or lines with very gentle curves. This vigorous display of strength—partly resulting from giving height to the vessel—adds to the masculinity of the ware. In contrast to this the well-rounded Ch'ien Lung wares tend to be squat and effeminate.

3. Placing of the Shoulder. All other factors excluded, the higher the shoulder the greater the degree of sobriety or austerity expressed. A low shoulder gives a note of informality, while the absence of a shoulder creates an atmosphere of simplicity—for shoulders are a luxury born of excesses. Note that forms produced for display below the eye level are typically low-shouldered (as for example, a pear-shaped vase) while those for exhibition above the eye level are usually high-shouldered.

4. Location of reliefs and protuberances. An examination of classic wares shows that the location of handles, spouts, openwork carvings, reliefs and luted ornamentations are not haphazard but always where they contribute to the shapeliness of the object.

5. Size and weight. The size of any one form is limited by such factors as functions, the thickness of the wall, the nature and tensile strength of the material, etc. By reducing an ewer into a miniature, for example, the handle and spout soon become non-functional and the object becomes a toy or a curio. An enlarged amphora will seek the out-of-doors to serve the gods, but made still larger it becomes a meaningless case of gigantism. Comparing this with an amphora which feels "just right" we realize that the search for a happy size and a correct weight is the occupation of an artist.

6. Distortion and suppression. Distortion may be a fault in potting or firing, but it can also be a virtue in artistry. The superior potter introduces those minute, subtle finishing touches—expressed through exaggeration or distortion and diminution or suppression—to create an atmosphere of austerity, sensuality, gaiety or modernity, bringing his ware beyond the reach of imitators.

Relief and openwork ornamentation is a feature of Chinese ceramics from the earliest time, but the seventeenth and eighteenth century potters—who delighted in showing their marvellous skill—had

(See Page 8)

EXHIBITS FOR U.N.C.I.O. DELEGATES

While the conference of the U.N.C.I.O. is in progress in San Francisco the Museums will redouble their efforts to display their best exhibits.

At least the M. H. DeYoung Memorial Museum and the California Palace of the Legion of Honor will be in condition to handle and entertain the great crowds that are sure to visit them during the conference.

The San Francisco Museum of Art, needed for delegates and their assistants, was forced to move to 441 Post Street where it will remain until their permanent home is again available. While in the Post Street location they will hang the annual Water Color Exhibit.

The museums and art schools and galleries have had their hands full in an effort to meet the schedules of the Conference and also to give the delegates an opportunity to see the exhibitions.

(See Next Page)

GEORGE WASHINGTON



by Gilbert Stuart (American)

Lent to the M. H. De Young Memorial Museum by the Edwin D. Levinson Collection, New York, and representing the United States in the exhibition, Art of the United Nations.

COVER PICTURE

THE WORLD FAMED GOLDEN GATE BRIDGE which spans historic Golden Gate at San Francisco is a fitting symbol of "Western" enterprise and stands as an everlasting tribute to the vision and foresight of community leaders and to the courage and ability of engineering progress.

The "International Orange" color of the structure represents the "Welcome" and "Farewell" to world travelers who pass beneath the bridge in sturdy ocean going vessels, or overhead in fast sky-lane planes.

The two 746-foot tall towers are 4200 feet apart and support 36½-inch steel cables from which a six-lane motor vehicle, plus two pedestrian walk, deck is suspended.

ARCHITECT & ENGINEER, in selecting this month's "Cover," gives recognition to the importance in economic and engineering development of the West by construction of the Golden Gate Bridge.

NEWS AND COMMENT ON ART

(From Preceding Page)

As a result it is difficult to outline a program ahead of time, but the permanent collections at the California Palace of the Legion of Honor will justify the trips and all the time the delegates can spare to visit the museum. In addition, the large exhibition of Contemporary Painting that opened May 17th will probably last through June.

THE CALIFORNIA SCHOOL OF FINE ARTS is still working hard on the development of their Student Association, which will bring out a publication they have decided to entitle "PERSPECTIVE." The bulletin published monthly is, at present, couched in the language, or rather style, of the student and is written mostly for the students which is probably as it should be but it makes reviewing rather thankless.

SUMMER SESSION IN ARTS AND CRAFTS

The California College of Arts and Crafts in Oakland announces a summer session which should create widespread interest for teachers of art, advanced students, artists, and craftsmen.

Mr. Spencer Macky, President, announces there will be twenty courses in the arts and crafts, conducted by a faculty of fifteen instructors. Among the courses offered are figure drawing and painting, advertising art and illustration, decorative design, weaving, textile design, pottery, ceramics, leather work, bookbinding, and occupational therapy crafts.

In addition to the regular faculty, there will be two distinguished guest instructors. Glenn Wesells will teach an advanced course in the exploration of the basic principles of space, form, and composition. Eugene Bielawski will introduce a significant departure in the introduction for the first time in the college of a comprehensive work shop course in the newer conceptions and techniques of contemporary design.

There will be lecture courses in art appreciation and a series of illustrated lectures on modern architecture. Special classes for children from the ages of six to twelve and for high school students will also be a part of the very diversified program which the California College of Arts and Crafts has to offer in its 39th annual summer term, which begins June 25th and closes on August 3rd.

FAMILLE ROSE PORCELAIN

(From Page 7)

made tooled ornamentation especially their own.

Carved ceramics are called tiao yao (carved wares); the ornamentation itself is called ting chuang (surface ornamentation) or tiao ko (sculpturing); and the process, tiao ko (sculpturing) or tiao hua (relief carving).

Raised relief, called chui kung (awl-raised design) or tieh hua (relief decoration) is divided into ko tieh (high relief), pan tieh (half relief) and ti tieh (low relief). These are also known as fou hua (raised decoration) pan tuo hua (half-raised decoration) and ch'ien fou hua (shallow decoration). Low reliefs are often made by applying slip with a brush; these slip reliefs being known as pate sur pate or tsui hua (brush-piled decoration). Applied reliefs are luted to the ware with water or slip and are often left unglazed. They are called tiao hsiang (applied carving).

The faintest decoration, whether faintly raised or incised, is barely perceptible even when held obliquely before a strong light. These are called an hua (secret decoration) and are generally found on eggshell porcelain, called t'o t'ai (bodiless) or luan mo (egg membrane). Though the earliest specimens of eggshell with an hua are found among the ying ching and the ting ware, the finest are the eggshell pre-hand cups of the Yung Lo period.

Hollow relief or intaglio is known as yin tiao (negative carving) or wa tiao (sunken relief), divided into shen yin tiao (deep hollow relief) and ch'ien yin tiao (shallow sunken relief). Incised decoration is called hua hua (etched decoration) or hsiu hua ("embroidered" decoration). The term hsiu hua is applied to any delicate tracery work, whether painted or incised. Wares covered with

(See Page 10)

Deciding what projects should come first, how you'll build them, what materials you'll use becomes the *immediate* concern of all who —because of official authority or special talent—are in position to contribute to the future progress of this great empire.



NOW IS THE TIME

for men with Plans!

TODAY'S leaders face the biggest peacetime jobs of their careers. The billions that will be spent for state, county, municipal and private construction after the war call for sound thinking NOW.

From whatever angle you approach the problems of post-war construction, STEEL should loom large in your planning. For steel's versatility of application, great durability and ultimate economy make it the ideal material for all types of road and bridge construction, as well as for new schools, hospitals, homes and other structures.

The more steel you specify for

these projects, the faster and more permanent their construction. Because of its high modulus of elasticity and high strength-weight ratio, easy-to-handle prefabricated steel is readily adaptable to all types of construction.

The great mills of United States Steel will be in position to handle your requirements for U-S-S Construction Steels — either direct from the Pacific Coast or from other strategic locations—so go ahead with your plans. If you need help in working out special applications, skilled engineers are ready now to give you the benefit of their broad experience.

**U-S-S
CONSTRUCTION STEELS**

- PLATES
- WIRE RODS
- STRUCTURAL SHAPES
- REINFORCING BARS
- HOT ROLLED SHEETS
- MERCHANT BARS
- GALVANIZED SHEETS
- PIPE AND TUBING
- CASTINGS
- HOT ROLLED STRIP
- COLD ROLLED SHEETS
- ELECTRICAL WIRES
- WIRE AND WIRE PRODUCTS
- SHEET PILING
- WIRE ROPE
- STAINLESS STEEL
- NAILS
- FABRICATED STRUCTURAL WORK



COLUMBIA STEEL COMPANY

San Francisco · Los Angeles · Portland · Seattle · Salt Lake City

Pacific Coast Distributors for

American Bridge Company · American Steel & Wire Company · Carnegie-Illinois Steel Corporation
National Tube Company · Tennessee Coal, Iron & Railroad Company
United States Steel Export Company, New York

UNITED STATES STEEL

FAMILLE ROSE PORCELAIN

(From Page 8)

an over-all geometrical pattern of incised or carved sunken relief are sometimes called chin ti tiao hua (carved brocaded ground). Deeply channeled sunken relief, generally in short curvy lines, arranged to give a design, when filled with translucent glaze, gives the highly desired "lace work" effect.

Stamped or moulded decoration is generally in low relief, whether raised or sunken. It is called pin hua (impressed decoration). A peculiar thing about the beautiful moulded Ting ware is that no one so far has found two articles from the same mould.

Many moulded wares are after ancient bronze forms—such as tri-pot vessels, ku-vases and p'ing-jars. Some connoisseurs objected to these imitations on the very good ground that this violated a fundamental law of art (that objects should be made according to the nature of its substances), but alas for these critics recent investigations have proven that the bronze forms were in turn copied from yet earlier (aeneolithic) pottery vessels, and are essentially "plastic" in their conception. Viewed in this newer light what had been a weak-

ness in bronze was "corrected" when copied in porcelain.

Pierced decoration or carving in openwork is called luo kung (hollowed carving), kwei kung (devil's work) or ling lung (carved openwork). Ling lung originally means the gentle tinkling sound of gems. It was extended to mean an artificially carved grotto, and also an ornate style. Jars or vases carved in openwork generally have an inner wall or core so that the use of the vessel is not impaired. Revolving vases with an outer casing in openwork is called chuan hsin p'ing (revolving core vases).

The "rice grain" effect is made by having small openings (about the size of a grain of rice) made in the porcelain to form a design, these openings being filled with translucent glaze before firing. The graviata is made by etching floral scrolls or wave design on an enameled ground. The "orange peel" effect of this period is often highly exaggerated; unlike the "heaped and piled" ripple effect found on Ming ware, the surface of the glaze is often almost scabrous. Modeling in the round of birds, animals and figures were made in fairly large number, but they lack the naturalism displayed by the T'ang potters.

(See Page 12)

All out for the Mighty 7th!

The 7th War Loan is a challenge
to every American . . . the goal for
individuals is the highest for any
War Loan to date . . . help mop up
the Japs . . . BUY BONDS!

The Treasury Department acknowledges with appreciation publication of this message by

DINWIDDIE CONSTRUCTION CO.

CROCKER BUILDING

San Francisco



Now Available...

KRAFTILE STRUCTURAL CLAY PRODUCTS IN MODULAR CO-ORDINATED DIMENSIONS

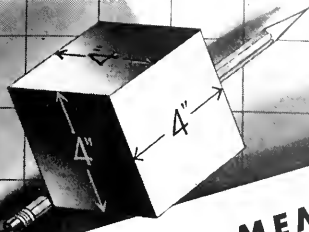

MEMO

NOTES ON MODULAR CO-ORDINATION

What It Is: Architecturally, modular coordination means planning or designing according to a common denominator or unit of measurement.

Standard Module Adopted: The four-inch module has been adopted as this unit in the "Proposed American Standard Basis for the Coordination of Dimensions of Building Materials and Equipment", and the American Standards Association's Project A62, for which the American Institute of Architects and the Producers' Council are the joint sponsors.

Manufacturer Cooperation: Members of the Structural Clay Products Institute, Metal Window Institute, National Concrete Masonry Association, and National Door Manufacturers Association (wood doors and windows) are preparing to make available modular products for postwar construction, and the manufacturers of many other building materials are actively studying the application of dimensional coordination to their products.

What It Means: The nominal layout of architectural drawings in plan and elevation in multiples of 4" permits the use of modular-coordinated products with a minimum of cutting and fitting, resulting in a reduction in waste and substantial savings in material and labor.

Note: Contact Kraftile Company for further information.

"We acknowledge the assistance of the American Institute of Architects in criticizing the subject matter and form of presentation of this publication."



**"KRAFTILE CAN ANSWER YOUR
SPECIAL CONSTRUCTION PROBLEMS"**

KRAFTILE COMPANY · NILES · CALIFORNIA

FAMILLE ROSE PORCELAIN

(From Page 10)

Just before the end of the K'ang Hsi period (1664-1723 A.D.) Cantonese porcelain painters brought about a change which transformed the complexion of porcelain the world over. By transferring the palette of opaque colors used in decorating cloisonne and enamelwares to porcelain, they created a new class of polychromes. These are called famille rose by French connoisseurs because rose is the dominant color. The Chinese have many names for this palette: *juan ts'ai* (soft colors), *fen ts'ai* (powdery or opaque colors) and *fa len ts'ai* (cloisonne enamels). It is also called *yang ts'ai* (foreign colors) because the Chinese attribute a near-East origin to their enamelwares and cloisonne, and *fang hsi yang ts'ai* (imitation European colors) because the enamels are quite similar to those used by French enamelers. Meanwhile, the enamels of the famille verte palette received the contrasting name of *ying ts'ai* (hard or translucent colors).

By the time of Yung Cheng (1723-1735 A.D.) famille rose practically replaced famille verte, both in Canton and Ching-te Chen. Typical Cantonese decoration consists of *shan-shui* (landscape) *huan-niu* (birds and flowers) and *jen-mu* (figures and objects), surrounded by as many as seven elaborate borders, that being the style of the time in Canton—a style which extended to ladies' and children's garments. The Ching-te Chen wares for domestic consumption are generally simply decorated—usually the same motifs as the Cantonese painters but more simplified and without borders. Porcelain for the foreign markets were decorated with famille rose enamels in a style which may be classified as "rococo". In the beginning the scholars and mandarins were slow in accepting the famille rose, as they found it too gaudy and effeminate, but with the advent of a new type of porcelain as well as refined style of painting (the Ku Yueh Hsien style) they too succumbed to the charm of the famille rose.

Meanwhile, influenced undoubtedly by the court glass makers, Ching-te Chen produced a dead white porcelain of great delicacy. These articles—generally for the cabinets or the scholars' tables—were decorated with a mixed palette of famille rose and famille verte enamels—the rose vertes. Shadings were used and many new hues were employed—for example, a golden brown for tree trunks or rockery and an inky black for writer, inscriptions. The painting usually represented court ladies in a garden or birds and flowers and are overpoweringly beautiful and other-worldly. These porcelains are known to the Chinese as *ky*

yueh hsien (old moon pavilion). The origin of that name has always been a mystery to students of the subject. It is certain that *ky yueh hsien* is not the name of any pavilion or palace in the Imperial City, either at Yung Cheng or the Ch'ien Lung period, for searches over old maps and historical documents failed to reveal any edifices by that name. The generally accepted belief is that *ky yueh hsien* is the name of a studio of glass makers owned or operated by a man surnamed Hu (this name is made of two component words, old and moon) and whose wares were said to have captured the fancy of the emperor. Fine imperial-grade porcelain made after the style of the *ku yueh hsien* glass soon came to be known as *ky yueh hsien* porcelain. In support of this theory we may say that there are decorated glass with the words *ku yueh hsien* mark, but all *ky yueh hsien* porcelain has the enameled imperial reign mark and never the *ku yueh hsien* mark.

Another theory is to the effect that *ku yueh hsien* porcelain were made in close imitation of a certain type of palace porcelain but were for the gentry, and these are called *ku yueh hsien* ware instead of palace ware. When porcelain of this type were smuggled out of the palace to the market in the tenth year of Hsien Feng (1850 A.D.) the collectors, noting the similarity of the decoration, immediately termed the imperial porcelain *ku yueh hsien* ware. In support of this theory we should note that forerunners of the *ku yueh hsien* style are to be found in K'ang Hsi ware. We may note also that the *ku yueh hsien* style extended to enamelware and painted ivory. The *ku yueh hsien* porcelain is the rarest ware this side of the K'ang Hsi period and commands an enormous price today.

Many new types of souffles were made with the advent of the famille rose palette. The earliest souffle is the *ts'ui ch'ing* (powder blue), made by blowing cobalt blue through a tube, one end of which is covered with a gauze. The simplest souffles are those employing one enamel—the color was blown onto the ware until a dappled monochrome was created, and then fired in a muffle kiln. Examples of single colored souffles are the *ts'ui hung* or souffle coral red and *ts'ui ch'ing* or souffle green.

The more usual souffles encountered are those employing two or more opaque colors. Robin's egg blue is made by blowing a deep opaque blue enamel onto a light turquoise blue ground, the darker color appearing as minute dots or circlets. If the blue is blown through a coarser screen the islands of blue will be larger, and if this is allowed to streak downward a jasper or marbled effect is

(See Page 20)



FROZEN FOOD STORAGE DISTRIBUTION PLANT, Oakland, Calif.

ALBIN FROBERG, Architect

CHRISTENSEN & LYONS, Contractors

Mr. Alvin Langfield, President of Frozen Food Distributors, Inc., announces that the firm has now completed and occupied their plant at 57th and Lowell Streets in Oakland. The building was designed by Albin Froberg, architect, and was built by Christensen & Lyons, general contractors.

About a year ago the management of Frozen Food Distributors, Inc., realized that the Company's expanding business had outgrown the facilities of public warehouses and that, in order to handle its business efficiently and economically, it was necessary to have its own quarters. These plans involved a degree of pioneering, as this type of distribution requires its own peculiar lay-out in the way of a building.

On Saturday, May 19th, Frozen Food Distributors, Inc., moved into its completely new structure. The building combines both architectural good looks and efficiency of operation. The freezer warehouse, the office, the machinery room, and garage are all under one roof and on one level so as to provide the maximum ease in handling merchandise. The warehouse contains fifty thousand cubic feet of freezer space and is insulated with six inches of fiberglass which has the highest insulating value of any insulating material. This is illustrative of the Company's continuing desire to keep itself in a position to handle these perishable products in such a way that they reach the grocer in the very best of condition.

(See Page 42)

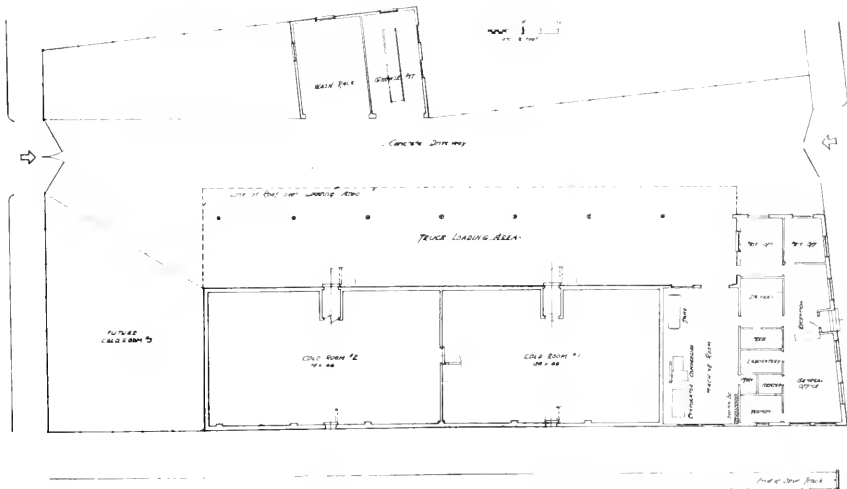

Floor Plan

ALBIN FROBERG, Architect



FOX THEATER . . . San Francisco

THOS. W. LAMB, Architect

MacDONALD & KAHN, General
Contractors

Twenty-Five Years of Engineering

By **MARK DANIELS, A.I.A.**

San Francisco was a partially ruined city, badly in need of rebuilding, at the time L. H. Nishkian received his degree of B.S. in Civil Engineering from the University of California. He, with others, immediately started on that job and has been at it ever since. Not that his work has been restricted to the confines of San Francisco; far from it, for his field has expanded during the past twenty-five years to embrace all of California and frequently has extended into neighboring states and

territories and even into Federal work and foreign countries, as a consulting engineer.

It is not at all uncommon to hear, nowadays, "If you've got a tough steel framing job, better get Nish," and it is not at all surprising to learn that the tough problems of even Federal and foreign work, eventually found their way into his offices before their solutions were found.

The forty years since Mr. Nishkian left college have in no way inhibited his habit of keeping

abreast, and usually several years ahead, of modern practice in Civil Engineering. Many of the ideas that were called Nishkian methods are in common practice today. The "tough ones," the problems that stump most engineers, sooner or later find their way to Nishkian's office to come out solved.

Some years ago, the American Society of Civil Engineers published a bulletin on "Moments in Restrained and Continuous Beams by the Method of Conjugate Point," by L. H. Nishkian and D. B. Steinman, which bulletin has been of great use to the designers of continuous structures.

The system derived and explained in this bulletin greatly facilitates the solution of continuous structures under any condition of loading and variation in span. Many designers who use this method have found it far simpler than the more tedious analytical methods and, in addition, find that the graphical solution greatly aids them in seeing the various points of counter flexure in the structure. Mr. Nishkian's principle as set forth in this bulletin is in general use throughout the United States, as are many other ideas that he has promulgated.



L. H. NISHKIAN, A.S.C.E.
Consulting Engineer

PROPOSED SAN FRANCISCO BAY INTERNATIONAL AIRPORT

Designed by L. H. NISHKIAN, Consulting Engineer. An exhaustive report accompanies the plan.

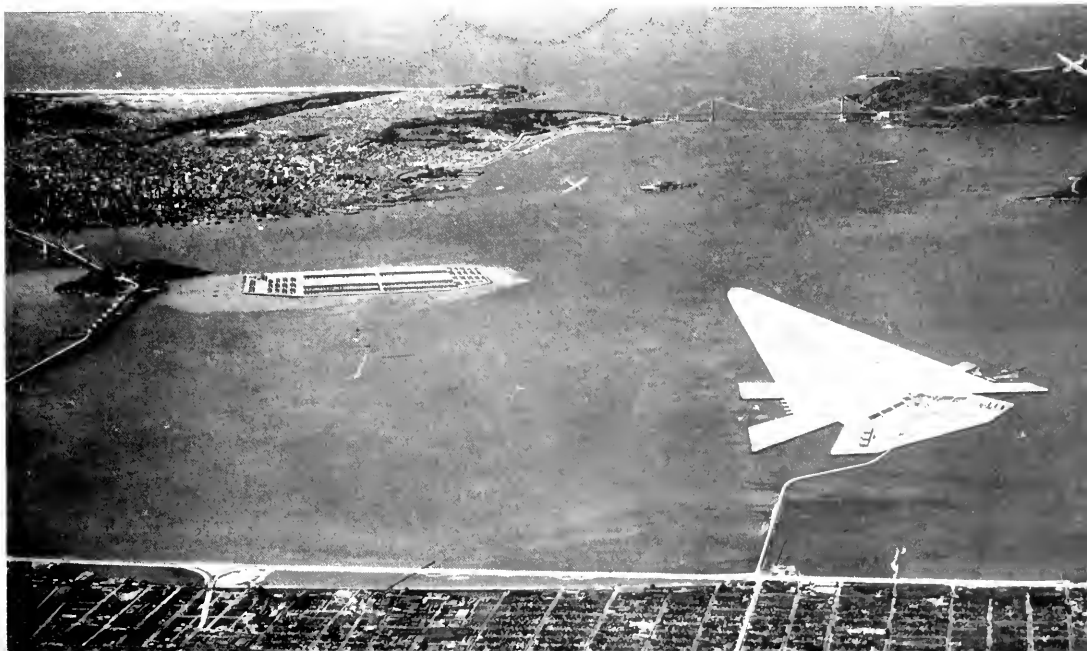

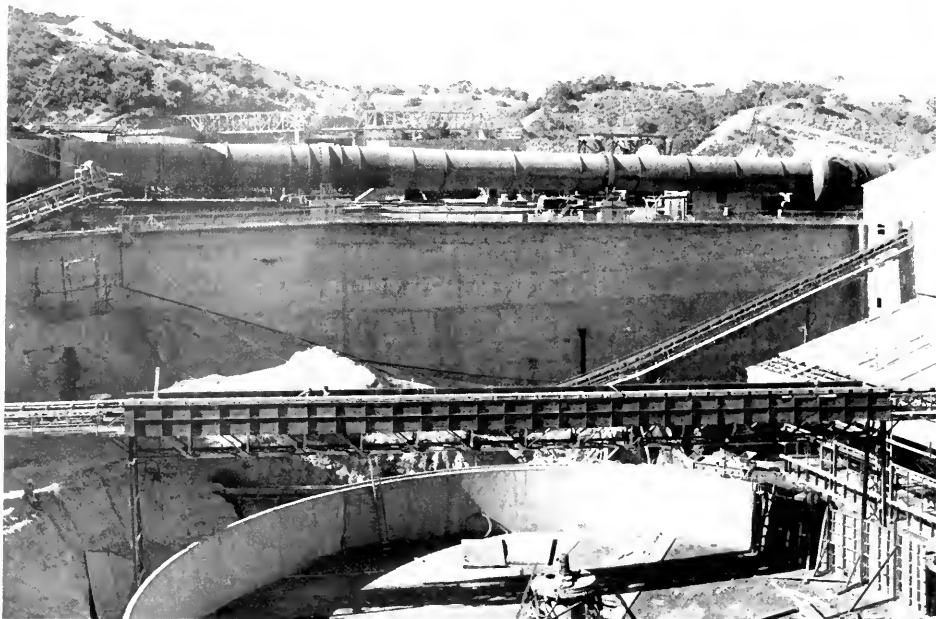

Above: Retaining Wall
3rd Kiln, Permanente

Below: Steel Framework
of Fox Theater

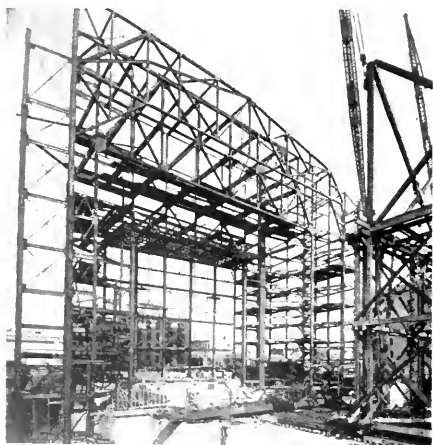

In addition to his activity in the affairs of the A.S.C.E., in which he is chairman of the Legislative Committee of the San Francisco Chapter, his collaboration on the report on Subsidence and the Foundation Problems in San Francisco has been invaluable in the city's extensive problems, particularly on made lands.

Mr. Nishkian started his engineering work back in 1906 when he went to work for G. Albert Landsburgh, Architect, on the two Gunst buildings, the old Orpheum Theatre on O'Farrell Street and several others that showed that the confidence in him, even at his then youth, was not misplaced.

After a short period on railroad location in Oregon, he was again back in San Francisco on the construction of the most familiar of all local landmarks, the Palace Hotel.

Following a period with the Pacific Rolling Mills as a steel detailer he went to southern California to join the force of Parkinson and Bergstrom, well known architects of Los Angeles, where he worked on the designs of the Los Angeles Athletic Club, the Los Angeles Title Insurance and the Union Oil Buildings.

In 1911 Mr. Nishkian was again back in San Francisco, this time working for the city of the City Hall. Here he worked on the Geary Street carbarns, the Hetch Hetchy project and finally as Consulting Structural Engineer for the City of San Francisco Building Department. MacDonald and Kahn finally succeeded in retaining him in 1918 and 1919 to design a number of buildings in the city's "automobile row" and the California Raisin Growers Association plant in Fresno, and, with thirteen years of experience in every phase of engineering behind him, Mr. Nishkian opened offices as a consulting engineer in San Francisco. Since that time he has done close to a thousand jobs.

Among the many landmarks that are familiar to most people which were engineered by Nishkian are the Loew Warfield Theatre at Market and Taylor Streets, San Francisco's most pretentious theatre; The Fox Theatre building; the Bellaire Apartment atop Russian Hill; the Insurance Center Building at Pine and Sansome Streets; the head office of the Bank of America at Pine and Montgomery Streets, and the Furniture Exchange at Market and Tenth.

Of his engineering work that is not strictly steel frame designing, perhaps the best known projects

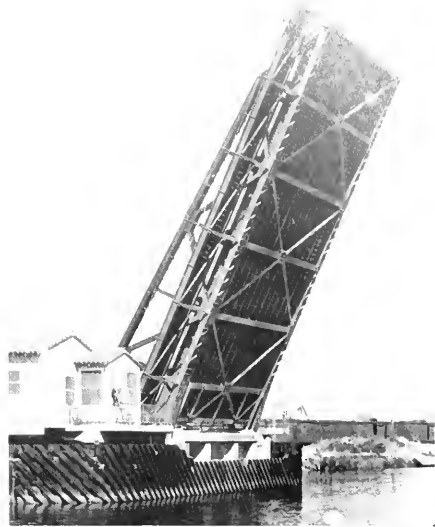

BASCULE BRIDGE

on "D" Street, Petaluma



BATTERY OF CEMENT SILOS AT PERMANENTE

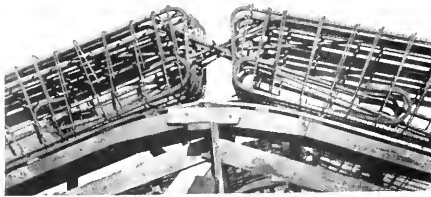

THREE-HINGED ARCH

Used in Park Presidio School Gymnasium

are those for Henry J. Kaiser for whom he designed the plant at Radum, California, to be followed by engineering work for several of Mr. Kaiser's associated companies. Much of the work at the Permanent Cement plant was done by Mr. Nishkian.

Since the beginning of the defense program the number of buildings he has engineered for the Joshua Hendy Iron Works at Sunnyvale, California, is such that the plant must be seen in order

to realize its great extent, and the same might be said of the Kaiser Yards at Richmond.

In addition to specific jobs resulting from war conditions, Nishkian has done a great amount of work for both the Army and the Navy, especially for the latter and the Maritime Commission on the San Francisco Bay waterfront.

At present, in addition to being engineer for the Golden Gate Bridge and Highway District, he is planning the deepening of the shipbuilding basins at the Kaiser Yard number three at Richmond to accommodate naval ships; the mass feeding project on the Waterfront, and the design of a bascule bridge on Third Street over Islais Creek, San Francisco.

These are the more prominent projects L. H. Nishkian has been doing and is doing.

There are many others that might more properly have been put in this category, but where to stop is the question. No, the question is, **What does he do with his spare time?**



WAREHOUSE OF KAISER COMPANY, Richmond, California

Housing

Again!

By LAWRENCE E. MAWN, A.I.A.

Low-income housing has been pursued in almost as many diverse ways as Lewis Carroll's Sark. And almost equally entertaining things have been spoken and written about it. During long and bitter controversies, harsh invectives, censorious accusations, ugly names have been tossed with gay abandon by all sides. This unfettered contest of wits is conducted in an atmosphere of noisy confusion. Any substantial change is unlooked for.

Successive studies have consistently shown that a large percentage of our population is unable to rent living quarters considered decent in the light of American standards. The number is close to one-third of both urban and rural residents. Practically all quarters renting for less than \$20 a month have been denounced as substandard. Few people who can afford better are found to live voluntarily in these squalid, unfit hovels.

The expense of providing and maintaining for substandard areas adequate fire and police protection, necessary water and sewer mains, health services, and penal and corrective institutions to combat their high delinquency and crime rates is out of all proportion to the returns from these areas. Communities cannot afford these areas of substandard dwellings.

All those who propose solutions insist that the problem should be handled their way. These say

the only way is by Federal aid. These say the only way is by local government. These say the only way is by private enterprise. These say the only way is by charity. Others propose other irreconcilable policies. All these groups cannot be satisfied.

Above this turmoil of claim and counterclaim, of petulant bickering and querulous reprobation, stands the sane and sound suggestion of the American Institute of Architects, worthy of thoughtful attention. It is outlined in the A.I.A. Bulletin of February of this year. The officers and members of this group as a whole have never been accused of radicalism or extremism.

Acutely aware of the vital importance and the dangerously controversial nature of the problem of housing our low-income group, this body has expressed a decided preference for public participation as the only workable solution under present circumstances.

The nature of the proposed participation is clarified later in this article.

Very distinct is the plain statement of the Institute's belief that "provision of decent housing for those of our population who cannot pay economic rents is a generally acknowledged obligation of the American way-of-life."

While the Institute would like to see private enterprise bear as much of the load as possible, it candidly and realistically faces the fact that "it has seen no development which would indicate a probability that private enterprise will be able to care for the needs of even a major portion of the families now in sub-standard housing unless a substantial increase in the economic level of this class can be brought about."

* Editor's note: The article in the March issue of THE ARCHITECT & ENGINEER entitled "Public Housing a Fallacy!" by Mr. W. P. Lauenberg has awakened several who do not agree with him. Mr. Lawrence E. Mawn, who is well qualified to present the other side and since, to plagiarize Voltaire, we may not agree with what our contributors say we will defend to our last pica their right to say it, we present Mr. Mawn's reply from the southern part of the state.

The Institute is forced to the conclusion that "public assistance in some forms will be necessary to discharge the obligation of American society to this group."

As to the meaning of public housing much disagreement exists. The Institute clarifies its stand on public participation by distinguishing between various forms thus:

1. Federal Public Housing: Housing constructed under Federal direction wholly with Federal funds, and remaining under Federal ownership.
2. Federal-aid Public Housing: Housing constructed under a local Housing Authority, partly financed by Federal funds, but remaining under local ownership.
3. Local Public Housing: Housing constructed under a local Housing Authority, wholly financed by local funds and remaining under local ownership.

Housing by private enterprise by FHA or similar financing is not considered public housing under any of these headings since such financing is based on expected profitable returns from all invested funds.

As recorded in the Bulletin, the architectural profession considers that public housing is primarily a local problem; and further "that Federal assistance or direction should be restricted to the minimum which may be necessary to assure throughout the country both reasonably uniform standards of housing accommodation and quality of construction and reasonably uniform distribution of housing facilities in accordance with demonstrable needs." An overwhelming majority opposition was registered to Federal Public Housing as above defined. An equal overwhelming approval was found for Federal-aid Public Housing and for Local Public Housing as above defined.

The Institute hopes that local interest in housing will be revived to restore local initiative in relieving the distress of the ill-housed. The Institute hopes for legislation that will further this local initiative in the elimination of slums and in intelligent broad planning of areas to be rehabilitated in order to avoid the injudicious and wasteful dissipation of public funds at variance with sound local needs.

So much for housing the low-income groups who can afford to rent only substandard dwellings.

Serious attention should be given to another problem, broader but less dramatic, that of achieving security of reasonably priced, adequate shelter for those of low income who are not forced to live in substandard housing and of arriving at an efficient system of small-home ownership with in-

(See Page 34)

FAMILLE ROSE PORCELAIN

(From Page 12)

secured. Sometime the islands will assume the shape of dark-centered tear-drops, in which case an argue-eyed peacock feather effect is obtained.

A deep pink blown onto a turquoise ground produces the more typical lu chun (muffle kiln Chun ware). The lu ma chun (muffle kiln Ma Chun ware) is secured by blowing or splashing one or more spots of red on a sky-blue ground. A deep crimson red sprayed onto an opaque white ground gives the strawberry soufflé. A leaf green on a chartrusse or light lemon-yellow gives a dappled green, sometimes called ts'ui kua pi lu (blown melon-rind green).

What is called ts'ui fa lan (cloisonne soufflé) is made by blowing red and blue enamel lightly onto a turquoise ground—this ground usually being supplemented by raised gilt biscuit reliefs to complete the illusion. Variegated soufflé (ts'ui wu ts'ai) is made by blowing splashes of red, blue, green, yellow and other colors on a white or pale green ground.

We should note here that many high-fired glazes, such as celadon and precious stone reds, were made at this time by alternately painting and blowing, as each layer dries, until about nine coats of glaze were given, but here the attempt is not to produce a speckled surface but a very thick and evenly applied glaze.

A large portion of Chinese porcelain was for the ever-growing foreign trade and these were called yang tsang tz'u (foreign style porcelain). During the T'ang dynasty and even earlier Chinese ceramics were already being exported to distant countries, either by direct shipping or by the "bucket" method. According to the Chu Fan Chin, the Lung Ch'uan celadons were exported through the port of Ch'uan Chou to the Malayan islands, the Indian Ocean, the Persian Gulf and the east coast of Africa. Fragments of high-fired celadons and white porcelain were recovered from the site of the city of Samarra on the Tigris, deserted in 883 A.D. During the Sung dynasty celadon and coarse stonewares constituted a great part of the export trade. The famous "talking jars" of the Philippines were probably of Fukien origin. By the time of the Ming dynasty porcelain made for Persia, India and other near-East countries often have Arabic or Sanskrit inscription while those for Egypt, Mesopotamia, Java, the Philippines, etc., are of a general nature. Those for Siam, Burma, Thibet, Mongolia and Japan have designs especially suited for them or were made to their order. Such for example, are some of the "Imbade" wares for Japan and the "Lama Bowls" for Thibet and Mongolia.

During the seventeenth and eighteenth centuries

(Continued on Page 22)

"The New City"

City Planning Is a Social Task

Review by JAN REINER

The work of Ludwig Hilberseimer may not be familiar to the Western reader, but that does not mean that Professor Hilberseimer is a newcomer in the field of architecture and city planning. In fact, "The New City" is his fifth book published aside from numerous articles which appeared in magazines here and abroad.

"The New City" contains a wealth of knowledge collected over a period of many years. The author himself tells us that he began to work on his book some twenty years ago. "In those days," as he put it, "I made skyscraper cities. Later, I became interested in the considerably more important problems of sunlight, prevailing winds, small houses and gardens, and the human aspect of planning. I studied all the different problems involved, and developed planning principles out of needs of life and the nature of things, and arrived at the solution presented in this book."

Ludwig Hilberseimer sees city planning as a social task which solves problems of technics, science, space and architecture. "As these problems change with the social pattern of their times, the means of realizing the aims of city planning also change."

To explain these changing patterns and means, he takes the reader back to the time when the "city" was a settlement of peasants or nomads. Then, there were two types of design: the "organic"—the irregular, and the "geometric"—the preconceived. "We meet these two types again and again in the course of history, regardless of political, economic, spiritual, and cultural circumstances. The elementary reactions of man are unchanging; it is only the expressions of these reactions which change."

The nomad is the originator of the "geometric city." He is a hunter or a herdsman, and his animals are his basic means of livelihood. "His feeling for space is centripetal, all life incoming from a domain within a border line. His settlements are, therefore, essentially tent settlements,

moving from time to time, according to natural necessities." A nomad's camp is the simplest form of a city made to order; the location of tents and defense walls follows an abstract planning principle. Plans of Roman camps, North African Colonial cities, Peking, Versailles, and others are brought in to illustrate the origin and development of the geometric city. Professor Hilberseimer points out that the geometric settlements are the typical form of autocratic communities (and states) and that they were usually located on plains. "In such location artificial boundaries, established by a conqueror's claim for domination, replaces the natural borders. Autocratic cities were the creation of a ruler, and they rose suddenly."

The peasant, on the other hand, is the originator of the "organic city." He is bound to the soil and the plants, which are his means of livelihood. "His sense of space is centrifugal, for all life emanates from a central source. The settlements he built in the center of his fields—his living space—were naturally rooted in the soil, like trees."

A peasant settlement, then, is the forerunner of the organic city. While this city also grew according to a plan, it did not reveal any pronounced geometrical schemes. Organic cities, developed over centuries, and carefully followed the contours of the land. Many organic cities were started in locations of strategic importance. In Greece, for example, the tribes who originally lived in open villages, gathered into the "polis"—the city state—mainly for reasons of safety.

Professor Hilberseimer then reviews and illustrates the importance of defense in the design of a city. "For all men in all times, a principal reason for drawing together in settlements has been the need for protection." The author takes us from an ancient place of refuge protected by timber walls, to the Acropolis of Athens, to the Lutetia Parisiorum (present "Isle de la Cité" of Paris), to the nucleus of London, Jerusalem, and many other cities whose names are (or should be) familiar to us from school days.

In conclusion of this chapter the author reminds us that the "type of man-made defense has varied

THE NEW CITY by Ludwig Hilberseimer; 189 pages, 142 plates, 9" x 11" size, P. Theobald, pul., 1944. \$5.95.

with the change of offensive and defensive weapons," and that the "modern aerial warfare has made all city concentration dangerous." He then recommends that "Protection in the future must be accomplished by disurbanization and dispersal."

However, it is not only the fear of aggression that gathered men into the city. The author lists several other factors, of which I quote two: "New religions gave rise to new temples around which new cities grew while the older cities of extinct cults dropped into oblivion." . . . "The change of trade routes, the increase of the size of ships, the formations of sandbanks in harbors—these also were circumstances which, creating at one time the conditions under which cities could grow, created at other times the conditions which made those cities decline."

Like every conscientious planner, the author is keenly interested in economy and its relation to the design of a city. With his convincing accuracy, he points out that "the change in production patterns had been brought about by the expansion of the economic sphere, from the household to the city, to the nation, to the world."

He analyzes the various stages of economy from the Roman community, through the self-sufficient Gothic city, to the cities of the Renaissance and the 19th century, and finally to the modern city. "The machine, and the steadily advancing specialization it made possible, created an almost unlimited capacity for production. This capacity has been wrongly used and wastefully used or never fully used at all. This is the source of our economic disorder. That disorder is aggravated by the fact that most of the countries which were buyers and bases of raw materials themselves became industrialized and are now competitors seeking markets for their own surplus production. And here are the roots of the economic catastrophe which is shaking the social structure of our time."

"Social and constitutional progress lags far behind the achievements of technology" leads Mr. Hilberseimer into discussing various "pros" and "cons" of old, present, and future cities. "To solve the complex problem we must go back to fundamentals . . . A first step in this clarifying process is recognition of the fact that the city should be organized into industrial, commercial, residential, and recreational areas, and that all these areas must be connected with each other by transportation facilities. The essential task of city planning is the proper placing and the organic order of the various elements of the city."

(See Page 45)

FAMILLE ROSE PORCELAIN

(From Page 20)

export of porcelain to Europe reached the high-water mark. A large class to England, called Lowestoft, because for a while they were attributed to a factory by that name in England, have European shapes and styles of decoration—milk jugs, cups with handles, soup tureens, flat dinner plates, mustard pots and other non-Chinese shapes. The rococo decoration consisted mostly of baskets of flowers, pink lattice diapers, wreaths of roses and leaves, flying ribbons, etc. The border which surrounds the well-known Willow Pattern, a type which the Chinese call shan-shui lu-ko (landscape with belvederes) was evolved toward the end of the Ch'ien Lung period.

Armorial China bears the coat-of-arms of European nobles, the rarest being those traceable to crowned heads. Jesuit porcelain is decorated with sacred scenes representing the crucifixion or resurrection. Hellenic porcelain are decorated with scenes of Greek gods and goddesses, generally in an amorous mood.

The French concentrated in collecting monochromes, and many of their single-colored wares have ormolu mounting. They pioneered in the study of Chinese ceramics and today many porcelain are given French names—sang de boeuf, clare de lune, du Barry rose, famille verte, etc.

There are also ku yueh hsien porcelain with finely drawn European subjects after the French "Grand Monarch" style, but these were meant for the Mandarins rather than for export.

A large portion of the painted export porcelain, of semi-eggshell thinness, were decorated in Canton, although the porcelain were from Ching-te Chen. The back of some of these wares are coated with crimson or rose-pink enamels. These "ruby-backs" are in great demand to this day. They are found chiefly in Europe and America.

The pressure of commercialism, internal political disruption and the absence of great minds like K'ang Hsi and Yung Cheng and great artists like Tsang Ying-hsuan and T'ang Ying soon resulted in the ceramic production coming to an inglorious end. After the eighteenth century Ching-te Chen was like an orchestra without a leader.

(This is the last of a series of nine articles by Chingwah Lee, experimental potter and noted collector and appraiser of rare Chinese porcelain. His Studio in Chinatown, open to the public afternoons and evenings, is currently exhibiting loan specimens of rare ceramics from the collection of Robert L. Stevenson, Oliver Mills, Joe Yuey, and Jan Kleijkamp, and the House of Ming, and the trustees of the Parish-Watson Company.)

A Plea for The Burnham Plan

By **GEORGE S. HILL**

The Burnham Plan of San Francisco was made in 1905 by Edward H. Bennett and Willis Polk under the direction of Daniel H. Burnham.

They worked for an entire year on the plan. The report was being published at the time of the fire, and a large part of the edition was destroyed.

The plan had however been officially adopted

by the city, and following the disaster of 1906 a citizens' committee of forty was chosen to rehabilitate San Francisco. A sub-committee was formed, and made a report and plan of proposed street changes in the burned-over portions and other sections of the city. The changes recommended were those necessary to put the Burnham



solution has been found to be the extension of the Panhandle directly to Market Street.

"Any other working out of the problem presents greater difficulties and would give more round-about and consequently less dignified results. The Panhandle extension, involving a whole block in a direct line with the existing Panhandle, is bounded by Oak and Fell Street, whose grades as working roadways are to be left almost intact."

It is therefore interesting to note that although the purpose of rendering the park more accessible would no longer be considered of first importance, nevertheless, the project fits in most admirably with the present day concept of developing super-highways of adequate width as radials to outlying sections of cities. It is in line with recent planning for Chicago, Los Angeles, Detroit, and other metropolitan areas.

How well this project would fit into the street plan for San Francisco is seen by referring to the latest map of San Francisco issued by the California State Automobile Association, which shows the importance of Fell Street in spite of its steep grades, as a connecting link with Tenth Street and other parts of Route 101.

The obstacle heretofore to the extension of the Panhandle has been due to the great cost of the project as advocated in the Burnham Plan. The modification, shown in Figure 2, is therefore suggested in order to make the project practicable for the immediate future. At the same time it would not necessarily preclude the construction of a more costly project including full freeway development, if future conditions should justify that course.

It is proposed to construct the entire project as a parkway at the existing grades, except the four blocks between Pierce and Buchanan Streets, where a tunnel would replace the deep cut formerly proposed. This tunnel would be 2000 feet long and have a grade of 3½ per cent, which also would be the maximum grade on the entire route. It is suggested that this be first constructed as a 4-lane tunnel with provision for the addition of a similar 4-lane tunnel in the future.

With the exception of the tunnel the project would be located practically as described in the Burnham report as far as Franklin Street where it would merge into Fell Street, widened to 223 feet 9 inches to include Hickory Street and extended to Market Street, to connect with a widened Tenth Street.

The right of way contains few buildings of other than frame construction and these could doubtless be moved to other sites, as has been done in similar cases.

The project will be similar to the existing Panhandle, Funston Avenue, and Sunset Boulevard.

The Proper Timing Needed For Post-War Work

With proper timing, the huge total of \$4,870,000,000 in proposed post-war construction of public works on the part of the Federal, State, and local governments in California can be made to supplement private construction employment in the transition to peacetime economy, according to a report presented by the State Reconstruction and Re-employment Commission.

The report points out that of the total suggested post-war public works expenditure in this State, more than 70 per cent is still in the proposal stage; that in the local governmental group only 3.3 per cent of the proposed projects are financed; that the State has insufficient money in the Post-war Employment Reserve to finance its own urgently needed construction projects for institutions and highways.

The breakdown of the totals of proposed post-war public works projects compiled in the report is as follows:

Federal	\$1,536,000,000
State	951,000,000
County	719,000,000
City	1,443,000,000
Other local special projects	178,000,000

With respect to State projects, it is pointed out funds have been provided for less than 50 per cent of all needs other than highways and funds are available for less than 15 per cent of the State highway improvements urgently needed during the first three post-war years.

Colonel Alexander R. Heron, State Director of Reconstruction and Reemployment, emphasized the role of public works as a supplement to private building construction, when and as needed to help maintain a high level of employment.

"If private building revives on a large scale immediately after the war, public construction should be carefully timed to avoid rising costs and creating bottlenecks in the flow of materials, equipment and skilled labor to private work.

"Although private enterprise should have the right-of-way in post-war construction, some public works projects will give real impetus to private industry and such public works should be built as soon as possible," he said.

"It cannot be too strongly emphasized that proper timing is the essence of the State's entire building program—public and private."

Timothy Flueger's projects for 156 Dwelling Units in Vacaville and 44 in Fairfield have been let to contract for \$473,347.

W. P. Day, John Funk & D. P. Smith have planned 250 Dwelling Units of Pre-fab construction. The contract was let for \$494,543.

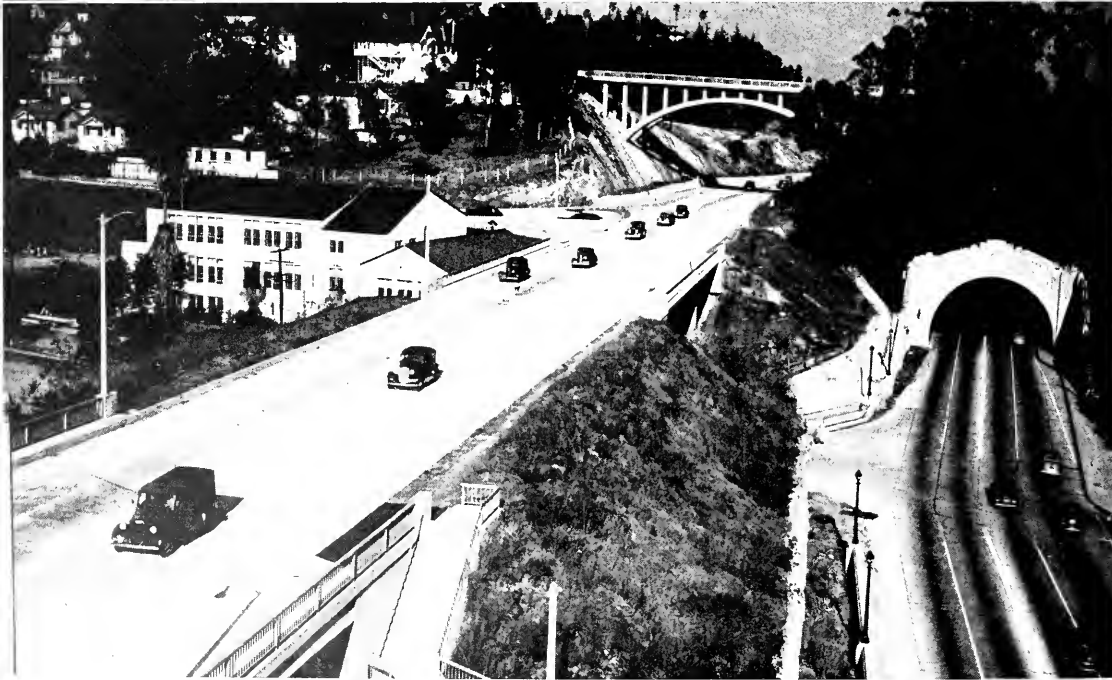

Top: Southbound traffic approaching Los Angeles on Arroyo Seco Extension and through open cut in Elysian Park. (Intersecting road at left. (Note famed City Hall in background.) **Bottom:** Southbound traffic passing under Park Boulevard, and northbound traffic entering park tunnel. (Photo courtesy Calif. Highways & Public Works.)

California Highways

Scientific Engineering Program of Long Range Planning - - -

By EDWIN H. WILDER

Long recognized as one of the first states in the nation to adopt an extensive public highways system embodying progressive engineering practices and long-range planning principles, California is today reaping the favorable economic benefit of many years of sound highway development.

Through the foresight of highway engineers, members of the California Highway Commission, public officials, and the people of California who

themselves so wisely provided by state constitutional amendment that certain tax monies shall be set aside and only allocated for bridge and highway purposes, a network of modern highways now serve every section of the State.

The constitutional directional use of money raised through taxation on the sale of gasoline and oil, and from motor vehicle license fees, for the specific purpose of construction of highways and bridges within the Primary and Secondary high-



MONTEREY-CASTROVILLE-PRUNEDALE project provides highway as shown looking southerly toward Marina on 4-lane, divided Portland cement concrete pavement. Road to left is Monterey Avenue to Salinas via East Garrison of Fort Ord. (Photo courtesy Calif. Highways & Public Works.)



BEAUTIFUL MODERN HIGHWAY BRIDGE at Russian Gulch State Park on State Route 1 in Mendocino county. (Photo Calif. Highways & Public Works.)

way system, and for the maintenance, improvement, realignment and reconstruction of these highways and bridges has enabled the state department of public works to view for many years the State's motor vehicle traffic needs on an overall basis and thereby adopt a carefully considered long-range program of construction.

With an assurance of certain basic funds being available the continuity of a statewide planned bridge and highway construction program has not been subject to extreme variations over a period of years due to changing state governors and corresponding changes in highway commission and administrative policies, nor have highway engineers and personnel, and department of public works officials been subject to so-called "political" pressure.

California's highway system has therefore had the advantage of non-political engineering planning and technical "security" in purpose and objective.

It is believed by many of those persons keenly interested in the future development of the State's highway system, as well as those closely allied to this department of the state government, that the establishment of the seven-man California Highway Commission, under the chairmanship of the director of the state department of public works, which was effected through the efforts of California's present Governor Earl Warren, will result in tremendous future advantage, in that post-war highways construction throughout the State will not only have the advantage of long-range engineer-

ing planning, but the State's vast highway system will also have the great value of sound economic planning and under such a coordinated program of highway construction California will retain its international prominence in the field of modern highway development.

Thus a proven, well functioning, and efficient engineering program will in future years have the added strength of an equally well analyzed and carefully projected long-range economic program for consideration in the planning and construction of highways and bridges.

While it is undeniably true that wartime rationing of gasoline, tires, and motor vehicle sales, have reduced highway revenues considerably and new highway construction has been greatly curtailed through inability to secure adequate materials and labor, the war has far from eliminated consideration of a vast bridge and highway construction program in the post-war era.

Despite many complicated problems confronting the California Highway Commission and highway department engineers during the past several years, from the standpoint of normal peacetime, or pre-war, operations, the State has met its obligations in maintaining California's highways in keeping with extensive Pacific Coast military and war industry activities.

The tremendous problem of converting peacetime California into a focal point for Army and Navy operations in the Pacific Theater of war; the acute traffic situations developing in concentrated was industry areas; and the need for an unre-

stricted flow of military and essential civilian vehicles from one center to another, has been successfully solved through the alertness and knowledge of California's highway engineers in cooperation with representatives of the Federal government.

Many essential highway improvements and much needed new construction in California's highway system has been effected during the war as part of the United States national highway's defense program.

Thus while reduced gasoline tax revenues, and other normal peacetime highway construction and maintenance income, has been considerably curtailed for the past several years, and wartime restrictions have prevented the possibility of a normal continuance of a peacetime highways program, actual progress in developing the State's highway system has continued during the war months on a "long-range" basis.

Almost as soon as the initial impact of the United States entering the war was met, the California Highway Commission, state department of public works officials, highway engineers, and state officials commenced working on and planning for post-war highways.

(See Next Page)



CZC

PRESSURE TREATED LUMBER

● PROTECTS AGAINST DECAY AND TERMITE ATTACK

Specify it in your home
Available through Lumber Dealers

LOS ANGELES 601 W. 5th Street Phone Michigan 6294	SAN FRANCISCO 333 Montgomery Street Phone DOuglas 3883
---	--

J. H. Baxter & Co.

AGENTS FOR WEST COAST WOOD PRESERVING CO., SEATTLE, WASH.



MATIC HIGHWAY CROSSING SIGNAL at intersection of East Shore Highway (left circle) between Oakland and Richmond. More than 45,000 vehicles per day are governed by this electric monitor. Note Highway Patrolman at right (in circle) governing flow of traffic. (Photo California Highways & Public Works.)

Substantial sums of money were set aside by the state government for after-war highways use. Similarly large amounts of money have been set aside by the Federal government for post-war highway uses in cooperation with state and county and city funds, so that there is before the state highway department today the most comprehensive program of highways construction ever known.

Vast construction of "freeways," "super-highways," bridges and realignment of present highway routes await but the coming of "Peace."

The plans are ready and the funds are ready.

Only an ample supply of materials and manpower is needed to effect in reality one of the most extensive and important portions of the world's greatest public highway systems.

Essential motor vehicle traffic today enjoys excellent highways extending into all parts of the state of California, but tomorrow's highway traveler, in addition to great post-war motor vehicle mechanical improvements and conveniences, will find California's highways unsurpassed in engineering design and constructed with a skill assuring the maximum in safety, comfort, and motor-pleasure.

California never has and never will stand still in scientific public highway construction.

IN THE NEWS

ELECTED CHAIRMAN OF BOARD

The Robert W. Hunt Company, Engineers, of Chicago, Illinois, announce the election of James C. Ogden, formerly President of the company, to the office of Chairman of the Board. The former Vice President, William L. Cooper, was elected to the office of President and Harold M. Morgan, former Chief Engineer, to the office of Vice President and Chief Engineer.

BULLET PROOF TIRE

A bullet proof tire, widely used in the Normandy campaign and throughout the European battle zone, has saved many lives and much time.

Manufactured in the United States and Great Britain, the tire is not actually bullet proof, but by reinforcing the walls, providing an inner rubber ring, and strengthening the beading, a flat tire can be run for 10 miles before it is completely ruined.

The secret of the British design is that when flat, the tire will carry the weight of the vehicle without slipping from side to side.

CENTER SAFETY BARRIER and DRAINAGE FEATURES combine to make the new 4-lane divided highway in the Grapevine Canyon one of the West's most modern highways' construction. (Photo courtesy Calif. Highways & Public Works.)



PREFABRICATED HOSPITALS

Prefabricated housing, furnished by the Chief of Engineers in packaged form, is supplying hospital space for a large portion of American wounded in Southwest Pacific operations. Originally designed as barracks, these units lend themselves perfectly to hospital purposes, each barracks becoming a ward.

With bulldozers and other heavy Engineer equipment to clear the site, a new hospital is only a question of days. Because they are separate units, the pattern of a hospital can be arranged to fit the site or any size necessary.

The standard designs are grouped in three classes, metal, precut, and wood, in two types of each design, tropical and insulated. The tropical design embodies continuous windows, ventilators at the base of the sidewalls and eave overhang to carry off tropical rains. The insulated type has a minimum of windows, gable or ridge ventilators and an interior lining of insulation.

Confer, Ponsford & Barovetto, Architects, have been selected to plan 110 Dwelling Units for Project California No. 4032 N. to be built in Berkeley, California.

APPOINTS DISTRIBUTORS

The Utility Appliance Corporation of Los Angeles, manufacturer of heating, cooling, and air-moving equipment and household appliances, has announced the appointment of Higgins Industries, Inc., as distributors of the complete Utility line for Louisiana, south central Mississippi, and southern Alabama.

The F. C. Stearns Company of Hot Springs National Park, Arkansas, has also been appointed distributor of Utility products for Arkansas.

Joseph Losekann, architect, has moved his offices from 311 E. Market Street, Stockton, California, to room 206 Elks Building in the same city. His new telephone number is 2-0245.

VARIATION IN DOOR DESIGN

Although its basic principle of operation is similar to the various rolling or upward opening types of door manufactured by the Kinnear Mfg. Company of Columbus, Ohio, an interesting variation in door design is found in the airtight vertical lift door recently developed and built for Wright Field, Dayton, Ohio.

The new door is spring counterbalanced and motor operated, while air operated rubber sealing tubes are controlled by valves working in conjunction with the motor operating mechanism by push button control.



TREES

"THAT time of year thou may'st in me behold,
When yellow leaves, or none, or few, do hang
Upon those boughs which shake against the
cold,—
Bare ruin'd choirs where late the sweet birds
sang."

—Shakespeare.

GLASS BASE PLASTIC

Made in sheets and known technically as glass melamine laminate, a glass base plastic is now being made by The Formica Insulation Co. of Cincinnati, Ohio.

Resistant to flame and arcing it is made from a fine weave, continuous filament fiber-glass fabric with melamine thermostetting resin and is available in sheets, tubes and rods.

FIRE-RESISTANT PLASTIC

To meet the stresses and strains of battle action calling for a fire-resistant, non-toxic, plastic, a new product has been perfected for the U. S. Navy by the General Electric Company, New York City.

Containing good electrical properties, high impact strength and easy moldability, asbestos fibers were bound together with certain phenolic resins to make the plastic.

IN THE NEWS

REDWOODS FOR MEMORIAL

More than 5,000 acres have been set aside by the California State Park Commission as a tribute to the service men and women of this great war. It is to be known as the National Tribute Grove and is located about five miles north of Crescent City in Del Norte County, California.

The purchase agreement calls for \$250,000 in addition to the \$250,000 that has already been subscribed. The grove is accessible by State Route 1 and a scenic park road direct from Crescent City.

ETHYL FROM SAWDUST

Construction of America's first commercial plant for the production of ethyl alcohol from sawdust is nearing completion in Springfield, Oregon. The project occupies about 14 acres and will cost in the neighborhood of two and one-half million dollars. Perhaps the completion of this plant will give the distillers of grain alcohol a better chance to produce something more potable.

MAXIMUM RUBBER PRODUCTION

In order to encourage maximum rubber production in Ceylon, where tapping the trees so extensively that they die from a complete loss of vitality within two years, the British Government reimburses planters up to \$180 per acre for replanting.

Under the plan it is estimated more than 36,000 acres have been given over to new plantings.

Navy funds amounting to \$2,527,100 have been allotted for additional Naval facilities in the Northern California Area.

A low bid of \$939,365 has been received for the general contract of paving, drainage and lighting of the Mills Field in San Mateo County. The low bidders were Macco Construction Co and Morrison & Knudson of Oakland, California.

CHANGE OF ADDRESS

The General Air Conditioning & Heating Company, Northern California Distributors for General Electric, announces the change of their Oakland office to 2001 Peralta Street, Oakland 7, California, where their telephone will now be TWinoaks 4066.



UTILITY
Appliance Corp.
Air Cooling, Ventilating and
Gas-Fired Heating Equipment



FLOOR FURNACES



FORCED AIR FURNACES



FORCED AIR UNIT HEATERS



DUAL OUTLET FLOOR FURNACES

You are invited to investigate the complete line of Utility evaporative air coolers, centrifugal blowers, propeller fans, floor furnaces, circulating heaters, unit heaters and forced air furnaces. Catalogs and illustrated literature will show you the outstanding features of these truly modern appliances.

Utility coolers, blowers and fans are now available under WPB regulations and priorities. Heating equipment will be available when war restrictions are lifted to permit manufacture.

EVAPORATIVE AIR COOLERS

UTILITY Appliance Corp.

Formerly Utility Fan Corporation

4851 S. ALAMEDA STREET • LOS ANGELES 11, CALIFORNIA

ARCHITECT AND ENGINEER

IN THE NEWS

FAMILY DWELLING UNIT CONTRACTS LET

The contract for Project Calif. No. 4138 by Merchant, Sharp & Starks, has been awarded to Erbenbraut & Summers for \$198,000.

APPOINTED DISTRICT MANAGER



Samuel W. Murray

Samuel W. Murray has been appointed district manager of the Pacific Coast territory for the Celanese Plastics Corporation.

Headquarters of the territory served by Mr. Murray is located at 19 Santee Street, Los Angeles.

FREDERICK L. ROHRIG has moved from 339 West Palm Avenue, Monrovia, to Route 1, Box 396, Walnut Creek.

HOME SURVEY

The Masonite Corporation has made a survey of Home Building requirements for the first post-war decade.

It shows home builders will spend \$4,000 to \$10,000 on their houses. On a basis of \$6,000 per home the estimated ten million homes for the first decade will run into 60 billion dollars, exclusive of new hotel or apartment construction. This is a partial answer to the question of jobs available.

VIRGIL OWEN PRINCE has moved from 1650 West 83rd Street, Los Angeles, to Suite 14, 808 South Vermont Avenue, Los Angeles.

HOW TO CHOOSE A HEATING SYSTEM

"How to Choose a Heating System for Your New Home" is the subject of a new 16-page booklet issued by A. M. Byers Company, 45 Clark Building, Pittsburg, Pa.

Pictures and layouts of representative homes and comments by their owners on radiant-heating installations is included, as is an analysis of construction costs.

ROOF COATING QUESTIONS ANSWERED

A 12-page illustrated pocket size booklet has just been issued by the Building Products Division of L. Sonneborn Sons, Inc., New York, which is intended as a buyer's guide to the selection of a roof coating that will meet exacting standards of protection, durability, service and economy.

Ingredients of roof coatings, their functions, and their meaning from the buyer's standpoint are explained in non-technical terms.

ADEQUATE WIRING

— is —

SOUND BUSINESS

Whether you are planning new homes or remodeling old ones, the specification of complete adequate wiring is sound business for architects . . . and their clients.

Since 1928, the average annual home consumption of electricity has jumped from 460 to approximately 1,100 kilowatt hours. After wartime restrictions are removed, demands for electrical service in the home will increase enormously . . . and wiring must be adequate to carry the load, satisfactorily, for many years ahead.

Home financing institutions recognize that a poorly wired home is not as good a long range risk as a home with complete and adequate wiring, for wiring facilities should be a selling feature, not a handicap.

Thus adequate wiring offers benefits far beyond its cost, and the architect who specifies it for all the postwar homes he designs is sure of satisfied clients.



NORTHERN CALIFORNIA
ELECTRICAL BUREAU

1355 Market Street
San Francisco 3



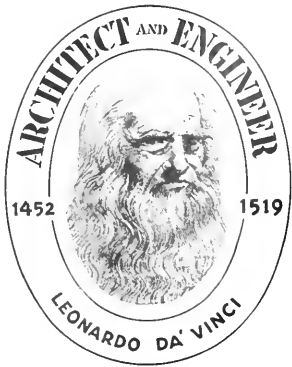

LEONARDO DA VINCI

In his "BOOK OF PAINTING," Leonardo wrote, "For portraits thou shouldst have a special studio—a court, like an oblong quadrangle, ten ells wide, twenty long; the walls should be painted black, with a sheltering projection along the walls, and a canvas awning, the latter arranged so that folding or unfolding, as required, it may serve as protection from the sun."

HOUSING AGAIN!

(Continued from Page 20)

vestment safeguarded and unnecessary costs eliminated.

This is a very complicated problem. It is essentially one of removing the disparity between the low, inadequate incomes of individual families on the one side and on the other, the disproportionate expense of home ownership due to the highly inflated cost of land, high construction and interest charges, and taxes; or in the case of tenancy the high rates due to these same causes.

The task of increasing the family income raises problems that are intrinsically and indissolubly bound up with the whole national economy. Land costs are out of all proportion to its use as residential sites. Construction costs are high often because of legal controls such as zoning ordinances and building codes, many of which need revision. Restrictive price agreements may also cause construction costs to be higher than they should be. These are often only suspected to exist and are difficult to detect. Construction costs are sometimes high because of special arbitrary and unreasonable labor union requirements. These should be revised and pre-assembly may accomplish some reduction of costs. Interest rates and tax rates are in urgent need of revision.

Attempts, not all successful, are being made in each of these phases of the problem to effect improvement as the direct solution. How each of these parts of the problem should be treated I do not know. Those who face realistically the work-

ings of our traditional form of private enterprise, as it is generally carried on, are prepared to expect little result from these attempts.

Several alternative methods of solution are proposed. Some favor a large public housing program which will clean out slums and rehouse the slum dwellers with Federal and local subsidy for construction and operation. Others want no public housing but want municipalities to condemn slum properties at the present high values set by their owners, clear and resell at the lower use values to private operators who will construct homes to be sold in the usual way or to be rented to the underprivileged at reasonably profitable rents made payable by financial assistance to the tenants in the form of a governmental subsidy. Others want extensive repair and alteration of existing structures for use by the underprivileged. This would also involve public subsidy.

Some builders and developers who oppose subsidies forget that most of their own housing developments are largely dependent on provision of sewers, water, light, and other utility and public service installations at the expense of utility companies or of the public.

The objectives of a sound program should be to house all Americans at fair prices and decently, but not necessarily all of them in new houses. It should have the secondary purpose of providing employment through the construction industry's normal activities.

Those who have studied the situation are of the opinion that the architectural profession currently favors that the principal burden of providing this housing be born by private enterprise backed by local public effort. Federal funds for construction and Federal direction should be called in only when and where it is conclusively shown that this combination cannot attain the proper ends. Generally Federal direction should be limited to advice and the minimum control necessary to prevent waste.

This general progress as sketchily outlined is provocative of thought and should encourage profitable development and amplification.

For those who would like a better acquaintance with this subject a supplementary reading list is given:

Rehousing Urban America, Henry Wright; **Housing America**, the Editors of *Fortune*; **The Culture of Cities**, Lewis Mumford; **American Housing Problems and Prospects**, Twentieth Century Fund; **Housing the Masses**, Carol Aronovici; **A Citizen's Guide to Public Housing**, Catherine Bauer; **Modern Housing**, Catherine Bauer; **Slums and Blighted Areas in the United States**, Edith Elmer Wood; and **Los Angeles—Its People and Its Houses**, Earl Hanson and Paul Beckett. The Haynes Foundation.

THE A.I.A. IN THE NORTHWEST

The resumption of the monthly bulletin of the Washington State Chapter of the A.I.A. is most welcome. It is more than a bulletin, it is really a report, for it occupies six pages of single spaced type and tells more about the activities of the Washington State, Tacoma and the Western Mountain district chapters of the A.I.A. than one is apt to find in print anywhere else.

The most important matter taken up by the Washington Chapter at their 493rd chapter meeting in Seattle was a lengthy consideration of the SMALL HOUSE PROBLEM.

The chapter's DOMESTIC ARCHITECTURE COMMITTEE arrived at the conclusion that the small house problem involved stock plans and that the architects were obligated to not only take part in this program but also to find some means of handling small jobs involving work not to exceed \$5,000 yet requiring the services of an architect. Also, "that a small house clinic be formed sponsored and financed by the Institute—and a drafting force comprised of young draftsmen. All offices who so desired could still handle these small jobs, but in cases of those who were finding them an encumbrance, it would afford an ideal solution." The committee further decided "that the sale of such stock plans be \$50.00 and include eight sets of blueprints, seven sets of specifications, and a bill of materials." The plan was explained in considerable detail in the bulletin including information on the Stock Plan Bureau idea. There was also a brief report from the Tacoma Chapter in which was given the information that should be generally known, to the effect that the Gold Medal of the American Institute of Architects awarded to the best General Architectural Achievement of a member of the graduating class in an accredited School of Architecture has recently been awarded at the University of Washington to Miss May Lund of this year's graduating class.



The Fight Moves West *Let's All Invest!*

Make your quota
in the 7th biggest
of all . . . Seven Billion
dollars the goal . . . Four
Billion in E Bonds alone.

The Treasury Department acknowledges with appreciation the publication of this message by

WESIX ELECTRIC HEATER COMPANY

390 FIRST STREET

San Francisco, Calif.

WITH THE ENGINEERS

PLENTY OF ACTION SEEN BY 246th ENGINEER COMBAT BATTALION

Foreign service for the 246th Engineer Combat Battalion started on 19 January 1944 in England, where the Battalion completed an extensive training prior to landing with the first troops of XIX Corps on the Normandy coast of France five days after D-day.

The first taste under combat conditions came when the Battalion constructed two Bailey Bridges in face of enemy fire to aid the 30th Infantry Division's drive toward the Vire Canal.

During the swift drive through France, the battalion constructed bridges, repaired roads, cleared minefields, fought, and finally entered Belgium, marking the route for XIX Corps troops. Here, with the support of two assault tanks of the 113 Cavalry Group, the battalion held the line along the Albert Canal for nine days.

All told, from June 1944 to December 1944, the 246th Engineer Combat Battalion constructed 3,000 feet of Class 40 and 70 bridges, and received official credit for blowing 150 pillboxes on three different sectors of the Siegfried Line.

A committee of the American Society of Civil Engineers, headed by Malcolm Pirnie, chairman, has at last been called in by the C. E. D. to get action on the monumental job of post war construction and jobs for everyone. Mr. Pirnie pointed out that it usually takes twice as long to get ready for a construction job as it does to build it and that there is a shockingly small amount of construction now ready for bids.

With the help of the A.S.C.E. Committee to help them the C.E.D. committee has estimated that the normal construction value after victory should be about 15 billion annually, plus 5 billion for repairs and maintenance. To substantiate these figures by actual field surveys the C.E.D. is sending out check sheets to 2800 offices in as many areas, in which work the C.E.D. will be assisted by the advisory committee of the A.S.C.E.

Already projects are taking on a renewed activity. True, many of the reports of contracts for large engineering tasks that have been awarded, were advertised before V-E day, but they swell the inevitable great volume of engineering work that will all but swamp the engineers of the West Coast when we get down to a one way basis.

Two examples, out of many, are the lengthening of the marginal wharf at Rough and Ready Island for which the contract was awarded to MacDonald & Kahn; George Pollock & Tiechert for \$1,814,345 and the bid of Gerwick, Morrison & Knudsen & Traits of \$1,146,254 for concrete, mechanical and electrical work at the Hunters Point Dry docks.

Also it should be recorded that the City of Oakland has voted favorably on bonds for \$15,754,500, over \$10,000,000 of which is for engineering construction.

PREFABRICATED HOUSES IN THE U.S.S.R.

According to the U.S.S.R. Embassy Bulletin, prefabricated houses have come to stay in the U.S.S.R.

The one that seems to meet with the most favor is the Pavlov House, so named after the designer, Mr. V. J. Pavlov, although manufacturers in the United States have become very active in Russia during the past few months.

Many Pavlov houses have been built in Stalingrad, Moscow, Kiev, Smolensk and other large cities in the Soviet since the Nazis wrecked those places, and in one city a considerable stir was raised over the building of a three-room house of this type of prefabricated construction in thirty hours. The cost was 27,000 rubles, or about \$5,000, if you can get any sort of a firm figure of the value of a ruble.

The main material of which this house is built is wood and it covers an area of 969 square feet with a total cubic content of 11,225 cubic feet, at a cost of 44 cents per cubic foot or \$5.00 per square foot, if you figure the ruble at 20 cents. It took 40 men, including 12 carpenters, two bricklayers, two electricians, two plumbers and three painters thirty hours to complete the house after the first sod had been lifted for the foundation.

Pavlov houses are going up by the hundreds in the devastated war zones, which probably inspired the prefabricated house manufacturers in the U. S. to open the show of their wares at the Moscow Architects Club. Anyhow, there is a great field for "Pre-fabs" in the Soviet and America will have to supply a large proportion of them if the demand is to be met.

FIRE SAFE SCHOOL AUDITORIUM CURTAIN

The first school auditorium stage in the United States to have fire-safe Fiberglas curtain and back-drop is the auditorium stage of the Von Steuben high school of Chicago.

Stirred by potentially tragic effects of school auditorium fires, jade green curtains and back-drop woven of incombustible glass yarns were recently installed.

Post-war homes will probably utilize similar installations to reduce fire hazards.

A. I. A. ACTIVITIES



Mr. Chas. H. Alden, F.A.I.A., has returned to his work of editing the Washington State Chapter's Monthly Bulletin after vacationing several months in California. Unfortunately, for him, he was unable to stay in San Francisco long enough to see the United Nations' Conference get into full swing.

The Bay Bulletin announces that Tacoma's Home Planning Institute has begun in actuality with several hundred attendance at their first meeting. They also state that a lot of small buildings are done there in concrete units as a result of the restrictions on lumber. It is to be hoped they will keep it up after the restrictions have been lifted.

The April Bulletin of the Northern California Chapter dwells at some length on the reports of the Building Industries Conference Board. To quote the bulletin it says, in part, on Authorized Housing Construction:

"The War Production Board, through the Na-

tional Housing Agency, authorizes construction at the present time (March, 1945) under three programs, designated H-1, H-2, H-3.

"Programs H-1, housing for immigrant war workers, and H-2, housing in congested war areas, are limited to specific quotas granted for districts where need is demonstrated. This housing is built for rent or sale, subject to limited maximum prices.

"Program H-3 is authorized, without limits of location or occupation, for cases of "Individual Hardship" and for Veterans of World War II. Eligible hardships include evictions, increase in dependents or consolidation of a family, or considerations of health, physical disability, or safety; and replacement of structures destroyed, damaged or condemned. These conditions must be clearly indicated and subject to demonstration, and the inability to secure adequate housing must be shown. Housing so authorized is for occupation only, by the individual owner.

"All cases are subject to current limitations and availability of materials. The main limitation at present is in the amount of lumber permitted. Authority to construct, as indicated by Preference Rating Order P-55-c, carries with it authority to purchase new lumber up to prescribed limits, and a reasonable amount of 'used' lumber.



ARCHITECT, Gerard Colcord
BUILDER, Wm. C. Warmington

PAYNE ZONE-CONDITIONING
Successor to old-fashioned central heating. Circulated winter warmth, summer ventilation . . . controlled by zones or rooms. Write for new booklet.

Design for Living

Lifetime comfort is assured by PAYNE gas-fired warm air heating . . . choice of tens of thousands of discriminating home owners, coast to coast.

PAYNE
FURNACE COMPANY
(One of the Dresser Industries)
BEVERLY HILLS, CALIFORNIA

PAYNEHEAT
OVER 30 YEARS OF LEADERSHIP

GAS FUEL
(HAS)
EVERYTHING

*Be sure you're getting the
finest window glass obtainable*

it costs no more to specify

PENNUERNON

Distributed by...

W·P·FULLER & CO.
PAINTS • GLASS • WALLPAPER

it's
FLATTER
... CLEARER
... BRIGHTER ...

PENNUERNON
flat drawn
WINDOW GLASS

"In addition, 200 board feet of dimension lumber is permitted for garage roof construction. Garage walls may be of masonry, used lumber, or any other material than new lumber.

"The use of board lumber is prohibited for sheathing walls, ceilings, or flat roofs (pitch less than 3 inches in 12 inches). Wood roof shingles are prohibited where composition or asbestos shingles are obtainable.

"Since the normal frame one-story house on a flat site requires approximately 5 board feet of dimension lumber per square foot of living area, it will be seen that a 3-bedroom house, for example, may include from 1200 to 1300 square feet of living area, if constructed with new lumber throughout. Economical planning and use of materials to conserve lumber may permit larger dwellings. The allowance of lumber for 4 bedrooms is the maximum for any dwelling. The use of other materials is much liberalized by the current critical list, obtainable at FHA offices. Electrical installations may be up to the minimum requirements of the 1940 National Electric Code. Plumbing materials are still limited in size to the Emergency Plumbing Standards, but installations are not now limited to a single stack, so that concentration of fixtures is no longer necessary. The number of bathrooms should be consistent with number and location of bedrooms."

NEW FOREST INDUSTRIES BOOKLET

"The Forest Industries Blaze New Trails" is the subject of a brochure just issued by the Timber Engineering Company.

Prepared by the Wood Products Development and Wood Derivative Chemistry facilities of the Timber Engineering Company, the booklet is designed for the information of executives, plant superintendents, chemical engineers, structural engineers and others in the woodworking, wood chemistry and building industries.

"Post-war plans of many industrial plants call for improved and new uses of wood in many forms," declared Harry Q. Uhl, president, Timber Engineering Company, in announcing the brochure.

Copies of the material may be secured from the general offices of the Company at 1319 Eighteenth Street, N. W., Washington 6, D. C.

MAX MALTZMAN moved from Box 8318 West Adams Station, Los Angeles, to 1906 Scott Road, Burbank.

ARTHUR E. MANN moved from 229 Marine Place, Manhattan Beach, to 311 South Gramercy Place, Los Angeles.



QUALITY AND DEPENDABLE *Service*

are the factors that influence architects and contractors when selecting lumber and mill work — Quality of merchandise — Integrity and Ability of the firm — Service in physical equipment — Experience and Personnel — All these factors contribute to a speedy and satisfactory completion of construction with minimum of time and expense.

MANUFACTURER OR DEALER IN

Douglas Fir — Redwood — Sugar and Ponderosa Pine — Plywood and Concrete Form Panels — Sash and Doors — Millwork — Insulation — Builders' Hardware.

E. K. WOOD LUMBER CO.

"Goods of the Woods" ©
LOS ANGELES • SAN FRANCISCO • OAKLAND

IN THE NEWS

PAYNE SERVICE CLUB BANQUET

The annual Service Club banquet for employees of Payne Furnace Company was held in Beverly Hills recently. Jimmy Gleason, star of stage and screen, as master of ceremonies, told the group that the combined membership of the Service Club now represented more than one thousand years of experience with the Company.

E. L. Payne, president of the Company, extended a greeting to the new club members and reported 133 employees serving with the armed forces.

The recent merger of Payne Furnace Company with Dresser Industries, Inc., Cleveland, Ohio, was the subject of a talk given by Lyle C. Harvey, vice-president and director of Dresser. Harvey stated, "Payne Furnace Company will continue to be run as a separate company and will lose none of its individuality by joining Dresser."

LEWERS & COOKE EXPANDING. Building materials supply houses in Honolulu have also joined the group who are preparing for the increased activities that are sure to result from the victory in Europe and the anticipated crushing of Japan. Here in the United States the dealers do not seem yet to have awakened to the possibilities of the rush to come.

Lewers & Cooke, an old and established firm of ninety years standing, are desirous of enlarging their field by handling, in addition to their standard lumber and building materials, a more extensive line of general hardware, floor coverings, tools, implements and plumbing supplies on a wholesale basis. Their desire to hear from producers who are seeking a responsible agent in the Islands is another sign of the growing realization that there is a flood of business in the offing.

PENDING PEACE

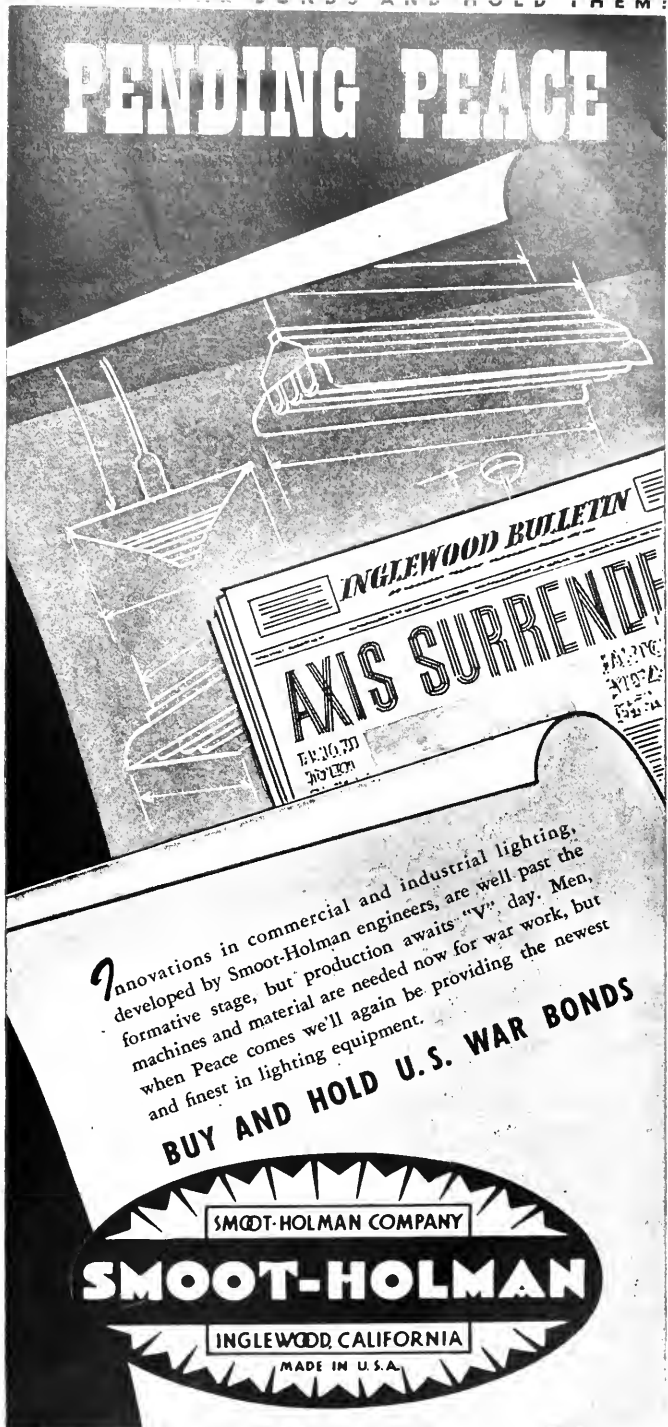

Innovations in commercial and industrial lighting, developed by Smoot-Holman engineers, are well past the formative stage, but production awaits "V" day. Men, machines and material are needed now for war work, but when Peace comes we'll again be providing the newest and finest in lighting equipment.

BUY AND HOLD U.S. WAR BONDS

SMOOT-HOLMAN COMPANY

SMOOT-HOLMAN

INGLEWOOD, CALIFORNIA

MADE IN U.S.A.

Offices in Principal Western Cities—Branch and Warehouse in San Francisco

PRODUCERS' COUNCIL PAGE

Northern California Chapter

The National Organization of Manufacturers of Quality Building Materials and Equipment

Affiliated with the AMERICAN INSTITUTE OF ARCHITECTS



CLARENCE E. BERRY

Clarence says his is no "Horatio Alger" story, but as District Sales Manager, covering seven Western States, he is certainly putting Mueller Brass Co. on the Western map. And after digging the story out of him, we learn that he started with his company 23 years ago at Port Huron, Michigan, as a clerk in the Order Department, steadily climbing up the ladder, rung by rung, as Office Manager, head of the Time Study Department, Sales Correspondent and then Manager of the Streamline Pipe & Fittings Division of the Company before moving on to his present job four years ago.

Clarence first saw the light of day in Ansonia, Pennsylvania, attended the Pennsylvania Business College at Lancaster.

Clarence and the Mrs. have celebrated their thirty-fourth wedding anniversary, have two daughters and a son, all married, and three grand children.

Son has just returned from thirty-four bombardments in the Southwest Pacific but give Dad the good old U. S. A. for his sightseeing. And that's Clarence's hobby. He has traveled every state in the Union in the interest of "Streamline" products and is still anxious to see more.

Larry Hart of Johns-Manville Sales Corp. was elected President of The Producers' Council, Inc., at the abbreviated annual meeting held in Atlantic City in conjunction with the annual meeting of the A. I. A., April 24 and 25.

Latest Development on the new "Base Bid" procedure is the acceptance by the Heating, Piping

and Air Conditioning Contractors National Association, of this principle in calling for quotations. Elimination of the "Or Equal" clause they hold cuts out one big guess from the "guessing game" of estimating and quoting a job without in any way preventing the use of alternate bids. "It puts the discussion of what will or will not be approved where it belongs . . . before the acceptance of the bid . . . not afterwards."

"A Scotchman Looks at Modular Coordination" is the title of a slide film sensation featuring talks made on modular coordination in eight Eastern cities by A. Gordon Lorimer, soon to be available for showing elsewhere. We regret that it couldn't be a talking picture. Mr. Lorimer's delightful burr is so thick you could cut it with the proverbial knife. Chief of the Bureau of Architecture of the City of New York, Mr. Lorimer knows whereof he speaks, having designed millions of dollars worth of modular coordinated buildings. So interested is he in the subject that he used his vacation time to make the tour under the sponsorship of The Producers' Council.

The Story of Modular Coordination was carried to Denver by Director Chuck Kraft on his return from Atlantic City, in a meeting with the Council Chapter there and their Architect guests, April 30.

V-E Day lends fresh emphasis to the necessity of all of us seeing to it that plans are ready for the release of materials. This may not come soon in volume,—but let's be ready!



USE QUALITY PRODUCTS



CONSULT AN ARCHITECT

BOOK REVIEWS

BUILDING INSULATION, by Paul D. Close. Publ. by American Technical Society, 2nd edition, 1945; 318 pages, \$3.50.

BUILDING INSULATION is among the technical textbooks of which many architects, builders, heating engineers, as well as schools will make a good use. Its author, Mr. P. D. Close, member of the American Society of Heating and Ventilating Engineers, has presented this complex—sometimes mysterious—subject in a comprehensive form.

Right at the beginning he wins the gratitude of the reader by classifying for him all of the 217 commercial insulating materials into 6 groups: (1) Flexible insulations, such as Cabot's Quilt or Kimsul; (2) Loose Fills which are supplied in granulated, powdered, cellular and fibrous wool forms, such as the Unifill or Palco Wool; (3) Bats and Pads of mineral wools, packed into water-and-fireproof paper; (4) Slabs of various sizes and thicknesses, usually containing processed cork: Porex, Thermax, and others; (5) Insulation boards which for their tensile strength and rigidity are used as structural members; again he presents and analyzes a number of products, Celotex, Insulite, and (6) Reflective insulation material composed of aluminum and steel foils.

The following chapter then is devoted to the various applications of these materials, and is illustrated by numerous drawings and reference tables. Although this is an exhaustive study, I miss in it mention of the use of insulation materials of modern airplanes, railroad cars and busses: for there, I feel, is a lesson for designers and insulating experts of the post-war fabricated houses. However, perhaps Mr. Close deemed it advisable to concentrate on the prewar everyday practice.

An enlightening discussion on "What is Heat" is embodied in the fourth chapter. There, Mr. Close explains conduction, convection, and radiation, the three main factors of heat transfer. He gives the reader a scientific analyses of heat and heating, from the B.T.U. up to the latest molecular theory of heat conductivity. An in the following two chapters the author backs up his analyses with a number of tables, illustration, and mathematical formulæ for computing heat losses, fuel efficiencies, condensation, economics of insulation, and other important factors for heating and ventilating.

A whole chapter is devoted to sound insulation and sound transmission; again, a number of practical examples and illustrations are brought in,

including the sound-and-vibration insulation for heavy machinery. Mr. Close concludes his book with a series of questions relative to each of the 18 chapters, which may indicate that the book is also meant as a school textbook, which it well could and should be. Jan Reiner.

WESTERN AIR DEVICES DAMPER QUADRANT

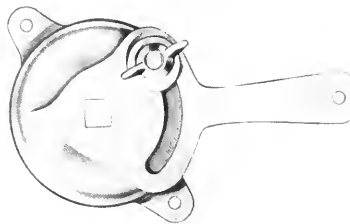

A new damper quadrant, designed in a modern pattern for light industry and dwellings, has just been placed on the market by the Western Air Devices, Inc., 1349 Vernon Avenue, Los Angeles.

The device comes in one-quarter and three-eighth inch sizes, and is attractively plated with rust resisting cadmium.

Features claimed for the product are ease of installation, dependability of operation and ruggedness of construction. The product is available for immediate shipment, free sample and descriptive material will be sent on request.

FROZEN FOOD DEPOT

Christensen & Lyons, Industrial Engineers, have just completed construction of a frozen food storage and distributing plant in Oakland for Frozen Food Distributors, Inc. . . . the building and equipment have been pronounced by experts outstanding in studied design and service facilities.

CHRISTENSEN & LYONS

GENERAL CONTRACTORS

Specializing in Industrial Buildings

3454 Harlan Street, Oakland, California

Telephone OLYmpic 5426

IN THE NEWS

BIG NEWS IN LACQUER

Listing important factors responsible for development of new high solids lacquers, the advantage of using them, and a short history of the development of lacquer as a protective coating, an 8-page pamphlet has just been issued by the Hercules Powder Company, Wilmington, Delaware.

GUY L. ROSEBROOK has moved from 1053 Monterey Avenue, Berkeley, to 1300 Glen Drive, San Leandro.

GUTH GERMICIDAL FIXTURE

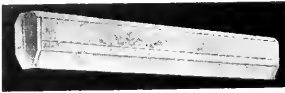

This new "Barrier Germ Killing Light" is equipped with a highly concentrating ALZAK reflector and can be arranged to curtain off an entire area against germs.

Offices, and rooms in the home can be curtailed against outside germs, or the ultra violet beam can be directed on exposed food, milk bottles, cosmetics, and other equipment with the same effect.

W. L. SCHMOLLE has moved from 2030 Wilshire Boulevard, Los Angeles, to 2217 Camden Avenue, Los Angeles.

(From Page 13)

The Company now has 16 employees and operates a fleet of 9 trucks serving retail stores, restaurants, hotels, hospitals, commissaries, etc., in the entire San Francisco Bay Area.

Frozen foods is one of the fastest growing industries in the country today and the post-war promises some heavy construction, such as packing plants, cold storage buildings, distributing depots and locker plants, all necessary to take care of the industry's needs. Today the industry is composed of 500 frozen food processors of fruits, vegetables, seafoods, meats and poultry. It is estimated that in three years there will be 3,000 freezing plants. Some idea of the growth of the industry may be had from the statement that in 1937, 150 million pounds of fruit and vegetables were frozen. Last year the total was 600 million with 700 million pounds estimated for this year. The industry packed 125 million pounds of frozen vegetables for the Army in 1943-44.

CLINTON CONSTRUCTION CO. OF CALIFORNIA

General Contractors

923 FOLSOM STREET • SAN FRANCISCO

SUtter 3440

MALOTT & PETERSON

ROOFING AND FLOORING
CONTRACTORS

20TH AND HARRISON STREETS

SAN FRANCISCO

Phone ATwater 1600

HOGAN LUMBER CO.

Wholesale and Retail

LUMBER

MILL WORK • SASH & DOORS

Office, Mill, Yard and Docks

SECOND AND ALICE STREETS • OAKLAND, CALIF.

Telephone GLencourt 6861

FAZIO PLUMBING

in Storage and Distributing Plant

for Frozen Food Distributors, Inc.,

Oakland, California.

J. A. FAZIO

686 Fourth Street, Oakland

Telephone HIgate 4685

ARCHITECT AND ENGINEER

Estimator's Guide

Giving Cost of Building Materials, Etc.

AMOUNTS GIVEN ARE FIGURING PRICES AND ARE MADE UP FROM AVERAGE QUOTATIONS FURNISHED BY MATERIAL HOUSES TO SAN FRANCISCO CONTRACTORS. 2½% SALES TAX ON ALL MATERIALS BUT NOT LABOR

All prices and wages quoted are for San Francisco and the Bay District. There may be slight fluctuation of prices in the interior and southern part of the state. Freight cartage, at least, must be added in figuring country work.

BONDS—Performance—50% of contract.
Labor and materials—50% of contract.

BRICKWORK—

Common Brick—Per 1M laid—\$50.00 to \$60.00 (according to class of work).

Face Brick—Per 1M laid—\$120 to \$150 (according to class of work.)

Brick Steps—\$1.60 per lin. ft.

Brick Veneer on Frame Bldg.—Approx. \$1.30 per sq. ft.

Common Brick—\$19.00 per M, truckload lots, f.o.b. job.

\$19.00 per M, less than truckload, plus cartage.

Face Brick—\$40 to \$80 per M, truckload lots, delivered.

Cartage—Approx. \$4.00 per M.

BUILDING PAPER—

1 ply per 1000 ft. roll.....	\$3.50
2 ply per 1000 ft. roll.....	5.00
3 ply per 1000 ft. roll.....	6.25
Brownskin, Standard, 500 ft. roll.....	5.00
Sisalcraft, 500 ft. roll.....	5.00
Sash cord com. No. 7.....	\$1.20 per 100 ft.
Sash cord com. No. 8.....	1.50 per 100 ft.
Sash cord spot No. 7.....	1.90 per 100 ft.
Sash cord spot No. 8.....	2.25 per 100 ft.
Sash weights, cast iron, \$50.00 ton.	
Nails, \$3.42 base.	
Sash weights, \$45.00 per ton.	

CONCRETE AGGREGATES—

The following prices net to Contractors unless otherwise shown.

Gravel, all sizes—		
\$1.95 per ton at Bunker; delivered	\$2.50	
	Bunker	Del'd
Top Sand	\$1.90	\$2.50
Concrete Mix	1.90	2.45
Crushed Rock, ¼" to ¾".....	1.90	2.50

Crushed Rock, ¾" to 1½".....	1.90	2.50
Roofing Gravel.....	2.25	2.80
River Sand.....	2.00	2.45

Sand—

River Sand.....	2.00	2.45
Lapis (Nos. 2 & 4).....	2.85	3.15
Olympia (Nos. 1 & 2).....	2.85	3.10
Del Monte White.....	84c per sack	

Cement—

Common (all brands, paper sacks), carload lots, \$2.42 per bbl. f.o.b. car; delivered \$2.72. Cash discount on carload lots, 10c a bbl., 10th Prox.; less than carload lots \$3.20 per bbl. f.o.b. warehouse or delivered.

Cash discount 2% on L.C.L.

Atlas White } 1 to 100 sacks, \$2.50 sack
Calaveras White } warehouse or del.; \$7.65
Medusa White } bbl. carload lots.

Forms, Labors average \$200.00 per M.

Average cost of concrete in place, exclusive of forms, 35c per cu. ft.; \$10 cu. yd.; with forms, 60c.

4-inch concrete basement floor

.....	.30c per sq. ft.
Rat proofing	7½c
Concrete Steps.....	\$1.25 per lin. ft.

DAMP-PROOFING and Waterproofing—

Two-coat work, \$3.50 per square.

Membrane waterproofing—4 layers of saturated felt, \$7.00 per square.

Hot coating work, \$2.50 per square.

Medusa Waterproofing, \$3.50 per lb. San Francisco Warehouse.

Tricocel waterproofing.

{See representative.}

ELECTRIC WIRING—\$12 to \$15 per outlet for conduit work (including switches).

Knob and tube average \$3.00 per outlet. {Available only for priority work.}

ELEVATORS—

Prices vary according to capacity, speed and type. Consult elevator companies. Average cost of installing a slow speed automatic passenger elevator in small four story apartment building, including entrance doors, about \$6500.00.

EXCAVATION—

Sand, 60 cents; clay or shale \$1 per yard. Teams, \$12.00 per day.

Trucks, \$22 to \$27.50 per day.

Above figures are an average without water. Steam shovel work in large quantities, less; hard material, such as rock, will run considerably more.

FIRE ESCAPES—

Ten-foot galvanized iron balcony, with stairs, \$150 installed on new buildings; \$160 on old buildings.

FLOORS—

Composition Floor, such as Magnesite, 33c to 50c per square.

Linoflor—2 gages—\$1.25 to \$2.75 per sq. yd.

Masterpay—90c to \$1.50 per sq. yd.

Battleship Linoleum—available to Army and Navy only—⅛"—\$1.75 sq. yd.
⅜"—\$2.00 sq. yd.

Terazzo Floors—50c to 70c per square.

Terazzo Steps—\$1.75 per lin. ft.

Mastic Wear Coat—according to type—20c to 35c.

Hardwood Flooring—

Standard Mill grades not available.

Victory Oak—T & G

⅜" x 2¼".....\$143.25 per M. plus Cartage

½" x 2".....122.00 per M. plus Cartage

½" x 1½".....113.50 per M. plus Cartage

Finished Standard & Better Oak Flooring

⅜" x 3¼".....\$180.00 per M. plus Cartage

½" x 2½".....160.50 per M. plus Cartage

Maple Flooring

⅜" T & G Clear \$160.50 per M. plus Ctg.

2nd 153.50 per M. plus Ctg.

3rd 131.25 per M. plus Ctg.

Floor Layers' Wage, \$1.50 per hr.

GLASS—

Single Strength Window Glass.....20c per □ ft

Double Strength Window Glass.....30c per □ ft.

Plate Glass, under 75 sq. ft.....\$1.00 per □ ft.

Polished Wire Plate Glass.....1.40 per □ ft.

Rgh. Wire Glass......34 per □ ft.

Obscure Glass......27 per □ ft.

Glazing of above is additional.

Glass Blocks.....\$2.50 per □ ft. set in place

HEATING—

Average, \$1.90 per sq. ft. of radiation, according to conditions.

Warm air (gravity) average \$48 per register.

Forced air, average \$68 per register.

IRON—Cost of ornamental iron, cast iron, etc., depends on designs.

LUMBER—All lumber at O.P.A. ceiling prices—

No. 1 Common	\$49.00 per M
No. 2 Common	47.75 per M
Select O. P. Common	52.75 per M

Flooring—

V.G.-D.F. 8 & 8tr. 1 x 4 T & G Flooring	Delvd. \$80.00
C 1 x 4 T & G Flooring	75.00
D 1 x 4 T & G Flooring	65.00
D.F.-S.G. 8 & 8tr. 1 x 4 T & G Flooring	61.00
C 1 x 4 T & G Flooring	59.00
D 1 x 4 T & G Flooring	54.00
Rwd. Plastic—"A" grade, medium dry	82.00
"B" grade, medium dry	78.50

Plywood—

	Under \$200	Over \$200
"Plyscord"— $\frac{3}{8}$ "	\$49.50	\$47.55
"Plywall"— $\frac{1}{4}$ "	45.15	43.30
3 ply— $2\frac{1}{2}$ — $\frac{1}{4}$ "	48.55	46.60
"Plyform"— $\frac{3}{8}$ "—		
Unailed	126.50	121.45
Oiled	127.90	122.75

Above prices delivered if quantity is sufficient to warrant delivery.

Shingles (Rwd. not available)—

Red Cedar No. 1—\$6.75 per square; No. 2, \$5.75; No. 3, \$4.45.
Average cost to lay shingles, \$3.00 per square.
Cedar Shakes—Tapered: $\frac{1}{2}$ " to $\frac{3}{4}$ " x 25"—\$8.95 per square.
Resawn: $\frac{3}{4}$ " to $1\frac{1}{4}$ " x 25"—\$10.65 per square.
Resawn: $\frac{3}{4}$ " to $1\frac{1}{4}$ " x 25"—\$10.65 per square.
Average cost to lay shakes, \$4.00 per square.

MILLWORK—Standard.

D. F. \$100 per 1000. R. W. Rustic \$100.00 per 1000 [delivered].
Double hung box window frames, average with trim \$6.50 and up, each.
Complete door unit, \$10.00.
Screen doors, \$3.50 each.
Patent screen windows, 25c a sq. ft.
Cases for kitchen pantries seven ft. high, per lineal ft., \$9.00 each.
Dining room cases, \$9.00 per lineal foot.
Rough and finish about 80c per sq. ft.
Labor—Rough carpentry, warehouse heavy framing (average), \$40.00 per M.
For smaller work average, \$40.00 to \$55.00 per 1000.

MARBLE—See Dealers

PAINTING—

Two-coat work	per yard 50c
Three-coat work	per yard 70c
Cold water painting	per yard 10c
Whitewashing	per yard 8c

PAINTS—

Two-coat work 50c per sq. yd.
Three-coat work 70c per sq. yd.
Cold water painting per yard 10c
Whitewashing 8c per sq. yd.
Turpentine \$1.03 per gal. in drum lots.
\$1.06 per gal. in 5-gal. containers.
Raw Linseed Oil—not available.

Boiled Linseed Oil—\$1.38 per gal. in drums. Available only to work with high priority—\$1.48 per gal. in 5-gal. containers.

Use replacement oil—\$1.86 per gal. in 1-gal. containers.

Replacement Oil—\$1.20 per gal. in drums. \$1.30 per gal. in 5-gal. containers.

A deposit of \$6.00 required on all drums.

PATENT CHIMNEYS—

6-inch	\$1.20 lineal foot
8-inch	1.40 lineal foot
10-inch	2.15 lineal foot
12-inch	2.75 lineal foot

PLASTER—

Neat wall, per ton delivered in S. F. in paper bags, \$17.60.

PLASTERING (Interior)—

3 Coats, metal lath and plaster	Yard 1.50
Keene cement on metal lath	1.80
Ceilings with $\frac{3}{4}$ " hot roll channels metal lath (lathed only)	1.20
Ceilings with $\frac{3}{4}$ " hot roll channels metal lath plastered	2.20
Single partition $\frac{3}{4}$ " channel lath 1 side (lath only)	1.20
Single partition $\frac{3}{4}$ " channel lath 2 inches thick plastered	3.20
4-inch double partition $\frac{3}{4}$ " channel lath 2 sides (lath only)	2.20
4-inch double partition $\frac{3}{4}$ " channel lath 2 sides plastered	3.85
Thermax single partition; 1" channels; $2\frac{1}{4}$ " overall partition width. Plastered both sides	3.30
Thermax double partition; 1" channels; $4\frac{3}{4}$ " overall partition width. Plastered both sides	4.40
3 coats over 1" Thermax nailed to one side wood studs or joists	1.65
3 coats over 1" Thermax suspended to one side wood studs with spring sound isolation clip	1.90

Note—Channel lath controlled by limitation orders.

PLASTERING (Exterior)—

2 coats cement finish, brick or concrete wall	Yard \$1.00
3 coats cement finish, No. 18 gauge wire mesh	2.00
Lime—\$3.00 per bbl. at yard.	
Processed Lime—\$3.10 bbl. at yard.	
Rock or Grip Lath— $\frac{3}{8}$ "—20c per sq. yd.	
"W"—19c per sq. yd.	

Composition Stucco—\$1.80 to \$2.00 sq. yard (applied).

PLUMBING—

From \$100.00 per fixture up, according to grade, quantity and runs.

ROOFING—

"Standard" tar and gravel, 4 ply—\$8.00 per sq. for 30 sqs. or over.
Less than 30 sqs. \$9.50 per sq.
Tile, \$30.00 to \$40.00 per square.
Redwood Shingles, \$7.50 per square in place.
5/2 #1-16" Cedar Shingles, 4/2"
Exposure \$8.00 square

5/8 x 16"—#1 Cedar Shingles, 5"
Exposure \$9.00 square
4/2 #1-24" Royal Shingles, 7/2"
Exposure \$9.50 square
Re-coat with Gravel \$4.00 per sq.
Asbestos Shingles, \$23 to \$28 per sq. laid.
1/2 x 25" Resawn Cedar Shakes,
10" Exposure \$10.50
3/4 x 25" Resawn Cedar Shakes,
10" Exposure 11.50
1 x 25" Resawn Cedar Shakes,
10" Exposure 12.50
Above prices are for shakes in place.

SHEET METAL—

Windows—Metal, \$1.75 a sq. ft.
Fire doors (average), including hardware \$2.00 per sq. ft.

SKYLIGHTS—(not glazed)

Copper, 90c sq. ft. (flat).
Galvanized iron, 40c sq. ft. (flat).
Vented hip skylights 60c sq. ft.

STEEL—STRUCTURAL (None available except for defense work).

\$150 ton (erected), this quotation is an average for comparatively small quantities. Light truss work higher. Plain beams and column work in large quantities \$140 per ton.

STEEL REINFORCING (None available except for war work).

\$150 to \$200 ton, set.

STONE—

Granite, average, \$6.50 cu. foot in place
Sandstone, average Blue, \$4.00. Boise, \$3.00 sq. ft. in place.
Indiana Limestone, \$2.80 per sq. ft. in place.

STORE FRONTS (None available).

TILE—

Ceramic Tile Floors—70c to \$1.00 per sq. ft.
Cove Base—\$1.10 per lin. ft.
Glazed Tile Winscot—\$1.25 per sq. ft.
Asphalt Tile Floor $\frac{1}{8}$ " & $\frac{3}{8}$ "—\$.18 to \$.35 per sq. ft. Light shades slightly higher.
Cork Tile—\$.40 to \$.75 per sq. ft.
Mosaic Floors—see dealers.
Lino-Tile, \$.35 to \$.75 per sq. ft.

Wall Tile—

Glazed Terra Cotta Wall Units (single faced) laid in place—approximate prices:
2 x 6 x 12 \$1.10 sq. ft.
4 x 6 x 12 1.25 sq. ft.
2 x 8 x 16 1.20 sq. ft.
4 x 8 x 16 1.40 sq. ft.

VENETIAN BLINDS—

40c per square foot and up. Installation extra.

WINDOWS—STEEL—

30c per square foot, \$5 for ventilators.

THE NEW CITY

(From Page 22)

This statement is backed by 150 pages of most valuable research containing a magnitude of practical and theoretical observations on the elements of city planning, esthetics, and on the replanning of existing cities. I feel that these pages should be a "must" reading in our schools, offices, and city planning commissions; in the end, these pages will prove profitable both from the financial as well as the human standpoint. Here I shall not attempt to review or abbreviate any portion of the book for I recommend careful study of "The New City."

Professor Hilberseimer advocates a sound approach to city design. "Real economy in the building of dwellings and cities cannot be effected by saving money through reduction of space. It can be achieved only by perfect planning and construction." His approach is further illustrated with the presentation of several city layouts, some of which are his work. (Plan for Chicago, London, etc.)

Mr. Hilberseimer brings up a problem that puzzles many a planner—young or old—namely, the bitter division between the progressive and conservative planners. "There are two schools of thought in city planning. One takes into consideration only parts of a city, without connecting these with the whole. "Little" things are thought about, and little parts are changed. Everything is done on a "sound basis." This is the school of the practical man. Paradoxically this practical work, which considers economy first, eventually reveals itself as impractical and unsound. The expense it entails is futile expense. The city so

conkered with remains essentially the same."

The second school thinks about the city as a whole, its zone of influence, its position in the region, and in the nation. It takes everything into consideration and tries to conceive of the needs and function of the city as an entity. This school is often regarded as impractical and theoretical. It is indeed accused of being destructive, eager to tear everything down. Its real purpose, however, is to reconstruct the city, according to a plan, building everything in its proper place."

I am certain that the reader knows into which "school of thought" to put the author as well as the students of the Illinois Institute of Technology in Chicago, where Ludwig Hilberseimer is the Professor of City Planning. "The New City" opens a bright vista into the tapestry of future cities; it presents difficult problems in a comprehensive form; its illustrations are convincing; its language is clear and simple. Modern cities—bombed or unbombed—need surgical operations, and not merely cosmetic embellishments; Ludwig Hilberseimer presents a sound and courageous approach to these "operations," and I therefore recommend his book "The New City" to the reader.

ADVERTISING MANAGER RETURNS

Lester M. Clayberger, for the past twenty-eight months with Uncle Sam's famed Sea Bees, has returned to his post as Advertising Manager of The Paraffine Companies, paints and building materials division.

Executive officer of a construction battalion, Lieut. Comdr. Clayberger saw active service in the Central Pacific, building airfields, roads, and other facilities for the Marines on several islands.

1945 BUILDING TRADES WAGE SCALES (JOB SITES) NORTHERN CALIFORNIA

Six- and seven-hour day eliminated on all Government Work. A. F. L. - O. P. M. Agreement calls for eight-hour day.

NOTE: Predeterminations by the Department of Labor, as of July 1, 1944 (the wage-freezing date) have not yet been made in all of the counties listed. The wage scales shown are those being paid and in effect mostly by agreement between employers and their union.

CRAFT	Alameda and Contra Costa									
	San Francisco	San Francisco	Fresno	Marin	Sacramento	San Jose	San Mateo	Vallejo	Stockton	
ASBESTOS WORKERS	1.50	1.50	1.25	1.50	1.50	1.25	1.50	1.50	1.25	
BRICKLAYERS	1.87½	1.87½	1.75	1.87½	1.75	2.00	1.79-1/6	1.75	1.50	
BRICKLAYERS, HODCARRIERS	1.40	1.40	1.05	1.40	1.05	1.50	1.35	1.50	1.14	
CARPENTERS	1.50	1.50	1.25	1.43¾	1.37½	1.37½	1.43¾	1.50	1.37½	
CEMENT FINISHERS	1.50	1.50	1.50	1.50	1.50	1.50	1.50	1.50	1.50	
ELECTRICIANS	1.70	1.70	1.70	1.70	1.70	1.70	1.70	1.70	1.70	
ELEVATOR CONSTRUCTORS	1.75½	1.75½	1.75½	1.75	1.75½	1.75½	1.75½	1.75½	1.75½	
ENGINEERS: MATERIAL HOIST	1.50	1.50	1.75	1.50	1.37½	1.62½	1.50	1.37½	1.25	
PILE DRIVER	1.75	1.75	1.60	1.75	1.75	1.75	1.75	1.75	1.75	
STRUCTURAL STEEL	1.75	1.75	1.60	1.75	1.75	1.75	1.75	1.75	1.60	
GLASS WORKERS	1.40	1.40	1.12½	1.40	1.12½	1.21	1.40	1.40	1.40	
IRONWORKERS: ORNAMENTAL	1.60	1.50	1.60	1.50	1.60	1.31¼	1.50	1.50	1.50	
REINFORCING IRONMEN	1.50	1.50	1.40	1.50	1.50	1.50	1.50	1.50	1.50	
STRUCTURAL	1.75	1.75	1.75	1.75	1.75	1.75	1.75	1.75	1.75	1.25
LABORERS: BUILDING	1.00	1.00	.90	.87½	.95	.90	.93¾	.90	.90	
CONCRETE	1.00	1.00	.90	.87½	.95	.90	.93¾	.95	.93¾	
LATHERS	1.75	1.75	1.50	1.75	1.60	1.75	1.75	1.75	1.75	1.75
MARBLE SETTERS	1.50	1.50	1.50	1.50	1.50	1.50	1.50	1.50	1.50	1.50
MOSAIC & TERRAZZO	1.25	1.25	1.12½	1.25	1.15-5/8	1.12½	1.42-6/7	1.44-2/7	1.37½	
PAINTERS	1.50	1.50	1.28-4/7	1.50	1.43	1.50	1.50	1.54	1.54	
PILEDRIVERS	1.54	1.50	1.54	1.54	1.54	1.54	1.54	1.54	1.54	
PLASTERERS	1.75	1.83½	1.75	1.75	1.75	2.00	2.00	1.75	1.83-1/3	
PLASTERERS' HODCARRIERS	1.50	1.60	1.40	1.50	1.18¾	1.50	1.75	1.50	1.50	
PLUMBERS	1.70	1.70	1.53-1/8	1.70	1.68¾	1.62½	1.70	1.70	1.50	
ROOFERS	1.50	1.50	1.25	1.37½	1.37½	1.37½	1.25	1.37½	1.37½	
SHEET METAL WORKERS	1.50	1.50	1.50	1.50	1.50	1.50	1.37½	1.70	1.50	1.50
SPRINKLER FITTERS	1.58	1.58	1.53-1/8	1.70	1.68¾	1.62½	1.70	1.70	1.50	1.50
STEAMFITTERS	1.75	1.75	1.53-1/8	1.70	1.68¾	1.62½	1.50	1.70	1.50	1.50
STONESETTERS (MASONS)	1.87½	1.87½	1.50	1.75	1.75	1.75	1.50	1.75	1.50	1.50
TILESETTERS	1.50	1.50	1.37½	1.50	1.37½	1.50	1.50	1.50	1.37½	

Prepared and compiled by

CENTRAL CALIFORNIA CHAPTER, ASSOCIATED GENERAL CONTRACTORS OF AMERICA

with the assistance and cooperation of secretaries of General Contractors Associations and Builders Exchanges of Northern California.

G. P. W.
JENSEN & SON

Building Construction

320 Market Street, San Francisco
Phone: GARfield 2444

**JOHN CASSARETTO
COMPANY**

—Since 1886—And Still Active—

Building Materials

READY MIX CONCRETE
ROCK - SAND - GRAVEL - LIME
CEMENT - PLASTER - MORTAR
METAL LATH - WOOD LATH
STUCCO - WIRE NETTING

Service Unexcelled

Bunkers
Sixth and Channel, San Francisco
Phones: GARfield 3758 - 3760

**MULLEN MFG.
COMPANY**

BANK, STORE AND OFFICE
FIXTURES—CABINET WORK
OF GUARANTEED QUALITY
CHURCH SEATING

Office and Factory:
60-80 RAUSCH ST., Bet. 7th and 8th Sts.
San Francisco
Telephone UNDERhill 5815

**THE TORMEY
COMPANY**

GENERAL PAINTERS
AND DECORATORS

Phone UNDERhill 1913

563 FULTON STREET
San Francisco

**F.H.A.
LOANS**

TO BUY—
REMODEL—
REFINANCE



Long - term
and low-cost
F. H. A. loans are still available
to finance the purchase of homes
already built. Monthly payment
F. H. A. loans for buying or
refinancing homes are made by this
bank for as much as 80% of the
appraised value of the property
with as long as 20 years to repay.

For further information call
at our Real Estate Loan
Department

**CROCKER FIRST
NATIONAL BANK**

OF SAN FRANCISCO
California's Oldest National Bank
ONE MONTGOMERY STREET
Member Federal Deposit Insurance Corporation

Phone GARfield 1166

Thomas B. Hunter

Consulting Engineer
DESIGNER OF HEATING
AIR CONDITIONING
VENTILATING AND WIRING
SYSTEMS, MECHANICAL
AND ELECTRICAL EQUIP-
MENT OF BUILDINGS

41 SUTTER STREET
ROOM 710
San Francisco California

**ANDERSON
&
RINGROSE**

General Contractors

320 Market Street, San Francisco
Phone GARfield 2245

"KIMSUL"

Controlled Insulation!

THERMAL EFFICIENCY 0.27

Compressed in rolls for
shipment and to save stor-
age space, it stretches out
over 5 times and when
fully stretched gives a uni-
form designated thickness
which insures the same
maximum insulation value
at all points.

Fire, Moisture and Vermin
Resistant

Extremely Light, Clean and
Easy to Install.

GUNN, CARLE & CO.

20 Potrero Avenue
San Francisco 3
UN 5480

**DINWIDDIE
CONSTRUCTION
COMPANY**

BUILDERS

CROCKER BUILDING
SAN FRANCISCO



**HERRICK
IRON WORKS**

STRUCTURAL STEEL
REINFORCING STEEL

18TH AND CAMPBELL STS.
OAKLAND, CALIF.
Phone GLencourt 1767

ARCHITECT AND ENGINEER

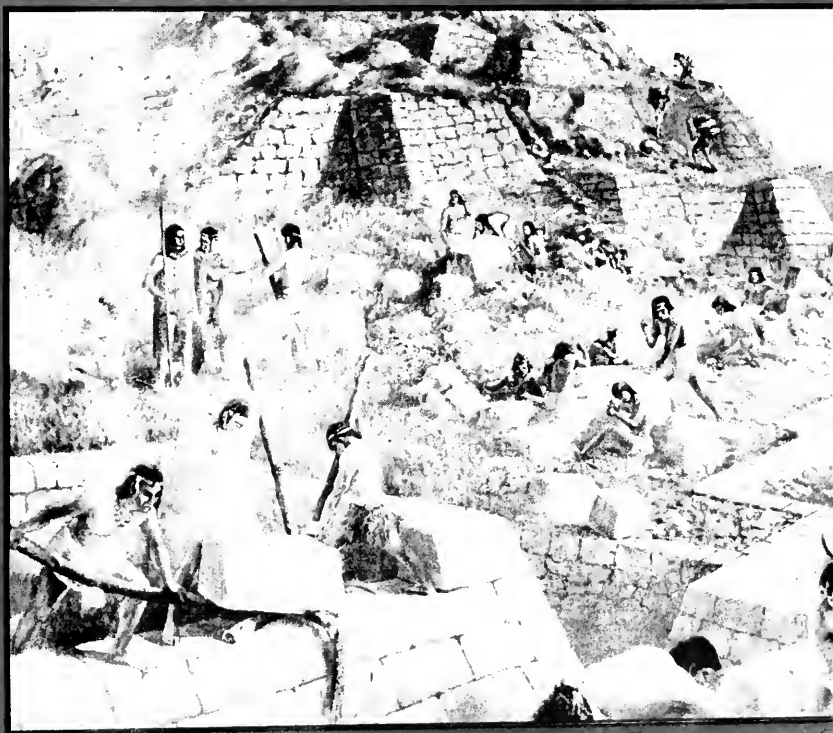

JULY

1945

Corrugated Transite...for permanent, fire-proof roof and wall construction



Installation by Western Asbestos Co. of Corrugated Transite for the American Forge Company, Berkeley, California.

FOR OVER 25 YEARS Johns-Manville Corrugated Transite has continually proved its value as the most efficient industrial roofing and siding material, particularly over skeleton frame construction. Thousands of installations have been made. Accurate records indicate that Transite assures the longest life and lowest per annum cost.

RESISTANCE TO FIRE: Johns-Manville Transite, in addition to being non-combustible, will withstand considerable temperature without cracking or buckling. No other material, so adaptable to general building construction, surpasses Transite in resistance to fire.

RESISTANCE TO WEATHER AND CORROSION: Corrugated Transite provides resistance to the corrosive attacks of practically all of the common acid fumes and gases. It is not affected by climatic conditions, high and low temperatures, or steam irrespective of its temperature or condition.

MODERN APPEARANCE: Many modern architectural effects can be obtained with Corrugated Transite. Its natural light cement gray color and uniform texture presents an attractive appearance. Transite can be painted, if desired.

DURABILITY AND ECONOMY: Corrugated Transite is made of asbestos fiber and cement, formed under great pressure into dense, unlaminated, monolithic sheets possessing unusual



Leslie Salt Company, Newark, California, a recent Corrugated Transite installation by Western Asbestos Co.

strength, rigidity and durability. Since it requires no protective painting or other maintenance expense and because it reduces fire risks to a minimum, Transite is decidedly economical.

COMPLETE ENGINEERING AND CONTRACT SERVICE: Our Construction Department has installed over 5 million square feet of Corrugated Transite. We offer you the advantages that come with this background of practical experience. Inquiries looking to future construction are solicited. Consult our office nearest you.

Contractors and Distributors for Johns-Manville Corporation

WESTERN ASBESTOS CO.
Engineers and Contractors

675 TOWNSEND STREET, SAN FRANCISCO 3, CALIF.
OAKLAND • RICHMOND • SACRAMENTO

ARCHITECT

Vol. 162 No. 1

ARCHITECTS' REPORTS—Published Daily

Telephone DOuglas 8311

AND ENGINEER

MARK DANIELS
Editor

E. H. WILDER
Associate Editor

MICHAEL GOODMAN
Post-War Planning

L. H. NISHKIAN
Consulting Editor

E. N. KIERULFF*
Ass't Editor
*In the Service

Contents for

JULY

COVER: MEXICAN INDIAN PYRAMID BUILDERS (See page 8)

ARTICLES AND MISCELLANEOUS TEXT

	Page
RUNNING FIRE	4
By MARK DANIELS	
NEWS AND COMMENT ON ART	6
GOLD FIRED CRACKLE GLAZE MASKS—ADELE WAYLAND	
COVER PICTURE	8
UNITED AIR LINES, NEW SAN FRANCISCO OFFICES	10
VINCENT RANEY, Architect	
KAHLER GENERAL HOSPITAL, ALL WELDED	11
CONSTRUCTION OUTLOOK	11
By MARDI	
NORTH BEACH PLACE HOUSING PROJECT	13
By JOHN S. BOLLES, A.I.A.	
THE PARADISE INN, PHOENIX, ARIZONA	17
R. T. EVANS, Architect	
MEXICO, A MARVEL OF ARCHITECTURAL CONTRASTS	18
By WM. ARTHUR NEWMAN, Architect	
FREEWAYS	29
MILLIONS OF PEOPLE ATTRACTED BY STORE FRONTS	30
HISTORIC CALIFORNIA FLAG GIVEN TO FRANCE IN 1922	35
WITH THE ENGINEERS	36
A.I.A. ACTIVITIES	37
APPLYING STAINLESS STEEL TO LIGHTWEIGHT STRUCTURES	37
By RUSSELL FRANKS	
PRODUCERS' COUNCIL PAGE	40
BOOK REVIEWS	41
ESTIMATORS' GUIDE	43
ADVERTISERS INDEX	48



ARCHITECT AND ENGINEER (Established 1905) is published on the 15th of the month by The Architect and Engineer, Inc., 68 Post St., San Francisco 4; Telephone EXbrook 7182. President, K. P. Kierulff; Vice-President and Manager, L. B. Penhorwood; Treasurer, E. N. Kierulff, Advertising Manager, V. E. Atkinson, Jr.

Los Angeles Office: 403 W. 8th Street.

Entered as second class matter, November 2, 1905, at the Post Office in San Francisco, California, under the Act of March 3, 1879. Subscription United States and Pan America, \$3.00 a year; \$5.00 two years; foreign countries \$5.00 a year; single copy 50c.

ARCHITECTS' REPORTS are published daily from this office, Vernon S. Yallop, Manager



RUNNING FIRE — by MARK DANIELS

COMMON SENSE

It doesn't seem like good sense to assume you are going to have so many gardeners, house servants, cooks, chauffeurs, and other servants in your menage before you have an idea of a definite income. The hue and cry to make jobs for returning G.I.'s is asking us to do somewhat the same thing. Until the Government gives us some idea of what building material they are going to let us have, how and when we must reconvert and what conditions under which we can figure on work that will create jobs, it is impossible to plan the employment of a definite proportion of returning soldiers. The construction industry is unquestionably the major factor in the employment of men, but that industry is asked to figure how many men they will employ before they know how much work they will have for these men to do. It all seems a little like getting the cart before the horse.

COPS AND ROUGE

Some of the best police officers I ever met were in Algeria, Tunisia, Egypt and neighboring countries. Many of them wore jewelry on or in their eyes, ears, and throats—not in deference to the medical profession, they just seemed to like it that way. It was not, therefore, with surprise that I saw a colored conductorette with long, pendant ear rings calmly collecting nickels from passengers on the street car. But when I saw an attractive white traffic directorette with similar adornments I wondered how long it would be before cops wearing lipstick would cause no surprise.

THE VICISSITUDES OF WAR

Many are the platitudes following war, including this, although these can be ignored while rationing cannot.

The medicos have told us that the protracted abstinence from butter has deleteriously affected our eyesight, although I have heard the counter claim that such a deflection is only the result of eye strain caused by the abnormal, and some say premeditated, shortening of girls' and women's skirts.

Among the many other problems that confront the world is what will London now do with her raid sirens? We're in a heluva fix, aren't we?

DISAPPEARING LONDON

In 1931 MAUDE ALLEN, of terpsichorean fame, and I drove around the western part of London while she pointed out to me how the older London was gradually giving way to more modern structures, landscapes and customs. Miss Allen seemed

to be very depressed by the sights we saw. She was then living in what had been one of the several structures that belonged to the royal estate in Regents Park. When we had returned there she presented me with a book of etchings of the fine old buildings that were slowly fading out of the London picture, entitled "DISAPPEARING LONDON." I still have the book and prize it highly.

Last night I was looking over that collection of etchings. None of the beautiful old buildings and monuments that were shown is now standing. It struck me sadly that a publication of the same work would need only a change in the title.

ESTIMATING

Gun shot estimates of cost are dangerous, not only for architects and builders, but to others who are called upon to estimate the cost of a venture before they enter upon it. Optimists frequently say to themselves "the lumber in this house will cost about \$10,000. I guess the whole thing will run about \$12,000." Or "we eat about \$40.00 worth of meat per month at our house. I guess I'll allow about \$75.00 per month to run the place." That is an exaggeration, of course, but so are all these gun shot estimates.

In the city of San Francisco just such an estimate of cost has resulted in the usual outcome. After considerable publicity it was determined that 50c municipal symphony concerts could be given in San Francisco, despite the fact that the Art Commission had been trying for years to do the same thing. All costs and expenditures of the Art Commission are audited and controlled in detail by the San Francisco Auditor. This experiment was not initiated nor sponsored by the Art Commission but was a purely privately sponsored project. Whether it was launched on a "gunshot estimate" or not may be determined by the fact that on reliable authority the enterprise resulted in a loss of over \$11,000 for the production of three concerts. Had this project been submitted to the City Controller, as all Art Commission productions must be, it is very doubtful that any permission whatever would have been granted.

PENCIL POINTS MAKES A POINT

Kenneth Reid's clear and outspoken points of view are always welcome to the forward looking architect. In the June issue of Pencil Points he says, "... there are plenty of alert architects and designers within the profession who have long ago ceased talking into their own ear trumpets and have turned them instead to catch what the outer world was saying." That is the kind of talk many of us like to hear.

**Conservation of Space
Efficiency in Service**
both depend on

Streamline

TRADE MARK REG. U. S. PAT. OFFICE

The installation of STREAMLINE Copper Pipe and Solder Type Fittings under normal water conditions assures many, many years of trouble-free, efficient service at low cost. Copper and bronze do not rust. STREAMLINE Pipe is made from pure copper. STREAMLINE Fittings are manufactured in copper and bronze.

Conservation of space is a very important consideration, especially in large public buildings and hotels. The more space that can be utilized, the more income produced. Since STREAMLINE Fittings are not connected by flaring or threading, no room is required for wrench play to tighten the Fittings into place, nor need any allowance be made for protruding valve stems, which on threaded pipe, must be swung in an arc to secure. Valves and fittings are installed in a minimum of space, they are located exactly where required, and soldered.

Copper Pipe loses less heat by radiation than ferrous piping, particularly if the surface is kept polished, although copper itself is a very rapid conductor of heat. Therefore, it naturally follows that there is considerably less heat loss when the heated element, water or steam, is being conveyed from the point of generation to the points of distribution through copper pipe of uniform, unclogged, internal conducting area.

Plan on specifying and installing STREAMLINE Copper Pipe for your postwar construction—or for replacement.

STREAMLINE
PIPE AND FITTINGS DIVISION
MUELLER BRASS CO.
PORT HURON, MICHIGAN

NEWS AND COMMENT ON ART



"EURYDICE"

These two masks by ADELE WAYLAND are in gold, fired over a crackle glaze, in fact they have been fired five times and present a depth of texture that defies photography. They were designed with purely decorative motives which followed as a natural result of her long study under Stackpole when she confined practically all her work to sculpture. She calls them Orpheus and Eurydice. As ornamental plaques on a wall they are most effective.

GOLD FIRED CRACKLE GLAZE Masks done by Adele Wayland

Mrs. Wayland's years of study and practice in the various fields of sculpture, modeling from life, painting and ceramics has qualified her in the pre-eminent work she has been turning out in porcelain and burned clay and her accomplishments in this field are shown by these plaques and the crackle ware head called "Lotus" shown on another page.



"ORPHEUS"

NEWS AND COMMENT ON ART



"LOTUS" MASK

by Adele Wayland

CALIFORNIA SCHOOL OF FINE ARTS PLANS FOR POST-WAR PROGRAM

Eldridge T. Spencer, president of the San Francisco Art Association, announces the resignation of William A. Gaw, noted painter, from the position of acting director of the California School of Fine Arts.

Mr. Gaw was appointed to this post at the outbreak of hostilities when the continued operation of the Art School seemed questionable. Mr. Gaw is resigning in order to devote more time to creative painting and to teaching. He will continue his classes at the California School of Fine Arts as well as teaching at Mills College, where he is associate professor of art and chairman of the Art Department.

Simultaneously Mr. Spencer announces that the Board of Directors has appointed Mr. Douglas MacAgy to the position of director of the California School of Fine Arts effective June 1st. Mr. MacAgy will be remembered locally for his work before the War as curator of the San Francisco Museum of Art.

"Illuminating Engineering" has just reprinted a report from their publication entitled **ART GALLERY LIGHTING**. It is well illustrated with half-tones and diagrams and is a brochure that should be available to all museum directors.

The problems of sculpture lighting as well as that of pictures is well handled in its thirty-six pages and it has a good, if brief, bibliography.

LEGION OF HONOR

Dr. Jermayne MacAgy, Acting Director of the California Palace of the Legion of Honor, 3100 Legion Park, San Francisco, has announced the following schedule of exhibitions and special events for July:

EXHIBITIONS: SILK SCREEN PRINTS BY HUGO GELLERT, illustrating "The Century of Common Man," by Henry A. Wallace, Opening July 3; JACOB STERN LOAN COLLECTION, Opening July 3; MODERN TEXTILES, Opening July 5; WATERCOLORS BY GEORGE POST, Opening July 5; GORDON BLANDING COLLECTION, Opening July 6; ROUMANIAN TEXTILES FROM THE SPRECKELS COLLECTION, Opening July 11.

Mr. Carleton M. Winslow, of the Los Angeles chapter of the A.I.A., is steadily recovering from the illness that has kept him from active participation in his practice for the past several months.

Sam W. Hamill, A.I.A. of San Diego, is so busy with plans for several projects in his district that it is difficult to keep in touch with him.

"ELLIS ISLAND"

a photo



LEGION OF HONOR MUSEUM

COVER PICTURE

THE PICTURE ON THE COVER

OUTSIDE OF THE MUSEUMS too little is said about the aborigines of our north American continent. In the United States we boast of the Indians and, at times, of their progenitors who inhabited the Cliff Dwellings of Arizona and Colorado, but they were youngsters to those of Mexico. In the role of time the Mayans, then the Toltecs and later the Aztecs left more than traces of a civilization that some say has not been equaled since.

On the cover is one of the mural reproductions sent to us from Mexico, none of which bore the name of the artist, but they were so good that we thought they justified reproduction, particularly as they all showed the relation between architecture, construction, art and mural decoration that even our forebears bore in their minds even before we were designing what we called houses. The other two cuts of the famous murals in Mexico are reproduced on page 30.

IN THE NEWS

BUILDING MATERIAL SUPPLY URGED

L. C. Hart, president of the Producers' Council, recently recommended the Federal government adopt at the earliest practical date a six-point program designed to build up a normal supply of building materials and equipment needed to permit urgently needed private construction.

"Inventories in the hands of building material dealers must be replenished and the building product pipelines must be filled before private industry can make any important beginning on the huge peacetime building program," Hart said.

"It is recognized that there is not sufficient manpower generally available at the present time to enable civilian construction to proceed unrestricted. However, if building is to resume as fast as workers are released from war plants and from the armed services, an ample inventory of building products must be built up prior to that time. In the case of some building products, up to six months will be required to meet inventory requirements."

With post-war hospital projects being swelled by the \$500,000 job of Architect Douglas Stone in El Cerrito and the \$750,000 project of Birge M. Clark in San Francisco it begins to look as if we in California are approaching a civilized degree of preparedness.

ELIMINATE GOVERNMENT CONTROLS

Efficient reconversion of the construction industry will require selective relaxation of present government controls at the earliest possible date, followed by their ultimate elimination, in the opinion of a joint meeting of the Construction Industry Advisory Group, which was set up in the fall of 1943, and the Construction and Civic Development Committee of the Chamber of Commerce of the United States.

To blueprint this process, a series of specific recommendations calling for action by the War Production Board and other government agencies concerned with construction, include:

"Firm agreement on this proposed construction conversion policy should be reached and working relations established for carrying it out cooperatively by and between the War Production Board, the Office of Price Administration, the Federal Reserve Board, the War Manpower Commission, the Office of War Mobilization and Reconversion, the Office of Defense Transportation, and any other government agency whose activities have a major bearing on the conversion of construction.

PLEXIGLAS DISKS SPEED AND SIMPLIFY SPLINING

An ingenious device for speedily drawing a line parallel to a splined line has been devised by Charles A. Jackson of Ferguson, Missouri.

The procedure consists of inserting the pencil point in a center hole of a Plexiglas disk and pro-



Rohn and Haas Co. photo

PELLING the transparent plastic disk along the edge of the spline or French curve. Mr. Jackson has designed a graduated set of disks, selected to take care of ordinary requirements in splining.

With the new Jackson instrument there is no lost motion and a line parallel to the splined line can be drawn quickly and accurately.

IN THE NEWS

DAILY "CLEAN-UP"

Few people realize the daily task of cleaning hundreds of millions of square feet of floor surface in chain stores, department stores, showrooms, banks, factories, schools, hospitals, dairies, packing plants, office buildings.

Vast total areas are scrubbed for obvious hygienic reasons and with the war shortage of fats and oils the problem has been challenging to suppliers and users of cleaning materials.

A product developed during the war is Maintenix, created by the Research Laboratories of the A. C. Horn Company, Long Island City, N. Y. The distinctive feature of Maintenix is that while going into solution rapidly it produces a fluorescent color which serves as the indicator of the correct dosage of cleanser. Overdosing or waste is therefore minimized.

Maintenix is free of abrasives or fillers, and emulsifies dirt and soil rapidly so that it can be rinsed away without redeposit.

NEW HI-PLASTIC CEMENT PRODUCT

The new improved Hi-Plastic Stucco Cement is being introduced to the trade, according to J. A. McCarthy, President, Pacific Portland Cement Company.

Chief among its properties is the high degree of plasticity which gives greater workability and more yards per sack, and it is also designed to reduce shrinkage cracks and affords a finer texture and more uniform color for stucco.

It is also adaptable for mortar, gunite jobs, and other uses where high plasticity is a factor.

Hunters' Point seems to be getting a good deal of attention from the San Francisco Housing Authority. But who can tell, they are very careful. The contract for 224 units, plans for which were prepared by JOHN DINWIDDIE & KENT & HASS, of San Francisco, has been awarded for \$535,034. If the Dinwiddie Construction Company had been the low bidder it is doubtful that they would have been awarded the contract.

From J. A. Krug, War Production Board Chairman, comes the statement that W.P.B. wants to get rid of regulations and production limitations as quickly as possible.

Among steps in reconversion are: the third quarter allocations of 8,800,000,000 of lumber, one half for industrial users priorities for \$107,900,000 for equipment and plant construction authorized as industrial aid; brass mill available at once for civilian use.

NEW INTERCOMMUNICATION SYSTEM

The SW 80 is a representative standard Bogen system featuring complete program supply and inter-communication facilities. Housed in a handsome console it includes an all-wave, high fidelity radio tuner, loudspeaker, two amplifiers, 12-inch turntable with automatic record changer optional and two microphone pickup channels for program supply. Magic eye tuning, visual volume level indicator included.

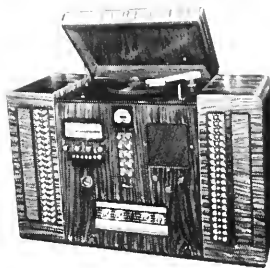

The system provides full intercommunication facilities for up to 80 stations with push button selection and provision for two-way origination of calls.

Highly flexible sound distribution system, ideally suited to schools, hotels, institutions, hospitals and many industrial plants. Literature is available on the Bogen line, David Bogen Co., Federal Trust Bldg., Newark 2, New Jersey.

THE SHELL CHEMICAL COMPANY is taking bids on their \$500,000 agricultural laboratory and greenhouses at Salida, Stanislaus County, California. While we are all interested in a contract of that size we are further interested in just what function such a laboratory will perform. The resources and possibilities in this great State are such that many possibilities present themselves. We would venture a few but the possibilities are too diversified to stick the neck out.

MODERNIZATION AND REPAIRS. From the Westinghouse Company comes the prediction that in the transition period from war to peace, repairs and modernization will be the major factors in housing work. They predict that the amount of money spent on those two items will probably exceed the amount spent on new housing by 25 to 50 per cent. They further state that we may expect housing construction to range from 400,000 units in the first peace year to 1,000,000 units in the fifth year. We will have to accustom ourselves to the sound of the hammer and the saw. As an example Westinghouse states that "the wiring in better than 95% of America's homes is inadequate to carry efficiently the present lighting and appliance load."



MAIN UNITED AIR LINES OFFICES
at corner of Powell and Post Streets
San Francisco, California.

Below: View of ticket counter—wait-
ing room in background, right.

VINCENT RANEY
Architect

UNITED AIR LINES

New San Francisco Offices

To Architect Vincent G. Raney came officials of United Air Lines with critical wartime problem number?—how can we expand, redesign, rearrange present United Airlines offices adequately to handle the tremendously increased and continuously growing passenger travel out of San Francisco?

Raney modestly doesn't remember what he said but what he did speaks for itself. The new San Francisco home of the Mainline Route is modern, orderly, spacious, convenient, and practical. Its beauty is the beauty of the air age with smoothly curving lines suggestive of movement without great effort. Colors are of sky and waters and the lighting, of atmosphere and reflection rather than of spots and shadow. Efficiency of design is proved in the easily handled, uncrowded greater traffic than ever.

The necessary facilities of a major air terminal ticket and administration office are relatively few:

1. Selling of tickets.
2. Manifesting or weighing of baggage and checking of tickets.
3. Arranging transportation of passengers from ticket office to air terminal.
4. Offices of general administration.

The problems of ticket sales, baggage handling, and administrative crowding were simply a matter of expanded air travel largely stimulated by the war. The problem of transporting passengers to and from the air field was further complicated and increased by the civilian gas shortages preventing many from either driving directly to the

field or being delivered there by the cars of friends and neighbors.

To facilitate ticket handling Raney provided sixteen selling units arranged in a "U" counter. Each unit is connected directly to the cashier's office in the basement by a Lansom delivery tube.

To take care of baggage Raney had four scales built into the counter. As the baggage is registered and checked it is deposited in a chute that carries it down into the basement where it is sorted and segregated by destination. It is later sent by conveyor up to the sidewalk by the side of the limousine that takes both passengers and baggage to the airport.

The balance of the waiting room is given over to spaces for passengers' convenience and to the necessary ticket office adjuncts.

(See Page 12)



W. D. Auerbach photo



Ellerbe & Company, Architects

PROPOSED NEW ALL WELDED KAHLER GENERAL HOSPITAL At Rochester, Minnesota

Framework of the new unit will be designed as a continuous structure of beams and connecting members conforming to general engineering acceptance. All concepts of riveted construction which tend to restrict the range of application of certain welding details have been discarded.

The Lincoln Electric Company, manufacturers of arc welding equipment, announce this will be the first all-welded hospital building to be built in the United States.

Bonds were voted for a new grammar school building in Concord, California, to be constructed at a cost of \$195,000, according to the plans of Dragon & Schmidts, Berkeley, California.

THE CONSTRUCTION OUTLOOK

By MARDI

Just how to pitch into a subject as broad as the construction outlook without any foreground of months of prefatory articles presents a problem. In fact it shouldn't be done but there has to be a beginning somewhere. There are so many things confronting us right now that were in the category of future things, that we would take up later, that it is a bit confusing. And right there is the major cause of our trouble, if we can call having too much to do a trouble. For some time the ARCHITECT AND ENGINEER has been warning the contractors that the time was coming when we would find ourselves facing a flood of work and would be ill prepared to take it on.

A glance over the records of the past few weeks will suffice to indicate how the snowball is rolling up on us. This item must, of its nature, be only a brief of the detailed facts that are to be found in the daily items set out in ARCHITECTS' REPORTS and similar publications but it will serve to substantiate and justify our repeated warnings.

In the past three weeks the Government has announced the allotment of over \$24,000,000, to be spent here on construction work for the Government alone. The work will cover roads, sewers, water works, air bases and building work. In addition to this allotment the Government has called for, let bids, or started plans for \$7,252,000 additional work of a type of smaller jobs open to bids.

The private, municipal, and miscellaneous work planned or open for bids breaks down substantially as follows: Schools, \$2,500,000; Hospitals, \$2,600,000; Housing Projects (not included in the above Government work), \$1,900,000; Municipal and miscellaneous jobs, such as jails, libraries, laboratories and auditoriums and churches amount to over \$1,000,000. Added to these are municipal bonds that have been voted to over \$16,000,000. These are only the high lights gleaned from the daily reports of the past three or four weeks and it seems that there is going to be no let up in the demand. The Federal Government is working hard and fast on the problems involved in clearing the way for construction. As fast as possible priorities are being established to clear the way for the materials men and methods of vacating and re-converting are being clarified daily. No matter how far we get in this work it seems that we will still be swamped with demands for more work to be done when the State of California begins to open up the State work in earnest. There are hundreds of millions of dollars worth of jobs there in highway work, the Central Valley Projects and extra dam work to be done.

There is a condition obtaining on the Pacific Coast, the like of which has never existed before. The natural resources are here, transportation from great resources to the coast is here, climate that permits 365 days' work a year is here and the work is here to do. It is increasing at an avalanche rate. Already we are fabricating houses to be built in Great Britain and Russia, and shipping them, too. We are building machines of war, fighting ships, ammunition and training soldiers. What are we going to do with this new and greater influx of work? Why, we're just going to take it in our stride, the stride of a great empire on its way!

The contract for the 188 family dwelling units by W. D. Peugh and H. E. Sweeting, architects, has been awarded to the G. W. Williams Company of Burlingame for \$399,775.

NEW UNITED AIR LINES

(From Page 10)

The general offices and manager's office are located on the mezzanine. In the basement, besides the baggage room are the auditor's office, conference room, ladies' locker room, storage and mechanical equipment.

The exterior of the ticket offices was designed around a corner entrance to provide easy access and egress. The identification signs above are visible from three directions and both location and design afford exceptional advertising values. The exterior surfaces of the offices are covered with ceramic veneer, signs are of Ferro-enamel and Herculite doors were used for the main entrance. Interior walls and ceilings are Empire plaster over gypsum board lath. Genuine care was exercised to use existing and non-critical materials as far as was possible. The floor material, for instance, does not represent the exact color scheme Raney desired to carry out the motif suggested by the general color pattern of grays and blues but represents a satisfactory compromise in materials immediately available.

Interior lighting in the main ticket office is accomplished by cold cathodes while the ticket counter itself is lighted with direct incandescent fixtures. An interesting feature is the illuminated map. This was sand blasted, painted and lighted from behind with fluorescent tubes.

Mechanical fixtures include two 7000 CFM blowers with steam coils and filters. The innumerable telephones were handled by building a removable baseboard raceway.

DEAN AT USC NAMED

Arthur B. Gallion, director of planning and construction for the Pacific Coast Region of the Federal Public Housing Authority, has been selected to serve as dean of the University of Southern California College of Architecture, according to an announcement made recently by President Rufus B. von KleinSmid. He succeeds Arthur C. Weatherhead who has retired.

Following his graduation from the University of Illinois in 1924, Gallion traveled extensively in Europe, Tunisia and Puerto Rico and was awarded a traveling fellowship to attend the Ecole des Beaux Arts in Paris.

For a two-year period he served with leading architectural firms in Chicago and St. Louis and has carried on extensive research work in housing and planning. Gallion will assume his new duties at S. C. in September.

Charles E. Butner, architect, is designing a \$150,000 county jail for Merced.

NORTH BEACH PLACE

HOUSING PROJECT - San Francisco

HENRY H. GUTTERSON & ERNEST BORN, Architects

by John S. Bolles, A.I.A.

Chief of Technical Division of the Housing Authority
of the City and County of San Francisco.

The San Francisco Housing Authority has recently announced its intention of proceeding with the construction of the North Beach Place and the Bernal Dwellings housing projects as soon as funds and materials are available. A careful review of the materials field indicated that it would be possible to construct projects of this nature at this time. The San Francisco Authority is endeavoring to convince the various Federal agencies involved that it would be far more advisable to invest funds in a permanent structure than to continue a program of temporary war housing. It is recognized that permanent housing projects of the nature of the North Beach Place and Bernal Dwellings would cost considerably more than the

original funds set up for these purposes; however, the difference in cost would be far less than the cost of construction of temporary war housing which would have to be demolished when hostilities cease.

In view of the contemplated construction of these projects within the immediate future, the **Architect and Engineer** has seen fit to publish the plans and drawings for the North Beach Place project. This undertaking on the part of the magazine should revitalize the interest of the architects and the public in the potentially enormous field of slum clearance housing. Certainly no finer example of public housing could be selected than the work of Henry H. Gutterson and Ernest Born.

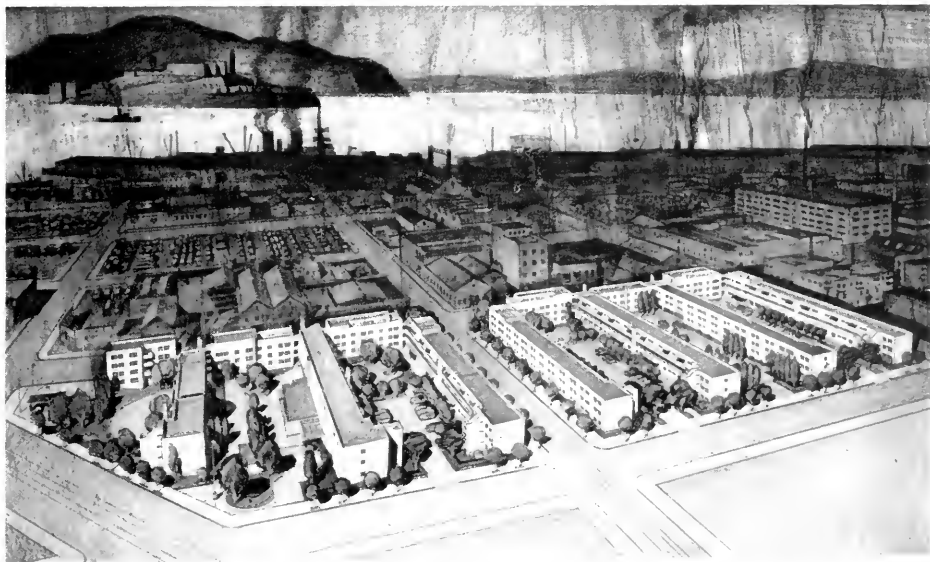

Looking North to Alcatraz Island

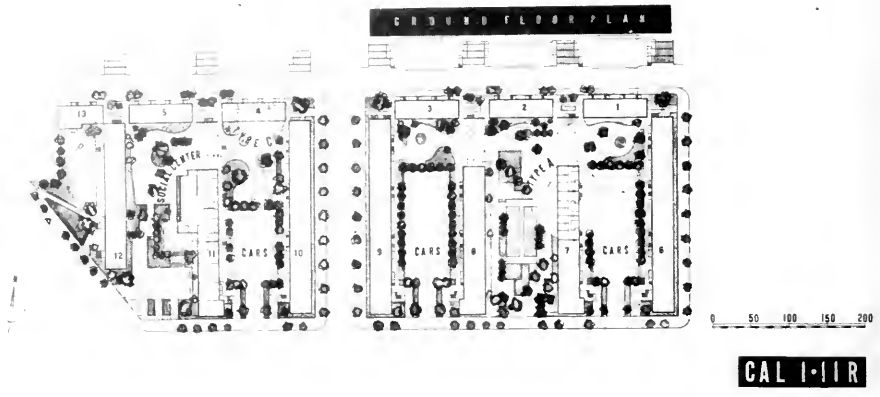

Above: Garden Level Plan showing Type "A" apartments and Social Center.

Below: Typical Plan for Upper Floors showing Laundries and Drying Yards on roof detail Type "B" apartments.

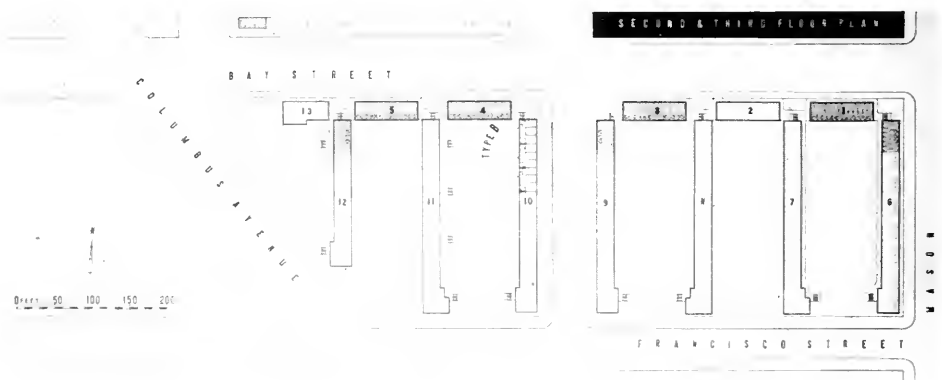

The period of the war has given the Housing Authority an opportunity to evaluate management technical problems which have heretofore been set up on a more or less theoretical basis. With the tapering off of the war housing program, the Authority is activating its studies based upon management experience and it is about to enter into a program whereby it will call upon the architects and the engineers for assistance in setting up standards which are far more realistic than those called for under the old United States Housing Authority.

It is interesting to note that in the case of the North Beach Place project there are but few changes which appear to be necessary and that most of these arise out of the necessity of curtailing



The social center and building No. 11

changes necessary to overcome former material restrictions, USHA minimum requirements and lack of management experience.

North Beach Place is composed of 226 apartments. Of this number, 60 have one bedroom, 98 have two bedrooms, 59 have three, and 9 have four bedrooms. In many cases, the kitchen and dining facilities are in the same room while in other cases the kitchen is a separate room with dining and living room facilities combined. With the exception of one building which has four stories, all of the structures are three-story, walk-up, balcony-type buildings. None of the basements is used with the exception of one building in which the terrain permits the ground floor level to be adapted for management offices and tenant activities. Tenant activities within the building include a large social room, experimental kitchen

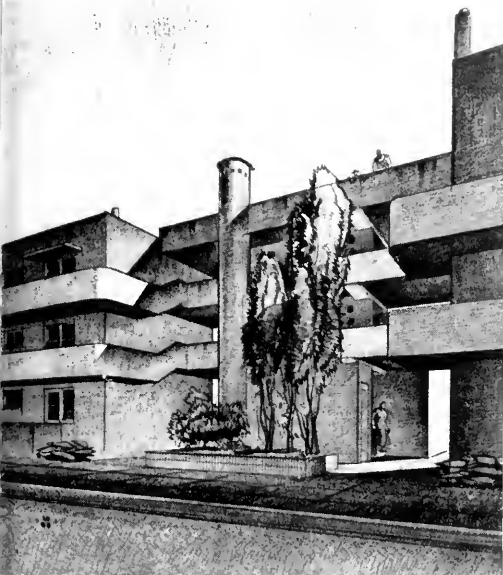

A typical street entrance to garden court

material requirements during the later stages of the planning of the project. The plans for this housing development were well under way at the time of Pearl Harbor Day in 1941 and were not completed until the middle of 1942. It had been the intention of the Authority to construct the project as was done in the case of the West-side Court project. The construction cost became so uncertain and so obviously high that the project had to be abandoned. The architects are, at this time, preparing for the San Francisco Housing Authority a list of their recommendations for minor



A garden court and play area

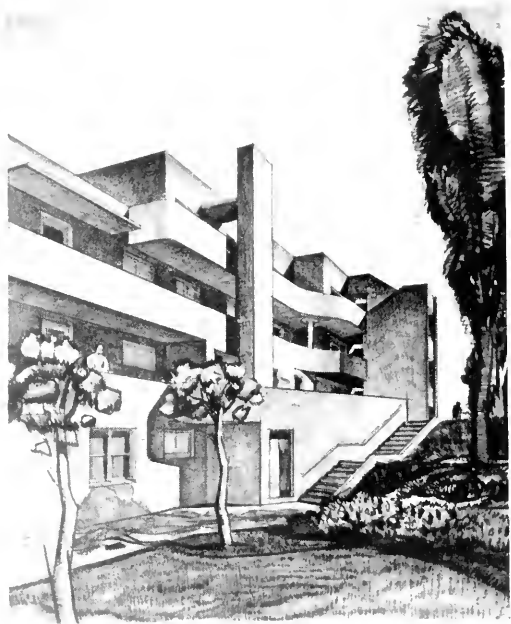

A composition in vertical and horizontal elements

and two craft rooms. By placing the laundry and drying yards on the roofs, the architects have succeeded in maintaining a large amount of land area for planting and recreational facilities. Alternate courts provide for interior parking of automobiles. The architects have created a great sense of openness and a clean flow between courts by the inclusion of large open passages on ground floor levels. The landscaping and paving treatments carry on uninterruptedly through these passages. Aside from the recognition of the large family problem in the four-bedroom units, the architects have adapted the project to the North Beach area by including a Bocci court.

In this day of our so-called modern architecture and the indiscriminate use of the word "functional" in its application to art and architecture, it is pleasing to note that the architects have recognized the need for a parapet and have used the parapet without sacrificing any of the beauty of the buildings.

From the drawings reproduced in this issue of **Architect and Engineer** it will be apparent, even to the layman, that the architects have arrived at something pleasing to the eye and that the landscaping, as planned by Thomas Church, will, in itself, be a contribution to the North Beach district. From these plans, however, one does not see the real problems which are involved in the develop-

ment of a site with a highly unstable foundation condition. The firm of Dames & Moore, geologists and foundation engineers, made a careful analysis of the site and reviewed the problem with the structural engineer, August V. Saph. The eventual solution was that the project be placed upon concrete piles. The building construction calls for the use of reinforced concrete exterior bearing walls, reinforced concrete post and girder interior system, with reinforced concrete flat slabs, including the roof. In some cases, the second story balconies are over portions of the lower rooms, while in others they are reinforced concrete cantilever structures projecting from the face of the building. The exterior masonry is left exposed. The interior partitions are of wood stud with metal lath and plaster. The balance of the concrete is left exposed with the exception of the interior faces of the exterior walls which are furred and plastered.

There is probably not much romance in the work of the mechanical engineer but the architects have assured the Authority that the work laid out by Clyde E. Bentley was as near foolproof as is possible under the USHA limitations.

In order to have specific information for costs on present-day construction, the Housing Authority recently obtained an estimate from MacDonald & Kahn, Inc. This showed the cost of construction to be slightly in excess of the five thousand dollar limitation placed upon public housing by the National Housing Act; however, both the Army and the Navy have expressed their enthusiasm over the possibility of constructing the project at this time and it is hoped that with their cooperation restricting statutory limitations will be waived. The Housing Authority and the Armed Forces take the realistic approach to the problem in that this project could be turned over to either of the services for the duration of the war with a contribution from the lessee being less per unit than the cost of construction of temporary housing, and that the Housing Authority in exchange would enter the post-war period with 226 housing units available and constructed at an outlay to the Authority approximating pre-war prices. It will be unfortunate if, for once, realism cannot overcome statutory limitations for then not only would the armed services be deprived of this housing but the City would have to wait for what will undoubtedly be its outstanding housing project.

THE BONDS HAVE BEEN VOTED AND THE DRAWINGS ARE UNDER WAY for seven new grammar schools for an estimated \$425,000 at Napa, in Napa County. The plans are being drawn by Fredrick H. Kennedy, Jr., of Pasadena, California, which shows that the selection of the architect is not a matter of geography.



NEW PARADISE INN AT PHOENIX, ARIZONA OFFERS MODERNISTIC DINING FACILITIES

R. T. EVANS, Architect

The Paradise Inn at Phoenix, Arizona



Patio at Paradise Inn, Phoenix

While the Bird of Paradise is not related ornithologically to the Phoenix, apparently they occupy the same nest in Arizona, for the Paradise Inn nestles perfectly in the suburban scenery of Phoenix. We in western America are prone to adopt the Mexican conception of the Phoenix as arising from the ashes, but in Chinese legendry it is a most beautiful bird and so a Paradise in Phoenix is not exactly an anachronism. (Pretty badly strained figure, but let it go.)

Anyhow, the architect had the courage to let a well designed building stand on its merits without plastering it over with daubs and veneers. The building is of reinforced concrete with a wash coat of white. When such a building is well done the rugged strength of the structure is in itself a major charm and any plastering and daubing only serves to weaken it. Mr. R. T. Evans was the architect and he no doubt bore in mind the harsh
(See Page 36)



Column of Independence . . . Mexico City

Symbolic of Mexico's Free, Peace-Loving People

ARCHITECT AND ENGINEER

MEXICO

A MARVEL OF ARCHITECTURAL CONTRASTS

By WM. ARTHUR NEWMAN, Architect

Stone and masonry structures discovered on the Gulf shores attracted attention, but it was the report of much gold that hastened some 400 Spanish adventurers in 1519 to Mexico. There they found an empire in a state of civilization that greatly astonished them; pyramids, larger than those in Egypt, stone palaces, temples, the splendid estates of the nobles and, of course, uncounted silver and gold.

Settlers who followed these conquistadors brought important architectural plans from across the Atlantic, and during succeeding centuries left their history in buildings and cities they constructed—similar to the very things we would see in Europe; really a marvel of architectural contrasts. This offers an opportunity to students of architecture for study and inspiration not available elsewhere, due to present conditions. Suppose we take a look at some typical examples.

There is a bit of interesting excavation back of the Cathedral in the capital, revealing sculptured stonework of the teocali, or great temple of the Aztecs, which was demolished by the Spaniards four hundred years ago. Portions of the heavy foundations, buttresses and stairways are exposed. Stonework lying about the enclosure and in the nearby National Museum represents religious

rites, sacred serpents, plants, warriors in full dress, etc. We may marvel at the untiring patience of these artists who carved in hardest stone the caryatides, columns, cornices and ornamentation of palaces and pyramids with their primitive stone hammers and stone chisels.

On the site of this great Aztec temple the present Cathedral was begun in 1525 and dedicated 150 years later. It faces the Plaza of the Constitution, or Zocalo, as it is called, and is one of the largest and oldest Spanish Renaissance cathedrals in the Americas. The interior ornamented vaulted ceilings are supported by Roman Doric columns, and the executed work speaks well for the skill of the architects and native artisans.

Adjoining the Cathedral is the Sagrario, faced with brown stone, in Mexican Churrigueresque, and was finished in 1769.

Let us dodge the traffic to the east side of the Zocalo, to the magnificent National Palace, where are located offices of the President of the Republic and Federal agencies. The design may be termed a Spanish Colonial Baroque, constructed of Tezontle stone. Started in 1692, it required 200 years to complete. On this site was the former palace of the Aztec emperor Montezuma.

**View of Avenida 20 de Noviembre,
Mexico City, D.F.**

National Railways of Mexico photo





Left: View of Cathedral and Presidential Palace in Mexico City, D.F.

Kodak Mexicana Ltd. photo

Below: Close up of Historic Cathedral.

National Railways of Mexico photo

Europe, older sections of cities contain structures which have played historic parts in times past, and so it is here. Many, however, have through the centuries lapsed partly into the decay that follows progressive moves to newer sections.

Passing down former Calle San Francisco, now Avenida Madero, we arrive at the "House of Tiles," which everyone here recognizes as "Sanborns," where you buy almost anything and meet almost everyone. This building was constructed in the late 1500's by a noble of the House of Orizaba, and exemplifies the use of ornamental blue and white glazed tile trimmed with buff stone. In those days a tile house was an indication of the wealth and importance of the owner.



Chapultepec Palace, house of Emperor Maxmilian and Charlotta, Mexico City, D.F.



"Sagrario," for the safe keeping of sacred religious objects, in Mexico City, D.F.

An American Renaissance type across the street is the Banco de Mexico, which functions similar to our Federal Reserve Bank.

Occupying the adjoining block is the splendid white marble Palacio de Bellas Artes designed by the Italian architect A. Boari and completed eleven years ago under the direction of Mexican architect F. Mariscal. It contains the national theater, exhibition and lecture salons, art galleries, museum, ball room, library, etc.

On entering the main vestibule one sees with keen appreciation the noble conception of the architects—a great marble lobby, grand staircases, foyers, great columns, all faced with beautifully colored Mexican marbles and bronzes. Impressive paintings by Rivera and Orozco decorate wall panels on upper floors. A unique glass mosaic curtain in the theater is a most elaborate Tiffany product.

The east side of this Palace of Fine Arts faces the main post office, of volcanic stone, completed forty years ago in Spanish Gothic by Architect Boari. It is elaborately ornamented with bronze and ironwork of Florentine manufacture.

Down Paseo de la Reforma, in the center of the large gloriotta, towers the beautiful Column of Independence 150 feet high in buff stone and with marble statuary. The column is surmounted by a winged golden angel and is dedicated to the heroes of Mexican independence. Inside the column is a spiral stair leading to the top of the capitol which I climbed to view the city — the homes of the wealthy, the busy traffic below, and to visualize and ponder the expansion of the me-



Embassy residence of U. S. Ambassador Hon. George D. Messersmith, in Mexico City, D.F.

Wm. A. Newman photo

tropolis from its inception to the present time, and what its future may be.

It's an interesting city; centuries-old buildings close to multi-storied modern structures, odd and unusual types abound, vying for attention, denoting the trend of design of their period; so very many with lovely details, and the sum total a marvel of architectural contrasts.

As an architect, viewing from this vantage point a city of great interest, I was impelled perhaps by a power not one's own, to dream of the possibilities there of added charm and beauty. And so the thought led me to discuss this with one who has been dreaming for years of beautifying cities.

Mexico is fortunate in having an outstanding personality devoted to the planning of the city beautiful. He studied engineering and graduated in architecture at Columbia University, opening his office in Mexico City in 1925, where he has prepared city plans for Monterrey in Mexico, Vera Cruz, Guadalajara, Acapulco and Mexico City. The Mexican government appointed him a dele-



Mexico City's Main Post Office

tal College.

Senor Contreras impresses one as a capable, genial and friendly person, who knows us and likes us. Because he, too, is so well thought of, the Rotary Club of Mexico City insisted on electing him their president.

Busy architect that he is, recently we finally found a quiet spot, away from the telephone and numerous clients.

"Tell me about your Mexico," I suggested. He

**National
Palace**



**Mexico
City**

gate to the International Planning Congress in Paris in 1928; also to the Congress in London in 1935, and again to Paris in 1937.

His wise counsel resulted in the formation of the National Planning Association of Mexico, and it was at his invitation the International Planning and Housing Conference met in Mexico in 1938. You who have read Violich's "Cities of Latin America" may have rightly guessed I am referring to Architect Carlos Contreras, Chairman of the Planning Forum of the University of Southern California in 1939, who has delivered series of lectures at the Universities of Michigan, Columbia, and Occiden-

leaned back in an easy chair as he replied: "Mexico is a marvel of architectural contrasts because we are a country of tradition and the blending of traditions; an active country and a changing country. It is a young-old country with a wealth of building materials and fine craftsmanship."

"Do Mexican architects enjoy visits of architects from the United States?" I ventured. "Indeed," he nodded, "and the professional and educational interchange of experiences." He has appreciated the friendly and helpful cooperation received when he visited the States, and he endeavors to reciprocate when an American architect comes to Mexico. Results of the "Good-Neighbor" policy are already seen in more understanding, elimination of superiority and inferiority complexes, mutual respect and cooperation. It should grow and carry on.

The Institute of Mexican-American Cultural Relations has been active in promoting many scholarships for Mexican students in schools and universities in the United States. This is a great help in a closer understanding and friendliness of the interests of the two countries. More American students should come to Mexico.

Through the American Institute of Architects a



City Hall in Mexico City, D.F.



La Latino-Americana Apartments, in Mexico City, was completed two years ago. Housing 150 families, it is the largest apartment building in Mexico.

American Photo Supply Co photo

competition was held in Mexico for a scholarship that had heretofore always been awarded a French student. Architects Campos, Tardit and Contreras prepared the program, "The Replanning of Tampico," a fifteen-day competition. Award was made to Carlos Lazo, Jr. As a result he traveled all over the United States, was treated royally, returned full of enthusiasm and plans an active career; thanks to this cooperation.

The new generation of architects must receive a great deal of credit for the efforts they have made in strengthening their position with the Government officials and the public. They have been battling for this twenty-five years, in the development of architecture in Mexico—for the recognition of the

standing of architects in the new hospital program for the Republic and the new school program. And, of course, whatever planning has been done, has been largely done by architects.

The greatest benefit resulting from the International Planning and Housing Conference in Mexico City in 1938 was the interchange of thoughts and mingling of planners from all over the world, and the stimulation of interest in these problems.

"How did you become interested in city planning?" I inquired. He smiled, "While teaching Freehand Drawing, Elements of Architecture, French and Spanish at Columbia from 1918 to 1925, I became acquainted with the 'Regional Plan of New York and Environs' through Prof. Boring,

New Alameda Hotel,
Morelia, Mexico,
facing corner of the Plaza.

Nelson Morris photo





Striking view of Plaza and Main Avenida, Morelia, Mexico, from Alameda Hotel *Nelson Morris photo*

head of the School of Architecture. Free access was given me to the office of Thomas Adams, Director of the Regional Plan, and it seemed it would be a very nice movement to start in Mexico."

"In order to create a still more beautiful capital out of Mexico City," Senor Contreras continued, "there should be a Master Plan, officially approved." He prepared one in 1938, and also later studies. There should be more boulevards of the type of Paseo de la Reforma; height of buildings should be restricted; architecture controlled; the central part of the city preserved and protected by better building regulations; the standard of living raised, and better housing.

Then we talked about the splendid improvements he had made in modernizing various districts in the capital—Avenida San Juan de Letran, Avenida 20 de Noviembre, Lopez, Insurgentes to the Cuernavaca Road, Rio de la Loza-Cuauhtemotzin, Arcos de Belem, Gante, the ring being built around the City, installation of parks and parkways on the site of the old Colonia railroad station.

"Our city plans are valued," he proceeded, "but one unfortunate thing is that when we are not engaged to interpret and carry them out, they are liable to be changed from the original ideas by other people."

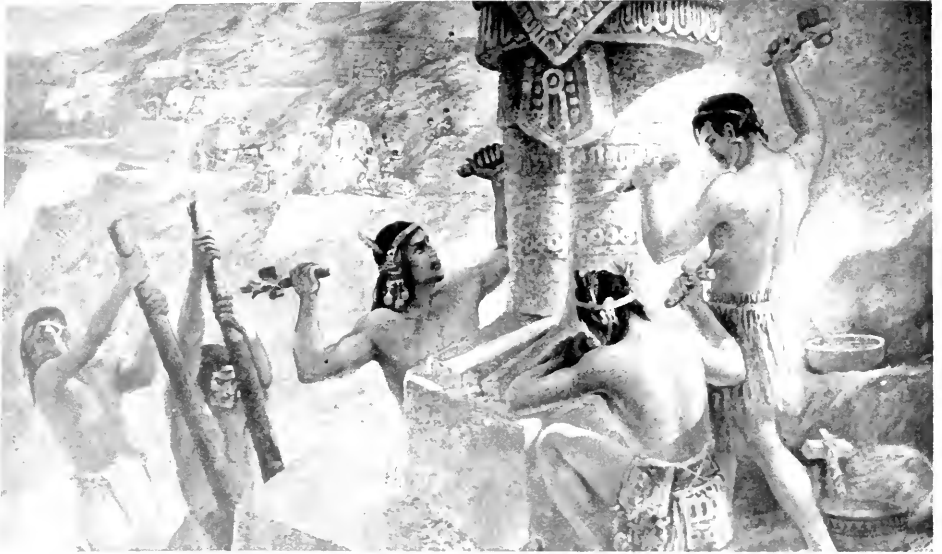

Above: Mexican Indian temple builders centuries before Columbus—photograph of a mural on display at Cuernavaca, Mexico.

Below: Interior of the Palace of the Aztec Emperor Montezuma in Mexico City—picture depicting the announcement of the arrival on the Gulf shores of the Spaniards.

Photo by American Photo Supply Co.





Palacio de Bellas Artes (Bank of Mexico to the right), Mexico City, D.F.

"How may a better culture, lovelier and finer cities in which to live, be created?" I questioned. He paused a moment and then continued, "For example, if I should condense my thoughts I would like to see the heart of Mexico City, which covers an area of one and a half square miles, containing all the fine architectural monuments which reveal the strength of its tradition, preserved in its character; buildings not higher than four or five stories allowed. The decayed buildings in this area which have no architectural value should be torn down and plazas created and the number of gardens increased; a reduction in automobile traffic, so that all of the traffic will not go through this part of the city; in fact traffic should be kept out of it; tramways eliminated from this area. New buildings should be of an educational and recreational character here; business and commercial buildings gradually removed outside this area.

"Churches and important monuments should be left free standing, removing undesirable construction that has been built over a period of years right next to them. This would allow for open spaces and would harmonize and enhance the architectural value of these monuments. This area should be surrounded by four boulevards forming a frame. Large ring boulevards should also be built. The system of north and south main arteries should be widened to at least 120 feet, possibly with a section like that of Paseo de la Reforma. An outer ring boulevard should also be built even wider, with parks.

"A system of parkways should also be developed wherever two parallel important arteries are found, and we have five cases of these. Longitudinal parkways should be built between these parallel arteries. Decentralization should take place and many civic centers created.

"The War Department should be moved to Chapultepec Heights where its hospital is. The National University should have a new campus and buildings on the volcanic rock region of the Pedregal of San Angel.

"The Department of Education should formulate

a program, so that all people, young and old, have schools and playgrounds, no more than a distance of one-half mile for all the children, and grade crossings for their safety.

"The excess overflow water canals could be turned into rapid transit freeways. The main central passenger and freight stations should be placed in the north central section. Industrial zoning is required. Important public housing should be subsidized to replace all slums; airports extended to provide for increasing airplane traffic.

"A legislative center with all courts and coordinated activities should be located at the contemplated new plaza at the southern end of Avenida 20 de Noviembre."

And, he added, "Have plenty of water, fountains, water works, gardens in open spaces, cultural equipment, physical education and playgrounds, recreation - with proper use of leisure time; provision for the enjoyment of the arts and fostering of spiritual values."

With these observations Carlos Contreras revealed to me how thorough a study he has made of the bright possibilities of the future, in improvements for finer, healthier cities, with higher standards for better living, work, and recreation. He has added to my admiration for the future of Mexico, which is at present a marvel of architectural contrasts.



"Sanborns," the house of tiles, in Mexico City

S. Gomez photo

ANGIER AND PROTECTION —NEW SYNONYMS

The Angier Corporation of Farmingham, Massachusetts fifty years ago was founded on a new idea, the idea engendered in the word "protection"—a protection that is now known throughout the world.

Angier emphasizes in all of its sales contacts and literature that it isn't selling paper, it is selling "protection" and each of its many products are designed to maintain that service.

"Protection" by Angier sheathes buildings and keeps moisture out of insulation in locker plants, lines portable silos on farms, safeguards machinery, motors, tools, tires, rubber horse, critical coils of wire, textiles and hundreds of other industrial products.

"Our business since its beginning," Mr. Angier said, "has been built upon the idea of protection—of safeguarding the products of industry from exposure to damage from the elements while in transit, during the processes of assembly, or in storage. In fact, the slogan of our Fiftieth Anniversary is: 'A Half Century of Protection to the Products of our Nation.'"

"Protection" which Angier manufactures is playing an important part in the war effort and covers a wide variety of products for many uses. It includes, for example, waterproof and asphalt impregnated materials for wrappers, case liners and bags. It includes greaseproof laminated materials

infused and bonded together with a synthetic resinous compound and used to prevent the most delicate oil-slushed precision instruments and parts used in airplanes from corroding while enroute to assembly plants or to points overseas. It includes huge expendable tarpaulins made of Brownskin, measuring up to fifteen feet in width and sixty feet in length which are used by the many thousands to protect boxed shipments in open storage at Army depots. It includes slit wrappings in many grades for the spiral wrapping of coils of critical wire.

1. Angier was the first manufacturer to meet all U. S. Army Air Corps requirements for a Grade A paper and is the only waterproof paper manufacturer to develop a non-corrosive, greaseproof wrapper eventually to be known as an Ordnance greaseproof barrier.

2. Angier originated waterproof tarpaulins as a substitute for those made of canvas and helped to solve a critical problem of protection for Army depots.

3. Angier was the first manufacturer to meet the Wright Aeronautical specification for the protection of critical parts against corrosion.

4. Angier originated the method and is the only manufacturer to meet the Army Engineers specification BE for the protection of critical parts.

5. Angier originated a product which meets all the tests of a greaseproof barrier and waterproof barrier and is the only manufacturer supplying it.

6. Angier is the originator and sole manufacturer of a non-corrosive, greaseproof barrier laminated to metal.

The study and solution of problems having to do with protective packaging methods and materials has always been a function of Angier engineers and, as a result, many new ideas and products, of lasting benefit to industry, have been evolved.

For example, a leading steel manufacturer asked for the development of a sheet of waterproof paper for wrapping coils of stainless steel. Since the wire was slushed in oil before wrapping, the wrapper must not contain asphalt in its construction. Angier originated a synthetic resinous product known as A-19 Grizzlybear. This has proved so satisfactory that many other steel companies have since adopted it.

Again, at the beginning of the war, replacement parts for airplane motors, and other highly finished metal parts, were corroding so badly as to be unusable when received at destination. Angier chemists and engineers went to work in cooperation with one of the leading airplane engineers and originated an infused and crinkled synthetic

(See page 33)



Besides the specialized protection that Angier has been selling to industry during the war, they also make a group of insulation building products, as shown here.

Freeways

In the October, 1940, issue of ARCHITECT AND ENGINEER appeared an article entitled "Traffic congestion, S. F. Bayshore to Be a Freeway."

Since that time the Director of Public Works and Chairman of the California Highway Commission, C. H. Purcell, has worked tirelessly on the problem of developing more freeways in the State of California.

In the 1940 article, mention was made of the famous Arroyo Seco Highway between Los Angeles and Pasadena as nearing completion.

While it is true that war, and the consequent fuel shortage intervened, the project was com-

(See page 32)

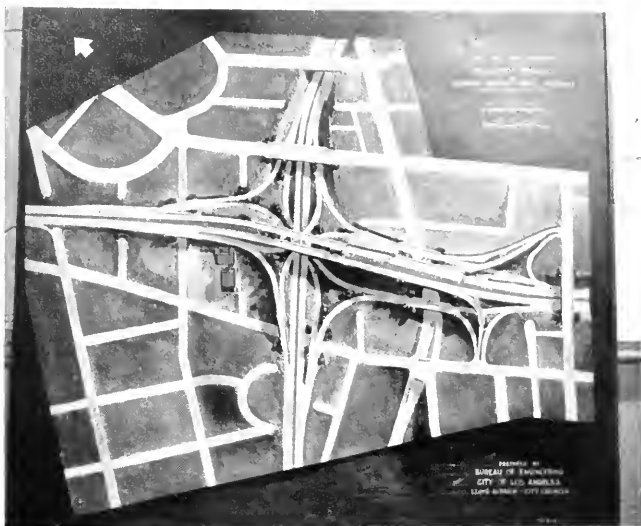

CALIFORNIA HIGHWAYS . . . Preparing for vast postwar motor vehicle traffic.



View of widened section of U. S. 101 near Atherton providing a 6-lane divided highway.

Photo courtesy California Highways and Public Works

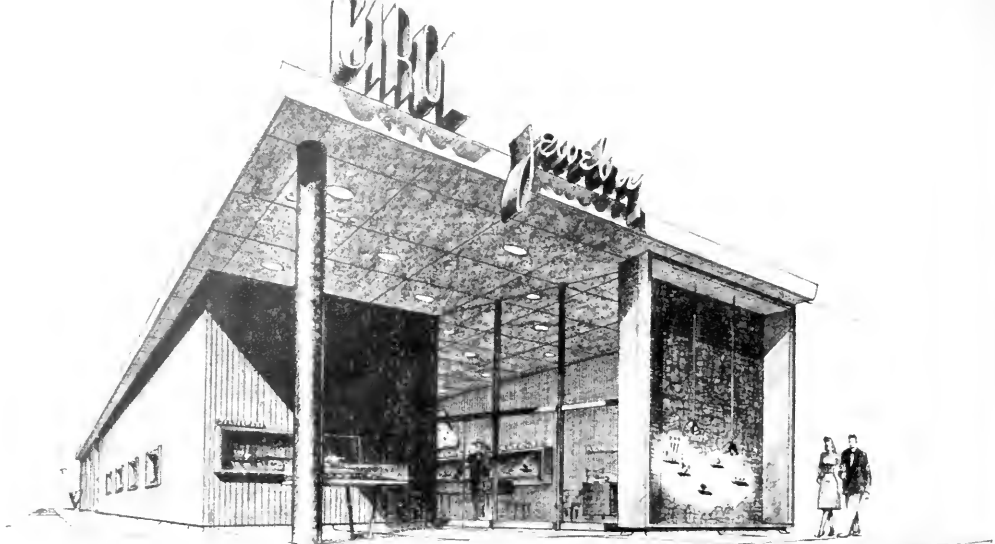

Designed for The Kawneer Co., by Ketchum, Gina & Sharp, Architects

Millions of People Will Be Attracted By Store Fronts



1900

TYPICAL OLD-FASHIONED STORE
At the turn of the century, very little was done by merchants to capitalize on the most valuable part of the store, the store-front. There was practically no window display, and entrance to the store often was made difficult.

Among the many postwar building and reconstruction opportunities offered architects and the construction industry is the almost unlimited field of building modernization, particularly as applied to the rebuilding of store-fronts in rural and metropolitan cities.

Based upon more than forty years of experience in the store-front field throughout the nation, and as a result of intensive research with outstanding authorities on store architecture and retail merchandising, the Kawneer Company of Niles, Michigan, have



1930

GOOD ARCHITECTURAL DESIGN IS ADDED. As retail competition increased, the most progressive merchants began to realize that show window space was not enough, and new store-fronts in increasing numbers were given the added appeal of good architectural design. But architectural design was not enough.

Merchants are presenting a new concept of store fronts as retail advertising.

Agreeing with experts in the field of advertising that an attractive store front is as important to the successful merchant as is a carefully considered program of newspaper, magazine, radio, and outdoor advertising, the Kawneer Company shows here two postwar designs in contrast with existent store-fronts.

Designated by the Company as "Machines for Selling," the store-front is considered as a part of the "stock-in-trade" of the store itself, and is no longer accepted as being merely a "physical" part of the building.

According to the Kawneer findings, the maximum results in new and old customers being attracted into the store can best be obtained where the specific problems of the individual stores, such as location, competition, and community habits, are carefully analyzed and a new store-front designed to meet those individual conditions.

The survey also shows that hundreds of thousands of merchants who have taken advantage of large show windows since the Kawneer Company originated the "Store-Front" in 1905, have not only successfully attracted customers, but, individual and gross sales have increased.

Working with architects, through more than 250 local distributors throughout the country, the organization is emphasizing the tremendous favorable possibilities in postwar commercial trade by bringing up to present and future standard the store-fronts of America just as soon as wartime restrictions are lifted.

Designed for The Kawneer Co., by Ketchum, Gina & Sharp, Architects



FREEWAYS

(From page 29)

pleted and the people of California were shown what a freeway could do toward the relief of congested traffic.

Many people travel several miles farther to their homes via the freeway and still reach their homes in considerably less time than a shorter route would take them. It should not take a lot of publicity to convince the public of the enormous value of freeways to relieve congested traffic conditions.

In Los Angeles the City Engineer's Department is hard at work doing all they can to cooperate with the Department of Public Works and the Division of Highways and they are making good progress. Of course they have an example with which to demonstrate, but other cities, not only in California but throughout the country, can learn much from their work. As a matter of fact not a city in the Union has as complete a plan for a freeway system as that worked out for the Los Angeles metropolitan area. In San Francisco Mr. L. Deming Tilton and the City Planning Commission are hard at work on the same problem and it is to be hoped that other cities in the State are doing the same.

The establishment of properly designed freeways involves the introduction of many factors other than engineering. It may call for rezoning, regulations of architectural character, landscape planning and sanitary problems but primarily it calls for getting behind your Department of Public Works, your Division of Highways and your City Planning Commissions.

COLOR WELDING FILM

Realizing that the most effective use of arc welding requires a knowledge of why metals expand and contract when they are heated and cooled, and how to prevent or control distortion, The Lincoln Electric Company has announced a 16mm sound, color, motion picture designed to make this technical subject easy to understand.

Three simple rules are dramatically presented in the films: (1) Reduce the effective shrinking force, (2) Make shrinkage forces work to minimize distortion, and (3) Balance shrinkage forces with other forces.

The film was produced for schools, colleges, technical societies, factories, shipyards and industrial groups.

FOREST INDUSTRIES BLAZE NEW TRAILS

An interesting story of wood's usefulness to man is contained in a brochure published recently by the Timber Engineering Company of Washington, D. C.

Wood, according to the report, is capable of being made universally useful as an engineering

medium and is also one of the basic raw materials used in the development of plastics and chemicals, which in itself offers untold future development.

Objective of the publication is to stimulate further research in wood and its natural properties.

The plan for 152 Family Dwelling Unit project, designed by L. J. Sharp, Earl R. MacDonald & A. C. Williams, was let to Claude T. Lindsay for \$344,587.

POST-WAR LAUNDRY EQUIPMENT

Few industries have taken a greater "war beating" than has the field of commercial and institutional laundering.



W. H. Gerald studying Troy "Photo Plan" layout.

Manufacture of new machinery, except for the armed forces, has practically ceased during the past four years and present equipment has been burdened by work of colossal proportion. There is hardly a laundry in the United States that does not need replacement when materials are released and laundrymen are going to do a complete job of rearrangement and streamlining of their plants.

Sketches, rough plans and blueprints utilizing scale models of laundry machines and equipment to fit any individual floor arrangement and space limitations are already available by the Troy Laundry Machinery Division of American Machine and Metals, Inc., East Moline, Illinois.

SCIENTIFICALLY DESIGNED FAN BLADE

Capable of handling large volumes of air at minimum noise level and designed with either 2 or 4-blade propellers the Trane Company of La Crosse, Wisconsin, announces an enlargement in its line of propeller-type fans.

Belt and direct driven fans are now available on a new cradle type mounting which permits operation without interference with the air stream.

ANGIER AND PROTECTION

(From page 28)

resinous product known as the "Inhibitive Dual Wrapper"—later shortened to Induwrap, an all purpose wrapper which inhibited corrosion—killed it before it had a chance to start—and for practically all airplane parts manufacturers is doing a protective job that formerly required, with less success, several wrappers.

It is recognized in government and military circles that Angier chemists and engineers pioneered in the development of corrosion preventive Ordnance wrappers, setting the high standard around which government specifications have been built.

Proofs are many that any metal part that has been properly cleaned and preserved before wrapping in either Induwrap or A-19 Grizzlybear will arrive at destination uncorroded and in usable condition.

As further protection against the weather, Angier engineers originated a waterproof expendable tarpaulin, made of Brownskin, a well-known Angier protective product. Canvas is scarce and has other important uses. Brownskin tarpaulins, according to army authorities, are rendering an outstanding service by releasing the comparatively limited supply of canvas for other uses.

STEEL IN THE WEST

According to the Los Angeles Chamber of Commerce, Steel Companies here should establish western steel prices based upon the cost of production at western mills instead of the present system of basing prices on eastern production costs plus real or arbitrary freight charges.

They contend that steel prices in the West must be lowered to a level comparable with prices paid in other industrial centers of the Nation and the transfer of the mills to private operation should not be made without statements of price policies to be followed by private operators, and those policies should ban "phantom freights" or other factors not related to actual costs.

SORRY

DOUGLAS DACRE STONE & LOU B. MULLOY, architects, were not mentioned in the article of last May on the Permanente Foundation Hospital through the lack of that information in the office of the editor. Mr. Stone and Mr. Mulloy were consulting architects representing the Federal Works Agency and had the editor been aware of that fact their names would most assuredly have been displayed for they are names that will add merit and strength to any article dealing with architecture.

—Ed.

Elmore G. Ernst and J. Upton Cloudsley, architects, of Stockton, California, have received bids for the general contract for the construction of 223 family dwelling units and 50 trailer units.

HANDICAPPED HOMES

The two-wire electrical service equipment, with Number 14 wire, barely getting by in the average home today, will be entirely inadequate to provide for greatly increased electrical demands of the postwar home.

To enjoy all the comforts and conveniences of electrical living, homeowners of 194X will want the newest in air conditioning, television, illumination, electrical refrigerators, ranges, dishwashers, laundry equipment and dozens of other home appliances—all requiring sufficient power for satisfactory, economical and safe operation. When that day comes inadequately wired homes will be obsolete, whether they are old or new. They will be handicapped from the standpoints of liveability and saleability.

That is why architects and builders today are specifying wiring of sufficient size, more convenience outlets, more circuits and better switching — a complete electrical "Service-entrance" for all future needs.

Don't permit your clients to handicap their homes of the future with wiring of the past. Insist on "Adequate Wiring" as a first requirement.



NORTHERN CALIFORNIA
ELECTRICAL BUREAU

1355 Market Street

San Francisco 3



IN THE NEWS

ENGINEER BATTALION BUSY

The bridgehead at Remagan was less than a day old when the 291st Engineer Combat Battalion, commanded by Lieutenant Colonel David E. Pergrin of Clairton, Pennsylvania, got orders to put up the first bridge to cross the Rhine.

"You are to commence construction of a Ponton Bridge across the Rhine at midnight," the orders read.

It was a thrilling, history-making assignment.

At 10 p.m. Colonel Pergrin called his company commanders together and gave them the news. It was the biggest, toughest, most important mission they had ever received, as by morning the Germans had begun shelling the bridge area.

Reports show that it took two days and two nights to build this bridge which proved invaluable to the defeat of Germany, a record accomplishment for any engineering outfit.



When you use BROWNSKIN building paper, you are assured of everlasting sheathing protection. BROWNSKIN meets every sheathing paper requirement.



BROWNSKIN S-T-R-E-T-C-H-E-S. Its special creping resists stress and strain to protect from tearing and shrinkage.



BROWNSKIN resists moisture. Its laminated, bituminous compound, impregnated composition repels water to protect from rot and deterioration.



BROWNSKIN is weathertight. Its laminated kraft paper and special treatment give tough resistance to sun and wind.

BROWNSKIN withstands vermin. Each layer's bituminous impregnation and the asphalt bond between deter silverfish, weevils and other paper consuming insects.

BROWNSKIN checks fungi. Its special treatment with bituminous compound and asphalt also prevents the growth of destructive fungi.

Only BROWNSKIN combines all these protective qualities. There are three kinds of BROWNSKIN for different uses. Ask your dealer about them.



HAYWARD INDUSTRIES EXPAND

Hayward Industries of Los Angeles has announced acquisition of the Security Valve Corp, manufacturers of Sentinel Earthquake operated Gas Shut-off valves and other safety and protective devices.

Operation of the company under the Security Valve Company name will continue with F. W. McRae as Sales Manager and R. W. Arnett, General Manager.

Production is under way at the Hayward plant and the "Sentinel," "Defense," and "Security" lines of gas and liquid shut-off valves are available for immediate delivery.

"Sentinel" Earthquake valves are designed to eliminate the hazard of fire resulting from gas pipes ruptured during earthquakes, explosions, floods and accidents. All public schools in Los Angeles, Glendale, Alhambra, Beverly Hills and Long Beach are equipped with this safety factor for the protection of children and teachers in times of seismic disturbances.

A SUBSCRIBER WRITES

15 June, 1945

PW Camp

Trinidad, Colorado

Architect and Engineer,
Subscription Dept.,
68 Post St., San Francisco.
Gentlemen:

Enclosed find money order for \$3.00, for a one year subscription to the Architect and Engineer. In order to avoid any unnecessary changes in address and delay in receiving the Architect and Engineer, I would like to have it mailed to my home address which is given below. From there it is forwarded to wherever I may be stationed.

The Architect and Engineer will be very valuable in helping to keep me posted on new ideas and developments in the building business. This information will prove invaluable to me when I am again returned to civilian life and building. (Gen. Contractor and Builder.)

Sincerely,
Ernest P. Ruggieri.



Quality Products Since 1895

ANGIER SALES CORPORATION

Framingham, Massachusetts

PACIFIC COAST OFFICE: 116 NEW MONTGOMERY ST., SAN FRANCISCO 5, CALIFORNIA

DISTRIBUTORS

WESTERN ASBESTOS CO., SAN FRANCISCO
LOCKWOOD WAREHOUSE CORP., SEATTLE
BUILDING SUPPLIES, INC., SPOKANE

WARREN & BAILEY CO., LOS ANGELES
MASON'S SUPPLY CO., PORTLAND
R. W. FRANK & CO., SALT LAKE CITY



HISTORIC CALIFORNIA FLAG GIVEN TO FRANCE IN 1922

Hanging on the gates of the Palace of the Legion of Honor in Paris is shown the Bear Flag of California, the gift of Mrs. Alma de Bretteville Spreckels. When this picture was taken in 1922, the Legion of Honor was holding an exhibition of the gifts of the Government of France to the California Palace of the Legion of Honor, then being built in San Francisco by the late Adolph B. Spreckels and Mrs. Spreckels. The building was dedicated on Armistice Day, 1924, in memory of the California heroes who died in World War I.

The gift of the Bear Flag to France was told by Mrs. Spreckels recently when she accepted a Bear Flag for the California Palace of the Legion of Honor, a gift of the San Francisco Women's Chamber of Commerce.

PLASTIC UPHOLSTERY

An extensive new line of plastic upholstery for civilian use which will provide designers and manufacturers with upholstery material that is both waterproof and flame-

proof, has been announced by United States Rubber Company. The plastic upholstery, known as Naugahyde, will be made in a wide range of light and bright, clear decorative colors and even two-tone effects as well as in a variety of grains. It will not be affected by perspiration, salt water, alcohol, gasoline, oils, greases, most acids and alkalis and can be cleaned with soap and water.

Over a million yards have been made and tested in severe military applications. The upholstery was adopted by the Navy as mandatory equipment for all Navy combat ships and is used for seating in all types of motorized war equipment, including combat tanks, trucks and jeeps. In bombers, fighters and transport planes, it is used for turret and wall lining as well as seat covering.

The new plastic upholstery will be practical for use in civilian furniture, trucks, theatre seats, railroads, automobiles, airplanes, boats, restaurants, and night clubs.

Real Estate Loans



F. H. A. loans are readily available on existing homes up to 80% of the appraised value. You can buy a home and pay for it in small monthly installments like rent. For example, a 20-year loan of \$4000 would cost about \$33.71 per month, including taxes, insurance, principal and interest.

*Come in and talk with us.
We can help you get the home you want.*

CROCKER FIRST NATIONAL BANK
OF SAN FRANCISCO
California's Oldest National Bank
ONE MONTGOMERY STREET
Member Federal Deposit Insurance Corporation

"KIMSUL" Controlled Insulation!

THERMAL EFFICIENCY 0.27

Compressed in rolls for shipment and to save storage space, it stretches out over 5 times and when fully stretched gives a uniform designated thickness which insures the same maximum insulation value at all points.

Fire, Moisture and Vermin Resistant
Extremely Light, Clean and Easy to Install.

GUNN, CARLE & CO.
20 Potrero Avenue
San Francisco 3
UN 5480

WITH THE ENGINEERS

MATERIALS FOR CONSTRUCTION

The Associated General Contractors of America hold that the general public is looking to the construction industry to cushion conditions by spreading employment and stimulating business activity during the transition from war to peacetime conditions. Hence all sections of the construction field have an obligation which requires the marshaling of forces.

The number one problem undoubtedly is in regard to the replenishment of the stocks of construction materials.

Unless these depleted stocks are replenished, construction will not be able to play the vital role that has been assigned to it in the period when other industries are retooling and reconverting to civilian production.

Obviously there is a definite need for more realistic attention to the needs of the construction industry both for the immediate future and with a view to its potential economic contribution to the post-war period and its capacity to supply the pent-up demands for new construction after the war.

In just a few days the U. S. Engineers will have their bids on the estimated \$5,000,000 plans prepared by H. J. Brunner, Engineer, for a lot of construction work in Sacramento County.

THE DINWIDDIE CONSTRUCTION COMPANY was the low bidder (\$546,972) for the Alameda job for engine Test Cells 1 to 4, for the U. S. Bureau of Yards and Docks.

\$550,000 BONDS HAVE BEEN VOTED for a new gymnasium, swimming pool, and sundries in Petaluma, Sonoma County, California.

Two of the Hunters' Point Projects of William H. Knowles, A.I.A., and Fred Langhorst, A.I.A., have been awarded to bidding contractors. The 205 unit project went for \$405,452 and the 80 unit project was awarded for \$185,534.

NEW PARADISE INN, PHOENIX

(From Page 17)



Spacious dining room at Paradise Inn

outlines of old Camel Back Mountain in the background.

The interior is treated in the same frank, direct way resulting in a cool and pleasing atmosphere. The project is not completed in all its details for there is residence capacity at present for about fifty guests which will be developed to one hundred and fifty as soon as possible. As soon as labor conditions ease up sufficiently the construction of fifty bungalows will be started, in which they will, no doubt, continue the same appropriate and charming style architectural concrete.



Enjoying Arizona sunshine at Paradise Inn, Phoenix

A. I. A. ACTIVITIES



HENRY H. GUTTERSON has retired as Regional Director and Mr. Earl T. Heitschmidt has been named Regional Director for the Sierra Nevada District. At Atlantic City during the A.I.A. convention on the 24th of April, last, Gutterson distinguished himself with his usual clear thinking and hard work and set a record for his successors to shoot at.

The new bulletin of the Northern California Chapter has come out for May, 1945.

It covers a wider field than formerly and is really an accomplishment. For instance, there is information as to costs of construction, legislative bills, and other data not formerly contained in the bulletin in so clear a form. The speculative builders are working on a cost estimate of \$5.75 per square foot while "bids received on plans prepared by architects have run from \$6.00 to \$10.00 per square foot." This item, just quoted from the bulletin, goes on to say that "The house normally figured in 1940 at \$4.25 per square foot can now be figured at \$6.25 per square foot."

It was interesting also to read that "it would appear that the cost of construction of hospitals varies between \$6,000 and \$8,000 per bed. To this can be added equipment costs, which is roughly \$1,000 per bed."

The first half of the monthly meeting, held June 1st, was taken up by reports and affairs of the Institute Convention at Atlantic City. The second half was given over to a talk, illustrated with lantern slides, by Dr. C. A. DOXIADIS, architect, and advisor to the Greek Delegation of the UNCIO. He told of the underground system that was organized in Greece and illustrated on the screen the terrible devastation in Greece and the dire need of reconstruction help.

ALBERT C. MARTIN, A.I.A. of Los Angeles, in consultation with Architect Samuel Marx of Chicago, is working on a store expansion plan estimated to cost \$10,000,000.

JOHN S. GOULD, architect, has completed his working drawings for the \$40,000 addition to the Colusa Court House.

RICHARD H. PLEGER, architect, has moved from 656 "G" Street, Boulder City, Nevada, to 1246 Summit Avenue, Pasadena, California.

APPLYING STAINLESS STEELS TO LIGHTWEIGHT STRUCTURES

By RUSSELL FRANKS, Chief Metallurgist

Union Carbide and Carbon Research Laboratories, Inc.

In post-war construction the design engineer will unquestionably emphasize lightness in weight in selecting structural materials, and it is generally conceded that stainless steel has a big stake in the "lightweight construction picture."

Two modifications of the 18 per cent chromium, 8 per cent nickel type of stainless steel, commonly known as "18-8", have been generally applied in lightweight structures—one containing approximately 17 per cent chromium and 7 per cent nickel and the other containing approximately 18 per cent chromium and 8 per cent nickel. The high strength of these steels is obtained by the application of cold-work, such as the cold-rolling of sheet and strip and the cold-drawing of bars, rods, and wire. It has been found that subjecting cold-rolled strip to a low-temperature heat-treatment, that is from about 390 to 530 degrees Fahrenheit, will improve the yield strength of the steel without reducing its ductility.

Retention of toughness at subnormal temperatures is, of course, a major requirement for materials to be used for lightweight structures. Thin sections of both the 17-7 and 18-8 stainless steels can be bent through 180 degrees at all temperatures down to -300 degrees Fahrenheit without failure. Furthermore, thick sections of the steels exhibit high impact values under the same conditions; they do not become brittle at the low temperatures. In both the cold-rolled condition and after application of low-temperature heat-treatment, relatively high fatigue strength has also been noted.

In regard to durability, which is another essential characteristic of materials for high-strength structures, few materials are equal to the 17-7 or 18-8 stainless steels so far as resistance to atmospheric corrosion is concerned. The steels have been exposed for many years to all kinds of atmospheres, including city, suburban, rural, and marine; and they have served admirably in all applications. Since the surfaces of the cold-rolled stainless steels are comparatively hard, they do not wear away rapidly when abraded with grit and dust particles; on the contrary, they tend to work-harden and become more abrasion-resistant.

All the commonly employed welding processes are applicable in fabrication of these stainless steels and the welds are ductile and tough provided they are properly made.

DONALD R. WARREN CO., ENGINEERS, announce the transfer of Mr. Carl E. Nelson and Mr. James M. Fox to their San Francisco offices.



QUALITY AND DEPENDABLE *Service*

are the factors that influence architects and contractors when selecting lumber and mill work — Quality of merchandise — Integrity and Ability of the firm—Service in physical equipment — Experience and Personnel — All these factors contribute to a speedy and satisfactory completion of construction with minimum of time and expense.

MANUFACTURER OR DEALER IN

Douglas Fir—Redwood—Sugar and Ponderosa Pine — Plywood and Concrete Form Panels — Sash and Doors — Millwork — Insulation — Builders' Hardware.

E. K. WOOD LUMBER CO.

"Goods of the Woods" ©
LOS ANGELES • SAN FRANCISCO • OAKLAND

*Be sure you're getting the
finest window glass obtainable*

it costs no more to specify

PENNUERNON

Distributed by...

W. P. FULLER & CO.

PAINTS • GLASS • WALLPAPER

it's
FLATTER
CLEARER
BRICHTER

Pennuernon
flat drawn
WINDOW GLASS

HOME VALUATION PLAN

To expedite the resale of existing homes, The Producers' Council has recommended that the National Housing Act be revised to permit down payments on older homes to be as low as those on new dwellings and to authorize the FHA to extend as much loan insurance on existing dwellings as on new construction.

"The presumption that older houses offer a greater investment risk than new ones is not correct, provided there is a realistic valuation of the properties, provided the life of the mortgage is adjusted to the condition of the dwelling, and provided the same rules of eligibility are observed in making the loans," Irving W. Clark, Chairman of the Council's Residential Committee, explained.

PLYWOOD HANDBOOK

The UNITED STATES PLYWOOD CORPORATION has come out with a booklet entitled "PLYWOOD HANDBOOK OF RESIDENTIAL CONSTRUCTION." It is timely, enlightening and of real value to anyone over the drafting board, whether they are in an architect's office or at the kitchen table.

Most people stumble over, or stop at, the problem of how to accommodate a double hung window to a plywood wall. They cannot see how to hang a door in a plywood partition. Half the time they cannot even see how you can make a plywood house stand up. Of course, the architect will know how to solve all these questions, but if the Plywood Corporation is to get the people "plywood minded" they must make it clear to the layman, and that is just what this book does and does it well.

Installation of windows, doors and cabinets in plywood walls and partitions are well shown, proving that such a house is not necessarily flimsy.

Plywood interiors that might be the envy of a palace tenant are shown. Things like inside corners, outside corners, interior linings and garage doors are shown to be so simple that one wonders why we don't all build in plywood. In the West, where the difference between summer and winter temperatures is not so much of a problem, there will be more plywood houses if more people can get their hands on this booklet.

"TODAY'S IDEA HOUSE"

Designed to meet the public need for information in conjunction with the construction of homes, and as an aid in home planning, an illustrated booklet has just been issued by the Ponderosa Pine Woodwork, Chicago office.

The booklet presents many suggestions in home construction, doors, windows, closet and storage space, and ideas for greater convenience and home comfort.

PRODUCERS' COUNCIL PAGE

Northern California Chapter

The National Organization of Manufacturers of Quality Building Materials and Equipment
Affiliated with the AMERICAN INSTITUTE OF ARCHITECTS



E. P. "ERDIE" LARSON

Active "Ernie" Larson very soon got into a job in Chapter affairs after his company, The Celotex Corporation, joined the Producers' Council. He is this year serving on the very important Program Committee.

Ernie is another young man who followed the "Go West" admonition and cast his lot with the "Golden State". Born in Springfield, Massachusetts, he attended New Rochelle Preparatory School in New York State, Columbia University and Valparaiso University, Valparaiso, Indiana, where he organized the University golf team and played varsity football. He, of course, also studied while there, his course being Business and Finance.

For the past nine years he has been with Celotex in San Francisco. Prior to that he was with the Dodge and Plymouth Dealers in Martinez.

Married, but with no children, Mrs. Larson is active in Red Cross and social work in which she has a Masters degree.

For sports and hobbies, Ernie likes fishing and golf, which he shoots in the low eighties, and unless we miss our guess, come V-J Day, Ernie will be active in reviving Council golfing activities.

Ernie is also a member of Educator Lodge F. & A. M., San Francisco.

H. G. R. SCHICKELE, President of the San Francisco Architectural Club, did a bang-up job of acquainting our June meeting with the problems and aspirations of the draftsman and "architect-to-be."

Rounding out the program of mutual acquaintance and understanding, **John Bolles**, President of the California Council of Architects, spoke on the Unification program.

Andy Hass, President of the Northern California Chapter of the A.I.A., spoke on "Architectural and Producers' Council Relationships," and

"Chuck" Kraft, Regional Director of the Council, filled in with background information on the "Origin and Growth of the Producers' Council."

GRASS ROOTS educational program for representatives of Producers' Council members interested in Modular Coordination is in prospect. Upon these men depends the job of getting down to cases with Modular designed products, and according to present plans, an opportunity to acquaint themselves with the details of how it works will soon be offered by the Chapter. This will enable each representative to answer questions of architects and draftsmen as to how their products fit with that of other manufacturers in building layout.

We Don't Claim we did it, but the fact remains that the "Start An Architect . . ." campaign has been in the groove and today Architects are plenty busy with plans and are hollering for help.

AFTER ALL, our slogan has always been: "Use Quality Materials—Consult An Architect."



USE QUALITY PRODUCTS



CONSULT AN ARCHITECT

BOOK REVIEWS

BABEL'S TOWER. By Francis Henry Taylor. Columbia University Press. \$1.00.

A review of this delightful little book should more properly appear in "News and Comment on Art" in another section of this issue, but any book, no matter how small, that is written by the Director of the Museum of Art of New York belongs on a review page.

The book deals principally with the problems of the museums and their obligations to society, but there are many pithy passages which bear repetition. For instance, he states that "The museum and the library have been called the two halves of the public's memory of the past," and that "The art museum is nothing more than a gymnasium for the development of the muscles of the mind."

The book is good reading besides being a 53-page presentation of the problem of the Museum and should be on the shelves of every Museum Director in the land.

FIRE PROTECTION THROUGH MODERN BUILDING CODES. By B. L. Wood, Consulting Engineer. The American Iron and Steel Institute, 350 Fifth Ave., New York 1, N. Y.

Apparently the book is to be had for the asking by addressing the Institute and it is well worth writing for. The first 110 pages are devoted to the considerations of codes, hazards, types of occupancy, maximum allowable floor areas and many other phases that are invaluable to architect and builder. The remaining 100 pages are taken over by indexes and similar data.

The American Iron and Steel Institute deserves the gratitude and thanks of all engineers and architects for bringing out this book and for the other similar books which they are preparing to make available.

SMALL HOMES OF TOMORROW. By Paul R. Williams, A.I.A. 95 pages, 40 full page plates. Published by Murray & Gee, Inc., Hollywood 18, California. De Luxe edition, \$3.00; flexible paper bound edition, \$2.00.

The title "Small Homes of Tomorrow" is apt to lead one to the erroneous conclusion that it is a book of modern designs, one of those that are flooding the market. That is wrong on two counts, for while the book is modern it is so because it is logical in a clear way of treating an old subject and it is **not** one of those "modern design books" that are flooding the market. In fact

(See Page 42)

STANLEY HARDWARE for Restaurant Construction

As communities are freed from wartime building restrictions, the foresighted architect will specify Stanley Hardware for every building project. Experience proves that, for handsome appearance, efficient performance and long service, the broad variety of Stanley Hardware satisfies every choice and meets every price requirement. The Stanley Works, New Britain, Connecticut.

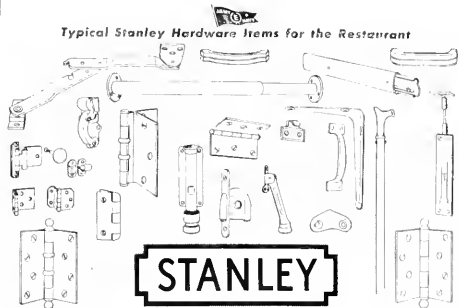

PRESSURE TREATED LUMBER
● **PROTECTS AGAINST DECAY
AND TERMITE ATTACK**

*Specify it in your home
Available through Lumber Dealers*

LOS ANGELES
601 W. 5th Street
Phone MIchigan 6294

SAN FRANCISCO
333 Montgomery Street
Phone DOuglas 3883

J. H. Baxter & Co.

AGENTS FOR WEST COAST WOOD PRESERVING CO. SEATTLE, WASH.

IN THE NEWS

TIMELY NEWS FOR THE CONTRACTORS

Released by the Department of Public Works of the STANDARD SPECIFICATIONS for the Division of Highways, State of California.

The book contains 330 pages of accurate information and will be all but indispensable to anyone figuring on bidding for work to be done under the State specifications. Fifty-one pages are devoted to General Provisions and two hundred eighty pages are given over to Construction Details. The issue is most timely, for during the next few years it will be all but a bible to many contractors who will take advantage of the coming rush of work.

ARCHITECTS J. FRANCIS WARD AND FRANCIS J. McCARTHY are well along with their 110 unit plan for housing in San Francisco. The contract for their Hunters' Point project was awarded to De Luca and Son for \$243,600.

"SMALL HOMES"—BOOK REVIEW

(From Page 41)

It is unique in that every plan and perspective in the book is good and is presented in beautiful drawings in a clear and logical manner. The whole series is so lovely that one finds it difficult to decide which plan he thinks is best.

Plans of the houses and gardens are done to scale, apparently all drawn by Mr. F. W. Jamison in an excellent style and accuracy pervading the entire book with a feeling of unity. On each plan is indicated the number of square feet occupied by the structure.

Nor are the beautifully drawn plans and perspectives all that recommends the book. In the text the author has succinctly presented most of the problems that confront the designer of residences today and what we must face in the form of new materials and devices. The column of "Do's and Don't's" is worth memorizing. At the end of the book are two pages from the "Architect's Notebook" that form the most informative recapitulations that have come out in print.

All in all, Mr. Williams has brought out a book that is a delight, both as a book on architecture and as a reference book, and before long it will be found on the shelves of architects and builders who are interested in the subject, and in the collections of lovers of good books generally.

HOGAN LUMBER CO.

Wholesale and Retail

LUMBER

MILL WORK • SASH & DOORS

Office, Mill, Yard and Docks

SECOND AND ALICE STREETS • OAKLAND, CALIF.

Telephone GLencaurt 6861

MALOTT & PETERSON

ROOFING AND FLOORING
CONTRACTORS

20TH AND HARRISON STREETS

SAN FRANCISCO

Phone ATwater 1600

CLINTON CONSTRUCTION CO. OF CALIFORNIA

General Contractors

923 FOLSOM STREET • SAN FRANCISCO

SUtter 3440

SANTA MARIA INN

SANTA MARIA, CALIFORNIA

FRANK J. McCOY, General Manager

FERNAND E. PIMENTEL, Manager

On the
Coast
Highway
between
San
Francisco
and
Los
Angeles



American
or
European
Plan
•
Old
English
Tap
Room

ARCHITECT AND ENGINEER

Estimator's Guide

Giving Cost of Building Materials, Etc.

AMOUNTS GIVEN ARE FIGURING PRICES AND ARE MADE UP FROM AVERAGE QUOTATIONS FURNISHED BY MATERIAL HOUSES TO SAN FRANCISCO CONTRACTORS. 2½% SALES TAX ON ALL MATERIALS BUT NOT LABOR

All prices and wages quoted are for San Francisco and the Bay District. There may be slight fluctuation of prices in the interior and southern part of the state. Freight cartage, at least, must be added in figuring country work.

BONDS—Performance—50% of contract.

Labor and materials—50% of contract.

BRICKWORK—

Common Brick—Per 1M laid—\$50.00 to \$60.00 (according to class of work).

Face Brick—Per 1M laid—\$120 to \$150 (according to class of work.)

Brick Steps—\$1.60 per lin. ft.

Brick Veneer on Frame Bldg.—Approx. \$1.30 per sq. ft.

Common Brick—\$19.00 per M, truckload lots, f.o.b. job.

\$19.00 per M, less than truckload, plus cartage.

Face Brick—\$40 to \$80 per M, truckload lots, delivered.

Cartage—Approx. \$4.00 per M.

BUILDING PAPER—

1 ply per 1000 ft. roll.....	\$3.50
2 ply per 1000 ft. roll.....	5.00
3 ply per 1000 ft. roll.....	6.25
Brownskin, Standard, 500 ft. roll.....	5.00
Sisalcraft, 500 ft. roll.....	5.00
Sash cord com. No. 7.....	\$1.20 per 100 ft.
Sash cord com. No. 8.....	1.50 per 100 ft.
Sash cord spot No. 7.....	1.90 per 100 ft.
Sash cord spot No. 8.....	2.25 per 100 ft.
Sash weights, cast iron, \$50.00 ton.	
Nails, \$3.42 base.	
Sash weights, \$45.00 per ton.	

CONCRETE AGGREGATES—

The following prices net to Contractors unless otherwise shown.

Gravel, all sizes—		
\$1.95 per ton at Bunker; delivered	\$2.50	
	Bunker	Del'd
Top Sand	\$1.90	\$2.50
Concrete Mix	1.90	2.45
Crushed Rock, ¼" to ¾".....	1.90	2.50

Crushed Rock, ¾" to 1½".....	1.90	2.50
Roofing Gravel	2.25	2.80
River Sand	2.00	2.45

Sand—

River Sand	2.00	2.45
Lapis (Nos. 2 & 4).....	2.85	3.15
Olympia (Nos. 1 & 2).....	2.85	3.10
Del Monte White	84c per sack	

Cement—

Common (all brands, paper sacks), carload lots, \$2.42 per bbl. f.o.b. car; delivered \$2.72. Cash discount on carload lots, 10c a bbl., 10th Prox.; less than carload lots \$3.20 per bbl. f.o.b. warehouse or delivered. Cash discount 2% on L.C.L.

Atlas White	} 1 to 100 sacks, \$2.50 sack warehouse or del.; \$7.65 bbl. carload lots.
Calaveras White	
Medusa White	

Forms, Labors average \$200.00 per M.

Average cost of concrete in place, exclusive of forms, 35c per cu. ft.; \$10 cu. yd.; with forms, 60c.

4-inch concrete basement floor	30c per sq. ft.
Rat-proofing	7½c
Concrete Steps.....	\$1.25 per lin. ft.

DAMP-PROOFING and Waterproofing—

Two-coat work, \$3.50 per square. Membrane waterproofing—4 layers of saturated felt, \$7.00 per square.

Hot coating work, \$2.50 per square.

Medusa Waterproofing, \$3.50 per lb. San Francisco Warehouse.

Tricocel waterproofing.
(See representative.)

ELECTRIC WIRING—\$12 to \$15 per outlet for conduit work (including switches).

Knob and tube average \$3.00 per outlet. (Available only for priority work.)

ELEVATORS—

Prices vary according to capacity, speed and type. Consult elevator companies. Average cost of installing a slow speed automatic passenger elevator in small four story apartment building, including entrance doors, about \$6500.00.

EXCAVATION—

Sand, 60 cents; clay or shale \$1 per yard. Teams, \$12.00 per day.

Trucks, \$22 to \$27.50 per day.

Above figures are an average without water. Steam shovel work in large quantities, less; hard material, such as rock will run considerably more.

FIRE ESCAPES—

Ten-foot galvanized iron balcony with stairs, \$150 installed on new buildings; \$160 on old buildings.

FLOORS—

Composition Floor, such as Magnesite 33c to 50c per square.

Linoflor—2 gages—\$1.25 to \$2.75 per sq. yd.

Mastapay—90c to \$1.50 per sq. yd. Battleship Linoleum—available to Army and Navy only—⅙"—\$1.75 sq. yd. ⅜"—\$2.00 sq. yd.

Terazzo Floors—50c to 70c per square. Terazzo Steps—\$1.75 per lin. ft. Mastic Wear Coat—according to type—20c to 35c.

Hardwood Flooring—

Standard Mill grades not available.	
Victory Oak—T & G	
⅜" x 2¼".....	\$143.25 per M. plus Cartage
½" x 2".....	122.00 per M. plus Cartage
½" x 1½".....	113.50 per M. plus Cartage
Prefinished Standard & Better Oak Flooring	
⅜" x 3¼".....	\$180.00 per M. plus Cartage
½" x 2½".....	160.50 per M. plus Cartage
Maple Flooring	
⅜" T & G Clear	\$160.50 per M. plus Ctg.
2nd	153.50 per M. plus Ctg.
3rd	131.25 per M. plus Ctg.
Floor Layers' Wage, \$1.50 per hr.	

GLASS—

Single Strength Window Glass	20c per □ ft
Double Strength Window Glass	30c per □ ft.
Plate Glass, under 75 sq. ft.	\$1.00 per □ ft.
Polished Wire Plate Glass	1.40 per □ ft.
Rgh. Wire Glass34 per □ ft.
Obscure Glass27 per □ ft
Glazing of above is additional.	
Glass Blocks	\$2.50 per □ ft. set in place

HEATING—

Average, \$1.90 per sq. ft. of radiation, according to conditions.

Warm air (gravity) average \$48 per register.

Forced air, average \$68 per register.

IRON—Cost of ornamental iron cast iron, etc., depends on design.

LUMBER—All lumber at O.P.A. ceiling prices—

No. 1 Common	\$49.00 per M
No. 2 Common	47.75 per M
Select O. P. Common	52.75 per M

Flooring—

V.G.-D.F. 8 & 8tr. 1 x 4 T & G Flooring	Delvd	\$50.00
C 1 x 4 T & G Flooring		75.00
D 1 x 4 T & G Flooring		45.00
D.F.-S.G. 8 & 8tr. 1 x 4 T & G Flooring		61.00
C 1 x 4 T & G Flooring		59.00
D 1 x 4 T & G Flooring		54.00
Rwd. Plastic—"A" grade, medium dry		82.00
"B" grade, medium dry		78.50

Plywood—

	Under \$200	Over \$200
"Plyscord"—3/4"	\$49.50	\$47.55
"Plywall"—1/4"	45.15	43.30
3 ply—2 1/2"—1/4"	48.55	46.60
"Plyform"—3/8"		
Unoaded	126.50	121.45
Oiled	127.90	122.75

Above prices delivered if quantity is sufficient to warrant delivery.

Shingles (Rwd. not available)—
 Red Cedar No. 1—\$6.75 per square; No. 2, \$5.75; No. 3, \$4.45.
 Average cost to lay shingles, \$3.00 per square.
 Cedar Shakes—Tapered: 1/2" to 3/4" x 25"—\$8.95 per square.
 Resawn: 1/2" to 1 1/4" x 25"—\$10.65 per square.
 Resawn: 3/4" to 1 1/4" x 25"—\$10.65 per square.
 Average cost to lay shakes, \$4.00 per square.

MILLWORK—Standard.

D. F. \$100 per 1000. R. W. Rustic \$100.00 per 1000 (delivered).
 Double hung box window frames, average with trim \$6.50 and up, each.
 Complete door unit, \$10.00.
 Screen doors, \$3.50 each.
 Patent screen windows, 25c a sq. ft.
 Cases for kitchen pantries 25c a sq. ft. high, per lineal ft., \$9.00 each.
 Dining room cases, \$9.00 per lineal foot.
 Rough and finish about 80c per sq. ft.
 Labor—Rough carpentry, warehouse heavy framing (average), \$40.00 per M.
 For smaller work average, \$40.00 to \$55.00 per 1000.

MARBLE—(See Dealers)

PAINTING—

Two-coat work	per yard	50c
Three-coat work	per yard	70c
Cold water painting	per yard	10c
Whitewashing	per yard	8c

PAINTS—

Two-coat work	50c per sq. yd.
Three-coat work	70c per sq. yd.
Cold water painting	per yard 10c
Whitewashing	8c per sq. yd.
Turpentine	\$1.03 per gal. in drum lots.
	\$1.08 per gal. in 5-gal. containers.
Raw Linseed Oil	—not available.

Boiled Linseed Oil—\$1.38 per gal. in drums. Available only to work with high priority—\$1.48 per gal. in 5-gal. containers.

Use replacement oil—\$1.86 per gal. in 1-gal. containers.
 Replacement Oil—\$1.20 per gal. in drums. \$1.30 per gal. in 5-gal. containers.
 A deposit of \$6.00 required on all drums.

PATENT CHIMNEYS—

6-inch	\$1.20 lineal foot
8-inch	1.40 lineal foot
10-inch	2.15 lineal foot
12-inch	2.75 lineal foot

PLASTER—

Neat wall, per ton delivered in S. F. in paper bags, \$17.60.

PLASTERING (Interior)—

3 Coats, metal lath and plaster	Yard	1.50
Keene cement on metal lath		1.80
Ceilings with 3/4 hot roll channels metal lath (lath only)		1.20
Ceilings with 3/4 hot roll channels metal lath plastered		2.20
Single partition 3/4 channel lath 1 side (lath only)		1.20
Single partition 3/4 channel lath 2 inches thick plastered		3.20
4-inch double partition 3/4 channel lath 2 sides (lath only)		2.20
4-inch double partition 3/4 channel lath 2 sides plastered		3.85
Thermax single partition: 1" channels; 2" overall partition width. Plastered both sides		3.30
Thermax double partition: 1" channels; 4 1/4" overall partition width. Plastered both sides		4.40
3 coats over 1" Thermax nailed to one side wood studs or joists		1.65
3 coats over 1" Thermax suspended to one side wood studs with spring sound isolation clip		1.90

Note—Channel lath controlled by limitation orders.

PLASTERING (Exterior)—

2 coats cement finish, brick or concrete wall	Yard	\$1.00
3 coats cement finish, No. 18 gauge wire mesh		2.00
Lime—\$3.00 per bbl. at yard.		
Processed Lime—\$3.10 bbl. at yard.		
Rock or Grip Lath—3/8"—20c per sq. yd.		
1/4"—19c per sq. yd.		

Composition Stucco—\$1.80 to \$2.00 sq. yard (applied).

PLUMBING—

From \$100.00 per fixture up, according to grade, quantity and runs.

ROOFING—

"Standard" tar and gravel, 4 ply—\$3.00 per sq. for 30 sqs. or over.
 Less than 30 sqs. \$9.50 per sq.
 Tile, \$30.00 to \$40.00 per square.
 Redwood Shingles, \$7.50 per square in place.
 5/2 #1-16" Cedar Shingles, 4 1/2" Exposure \$8.00 square

5/8 x 16"—#1 Cedar Shingles, 5" Exposure \$9.00 square
 4/2 #1-24" Royal Shingles, 7 1/2" Exposure \$9.50 square
 Re-coat with Gravel \$4.00 per sq.
 Asbestos Shingles, \$23 to \$28 per sq. laid.
 1/2 x 25" Resawn Cedar Shakes, 10" Exposure \$10.50
 3/4 x 25" Resawn Cedar Shakes, 10" Exposure 11.50
 1 x 25" Resawn Cedar Shakes, 10" Exposure 12.50
 Above prices are for shakes in place.

SHEET METAL—

Windows—Metal, \$1.75 a sq. ft.
 Fire doors (average), including hardware \$2.00 per sq. ft.

SKYLIGHTS—(not glazed)

Copper, 90c sq. ft. (flat).
 Galvanized iron, 40c sq. ft. (flat).
 Vented hip skylights 60c sq. ft.

STEEL—STRUCTURAL (None available except for defense work).

\$150 ton (erected), this quotation is an average for comparatively small quantities. Light truss work higher. Plain beams and column work in large quantities \$140 per ton.

STEEL REINFORCING (None available except for war work).

\$150 to \$200 ton, set.

STONE—

Granite, average, \$6.50 cu. foot in place.
 Sandstone, average Blue, \$4.00. Boise, \$3.00 sq. ft. in place.
 Indiana Limestone, \$2.80 per sq. ft. in place.

STONE FRONTS (None available).

TILE—

Ceramic Tile Floors—70c to \$1.00 per sq. ft.
 Cove Base—\$1.10 per lin. ft.
 Glazed Tile Wainscot—\$1.25 per sq. ft.
 Asphalt Tile Floor 1/8" & 3/8"—\$.18 to \$.35 per sq. ft. Light shades slightly higher.
 Cork Tile—\$.40 to \$.75 per sq. ft.
 Mosaic Floors—see dealers.
 Lino-Tile, \$.35 to \$.75 per sq. ft.

Wall Tile—

Glazed Terra Cotta Wall Units (single faced) laid in place—approximate prices:	
2 x 6 x 12	\$1.10 sq. ft.
4 x 6 x 12	1.25 sq. ft.
2 x 8 x 16	1.20 sq. ft.
4 x 8 x 16	1.40 sq. ft.

VENETIAN BLINDS—

40c per square foot and up. Installation extra.

WINDOWS—STEEL—

30c per square foot, \$5 for ventilators.

"BUILDING PERMIT VALUES"

(From Page 39)

Akron, Ohio	3,606,284	3,249,650
Cleveland, Ohio	3,598,500	6,969,600
Miami, Fla.	3,567,165	975,564
Baltimore, Md.	3,535,014	1,872,876
San Diego, Cal.	3,432,581	4,396,999
New Orleans, La.	3,315,508	27,687,742
Long Beach, Cal.	3,306,085	6,315,690
Memphis, Tenn.	3,268,712	2,381,315
Portland, Ore.	2,934,200	4,494,975
Tacoma, Wash.	2,865,937	1,472,585

NO DRIP TAPE

Forming a snug, sealed jacket around pipes, a pliable, cork-filled, easy to handle tape, which immediately stops damaging drip from cold water pipes has been announced by the J. W. MORTELL CO., of Kankakee, Illinois.



A product of extensive research and testing it is easily applied without tools and can completely cover fittings, valves, and pipe.

NEW GYPSUM FOLDER

An attractive illustrated folder, describing gypsum acoustical plaster, has been prepared by the Gypsum Association for distribu-

tion to those engaged in any phase of the building industry.

Stressing that gypsum acoustical plaster is fireproof, sanitary, and economical and can be had either colored or in the natural warm grey white of gypsum, the folder illustrates gypsum acoustical plaster in actual use and shows by means of a cut-away photograph how the plaster is applied and gives specifications.

A copy of the folder, entitled "Sound Absorbing Gypsum Plaster" may be obtained free by writing to the Gypsum Association, 211 West Wacker Drive, Chicago 6, Illinois.

GLASS HANGARS FOR WAR PLANES

Two types of hangars incorporating the use of glass cloth, woven of glass fiber yarns and coated with either synthetic rubber or resin, have been designed and selected by the U. S. Army Corps of Engineers for curtains, side walls and ends in newly developed airplane hangars installed at advance Army Air Forces bases.

A structural steel framework 162 feet long, 146 feet wide and 39 feet high is curtained with glass cloth, while a much smaller type known as the "nose" or "Shed type" not only has the glass curtain doors

Built-In Fixtures for the Post-War Home

Paramount Fixtures will fit your post-war needs . . . investigate our new kitchen ideas which make for convenience and efficiency.

Paramount Built-in Fixtures meet the most exacting requirements. Our "Deluxe," "Moderne" and "Economy" cabinet fixtures are distinctive in design and construction and may be had in stock sizes or built to order.

Catalog for the asking



but is also equipped with side-walls made of the same material.

The glass cloth is resistant to mould and fungus, has great strength in proportion to its light weight, and is not affected by tropical heat or Arctic cold.

1945 BUILDING TRADES WAGE SCALES (JOB SITES) NORTHERN CALIFORNIA

Six- and seven-hour day eliminated on all Government Work. A. F. L. - O. P. M. Agreement calls for eight-hour day.

NOTE: Predeterminations by the Department of Labor, as of July 1, 1944 (the wage-freezing date) have not yet been made in all of the counties listed. The wage scales shown are those being paid and in effect mostly by agreement between employees and their union.

	San Francisco	Alameda and Contra Costa	Fresno	Marin	Sacramento	San Jose	San Mateo	Vallejo	Stockton
CRAFT									
ASBESTOS WORKERS	1.50	1.50	1.25	1.50	1.50	1.25	1.50	1.50	1.25
BRICKLAYERS	1.87 ¹ / ₂	1.87 ¹ / ₂	1.75	1.87 ¹ / ₂	1.75	2.00	1.79-1.6	1.75	1.50
BRICKLAYERS' HODCARRIERS	1.40	1.40	1.05	1.40	1.05	1.50	1.35	1.50	1.14
CARPENTERS	1.50	1.50	1.25	1.43 ³ / ₄	1.37 ¹ / ₂	1.37 ¹ / ₂	1.43 ³ / ₄	1.50	1.37 ¹ / ₂
CEMENT FINISHERS	1.50	1.50	1.50	1.50	1.50	1.50	1.50	1.50	1.50
ELECTRICIANS	1.70	1.70	1.70	1.70	1.70	1.70	1.70	1.70	1.70
ELEVATOR CONSTRUCTORS	1.75 ¹ / ₂	1.75 ¹ / ₂	1.75 ¹ / ₂	1.75 ¹ / ₂	1.75 ¹ / ₂	1.75 ¹ / ₂	1.75 ¹ / ₂	1.75 ¹ / ₂	1.75 ¹ / ₂
ENGINEERS: MATERIAL HOIST	1.50	1.50	1.25	1.50	1.37 ¹ / ₂	1.62 ¹ / ₂	1.50	1.37 ¹ / ₂	1.25
PILE DRIVER	1.75	1.75	1.60	1.75	1.75	1.75	1.75	1.75	1.60
STRUCTURAL STEEL	1.75	1.75	1.60	1.75	1.75	1.75	1.75	1.75	1.60
ELEVATOR CONSTRUCTORS	1.40	1.40	1.40	1.40	1.17 ¹ / ₂	1.21	1.40	1.40	1.40
IRONWORKERS: ORNAMENTAL	1.60	1.50	1.60	1.50	1.60	1.31 ¹ / ₄	1.50	1.50	1.50
REINF. RODMEN	1.50	1.50	1.60	1.50	1.50	1.60	1.50	1.50	1.25
STRUCTURAL	1.75	1.75	1.75	1.75	1.75	1.75	1.75	1.75	1.37 ¹ / ₂
LABORERS: BUILDING	1.00	1.00	1.00	1.00	1.00	1.00	1.00	1.00	1.00
CONCRETE	1.00	1.00	.90	.87 ¹ / ₂	.95	.90	.93 ³ / ₄	.90	.90
LATHERS	1.75	1.75	1.50	1.75	1.60	1.75	1.75	1.75	1.75
MARBLE SETTERS	1.50	1.50	1.50	1.50	1.50	1.50	1.50	1.50	1.50
MOSAIC & TERRAZZO	1.25	1.25	1.12 ¹ / ₂	1.25	1.15-5-8	1.12 ¹ / ₂			
PAINTERS	1.50	1.50	1.28-4/7	1.50	1.43	1.50	1.42-6-7	1.64-2-7	1.37 ¹ / ₂
PILEDRIVERS	1.54	1.54	1.54	1.54	1.54	1.54	1.54	1.54	1.54
PLASTERERS	1.75	1.83 ¹ / ₂	1.75	1.75	1.75	2.00	2.00	1.75	1.93-1-3
PLASTERERS' HODCARRIERS	1.50	1.60	1.40	1.50	1.63 ¹ / ₂	1.50	1.75	1.50	1.50
PLUMBERS	1.70	1.70	1.53-1-8	1.70	1.68 ³ / ₄	1.62 ¹ / ₂	1.70	1.70	1.50
ROOFERS	1.50	1.50	1.25	1.37 ¹ / ₂	1.37 ¹ / ₂	1.37 ¹ / ₂	1.25	1.37 ¹ / ₂	1.37 ¹ / ₂
SHEET METAL WORKERS	1.50	1.50	1.50	1.50	1.50	1.50	1.37 ¹ / ₂	1.50	1.50
SPRINKLER FITTERS	1.58	1.58	1.53-1-8	1.70	1.68 ³ / ₄	1.62 ¹ / ₂	1.70	1.70	1.50
STEAMFITTERS	1.75	1.75	1.53-1-8	1.70	1.68 ³ / ₄	1.62 ¹ / ₂	1.50	1.70	1.50
STONESETTERS (MASONS)	1.87 ¹ / ₂	1.87 ¹ / ₂	1.50	1.75	1.75	1.50	1.75	1.75	1.50
TILESETTERS	1.50	1.50	1.37 ¹ / ₂	1.50	1.37 ¹ / ₂	1.50	1.50	1.50	1.37 ¹ / ₂

Prepared and compiled by CENTRAL CALIFORNIA CHAPTER, ASSOCIATED GENERAL CONTRACTORS OF AMERICA with the assistance and cooperation of secretaries of General Contractors Associations and Builders Exchanges of Northern California.

JOHN CASSARETTO COMPANY

—Since 1886—And Still Active—

Building Materials

READY MIX CONCRETE
ROCK - SAND - GRAVEL - LIME
CEMENT - PLASTER - MORTAR
METAL LATH - WOOD LATH
STUCCO - WIRE NETTING

Service Unexcelled

Bunkers

Sixth and Chennel, San Francisco
Phones: GARfield 3758 - 3760

MULLEN MFG. COMPANY

BANK, STORE AND OFFICE
FIXTURES—CABINET WORK
OF GUARANTEED QUALITY
CHURCH SEATING

Office and Factory:
60-80 RAUSCH ST., Bet. 7th and 8th Sts.
San Francisco
Telephone UNDERhill 5815

THE TORMEY COMPANY

GENERAL PAINTERS
AND DECORATORS

Phone UNDERhill 1913

563 FULTON STREET
San Francisco

G. P. W. JENSEN & SON

Building Construction

320 Market Street, San Francisco
Phone: GARfield 2444

IN THE NEWS

SURPLUS GOODS

In accordance with the basic law, every effort is being made to sell by bids surplus to the industries through which it was purchased and care is being taken to keep the material out of the hands of speculators, and out of competition with existing business. As of April 1st surplus property valued at \$262,000,000 was sold at a return of \$163,800,000, we are informed by the U. S. Chamber of Commerce.

NEW FARRIS VALVE

Perfected for use aboard Naval and Merchant Marine vessels and now commanding attention in refineries, chemical, power and industrial plants this new Type 1000 relief valve is of unique construction.



The diaphragm seals the valve from leakage encountered around the stem, particularly where there is fluid constantly on the downstream side. The valve will open to the full relieving capacity at 20% overpressure, rather than the approximate 35% in the conventional type of relief valve which depends upon pressure under the disc to lift the disc.

Bulletin on this and other relief and safety valves manufactured are available, FARRIS ENGINEERING CO., Palisades Park, N. J.

STEEL WINDOWS IN MODULAR PLANNING

A designer's reference book to assist in an understanding of the reasons for new types and sizes in conformity with a new concept of building design known as modular planning has just been issued by the William Bayley Company, Springfield, Ohio.

ANDERSON & RINGROSE

General Contractors

320 Market Street, San Francisco
Phone GARfield 2245

DINWIDDIE CONSTRUCTION COMPANY

BUILDERS

CROCKER BUILDING
SAN FRANCISCO



HERRICK IRON WORKS

STRUCTURAL STEEL.
REINFORCING STEEL.

18TH AND CAMPBELL STS.
OAKLAND, CALIF.
Phone GLEncourt 1767

Phone GARfield 1164

Thomas B. Hunter

Consulting Engineer

DESIGNER OF HEATING
AIR CONDITIONING
VENTILATING AND WIRING
SYSTEMS, MECHANICAL
AND ELECTRICAL EQUIP-
MENT OF BUILDINGS

41 SUTTER STREET
ROOM 710
San Francisco California

ARCHITECT AND ENGINEER

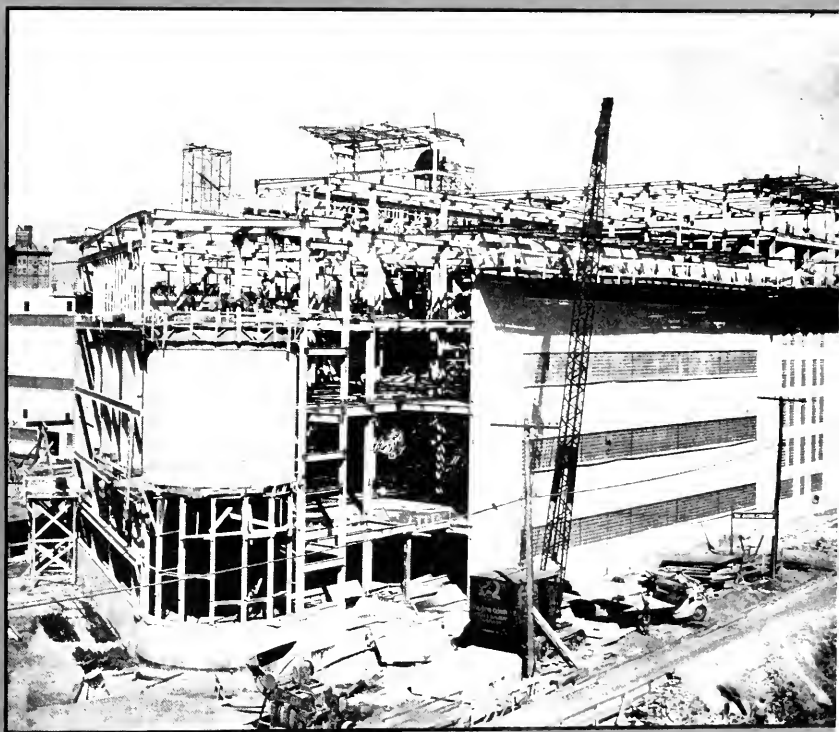

AUGUST

1945

CUSTOM TAILOR for a suit of insulation

Tank trailer for hot road oil, insulated with J-M 85% Magnesia blocks, secured by galvanized steel bands. The Western Asbestos Co. workman is applying a finishing coat of asbestos cement.



THE ENGINEERING AND APPLYING of insulation on equipment for the control of heat or cold is a custom tailoring job. To perform a thorough, speedy and economical installation it requires tailor-made materials, extensive engineering and field experience, and craftsmanship in application.

Western Asbestos Co., with a great reservoir of practical knowledge, gained in thousands of insulation installations

of every conceivable type, have the experience necessary to meet exactly your particular requirements. Our specialists are available to help you with present insulation problems... or with those connected with future plans.

Contractors and Distributors for Johns-Manville Corporation
WESTERN ASBESTOS CO.
DISTRIBUTORS • ENGINEERS • CONTRACTORS

ARCHITECT

Vol. 162 No. 2

ARCHITECTS' REPORTS—Published Daily
Telephone DOuglas 8311

AND ENGINEER

MARK DANIELS
Editor

E. H. WILDER
Associate Editor

MICHAEL GOODMAN
Post-War Planning

L. H. NISHKIAN
Consulting Editor

E. N. KIERULFF
Ass't Editor
*In the Service

Contents for



AUGUST

COVER: Welded Steel Construction (See Page 10)

ARTICLES AND MISCELLANEOUS TEXT

	Page
RUNNING FIRE	4
By MARK DANIELS	
NEWS AND COMMENT ON ART	6
TWO FINNISH SISTERS, Modeled by ADELE WAYLAND	
COVER PICTURE	10
ARCHITECTURE FROM GUTTERSON	11
UNITED STATES COAST GUARD, 155th BIRTHDAY	13
By MEL VENTER, LIEUTENANT, U. S. C. G. R.	
GOODYEAR'S NEW WINGFOOT HOMES	14
PLANS FOR NATIONWIDE SUPER HIGHWAYS ARE REVEALED	16
GLASS, For Postwar Store Fronts	17
ADVANCEMENTS IN WELDED DESIGN	20
BRITISH BUILDING INDUSTRY FACES RECONSTRUCTION PROBLEM	24
UNIFICATION UNDER THE CALIFORNIA COUNCIL OF ARCHITECTS	27
THE MINNATOMA PROJECT	28
By GEORGE S. HILL	
STAINLESS STEEL, In Modern Transportation Construction	31
LIGHT SAVING PAINT	34
WITH THE ENGINEERS	36
A.I.A. ACTIVITIES	37
PRODUCERS' COUNCIL PAGE	40
BOOK REVIEWS	41
ESTIMATOR'S GUIDE	43
Classified Advertising	45
Advertisers' Index	48



ARCHITECT AND ENGINEER (Established 1905) is published on the 15th of the month.
The Architect and Engineer, Inc., 68 Post St., San Francisco 4; Telephone EXbrook
92. President, K. P. Kierulff; Vice-President and Manager, L. E. Penhorwood;
Treasurer, E. N. Kierulff, Advertising Manager, V. E. Atkinson, Jr.

Los Angeles Office: 403 W. 8th Street.

Registered as second class matter, November 2, 1905, at the Post Office in San Francisco,
California, under the Act of March 3, 1879. Subscription United States and Pan
America, \$3.00 a year; \$5.00 two years; foreign countries \$5.00 a year; single copy 50c.
ARCHITECTS' REPORTS are published daily from this office, Vernon S. Yallop,
Manager.



RUNNING FIRE — by MARK DANIELS

CHINESE ARCHITECTURE AND HOUSING

At a meeting of distinguished scholars, officials and merchants chosen from the American-Chinese citizens of San Francisco, the name "Ping Yuen" was chosen for the Chinese housing project which, at that time, was occupying most of the attention of the true lovers of the city. A broad, ideological translation of the title might be "Happy Garden Homes" and much of the joy implied by the name was incorporated in the original plans. Also, much of it was taken out, step by step, by authorities who either thought that the plans were paying too much deference to Chinese details or that the additional cost, slight as it was, was not justified, or both. Now would be a good time to restore some of those happy elements to the plans before the structures are launched into construction, for it is understood that the San Francisco Housing Authority now has the authority to do this.

None of the features incorporated was extreme nor of a character antagonistic to good architecture in America. The elimination of the tile roofs is an example of how much of the beauty and Chinese character were left out of the plans. True, the buildings would be habitable if roofed with a plain concrete deck but so would be many other residential and hotel buildings to which we point with pride in our city. The fact that they were curved and lifted at the corners and laid in Peking yellow glazed tile might have added somewhat to the cost but not enough to justify their omission.

The balcony rails and corbel bracket tops of the columns offer an excellent opportunity to introduce some of those age-old designs the Chinese artists used so beautifully centuries ago in Shansi and Szchuan. This can be done in architectural concrete with little loss in the detail of the carved stone columns of old China.

One of the most important features is the P'ai-lou, or gateway, that is planned for the entrances. In the designing of a monumental building most architects throughout the world lay great stress on developing an imposing and impressive entrance. In "Ping Yuen" the entrance is to the garden proper and thence but a few yards farther to the building itself. A beautifully designed P'ai-lou (and there are many examples) would go far to lift this project out of the class of smaller housing projects, and it should be remembered that Ping Yuen comprises three separate buildings varying in height from six to eight stories.

There is no thought to make Ping Yuen an example of the infinite variety of architecture that might be seen in China, even if that were possible.

No idea has been entertained that was based upon the use of legendary superstitions or customs of various districts or religions. The thought at all times has been to employ the best examples of the work of the great artists and architects in China whose work has been admired by the world for more than a thousand years, and to use to the best of our abilities the knowledge thus gained in a practical twentieth century building to house Chinese people in San Francisco. For many years these people have worked by our side, uncomplaining, doing their best to help us build San Francisco into the great city she is, in which Chinatown has become the greatest single factor in her development. Now that the San Francisco Housing Authority has the right to review these plans the residents of this city are hoping that the original Chinese character may be restored before it is too late.

KUNG HEI, PONG YAU

"Greetings, my friend," or some such cheerful and happy salutation might have been heard at the P'ai-lou opening the walk to Ping Yuen, but I fear that unless some of the charm of the original designs is restored the greetings will be silent.

APPOINTED TELECHRON AGENT

Telechron program and clock systems will be handled by Edwards & Company of Norwalk, Connecticut, through recent arrangements made with the Warren Telechron Company.

C. J. RYLAND, architect of Monterey, California, is in the same boat with a growing number of other architects. He wants help and is asking for an architectural draftsman for his office in Monterey, phone Carmel 404 or write P. O. Box 847, Monterey, California. He wants a Construction Superintendent to operate on the Monterey Peninsula and asks that the applicant give training and experience which will be considered confidential.

BRANCH OFFICE OPENED

The DETROIT STEEL PRODUCTS COMPANY has reopened a branch sales office in San Francisco, located in the Russ Building at 235 Montgomery Street, where Mr. George B. Quamby will act as manager. Mr. Quamby has been with the Fenestra selling organization for twenty-five years. Mr. Sherman M. Hathaway is the General Manager of the Company's Pacific Coast Division. Offices in San Francisco have been maintained for over thirty years by the manufacturers of Fenestra Products.

**Conservation of Space
Efficiency in Service**
both depend on

Streamline

TRADE MARK REG. U. S. PAT. OFFICE

The installation of STREAMLINE Copper Pipe and Solder Type Fittings under normal water conditions assures many, many years of trouble-free, efficient service at low cost. Copper and bronze do not rust. STREAMLINE Pipe is made from pure copper. STREAMLINE Fittings are manufactured in copper and bronze.

Conservation of space is a very important consideration, especially in large public buildings and hotels. The more space that can be utilized, the more income produced. Since STREAMLINE Fittings are not connected by flaring or threading, no room is required for wrench play to tighten the Fittings into place, nor need any allowance be made for protruding valve stems, which on threaded pipe, must be swung in an arc to secure. Valves and fittings are installed in a minimum of space, they are located exactly where required, and soldered.

Copper Pipe loses less heat by radiation than ferrous piping, particularly if the surface is kept polished, although copper itself is a very rapid conductor of heat. Therefore, it naturally follows that there is considerably less heat loss when the heated element, water or steam, is being conveyed from the point of generation to the points of distribution through copper pipe of uniform, unclogged, internal conducting area.

Plan on specifying and installing STREAMLINE Copper Pipe for your postwar construction—or for replacement.

STREAMLINE
PIPE AND FITTINGS DIVISION
MUELLER BRASS CO.
PORT HURON, MICHIGAN



TWO FINNISH SISTERS
Modeled by ADELE WAYLAND

There is a distinct difference in these two charmingly modeled portraits, rendered in permanent form. The one is modeled, and then a mold is made from which casts are made which in turn must be fired for reproduction. The "peasant girl," with the handkerchief over her head, is fired direct. In other words, the modeling was done in terra cotta and fired upon completion. This, of course, means that only one can be produced. This latter method eliminates many of the losses in modeling that are destroyed in casting but, of course, means only one piece for all the work done, which piece might easily be broken and the work lost.

After July 31, the San Francisco Museum of Art will return to its permanent location in the World War Memorial Museum in the Civic Center War Memorial Museum Building. The permanent location will reopen on August 7, after having been devoted to the use of the UNCIO Conference for its duration. Both the people of San Francisco and the directors of the Museum will hail the return with joy.

GLENN STANTON, A.I.A., will move his office on September 1st, 1945, from the Railway Exchange Building to 208 S.W. Stark Street, Portland 4, Ore



"CAROLINE, A FINNISH PEASANT"
Modeled from life by ADELE WAYLAND

The Peasant Girl, one of the two Finnish sisters, was modeled and built direct in terra cotta. Adele Wayland mixes her own terra cotta and does all firing in her own kiln. "Caroline" and her sister have been exhibited several times, including the shows of the Exposition, the Oakland Sculpture show and that of the San Francisco Society of Women Artists.

ART DISPLAYS

Dr. Jermayne MacAgy, Acting Director of the California Palace of the Legion of Honor, Lincoln Park, San Francisco, has announced the following schedule of exhibitions and special events for August:

Exhibitions

MODERN ADVERTISING ART, August 1-31; WATERCOLORS BY HALLEY COX, August 6 through September 9; CERAMICS BY CLAUDE HORAN, August 14 through September 16; WATERCOLORS BY GEORGE POST, through August 30; GEORGE BLANDING COLLECTION, through August.

The Alma de Bretteville Spreckels Collection of Sculpture and Drawings by Auguste Rodin.

The Mildred Anna Williams Collection of Paintings, Sculpture, Tapestries and Furniture.

The Collis Potter Huntington Memorial Collection of 18th Century French Paintings, Sculpture, Tapestries, Furniture and Porcelain.

The de Young Museum will open an exhibit of paintings by Flavio Cabral on August 10 and an exhibit of water colors by Dong Kingman on August 21. Perhaps the exhibit of the water colors of Winslow Homer, scheduled through August 19, may still be there and if so, a visit to the gallery might be made to cover all three of these worthy exhibits. In any case either one of them is worth the trip to the Museum.

from Life

"LORD - SINGING"



Oil Painting by George De La Tour

Courtesy Legion of Honor

Get Set Now—To Take Full Advantage of the Postwar *Building Boom!*

MANY SUBSCRIBERS to Architects' Reports (a daily advance building news service, reporting construction projects for the Northern California area) have told us that for one contract secured through these reports, they have made a profit that would pay for the service for many, many years to come.

THIS SERVICE comes to subscribers in the form of handy, individual slips, giving name of project, location, architect, proposed cost and other pertinent and valuable data. These are mailed daily and the current average is about 500 *monthly*.

BUILDING MATERIAL DEALERS and contractors in the San Francisco Bay region use Architects' Reports to supply their salesmen with good prospects. The compilation cost of these reports is very expensive, yet the service is available to subscribers at the nominal charge of \$10.00 per month, or about two cents per report.

NOW IS THE TIME for you to get set for the postwar building boom by incorporating this valuable service in your sales program. Order your trial subscription now or telephone EXbrook 7182 or DOuglas 8311 requesting samples.

ARCHITECTS' REPORTS

Published by

THE ARCHITECT AND ENGINEER, INC.

68 Post Street, San Francisco 4



The Pace of Victory Permits Only A Congratulatory Handshake!

American Industry well merits a decoration for its brilliant record in the Mighty 7th! But, as our newly decorated Pacific heroes quickly return to combat, so industrial leaders aren't resting on their laurels. ***Back into Bond action***—they are now busy consolidating recent Payroll Savings Plan gains!

First, many executives are now patriotically working to retain the substantial number of new names recently enrolled during the 7th War Loan. By selective resolicitation, they are urging all new subscribers to maintain Bond buying allotments.

Second, many are also employing selective resolicitation to urge every worker who increased his or her subscription in the 7th to continue on this wise, saving-more-for-the-future basis.

Help to curb inflationary pressures and harvest peacetime prosperity by holding the number of Payroll Savings Plan subscribers—and amounts of individual subscriptions—to the mark set in the Mighty 7th!

The Treasury Department acknowledges with appreciation the publication of this message by

ARCHITECT AND ENGINEER

COVER PICTURE

THE PICTURE ON THE COVER

It will be found that many architects labor under the misapprehension that arc welding is employed only in the steel frames of smaller buildings, which is one reason for using this picture on the cover. This building of seven and eight stories, designed and constructed to support concrete bins, is supplied by the Lincoln Electric Company to show on what a scale welding has developed. Like many other advances in construction, arc welding is going forward rapidly.

RECONVERSION DATA

FANS: Unrestricted production of electric fans permitted, but restrictions remain on distribution.

STEEL: 25 per cent cut in permissive inventories for sheet and strip steel in effort to spread supplies.

AUTOS: Persons desiring to enter automobile manufacturing field and producers seeking increases in production quotas should apply under provisions of WPB priorities regulation 25. All controls lifted on production and distribution of automotive maintenance equipment.

TIRES: OPA has relaxed prohibition against letting new tire dealers start up to permit veterans to obtain stocks of tires.

RESEARCH: WPB says it wants to help in establishment of laboratories, pilot plants and experimental shops in industrial fields.

IRONS: Production controls now removed.

REFRIGERATORS: WPB raises permitted third quarter production by 27,993 to total of 225,702 units; all will go into frozen stockpile to meet military, hospital and other highly essential requirements.

WASHERS: WPB raises permitted third quarter production by 148,093 to total of 303,890 units; machines not needed for military or other orders go on open market.

FURNITURE: Production controls on manufacture and use of metal in furniture and fixtures liberalized.

TUNGSTEN: Army cutbacks permit revocation of order limiting purchase of tools with high tungsten content.

TIRE CHAINS: Cutbacks permit relaxation of production and delivery controls.

ELECTRICAL POWER: Controls relaxed on domestic watt-hour meters, integrating electrical meters, steam driven generators, diesel or natural gas driven generators, soot blowers and hydraulic governors, except aircraft.

IN THE NEWS

MANY USES FOR TENITE

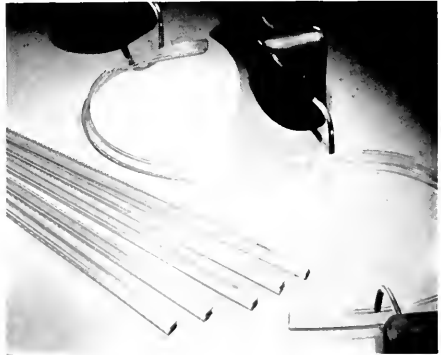

(Eastman Kodak Photo)

Draftsmen's splines extruded of transparent Tenite produce accurate curves, because of a high degree of dimensional stability, close tolerance, and even edge.

Uniformly flexible and resilient, they may be made to take any desired curvature.

Tenite, a product of the Eastman Kodak Company, is being used as material for drawing and measuring instruments, architects' and engineers' triangular and flat scales, T-squares, and straight edges.

BUYS NEILSEN PUMP COMPANY

The Oil Well Supply Company, U. S. Steel Corporation subsidiary, recently announced its intention of exercising an option for purchase of assets of the Neilsen Pump Company of California.

Main plant facilities of the Neilsen Pump Company are located at Long Beach, California; a large shop and warehouse are at Taft, and stores and sales offices are at Bakersfield, Huntington Beach and Ventura.

Under the projected purchase plan the company's assets will be organized into the Neilsen Pump Division of Oil Well Supply Company.

Established in 1926, the company was owned by Karl P. Neilsen and Edward D. Sports.

FELT FACTS

Photographs showing new and interesting uses of felt are desired by Worth Colwell, Public Relations Department, The Felt Association, Inc., 480 Lexington Ave., New York 17, N. Y.

Here is an opportunity to turn your original uses of felt into more cash.

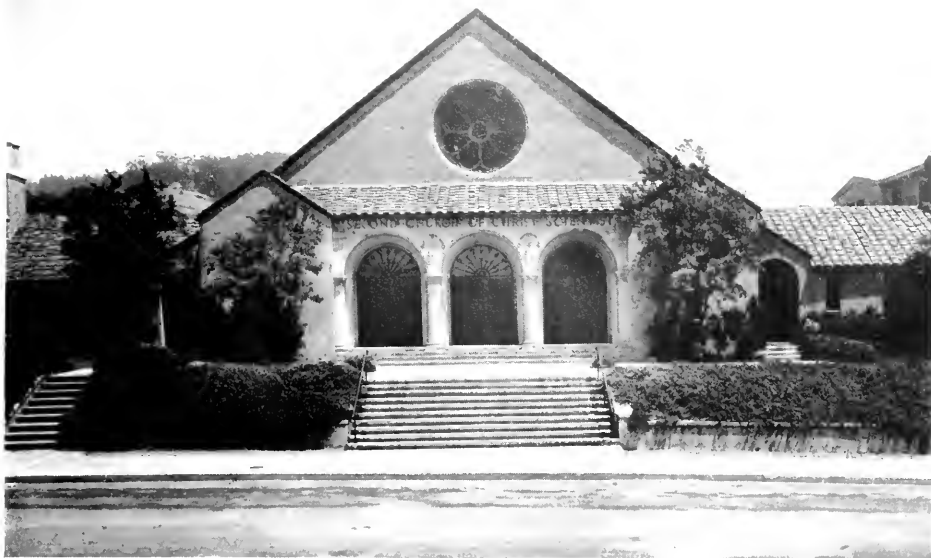

SECOND CHURCH, C. S., Berkeley, California

Henry H. Gutterson, Architect

Architecture from Gutterson

Now that he is back in San Francisco with coat off in new offices, we may look forward to more work from his gifted pencil. After several years of absence in the east on various missions, in which Principia College was one, Mr. Gutterson has returned to the scene of his first accomplishments. Judging by his latest works here, these trips have not impaired or lost for him any talent for looking up to the skies for inspiration.

On his last trip east Mr. Gutterson represented the Northern California chapter of the American Institute of Architects, at the Annual Convention of the Institute, where he acquitted himself and the Chapter with all the distinction that was expected of him. Now we are all looking forward to his doing the same for our western architecture. Over twenty years ago the ARCHITECT AND ENGINEER published articles of unusual merit on the work of Mr. Gutterson and we shall look forward in hopeful expectation for others, wherever he is.



Ralph J. Robey, Photo

The Famed Okinawa Beachhead



Official U. S. Coast Guard Photo

THE SEA MIGHT of America closes in on Tokyo. Striking boldly at the West Coast of Okinawa, Japanese bastion in the Ryukyus, another formidable task force carries out a beachhead, this time about 350 miles from the Japanese mainland. COAST GUARD manned and Navy landing craft of all kinds blacked the sea out to the horizon where stand the battlewagons, cruisers and destroyers.

United States Coast Guard 155th Birthday



By MEL VENTER, Lieutenant, U.S.C.G.R.

As the great Allied offensive moves ever closer to victory over Japan—two down and one to go—the United States Coast Guard has better reason than ever to commemorate its 155th birthday on August 4. Men of this unsung service, oldest in the Nation's naval history, will take official time out, but only briefly, to celebrate.

They're much too busy landing Army and Marine forces on Jap-held beaches; manning troop, assault and cargo ships; convoying and escorting, and withal, carrying on equally vital Port Security duties, to initiate extensive celebrations.

Wherever American forces have stormed ashore on enemy beaches—from North Africa to Normandy to Guadalcanal and Okinawa—Coast Guardsmen were there to put all of their fighting surtman's skill into difficult landing operations, dodging shells and torpedoes, getting vital supplies ashore in driving tropical rains and heavy seas.

These Coast Guard Invaders who hit the beaches with unflinching courage in the face of withering enemy gunfire have earned a birthday salute from a grateful Nation.

And so have other proud wearers of the small white shield on the right forearm—170,000 strong—who are performing equally vital duties ashore and afloat. Included in this number are 10,000 women in blue, the Spars, who are making it possible for an equal number of doughty Coast Guardsmen to join their shipmates at sea.

Just as important as the overseas operations of the Coast Guard—amphibious landings and manning of troop, assault, cargo and convoy ships—

are the less spectacular home front activities of Port Security, Merchant Marine inspection, training and licensing, Air Sea Rescue operations and the traditional tasks of tending lighthouses on rocky capes, enforcing navigation laws and rescuing men from foundering vessels.

To assist in Port Security activities—vastly increased now on San Francisco Bay, the main funnel for shipment of men, munitions and supplies to Pacific fighting fronts—are thousands of patriotic Americans who have enlisted in the Coast Auxiliary and Temporary Reserve, devoting a minimum of 12 hours per week at no pay, thus helping to release more regular Coast Guardsmen for other assignments.

With a minimum of fanfare, the Coast Guard is performing its important wartime assignments. Few know that this was the first American service to take German prisoners of war . . . that a Coast Guardsman, volunteering in the rescue of Marines trapped behind enemy lines at Guadalcanal, was awarded the Congressional Medal of Honor posthumously, the Nation's highest military award. Further, it was a Coast Guardsman who was responsible for the capture of the saboteurs who landed at Long Island from a Nazi submarine.

And this service, born away back in 1790, also lived up to its motto, "Semper Paratus—Always Ready," in the decisive battle of the North Atlantic, both in convoying merchant ships and in prowling the ocean for undersea raiders.

"Semper Paratus — Always Ready" was never more exemplified by doughty Coast Guard personnel than in this war.



Litchfield Park, Arizona

Goodyear's New Wingfoot Homes

Five basic colors have been worked into a wide variety of color schemes for the production models of Goodyear Wingfoot Homes now coming off the assembly line of the pilot plant at Litchfield Park, Arizona.

This wide selection of color schemes is made possible by varying the widths of the paint zones of the house and using various combinations. In addition the windows and doors are painted in other colors to add to the attractiveness of the color combinations.

Natural lighting and ventilation of the production model have been improved to far exceed minimum accepted standards. The house is



Complete Standard Size
Fixture Bathroom



KITCHEN: Louvers beneath the windows provide special ventilation, while many built-in features increase the kitchen facilities and general livability of the home.

BELOW: These sturdy built homes come with many built-in features, special attention having been given to ventilation and storage space in planning two bedrooms. All available space has been utilized, one bedroom having double bed and the other an upper and lower bunk.



equipped with louvers which when opened provide plenty of ventilation even though the doors are locked and all windows closed.

Wingfoot Homes production is being carried out under wartime housing regulations with many of the homes now going to house workers at the Goodyear Aircraft plant in Litchfield Park, Arizona. The date garden of the Goodyear Farms there is the site of a second model development. Another such village is located directly across from the aircraft plant.

Unlike most pre-fabricated houses, the pre-assembled model comes delivered as a packaged unit with much of the furniture built-in. Each home is equipped with cooking facilities, heating equipment, ice box and automatic hot water heater.

Plans For Nationwide Super-Highways Are Revealed

A nationwide network of superhighways designed for maximum safety at speeds of 75 miles an hour in rural areas and 45 in cities is neither fantastic nor visionary but actually the Government's program for immediate peacetime years, Major General Philip B. Fleming, Administrator of the Federal Works Agency, predicts.

During the first three years of peace "\$3,000,000,000 is to be spent on roads . . . a considerable portion of these funds will be expended upon a 40,000-mile national system of interstate highways," General Fleming states. "The great network of interstate highways now being selected in cooperation with the states will extend into every state and connect every important center of population. These roads, designed for traffic needs 20 years from now, will form direct links between our large cities and industrial centers.

"We also plan to build a system of secondary or farm-to-market roads to meet the needs of the farmers."

The interstate system, which will necessitate an over-all expenditure of \$10,000,000,000, will be from two to six lanes in width, without grade crossings, and on divided highways, the right-hand and left-hand roadways will be separated by at least 15 feet of grass.

"You will be able to spin right through business centers of large cities without stopping for traffic lights," General Fleming tells motorists. "For the first time extensive Federal funds are being granted specifically for urban highway development, and non-stop highways, many of them either elevated or depressed below the street levels, will be constructed right through or skirting the centers of most of our larger cities. Ramps will enable you to drive on or off these arteries every few blocks, but there will be no intersections.

The unsightly roadside stand or gasoline station—indirect cause of many accidents when motorists slow down or stop at them—is doomed.

Standards recommended to the states provide that there be no hot-dog stands fronting immediately on the main highways, and no filling stations, such facilities will be located at selected points where access roads can lead to them.

Seven-eighths of all motorists on rural highways don't want to by-pass the cities so the avoiding of a business district is being made optional for the tourist.

"The cross-country driver will be able to avoid the main business district, if he wishes to, by taking circumferential routes which pass around the city," states the Federal Works Administrator. "The largest cities may have inner and outer 'ring' roads."

These circumferential roads will give cities an opportunity for a more even development of their outlying areas by the demolition of outdated buildings; laying out of new streets, and parks and playgrounds; and the erection of modern apartment houses.

THE CONSTRUCTION OUTLOOK

By MARDI

The reviewing of the work that is in hand for the contractors is quite tautological in the light of the information that is sent out daily by ARCHITECTS' REPORTS but a resume of sections of those reports may not be amiss.

In going over these daily reports I find that over six million dollars in contracts were awarded in Central and Northern California during the first half of July. Add to this a much larger amount that were probably awarded in Southern California and you get a picture of how the construction game is shaping up in the State.

On July 15th over ten million dollars worth of construction work was being planned and on the drafting tables. These were definite jobs that had been ordered to go ahead as soon as possible and were not just up in the air possibilities.

In July the Government made an additional allotment of \$8,700,000 for Hunters' Point and several towns and districts have voted bonds that have been before the public for some time. The work to be done is piling up on us and promises to be here in abundance when the discharges begin to pour in on us. It is felt that later the only difficult problem will be that of the materials of construction, and the Government is working hard at that problem.

Chas. E. Butner, architect, has, on his draughting boards, post-war plans for two grammar school additions in Salinas where he practices architecture.

KEITH O. NARBETT, architect, has reopened offices in Richmond, California. He is now located at 2036 San Pablo Avenue.

A GENERAL STORE

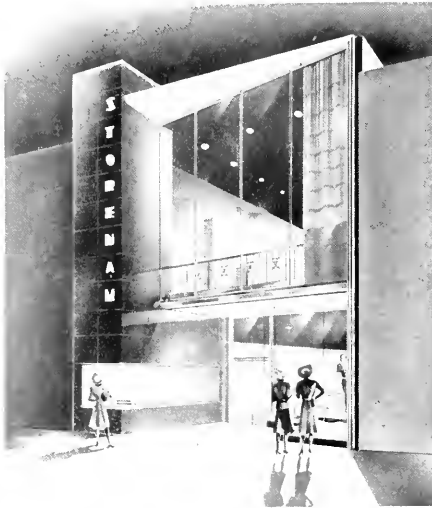

Design by Silverman & Levy

In this postwar, glass emphasized building, the design contemplates merchandise typical of the needs of a small community.

To make the interior as inviting as possible to passers-by, display window backs and divisions between departments are limited to structural glass. Both display window and entrance vestibule are strongly illuminated from glass ceiling panels.

Structural features include Herculite doors, Carrara structural glass exterior, mirrors and glass front stock cases and counters.

A RESTAURANT

This design was based on the formula that an inviting restaurant interior is its best possible display, and consequently creation of an attractive restful interior was the primary design consideration.

An informal, garden-like area was created through the use of a rough brick wall, quarry tile floor, profuse interior planting and free standing decorative glass partitions, the latter forming private dining alcoves.

Table lamps may be plugged in anywhere through provision of continuous built-in floor plug-in strips.

Outdoor dining is provided on second floor; this area, however, may be thrown into the enclosed interior during adverse weather by rearranging the movable glass panels around the balcony.

The problem of making this interior as co-extensive with the street as possible is solved by the use of an invisible flat glass front window

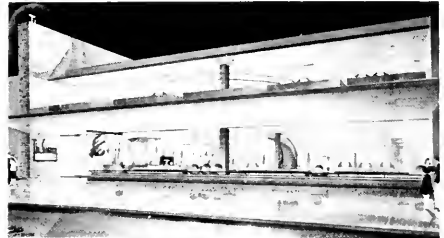

ABOVE: General view from street.

BELOW: Interior scene, indicating unique postwar design.



Designed by Igor B. Polevitzky, Architect

which, by eliminating all reflections, removes every vestige of barrier between the pedestrian and the interior and accents the impression of a wayside garden.

STUDY FOR AN AUTOMOBILE SALES AND SERVICE BUILDING

Predicated upon the advertising and display value that the jewel case type of show window possesses, this ultra modern automobile sales and service building has been developed.

(See Opposite Page)

ARCHITECT AND ENGINEER

IN THE NEWS

LABOR SCHOOL SUMMER PROGRAM

The Summer Session of the California Labor School presents several courses in contemporary art and architecture: **WHAT IS MODERN ARCHITECTURE**, a series of illustrated lectures by Jan Reiner; **HOUSING—AN INTERNATIONAL PROBLEM**, by Robert Anshen and Francis Violich; **PLANTS IN THE LANDSCAPE**, by Garrett Eckbo; and **ARTS OF TODAY**, by Adelyn Cross.

AUTOMOBILE SALES

(From Opposite Page)



SHOWROOM interior, while below is attractive street view.

A recessed walk permits diversion of pedestrians without interfering with the flow of traffic, while polished plate glass which slopes from top to bottom, eliminates glare and reflection under changing light values.

Walls of suede finish Carrara and doors of Herculite tempered glass offer an unusual solution of the appearance of the building.

Aside of Creative Art, the summer courses in Music, Drama, and Speech are held. The California Labor School is located at 1000 Broadway, San Francisco.

MATERIALS NEEDED

Seven billion dollars worth of construction materials are needed for the first postwar year to enable the Construction Industry to attain the desired rate of \$12,000,000,000 per year, according to H. E. Foreman, managing director of the Associated General Contractors of America.

That is a lot of material but it includes everything in the construction line such as electrical accessories, plumbing and heating equipment, cast iron pipe and all kinds of builders hardware.

Private construction is expected to account for about two thirds of the volume by the first of the year which means that priorities and other obstructions will have to melt fast in the sun of the heavy demand. The Government seems confident the goods will be forthcoming.

CONSTRUCTION PREPARATIONS

Harry A. Dick, president of the Associated General Contractors of America, has called attention to the fact that "It is much easier to gear our business economy to war, than it is to shift it back into prosperous peacetime operations."

"The reconversion period will bring many problems, and we on the home front would be derelict in our duty to our fighting forces if we did not plan for the day of their return home and reentry into civilian life," Dick recently said.

Starting last year the Associated General Contractors have advocated and been planning postwar construction to the contract-letting stage, in the hope of having available \$12,000,000,000 for construction by the end of the first year after the war.



Smith, Hinchman & Grylls, Architects



THE AUSTIN COMPANY erects rigid, welded steel framed foundry.

Advancements In Welded Design

INDICATE ITS WIDER USE FOR BUILDING CONSTRUCTION

By **J. R. MORRILL**

(Photos and Data Courtesy The Lincoln Electric Co., Cleveland, Ohio)

Although the erection of modern housing structures has been generally retarded due to war conditions, welded steel building construction has shown some remarkable developments during the past several years due to the wider use of arc welding methods in all types of metal fabrication.

Extreme simplicity is a fundamental advantage of arc welded design. This simplicity is attained because arc welding joins two members directly to each other without use of a third or connecting member; whereas to join two members by riveting

usually requires an additional member. This advantage is responsible for a greater or lesser saving in designing and detailing. It should be borne in mind, however, that regardless of the simplicity of arc welded design the stress at every connection must be accurately calculated and the required amount of weld metal specified.

The chief economy of arc welded design is due to the fact that it calls for less material. For almost all types of connections, the arc welded design is more economical in material requirements.

WELDER fuses connecting steel member by means of electric arc.



Trusses properly designed for arc welding require practically no gusset plates. Because the electric arc fuses one member directly into another, an entire structure so fabricated actually is and acts as a single member. For this reason arc welded design usually permits the use of lighter members than a riveted design. A saving in steel results for arc welded design which averages approximately 15 per cent for buildings so designed to date. In the case of arc welded mill buildings containing a large number of trusses, the saving in steel often amounts to as high as 25 per cent.

The simplicity of arc welded design means more than the saving of weight and material. In the fabricating process it is apparent in a different form.

The handling of material is a large item in the cost of shop fabrication. Naturally the fewer pieces and the less weight to handle the lower the fabricating costs. With this in mind consider now the comparative examples of arc welded and riveted design. To make the riveted connection requires the handling of three pieces. The arc welded connection calls for the handling of only two pieces.



BEAMS are rigidly welded with connecting pieces.



ABOVE: "Three-Form" steel column in welded sawtooth section of industrial plant structure.

GENERAL VIEW of industrial plant construction showing welded structural steel in place.



To make the riveted connection holes must be punched in all three members. No punching is required for the arc welded connection. The punching also involves more laying out. Three separate operations and two different machines are required to make the riveted connection. The arc welded connection requires only two operations and only a welding machine for equipment.

From the above comparison of a fundamental detail, some of the fabricating economies of arc welded design are readily apparent.

By the use of the proper arc welded design much of the handling of the main members can be eliminated. Instead of punching main members for temporary bolted field connections small clip angles or plates can be punched, carried to, and arc welded to the main members for such connections.

Ingenuity in designing simple details such as those described above results in substantial saving in shop fabrication and in erection in the field.



FABRICATION of curved roof truss.



UNIQUE Hotel Design for welded construction.

Advantages of welded structural design does not stop with savings in material, labor and weight. There is an additional advantage of quietness in the welding operation as illustrated in Fig. 1, which is highly desirable as compared to the nerve-racking noise created by riveting machines.

A recent survey reveals scores of newly welded structures including approximately 50 industrial buildings and plant additions, 9 schools, 11 stores, 4 office buildings, 6 commercial garages, 4 hospitals and numerous other structures such as homes, churches, apartment buildings, theaters, auditoriums, bridges and piers. A few typical illustrations of welded building designs are shown in Figs. 2 to 10, inclusive.

Having proven its feasibility in both peace and wartime structural building erecting, welding equipment is destined to become one of the most important tools in our postwar reconstruction and will undoubtedly contribute greatly towards solving future housing and employment problems.



WELDED free standing framework of Church structure showing unusually high pitch of roof design.



A British Prewar Public Housing Scheme.

British Building Industry Faces Reconstruction Problem

(One out of every three houses in Britain has been seriously damaged or destroyed by enemy action. Out of 13,000,000 houses, 4,073,000 were damaged, 225,000 rendered uninhabitable, and 202,000 totally destroyed up to the end of September, 1944. One-quarter of the 4,500,000 houses damaged or destroyed by bombing were damaged in robot attacks after D-Day. Following are brief descriptions of some of the steps being taken to meet the housing shortage and repairing of buildings damaged by enemy action but not rendered unfit for living quarters, together with a few of the proposed plans for postwar construction.—Editor's Note.)

A prefabrication concern in the heart of one of Britain's most heavily bombed cities recently built a factory-produced, new type cottage containing a living room, kitchenette, bedroom and bathroom. The walls, roof, chimney and floor were in position in one hour, and the cottage itself was completed in the record time of six hours by a construction force of twelve persons, four of whom were women. Specifications include walls with an insulating value of an 11-inch cavity wall, and kiln-dried timber and joinery. The same firm also constructed a factory-built two-story, three-bedroom house

which was assembled in the short space of four days. It was constructed in wooden-framed concrete wall units, with a utility room for washing boilers and space for baby carriages, bicycles, etc. The cost of the latter type of home is in the neighborhood of \$3,000.

One of the larger industrial cities of Britain, which has been faced with the necessity of providing at least 15,000 homes immediately, is approaching the problem from an entirely different angle. A proposed new type of building, in which as much prefabricated material as possible consistent with suitability is being used, consists of a light-weight steel frame in which a permanent interior can be constructed, and which can be covered with either permanent or temporary material. If the latter is used, it can be exchanged for permanent covering when such materials are again available for civilian use. It is anticipated that if and when frame prefabrication is put on an "assembly line" basis, it should be possible to construct these homes in a matter of days rather than weeks.

One advantage of this type of housing is that the steel frame is satisfactory for a different type of house if future needs or demands warrant a change in present specifications, as the inside of the structure can be completely re-designed and rebuilt without disturbing the exterior surfaces.

Bomb Damage Repair

Emphasizing the vast extent of damage to civilian property by enemy action was the announcement recently by the Officer in Charge of Bomb Repairs that no building work in excess of \$40.00 could be done in the London Civil Defense Region without a license. Every house repair job until April 15th was to be done by labor under the direction of the Works Ministry, the only exception being instances where severe structural damage or matters of sanitation was involved.

"Dream House"

In a report issued by the Women's Advisory Housing Committee, based on the replies of 3,000 housewives to a questionnaire asking their ideas on postwar homes, almost 100 per cent of the women wanted houses in preference to apartments, and most of them wanted gardens. Their ideas have been summed up in a "Charter" for postwar building, the salient points of which are:

- (1) Dwellings should vary from a 2-roomed house for single or elderly persons to 5-room family homes;
- (2) Walls should be thick or sound-proofed;
- (3) Rooms should be square and high with large, low windows;
- (4) Kitchens and pantries should be better

planned and fitted with adequate electric outlets and a scientifically designed load-bearing space.

The British Architects Association estimated that such a home would cost about \$5,000 in present values, although it probably could be mass-produced after the war for about half that sum.

Subsidies For Private Enterprise

Subsidies for British houses built by private enterprise after the war are proposed in a new Government report. The problem to be faced is that Britain will require 3,000,000 to 4,000,000 houses in the first ten or twelve years after the war—the greatest undertaking in the history of housing. The report argues that building costs may be inordinately high in the first two years, and that without aid, private builders will not be able to produce houses which can be let at low rents. "Until costs settle down at a level which is in balance with the cost of living and wage rates . . . some form of subsidy is essential . . . A subsidy must necessarily involve some degree of control, for public opinion will rightly demand measures to secure that public funds are not exploited."

Government Housing

The Minister of Health's Housing (Temporary Accommodation) Bill, which was recently passed by the House of Commons, covers the erection of 250,000 temporary homes by October 1, 1947. These houses are to provide a temporary solution to the acute shortage previously mentioned, and will be used only until an adequate supply of permanent housing has been made available. (Their average life is expected to be not more



Some of 1212 Houses on the London County Council's Estate at Roehampton.

(than ten years at the outside.) Financing of these homes is to be effected through borrowing, repayable by annuities. Annual payments are to be made to the Health Department by local authorities for as long as the structures remain in use.

A self-styled "carpenters' circus" which moved from camp to camp in the backyards of the bombed areas nearest its scene of operations became a feature of air-blitzed London after the advent of the robot bomb. This sixty-man, first aid repair party was the flying column of a slower-moving corps of 3,000 men and was settled in a yard surrounded by ruins. It slept in traveling dormitories and had meals from a traveling kitchen. All vehicles were electrically lighted, and a telephone connected the moving office with the Works Ministry.

Members of the party were men absorbed by London from the provinces, and as new workers arrived, they were distributed from pools which registered and allocated them to beds for the night and allotted them to contractors.

These men, whose versatility was their strongest point, won the warm approval and gratitude of the bombed-out Londoners who benefited from their unselfish service.

The Luftwaffe unwittingly contributed to Germany's woes when it reduced British structures to rubble, for much of that hard-core rubble was used in the prefabricated harbors for the Normandy invasion. When work started on the ports approximately 225,000 tons were sent to the harbor construction sites. Demands for the rubble strained to the utmost the already short-handed and overworked organization entrusted with the job of obtaining the huge amount, which had previously supplied in excess of 1,000,000 cubic yards for U.S. Army Air Force airfields construction in Britain. As a result, most of the debris needed for harbor construction had to come from fresh demolitions, and London supplied from the outset about 30,000 cubic yards per week for this D-Day project.

POSTWAR EMPLOYMENT

California's postwar employment problems depend not just upon the total number of jobs, but upon an adjustment of the kinds, locations and durations of jobs to the desires of the workers themselves.

This is one of the important findings in a study being made by the State Reconstruction and Re-employment Commission on the subject of postwar employment. The study reveals that, for approximately one-half of California's workers, both employment and unemployment are transitory.

IN THE NEWS

PLANNING SAN FRANCISCO

The monthly bulletin of the City Planning Commission, only just inaugurated, is one of the best in the country. It is couched in the terms that one who runs may read, and yet it is full of meat for thought. If you want to get information about the many problems of the city that you and I should thoroughly understand but really know little or nothing about, get a copy of "PLANNING." It's the best source of information we know. We don't know whether Michel Weill or Deming Tilton is responsible, so hats off to both.

WEATHER MAGIC

The May-June issue of WEATHER MAGIC, published by The Trane Company, La Crosse, Wisconsin, contains an illustrated article on the U. S. Naval Hospital at Shoemaker (Livermore Valley), California.

Design and construction of this prefabricated hospital are given in detail.

W. D. Peugh, architect; Clyde E. Bentley, electrical and mechanical engineer; F. W. Kellberg, civil and structural engineer; and Karl F. Baldwin, project mechanical engineer in charge of design, all of San Francisco, were in charge of architectural and engineering features of the project.

AMERICAN AIRMEN MEMORIAL

The American Second Air Division has chosen the new public library in Norwich for display of a memorial to all men of the Division who lost their lives in the great bombing expeditions which went out to Germany from Norfolk.

More than \$80,000 subscribed by officers and enlisted men of the Division will be spent in construction and maintenance of an entrance hall containing the Roll of Honor, and later American books, music and examples of American Art will be added.

NEW AIRCO CATALOG

Air Reduction is distributing a new electrode catalog, one of the most complete books of its kind.

The 65-page book contains a combined electrode selector chart and index, illustrated sections on Mechanical Properties and Testing and on Approvals.

Attractively printed in two colors the entire arrangement is calculated to make it easy to use. Copies may be obtained from Air Reduction, 60 East 42nd Street, New York 17, New York.

Unification Under the California Council of Architects

Many architects in the State of California have been inquiring as to the progress of unification under the California Council of Architects. Appreciating this fact, the Council has asked the Architect & Engineer to publish this resume of its last meeting which was held in Los Angeles. This report will, in itself, give the profession a comprehensive picture of the activities of this unifying organization.

In addition to the discussions centering about the finances of the Council, the meeting dealt with the three broad phases of the Council's responsibilities, namely, its public, professional, and Governmental relations programs.

As a matter of policy the Council will bill the Northern California and the Southern California Associations \$1.00 for each registered architect within their area. The Council is, however, requesting a list from each of the Associations setting forth The American Institute of Architects' corporate members who have contributed \$10.00 or more to the Associations. The Council anticipates the formation of Northern and Southern California District Chapters within the year, in which event the Council will credit to the Chapters the amounts already paid through the Association by individual members of those Chapters. It is understood that the Southern California Association collected funds for legislative purposes which funds will be turned over to the Council to be used for the work of the legislative committee. An additional amount will be paid to the Council by the Northern California Association which has a substantial legislative fund. Contributions have also been received from the Southern California Chapter of The American Institute of Architects and from Architect G. Stanley Wilson. It is hoped that the gift of Mr. Wilson will set an example for other architects within the State who are financially able to contribute to the welfare of their profession.

The Council heard a report of the work of its legislative committee from Earl T. Heitschmidt, Chairman of that committee. It was gratifying to the Council to find that unification had been so

ably expressed and carried out in this one phase of the Council's activity. For the first time the architects of the State have been represented by a single legislative committee with whom the various groups have placed their moral and financial support. The committee has recognized its responsibility and is taking aggressive steps to clarify the position of the architect in regard to State work as well as to protect the interests of the architect from the usual nuisance bills which are presented at every meeting of the Legislature.

The legislative committee had been appointed with Statewide representation. It was determined that similar committees should be set up for public and professional relations and that the legislative committee should become the Governmental Relations Committee of the Council. In order to maintain coordination and records of the work done by these committees they will be asked to submit quarterly reports to the Council and these reports, in turn, will be available at all times for reference by any and all architects. The Council has appointed a liaison representative from the Council to cooperate with each of the committees. These liaison officers are: Public Relations, Loy Chamberlain; Professional Relations, Capt. Allan Sheet; Governmental Relations, Charles O. Matcham.

In discussing its public relations program the Council determined that a strong aggressive policy should be used and that the Council and its Chapters should, wherever possible, take active steps to promote the appointment of architects to key committee or directional positions in which their professional training qualifies them as leaders in planning. It was also brought out that it was not only necessary to have trained men in such positions but that they must be supported by the profession as a whole and that the Council, which represents the profession, should, wherever possible, cooperate with and assist such individual architects.

The Council believes that in California Architects, Incorporated, it has a sound corporate setup

(See Page 32)

The Minnatoma Project

By **GEORGE S. HILL**

For this project, as the name implies, it is proposed to acquire all of the property between Minna and Natoma Streets and to combine them into a thoroughfare 230 feet wide, extending from the Telephone Building to South Van Ness Avenue. Minna and Natoma Streets between Mission and Howard Streets are only 35 feet wide, and as they are virtually alleys, the property between them has a very low value and few improvements of a permanent nature. These consist mostly of one and two story frame or Class C buildings and are largely residential. Much of the housing is substandard, and the land is not being put to its best use. The land value at present is about \$100 per front foot, while that at Fifth and Market Streets is \$20,000 per front foot. The project, therefore, would seem to present an opportunity which few cities the size of San Francisco have, of acquiring at comparatively low cost an additional street of ample width in the central part of the city.

Market Street is 120 feet wide and has long been a greatly overloaded street. The arrangement of the blocks presents many traffic difficulties which will be multiplied as soon as normal conditions prevail. With new freeways from the Peninsula in prospect, some provision should be made for receiving and distributing the traffic before it reaches Market Street. Unless the Third Street entrance is retained and made adequate, the existing retail center will shift elsewhere. As San Francisco is a terminal city it is not a sufficient answer to the problem to through-route or detour the traffic. The need for additional wide streets parallel with Market Street has long been recognized. In 1906 City Engineer Marston Manson proposed the widening of Folsom Street. A broadening of the business district is essential in order to provide for future growth and development. As the proposed new street is less than 800 feet from Market Street, and therefore less than the distance from Third to Fourth Street, it will not disturb, but really help the present retail centers by reducing vehicular traffic congestion. As nearly all of the main streets south of Market Street are 82 feet 6 inches wide compared with only 68 feet 9 inches

north of Market Street, there will be ample redistribution facilities for traffic of all kinds.

As a matter of preliminary planning, it is proposed that the highway be divided into four portions 48 feet wide each, from curb to curb, providing 16 lanes of 12 feet each, and that there be a median strip 5 feet wide, two strips 1½ feet wide each, and two 15-foot sidewalks, making 230 feet in all. The service streets would be at the sides, with parking facilities. The central 8-lane divided highway would be for the faster through traffic and buses.

In Detroit, the master plan provides that all diagonals and arterials have super-highway rights of way 204 feet wide, but the problem of correcting conditions in the congested core of Detroit is only in process of solution. The famous Champs Elysees in Paris is 260 feet wide. Chicago is planning a system of freeways one block wide, with delivery at street level in the business center.

Similar to the Ferry Building at the foot of Market Street, the Pacific Coast office building of the American Telephone Company will be an object of interest at the end of the highway. Minna and Natoma Streets will pass on each side of it, and extend to the Bay Bridge Terminal with a combined width of 70 feet. The fast central lanes can be designed to pass under both Third and Howard Streets making a right angle turn and continuing as a freeway between Third and Hawthorne Streets, along the base of Rincon Hill to connect with the shore drive or marginal freeway proposed by Mr. Deming Tilton, and with the Bay Bridge.

The street will have a capacity for bus transportation on a large scale. It is planned to replace many of the street car lines with buses, and the use of buses for interurban service is expanding. Although buses are increasing in size they still have less capacity than street cars, hence the need for more street space.

The broad highway will serve as a fire break. Experience has shown that considerable width is necessary if a street is to serve effectively to prevent the spread of fires.



"MINNATOMA PROJECT"
- A LIMITED HIGHWAY -
230 FEET WIDE
PROPOSED BY GEORGE S. HILL, ENGINEER
JULY 4 1943

It is thought that this project will provide a stimulus for business and building expansion after the war. As San Francisco was chosen for the United Nations' Conference because it is a world center of communication, it is suggested that the vicinity of the Telephone Building might prove to be a suitable site for future development similar to Rockefeller Center in New York.

The aerial view was furnished, enlarged, and retaken through the generosity of the late Gabriel Moulin. It shows the relationship of this project

to Market, Mission, Howard, Folsom, and Harrison Streets and to the Bay Bridge. South Van Ness Avenue is in the foreground.

The estimated cost including all incidental items is \$10,000,000.

It is believed that this project will accomplish more in improving the transportation, traffic, and parking conditions in downtown San Francisco than can be accomplished in any other manner with an equal expenditure of time and money.

THE CONSTRUCTION OUTLOOK

Construction programs that have been announced by private enterprise and provided for by the Federal Government, which now total approximately \$21,000,000,000, give an indication of the enormous amount of construction that will be needed after the war. H. E. Foreman, managing director of the Associated General Contractors of America, declared in discussing the outlook for the industry.

"Private construction programs that have been publicly announced total about \$6,000,000,000 and the public programs about \$15,000,000,000," he explained. "Most of these programs cover periods of from five to ten years."

Construction programs totaling about \$750,000,000 have been announced by the automobile companies; \$150,000,000 by chemical and paper companies, \$300,000,000 by the theatrical industry and by colleges and universities, and about \$260,000,000 by a miscellaneous group of productive industries, he said. Utility companies have the largest program with a total of about \$4,000,000,000 for modernization and expansion.

The largest single construction potential that has been announced is new residential construction which the National Housing Agency estimates at about 1,000,000 units a year in the first decade after the war.

In public construction, the U. S. Corps of Engineers has a flood control and navigation program totaling about \$4,800,000,000 and the Bureau of Reclamation is developing a \$5,000,000,000 program, he stated. For Federal-aid highway construction, a program of \$3,000,000,000 over a three-year period has been provided, and for Federal-aid in airport construction, the program now pending in Congress calls for the expenditure of \$2,000,000,000 over a one-year period.

As further evidence of the need for construction, Mr. Foreman pointed out that statistics recently released by the Twentieth Century Fund on estimated capital outlays during the first 15 years after the war include about \$135,000,000,000 worth of construction of various kinds.

"These statistics," he continued, "definitely indicate that under favorable conditions construction can be an important factor in the transition from war to a prosperous peacetime economy. But both completed plans and adequate materials must be available in order for the industry to resume operations rapidly and on a scale that will provide jobs and the business stimulus that will be needed."

IN THE NEWS

RESUMPTION OF PRIVATE CONSTRUCTION PREDICTED

Most types of private construction can be resumed on a large scale as soon as cutbacks in war production become general, although the rate of increase in home building will be more gradual because of the time required to produce certain types of home equipment in quantity, James W. Follin, managing director of the Producers' Council, recently predicted.

"In addition, the volume of residential construction may be limited temporarily, even after war production has been sharply reduced, because of continued heavy need of lumber for military purposes.

"Although postwar construction cannot reach its peak until after most of the construction workers now in the armed forces have been demobilized, the beginning of general reconversion will release sufficient labor and materials to permit a volume of building at about the 1939 level," Follin reports.

A survey by the War Production Board indicates mechanical refrigerators and electric ranges will not be available in quantity until five or six months after manufacturers' war contracts are canceled.

The WPB indicates only a moderate quantity of new tools and equipment will be needed to permit all-out production of building products, inasmuch as manufacturers for the most part will concentrate in the early postwar period on modernized models of their prewar lines.

Ability of many manufacturers to produce building products in large volume is due to the fact that three-quarters or more have continued to produce their normal peacetime lines to supply the war construction program, war housing, and essential civilian needs.

PLASTIC-COATED FABRIC

A fire-resistant, plastic-coated upholstery fabric, developed for aircraft, tanks, and ships, is expected to find wide postwar usage in boats, restaurant seats, and office furniture, according to E. I. DuPont De Nemours and Company officials.

Consisting of a flameproofed cotton cloth base treated with a flexible fire resistant surface coating of synthetic resin, the material will char in contact with a flame but will not support combustion.

Known as P. C. "Cavalon" the fabric will be available in a range of colors, grains and finishes after the war.



Primary structural members U. S. Army training plane are of stainless steel.



Stainless Steel

In Modern Transportation Construction

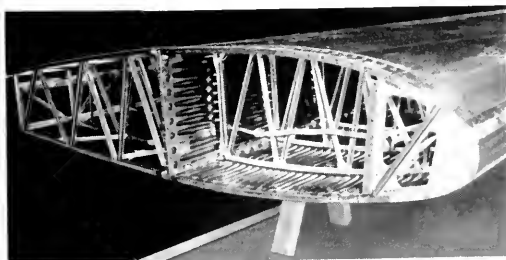

Section of outer wing panel all stainless steel airplane.

In streamlined, light, strong, and durable trailers and semitrailers, shown above, stainless steel has made possible exceptional speed and lightness which is combined with durability for modern commercial motor transport equipment.

(Photos through courtesy Electro Metallurgical Co.)

UNEMPLOYED TO BENEFIT

James G. Bryant, chairman of the California Employment Stabilization Commission, has stated that approximately 150,000 workers who never previously benefited by unemployment insurance will be under the system as the result of legislation passed by the recent Legislature covering employers hiring from one to three persons.

The waiting period for unemployment insurance was also reduced from two weeks to one week, thus claimants may obtain unemployment insurance funds a week sooner than previously.

UNIFICATION—ARCHITECTS

(From Page 27)

for aiding any promotional enterprises for the benefit of the profession. Since this corporation was in a state of formation at the time the Council succeeded the State Association, the Council's public relations officer, Mr. Chamberlain, was requested to clarify the entire picture of the corporation and its relationships with the Council. It is the intention of the original corporate corporation and of the Council that the corporation should remain in the control of the elected delegates of the profession.

The Council was given an informal review of the proposed By-Laws of the Southern California Chapter of The American Institute of Architects which are being revised to permit that Organization to become a District Chapter of the Council. It was also pointed out that the By-Laws Committee of the Northern California Chapter of The American Institute of Architects is about ready to present their By-Laws for review. It would appear that these District Chapters will be in existence as members of the Council before the end of this year.

The Council, in its informal discussions of proposed district society By-Laws, was of the opinion that so long as all registered architects were automatically eligible for membership in the district society the specific details of accomplishing this were not of importance. The Council believes that the present five Chapters of The American Institute of Architects will be able to arrive at practically identical By-Laws for the purpose of becoming District Chapters. In this way California can go even further toward promoting a solid front for unification. The fate of the Council and of unification would depend upon the wholehearted acceptance of the spirit of unification by the individual Chapters. It is apparent from the cooperation and information received to date that this is forthcoming.

IN THE NEWS

RUSSIAN RESTORATION

Restoration of cities in Russia, under the direction of Professor Vladimir Vitman, Chief Architect of the State Institute of Town Planning, is in full swing. They are tackling the restoration of thirty-eight cities that have been ruined by the Germans, including the ancient city of Orel, founded in the reign of Ivan the Terrible in the middle of the sixteenth century where more than half of the beautiful houses and buildings were burned and demolished by the invaders.

The general scheme is not merely rebuilding but includes beautification with parks, gardens and a thorough study of river vistas. As Professor Vitman says, "We base our projects of traditions of Russian city building which utilizes natural conditions and scenery as component parts of the landscape of the town and strive to create a complete ensemble." Orel was poor in public parks and gardens. This definitely is being corrected with a stadium on the bank of the Orlik River and a number of new gardens and squares in the residential district.

The ancient city of Bryansk, about a thousand years old, comes in for its share of restoration. Situated on the green slopes of three contiguous hills it has possibilities that are now to be developed for the first time. Bridges will be built over the deep ravines which separate the city into three parts, and the district between Bryansk and, Bezhitsa, in which large mills and factories were once located, will be turned into a forest and park of rest and recreation. Surely war and destruction have not destroyed the Russian spirit and love of home and beauty.

OPENS SALES OFFICE

The Dalmo-Victor Manufacturing Company have opened a branch sales office at number One Montgomery Street, San Francisco, California.

John B. Allen is in charge of flush valves and ship fittings, while Harry A. Minton, Jr., is in charge of window sales.

JAMES H. MITCHELL, AIA, architect, announces the removal of his office to 407 Sansome Street, San Francisco.

MARIO J. CIAMPI, architect, has moved from 85 San Pablo Avenue, San Francisco, to 3424 19th North, Tacoma, Washington.

IN THE NEWS

CENTRAL VALLEY PROJECT CONSTRUCTION TO GO AHEAD

Mr. Charles E. Carey, Regional Director of the Bureau of Reclamation, stated that "there is now definite indication that we may soon be given the green light to go ahead with the resumption of construction on the uncompleted central valley structures. The Central Valley Project structures yet to be built which will bring water to the San Joaquin Valley are among the largest of those authorized to date. These great projects will call for the work of many engineers and contractors. Let us hope that we have them.

GARAGE STYLING WITH OVERHEAD DOORS

A new all-aluminum overhead garage door that does away with hardware inside the garage is being offered the post-war residential garage market by the Berry Door Company of Birmingham, Michigan. All mechanism for operation of the door is compactly installed in a metal box 6"x6"x24" weighing only 18 pounds.



This feature makes it possible to lower the roof line of the garage to the top of the door opening, which helps considerably where living quarters are being planned above the garage.

Multiple installations of 8-foot doors can be used without the necessity of installing breaker strips or posts to separate the doors, and the door, weighing less than 60

pounds, may be hung and weather-stripped, ready for use, in less than thirty minutes. One man can do the job, simply by centering the door in the opening and fastening the two hanging brackets to the jambs with only four lag screws. After the lock, striker plate, and weatherstrips have been installed, the door is ready for operation.

RUSH (FybRglass) ERASERS

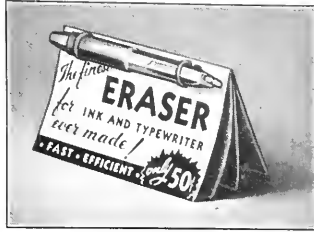

A new technique of erasing ink from tracing cloth, typing errors, and other erasures is contained in the RUSH (FybRglass) Eraser, which operates by a slight brushing stroke rather than rubbing as with the ordinary eraser.

Complete data on uses and utility of this product may be secured from The Eraser Company, Inc., Syracuse 2, New York.

VISUAL EQUIPMENT

The Educational Division of Bell & Howell, 7100 McCormick Road, Chicago 15, Illinois, recently published the "Architects' Visual Equipment Handbook", which is designed to show architects, school boards, church organizations and others how to plan or adapt rooms for showing motion pictures or other visual aids.

Technical advice on structural requirements and equipment specifications are included.

RURAL ELECTRIFICATION

Fewer than 100,000 farms were electrified prior to 1930. The total today is 2,600,000, with plans underway for the extension of lines to a million more three years after final V-Day.

F.H.A. LOANS

TO BUY—
REMODEL—
REFINANCE



Long-term and low-cost F. H. A. loans are still available to finance the purchase of homes already built. Monthly payment F. H. A. loans for buying or refinancing homes are made by this bank for as much as 80% of the appraised value of the property with as long as 20 years to repay.

For further information call
at our Real Estate Loan
Department

CROCKER FIRST NATIONAL BANK

OF SAN FRANCISCO
California's Oldest National Bank
ONE MONTGOMERY STREET
Member Federal Deposit Insurance Corporation

"KIMSUL"

Controlled Insulation!

THEMAL EFFICIENCY 0.27

Compressed in rolls for shipment and to save storage space, it stretches out over 5 times and when fully stretched gives a uniform designated thickness which insures the same maximum insulation value at all points.

Fire, Moisture and Vermin
Resistant
Extremely Light, Clean and
Easy to Install.

GUNN, CARLE & CO.

20 Potrero Avenue
San Francisco 3
UN 5480

LIGHT SAVING PAINT

Wartime experiments have proved still another means of conservation—light-saving with paint. The color of walls and ceilings, and even of floors and furnishings, have been found to have a direct bearing on both the saving of electricity and on improvement of seeing conditions. Surfaces that are covered with a light paint have a reflection value that can be measured in dollars and cents.

A store or dwelling may have excellent lighting fixtures and still not secure the good light it deserves because the finish of walls or ceiling is too dark. (Dark green or dark blue have as little as 9 to 10 per cent reflection value.) In order to receive full benefit, a light color combination should be used—and the closer to white a color scheme is, the greater will be the reflected light.

Indirect lighting has been proven to be preferable to direct lighting for most everyday uses. This method, of course, means the direct light is made indirect by some manner of reflecting the direct light, often by throwing that light to the ceiling and having it reflected to light the room without glare. If the ceiling has a low reflection value, a great amount of the light thrown on the ceiling is dissipated—money is sent to a ceiling never to return again. The reflectors of the light must be kept clear. A dark ceiling will absorb light and make indirect light inefficient and expensive.

A bright, sparkling interior that is immaculately clean helps greatly to sell products. A room that has inadequate lighting has dark corners, stuffy, dirty-looking nooks—not necessarily because of the presence of dirt or soot, but often because of murky shadows. These can be eliminated and a room made brighter and more cheerful by painting walls, ceilings, or other large expanses of surface a light color.

The type and texture of the paint used is very important. When paint becomes dirty it has little or no value as a reflector of light. For that reason the paint chosen should have a flat finish that can be washed easily and light reflection value can be maintained indefinitely. Ivory, white, light cream or buff in a mat finish are rightly popular.

The following list gives the percentage of light reflected by various standard colors: White (Casein), 90%; Ivory White, 79%; Cream, 74%; Aluminum, 73%; Yellow, 60%; Light Blue, 52%; Orange, 40%; Dark Red, 14%; Black, 2%.



A CYPRESS TREE AND INCIDENTALLY A RANCH

As might be expected in the vicinity of Monterey, the old Monterey cypress tree would dominate the landscape. Perhaps it is that our forbears loved the landscape and could not resist the desire to add to it. Whatever was their motive, the indigenous trees, the Monterey cypress and the Monterey pine, mark and bless many an otherwise bleak and barren spot. How often do we say, "Drive south until you come to a tall pine tree, then left"? These sentinels marking the place where some lover of trees registered his ambitions are today markers of the road.

CONTRACTORS GUIDE

The Contractors Guide, published jointly by the War and Navy Departments to aid war contractors in the settlement of their terminated war contracts, is now being distributed. The 60-page illustrated pamphlet is written in easy-to-read, non-legal language and should prove helpful to contractors in meeting their present and future contract settlement problems.

The Guide discusses how to claim reimbursement for contract settlement charges and how to plan in advance of termination. It contains Contract Settlement Proposal Forms filled out with actual figures.

Contractors may obtain this Guide, without cost, from their contracting officers or by writing to the Readjustment Distribution Center, 90 Church Street, New York 7, New York.

IN THE NEWS

PLANNING SAN FRANCISCO

The third number of the publication of the San Francisco Planning Commission has come out. As was stated last month this publication called "PLANNING" is a real joy, both to read and study.

The burden of the song in this issue is the subject of "FREEWAYS." The ARCHITECT AND ENGINEER has been harping away on this subject for the past few issues but has not presented the problem in so clear and concise a way as has this issue of "PLANNING."

As a matter of fact, San Francisco has no such freeway as may be found in Los Angeles in the Arroyo Seco Freeway and cannot realize what a boon to present day civilization it really is. The nearest approach to such a freeway is the Oakland-San Francisco Bay Bridge. Once you are on it you are on a real freeway and need not worry about in-coming traffic. But why go into all this here—it is all in the current issue of "PLANNING."

Perhaps it is because the editors must condense what they have to say into the four pages of the bulletin that everything in it is so brief and clear. Anyhow, their definitions and pictorial illustrations are so done that anyone who gives them the most limited study can quickly grasp the problem with which the issue is prepared. This month's is "FREEWAYS," and there is no mistake about it. Get it, if you have to steal it.

TALMAGE C. HUGHES, A.I.A., editor of the weekly bulletin "OF BY AND FOR ARCHITECTS OF THE UNITED STATES," as the bulletin puts it on its front page, has done, and is doing a great job in his particular branch of unification, one that might well be copied in other branches of the profession. However, it must be admitted that there is considerable ambiguity in title and address of editorial staff, etc., all of which is of little importance, as yet, if it can be developed that the welding of the interests into one active organization can be accomplished by bringing the National Council of Architectural Boards into camp. In the current issue of the bulletin the functions of the National Council are fully explained, but as in the case of so many other matters, the difference between the population density in the east and in the west leads to confusion. If an architect in Arizona contemplates work in Montana it will probably result in his moving there. In the east one may commute from one state to another.

Tomorrow's Home DEMANDS Adequate Wiring

Add up the many electrical conveniences that the home of tomorrow will demand, and you'll find that the average home of today is wired to carry only a fraction of the necessary future load.

Even though only a small percentage of homes may be *completely* electrified immediately after the war, every home will want to enjoy modern electrical conveniences and will add equipment as rapidly as possible.

Wiring for the postwar homes you are designing should be adequate for full, efficient operation of not just a few, but *all* appliances — electric range, refrigerator, dishwasher, garbage disposer, water heater, laundry equipment, air conditioning, television, sun lamps, better lighting — the list is practically endless.

Tomorrow's home buyers and builders will insist on wiring adequate for constantly expanding electrical service as the key to better living in the years ahead.



NORTHERN CALIFORNIA
ELECTRICAL BUREAU

1355 Market Street
San Francisco 3



WITH THE ENGINEERS

SACRAMENTO RIVER PROJECT

Approval by the U. S. Army Engineers of the \$16,000,000 Sacramento deep water ship channel, connecting California's capital city with San Francisco Bay, is an example of accomplishment by a community postwar planning committee.

Under leadership of the postwar planning committee of the Sacramento Chamber of Commerce, funds were raised and an economic survey made covering the Sacramento Valley and mountain counties, reaching as far north as southern Oregon and northwestern Nevada, to determine the permanent economic benefit to agriculture and manufacturing from such a project.

The project will provide approximately 750 jobs in the construction work over a period of about three years.

SIMPLIFIED PRACTICE RECOMMENDATIONS

The proposed simplified practice recommendation for cast brass solder-joint fittings has been approved for promulgation, according to an announcement of the Division of Simplified Practice of the National Bureau of Standards. The recommendation will be identified as R212-45, Cast Brass Solder-joint Fittings, and will be effective from July 1, 1945.

The recommendation sets up a stock list of cast brass solder-joint fittings representing the best thought of the industry, its distributors, and customers as to what constitutes desirable practice for the present and the postwar days to come.

CROSS CHANNEL PIPELINE

Although many stories have appeared on "Operation Pluto," some have been inaccurate from a technical standpoint in regard to various types of pipe used.

"Operation Pluto," the submarine pipeline system which carried gasoline across the English Channel to Allied Armies in France, was aided by U. S. Army Engineers through procurement of 140 miles of cable-type pipe. Four American manufacturers produced the special pipe under highly secretive conditions. A second type of pipe made wholly in England was also used.

The cable pipeline is of a similar construction to the protective cover which houses the famous trans-Atlantic cable. It is composed of a hollow lead pipe without a core, heavily reinforced with wire and provided with a special waterproof covering, and was laid from the holds of cable-laying ships.

Because of numerous hazards anticipated in

laying the pipeline across the treacherous Channel, another pipeline composed of 20-foot lengths of three-inch diameter steel pipe was developed by the British. This pipe could be welded automatically into any length and could be wound onto a drum-like thread on a spool. The welded steel pipe, though smaller, is similar to the submarine pipeline used by American Army Engineers to unload tankers in ship-to-shore operations. To use this pipe, huge floating drums were developed, capable of carrying the full length of pipe which might be required for the Channel crossing, and which could be towed by tugs, like a large bobbin playing off the pipe as it went. The 40-foot diameter and approximate 120-foot circumference of the drum was sufficient to permit the coiling of the semirigid steel pipe.

PROMOTED AT PERMANENTE

Carl R. Olson, general manager of the Permanente Cement Company, Oakland, California, has announced the promotion of Wallace A. Marsh to the position of assistant general manager, and James K. Beatty to general sales manager.

Jack Jansse has been named northern California district sales manager, and Festus T. McDonough, sales manager of the southern California district.

FOR SALE BUILDING NEWS

Pertinent facts relative to building and contracting projects contemplated in Northern California.

A DAILY ADVANCE news service giving name and location of project, architect, proposed cost, and other valuable information.

YOU GET DAILY REPORTS at a total cost of \$10 PER MONTH. Get prepared for the postwar building opportunities.

Subscribe for This Service Today

ARCHITECT'S REPORTS

Published Daily by

ARCHITECT and ENGINEER, Inc.

68 POST STREET, SAN FRANCISCO

EXBROOK 7182

A. I. A. ACTIVITIES



The two principal sources of information on the subject of the wishes and aspirations of the members of the American Institute of Architects on the Pacific Coast are, as might be expected, the two bulletins on the A.I.A. in Los Angeles and in San Francisco. Without their knowing it or in any way working together, they are covering the same field without appearing to do so. The difference this month is the fact that the Southern California bulletin has devoted most of its space to a book review while the Northern California told us about the various problems connected with the practice of architecture, but at least both pamphlets were on "Architecture." The Southern California bulletin devotes one-half of its printed space to the review of the latest of Lewis Mumford's new book entitled "City Development: Studies in Disintegration and Renewal," and as such is extremely well done. In fact, the various parts are reviewed more

or less in detail, but this sort of bulletin seems to be somewhat in the field of "over-viewing."

On the other hand, the Northern California bulletin covers a much wider field. In fact, it approaches the field of a magazine review of the various problems of the practice of the profession of architecture in general. Well, why not? That is, if the Chapter can keep it up financially. The subjects covered in the bulletin constitute a table of contents that would all but fill a well-developed monthly magazine rather than a bulletin. There are seventeen items listed in the contents on the first page and they are all worth reading. In fact, so well worth reading that at the end of each item you feel that more should have been said.

Not only is the content well arranged but the format, composition and typography are of a quality that is seldom equaled in modern commercial printing. Among the several items that should have statewide, or even nationwide circulation is the one on "SPECIALIZATION OF ARCHITECTS." There is a rapidly growing and misguided tendency on the part of the public to look for "specialists" in architecture—"Domestic architects," "Farm architects," "Business architects," "Hospital architects," and so on. A well-trained architect can do most of these as well as any specialist, at least that is the contention of the well-trained architect. The point is discussed in the bulletin.

a source of PRIDE



Residence of "Andy" Clyde, Hollywood, Calif.; Architect: Wendell W. Warren, Builder: T. A. Meyers

PAYNEHEAT
OVER 30 YEARS OF LEADERSHIP



**PAYNE
ZONE-CONDITIONING**

Successor to old-fashioned central heating. Write for Free booklet.

The owner's pride in this distinctive home may well be shared by all who had a hand in its creation: the architect whose skill is so evident, the builder whose craftsmanship shows in every detail and **PAYNE FURNACE COMPANY** whose gas-fired, warm-air heating installation assures care-free, lifelong comfort.

**PAYNE
FURNACE COMPANY**
(One of the **DRESSER** Industries)
BEVERLY HILLS, CALIFORNIA

*Be sure you're getting the
finest window glass obtainable*

it costs no more to specify

PENNUERNON

Distributed by...

W · P · FULLER & CO.
PAINTS • GLASS • WALLPAPER

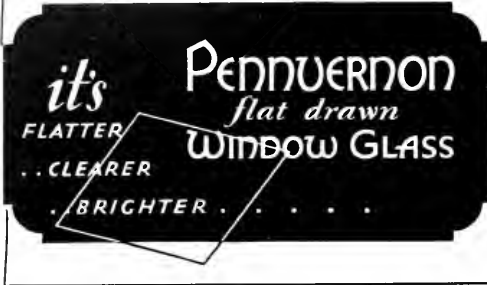

DEPENDABLE QUALITY AND SERVICE

WE MANUFACTURE OR SUPPLY

DOUGLAS FIR
REDWOOD
SUGAR OR
PONDEROSA PINE
SASH AND DOORS
MILLWORK
MASONITE TEMPERED PRESWOOD
CONCRETE FORM PANELS
CEMENT ASBESTOS BOARD
INSULATION AND
INSULATION BOARD
INSULATION TILE AND PLANK
PLASTER BOARD
FIR-TEX INSULATION PRODUCTS
TRIPLE-SEALED GYPLAP
SISALKRAFT BUILDING PAPER
ROOFING
WOODLIFE WATER REPELLANT
BUILDERS HARDWARE

E. K. WOOD
LUMBER COMPANY

LOS ANGELES, SAN FRANCISCO, OAKLAND

Another is the distinction between the types of architect that are chosen for public work.

The "small homes" problem is well brought out as is the legislative work of the Council of the California Architects, although just where they fit in with the A.J.A. has never been clearly explained. There are a number of other items, well and succinctly discussed, that should be read to get their value and it is to be hoped that this form of bulletin may be carried on and enlarged.

The notes on "The Typography of This Issue" are delightful, if debatable in spots. At least they call to attention the innumerable problems of typography which often bring no other comment from the lay reader than "Gee! Ain't this a lousy piece of printing!"

PRACTICE RECOMMENDATIONS

Printed copies of Simplified Practice Recommendation R207-45, Pipes, Ducts, and Fittings for Warm Air Heating and Air Conditioning, are now available, according to an announcement of the Division of Simplified Practice, National Bureau of Standards.

The recommendation sets up a stock list of pipes, ducts, and fittings representing the best thought of the industry, its distributors, and customers as to what constitutes desirable practice for the present and the postwar days to come.

Fittings for both gravity and forced air heating and air conditioning systems are covered, the former including double-wall pipe and fittings.

There is a total of about 1,223 items in the list, whereas at least one large producer has recently catalogued not less than 5,580 varieties of pipes, ducts, and fittings for the same types of installations covered by the recommendation. On the basis of information submitted by manufacturers when the Division was cooperating with the War Production Board on this subject, it is estimated that the recommendation will effect a reduction of about 40 per cent.

BRITAIN'S NEW ROADS

When British motorists again take to the roads they will find their old road maps sadly out of date.

New roads are the reason.

Roads that were built to rush men and materials to meet the threatened Nazi invasion, and roads that were built to by-pass towns and villages to speed the D-Day armies, have been built by engineers who worked in gangs of hundreds.

Civilians will soon acquaint themselves and become familiar with these new roads, British authorities predict.

IN THE NEWS

POSTWAR PROJECTS

Ninety thousand seven hundred postwar projects costing an estimated \$14,815,613,000 have been reported by the field staff of the F. W. Dodge Corporation, covering the area east of the Rocky Mountains.

Of these, 30,217, amounting to \$7,231,295,000, have progressed to the design stage.

UNDERGROUND PIPE

"Therm-O-Tyle, The Conduit for Underground Pipe Lines," is the title of a bulletin recently published by H. W. Porter & Co., 825 Frelinghuysen Avenue, Newark 5, N. J.

The content covers the subject of quality, strength, and initial cost.

REGAN BANK TYPE RESISTOR

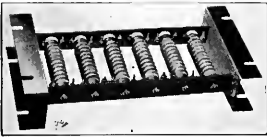

The Techtmann Industries, Inc., have announced the development of the Regan Bank-type Resistor, which can be built in banks of from 2 to 24.

In the event of burnout of the element, due to overloading, replacement is a matter of minutes as the glazed Steatite cores are easily removed for new element winding.

Complete data is available from the manufacturer, 828 N. Broadway, Milwaukee 2, Wisconsin.

OPENS OFFICE. A. McF. McSweeney, Architect, has opened offices in the Hearst Building, San Francisco, Room 927. He desires recent catalogs.

WINFIELD HADSELL HYDE, Architect, has opened offices at Room 607, Hobart Building, San Francisco. He desires recent catalogs.

BUY U. S. WAR BONDS AND HOLD THEM!

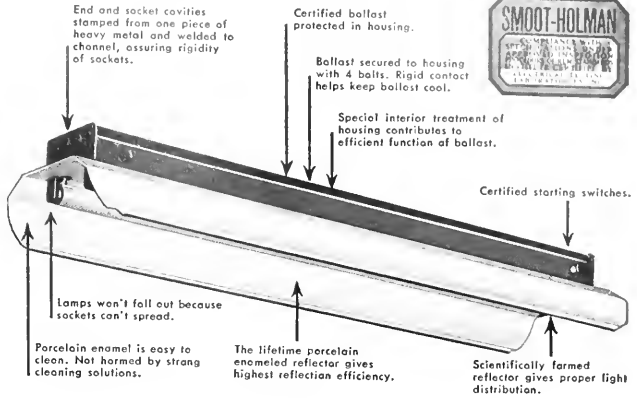

*Why Buy
Certified Quality?*

Because the many features which enable Smoot-Holman to certify highest quality provide equipment giving the most light with the least maintenance cost. The RLM label is an additional guarantee, because RLM quality is policed by independent testing laboratories. Rated orders for Smoot-Holman certified equipment are now being filled—general distribution must await V-J day.

BUY U. S. WAR BONDS AND HOLD THEM



Offices in Principal Western Cities—Branch and Warehouse in San Francisco

PRODUCERS' COUNCIL PAGE

Northern California Chapter

The National Organization of Manufacturers of Quality Building Materials and Equipment
Affiliated with the AMERICAN INSTITUTE OF ARCHITECTS



H. C. "Herb" GALITZ

Handsome Herb Galitz is another member of that active Westinghouse team, and is currently serving on the Membership and Attendance Committee.

Herb's youthful appearance belies his long years of service and other accomplishments. He started back in 1924

with Kaestner and Hecht, Westinghouse agents in Chicago, his home town. Westinghouse acquired his company and Herb in 1926 and he has been with them ever since, moving to their new headquarters in Jersey City in 1937 and to San Francisco in 1939, where he now serves as Pacific Coast Application Engineer.

He is the proud father of four sons, two of them twins, born March 1, 1945.

He enjoys bowling, fishing and especially the association with the Producers' Council, Herb says.

FRANK E. COX, Field Coordinator, Business Planning Institute of California, interesting speaker at our June meeting, presented a profitable opportunity for Architects and Producers through a program similar to the Home Planning Institutes, to do a job for merchants. One of the phases of the program is education in store modernization. Retail sales set-up of the country must be vastly

expanded if the volume of goods necessary to maintain the kind of economy we're shooting at is to be distributed. And therein lies a major market that should interest many of our members.

OUR ATTENDANCE PLAN is stirring up interest in Chapter circles. Subject of a thorough "going over" at a Chapter business session in July no better plan could be suggested. In spite of criticism as to some details it must be admitted that the plan works. It unquestionably accomplishes its major aim . . . it brings out the attendance, both members and guests.

COMMITTEE FOR ECONOMIC DEVELOPMENT SAYS, "It takes twice as long to plan a project as it does to build it. Malcolm Pirnie, Chairman of the American Society of Civil Engineers. . . . CED committee estimates that of the \$19.9 billion construction projects proposed this far only \$8 billion have advanced to the planning stage and only one billion or about 5 per cent are ready for bids.

He points out the danger of delay by reporting that in the '30's when the Federal Government had three billion dollars to spend on useful public works, let to contract after bidding, it was 18 months before 100,000 were at work.

So let's get busy!



USE QUALITY PRODUCTS



CONSULT AN ARCHITECT

BOOK REVIEWS

SIMPLIFIED DESIGN OF STRUCTURAL STEEL.

By Harry Parker. Published by John Wiley & Sons, Inc. Price \$2.75.

Mr. Parker has succeeded in clearing away the smoke screen of higher mathematics that usually accompanies texts on engineering. Only a working knowledge of high school algebra and arithmetic is required to understand this book.

The fourth of a series of elementary books on structural design, the book will be of particular interest to architectural men.

No new methods or short cuts in design are presented. Rather the book takes the reader through the principles and methods of design in easy and concise steps.

A great deal of the text consists of illustrative examples covering the design of the more common steel members found in building constructions.

Tables necessary for structural engineering are included in order to eliminate additional reference books.

—L. H. NISHKIAN.

BUILDING CONSTRUCTION ESTIMATING. By

George H. Cooper, in Charge of Estimating Classes of Mechanics Institute, New York City. Published by McGraw-Hill Book Company, Inc., 1945. 282 Pages. Price \$3.00.

AH! here's a book! Buildings and books are seldom successful in their multi-purpose intentions but this is a book that will prove invaluable to architects, engineers, designers, contractors and laymen.

The author does not confine himself to the arithmetic of estimating nor the forms of the necessary accounting. He goes into plans and details of construction with a thoroughness that results in a book that would be a reference for architectural designers. For instance, there are details on concrete work, masonry, wood framing, roofing and sheet metal work that seem to be far outside mere estimating and yet are necessary properly to approach the estimating problem.

Details on wood and steel trusses are drawn with dimensions so complete that only the most advanced designers need have further recourse to reference. There are floor plans, roof plans, sections, and elevations in excellent detail, better than most architects' working drawings. At first glance the book, with its profusion of illustrations, impresses one as a publication on architecture,

JOHNSON OIL BURNERS WILL CUT YOUR FUEL BILLS!

Yes, that's a pretty strong claim . . . but don't just brush it aside with a skeptical wave of the hand. It's a tested and proveable fact that Johnson Burners capture and use an exceptionally high percentage of the potential heat in every gallon of fuel they burn.

And don't think that's just a lucky accident. We've spent over 40 years of effort and research and study in developing the super-efficiency of these famous burners . . . years that were marked by sweat rather than four-leaf clovers.

In those long years, we've learned a lot of other things too, about building fine burners . . . how to minimize wear and noise, how to simplify and improve automatic action, and how to build years and years of carefree life into every one of them.

Whether you have a hotel to heat or a 5-room house, it will pay you well to investigate Johnson Burners before you buy.

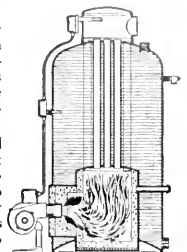

Aqualux Water Heaters
... one of the many fine heating units built by Johnson.

... *Johnson Oil Burners* ...

S. T. JOHNSON CO.

940 Arlington Ave., Oakland 8, Calif.

401 No. Broad St., Philadelphia 8, Pa.

BAXCO
CHROMATED ZINC CHLORIDE

CCZC

PRESSURE TREATED LUMBER
● **PROTECTS AGAINST DECAY**
AND TERMITE ATTACK

Specify it in your home
Available through Lumber Dealers

LOS ANGELES
601 W. 5th Street
Phone Michigan 6294

SAN FRANCISCO
333 Montgomery Street
Phone DOUGLES 3883

J. H. Baxter & Co.

AGENTS FOR WEST COAST WOOD PRESERVING CO. SEATTLE, WASH.

but the estimating forms and instructions will be found quite complete. If you are an architect employing several draftsmen you had better purchase at least two copies, for your men will wear one out in no time.

YES, HERE'S A BOOK!

—Ed.

BUILDING OR BUYING A HOUSE. By B. K. Johnstone & Associates. McGraw-Hill Book Company, Inc., Publishers. (Whittlesey House) 1945. 154 Pages. Price \$2.75.

As the title might imply, this book is written for the layman, although some architects may find a bit here and there of interest to them professionally. The advices given are generally sound even if they are a bit youthful. To an experienced architect they would add little to his lore although he might use some of it in his usual admonitions to his clients.

Most of the illustrations are from sketches and none of them is to scale. The check lists of things to be examined and looked for in the hunt for a house to buy are good and practical although sizes and dimensions seem to have been chosen rather arbitrarily. It is a good book for the layman to pack around with him on his house hunting tour.

—Ed.

THERMOPLASTIC MATERIALS

The CELANESE PLASTICS CORPORATION has brought out a book entitled "FABRICATING METHODS FOR LUMARITH, CELLULOID, AND SIMILAR THERMOPLASTIC MATERIALS" (obtainable at 180 Madison Avenue, New York 16, N. Y. Price \$1.00) which contains more information of the kind wanted by the fabricators than is found in the average run of short books on the subject.

The difference between the treatment of LAMARITH and that of CELLULOID (whether and when a coolant is needed, for instance) is explained. Substantially all the problems that might confront a fabricator are dwelt upon in type and illustrations. The book has 129 pages, numerous illustrations in half-tones and line drawings, and is well indexed. To one who is working in thermoplastics it will undoubtedly prove to be a valuable aid.

EUROPEAN ARMIES CONSUMED GAS

Between D-Day and V-E Day the Transportation Corps imported and delivered 1,645,145,840 gallons of gasoline, oil and lubricants to depots and air bases on the continent of Europe. An average of 5,000,000 gallons a day.

In prewar days this would have been enough gasoline to propel every motorized vehicle in the world from New York City to Chicago.

HOGAN LUMBER CO.

Wholesale and Retail

LUMBER

MILL WORK • SASH & DOORS

Office, Mill, Yard and Docks

SECOND AND ALICE STREETS • OAKLAND, CALIF.

Telephone GLencourt 6861

CLINTON CONSTRUCTION CO.

OF CALIFORNIA

General Contractors

923 FOLSOM STREET • SAN FRANCISCO

SUtter 3440

MALOTT & PETERSON

ROOFING AND FLOORING
CONTRACTORS

20TH AND HARRISON STREETS

SAN FRANCISCO

Phone ATwater 1600

SANTA MARIA INN

SANTA MARIA, CALIFORNIA

FRANK J. MCCOY, General Manager

FERNAND E. PIMENTEL, Manager

On the
Coast
Highway
between
San
Francisco
and
Los
Angeles



American
or
European
Plan
•
Old
English
Tap
Room

ARCHITECT AND ENGINEER

ESTIMATOR'S GUIDE

BUILDING AND CONSTRUCTION MATERIALS

PRICES GIVEN ARE FIGURING PRICES AND ARE MADE UP FROM AVERAGE QUOTATIONS FURNISHED BY MATERIAL HOUSES TO SAN FRANCISCO CONTRACTORS. 2½% SALES TAX ON ALL MATERIALS BUT NOT LABOR

All prices and wages quoted are for San Francisco and the Bay District. There may be slight fluctuation of prices in the interior and southern part of the state. Freight cartage, at least, must be added in figuring country work.

BONDS—Performance—\$10 per \$1000 of contract. Labor and materials, \$10 per \$1000 of contract.

BRICKWORK—

Common Brick—Per 1M laid—\$50.00 to \$60.00 (according to class of work).

Face Brick—Per 1M laid—\$120 to \$150 (according to class of work.)

Brick Steps—\$1.60 per lin. ft.

Brick Veneer on Frame Bldg.—Approx. \$1.30 per sq. ft.

Common Brick—\$19.00 per M, truckload lots, f.o.b. job.

\$19.00 per M, less than truckload, plus cartage.

Face Brick—\$40 to \$80 per M, truckload lots, delivered.

Cartage—Approx. \$4.00 per M.

BUILDING PAPER—

1 ply per 1000 ft. roll.....	\$3.50
2 ply per 1000 ft. roll.....	5.00
3 ply per 1000 ft. roll.....	6.75
Brownskin, Standard, 500 ft. roll.....	5.00
Siselkraft, 500 ft. roll.....	5.00
Sash cord com. No. 7.....	\$1.20 per 100 ft.
Sash cord com. No. 8.....	1.50 per 100 ft.
Sash cord spot No. 7.....	1.90 per 100 ft.
Sash cord spot No. 8.....	2.25 per 100 ft.
Sash weights, cast iron, 550.00 ton.	
Nails, \$3.42 base.	
Sash weights, \$45.00 per ton.	

CONCRETE AGGREGATES—

The following prices net to Contractors unless otherwise shown.

Gravel, all sizes —		
\$1.95 per ton at Bunker; delivered.....	\$2.50	
	Bunker	Del'd
Top Sand.....	\$1.90	\$2.50
Concrete Mix.....	1.90	2.45
Crushed Rock, ¼" to ¾".....	1.90	2.50

Crushed Rock, ¾" to 1½".....	1.90	2.50
Roofing Gravel.....	2.25	2.80
River Sand.....	2.00	2.45

Sand—

River Sand.....	2.00	2.45
Lapis (Nos. 2 & 4).....	2.85	3.15
Olympia (Nos. 1 & 2).....	2.85	3.10
Del Monte White.....		.84c per sack

Cement—

Common (all brands, paper sacks), carload lots, \$2.42 per bbl. f.o.b. car; delivered \$2.72. Cash discount on carload lots, 10c a bbl., 10th prox; less than carload lots \$3.20 per bbl. f.o.b. warehouse or delivered. Cash discount 2% on L.C.L.

Atlas White } 1 to 100 sacks, \$2.50 sack
Calaveras White } warehouse or del.; \$7.65
Medusa White } bbl. carload lots.

Forms labor average \$350 per 1000 sq. feet.

Average cost of concrete in place, 50c per cubic foot, exclusive of forms; \$15.00 per cubic yard. With forms \$1.60 per cubic foot.

DAMP-PROOFING and Waterproofing—

Two-coat work, \$3.50 per square.

Membrane waterproofing—4 layers of saturated felt, \$7.00 per square.

Hot coating work, \$2.50 per square.

Madusa Waterproofing, \$3.50 per lb. San Francisco Warehouse.

Tricocel waterproofing.

{See representative.}

ELECTRIC WIRING—\$12 to \$15 per outlet

for conduit work (including switches).

Knob and tube average \$3.00 per outlet. (Available only for priority work.)

ELEVATORS—

Prices vary according to capacity, speed and type. Consult elevator companies. Average cost of installing a slow speed automatic passenger elevator in small four story apartment building, including entrance doors, about \$6500.00.

EXCAVATION—

Sand, 60 cents; clay or shale \$1 per yard.

Trucks, \$20 to \$32 per day.

Above figures are an average without water. Steam shovel work in large quantities, less; hard material, such as rock, will run considerably more.

FIRE ESCAPES—

Ten-foot galvanized iron balcony, with stairs, \$150 installed on new buildings; \$160 on old buildings.

FLOORS—

Composition Floors, such as Magnesite, 50c per square foot.

Linoform—2 gages—\$1.25 to \$2.75 per sq. yd.

Mastopave—90c to \$1.50 per sq. yd.

Battleship Linoleum—available to Army and Navy only—1/8"—\$1.75 sq. yd. 1/4"—\$2.00 sq. yd.

Terazzo Floors—50c to 70c per sq. ft.

Terazzo Steps—\$1.75 per lin. ft.

Mastic Wear Coat—according to type—20c to 35c.

Hardwood Flooring—

Standard Mill grades not available.

Victory Oak—T & G

1½" x 2¼"..... \$143.25 per M. plus Cartage

1/2" x 2"..... 122.00 per M. plus Cartage

1/2" x 1½"..... 113.50 per M. plus Cartage

Prefinished Standard & Better Oak Flooring

1½" x 3¼"..... \$160.00 per M. plus Cartage

1/2" x 2½"..... 160.50 per M. plus Cartage

Maple Flooring

1½" T & G Clear \$160.50 per M. plus Ctg.

2nd 153.50 per M. plus Ctg

3rd 131.25 per M. plus Ctg.

Floor Layers' Wage, \$1.50 per hr.

GLASS—

Single Strength Window Glass..... 20c per □ ft

Double Strength Window Glass..... 30c per □ ft.

Plate Glass, under 75 sq. ft..... \$1.00 per □ ft.

Polished Wire Plate Glass..... 1.40 per □ ft.

Rgh. Wire Glass..... .34 per □ ft.

Obscure Glass..... .27 per □ ft.

Glazing of above is additional.

Glass Blocks..... \$2.50 per □ ft. set in place

HEATING—

Average, \$1.90 per sq. ft. of radiation, according to conditions.

Warm air (gravity) average \$48 per register.

Forced air, average \$68 per register.

IRON—Cost of ornamental iron, cast iron, etc., depends on design.

LUMBER—All lumber at O.P.A. ceiling prices—

No. 1 Common	\$49.00 per M
No. 2 Common	47.75 per M
Select O. P. Common	52.75 per M

Flooring—

Delvd.	
V.G.-D.F. B & Btr. 1 x 4 T & G Flooring	\$80.00
C 1 x 4 T & G Flooring	75.00
D 1 x 4 T & G Flooring	65.00
D.F.-S.G. B & Btr. 1 x 4 T & G Flooring	61.00
C 1 x 4 T & G Flooring	59.00
D 1 x 4 T & G Flooring	54.00
Rwd. Plastic—"A" grade, medium dry	82.00
"B" grade, medium dry	78.50

Plywood—not available

	Under \$200	Over \$200
"Plyscord"— $\frac{3}{8}$ "	\$49.50	\$47.55
"Plywall"— $\frac{1}{4}$ "	45.15	43.30
3 ply— $\frac{2}{8}$ — $\frac{1}{4}$ "	48.55	46.60
"Plyform"— $\frac{5}{8}$ "—		
Unoiled	126.50	121.45
Oiled	127.90	122.75

Above prices delivered if quantity is sufficient to warrant delivery.

Shingles (Rwd. not available)—

Red Cedar No. 1—\$6.75 per square; No. 2, \$5.75; No. 3, \$4.45.
Average cost to lay shingles, \$3.00 per square.
Cedar Shakes—Tapered: $\frac{1}{2}$ " to $\frac{3}{8}$ " x 25"—\$8.95 per square.
Resawn: $\frac{3}{4}$ " to $1\frac{1}{4}$ " x 25"—\$10.65 per square.
Resawn: $\frac{3}{8}$ " to $1\frac{1}{4}$ " x 25"—\$10.65 per square.
Average cost to lay shakes, \$4.00 per square.

MILLWORK—Standard.

D. F. \$100 per 1000. R. W. Rustic \$100.00 per 1000 (delivered).
Double hung box window frames, average with trim \$6.50 and up, each.
Complete door unit, \$10.00.
Screen doors, \$3.50 each.
Patent screen windows, 25c a sq. ft.
Cases for kitchen pantries seven ft. high, per lineal ft., \$9.00 each.
Dining room cases, \$9.00 per lineal foot.
Rough end finish about 80c per sq. ft.
Labor—Rough carpentry, warehouse heavy framing (average), \$40.00 per M.
For smaller work average, \$40.00 to \$55.00 per 1000.

MARBLE—(See Dealers)

PAINTING—

Two-coat work	per yard	50c
Three-coat work	per yard	70c
Cold water painting	per yard	10c
Whitewashing	per yard	8c

PAINTS—

Two-coat work	50c per sq. yd.
Three-coat work	70c per sq. yd.
Cold water painting	per yard 10c
Whitewashing	8c per sq. yd.
Turpentine	\$1.03 per gal. in drum lots.
	\$1.05 per gal. in 5-gal. containers.
Raw linseed Oil	not available.

Boiled Linseed Oil—\$1.38 per gal. in drums. Available only to work with high priority—\$1.48 per gal. in 5-gal. containers.

Use replacement oil—\$1.86 per gal. in 1-gal. containers.

Replacement Oil—\$1.20 per gal. in drums. \$1.30 per gal. in 5-gal. containers.

A deposit of \$6.00 required on all drums.

PATENT CHIMNEYS—

6-inch	\$1.20 lineal foot
8-inch	1.40 lineal foot
10-inch	2.15 lineal foot
12-inch	2.75 lineal foot

PLASTER—

Neat wall, per ton delivered in S. F. in paper bags, \$17.60.

PLASTERING (Interior)—

3 Coats, metal lath and plaster	Yard 1.50
Keene cement on metal lath	1.80
Ceilings with $\frac{3}{4}$ hot roll channels metal lath (lath only)	1.20
Ceilings with $\frac{3}{4}$ hot roll channels metal lath plastered	2.20
Single partition $\frac{3}{4}$ channel lath 1 side (lath only)	1.20
Single partition $\frac{3}{4}$ channel lath 2 inches thick plastered	3.20
4-inch double partition $\frac{3}{4}$ channel lath 2 sides (lath only)	2.20
4-inch double partition $\frac{3}{4}$ channel lath 2 sides plastered	3.85
Thermax single partition; 1" channels; 2" overall partition width. Plastered both sides	3.30
Thermax double partition; 1" channels; $4\frac{3}{4}$ " overall partition width. Plastered both sides	4.40
3 coats over 1" Thermax nailed to one side wood studs or joists	1.65
3 coats over 1" Thermax suspended to one side wood studs with spring sound isolation clip	1.90
Note—Channel lath controlled by limitation orders.	

PLASTERING (Exterior)—

2 coats cement finish, brick or concrete wall	Yard 1.00
3 coats cement finish, No. 18 gauge wire mesh	2.00
Lime—\$3.00 per bbl. at yard.	
Processed Lime—\$3.10 bbl. at yard.	
Rock or Grip Lath— $\frac{3}{8}$ "—20c per sq. yd.	
" " "—19c per sq. yd.	

Composition Stucco—\$1.60 to \$2.00 sq. yard (applied).

PLUMBING—

From \$100.00 per fixture up, according to grade, quantity and runs.

ROOFING—

"Standard" tar and gravel, 4 ply—\$8.00 per sq. for 30 sqs. or over.	
Less than 30 sqs. \$9.50 per sq.	
Tile, \$30.00 to \$40.00 per square.	
Redwood Shingles, \$7.50 per square in place.	
5/2 #1-16" Cedar Shingles, 4 1/2" Exposure	\$8.00 square

5/8 x 16"—#1 Cedar Shingles, 5" Exposure	\$9.00 square
4/2 #1-24" Royal Shingles, 7 1/2" Exposure	\$9.50 square
Re-coat with Gravel	\$4.00 per sq.
Asbestos Shingles, \$23 to \$28 per sq. laid.	
1/2 x 25" Resawn Cedar Shakes, 10" Exposure	\$10.50
3/4 x 25" Resawn Cedar Shakes, 10" Exposure	11.50
1 x 25" Resawn Cedar Shakes, 10" Exposure	12.50
Above prices are for shakes in place.	

SHEET METAL—

Windows—Metal, \$1.75 a sq. ft.
Fire doors (average), including hardware \$2.00 per sq. ft.

SKYLIGHTS—(not glazed)

Copper, 90c sq. ft. (flat).
Galvanized iron, 40c sq. ft. (flat).
Vented hip skylights 60c sq. ft.

STEEL—STRUCTURAL (None available except for defense work).

\$150 ton (erected), this quotation is an average for comparatively small quantities. Light truss work higher. Plain beams and column work in large quantities \$140 per ton.

STEEL REINFORCING (None available except for war work).
\$100 to \$130 ton, set.

STONE—

Granite, average, \$6.50 cu. foot in place
Sandstone, average Blue, \$4.00. Boise, \$3.00 sq. ft. in place.
Indiana Limestone, \$2.80 per sq. ft. in place.

STONE FRONTS (None available).

TILE—

Ceramic Tile Floors—\$1.00 to \$1.25 per sq. ft.
Cove Base—\$1.10 per lin. ft.
Glazed Tile Wainscot—\$1.25 per sq. ft.
Asphalt Tile Floor $\frac{1}{8}$ " & $\frac{3}{8}$ "—\$.18 to \$.35 per sq. ft. Light shades slightly higher.
Cork Tile—\$.40 to \$.75 per sq. ft.
Mosaic Floors—see dealers.
Lino-Tile, \$.35 to \$.75 per sq. ft.

Wall Tile—

Glazed Terra Cotta Wall Units (single faced) laid in place—approximate prices:	
2 x 6 x 12	\$1.10 sq. ft.
4 x 6 x 12	1.25 sq. ft.
2 x 8 x 16	1.20 sq. ft.
4 x 8 x 16	1.40 sq. ft.

VENETIAN BLINDS—

40c per square foot and up. Installation extra.

WINDOWS—STEEL—

30c per square foot, \$5 for ventilators.

IN THE NEWS

TALK-A-PHONE BOOSTER

A new and improved HP-16 Booster, development of the Talk-A-Phone Electronic Laboratories, enables the executive to have both

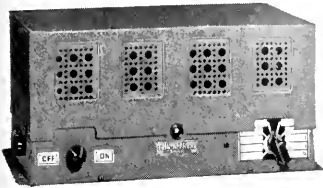

his office and factory at his finger tips.

Capable of delivering sufficient "voice range" power to cover the average paging system, additional boosters may be used where greater power levels are necessary.

Neat and compact, the unit is equipped with easily accessible "On-Off" switch, "Pilot Light" indicator and variable "Volume Control".

Complete information is available by writing the company at 1512 So. Pulaski Road, Chicago 23, Illinois.

been approved by promulgation, according to the recommendation of the Department of Labor and Practice of the National Bureau of Standards.

Effective immediately will be identified as R211-1.

AUSTIN AVIATION EXPANDS

The Austin Company, engineers and builders, have announced the establishment of a new Austin Aviation Division with headquarters at Cleveland, Ohio.

W. R. Engstrom, district manager in the Pacific Northwest since 1933, has been placed in charge of the new offices.

CLAY SEWER PIPE

A simplified practice recommendation for Clay Sewer Pipe has

POST-WAR IRONING TABLE

Another household product soon to become available is the "Lyon" ironing table.

Announcement of the product is made in a four-page brochure just issued by the company.

Embodying numerous features including a patented lock and a steel substructure, in the standard size table of 15" wide by 54" long, these tables will be manufactured by Lyon Metal Products, Inc., Aurora, Illinois, and distributed throughout the country by the company's 16,000 dealers.

1945 BUILDING TRADES WAGE SCALES (JOB SITES) NORTHERN CALIFORNIA

Six- and seven-hour day eliminated on all Government Work. A. F. L. - O. P. M. Agreement calls for eight-hour day.

NOTE: Predeterminations by the Department of Labor, as of July 1, 1944 (the wage-freezing date) have not yet been made in all of the counties listed. The wage scales shown are those being paid and in effect mostly by agreement between employees and their union.

CRAFT	San Francisco	Alameda and Contra Costa	Fresno	Marin	Sacramento	San Jose	San Mateo	Vallejo	Stockton
	San Francisco	Alameda and Contra Costa							
ASBESTOS WORKERS	1.50	1.50	1.25	1.50	1.50	1.75	1.50	1.75	1.50
BRICKLAYERS	1.87½	1.87½	1.75	1.87½	1.75	2.00	1.79-1/6	1.75	1.25
BRICKLAYERS' HODCARRIERS	1.40	1.40	1.05	1.50	1.05	1.50	1.35	1.50	1.14
CARPENTERS	1.50	1.50	1.25	1.43¾	1.37½	1.37½	1.43¾	1.50	1.37½
CEMENT FINISHERS	1.50	1.50	1.50	1.50	1.50	1.50	1.50	1.50	1.50
ELECTRICIANS	1.70	1.70	1.70	1.70	1.70	1.70	1.70	1.70	1.70
ELEVATOR CONTRACTORS	1.75½	1.75½	1.75½	1.75½	1.75½	1.75½	1.75½	1.75½	1.75½
ENGINEERS: MATERIAL HOIST	1.50	1.50	1.25	1.50	1.37½	1.62½	1.50	1.37½	1.25
PILE DRIVER	1.75	1.75	1.60	1.75	1.75	1.75	1.75	1.75	1.60
STRUCTURAL STEEL	1.75	1.75	1.60	1.75	1.75	1.75	1.75	1.75	1.60
GLASS WORKERS	1.40	1.40	1.12½	1.40	1.12½	1.21	1.40	1.40	1.40
IRONWORKERS: ORNAMENTAL	1.40	1.50	1.60	1.50	1.60	1.31¼	1.50	1.50	1.50
REINF. RODMEN	1.50	1.50	1.60	1.50	1.60	1.50	1.50	1.50	1.25
STRUCTURAL	1.75	1.75	1.75	1.75	1.75	1.75	1.75	1.75	1.37½
LABORERS: BUILDING	1.00	1.00	.90	.87½	.95	.90	.93¾	.90	1.00
CONCRETE	1.00	1.00	.90	.87½	.95	.90	.93¾	.95	1.00
LATHERS	1.75	1.75	1.50	1.75	1.60	1.75	1.75	1.75	1.75
MARBLE SETTERS	1.50	1.50	1.50	1.50	1.50	1.50	1.50	1.50	1.50
MOSAIC & TERRAZZO	1.25	1.25	1.12½	1.25	1.15-5/8	1.12½	1.25	1.25	1.25
PAINTERS	1.50	1.50	1.26-4/7	1.50	1.43	1.50	1.42-6/7	1.64-2/7	1.37½
PILEDRIVERS	1.54	1.54	1.54	1.54	1.54	1.54	1.54	1.54	1.54
PLASTERERS	1.75	1.83½	1.75	1.75	1.75	2.00	2.00	1.75	1.83-1/3
PLASTERERS' HODCARRIERS	1.50	1.60	1.40	1.50	1.18¾	1.50	1.75	1.50	1.50
PLUMBERS	1.70	1.70	1.53-1/8	1.70	1.68¾	1.62½	1.62½	1.70	1.50
ROOFERS	1.50	1.50	1.25	1.37½	1.37½	1.37½	1.25	1.37½	1.37½
SHEET METAL WORKERS	1.50	1.50	1.50	1.50	1.50	1.50	1.37½	1.50	1.50
SPRINKLER FITTERS	1.58	1.58	1.53-1/8	1.70	1.68¾	1.62½	1.70	1.50	1.70
STEAMFITTERS	1.75	1.75	1.53-1/8	1.70	1.68¾	1.62½	1.50	1.70	1.50
STONESETTERS (MASON'S)	1.87½	1.87½	1.50	1.75	1.75	1.50	1.75	1.75	1.50
TILESETTERS	1.50	1.50	1.37½	1.50	1.37½	1.50	1.50	1.50	1.37½

Prepared and compiled by

CENTRAL CALIFORNIA CHAPTER, ASSOCIATED GENERAL CONTRACTORS OF AMERICA

with the assistance and cooperation of secretaries of General Contractors Associations and Builders Exchanges of Northern California.

CLASSIFIED ADVERTISING

RATE: 8c PER WORD . . . CASH WITH ORDER

MINIMUM \$1.50 (3 Lines)

ARCHITECT'S REPORTS—A valuable advance news service giving building and construction information daily on projects in Northern California. Name, location, architect, proposed cost, etc., on individual slips. Ideal for securing new business leads. Hundreds of items, total monthly cost only \$10. Don't delay, subscribe today. ARCHITECT & ENGINEER, Room 618, 68 Post Street,

San Francisco, California. Phone DOuglas 8311.

PHOTOGRAPHY—Keep a pictorial record of your building, or construction project. Pictures are of tremendous value to contractors, builders, engineers, architects. For Industrial-Publicity-Aerial photography, see FRED MAE, Room 721-22 Hearst Bldg., San Francisco 3, California.

ARCHITECTS—A. McF. McSweeney, Architect, Room 927 Hearst Bldg., San Francisco. New offices. Desires catalogs.

Winfield Hadsell Hyde, Architect, new offices at 607 Hobart Bldg., San Francisco. Send catalogs.

PRINTING—Printers, bookbinders. See us for commercial printing. Mercury Press, 942 Howard Street, San Francisco.

MULLEN MFG. COMPANY

BANK, STORE AND OFFICE
FIXTURES—CABINET WORK
OF GUARANTEED QUALITY
CHURCH SEATING

Office and Factory:
60-80 RAUSCH ST., bet. 7th and 8th Sts.
San Francisco
Telephone Underhill 5815

THE TORMEY COMPANY

GENERAL PAINTERS
AND DECORATORS

Phone Underhill 1913

563 FULTON STREET
San Francisco

G. P. W. JENSEN & SON

Building Construction

320 Market Street, San Francisco
Phone: GARfield 2444

JOHN CASSARETTO COMPANY

—Since 1886—And Still Active—

Building Materials

READY MIX CONCRETE
ROCK - SAND - GRAVEL - LIME
CEMENT - PLASTER - MORTAR
METAL LATH - WOOD LATH
STUCCO - WIRE NETTING

Service Unexcelled

Bunkers
Sixth and Channel, San Francisco
Phones: GARfield 3758 - 3760

IN THE NEWS

A SUBSCRIBER WRITES

Netherland East Indies,
Molucca Group,
June 8, 1945

Architect and Engineer,
68 Post St., San Francisco.

Dear Sirs:

Will you please send a one year subscription of your magazine to the address listed below. As I consider each copy of your magazine well worth saving, I am sending my home address.

Please find enclosed a money order amounting to three dollars, to cover the subscription.

Thank you very much.

Sincerely yours,
Robert Storie.

NEW POCKET CIRCUIT TESTER BY AMERLINE



A new all-purpose Circuit Tester has been made available by Amerline, manufacturer of plastic and metal specialties, 1753 North Honore Street, Chicago 22, Illinois.

In convenient vest pocket type, it indicates voltage from 90 DC, and 60 AC, to 500 volts AC or DC. A neon lamp on top glows in varying intensities indicating circuit conditions and will light on currents as low as one microampere. Full details and many uses available from manufacturer.

PAINTED CEMENT FLOORS

Protection and upkeep of colored cement floors is discussed in an illustrated brochure recently released by the Building Products Division of L. Sonneborn Sons, Inc., New York.

DINWIDDIE CONSTRUCTION COMPANY

•
BUILDERS
•

CROCKER BUILDING
SAN FRANCISCO



HERRICK IRON WORKS

STRUCTURAL STEEL
REINFORCING STEEL

18TH AND CAMPBELL STS.
OAKLAND, CALIF.
Phone Glencourt 1767

Phone GARfield 1164

Thomas B. Hunter

Consulting Engineer

DESIGNER OF HEATING
AIR CONDITIONING
VENTILATING AND WIRING
SYSTEMS, MECHANICAL
AND ELECTRICAL EQUIP-
MENT OF BUILDINGS

41 SUTTER STREET
ROOM 110
San Francisco California

ANDERSON & RINGROSE

General Contractors

320 Market Street, San Francisco
Phone GARfield 2245

ARCO ND ENG



SEPTEMBER

1945

It takes
Experience
to do a first-class
insulation job!



Sewing canvas over Johns-Manville BX1B insulation on a ventilating duct



Western Asbestos workman applying tape over insulation on a steam line



Installing low temperature cork insulation on a refrigeration system

WESTERN ASBESTOS CO.'S ability to do a first-class insulation job was attained through the practical knowledge gained in thousands of insulation installations of every conceivable type. This experience is your assurance of a *first-class* job — performed with speed and economy. If you have ... or expect to have ... insulation repair problems or require insulation on new equipment, Western

Asbestos Co. invites your inquiry. Our field engineers are also ready to assist you in selecting the proper packings, gaskets and other Johns-Manville marine materials, and Foster IBM Adhesives.

Contractors and Distributors for Johns-Manville Corporation

WESTERN ASBESTOS CO.

DISTRIBUTORS • ENGINEERS • CONTRACTORS



MAIN OFFICE: 675 TOWNSEND STREET, SAN FRANCISCO 3 • BRANCH OFFICES: OAKLAND, RICHMOND, SACRAMENTO



ADMINISTRATION BUILDING

• UNIVERSITY OF CALIFORNIA, BERKELEY

• ARCHITECT
ARTHUR BROWN, JR., ARCHITECT

Conservation of Space Efficiency in Service

both depend on

Streamline

TRADE MARK REG. U. S. PAT. OFFICE

The installation of STREAMLINE Copper Pipe and Solder Type Fittings under normal water conditions assures many, many years of trouble-free, efficient service at low cost. Copper and bronze do not rust. STREAMLINE Pipe is made from pure copper. STREAMLINE Fittings are manufactured in copper and bronze.

Conservation of space is a very important consideration, especially in large public buildings and hotels. The more space that can be utilized, the more income produced. Since STREAMLINE Fittings are not connected by flaring or threading, no room is required for wrench play to tighten the Fittings into place, nor need any allowance be made for protruding valve stems, which on threaded pipe, must be swung in on arc to secure. Valves and fittings are installed in a minimum of space, they are located exactly where required, and soldered.

Copper Pipe loses less heat by radiation than ferrous piping, particularly if the surface is kept polished, although copper itself is a very rapid conductor of heat. Therefore, it naturally follows that there is considerably less heat loss when the heated element, water or steam, is being conveyed from the point of generation to the points of distribution through copper pipe of uniform, unclogged, internal conducting area.

Plan on specifying and installing STREAMLINE Copper Pipe for your postwar construction—or for replacement.

STREAMLINE
PIPE AND FITTINGS DIVISION
MUELLER BRASS CO.
PORT HURON, MICHIGAN

ARCHITECT AND ENGINEER

ARCHITECT

Vol. 162 No. 3

AND ENGINEER

ARCHITECTS' REPORTS—Published Daily
Telephone DOuglas 8311

MARK DANIELS, A.J.A.
Editor

E. H. WILDER
Associate Editor

JOHN S. BOLLES, A.I.A.
Book Reviews

MICHAEL GOODMAN
Post-War Planning

L. H. NISHKIAN
Consulting Editor

E. N. KIERULFF
Ass't Editor
In the Service

Contents for



SEPTEMBER

COVER: America's Badge of Honor (See Page 10)

ARTICLES AND MISCELLANEOUS TEXT

	Page
RUNNING FIRE	4
By MARK DANIELS	
NEWS AND COMMENT ON ART	8, 43
A CONVERSION FOR IN-MIGRANT WAR HOUSING	9
By LEONARD S. MOSIAS	
COVER PICTURE	10
CITY PLANNING IN RUSSIA	11
By MARDI	
GLASS MURALS	13
IN THE NEWS	16, 33, 34, 36, 37, 40
PETALUMA, PLANS FOR POSTWAR PLANNING	17
By MAYOR J. S. WOODSON	
THE NEW PETALUMA CITY HALL	19
By J. CLARENCE FELCIANO, A.I.A.	
AMERICA'S IDEAL POSTWAR HOME—PLYWOOD PRIZE WINNER	21
ARCHITECTURE IN MODERN MEXICO	23
By WM. ARTHUR NEWMAN, Architect	
A.I.A. ACTIVITIES	31, 44
WITH THE ENGINEERS	32
HOME BUILDING OUTLOOK	35-39
PRODUCERS COUNCIL PAGE	38
ESTIMATOR'S GUIDE	41
CLASSIFIED ADVERTISING	43
BOOK REVIEWS	45
ADVERTISERS' INDEX	48



ARCHITECT AND ENGINEER (Established 1905) is published on the 15th of the month by The Architect and Engineer, Inc., 68 Post St., San Francisco 4; Telephone EXbrook 7182. President, K. P. Kierulff; Vice-President and Manager, L. B. Penhorwood; Treasurer, E. N. Kierulff. Advertising Manager, V. E. Atkinson, Jr.

Los Angeles Office: 403 W. 8th Street.

Entered as second class matter, November 2, 1905, at the Post Office in San Francisco, California, under the Act of March 3, 1879. Subscription United States and Pan America, \$3.00 a year; \$5.00 two years; foreign countries \$5.00 a year; single copy 50c. ARCHITECTS' REPORTS are published daily from this office, Vernon S. Yallop, Manager.



RUNNING FIRE — by MARK DANIELS

NIPPON (TO BE POLITE)

It seemed that now was a good time to spend a little space on that country we are still fighting but don't know it, but we are too close to the picture of their duplicity to make anything like a calm appraisal of the Japanese background. Combining the facts that written records began only in the eighth century and that communication with the outer world was forbidden in the seventeenth century for about two hundred years, with our factual knowledge of the events in the last few years, almost any conclusion as to what their background really was would be all too complimentary.

The Shoguns resigned in 1867 and a constitution was promulgated in 1890, but the shoguns individually are still running things and the constitution does not seem to have improved the people, at least not to the naked eye.

If the present surrender does not result in another war, or rather to a continuation of the one we think we have won, to force the Japanese to keep their word, a later article on this so-called background might still be timely, but let's wait until the story is told.

JUST AN ATOM

Charlie McHito seems already to have forgotten that we still have atom bombs. He wants more time to do that which he said he would do at once. We gave him more time but it was not to his satisfaction. Our next reply will be, "No more time; not a bit, not a speck; except, perhaps, an atom!"

A CHANGE OF ADDRESS

The capitol of Japan, the residence and street number of the Emperor of Japan, have been changed so often that another address of Charlie McHito might be timely.

IN HIROSHIMA

If there was a jokaku in Hiroshima at one time, it is gone now.

Not an irimoya, a goju-no-to or even a hewadabuki remains standing in the bombed area. The houdens are no more. Not even a lone kawayaya is to be found.

Now, I ask you, isn't that a helluva note?

BOTH SIDES UP, PLEASE

The shooting of the American aviator who landed on German soil, by the Nazi who was supposedly guarding it, was brutal and shocking but as usual there may have been extenuating cir-

cumstances. The aviator was holding his parachute ropes with one hand and raised only the other when ordered "Hands up!" The Nazi's excuse, which was about as good as any they ever used, was that he had never ridden on a Geary Street car or heard of the order, "Both sides up, please."

EXCUSABLE MISTAKE

As capitol succeeded capitol and emperor followed emperor new palaces were built to please new emperors. The Mikado's present palace is in Kioto and it is something to see, if you can.

Never having flown a B-29 or seen a bombardier drop a bomb from one, I don't know what the instructions or maps accompanying orders to bomb a city look like. Nevertheless, it does seem plausible that KIOTO on a map or in written instructions might be mistaken for TOKIO. Personally, I would not have the heart to blame an aviator who had made such an excusable mistake. No, far, far from it.

TOO PERSONAL

In the April issue, RUNNING FIRE carried an article about slip covers, used by Jan Reiner to describe his opinion of certain types of architecture of today. My own opinion of Mr. Reiner's article, which was in the same issue, was that it was inspired by personal rather than architectural considerations. Mr. Francis Violich then took up Mr. Reiner's cudgel in a letter the following month but I felt that it was based on an even more thinly veiled personal criticism, which was one reason why THE ARCHITECT AND ENGINEER did not print it. One paragraph, however, should be quoted. Mr. Violich says, "Let us see more and more material expressing these principles in the pages of THE ARCHITECT AND ENGINEER. Let us welcome expression of the errors of the past and present in order to bring forth the highest standards of contemporary design here in California."

COMING BACK

We are slowly returning to prewar habits, some good, some bad. Any one of them that recalls the old insouciant habits of the past, such as knife and scissors sharpeners pushing their small establishments along on two wheels to the accompaniment of a tiny bell, stirs our memories pleasantly. Now and then the Peripatetic rag man, in his dilapidated wagon behind a spavined horse, again tells us, with his familiar "Any rags, bottles, sacks," that the need for economy is still with us.



High School at Frostburg, Md., designed in Architectural Concrete by Robert Holt Fitchins, architect, Cumberland, Md

Glimpse of Future seen in these inspiring, firesafe schools of **ARCHITECTURAL CONCRETE**

Firesafety, strength, low annual cost and inspiring architectural appearance were the intensely practical considerations which led to the selection of Architectural Concrete for these schools.

Architectural Concrete has proved itself as an adaptable design medium through

which economies may be effected on large or small school buildings for post war construction.

Write for copy of "Concrete in Schools," a 36-page illustrated booklet on educational and architectural planning. Free in U. S. and Canada.

PORTLAND CEMENT ASSOCIATION, Dept. 1 9-8, 816 W. Fifth St., Los Angeles 13, Calif.

A national organization to improve and extend the uses of concrete . . . through scientific research and engineering field work

BUY VICTORY BONDS



Architectural Concrete building for Senior High School and Junior College at Bartlesville, Okla. Designed by John Duncan Forsythe, architect, Tulsa.



How many of these do you own?

If you look under your car, you'll probably find a couple of gadgets something like this one.

They're shock absorbers.

They take the sting out of sudden bumps and jolts. They make a rough road smoother.

And if you're wise, somewhere in your desk, or bureau drawer, or safe deposit box, you have a lot more shock absorbers. Paper ones. War Bonds.

If, in the days to come, bad luck strikes at you through illness, accident, or loss of job, your War Bonds can soften the blow.

If there are some financial rough spots in the road ahead, your War Bonds can help smooth them out for you.

Buy all the War Bonds you can. Hang on to them. Because it's such good sense, and because there's a bitter, bloody, deadly war still on.

BUY ALL THE BONDS YOU CAN...
KEEP ALL THE BONDS YOU BUY

ARCHITECT AND ENGINEER

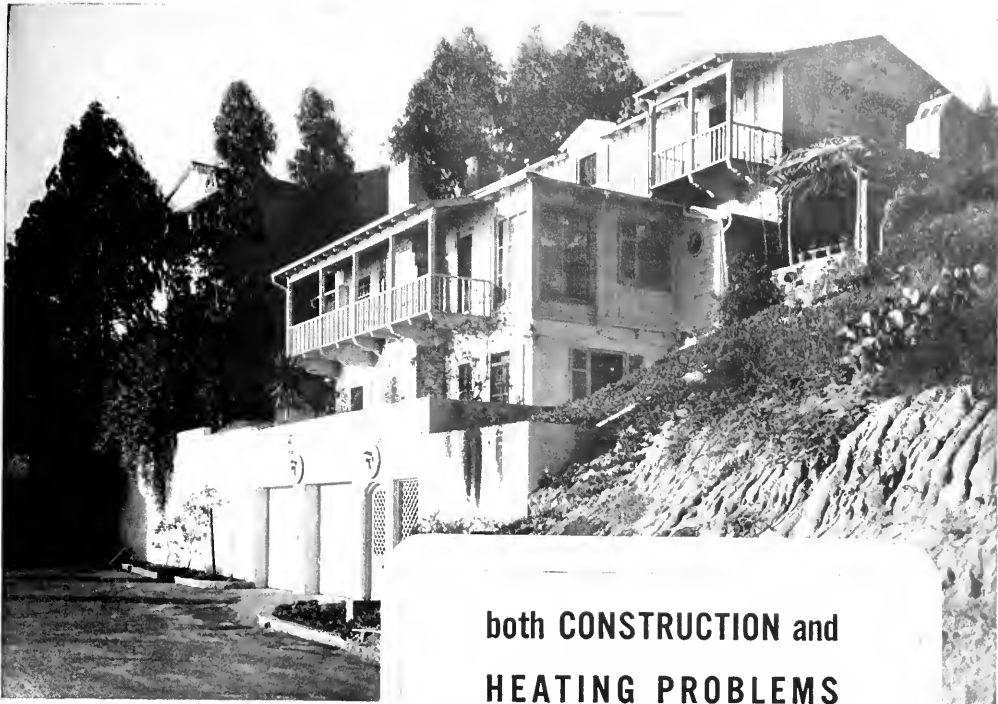

Residence, Mr. W. R. Brent
Laguna Beach, Calif.
Architect: Aubrey St. Clair
Builder: Smith Construction Co.



INVESTIGATE PAYNE ZONE · CONDITIONING

Successor to old-fashioned central heating! Circulated winter warmth ... cooling summer ventilation with forced-air models ... *controlled by zones, rooms or apartments.*

*Zone-Conditioning Booklet
sent free on request*

both CONSTRUCTION and HEATING PROBLEMS happily solved

Fitted "like a glove" to its sharply-sloping lot ... designed to afford maximum enjoyment of a magnificent marine view ... this seaside home is as comfortable *inside* as it is attractive *outside*. *A time-tested PAYNE gas-fired heating installation provides "zoned" comfort. Two PAYNE furnaces, plus smaller units, separately controlled, assure *flexibility* unobtainable with a single "central" furnace. *Consult a PAYNE Dealer or the Factory Engineering Department on your next job.

PAYNE FURNACE COMPANY
(One of the DRESSER Industries)
BEVERLY HILLS, CALIFORNIA

PAYNEHEAT
OVER 30 YEARS OF LEADERSHIP



NEWS AND COMMENT ON ART

NEW EXHIBITIONS AT THE SAN FRANCISCO MUSEUM OF ART

CARLOS MERIDA —a Selection of Painting, August 20.

JOHN TUNNARD —Watercolors, August 20.

The San Francisco Museum of Art, in preparation for the active fall season, announces the appointment of two new professional members to the staff.

Louise Ballard, formerly on the curatorial staff of the Los Angeles Museum, has been named Assistant Curator for Collections and Exhibitions.

Nora Lee Rohr, formerly on the educational staff of the Albright Art Gallery, Buffalo, New York, and of the Boston Museum of Fine Arts, later art critic for the Buffalo Evening News, has been appointed Assistant Curator in charge of Education and Public Relation.

Both Miss Ballard and Mrs. Rohr have had specialized professional museum training as well as experience in the work. They will carry on for the Museum the major functions of contact with all parts of the public served—instructing and aiding the public to art understanding, and working with artists and lenders of art on exhibitions and collections.

Since its return to the Civic Center, from its temporary location on Post Street, the Museum has

found it necessary to open gallery by gallery, until the most obvious damages, resulting from the occupation of the premises by the staff of the United Nations Conference, can be repaired. It is hoped to resume normal activities by the first of September.

DESIGN FOR COMMERCE AND INDUSTRY

Beginning August 20, the California School of Fine Arts will launch its new department of design for commerce and industry. This department will offer thorough courses in advertising art, illustration, packaging and industrial design.

Prerequisite courses in a detailed program extending through three years will be given at once by Allen Peare, advertising artist, and Dorr Bothwell, designer and painter. Other courses will be added shortly under new and expert instructors. The student who desires to become a professional designer or illustrator also will be able to take immediate advantage of courses offered in other related departments of the school under Robert B. Howard, James McCray and Clay Spohn.

WORKSHOP TO TRAIN ARTISTS

The Rosenberg Foundation has granted \$5000 to the California School of Fine Arts, 800 Chestnut Street, San Francisco, for the establishment of an Associated Arts Workshop to begin August 20, according to Douglas MacAgy, director of the school.

At the same time MacAgy announced the appointment of Robert Boardman Howard as head of the workshop. Howard's wide experience in painting, sculpture and other mediums, along with his knowledge of practical working conditions in architectural projects, makes him an ideal choice as instructor for the new experiment.

Students will be trained to participate with architects and planners in post-war projects. Problems will range from the design of bus stations and libraries to children's wading pools. They will work from blueprints and produce their designs with both manual and power tools.

While workshop training courses have been introduced in several art schools in this country in recent years, the new course at the California School of Fine Arts does not follow their example by starting with abstract design problems. Instead students are faced at once with actual problems of construction for use.

WALKOWITZ FIFTY TIMES

Opening August 19th and remaining at the de
(See Page 43)

THE SICK CHICKEN



By Winslow Homer

Collection Mr. Harry T. Pulsifer, New York



New Entrance . . . 2350 Geary St.

A Conversion for In-migrant War Housing

By **LEONARD S. MOSIAS**
Construction Planning
San Francisco

Completed close to the end of the conversion program of the Home Owners' Loan Corporation, the projects at 2350 Geary Street and the northeast corner of Eddy and Laguna Streets, San Francisco, are outstanding examples of permanently altered structures, where, although the use of critical materials was kept to a minimum, comfortable family living quarters with up-to-date conveniences have been provided.

The building at 2350 Geary Street is an L-shaped frame structure originally constructed for use as a gymnasium, consisting of a large room for basketball and badminton, steam, dressing, rest and exercise rooms, a handball court with gallery, and office and boiler room. The outer court

formed by the L fronts on the street, and was used as a tennis court.

In planning, the principle problem was how to obtain two additional floors in the basketball court area, the clear height of which was limited by wood trusses spanning the fifty-three-foot width. This was solved by taking out the trusses and supporting the existing roof construction on the new interior stud partitions.

The completed three floors contain 44 units divided up into 13 two-room, 29 three-room and 2 four-room apartments. Three-quarters of them have exposures on either the street, former tennis court or the large rear yard. The remaining look out into spacious light courts. The former tennis (See Page 10)



THE OLD BURKE GYMNASIUM converted into comfortable family living quarters.

COVER PICTURE

THE PICTURE ON THE COVER— HONORABLE DISCHARGE EMBLEM

Neatly and attractively done in "Old Gold" this emblem "stands for honorable service to our Country."

Millions of men and women serving in the Nation's armed forces during World War II will be eligible to wear the Honorable Discharge Button, which is made of gold plated brass 5/8 of an inch high and 7/16 of an inch wide and was designed by Anthony De Francisci.

Remember when you see this button, it is the "official" civilian identification of an American who in the uniform of the United States Army, United States Navy, United States Marines, United States Coast Guard, or United States Air Force, made a tremendous contribution in time, effort, and personal sacrifice to you and the principles for which you stand—the United States of America's form of democracy.

CONSTRUCTION EXPOSITION AND HOME SHOW PROPOSED

The Los Angeles Chamber of Commerce announces a "Construction Exposition and Home Show" for next Spring.

The exhibition will present to the building industries and public the types of material and equipment expected to be available soon after V-J Day.

Joining with the Chamber in sponsoring the event are: the Building Contractors Association, National Association of Home Builders, Electrical Contractors Association, Contracting Plasterers Association, Merchant Plumbers Association, Heating and Piping Contractors Association, Refrigeration Contractors Association and the Associated General Contractors.

SURPLUS PROPERTY FOR SALE

The U. S. Department of Commerce, Office of Surplus Property, is now offering over 400 items of construction machinery and farm equipment for sale.

Included are such items as: Used tractors, escort wagons, road graders, road rooters, scrapers, pumps, snow plows, vegetable planters, and barrage balloon winches which are compact and can easily be mounted on a truck and offer a wide variety of uses.

Regional offices of Surplus Property are located at 30 Van Ness Avenue, San Francisco; 1206 S. Maple Ave., Los Angeles; 1816 W. Fillmore St., Phoenix, Ariz.; and P. O. Box 1751, Reno, Nevada.

A CONVERSION FOR WAR HOUSING

(From Page 9)

court now serves as an entrance court and off-street automobile parking area.

The interior walls and ceilings are plastered with a pleasing colored stucco finish in the living rooms, bedrooms and halls, and painted surfaces in the kitchen and baths, while the street facade and outer court walls are cement plastered.

The boiler which formerly served to provide steam to heat the gymnasium was insufficient for the conversion, so it is being utilized for the increased hot water system. Each apartment is now furnished with a modern cabinet space heater.



Eddy and Laguna Streets . . . Before.

Below: After conversion work.

The converted Eddy and Laguna Streets building is also of frame construction and the new finishes, both internal and external, are the same as the Geary Street project.

Originally two structures, each on a corner, they have been connected, thereby eliminating





Prior to conversion . . . old, outdated.

the necessity of providing a rear yard on the same lot. The buildings, of sound construction with brick and concrete foundations, were erected approximately 60 years ago by Geo. H. Eggers, a pioneer and one of the founders of the San Francisco Bank. As the family grew, additions were built and in later years as the children moved into homes of their own the building gradually out-lived the usefulness for which it was erected.

Ideally situated fairly close to the downtown section of the city, with good transportation facilities at hand, and directly across from a public park, it was only natural for the next step to be conversion.

The ground floor formerly occupied by stores and unused space has been converted into garages, laundry, storage and utility areas. The converted residential section above consists of 21 units with 6 two-room, 12 three-room and 3 four-room apartments. The rooms are all above average in size with large window areas. All apartments have spacious closets and cabinets.

While the outside is not a masterpiece in design due to a cost limitation prohibiting excessive exterior remodeling, it is acceptable as an improve-

Today a modernized family dwelling.



ment enhancing the neighborhood appearance and property values. The planning by the office of Leonard S. Mosias shows a policy in the utilization of existing conditions to the fullest advantage. Credit should be given to the Mills Construction Company for sincere attention on the job and good workmanship.

CITY PLANNING IN RUSSIA PROCEEDS

By MARDI

With the entry of Russia into the war on Japan there has been some talk of a letup in the huge undertakings of the Russian people in their efforts to rebuild the cities and communities that were destroyed and wrecked by the Germans in World War II. It hardly seems likely or reasonable, for if the Russians could carry on the great amount of city building work reported while they were fighting the last months of their war with the Nazis there should be no difficulty in continuing that work.

According to the latest cables received in this office from Moscow, Karo Alabyan, President of the Academy of Architecture in Moscow, has completed the plans for the restoration of Stalingrad and these plans have been confirmed by the Government. Work has been going on in Stalingrad and now many large factories are working full blast. The Russians have been making large use of brick and tile, quantities of the latter of which have been shipped from this country. It is expected that this year will see the completion of all plans and much of the work of restoration at Rostov-on-Don, Smolensk, Sevastopol and several other cities.

Of course, this great task of replanning and restoring the cities and homes destroyed during the war will continue for years. In Belorussia alone, of twelve capitals there ten were seventy per cent destroyed. By the present date it is estimated that 26,000 houses will have been restored, but that leaves about 1,500,000 houses and farms yet to do which the government feels will take the next six or seven years, by which time Belorussia should have most of her villages well built throughout. No, I do not think Russia's job in Japan, after the atom bombs are through, will interfere with her great reconstruction work.

OPENS FACTORY BRANCH

John E. Stolz, identified with the elevator industry on the Pacific Coast for over 45 years, has been named manager of the new MONTGOMERY ELEVATOR COMPANY branch office in San Francisco.

Specializing in high speed geared elevators for medium height buildings, the new office will serve central and northern California, northern Nevada, Utah and Idaho.

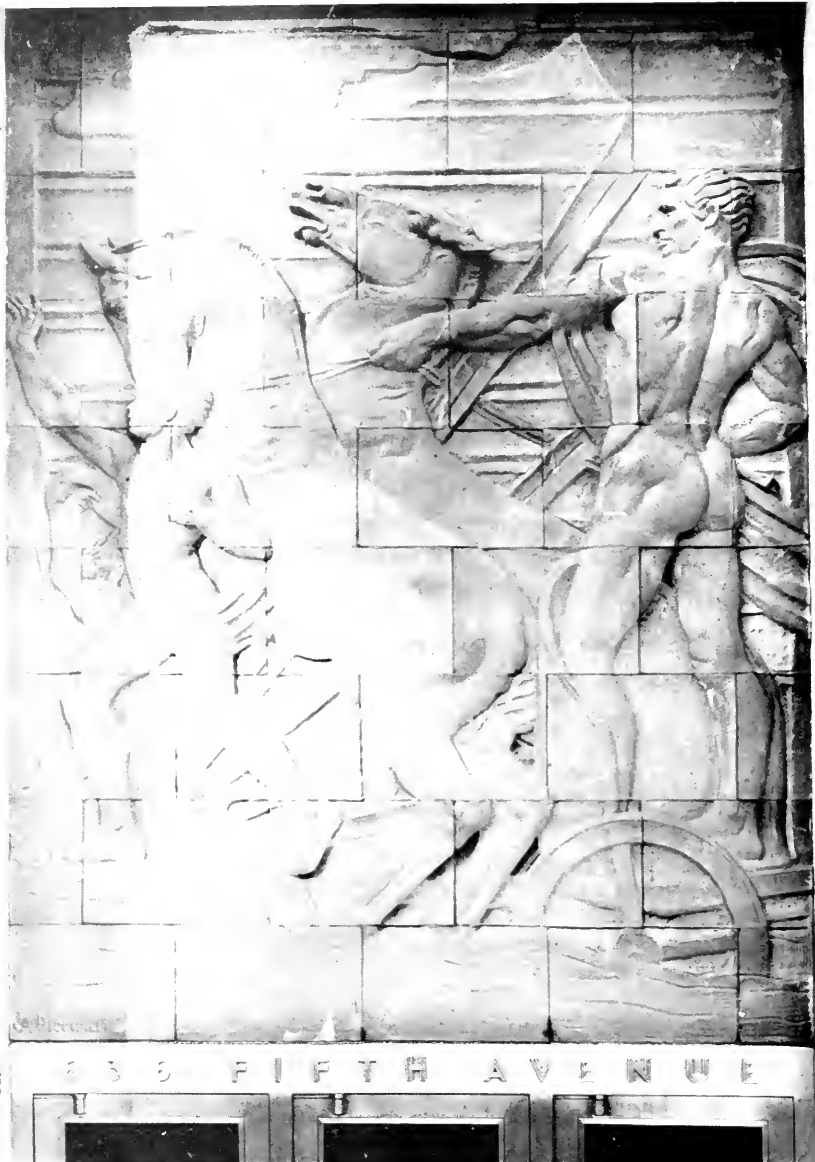

SCULPTURED IN GLASS . . . Three-ton glass panel over the main entrance to the International Building East, Rockefeller Center, New York. Created by Attilio Piccirilli. It symbolizes youth's vision and leadership by depicting a youth pointing out the road ahead to a charioteer who represents commerce and industry.

Photo Pittsburg Plate Glass Co.

Glass Murals

The Ultimate in Decoration

Glass as a decorative medium has grown in popularity in recent years and wartime developments in glass production and fabrication will lend a further impetus to use of glass murals and other art objects in both domestic and commercial building in the postwar years. The qualities of the material and its adaptability to new processes involving bending, cutting, and shaping make possible an endless variety of designs to suit the most discriminating taste.

Plate glass can be transformed into attractive murals and other art objects in several ways. Hand carving, etching with chemicals and casting into molds are some of the older processes. The mold-casting process has been, perhaps, the most widely used for producing decorative glass

murals in the past. European artisans usually made one or two murals and then destroyed the mold so that their carvings were exclusive and could not be duplicated. Another carving method involved the use of various-sized grinding wheels. Both of these processes, together with laborious hand carving, have definite limitations because with them it is not possible to create large size architectural murals.

Glass Sandblasted

The most recent and successful method of glass sculpturing is the sand-blasting process. The special refinements of polished plate glass products and the introduction of sand-blasting open unlimited vistas for development of glass art. The extent of glass sculpturing is now limited only by

APOLLO—Sun God of the Greeks and Romans, is preparing to hitch one of his horses to the sun chariot for his daily ride across the heavens, in this glass mural by sculptor Ivan Poque.

The size of the glass is three-quarters inches thick and approximately 10 feet wide by 6 feet high.



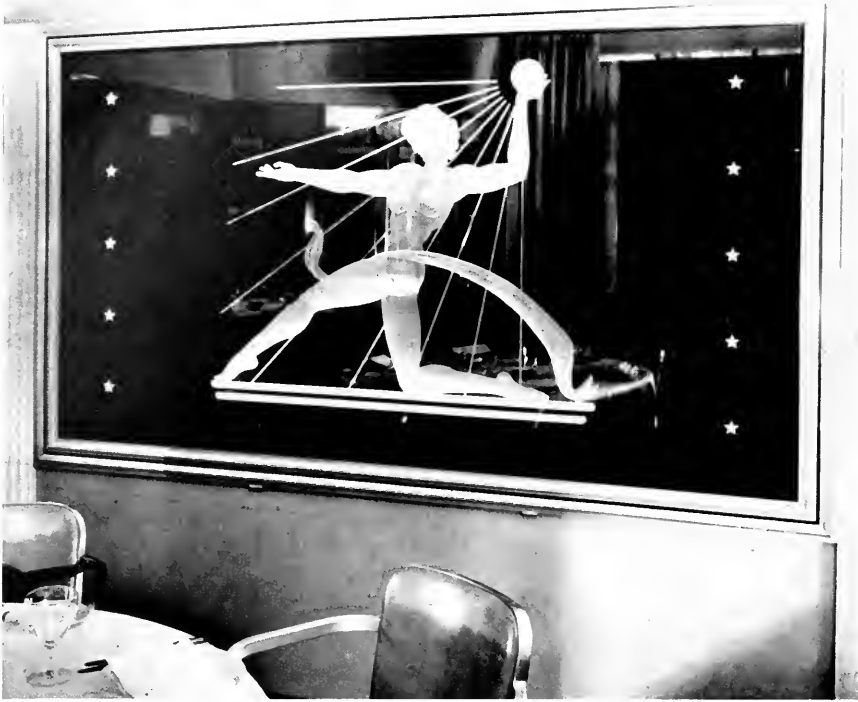

SANDBLASTED MURAL COVERING ENTIRE WALL . . . decorates one of New York's skyscraper restaurants. It is made of Carrara glass.

the ability and imagination of the artist. Sandblasting glass is much like stone carving; where the stone cutter uses a hammer and chisel to shape an object, the sandblaster utilizes a very fine stream of sand driven by high pressure. Each particle of sand acts as a miniature chisel in breaking away tiny pieces of glass.

There are two methods of sandblasting glass, one infinitely more intricate than the other. In ordinary sandblasting of glass, the desired design is adhered to the glass. Those parts not to be treated are masked-out and the open areas subjected to sand blasts. Difficult as this process is, there is almost as much difference between it and sand sculpturing as there is between painting a house and painting a portrait. The sculpturing becomes a process of controlling the grinding medium to produce any desired depth of cutting, plus a shading and blending of cuts to produce a carving as complicated, for example, as the human form. It is a problem of exposing the deeper parts of the carving to the sandblast first, bearing in mind that the first cuts not to be so deep are exposed, and that the deep cuts will not continue

to etch into the glass with the same speed as the more shallow cuts.

Work is Exacting

Important, too, is that the fact that glass as an art medium presents only one chance for success. Each operation must be started and finished at exactly the right time. A single mistake is usually fatal to the success of the entire operation. For example more than 250 hours were devoted to carving a large mirror mural of the Greek God Apollo astride a horse, but of this time only 50 hours were spent in actual blasting. The remainder of the time was devoted to inspection, thought, and decision of just how far to carry each operation so that the final result would be satisfactory.

Sand-blast sculpture has many advantages over other glass carving methods. It is less expensive than molded glass where only one copy is required; also, the section of the glass not carved will remain in its machine-polished state and be free of mold marks, providing glass of mirror quality. No job can be too large. The entire



HERCULEAN POWER is depicted in this glass mural of the Young Building in Allentown, Pennsylvania. Special tools were required for sculpturing this panel which was executed on a full size clay panel, one inch thick.



THE FIGURES in this Carrara structural glass mural stand out a quarter of an inch from a sandblasted background, although they appear to be sculptured in bas-relief.

surface of the largest piece of glass ever made could be carved if desired.

Bridal Bureau Mural

One of the most difficult glass sculpturing jobs ever done was recently completed for the Wm. H. Block Company, Indianapolis department store, by Ivan Pogue, of the Pittsburgh Plate Glass Company and one of the country's foremost glass sculpturers. This sculpture is a beautifully executed figure of a bride surrounded by small flowered designs. The idea was developed by E. W. Snyder, Block's architect, who wanted to do something that would compensate for the rather poor location of the store's bridal bureau. The glass carving has attracted great numbers of people who have made special trips to the department store to see this fine artwork. The glass mural has helped make an obscure department store famous.

Mr. Pogue says this mural involved delicate operation because the detail of the work was so very fine in comparison to the one inch thickness of the polished plate glass. As in all sand blast sculpturing the cut had a tendency to come to a V-shape in its own width and in order to render the design satisfactorily it was necessary to drive many of these cuts beyond the V stage—a procedure usually considered impossible, but accomplished with refinements of the glass sculpturing art developed by Mr. Pogue.

Another interesting and different example of glass carving by Mr. Pogue is a huge mirror surrounding a fireplace in a living room decorated in period furniture and style of French influence. A rococo design, in keeping with the furnishings, was sand carved on the mirror. This piece is being used by Harold Holtz, Interior Decorator of the L. S. Ayres & Company, to advantage in home decoration. Glass sculptor Pogue is also carving a three-quarter inch plate glass mirror frame with a rose and vine design for the Ayres & Company's "Glass Room."

Glass War Memorial

Another indication of the growing appeal of glass murals is the commissioning of Mr. Pogue to carve a portrait of a Navy dive bomber pilot killed in action. This portrait will be heroic in size with the head about 18 inches high and made of edge-lighted one inch thick plate glass. It will be mounted in the foyer of a large Indianapolis office building against a background of Carrara glass that will be shaped in the form of a gigantic eagle. This glass memorial will cover the entire wall from floor to ceiling, approximately twelve by twenty-two feet.

IN THE NEWS

DEAN NAMED AT SYRACUSE

L. C. Dillenback, director of the School of Architecture, Syracuse University (N. Y.), has been named dean of the College of Fine Arts by Chancellor William P. Tolley, succeeding Dean Harold L. Butler, retired.

He will continue as director of the School of Architecture in addition to his new duties.

OWI OPENS HOME FRONT PROPAGANDA CAMPAIGN

Originally formed for the purpose of propagandizing peoples at war with the United States, the Office of War Information has turned its attention to the "home front," with release of the following propaganda representing the National Housing Agency.

"With some 61,500 privately-financed houses now under construction, priorities for 73,000 more are in the hands of builders who can start work as soon as they are able.

"The NHA already has programmed an additional 48,000 privately-financed houses for which priorities now are available. And the Agency has the authority under the current War Production Board program termination to issue 98,000 more priorities before January 1. The great bulk of these will be for private construction, according to National Housing Administrator John B. Blandford, Jr."

EXPANDS OFFICES

J. K. Calley, for the past 25 years in the construction and finance business in San Francisco, California, has moved his offices to 666 Mission Street, San Francisco. He specializes in program of erection of industrial and factory buildings for firm entering, or re-entering, activity in the bay area.

INSURANCE ACT CHANGES

Important changes in the California Unemployment Insurance Act voted by the 1945 legislature and approved by Governor Earl Warren, will become effective as of September 15, 1945.

Exemption of certain small, non-profit organizations; reduction of waiting period from two to one week; modification of Veterans' allowances are among the major changes although some 30 bills in all were passed by the legislature.

Application of the law to workers in establishments hiring one or more persons will become effective on January 1, 1946.



PROPOSED
PETALUMA CITY HALL
 PETALUMA, CALIFORNIA
 J. CLARENCE FELCIANO, ARCHITECT

PETALUMA

“The World’s Egg Basket”

Plans for Post War Living

By J. S. WOODSON, Mayor of Petaluma

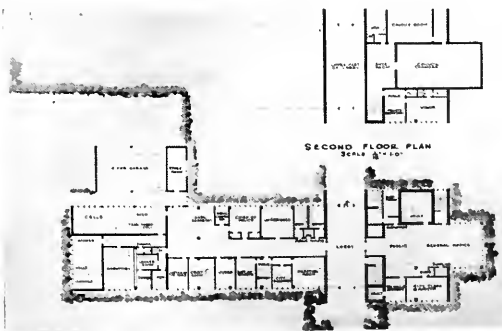

FIRST AND SECOND FLOOR PLAN of Petaluma, California, new City Hall, showing convenience in departmental location for economy in operation.

J. Clarence Felciano, A.I.A., Architect

The growth and development of Petaluma, which is located 35 miles north of San Francisco on the world famed Redwood Highway, has far exceeded the most optimistic prediction of those hearty pioneers who founded a “city” on the banks of the Petaluma River and set about building a community which would utilize to the fullest extent the bountiful natural resources of the area.

Progress of the City of Petaluma has been continuous since its inception.

Favorable climatic conditions, mild winters and plenty of sunshine without excessive summer heat, has contributed to the development of a huge poultry industry throughout the territory surrounding the city. So extensive has become the poultry industry, and so widespread the distribution of poultry products, the City of Petaluma is known throughout the world as the “World’s Egg Basket.”

Millions of dozens of eggs are packed and shipped annually to world-wide markets, as are thousands of baby chicks and turkeys which are

hatched in strictly modern hatcheries within the city.

Remembering that their pioneer fathers did not pour all their gunpowder into one barrel, and aware of the old axiom about "putting all their eggs in one basket," farsighted industrial, financial, and commercial leaders of the community have developed a diversity of activity which assures a sound, substantial income to residents of the city.

Outstanding along these developments is the establishment of two large creameries within the city limits where hundreds of thousands of pounds of butter, dried milk, and other by-products of the dairy industry are produced annually. So great has become the need for milk that Petaluma has become the focal point of milk products produced in both Marin and Sonoma counties.

There are also a number of manufacturing concerns within the city which enjoyed a substantial volume of business prior to "Pearl Harbor," but which at the present time are establishing an enviable record in the production of supplies for the armed forces. These industries, like the poultry and dairy business, are sound economic factors of the peace-time community and will experience no difficulty in converting their production to civilian uses with the coming of V-J Day.

While the City of Petaluma is justly proud of its long record of commercial development, it is likewise proud of its people.

Peaceful, home loving, the citizens of Petaluma have over-subscribed the quota for each of the seven War Bond Drives; they have gone "over-

the-top" in Red Cross and other worthwhile public subscriptions; they have furnished their share of men and women for service in the armed forces; and they have suffered their ratio of combat casualties.

Despite their actual financial contributions to the war, the citizens of Petaluma have set aside funds for postwar uses. Deposits of the three banks in the city have more than doubled in the past few years, further indicating the healthy financial condition of the people of Petaluma.

Not content with just meeting current needs for educational and governmental activities of the city, which now numbers some 9559 population in a trading area of 20,000 people adjacent to the city limits, citizens are looking towards the future; towards a further expansion and development of industrial, commercial, and financial activities, and towards a further and more comprehensive program of civic comfort and public education.

At the municipal election held on June 12, 1945, the electors approved a bond issue for two projects sponsored by the City Council (see photographs and article on page 00):

- (1) \$200,000 for the construction of a new City Hall and Administration Building, and
- (2) \$220,000 for the construction of a Memorial Auditorium and Recreation Building.

Work on both of these projects will begin after the war, and as soon as materials and labor become available.

At the same election the voters approved additional bonds in the amount of \$550,000, for construction of projects submitted by the Board of Education.

Scheduled for postwar construction also, these projects include—

- (1) \$100,000 for a modern swimming pool of sufficient size to be used for competitive swimming races. The Board of Education intends to include swimming instruction in its physical education branch, and it is also the intention of the Board of Education to permit the general public's use of the pool outside of school hours and during vacation periods;
- (2) \$160,000 for a Gymnasium. The Board of Education also plans for development of an athletic field, and additional tennis and hand-ball courts;
- (3) \$85,000 for acquisition of 5 acres of land; and
- (5) \$45,000 for additional educational equipment.

Thus the City of Petaluma, through its progressive citizens and civic leaders, have approved bonds in the amount of \$970,000 to be used for postwar improvements to the city, thereby providing better facilities for the people and assisting in the employment of veterans during the postwar reconversion period.



OLD CITY HALL of Petaluma, California, which is to be replaced with ultra modern building in post-war building program of city.

The New City Hall and Auditorium-Recreation Building for City of Petaluma, California

J. CLARENCE FELCIANO, A.I.A., Architect

The new Petaluma City Hall is designed and planned to be a most modern and up-to-date building and will take advantage of the technical progress and development resulting from the war. The architecture is contemporary modern, simple and practical, a straightforward expression of its function.

The building is partly one- and partly two-story, and is to be a fireproof building, reinforced concrete floors, walls and roof, and is so designed as to lend itself easily to alteration and addition. The wall surfaces are embellished with varied colored brick which contrasts pleasantly with the large glass areas.

The entrance is the predominant feature of the design and is emphasized by its great glass areas at both front and rear. This permits a vista through the building to the garden and landscaped grounds beyond.

The plan is divided into three zones, the executive, the administrative, and the law enforcement and judicial departments.

The council chamber, including the mayor's office and caucus room are located on the second floor. This placing of the executive offices and council chamber serves to express the dignity becoming to the offices and officers in whom the people place their trust, and separates this phase of the city's function from the normal municipal business carried on by the public.

All administrative offices are on the first floor and the offices having to do with most of the business between the public and the city are

placed off the lobby in easy access to the citizens of the community. This includes the city clerk and auditor, tax collector and assessor, and the city engineer and superintendent of streets.

The police department, together with the judicial department, is in the remaining portion of the building. The chief of police, desk sergeant and court and judge's offices are so placed that they may be easily reached from the lobby or the side entrance. The cell block is placed in the most inconspicuous part of the building. Prisoners can be brought in either on foot or in patrol cars without entering the main portion of the building. Provision is made for the segregation of men, women and juvenile prisoners. The facilities provided are in strict conformance to the state laws so governing.

All offices have a great abundance of natural light and ventilation and are designed with facilities for their express purpose and necessary function.

The heating plant, extra storage spaces for records, and janitor's facilities are to be located in the basement of the building. The heating plant will be a split system to provide overall heating for all offices during the day, and partial heating for the police department which functions 24 hours per day.

In general, every effort has been made to provide a building which will be attractive, modern, and function and perform to the best advantage for the community.

Auditorium and Recreational Building

The auditorium and recreation building is designed and planned to be a companion building to the city hall, though of separate function and

COMBINED CIVIC AUDITORIUM AND RECREATION BUILDING for Petaluma, California.

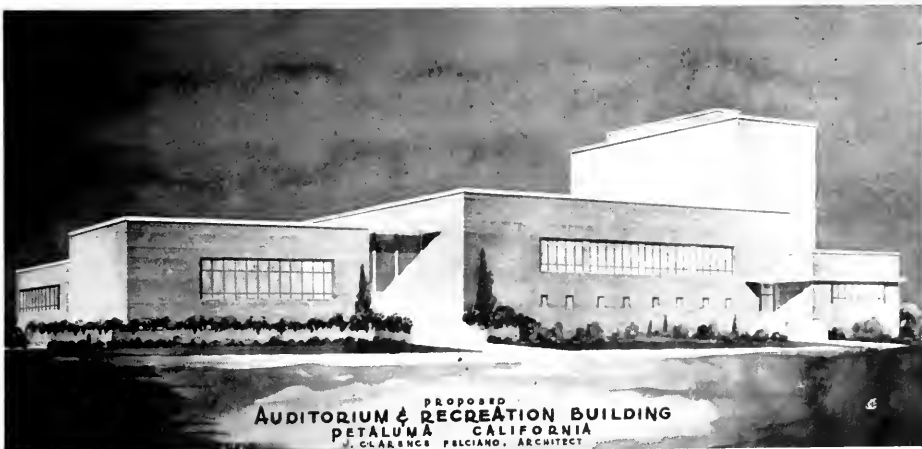

J. Clarence Felciano, A.I.A., Architect

purpose. It, too, is designed to take advantage of all the technical progress and development resulting from the war.

The architecture of this building is contemporary modern like the city hall, and reinforced concrete with brick veneer. Steel trusses will support the roof over the main auditorium.

The building is divided into two parts, the auditorium proper and the recreation or lobby wing. These are connected or joined by a memorial foyer, whose feature will be the great expanse of glass at each end. The foyer is designed for the featuring and display of various mementoes, plaques, and flags of interest to the community. The foyer is common to both auditorium and recreation wing, and is such that either wing can be operated separately.

The auditorium has a seating capacity of about 1,450 persons. The main floor has movable seats and a seating capacity of 800. The stadia portion has 750 permanent seats. The main floor will have a maple floor and is 64 x 96 feet, sufficiently large to play basketball, as well as to hold large dances, conventions, boxing and wrestling matches, badminton, volley ball, and many other indoor athletic contests.

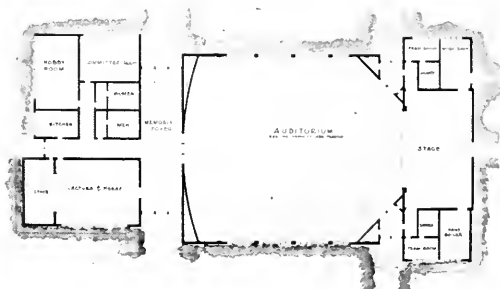

FLOOR PLAN of new Auditorium.

The auditorium has a large stage, 36 feet wide by 64 feet long, ample for the largest stage productions. It will be fully rigged, having a grid and smoke tower. At each side of the stage are the team or dressing rooms with shower and toilet facilities. A stage work shop, together with the fan and boiler room are in this location as well.

The hobby wing of the building contains three large all-purpose rooms to be used for crafts, hobbies, lectures, committee meetings, and camera and other exhibitions.

The lecture-hobby room is 34 feet wide, 45 feet long, with a seating capacity of 220 persons and is equipped with a small stage or lecture platform. The seats are movable, with storage for the same under the stage. This room can be used for banquets, hobbies of various sorts, as an exhibi-

tion room, and for large committee meetings. The other two large rooms are rooms for crafts and hobbies or smaller committee meetings. kitchen is located in this wing to serve the lecture-hobby room mainly, but is accessible to all parts of the building.

The main toilet facilities serving the whole building are in this wing and so arranged that when the hobby wing is being used the auditorium wing can be closed off.

The heating will be divided into two parts to function separately or together, one portion to heat the hobby wing and the other the auditorium wing.

In general the building is an all-purpose building designed to serve the varied cultural, recreational and sporting interests of Petaluma.

IMPROVED FACTUAL INFORMATION IS PLANNED ON CONSTRUCTION

Improved factual information on construction activity and interpretation of those facts for the benefit of the industry is planned by the Bureau of Foreign and Domestic Commerce of the Associated General Contractors of America.

Estimates of construction activity will be compiled to provide detail by type and geographic location that will best meet the needs of the construction industry. It is also proposed to develop information on the physical quantities of materials being used in various kinds of construction so as to give manufacturers of construction materials a more adequate picture of their market, and it is hoped to develop a satisfactory method of surveying plans periodically so as to anticipate the volume of construction as well as other capital expenditures several months in advance.

A practical example of what can be done to provide information to guide business management is the bureau's recent survey of business plans for capital outlays, including construction, during the year following victory in Europe.

Preliminary summary for manufacturing industries, which in peacetime accounted for one-third of total private producers capital outlays, indicates manufacturers expect to spend about \$4,500,000,000 for plant, equipment and alterations during the next 12 months. This would be nearly three times the prewar, 1937 to mid-1940, average and far above the 1920 peak of \$2,666,000,000.

Of the total planned outlays nearly 30 per cent are for plant. This is roughly three times the prewar average and 35 per cent above 1920. The total also includes a rather large expenditure for alterations. This programming of outlays well above the prewar level is characteristic of the 10 major groups of industries.



DESIGN FOR THE IDEAL HOME of American families in the postwar era.

America's Ideal Postwar Home for the Average Family

FIGURE 1

First prize winner in the United States Plywood Corporation sponsored nationwide contest to determine America's Ideal Postwar Small Home for the Average Family was Lieut. Charles D. Wiley, U. S. Army veteran, who submitted the designs appearing on this page.

The top view is an exterior of an all plywood house, while the floor layout shows room function in design.

Second prize was awarded to Lieut. (jg) Russell M. Amdal, USNR, who employed a simplified method of home construction based upon the 3-hinged arch principle. Third prize went to Eduardo Fernando Catalano of Buenos Aires who explained the use of plastics in the roof, panels, doors and walls of the small home design.

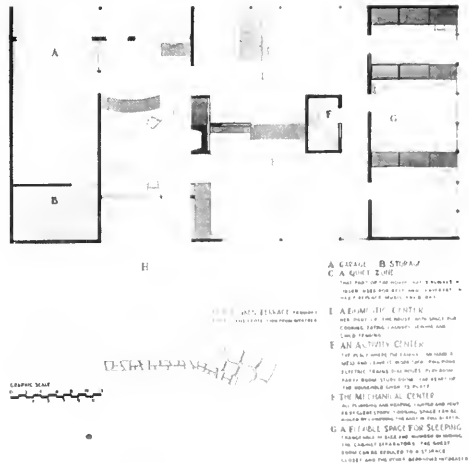

FLOOR PLAN of design by Lt. Wiley.



EDIFICIO SEGUROS DE MEXICO . . . one of the more interesting of modern buildings in Mexico City, D. F. The architectural design is by Luis Martinez Negrete, while the engineering was done by Francisco Martinez Negrete. S. Gomez, Photo

Glimpses of ARCHITECTURE IN Modern Mexico

By **WM. ARTHUR NEWMAN, Architect**

It was one o'clock June 15 at Avenida San Juan de Latran No. 9 in Mexico City. A large and fashionably dressed group assembled composed of distinguished citizens, el Secretario de Hacienda y Credito Publico, representing the President of the Republic, high functionaries of the Government, bankers, professional men and industrialists.

These dignitaries came to perform a solemn act,—a ceremony of dedication of a new edifice and the unveiling of a commemorating bronze plaque in the entrance vestibule of Edificio Seguros de Mexico. As is customary in this country on the occasion of formal opening, speakers and officers of the company owning the building, proclaimed their just pride in the beautiful eighteen story



VIEW OF BRONZE BAS-RELIEF in Main Business Office of Seguros de Mexico.



SALA OF THE COUNSEL OF ADMINISTRACION of the Seguros de Mexico, Mexico City, D. F.



EDIFICIO San Antonio, Mexico City, D. F. Another attractive office building by Luis and Francisco Martinez Negrete, Architect and Engineer.

edifice, designed in modern style,—the tallest office building in the Republic. Then followed a sumptuous banquet and expressions of appreciation to the Architect, Luis Martinez Negrete and his brother, Engineer Francisco Martinez Negrete.

Both Luis and Francisco are men you enjoy knowing, frank and friendly. They have shown their business ability by obtaining, in addition to Edificio Seguros de Mexico, the commissions to design three others,—among the tallest office buildings in the capital: Edificio Jalisco has eight stories, occupied by Banco Capitalizador de Guadalajara, S. A., American Airlines, Babcock & Wilcox and General Motors; completed in 1942. Edificio Internacional, sixteen stories high (illustrated in the March number of this magazine). This building numbers among its occupants Banco Internacional, S. A., Worthington Pump Corp., and the Canadian Embassy, and was completed in 1943.

Edificio San Antonio is twelve stories and was occupied in 1944. It faces Alameda Park on Avenida Juarez and numbers among its tenants Banco Capitalizador de Monterrey, S. A., Stude-

baker and Luis and Francisco Martinez Negrete.

Edificio Seguros de Mexico, situated in the heart of the business district, is 227 feet above street level, supported on wood piles driven to a depth of over 100 feet. The driving of piles started November 24, 1941. Ground floor and main entrance are faced with dark red polished Mexican marble. Superstructure above is faced with buff pressed brick. The large ornamental entrance doors and grilles are of metal painted black, as are also window sash and frames. Building has a structural steel frame well braced against earthquakes, and reinforced concrete wall and floor construction. Corridor floors are marble, and main entrance vestibule has high marble wainscot.

The owner of this building, an insurance company, has taken to transact its business the three upper floors. This is a little unusual in the States where the owner generally prefers a location closer to street level. The company's main business office has Vermont marble wainscot and Botticino marble floor. A bas-relief symbolizing protection given by the insurance company is framed on the wall in Verde Antique marble. Window openings alongside have translucent Mexican onyx in lieu of glass.

Cost of this edifice was \$613,470 itemized in part as follows: Land, \$60,000; demolition, excavation and piling, \$9,000; basement concrete and waterproofing, \$36,000; structural steel, \$84,000; exterior and interior walls, marble, etc., \$97,200; concrete floors, waterproofing and linoleum, \$27,600; plumbing, \$18,000; electrical, heating and fire protection systems, \$31,700; metal doors and win-



MAIN ENTRANCE of the Edificio San Antonio.

dows, wood doors and painting, \$27,000; elevators and lifts, \$54,000.

Luis Martinez Negrete first took up engineering in Guadalajara, but soon realized he preferred architecture. Following his preference he was later graduated from the School of Architecture of the University of Mexico. Then came an automobile



LOOKING EAST from the roof of the Seguros de Mexico building at Avenida San Juan de Letran 9, Mexico City, D. F.



RESIDENCE of Dr. Fernando Molina Font at San Angol, Mexico, D. F. Assembly room is semi-circular on south front, while east front to right is main entrance. Jorge Rubio, Architect.

tour of six months in Europe for further study.

Francisco Martinez Negrete from early boyhood was fond of both architecture and engineering. He received his early training in the offices of Chicago architects. He has traveled extensively in the United States and visited San Francisco in 1930. Both he and his brother Luis speak English and understand our American ways.

They came to live in Mexico City some years ago to enjoy the excellent climate to be near many friends and particularly on account of the large amount of new building construction.

We discussed differences in the practice of architecture in Mexico and in the United States. Services performed by the Mexican architect include more than is generally required of the American architect. At the present time there are no general contractor's organizations large enough to take a contract for a good-sized building in this country.

The Mexican architect, in addition to planning and supervision, has been required to perform duties of administration, the responsibilities of the contractor; to be a civil engineer, estimator, a specialist in all branches, a financier, diplomat, and about everything connected with building construction, including pacifying the client, his wife, the whole family, business associates and friends.

In the case of a large building the different branches of the work are subdivided to a larger extent than in the United States and let separately; foundations to one, reinforced concrete to another, structural steel to a third, floors and interior finish to a fourth, and so on. There are no reliable companies that make doors. If you need doors you call in a carpenter and order 500. You follow similar procedure with windows, floors and masonry.

Often the architect is required to obtain most

of the materials, check and settle the accounts, and hire and pay the mechanics by the day. This to the American architect seems quite an added responsibility, especially on large work.

Problems which confront the Mexican architect at present are lack of materials and scarcity of good workmen. Many of the best workmen have gone to the United States. Steel reinforcing bars, cement and brick are obtainable, but there is great



DETAIL of exterior stair from second floor to swimming pool at Dr. Font's home.



TYPICAL VIEW of modern living room in Mexico City. This particular scene is in the residence at Avendia Virreya 155.

Photo by Brehme

need of all kinds of American supplies. There are no dry kilns in Mexico, and it is difficult to get anything but green wood. Oak flooring and interior finish are imported. Oak and mahogany cut in Mexico are kiln dried in the United States and returned to Mexico. Travertine, similar to our Colorado product, is imported from Peru. There are many beautiful and varied marbles in Mexico, and prices are reasonable, but not all quarries are opened for production.

It is easy today to finance a business or residential building, and there is plenty of 8 per cent and 9 per cent money available. While costs of building construction have risen it is still considered cheap. It is said the average Mexican owner is slow in his appreciation of the value of good architecture; he is inclined first to look for a good investment. In the matter of rentals, it is thought proper for the owner to expect to net 10 per cent or more.

The world war greatly increased the practice of Mexican architects and draftsmen. Draftsmen now receive from 50 cents to \$1.00 an hour. Their working hours are from 9:00 to 5:30 or 6:00, with lunch time at 1:00.

We discussed the possibility of a distinctive

national architecture. Yes, was the reply, there is a beginning, but it hasn't advanced far. Some architects are endeavoring to develop a new Mexican architecture out of the Spanish, but the trend is toward the modern, as is seen in recent designs of the new hospitals, schools and office buildings. There has been little use made to date in present buildings of prehistoric Toltec, Mayan and Aztec details.

For the most part the climate is so mild and easy on building materials that the tendency is to overlook the architect's advice regarding necessary upkeep, which when neglected, causes criticism and additional expense to the owner.

In every city the world over may be found examples of both good and poor design in costly buildings and Mexico is no exception to the general rule. We are all aware of the efforts of progressive architects and their institutes by various means to educate the public to appreciate what is best in architecture, and the Mexican architects have done likewise. Some months ago a unique competition was held to determine the poorest design in a costly residence in the capital. A jury of architects examined photographs submitted and inspected the buildings. Decisions of the jury and



**HOTEL Y BALNEARIO in San Jose Purua, Mich., Mexico, looking west with the dining room
lookout being shown at the high point. Jorge Rubio, Architecto.**

Photo by Nelson Morris

the "successful" photographs were published, much to the amazement of some owners. This practice, however, has now been discontinued.

Progress is being made in advancing the status of architectural practice. The endeavor of the best architects is to bring about at as early a date as possible the same professional practice as is in general use in the United States, and regulate architect's services strictly to planning and supervision, so that more attention can be given to better design.

"We feel," says Architect Luis Martinez Negrete, "that the future of Mexico is assured, but very much depends on the friendship of the United States." "Do you mean that?" I inquired. He replied, "Who doubts it?"

Among the many interesting residences dotting the boulevards there is room in this article to present but a few typical examples of charming modern homes in lovely settings for comfortable living.

Families that would be considered large according to the American standard are the rule in Mexico. Hospitality is a feature. Mexican architects have something of a larger problem in residential commissions.

In company with Architect Jorge and Mrs. Rubio, we visited some new residences he designed. He is among the younger progressive members of the profession, and comes from the State of Yucatan, which State, by the way, once petitioned Congress for admission into the United States. Senior

Rubio's father is also an architect. He sent the young Jorge to Rensselaer Polytechnic Institute in Troy, New York, where he received his architectural training. Jorge is married to a beautiful young lady, a former student at MIT. His wife is aiding him in his architectural practice.

One of Architect Rubio's recently completed residences is that of Dr. Fernando Medina Flores in the exclusive San Angel district adjoining Mexico City. The site consists of a couple of acres most of which is planted in fruit and other trees, garden and vegetables.

The program given the architect was to provide a home for the owner, his wife, mother and ten children,—five boys and five girls, ranging from the baby to the eldest, fourteen years of age. When guests came and the children brought their schoolmates home for the week-end, it was not uncommon to seat sixty in the dining room. The exterior is faced with red brick and flat roof tile with edges exposed and horizontal joints raked out. The concrete frame (including columns, belt courses, lintels, etc.) is exposed, with texture as it comes from the forms.

On the ground floor are the living room, community billiard and play rooms, main entrance



GUEST Rooms, solariums and beautiful vista of nearby hills and valley as seen from main buildings looking east at San Jose Purua, Mexico.

**Left:
LOOKING east from swimming pool at San Jose Purua.**

from a wide platform, and terrace adjoining swimming pool.

The second floor has an assembly room, dining room, kitchen, master bedroom, guest rooms and rooms for each of the five girls, baths, balconies and a winding stair from assembly and dining rooms to the pool.

On the third floor are separate rooms for the five boys, baths and play room. Provision is made for servants, nurse maids, store rooms and garage, and it is needless to say the family is pleased with their new home.

Another example of Architect Rubio's work is a hotel and bathing resort, reached after a scenic two hours' ride from Mexico City. This is frequented by holiday and week-end guests and by lovers of the great outdoors.

The drive is appealingly beautiful, rich in color and variety. We passed in and out of lovely bits of fir forest, lake and woodland, through upland meadows at the side of magnificent snow-capped

Nevada de Toluca and by quaint and picturesque Indian villages until we reached San Jose Purua. This is the mecca or paradise we came to see; opened to the public three years ago, and still receiving finishing touches. Near this site ancient Tarascans lived and legends are still told of them.

The resort is a place to enjoy rest and relaxation, as well as eight-course dinners, juicy filet mignon, fat pats of butter, no lack of sugar nor delicious desserts.

The site is a small irregular mesa lying under the bluff of the tableland above, and is at the edge of a barranca which drops to the Tuxpan River. The view is inspiring.

The architect found this a most interesting and intriguing project to plan. It was virgin country distant from any village. There was no way of access for any vehicle; no fresh water supply, telephones, gas or electricity. There were immense boulders and a few trees scattered about. A

(See Page 46)



ATTRACTIVE RESIDENCE in Lomas de Chapultepec, Mexica City, D. F.

Photo by Nelson Morris

A.I.A. ACTIVITIES



The August Bulletin of the Southern California Chapter of the Institute gives us the note that Lt. Colonel David J. Witmer, F.A.I.A., who has been a member of that chapter for many years, has been honored by the United States Army in France by the awards of three coveted decorations: the Bronze Star, the Legion of Merit, and the Croix de Guerre. The army is, in a way, a little late, for we in the A.I.A. have often honored Col. Witmer in our minds and in our hearts many times ere this. We now join others in recognition of the official awards.

SUMNER SPALDING, of the southern chapter, is swinging out with vigor in his capacity as Chairman of the National Urban Planning Committee. Again he brings out the expression "Plan or Die" unless there is a real demand for planning. As he puts it, "without mass demand for planning our results are just conversation and sketches."

The August Bulletin also tells of the July's meeting and its major devotion of time to the subjects of MODULAR DESIGN. Unquestionably, Modular Design is one of the most important subjects that have been taken up by the American Institute of Architects. Mr. Paul Hunter was speaker of the evening and he brought out that back in 1929 the "modular approach was seen to be a proper method of solving the problem" of cost reduction in most lines. Then in 1939 the A.I.A., the Producers' Council and the American Standards Council began their researches. Mr. Hunter held that if we were to enjoy the fruits of this method that we as architects must advocate modular design and encourage manufacturers to adopt its universally.

The July meeting of the Northern California Chapter of the American Institute of Architects has issued their July Bulletin, a little late this time, but what the chapter lacks in speed of issue it more than makes up in quality of presentation and content. There is not time for this issue of "Architect and Engineer" properly to review all the important and well selected items in this bul-

(See Page 44)



Our Twentieth Anniversary

Through 20 years of careful planning and production UTILITY has established high standards of quality and dependability for its products. New methods of manufacturing and greater volume of production will give users of postwar UTILITY Appliances new standards of quality and new measures of value.



Propeller Fans



Blowers



Space Heaters



Forced Air Furnaces



Floor Furnaces



Evaporative Air Coolers



UTILITY APPLIANCE CORP.

Formerly Utility Fan Corporation

4851 S. Alameda, Los Angeles 11, Cal.

Manufacturers of the famous Utility evaporative air coolers (the original Desert Cooler), Fans, Blowers, Floor Furnaces, Forced Air Furnaces and Fan-Equipped Space Heaters (console type).

WITH THE ENGINEERS

A new list of American Standards and War Standards, approved to date, has been published by the American Standards Association, 70 E. 45 St., New York City 17, N. Y.

There are approximately 800 standards listed in the booklet, covering specifications for materials, methods of tests, dimensions, definitions of technical terms, procedures, etc., in the electrical, mechanical, building, transportation, textile, and other fields. For ready reference, the standards are listed alphabetically as well as by engineering fields. There is also a separate list of the War Standards—jobs carried through since Pearl Harbor at the specific request of Army, Navy, or industrial groups.

China.—More than 2,000 miles from their former headquarters in Tengchung, four men of the U. S. Army's famous Burma Road Engineer unit are supervising the repair of an 1,800-year-old bridge over the Yuan Hwo.

Built during the Tong dynasty, the Yuan bridge is the largest in southwest China. Stone masons from all parts of Hunan province gathered to span the river whose rushing waters separated the eastern and western parts of this area like a stone wall. Through the lives of three local emperors, the massive stonework was laid. Wooden stringers were floated hundreds of lis from mountain forests, raised to form the floor and the bridge opened for traffic.

The old wooden beams have been replaced numerous times during the centuries—but never before has the need for replacement been so important to China's national interests.

While the abutments still hold firm, mute testimony to the art of the Chinese masons, the dried, rotted spans have to be replaced—and replaced quickly.

Combat officers on the eastern front called upon SOS and the Burma Road Engineers for a team of men and a couple of machines to help the Chinese workmen do the job.

A total of 756 feet of woodwork is being replaced on the 15 spans that make up the roadbed. Working with U. S. engineers are over 70 skilled "choa gungs" (bridge workers), hundreds of coolies as well as Mr. H. H. Ouyang, a graduate of Hunan University, who is chief engineer for the national government.

The Americans constantly amaze their Chinese associates when they operate the BRE power saws, ripping out cross ties faster than the choa gungs could break toothpicks. Although almost 100 coolies spent several hours carrying one beam

from the riverbed to the 40-foot heights of the abutments, operating an American winch on a six-by-six truck, a beam is lifted directly from the river in a matter of minutes.

Working on one span at a time, Chinese and Americans are ripping off the old, worn out timbers, getting down to the stonework and building up from there. Every day a new section is set in by combining modern mechanical skill with the ancient manual art and if the river water remains high and loaded rafts can continue to float down the heavy beams, the bridge will be completed in one-third the expected time.

THE CONSTRUCTION OUTLOOK

By MARDI

At this writing we know that Japan is through, but that is about all. She has accepted the Potsdam terms, on conditions, but these details are not properly a part of this column; for them, see a newspaper, any one you prefer. What is proper here is the effect a Japan peace will have on the construction outlook.

It seems clear to me that the impasse that is overtaking us is one which the government alone can break. Roughly, the War and Navy Departments have or control the materials of construction. If they cease to use them, or, in other words cease letting contracts to use these materials, and at the same time refuse to let others use them, then we are indeed at an impasse.

But the force of public opinion, that bete noir of the politician, is already showing up in private contracts that, with repeated frequency, are being renegotiated. Private contracts are being let in remote parts of California, interspersed with government contracts in Nevada and even Hawaii. For example over \$1,000,000 of work has been contracted in Nevada during the last few weeks and over \$2,000,000 of contracts have been awarded in Hawaii, according to "Architectural Reports, Inc. \$11,600,000 have been awarded in California, \$3,750,000 are in progress and \$13,685,000 worth of contracts have been allotted by the government.

These are in round figures, considerably lower than are given by "Architectural Reports" and do not include the large number of small contracts, but they show clearly that the contracting business is on the up grade and that it will increase as soon as the government removes the priority requirements.

GREEN LIGHT

Christmas this year promises to be a bright one as far as lights for Yule trees are concerned. The WPB says Christmas tree and other decorative lights can be manufactured again.

IN THE NEWS

WATER FROM OLD CANAL

Water from a canal in the Naugatuck River valley in Connecticut, built more than a century ago to furnish hydro-electric power for factories in the area, still serves the same purpose.

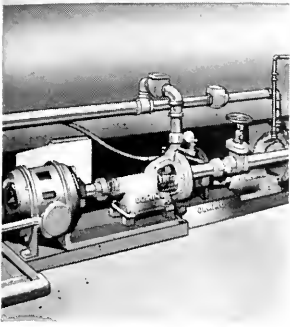

Deming Pump

Two Deming centrifugal pumps supply the entire De Jur Amsco Company plant at Shelton with water from the canal.

Two hundred gallons of water per minute, against a 180-foot head, is pumped continuously and used by the company in the manufacture of airplane meters, rheostats, photographic light meters, and enlargers for aerial photographers.

NEW TOOL FOR BUSINESS

A 16-page booklet, illustrated in color, and containing complete information on uses of the VARI-TYPER COMPOSING MACHINE has just been released by the Ralph C. Coxhead Corporation, 333 Sixth Avenue, New York 14, New York.

Economical ways to get paper work done is emphasized in the booklet.

"TODAY'S IDEA HOUSE"

Representing the result of extensive research concerning the functional use of doors, frames and windows for those planning home

construction, the well-illustrated booklet has just been released by the PONDEROSA PINE WOOD-WORK, 111 W. Washington Street, Chicago 2, Illinois.

MUSIC AT WORK

Taking the story of music at work and tracing it through history, including the experiments by Thomas A. Edison and the English factories during the blitz, as well as recent government and college research into the results obtained from playing of planned music in plants and factories, a brochure has been released by Executone,

Inc., 415 Lexington Ave., New York City.



Copies are available by writing the Director of Sales and Promotion, New York.



assures lasting protection

There's no escaping the formation of moisture on the warm side of an insulated wall. But with **BROWNSKIN VAPORSEAL**, the insulation can be given *lasting protection* from this vapor and the damage the vapor can do.

BROWNSKIN VAPORSEAL is the perfect protection for insulation.

1. Because **BVS** is **CREPED.**, **BVS** resists stress and strain to protect from tearing and shrinkage.
2. Because **BVS** is laminated and each tough kraft sheet is impregnated with bituminous compound and the sheets bonded together with asphalt, **BVS** is vapor and water proof.
3. Because **BVS** is treated with bituminous compound, **BVS** resists vermin and fungus and won't deteriorate.

BROWNSKIN VAPORSEAL is guaranteed for the life of the building, if properly installed. Samples of **BVS** and full details of how **BVS** can give your insulation perfect protection gladly sent on request.



Quality Products Since 1895

ANGIER SALES CORPORATION

Framingham, Massachusetts

PACIFIC COAST OFFICE: 116 NEW MONTGOMERY ST., SAN FRANCISCO 5, CALIFORNIA

DISTRIBUTORS

WESTERN ASBESTOS CO., SAN FRANCISCO
LOCKWOOD WAREHOUSE CORP., SEATTLE
BUILDING SUPPLIES, INC., SPOKANE

WARREN & BAILEY CO., LOS ANGELES
MASON'S SUPPLY CO., PORTLAND
R. W. FRANK & CO., SALT LAKE CITY

IN THE NEWS

PROGRAM TO LOWER COST

An eleven point program designed to lower cost of postwar construction and at the same time stimulate the volume of building and employment, has been adopted by the Advisory Board of the Producers' Council in New York.

Assistance in formation of local construction, financing, and general cooperation in rural, urban and city construction is included in the program.

GLENN STANTON, A.I.A., has moved his office from the Railway Exchange Building in Portland, Oregon, to 208 S. W. Stark Street in the same city, Portland 4, Ore.

URBAN DEVELOPMENT

The signing of Assembly Bill No. 1531, officially known as the "Community Redevelopment Act," will make possible the legal machinery whereby local governments may assemble properties within "blighted areas" and cause redevelopment to be carried out in such areas by private enterprise.

"Blighted areas," according to the State Reconstruction and Reemployment Commission which advocated passage of the bill by the Legislature,

has become acute within certain cities as a result of California's tremendous increase in population.

A basic requirement of the bill calls for setting up master plans by local planning commissions before communities can rid themselves of "blighted areas." Legislative bodies may adopt ordinances by a two-thirds vote; appoint a 5-man agency which has power to assemble property through purchase, lease, gift or grant and may acquire property by eminent domain.

HARRY A. BRUNO, Architect, A.I.A., has moved his offices from 4875 Harbor Drive, Oakland, California, to 1440 Broadway in the same city.

NAMED AD MANAGER

Don Poor has been appointed advertising manager of Ceco Steel Products Corporation, with headquarters in the offices of the firm's manufacturing division in Chicago.

For the past five years Mr. Poor has served as assistant advertising and sales promotion manager of Lyon Metal Products, Inc., of Aurora and Chicago Heights, Ill.

Part of his new assignment will be to control an institutional campaign embracing wide product diversification, including:

Reinforcing steel fabricated at Ceco's plants in Omaha, Jersey City, Birmingham, Houston, Los Angeles and San Francisco; metal windows, joists, lath, roof deck, doors, screens and weatherstrip manufactured in the Chicago plants; and double drain roofing and corrugated siding rolled at Ceco's sheet steel and wire division plant in Peoria.

Mr. Poor, a graduate of the University of Illinois, class of 1931.

MOVES IN PORTLAND



Warren Weber, Architect, has moved his offices from 3725 S. W. Corbett, Portland, Oregon, to 5643 S. W. Hewett Boulevard of the same city.

PRIVATE CONSTRUCTION

The volume of new private industrial construction after V-J Day is expected to reach a peak of \$1,000,000,000 annually in 1947 and 1948, and then decline to an average of \$575 million during the three following years, according to an estimate by the Producers' Council.

ENGINEERING OFFICE

John A. Blume, Engineer, has opened offices at 68 Post Street, San Francisco 4, California. Mr. Blume specializes in structural engineering.

PRESSURE TREATED LUMBER
● **PROTECTS AGAINST DECAY
AND TERMITE ATTACK**

*Specify it in your home
Available through Lumber Dealers*

LOS ANGELES 601 W. 5th Street Phone Michigan 6294	SAN FRANCISCO 333 Montgomery Street Phone DOugles 3883
---	--

J. H. Baxter & Co.
AGENTS FOR WEST COAST WOOD PRESERVING CO., SEATTLE, WASH.

NEW HOME BUILDING OUTLOOK PROMISING AS SHORTAGES ACCUMULATE

Preliminary results of a national housing survey conducted for the tenth consecutive year by the Investors Syndicate of Minneapolis, Minnesota, show that home building in 310 U. S. cities in 1944 reached the lowest volume level in eight years.

Alabama, Arkansas, Colorado, Iowa, Louisiana, Minnesota, Missouri, Montana, Nebraska, and West Virginia show increased residential building in 1944 over 1943, but elsewhere home building in 1944 was less than in 1943, with the majority of states showing a sharp decrease.

The states of Alabama, California, District of Columbia, Florida, Louisiana, Montana, Nebraska, and Utah, which have a great amount of war activity and therefore acute housing problems, were providing new housing during 1944 at a rate greater than the normal 1930 building year.

In the general home building field, however, new homes built during 1944 in 310 key cities housed 271,952 people. This total was 211,616 or 43 per cent under the 1943 total of 483,568 people. The 1944 aggregate was 330,264 or 54.8 per cent less than the 602,216 people housed during 1942.

Volume in 1944 was 247,244 or 47.6 per cent under the normal 1930 total of 519,196 people furnished with new housing.

The 310 cities included in the survey are located in 41 states and the District of Columbia and with a total population of 50,322,781 represent 38 per cent of the nation's people.

Wartime bans were credited with responsibility for the cut in 1944 home building, while wartime housing needs, resulting from widespread population shifts, assured home building in many war industry centers. However, war housing in 1944 declined over the years of 1942 and 1943.

It is interesting to note that Federal construction in the 319 cities housed 54,156 people in 1944, as against 217,060 in 1943 and 154,164 in 1942, representing a loss of 75.1 per cent for the year.

During the same period homes federally built represented 20 per cent of the new housing put up; 44 per cent in 1943, and 25.6 per cent for 1942.

The postwar housing outlook in these 310 cities appears promising as a result of accumulated home shortages.

In the three years following Pearl Harbor only 48.4 per cent as many people were supplied with new housing as in 1939 to 1941.

Older houses, in number and percentage, are increasing as a result of slackened home construction.
(See Page 39)

ARCHITECTURAL ENEMY NO. 1

A home that shows signs of premature obsolescence because of inadequate wiring.

This danger will be even greater in the postwar era when demands for electrical service will soar. New and better appliances, available for practically every household task, new and better lighting equipment will all depend upon Adequate Wiring for satisfactory operation.

When that day comes, inadequately wired homes will be obsolete whether they are old or new. They will be neither livable nor salable.

Architects and builders today are avoiding this danger by specifying wiring of sufficient size, more convenience outlets, more circuits and better switching — a complete electrical "Service-entrance" for all future needs.

Such an Adequate Wiring plan will circumvent the enemy, electrical obsolescence, and will enhance the value of the house for years.



NORTHERN CALIFORNIA
ELECTRICAL BUREAU

1355 Market Street
San Francisco 3



F.H.A. LOANS

TO BUY—
REMODEL—
REFINANCE



Long - term
and low-cost
F. H. A. loans are still available
to finance the purchase of homes
already built. Monthly payment
F. H. A. loans for buying or ref-
inancing homes are made by this
bank for as much as 80% of the
appraised value of the property
with as long as 20 years to repay.

For further information call
at our Real Estate Loan
Department

**CROCKER FIRST
NATIONAL BANK**
OF SAN FRANCISCO
California's Oldest National Bank
ONE MONTGOMERY STREET
Member Federal Deposit Insurance Corporation

"KIMSUL" Controlled Insulation!

THEMAL EFFICIENCY 0.27

Compressed in rolls for shipment and to save storage space, it stretches out over 5 times and when fully stretched gives a uniform designated thickness which insures the same maximum insulation value at all points.

Fire, Moisture and Vermin
Resistant
Extremely Light, Clean and
Easy to Install.

GUNN, CARLE & CO.

20 Potrero Avenue
San Francisco 3
UN 5480

IN THE NEWS

NEW FIRE EXTINGUISHER

A new fast acting portable fire extinguisher is announced by American, LaFrance, Foamite Corporation, Elmira, New York, in the form of "Alfite Speedex" which uses carbon dioxide as the fire extinguishing agent.



"Alfite Speedex"

Designed to more speedily extinguish small oil or electrical fires with no loss of extinguishing gas on anything but the fire itself, an operating valve lever is located directly above the carrying handle which may be instantly opened by the pressure of the hand grip.

All models of this new extinguisher are approved by Underwriters' and Factory Mutual Laboratories.

DUBLIN AWARD

In the early part of last year The Architect and Engineer ran an ad for the City of Dublin announcing a competition for the design for a sanatorium to be erected at Ballyowen, Dublin, Eire. Following is the announcement to the winners, just received. The awards were unanimous.

Design No. 10, Placed First—Submitted by Joh G. Manahan, Esq., Cowper Road, Rathgar, Dublin, and L. P. Peppard, Esq., 76

Malahide Road, Dublin.

Design No. 21, Placed Second—Submitted by Messrs. Nicol Nicol & Thomas and Donald G. Walton, White House, 111 New Street, Birmingham, England.

Design No. 11, Placed Third—Submitted by Dex Harrison, Esq., and Miss Penelope Whiting, 34 Holland Park Road, Kensington London, W. 14.

Design No. 23, Placed Fourth—Submitted by The Grenfell Baines Group of Architects, 12/24 Guildhall Street, Preston, Lancashire, England.

Design No. 14, Highland Commended—Submitted by Messrs. O'Connor & Aylward, 27 Dawson Street, Dublin.

Design No. 19—Commended—Submitted by Mr. Dermot O'Toole, 69 Fitzwilliam Square, Dublin.

To the author of the design placed first, £500; to the author of the design placed second, £350; to the author of the design placed third, £250; to the author of the design placed fourth, £150.

Built-In Fixtures for the Post-War Home

Paramount Fixtures will fit your post-war needs . . . investigate our new kitchen ideas which make for convenience and efficiency.

Paramount Built-in Fixtures meet the most exacting requirements. Our "Deluxe," "Moderne" and "Economy" cabinet fixtures are distinctive in design and construction and may be had in stock sizes or built to order.

Catalog for the asking

Paramount
BUILT-IN FIXTURE COMPANY
5107 Broadway, Oakland, California
Phone Pleimont 8400

IN THE NEWS

WELFARE CLUB

The Ilg Electric Ventilating Company, Chicago, Illinois, have released a booklet covering its policies and personnel practices, beginning with inauguration of a company profit sharing plan in 1947.

Expansion and development of employer-employee relations to meet changing economic conditions to date are included in the 16-page booklet.

THE C. E. D. REPORTS

The report, issued in Washington by CED spokesmen, was highlighted by emphasis on: rapid demobilization and strengthened aid and protection to veterans in obtaining civilian jobs; prompt state action to raise unemployment compensation benefits and to extend duration of payments; a strengthening of public Employment Services to aid postwar migration and to assist the speedy placement of both veterans and civilian workers; rapid blueprinting of a "reserve shelf" of public works for use if and when needed; provisions for retraining workers for their new postwar jobs and finally, a strong recommendation that individual employers at once put into effect their postwar plans for rapid business expansion and the creation of new jobs.

The Committee opposes arbitrary reductions in the pre-war normal work week solely for the purpose of sharing employment. "We do not want to freeze unemployment into a short work week, since national 'share the work' policy is essentially a 'share the unemployment' plan which places the burden of unemployment on the workers and tends to restrict desirable labor mobility," declares the report.

SMOOT-HOLMAN



The Smoot-Holman name on commercial and industrial lighting equipment means quality...quality today (even in the face of production restrictions)...quality tomorrow, when with many new names entering the field, a good name will more than ever be your protection.

SMOOT-HOLMAN COMPANY

SMOOT-HOLMAN

INGLEWOOD, CALIFORNIA

MADE IN U.S.A.



Offices in Principal Western Cities—Branch and Warehouse in San Francisco

PRODUCERS' COUNCIL PAGE

Northern California Chapter

The National Organization of Manufacturers of Quality Building Materials and Equipment

Affiliated with the AMERICAN INSTITUTE OF ARCHITECTS



FRANK NUGENT

Frank Nugent represents one of our newer members in the Council, Certain-Teed Products Corporation, as an alternate in the Chapter. Frank wasn't long in finding himself a job in Chapter activities and is serving in his first full year as a member of the Fellowship Committee.

Frank was born right over in Contra Costa County on the famous "horse haven" of other years . . . the Brentwood Stock Farm. And he claims his hobby is still farming.

Although surrounded by thoroughbreds with the finest of pedigrees, however, Frank's real interest was in the mechanical side, gas engines, levee siphons and the fine points of irrigating and draining a delta farm. This naturally led to a B.S. degree in Civil Engineering at St. Mary's College, then located in Oakland. School days were followed by ten years in structural engineering with Couchot & Rosenwald, L. H. Nishkian, Austin W. Earl and H. J. Brunner. It was while with H. J. Brunner he decided to enter sales engineering and with "Bru's" advice and help, made the change.

Since then Frank's career has been successively sand and gravel, ready mixed concrete and now bituminous products.

Frank is married and with a boy turning eight-teen, no doubt is thanking his lucky star that the Jap doesn't like our atomic bomb.

Jinx Set—Thursday, December 6, is the date. Xmas Jinx Chairman, Ernie Larson, and his Committee have already been working on it for over a month, which augurs well for his success of

this outstanding event in Architect-Producers' Council relations.

Council Approves the publication of a Building Products Directory, a crystallization of what started out to be a Chapter & Member Directory. "This will be one of the most valuable and useful publications which the Council has ever issued!" states Jim Follin, Managing Director.

- 1) Under a classified product listing it will show all the companies in the Producers' Council which can furnish the products listed.
- 2) It will show each member's local sales representative to whom inquiries should be made.
- 3) It will give an alphabetical listing of Council member companies showing all their products.

Distribution is planned for mailing with Bulletin No. 48 scheduled to go out to 10,000 Architects and Engineers in January, 1946.

In addition 5,000 copies are planned for direct distribution by local Chapters. These copies would be imprinted on the back cover with the roster of the Chapter, which would make the distribution.

It May Well Be that the Chapter distribution will develop into the primary channel for reaching the buyer group, expanding the influence of the Chapters with general and specialized contractors, home builders and others of interest to the men in the field, supplementing the direct mailing by the Council nationally to the specifying group.

This Is It. That post-war period we've all been talking about. Are we ready? Or are there a lot of things we wish we had done in preparation for it? Whatever your answer, let's step on the gas from here!



USE QUALITY PRODUCTS



CONSULT AN ARCHITECT

NEW HOME BUILDING

(From Page 35)

struction and of an approximate 15,181,776 homes considered, 1,825,784 or 12 per cent were 15 years or less old. In other words 88 per cent of all dwellings in these cities were in excess of 15 years old.

The survey was based upon government statistics and include corporate limits of the cities only, unless the regions outside cities subsequently became a part of the adjacent municipality.

Home shortages due to fire, flood, or storms, and the normal rate of obsolescence nor home surplus or shortage existing in any individual city is not included.

PRIVATE BUILDERS WILL HAVE BUSY FIVE YEARS

More than 4,600,000 new dwelling units will be constructed by private builders during the five years, 1947-51, provided the war production program has been greatly reduced in volume by the middle of 1946, according to a revised estimate prepared by the Market Analysis Committee of the Producers' Council.

"The dollar volume of new private residential construction during the five years should exceed \$26 billion, rising from \$3.2 billion in 1947 to an average \$6 billion in 1949-51," Wilson Wright, chairman of the Council's committee, stated.

"The cost of the average dwelling unit, not including the value of the land, is estimated at about \$5,600 for the five-year period. A reduction in the size of the typical dwelling which was pronounced in prewar years probably will continue in the postwar period as a partial offset to increased costs of construction.

"The forecast indicates that housing for about 620,000 non-farm families will be built in 1947, or more than double the number estimated for 1946. In 1948, the number of dwelling units should rise to 870,000 and then is expected to average 1,050,000 in the three-year period ending with 1951. Both housing for sale and for rent are covered in the estimate.

"The estimate for 1949-51 represents a new high volume of home building. The largest number of new dwelling units started in any single year in the past was 937,000 in 1925 and the highest three-year average on record was 893,000 units in 1924-26.

"Savings accumulated during the war by families desiring new homes are expected to play a prominent part in the record-breaking volume of residential construction after the war. It is not likely that the number of new dwellings will catch up with the demand at any time during the early postwar years."



QUALITY AND DEPENDABLE *Service*

are the factors that influence architects and contractors when selecting lumber and mill work — Quality of merchandise — Integrity and Ability of the firm—Service in physical equipment — Experience and Personnel — All these factors contribute to a speedy and satisfactory completion of construction with minimum of time and expense.

MANUFACTURER OR DEALER IN

Douglas Fir—Redwood—Sugar and Ponderosa Pine — Plywood and Concrete Form Panels — Sash and Doors — Millwork — Insulation — Builders' Hardware.

E. K. WOOD LUMBER CO.

"Goods of the Woods" ©

LOS ANGELES • SAN FRANCISCO • OAKLAND

*Be sure you're getting the
finest window glass obtainable*

it costs no more to specify

PENNUERNON

Distributed by...

W·P·FULLER & CO.
PAINTS • GLASS • WALLPAPER



ESTIMATOR'S GUIDE

BUILDING AND CONSTRUCTION MATERIALS

PRICES GIVEN ARE FIGURING PRICES AND ARE MADE UP FROM AVERAGE QUOTATIONS FURNISHED BY MATERIAL HOUSES TO SAN FRANCISCO CONTRACTORS, 2 1/2% SALES TAX ON ALL MATERIALS BUT NOT LABOR

All prices and wages quoted are for San Francisco and the Bay District. There may be slight fluctuation of prices in the interior and southern part of the state. Freight cartage, at least, must be added in figuring country work.

BONDS—Performance—\$10 per \$1000 of contract. Labor and materials \$10 per \$1000 of contract.

BRICKWORK—

Common Brick—Per 1M laid—\$50.00 to \$60.00 (according to class of work).

Face Brick—Per 1M laid—\$120 to \$150 (according to class of work).

Brick Steps—\$1.60 per lin. ft.

Brick Veneer on Frame Bldg.—Approx. \$1.30 per sq. ft.

Common Brick—\$19.00 per M. truckload lots, f.o.b. job.

\$19.00 per M, less then truckload, plus cartage.

Face Brick—\$40 to \$80 per M, truckload lots, delivered.

Cartage—Approx. \$4.00 per M.

BUILDING PAPER—

1 ply per 1000 ft. roll.....	\$3.50
2 ply per 1000 ft. roll.....	5.00
3 ply per 1000 ft. roll.....	6.25
Brownkin, Standard, 500 ft. roll.....	5.00
Sisalcraft, 500 ft. roll.....	5.00
Sash cord com. No. 7.....	\$1.20 per 100 ft.
Sash cord com. No. 8.....	1.50 per 100 ft.
Sash cord spool No. 7.....	1.90 per 100 ft.
Sash cord spool No. 8.....	2.25 per 100 ft.
Sash weights, cast iron, \$50.00 ton.	
Nails, \$3.42 base.	
Sash weights, \$45.00 per ton.	

CONCRETE AGGREGATES—

The following prices net to Contractors unless otherwise shown.

Gravel, all sizes—		
\$1.95 per ton at Bunker; delivered.....	\$2.50	
	Bunker	Del'd
Top Sand.....	\$1.90	\$2.50
Concrete Mix.....	1.90	2.45
Crushed Rock, 1/4" to 3/4".....	1.90	2.50

Crushed Rock, 3/4" to 1 1/2".....	1.90	2.50
Roofing Gravel.....	2.25	2.80
River Sand.....	2.00	2.45

Sand—

River Sand.....	2.00	2.45
Lapis (Nos. 2 & 4).....	2.85	3.15
Olympia (Nos. 1 & 2).....	2.85	3.10
Del Monte White.....	84c per sack	

Cement—

Common (all brands, paper sacks), carload lots, \$2.42 per bbl. f.o.b. car; delivered \$2.72. Cash discount on carload lots, 10c a bbl., 10th Prox.; less than carload lots \$3.20 per bbl. f.o.b. warehouse or delivered.

Cash discount 2% on L.C.L.

Atlas White } 1 to 100 sacks, \$2.50 sack
Calaveras White } warehouse or del.; \$7.65
Medusa White } bbl. carload lots.

Forms labor average \$350 per 1000 sq. feet. Average cost of concrete in place 50c per cubic foot, exclusive of forms; \$15.00 per cubic yard. With forms \$1.60 per cubic foot.

DAMP-PROOFING and Waterproofing—

Two-coat work, \$3.50 per square.

Membrane waterproofing—4 layers of saturated felt, \$7.00 per square.

Hot coating work, \$2.50 per square.

Medusa Waterproofing, \$3.50 per lb. San Francisco Warehouse.

Tricozol waterproofing.

(See representative.)

ELECTRIC WIRING—\$12 to \$15 per outlet for conduit work (including switches).

Knob and tube average \$3.00 per outlet. (Available only for priority work.)

ELEVATORS—

Prices vary according to capacity, speed and type. Consult elevator companies. Average cost of installing a slow speed automatic passenger elevator in small four story apartment building, including entrance doors, about \$6500.00.

EXCAVATION—

Sand, 60 cents; clay or shale \$1 per yard.

Truck: \$20 to \$32 per day.

Above figures are an average without water. Steam shovel work in large quantities, less; hard material, such as rock will run considerably more.

FIRE ESCAPES—

Ten-foot galvanized iron balcony with stairs, \$150 installed on new buildings; \$160 on old buildings.

FLOORS—

Composition Floors, such as Magnesite, 50c per square foot.

Linolor—2 gages—\$1.25 to \$2.75 per sq. yd.

Mastopave—90c to \$1.50 per sq. yd.

Battleship Linoleum—available to Army and Navy only—1/8"—\$1.75 sq. yd. 3/8"—\$2.00 sq. yd.

Terazzo Floors—50c to 70c per sq. ft.

Terazzo Steps—\$1.75 per lin. ft.

Mastic Wear Coat—according to type—20c to 35c.

Hardwood Flooring—

Standard Mill grades not available.

Victory Oak—T & G

3/4" x 2 1/4"..... \$143.25 per M. plus Cartage

1/2" x 2"..... 122.00 per M. plus Cartage

1/2" x 1 1/2"..... 113.50 per M. plus Cartage

Prefinished Standard & Better Oak Flooring

3/4" x 3 1/4"..... \$180.00 per M. plus Cartage

1/2" x 2 1/2"..... 160.50 per M. plus Cartage

Maple Flooring

3/4" T & G Clear \$160.50 per M. plus Ctg.

2nd 153.50 per M. plus Ctg

3rd 131.25 per M. plus Ctg.

Floor Layers' Wage, \$1.50 per hr.

GLASS—

Single Strength Window Glass..... 20c per ft

Double Strength Window Glass..... 30c per ft

Plate Glass, under 75 sq. ft..... \$1.00 per ft.

Polished Wire Plate Glass..... 1.40 per ft.

Rgh. Wire Glass..... .34 per ft.

Obscure Glass..... .27 per ft

Glazing of above is additional.

Glass Blocks..... \$2.50 per ft. set in place

HEATING—

Average, \$1.90 per sq. ft. of radiation, according to conditions.

Warm air (gravity) average \$48 per register.

Forced air average \$68 per register.

IRON—Cost of ornamental iron, cast iron, etc., depends on design.

LUMBER—All lumber at O.P.A. ceiling prices—

No. 1 Common	\$49.00 per M
No. 2 Common	47.75 per M
Select O. P. Common	52.75 per M

Flooring—

V.G.-D.F. B & Btr. 1 x 4 T & G Flooring	Delvd. \$80.00
C 1 x 4 T & G Flooring	75.00
D 1 x 4 T & G Flooring	65.00
D.F.-S.G. B & Btr. 1 x 4 T & G Flooring	61.00
C 1 x 4 T & G Flooring	59.00
D 1 x 4 T & G Flooring	54.00
Rwd. Plastic—"A" grade, medium dry	82.00
"B" grade, medium dry	78.50

Plywood—not available

	Under \$200	Over \$200
"Plyscord"— $\frac{3}{8}$ "	\$49.50	\$47.55
"Plywall"— $\frac{1}{4}$ "	45.15	43.30
3 ply— $2\frac{1}{2}$ "— $\frac{1}{4}$ "	48.55	46.60
"Plyform"— $\frac{3}{8}$ "—		
Unailed	126.50	121.45
Oiled	127.90	122.75

Above prices delivered if quantity is sufficient to warrant delivery.

Shingles (Rwd. not available)—

Red Cedar No. 1—\$6.75 per square; No. 2, \$5.75; No. 3, \$4.45.
Average cost to lay shingles, \$3.00 per square.
Cedar Shakes—Tapered: $\frac{1}{2}$ " to $\frac{3}{4}$ " x 25"—\$8.95 per square.
Resawn: $\frac{3}{4}$ " to $1\frac{1}{4}$ " x 25"—\$10.65 per square.
Resawn: $\frac{3}{4}$ " to $1\frac{1}{4}$ " x 25"—\$10.65 per square.
Average cost to lay shakes, \$4.00 per square.

MILLWORK—Standard.

D. F. \$100 per 1000. R. W. Rustic \$100.00 per 1000 [delivered].
Double hung box window frames, average with trim \$6.50 and up, each.
Complete door unit, \$10.00.
Screen doors, \$3.50 each.
Patent screen windows, 25c a sq. ft.
Cases for kitchen pantries seven ft. high, per lineal ft., \$9.00 each.
Dining room cases, \$9.00 per lineal foot.
Rough and finish about 80c per sq. ft.
Labor—Rough carpentry, warehouse heavy framing (average), \$40.00 per M.
For smaller work average, \$40.00 to \$55.00 per 1000.

MARBLE—(See Dealers)

PAINING—

Two-coat work	per yard 50c
Three-coat work	per yard 70c
Cold water painting	per yard 10c
Whitewashing	per yard 8c

PAINTS—

Two-coat work	50c per sq. yd.
Three-coat work	70c per sq. yd.
Cold water painting	per yard 10c
Whitewashing	8c per sq. yd.
Turpentine	\$1.03 per gal. in drum lots.
	\$1.08 per gal. in 5-gal. containers.
Raw Linseed Oil—not available.	

Boiled Linseed Oil—\$1.38 per gal. in drums. Available only to work with high priority—\$1.48 per gal. in 5-gal. containers.

Use replacement oil—\$1.86 per gal. in 1-gal. containers.

Replacement Oil—\$1.20 per gal. in drums. \$1.30 per gal. in 5-gal. containers.

A deposit of \$6.00 required on all drums.

PATENT CHIMNEYS—

6-inch	\$1.20 lineal foot
8-inch	1.40 lineal foot
10-inch	2.15 lineal foot
12-inch	2.75 lineal foot

PLASTER—

Neat wall, per ton delivered in S. F. in paper bags, \$17.60.

PLASTERING (Interior)—

3 Coats, metal lath and plaster	Yard 1.50
Keene cement on metal lath	1.80
Ceilings with $\frac{3}{4}$ hot roll channels metal lath (lathed only)	1.20
Ceilings with $\frac{3}{4}$ hot roll channels metal lath plastered	2.20
Single partition $\frac{3}{4}$ channel lath 1 side (lath only)	1.20
Single partition $\frac{3}{4}$ channel lath 2 inches thick plastered	3.20
4-inch double partition $\frac{3}{4}$ channel lath 2 sides (lath only)	2.20
4-inch double partition $\frac{3}{4}$ channel lath 2 sides plastered	3.85
Thermax single partition; $1\frac{1}{2}$ " channels; $2\frac{1}{2}$ " overall partition width. Plastered both sides	3.30
Thermax double partition; 1" channels; $4\frac{3}{8}$ " overall partition width. Plastered both sides	4.40
3 coats over 1" Thermax nailed to one side wood studs or joists	1.65
3 coats over 1" Thermax suspended to one side wood studs with spring sound isolation clip	1.90
Note—Channel lath controlled by limitation orders.	

PLASTERING (Exterior)—

2 coats cement finish, brick or concrete wall	Yard 1.00
3 coats cement finish, No. 18 gauge wire mesh	2.00
Lime—\$3.00 per bbl. at yard.	
Processed Lime—\$3.10 bbl. at yard.	
Rock or Grip Lath— $\frac{3}{8}$ "—20c per sq. yd.	
$\frac{1}{2}$ "—19c per sq. yd.	

Composition Stucco—\$1.80 to \$2.00 sq. yd (applied).

PLUMBING—

From \$100.00 per fixture up, according to grade, quantity and runs.

ROOFING—

"Standard" tar and gravel, 4 ply—\$8.00 per sq. for 30 sqs. or over.	
Less than 30 sqs. \$9.50 per sq.	
Tile, \$30.00 to \$40.00 per square.	
Redwood Shingles, \$7.50 per square in place.	
5/2 #1-16" Cedar Shingles, 4 1/2" Exposure	\$8.00 square

5/8 x 16"—#1 Cedar Shingles, 5" Exposure	\$9.00 square
4/2 #1-24" Royal Shingles, 7 1/2" Exposure	\$9.50 square
Re-coat with Gravel	\$4.00 per sq.
Asbestos Shingles, \$23 to \$28 per sq. laid.	
1/2 x 25" Resawn Cedar Shakes, 10" Exposure	\$10.50
3/4 x 25" Resawn Cedar Shakes, 10" Exposure	11.50
1 x 25" Resawn Cedar Shakes, 10" Exposure	12.50
Above prices are for shakes in place.	

SHEET METAL—

Windows—Metal, \$1.75 a sq. ft.
Fire doors (average), including hardware \$2.00 per sq. ft.

SKYLIGHTS—(not glazed)

Copper, 90c sq. ft. (flat).
Galvanized iron, 40c sq. ft. (flat).
Vented hip skylights 60c sq. ft.

STEEL—STRUCTURAL (None available except for defense work).

\$150 ton (erected), this quotation is an average for comparatively small quantities. Light truss work higher. Plain beams and column work in large quantities \$140 per ton.

STEEL REINFORCING (None available except for war work).

\$100 to \$130 ton, set.

STONE—

Granite, average, \$6.50 cu. foot in place.
Sandstone, average Blue, \$4.00. Boise, \$3.00 sq. ft. in place.
Indiana Limestone, \$2.80 per sq. ft. in place.

STORE FRONTS (None available).

TILE—

Ceramic Tile Floors—\$1.00 to \$1.25 per sq. ft.
Cove Base—\$1.10 per lin. ft.
Glazed Tile Wainscot—\$1.25 per sq. ft.
Asphalt Tile Floor $\frac{1}{8}$ " & $\frac{3}{16}$ "—\$.18 to \$.35 per sq. ft. Light shades slightly higher.
Cork Tile—\$.40 to \$.75 per so. ft.
Mosaic Floors—see dealers.
Lino-Tile, \$.35 to \$.75 per sq. ft.

Wall Tile—

Glazed Terra Cotta Wall Units (single faced) laid in place—approximate prices:
2 x 6 x 12.....\$1.10 sq. ft.
4 x 6 x 12.....1.25 sq. ft.
2 x 8 x 16.....1.20 sq. ft.
4 x 8 x 16.....1.40 sq. ft.

VENETIAN BLINDS—

40c per square foot and up. Installation extra.

WINDOWS—STEEL—

30c per square foot, \$5 for ventilators.

NEWS AND COMMENT ON ART

(From Page 8)

Young through September 16th will be an exhibition bearing the perplexing title, "Fitty Arty and Walkowitz." Sponsored by the American Federation of Arts, this show presents fifty different versions of the obliging Mr. W. as painted by as many noted American artists.

DONG KINGMAN TO HOLD ONE-MAN EXHIBIT AT DE YOUNG

On view at the de Young Museum, Golden Gate Park, August 21st through September 23rd will be a large comprehensive showing of the watercolors of the distinguished American artist, Dong Kingman. Private and public collections throughout the country have cooperated in lending works for this outstanding exhibition.

Well known in the Bay Region, Kingman was born in Oakland, but received the major part of his education at the Ling Nom Academy in Hong Kong, returning at the conclusion of his studies to make his home in this city. During many years of exhibiting both nationally and internationally,

he has been awarded numerous prizes and medals. Chief among them being the Guggenheim Fellowship which he received a few years ago. He is represented in the permanent collections of the San Francisco Museum of Art, the Max Cole Art Gallery, University of Nebraska, the Brooklyn Museum and the Museum of Modern Art, New York, as well as in many private collections. At present Dong Kingman is a member of the U. S. Army.

U. S. PLYWOOD EXPANDS

Stock control of the Siuslaw Forest Products Company of Mapleton, Oregon, has been acquired by the United States Plywood Corporation.

Siuslaw owns about 300 million feet of standing timber and has options on substantial additional tracts.

IN SACRAMENTO

Leonard H. Stark, Architect, has moved his offices from the deYoung Building in San Francisco, to 416 Native Sons' Building, Sacramento, Calif.

1945 BUILDING TRADES WAGE SCALES (JOB SITES) NORTHERN CALIFORNIA

Six- and seven-hour day eliminated on all Government Work. A. F. L. - O. P. M. Agreement calls for eight-hour day.

NOTE: Predeterminations by the Department of Labor, as of July 1, 1944 (the wage-freezing date) have not yet been made in all of the counties listed. The wage scales shown are those being paid and in effect mostly by agreement between employees and their union.

CRAFT	San Francisco	Alameda and Contra Costa	Fresno	Marin	Sacramento	San Jose	San Mateo	Vallejo	Stockton
	ASBESTOS WORKERS	1.50	1.50	1.25	1.50	1.50	1.25	1.50	1.50
BRICKLAYERS	1.87 1/2	1.87 1/2	1.75	1.87 1/2	1.75	2.00	1.75-1/6	1.75	1.50
BRICKLAYERS, HODCARRIERS	1.40	1.40	1.05	1.40	1.05	1.50	1.35	1.50	1.14
CARPENTERS	1.50	1.50	1.25	1.43 1/4	1.37 1/2	1.37 1/2	1.43 3/4	1.50	1.37 1/2
CEMENT FINISHERS	1.50	1.50	1.50	1.50	1.50	1.50	1.50	1.50	1.50
ELECTRICIANS	1.70	1.70	1.70	1.70	1.70	1.70	1.70	1.70	1.70
ELEVATOR CONSTRUCTORS	1.75 1/2	1.75 1/2	1.75 1/2	1.75 1/2	1.75 1/2	1.75 1/2	1.75 1/2	1.75 1/2	1.75 1/2
ENGINEERS: MATERIAL HOIST	1.50	1.50	1.25	1.50	1.37 1/2	1.62 1/2	1.50	1.37 1/2	1.25
PILE DRIVER	1.75	1.75	1.60	1.75	1.75	1.75	1.75	1.75	1.60
STRUCTURAL STEEL	1.75	1.75	1.60	1.75	1.75	1.75	1.75	1.75	1.60
GLASS WORKERS	1.40	1.40	1.12 1/2	1.40	1.12 1/2	1.21	1.40	1.40	
IRONWORKERS: ORNAMENTAL	1.60	1.50	1.60	1.50	1.60	1.31 1/4	1.50	1.50	
REINF. RODMEN	1.50	1.50	1.60	1.50	1.50	1.60	1.50	1.50	1.25
STRUCTURAL	1.75	1.75	1.75	1.75	1.75	1.75	1.75	1.75	1.37 1/2
LABORERS: BUILDING	1.00	1.00	.90	.90	.95	.90	.93 1/4	.90	.90
CONCRETE	1.00	1.00	.90	.87 1/2	.95	.90	.93 1/4	.95	1.00
LATHERS	1.75	1.75	1.50	1.75	1.60	1.75	1.75	1.75	1.75
MARBLE SETTERS	1.75	1.75	1.50	1.50	1.50	1.50	1.50	1.50	1.50
MOSAIC & TERRAZZO	1.25	1.25	1.12 1/2	1.25	1.15-5/8	1.12 1/2			
PAINTERS	1.50	1.50	1.28-4/7	1.50	1.43	1.50	1.42-6/7	1.64-2/7	1.37 1/2
PILEDRIVERS	1.54	1.54	1.54	1.54	1.54	1.54	1.54	1.54	1.54
PLASTERERS	1.75	1.83 1/2	1.75	1.75	1.75	2.00	2.00	1.75	1.83-1/3
STRUCTURAL	1.50	1.60	1.40	1.50	1.18 1/4	1.50	1.75	1.50	1.50
PLASTERERS' HODCARRIERS	1.70	1.70	1.53-1/8	1.70	1.68 1/4	1.62 1/2	1.70	1.70	1.50
ROOFERS	1.50	1.50	1.25	1.37 1/2	1.37 1/2	1.37 1/2	1.25	1.37 1/2	1.37 1/2
SHEET METAL WORKERS	1.50	1.50	1.50	1.50	1.50	1.50	1.37 1/2	1.50	1.50
SPRINKLER FITTERS	1.58	1.58	1.53-1/8	1.70	1.68 1/4	1.62 1/2	1.70	1.70	1.50
STEAMFITTERS	1.75	1.75	1.53-1/8	1.70	1.68 1/4	1.67 1/2	1.50	1.70	1.50
STONESETTERS (MASON'S)	1.87 1/2	1.87 1/2	1.50	1.75	1.75	1.50	1.75	1.75	1.50
TILESETTERS	1.50	1.50	1.37 1/2	1.50	1.37 1/2	1.50	1.50	1.50	1.37 1/2

Prepared and compiled by

CENTRAL CALIFORNIA CHAPTER, ASSOCIATED GENERAL CONTRACTORS OF AMERICA

with the assistance and cooperation of secretaries of General Contractors Associations and Builders Exchanges of Northern California.

CLASSIFIED ADVERTISING

RATE: 8c PER WORD . . . CASH WITH ORDER

MINIMUM \$1.50 (3 Lines)

ARCHITECT'S REPORTS—A valuable advance news service giving building and construction information daily on projects in Northern California. Name, location, architect, proposed cost, etc., on individual slips. Ideal for securing new business leads. Hundreds of items, total monthly cost only \$10. Don't delay, subscribe today. ARCHITECT & ENGINEER, Room 618, 68 Post Street,

San Francisco, California. Phone Douglas 8311.

ARCHITECTS—A. McF. McSwaney, Architect, Room 927 Hearst Bldg., San Francisco. New offices. Desires catalogs.

WANTED: Men on good residential working drawings and detailing. Write full qualifications. Roland E. Coate, Architect, 1111 Architects Bldg., Los Angeles, California.

PHOTOGRAPHY—Keep a pictorial record of your building, or construction project. Pictures are of tremendous value to contractors, builders, engineers, architects. For Industrial-Publicity-Aerial photography, see FRED MAE, Room 721-22 Hearst Bldg., San Francisco 3, California.

PRINTING—Printers, bookbinders. See us for commercial printing. Mercury Press, 942 Howard Street, San Francisco.

HOGAN LUMBER CO.

Wholesale and Retail

LUMBER

MILL WORK • SASH & DOORS

Office, Mill, Yard and Docks

SECOND AND ALICE STREETS • OAKLAND, CALIF.

Telephone GLencourt 6861

MALOTT & PETERSON

ROOFING AND FLOORING
CONTRACTORS

20TH AND HARRISON STREETS
SAN FRANCISCO
Phone ATwater 1600

CLINTON CONSTRUCTION CO. OF CALIFORNIA

General Contractors

923 FOLSOM STREET • SAN FRANCISCO
SUtter 3440

SANTA MARIA INN SANTA MARIA, CALIFORNIA

FRANK J. McCOY, General Manager

FERNAND E. PIMENTEL, Manager

On the
Coast
Highway
between
San
Francisco
and
Los
Angeles



American
or
European
Plan
•
Old
English
Tap
Room

A. I. A. ACTIVITIES

(From Page 31)

JOHN H. AHNDEN, ARCHITECT, one of San Francisco's most loved and respected members of the architectural profession, passed away on July 10 of this year. In his early years he worked with Mr. Henry Schulze, Architect, and for Bakewell and Brown, architects for San Francisco City Hall, on which plans he spent many months. He leaves behind him memories of ability, faithfulness and modesty that are accorded to few in any profession.

letin. This must be postponed to next month, but the affairs of the meeting must be done here, if it can be got into the press in time.

The guest of honor at the July meeting was Miss Elinor Hillyer, "Design for Living" editor for "Madoiselle Magazine". She is traveling to various parts of the country for the purpose of selecting five architects who will construct houses typical of their regions.

The principal speaker of the evening was Architect Conrad Kett who is serving with the Priorities Division of the War Production Board of San Francisco. The bulletin says that Mr. Kett "explained the various orders of the War Production Board." If that is literally true, the meeting must have lasted well into the small hours of the morning. He also stated that he was prepared to assist any architect who desired help when he called at the War Production Board on priority matters. During Mr. Kett's excellent and informative talk he was assisted by Architect Ralph Kerr, of the Federal Public Housing Authority, and Architect Houghton Sawyer, of the War Production Board. Their assistance took the form of helping to answer questions that were asked during the closing discussion.

The feature article in the bulletin is entitled "Your Responsibilities", by Langdon W. Post. It is followed by an article by Samuel Lunden and other items, all of which should be read by every architect who is interested in his profession. If the bulletin can keep up the present quality, public demand will force it to enlarge.

VIBRATION

Vibration control, the effects of vibration, and how applied to many kinds of machines and equipment, is contained in a bulletin recently issued by the Korfund Company, Inc., 48 32nd Place, Long Island City 1, New York.

BOOK REVIEWS

PUMP ENGINEERING DATA. Compiled and published by Economy Pumps, Inc., Hamilton Ohio. Price \$2.00. (Free on application engineers and architects written on their personal letterheads.)

Reviewing this most remarkable and complete book is like trying to describe California for, as the distinguished Senator James D. Phelan said, "You can't tell the truth about it without lying about it." The book has 416 pages of the most complete and serviceable data on pump engineering I have ever seen. It contains articles on general principles of hydraulics as well as pumping, performance curves and efficiency curves, pump capacities and fuel consumption. It is illustrated with hundreds of cuts, many of them mechanical drawings of sections through pumps and installations and even the plan of a golf course layout to illustrate the water distribution in such a problem. Almost every phase of the general subject of hydraulics, not confined to pipe flow or direct pumping, such as the flow through weirs, is fully and well detailed. In fact, I would not hesitate to say that "Pump Engineering Data" is the best and most complete book I have ever seen on a subject covered by its title.

THE LOCAL HOUSING AUTHORITY AND THE ARCHITECT. By Oliver C. Winston. Foreword by High R. Pomeroy. Public Administration Service, 1313 East Sixteenth Street, Chicago 37, Illinois. Price 60 cents.

This brochure handles a subject that is vital to many architects, in an unusually clear and convincing manner, but just how long it will remain of vital interest to us depends upon the ephemeral promises from Tokio. Nevertheless it is worth buying and reading right now.

LOCATES IN BERKELEY

Russell Guerne deLappe, Architect, has moved his offices from 544 Market Street, San Francisco, California, to the Claremont Hotel, Berkeley 5, California.

TOUGHER CONCRETE

The results of scientific research recently completed by chemists at the Ohio State University, indicate that concrete in the \$20 billion construction program planned for the first two postwar years will last much longer with far less maintenance cost if a small amount of a lignin product is added.

The product, calcium lignosulfonate, is made from paper mill waste.

"AMERICAN - MARSH"

CONDENSATION UNIT

Pumping
Machinery
for
Every
Purpose

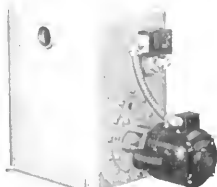

For Service
Call
DOuglas
6794
or
MUtual8322

SIMONDS MACHINERY CO.
SAN FRANCISCO LOS ANGELES
816 FOLSOM 455 EAST 4TH

VERMONT MARBLE COMPANY

Producers and Finishers
of
Domestic and Imported Marbles

Write for new pamphlet describing our
Marble Toilets and Showers

San Francisco and Los Angeles
San Francisco phone: SUtter 6747



The Most Complete Line of
STEELS and BUILDING MATERIALS
Made by a Single Producer



See Sweet's Catalog File or write us for
full information.

REPUBLIC STEEL CORPORATION
GENERAL OFFICES: CLEVELAND, OHIO

DENVER, COLORADO . . . CONTINENTAL OIL BUILDING
LOS ANGELES, CALIFORNIA . . . EDISON BUILDING
SALT LAKE CITY, UTAH . . . WALKER BANK BUILDING
SAN FRANCISCO, CALIFORNIA . . . RIALTO BUILDING
SEATTLE, WASH. . . . WHITE-HENRY-STUART BUILDING

PACIFIC MANUFACTURING CO.

HIGH CLASS INTERIOR FINISH
QUALITY MILLWORK
142 SANSOME ST., SAN FRANCISCO
GARfield 7755
6820 MCKINLEY AVE., LOS ANGELES
THornwall 4196
BUILDERS EXCHANGE, OAKLAND

BASALITE

CAMBERED SHINGLE TILE

PERMANENT • FIREPROOF • STORM-
SAFE • COLORFUL • ECONOMICAL

Manufactured by

BASALT ROCK CO., INC.

NAPA, CALIFORNIA

FORDERER CORNICE WORKS

Manufacturers of

Hollow Metal Products • Interior Metal Trim
Elevator Fronts and Cabs

Metal Plaster Accessories • Sanitary Metal Base
Flat and Roll Metal Screens

Metal Cabinets • Commercial Refrigerators

269 POTRERO AVE.

SAN FRANCISCO, CALIF.

HEMLOCK 4100

STRUCTURAL STEEL

For Class A Buildings,
Bridges, etc.

JUDSON PACIFIC - MURPHY CORP.

1200 SEVENTEENTH STREET
SAN FRANCISCO

Plants: San Francisco - Oakland

SISALKRAFT

REG. U. S. PAT. OFF.

"More than a building paper"

THE SISALKRAFT CO.

205 West Wacker Drive
Chicago, Ill.

55 New Montgomery Street
San Francisco, Calif.

GLIMPSES OF ARCHITECTURE—MEXICO

(From Page 30)

spring of warm mineral water gushes from the rock.

From the nature of the terrain no standard plan seemed adaptable, if the cost was to be kept down. Thus, the architect's creative ability was given a test, and he succeeded admirably.

The program called for the bathing unit to be independent of the hotel. As far as practicable the work was to be of fireproof construction.

A road was cut out of the hillside to a circular space to provide parking for such automobiles as could not be accommodated near the hotel on account of the grade at the lower elevations. The road was then continued to the location contemplated for the administration building and garage.

Dining room site was selected some 200 feet distant to command the best view of the surrounding panorama. A covered terrace contiguous to the dining room was constructed for those desiring open-air meals.

Guest rooms, single and en suite with bath, were arranged for easiest accessibility to all the facilities provided. Circling groups of the accommodations for guests were connected by covered porches; solariums located at vantage points; a lookout tower of ample proportions was built over the dining room and another over the administration building. Plenty of large windows and chummy balconies are included. Trees and great boulders in the way of various units were encircled by the building, surrounded by a stair, lounge or passage to add charm and interest.

Much of the hillside has now been planted with evergreen citrus trees. Flowering shrubs and cacti are used to advantage at rocky points. Walks, roads, garden and lawns surround these buildings, including bungalows at the east end of the site.

Near the mineral spring are three concrete bathing pools. On two sides are dressing rooms. The remaining sides are planted with shade trees, lawn and flowers, where easy chairs and tables invite rest and refreshment.

It is obvious that the architect in planning this project took into consideration in his plans the furnishing of maximum comfort and enjoyment to the guests through employment of all the natural advantages, as well as minimum expense for leveling the site and costs of construction; all of which pays excellent dividends to the owner.

This article should hardly be concluded without reference to a recent meeting I attended of la Sociedad de Arquitectos Mexicanos, presided over by its Presidente, Carlos Obregon Santicilia. Mexico has about 250 registered architects. It was a pleasure to meet these gentlemen, many of who speak excellent English.

THE TORMEY COMPANY

GENERAL PAINTERS
AND DECORATORS

Phone UNDERhill 1913

563 FULTON STREET
San Francisco

IN THE NEWS

BUILDING PERMITS RISE

Continuing to trend upward the value of building permits issued in 215 cities for the first half of 1945 showed an increase of 31.1 per cent over a year ago, according to Dun & Bradstreet.

HOSPITAL PLANNING



One of the most complete books ever published on the subject of hospital planning has just been issued by the Wewaunee Manufacturing Company, Adrian, Michigan.

Architects, designers, engineers, hospitals and institutions will find many suggestions for planning health centers, various schematics for hospitals and health centers, and standardized hospital case-work units.

MOLDED PLASTICS

Recent developments in the field of plastics are described in an illustrated brochure recently issued by the MACK MOLDING COMPANY, INC., 180 Main Street, Wayne, New Jersey. Copies available by writing the company direct.

RUBBER GOODS CATALOG

Complete, up-to-the-minute product information and construction details on standard line industrial rubber products is offered in a new catalog issued by the Goodyear Tire & Rubber Company, Akron, Ohio.

Synthetic rubber construction in currently produced mechanical rubber products is included in the catalog.



HERRICK IRON WORKS

STRUCTURAL STEEL
REINFORCING STEEL

18TH AND CAMPBELL STS.
OAKLAND, CALIF.
Phone GLencourt 1747

Phone GARfield 1166

Thomas B. Hunter

Consulting Engineer
DESIGNER OF HEATING
AIR CONDITIONING
VENTILATING AND WIRING
SYSTEMS, MECHANICAL
AND ELECTRICAL EQUIP-
MENT OF BUILDINGS

41 SUTTER STREET
ROOM 710
San Francisco California

JOHN CASSARETTO COMPANY

—Since 1886—And Still Active—

Building Materials

READY MIX CONCRETE
ROCK - SAND - GRAVEL - LIME
CEMENT - PLASTER - MORTAR
METAL LATH - WOOD LATH
STUCCO - WIRE NETTING

Service Unexcelled

Bunkers

Sixth and Channel, San Francisco
Phones: GARfield 3758 - 3760

MULLEN MFG. COMPANY

BANK, STORE AND OFFICE
FIXTURES—CABINET WORK
OF GUARANTEED QUALITY
CHURCH SEATING

Office and Factory:

60-80 RAUSCH ST., Bet. 7th and 8th Sts.
San Francisco
Telephone UNDERhill 5815

ANDERSON & RINGROSE

General Contractors

320 Market Street, San Francisco
Phone GARfield 2245

DINWIDDIE CONSTRUCTION COMPANY

•
BUILDERS
•

CROCKER BUILDING
SAN FRANCISCO

A. F. MATTOCK CO.

Builders

★

212 CLARA STREET
SAN FRANCISCO

Independent Iron Works

Structural Steel
Ornamental Iron
Steel Service Stations
Steel Tanks
Standard Steel Mill Buildings
Bridges

821 Pine Street Oakland

George F. Brayer

ELECTRICAL
CONTRACTOR

166 Seventh Street
San Francisco

Phones: KLondike 2-0879
HEmlock 2646

Scott Company

HEATING . . . PLUMBING . . . TILE

★

243 MINNA STREET
SAN FRANCISCO
Phone EXbrook 6741

Index to Advertisers

* Indicates Alternate Months

ALADDIN Heating Corp.	48
ANDERSON & Ringrose	47
ANGIER Sales Corporation	33
ARCHITECTS Reports	40
BASALT Rock Company	46
BAXTER & Company, J. H.	34
BRAYER, George F.	48
CASSERETTO, John	47
CLARK, N., & Son	*
CLASSIFIED Advertising	43
CLINTON Construction Company	44
COLUMBIA Steel Co.	*
COLOTYLE Corporation	*
CROCKER First National Bank	36
DINWIDDIE Construction Company	47
FORDERER Cornice Works	46
FULLER, W. P., Co.	39
GUNN, Carle & Company	36
HANKS, Inc., Abbot A.	48
HAWS Drinking Faucet Company	Back Cover
HERRICK Iron Works	47
HOGAN Lumber Company	44
HUNT, Robert W., Company	48
HUNTER, Thos. B.	47
IMPERIAL Brass Manufacturing Co.	*
INDEPENDENT Iron Works	48
JENSEN & Con, G. P. W.	47
JOHNSON Company, S. T.	*
JUDSON Pacific-Murphy Corp.	46
KRAFTILE Company	*
KAWNEER Company	*
MALOTT & Paterson	44
MATTOCK, A. F.	48
MULLEN Mfg. Co.	47
MUELLER Brass Co.	2
NORTHERN California Electrical Bureau	35
OWENS Corning Fiberglas Co.	*
PACIFIC Coast Gass Association	*
PACIFIC Manufacturing Company	45
PACIFIC Portland Cement Company	Inside Back Cover
PARAMOUNT Built-in Fixture Co.	36
PARKER, STEFFINS & PEARCE	1
PAYNE Furnace & Supply Co., Inc.	7
PORTLAND Cement Association	5
REMILLARD-Dandini Co.	48
REPUBLIC Steel Corporation	45
SANTA Maria Inn	44
SCOTT Co.	48
SIMONDS Machinery Company	45
SISALKRAFT Company	46
SMOOT-Holman Co.	37
STANLEY Works, Inc., The	40
SOULE Steel Co.	*
TIMBER Engineering Co., Inc.	*
TORMEY Company, The	47
UTILITY Appliance Corp.	31
U. S. STEEL Company	*
VERMONT Marble Company	45
WAR Bonds	6
WESTERN Asbestos Company	Inside Front Cover
WOOD, E. K., Lumber Company	39

ABBOT A. HANKS, INC. Engineers & Chemists

INSPECTING — TESTING — CONSULTING
CONCRETE — STEEL — MATERIALS
CHEMICAL AND TESTING
LABORATORIES
● RESEARCH AND INVESTIGATION ●

TESTS OF STRUCTURAL MATERIALS
DESIGN OF CONCRETE MIXES
SHOP AND ERECTION INSPECTION OF
STRUCTURES AND EQUIPMENT
INVESTIGATION OF STRUCTURES
AND MATERIALS
TESTS AND INVESTIGATION OF
FOUNDATION SOILS
FIRE RESISTANCE AND INSULATION
TESTS

624 Sacramento Street, San Francisco

A LADDIN Heating Corp.

Specializing in
QUALITY HEATING
EQUIPMENT

2222 San Pablo Avenue
OAKLAND
TWinoaks 1022

REMILLARD-DANDINI Co.

Brick and
Masonry Products

★

633 BRYANT ST., SAN FRANCISCO
569 THIRD ST., OAKLAND

Robert W. Hunt Company ENGINEERS

Inspection • Tests • Consultation
Schools and Other Structures
Are Built as Designed

*When Construction Materials are
Inspected at point of Manufacture
and during Erection by*

ROBERT W. HUNT COMPANY

*Cement, Concrete, Chemical, Metallurgical,
X-Ray and Physical Laboratories*

Chicago • New York • Pittsburgh
Los Angeles • All Large Cities
San Francisco, 251 Kearny Street

ARCHITECTURE AND ENGINEER

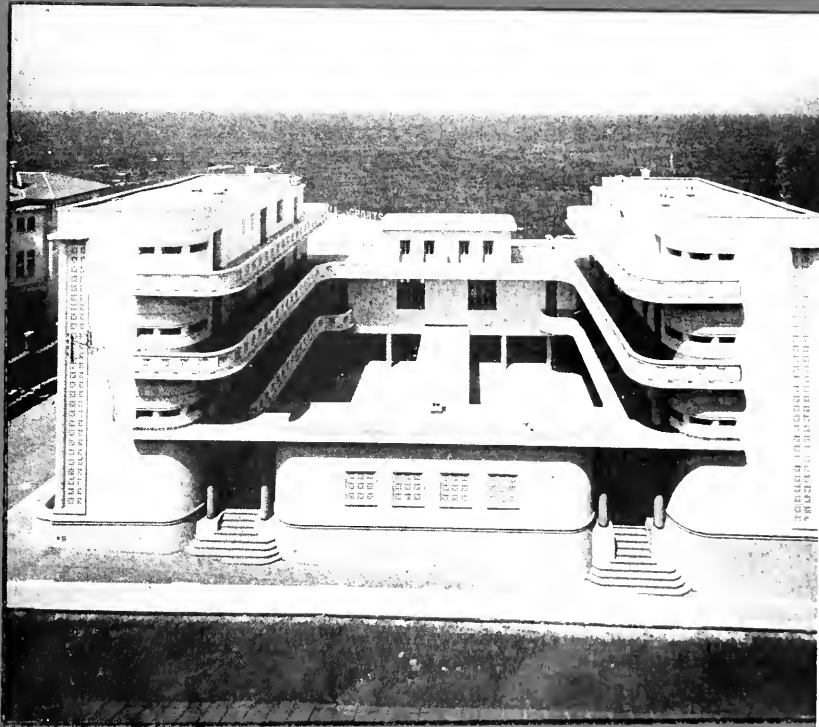

OCTOBER

1945

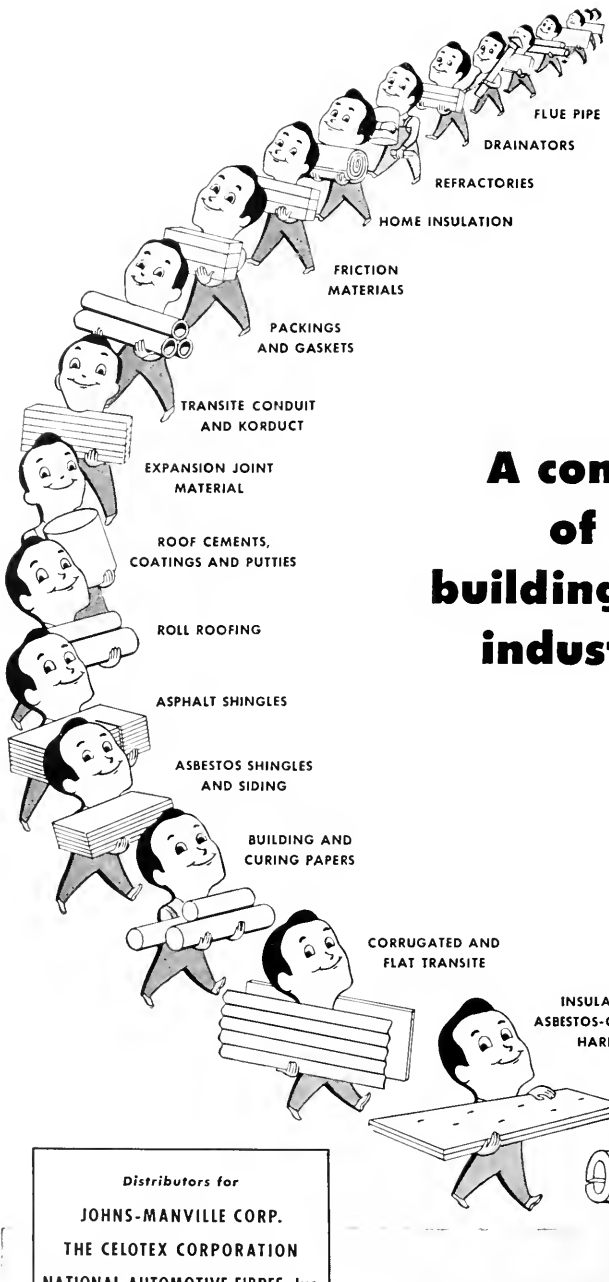

FLUE PIPE

DRAINATORS

REFRACTORIES

HOME INSULATION

FRICTION MATERIALS

PACKINGS AND GASKETS

TRANSITE CONDUIT AND KORDUCT

EXPANSION JOINT MATERIAL

ROOF CEMENTS, COATINGS AND PUTTIES

ROLL ROOFING

ASPHALT SHINGLES

ASBESTOS SHINGLES AND SIDING

BUILDING AND CURING PAPERS

CORRUGATED AND FLAT TRANSITE

INSULATING BOARDS
ASBESTOS-CEMENT BOARDS
HARD BOARDS

INSULATING MATERIALS FOR PIPING, BOILERS, INDUSTRIAL EQUIPMENT AND REFRIGERATION

A complete source of supply for building materials and industrial products

Distributors for
JOHNS-MANVILLE CORP.
THE CELOTEX CORPORATION
NATIONAL AUTOMOTIVE FIBRES, Inc.
THE COE MANUFACTURING CO.
ANGIER CORPORATION

WESTERN ASBESTOS CO.

Building Materials · Industrial Products

• ARCHITECT

Vol. 163 No. 1

ARCHITECTS' REPORTS—Published Daily
Telephone DOuglas 8311

AND ENGINEER

MARK DANIELS, A.I.A.
Editor

E. H. WILDER
Associate Editor

JOHN S. BOLLES, A.I.A.
Book Reviews

MICHAEL GOODMAN
Post-War Planning

L. H. NISHKIAN
Consulting Editor

E. N. KIERULFF*
Ass't Editor
*In the Service

Contents for



OCTOBER

COVER: North African Grammar School (see Page 9)

ARTICLES AND MISCELLANEOUS TEXT

RUNNING FIRE	4
By MARK DANIELS	
NEWS AND COMMENT ON ART	8
COVER PICTURE	9
THE BAY MEADOWS AIRPORT	10
NEW GENERAL MOTORS TECHNICAL PRODUCTION CENTER	12
HEADLINE NEWS & VIEWS	13
By E. H. W.	
PROPOSED FASHION BUILDING FOR LOS ANGELES	14
RISLEY AND GOULD, Architects—H. C. BURGE	
ERNEST C. HILLMAN, Structural Engineer	
E-L-E COMPANY, Electrical and Mechanical Engineers	
INGENIOUS INVENTION CONVERTS ENERGY IN SUN'S RAYS INTO DYNAMIC POWER	15
By EDWIN H. WILDER	
SOME GENISTAS FOR THE GARDEN	16
By MARDI	
A NEW WINDOW DESIGN FOR TOMORROW'S IDEAL HOME	17
A GLIMPSE AT THE SCHOOL PLANT OF THE FUTURE	18
By ARTHUR M. PRIAULX	
ARCHITECTURE IN NORTH AFRICA	22
By J. WELLS HASTINGS	
PROPOSED VETERAN'S MEMORIAL CIVIC AUDITORIUM AND CONVENTION HALL FOR SAN DIEGO	29
By JOHN S. SIEBERT, A.I.A.	
A. I. A. ACTIVITIES	31
WITH THE ENGINEERS	32
PRODUCERS' COUNCIL PAGE	38
ESTIMATOR'S GUIDE	41
CLASSIFIED ADVERTISING	43
BOOK REVIEWS	45
ADVERTISERS' INDEX	48



ARCHITECT AND ENGINEER (Established 1905) is published on the 15th of the month by The Architect and Engineer, Inc., 68 Post St., San Francisco 4; Telephone EXbrook 7182. President, K. P. Kierulff; Vice-President and Manager, L. B. Penherwood; Treasurer, E. N. Kierulff; Advertising Manager, V. E. Atkinson, Jr.

Los Angeles Office: 403 W. 8th Street.

Entered as second class matter, November 2, 1905, at the Post Office in San Francisco, California, under the Act of March 3, 1879. Subscriptions United States and Pan America, \$3.00 a year; \$5.00 two years; foreign countries \$5.00 a year; single copy 50c. ARCHITECTS' REPORTS are published daily from this office, Vernon S. Yallop.



RUNNING FIRE — by MARK DANIELS

THE ARCHITECTS

The architectural organizations are so bound up with woolen strings of their own weaving that most of them will be unable to reap the long-awaited harvest of activity in their profession. Much of this "woolen string" of their so-called ethics. If you should make an inquiry of the office of the A.I.A. for an architect you could hire to help you on your building problem, you would, in all likelihood, be told that it was hardly ethical for a chapter of the Institute to mention the names of available architects and that you should look for the name in the telephone directory.

Most of us think of such an organization as a clubbing together of men for the purpose of helping one another, particularly the needy, but the names of architects who are idle and want work seem to be withheld.

Every branch of industry is putting forth effort to develop work to make jobs for G I's and other craftsmen who want to work, and a large share of this work will be in building construction which needs an architect before it in turn can get going. Keeping secret the names of architects who want to make such plans is no way to help in this emergency.

A SOLUTION

One way out of the above self-inflicted dilemma has been opened by the Northern California Chapter of the A.I.A. and the Northern California Association of Architects. It has been decided that, while giving the name of one architect would be unethical (imagine), the recital of three names would be quite O.K.

So the officers of those two organizations have circulated the architectural profession with the following letter, for which all architects are grateful.

TO ALL ARCHITECTS:

The combined office of the Chapter and the Association receives a continuous flow of requests from the public for information and advice on architectural problems. These requests cover a wide field, in small homes, stores, schools, subdivisions, and even included a request for an architect to do a dining hall for a Government agency. Under our past policy, the Office Secretary was unable to supply this information. In order to overcome this difficulty the Board of Directors of both the Northern California Chapter and the Northern California Association are asking for a self-classification of all Architects in Northern California.

A file will be maintained in the office for each of the types of work indicated below. Your name will be kept in the file, or files, for the classifications you select. You are free to select any, or all, of the items listed below. The Office Secretary will be instructed to respond to each call with a list of three Architects, with the names to be given in rotation, for the classification of work requested.

Your cooperation in this effort to supply the public with the information which they so urgently request will keep this work within the profession.

The Boards of Directors of
Northern California Chapter
The American Institute of Architects
and
Northern California Association of
Architects

Check, sign and return this letter to 369 Pine Street, San Francisco 4.

Hotels	Institutional Buildings
Apartments	Hospitals
Churches	Clubs & Fraternity
Theaters & Auditoriums	Houses
Commercial Buildings	Mausoleums
Public Buildings	Residences

Name

Address

Phone

PRESIDENTIAL ORDER REPORT READY

A comprehensive report prepared by the U. S. Bureau of Reclamation containing a program of coordinated and multiple-purpose dams, reservoirs, canals, power plants, and other works designed to meet the expanding farm and industrial needs of California's increased population has been completed and sent to Washington.

Known as "The Central Valley Basin Report," the plan provides for farm homes for demobilized service men and war workers; will supply construction jobs in the reconversion to peace period, and in general will meet the State's land, water, and power needs for the next 15 years.

The Basin Report proposes ultimate development costing \$1,800,000,000.

Copies of the 300-page document are available through the Regional Director, U. S. Bureau of Reclamation, Old Postoffice Building, Sacramento 14, California.

It is with deep regret that we learn of the sudden death of James C. Ogden, Chairman of the Board of Directors of the Robert W. Hunt Company, on Monday, September 10, 1945.

Provide *New Freedom* with your clever kitchen-designs



SCIENTIFICALLY-PLANNED TO SAVE STEPS AND EFFORT

Every woman wants an *attractive* kitchen... enjoyable to enter, but easy to leave when outside interests call. ★ She wants to take fewer steps at her work, make less effort, yet be more certain of success as homemaker and hostess. ★ Picture her ... *your* client ... with a gas-equipped kitchen such as this ... proud to show it, happy to use it, but never "tied down." ★ There's a CP gas range for quick, sure cooking ... a silent, dependable gas refrigerator ... automatic gas hot water service ... gas heating and air-conditioning for year-around comfort throughout the house. ★ For owner satisfaction and good will, specify *gas*. Your own gas company offers helpful consultation in planning new construction or remodeling.



THE PACIFIC COAST GAS ASSOCIATION

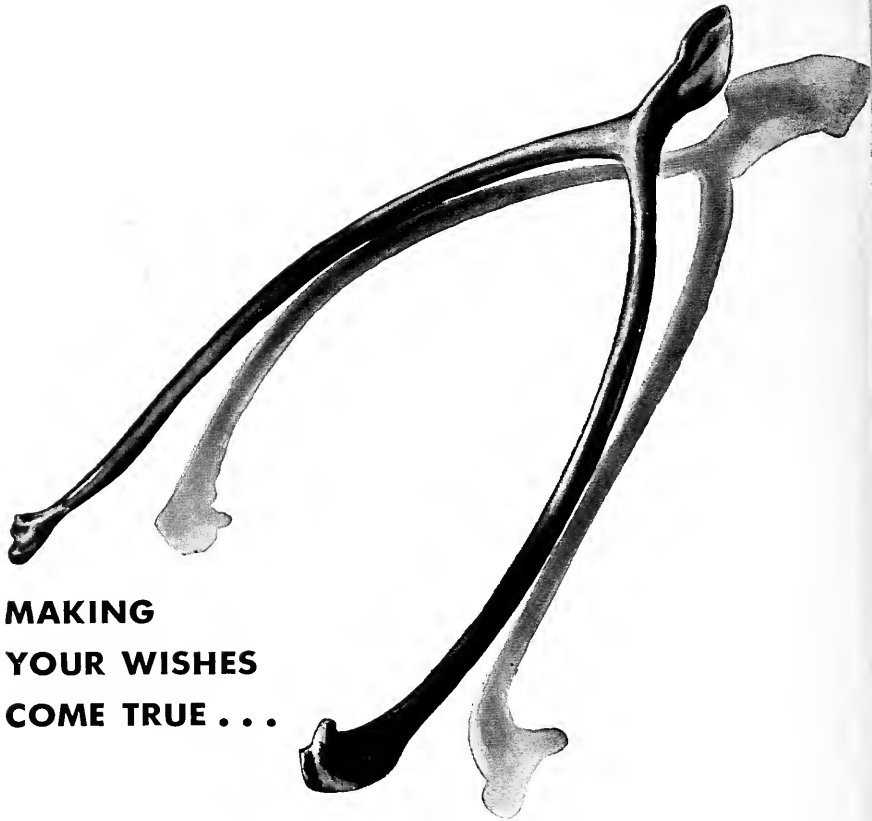

**MAKING
YOUR WISHES
COME TRUE . . .**

One wish has been fulfilled. Won by 3½ years of deadly struggle. With God's help, we have prevailed.

Now we have a chance to make another wish come true. For most of us, the outlook is a bright one. If we will simply use the brains, the will, the energy, the enterprise . . . the materials and resources . . . with which we won our war, we can't fail

to win the peace and to make this the richest, happiest land the world has known.

Your wishes have been wrapped in that bright outlook. Your wish for a cottage by a lake. For your boy's college education. For a trip you long to take. For a "cushion" against emergencies and unforeseen needs.

You can make those wishes come

true by buying bonds today . . . buying them regularly . . . and holding on to them in spite of all temptation.

There's no safer, surer investment in the world. You can count on getting back \$4 for every \$3 you put in—as surely as you can count on being a day older tomorrow.

So why not be patriotic and smart at the same time?

**FULFILL YOUR WISH—BUY EXTRA BONDS
IN THE GREAT VICTORY LOAN!**

ARCHITECT AND ENGINEER

★ *This is an official U.S. Treasury advertisement prepared under the auspices of Treasury Department and War Advertising Council* ★

MODULAR COORDINATION

... ONE *sure* WAY TO REDUCE BUILDING COSTS

*Over 50%
Saving!*



Modular Coordination Saves Time: Architect, engineer, contractor, building craftsman and materials manufacturer save time when all significant dimensions of plans, materials and equipment conform to a common denominator: the standard 4-inch module.

Modular Coordination Reduces Waste: Cutting and fitting of material in field erection is a costly waste. Dimensionally-coordinated materials match modular-coordinated plans with minimum waste of materials and labor, saving as much as 50 per cent of the time customarily consumed by cutting and fitting.

Modular Coordination is the Logical Answer to Rising Building Costs: Because it reduces costs by eliminating waste, modular coordination contributes to lower costs of construction, thus encouraging increased volume without sacrificing architectural effect, convenience or permanent value.

For further information, contact KRAFTILE Company

"We acknowledge the assistance of the American Institute of Architects in criticizing the subject matter and form of presentation of this publication."

"KRAFTILE CAN ANSWER YOUR
SPECIAL CONSTRUCTION PROBLEMS"

KRAFTILE COMPANY NILES, CALIFORNIA

NEWS AND COMMENT ON ART

DONG KINGMAN AT THE DE YOUNG MUSEUM

During September the de Young Museum held an exhibition of the paintings of one of America's leading watercolorists, **Dong Kingman**. Ever since his return to his native California in 1929 after completing his art studies in Hong Kong, Kingman has risen steadily from the ranks of a talented local artist to one whose maturing style has won him ever-increasing recognition throughout the country, as well as internationally. Perhaps one of Kingman's major contributions to contemporary painting is his unique blending of Chinese calligraphy with western watercolor technique.

The changing American scene that Kingman has been allowed to view through his winning of the Guggenheim Fellowship a few years ago (incidentally, he is the only Chinese painter ever awarded this honor) should be a source of particular interest to Bay Area visitors who so far may have seen only the artist's land and seascapes of San Francisco and its environs.

Kingman is represented in the permanent collections of the San Francisco Museum of Art, the Mills College Art Gallery and the University of Nebraska, as well as in such leading eastern museums as the Metropolitan, the Museum of Modern

Art, Brooklyn Museum, Boston Museum of Fine Arts and the Art Institute of Chicago.

The California Palace of the Legion of Honor, San Francisco, is featuring a special memorial exhibition of 11 William Keith Paintings, given to the city in 1941, by Gordon Blanding, art connoisseur and retired attorney, who passed away here on September 11.

Under the terms of the gift, according to Dr. Jermaine MacAgy, acting Director of the Museum, the collection must be exhibited for 40 consecutive days each year. The California Palace of the Legion of Honor acts as trustee of the collection.

The memorial exhibition will continue through October 31.

THE SAN FRANCISCO ART ASSOCIATION, in their August bulletin, announces a most successful summer session was carried through this year. McCRAVY'S day classes were heavily attended. The enrollment total was 258 students. Dr. MacAgy set forth the merits of the new program clearly in the August bulletin. He says:

"The new program of the California School of Fine Arts has been planned carefully to accommodate the interests of students who will take part in the affairs of a changed world. While it is true that schools always must keep alert to changing circumstances in the environment for which they train their students, the greatly accelerated change caused by the war presents a special challenge.

"Too frequently in the past the art schools of this country have not prepared students to take their place in existing community affairs. Or else too often they have trained students to cope with common community standards at the expense of imaginative freedom. The immediate challenge is to find some means by which the separate evils may be dissolved, and surely the time has not for years been more opportune."

THE MILLS COLLEGE ART GALLERY announces an exhibition of **THE EVOLUTION OF MODERN ART**, demonstrated by sculptures, paintings, drawings and prints and photographs. It will be held from September 28 to December 2, open Wednesday, Friday and Sunday, 2 to 5.

THE CALIFORNIA PALACE OF THE LEGION OF HONOR, at Lincoln Park is offering a new course on the **PRIMITIVE ARTS AND FOLK WAYS** to be given by Dr. Jermaine MacAgy which will begin October 3rd, admission free.



DONG KINGMAN

COVER PICTURE

MODERN ALGERIAN ARCHITECTURE

Featured in the cover of this month's issue is ARCHITECT & ENGINEER a study of the new grammar school buildings of Algiers, designed by the prominent Algerian architect X. Salvador.

A study of current architectural trends in the North African country shows a retention of the proverbial loggia or balcony, but streamlined to meet European trends, with pre-cast concrete grilles used for shade, privacy and protection on the first floor.

The building is divided into two distinct sections. The left portion has been designed and set aside for a girls' school, while the right section is used for a boys' school classroom. According to Algerian custom boys and girls are kept in separate classes until they reach the University.

Overlooking the sea the building offers a striking contrast to native structures.

WILLIAM GROPPER

William Gropper, one of America's foremost contemporary artists in the field of satire, is now exhibiting a small, but highly representative group of his paintings of San Francisco's de Young Museum.

The present exhibit of Gropper's works will remain at the de Young through October.

SELF-PORTRAIT WITH SOCIAL SIGNIFICANCE



By William Gropper

Mr. Gropper's introduction of himself, first seen in the exhibition, "Meet the Artist," held at this museum in 1943.

One-man exhibit of Gropper's paintings at the de Young through October.



SAN FRANCISCO HARBOR

By Dong Kingman

water color exhibited by DeYoung Museum in September

COPELAND BURG

Copeland Burg, prominent Chicago painter whose works have aroused interest in national shows during recent years, is now holding a one-man exhibition at the de Young Museum. On view are two dozen canvases which include adroitly painted still lifes and colorful compositions of Mexican landscapes and street scenes. These will remain up through October.

WILMA PREZZI

Feeling that the acquisition of rare Chinese art objects is an indulgence few can enjoy, and wanting to transmit faithfully onto canvas the lasting beauty of early Oriental plastic art, Wilma Prezzi, young eastern artist, has struck a novel idea in the group of twenty paintings she is now exhibiting at the de Young Museum. Bronze ritual vessels and statues, terra cotta fixtures and animals, stone Bodhisattvas and delicate porcelain cases, encompassing 2000 years of Chinese culture, are recorded by Miss Prezzi in this series of tastefully painted oils, remaining on view through October.

REOPENS OFFICE

Henry Temple Howard, Architect, has reopened offices for the general practice of architecture at 605 Market Street, San Francisco, California.

HEADQUARTERS ESTABLISHED

The headquarters of the Guy F. Atkinson Company have been established at 10 West Orange Avenue, South San Francisco, California, mail address being P. O. Box 593, South San Francisco.

The firm will continue a branch office at 662 Russ Building, San Francisco.

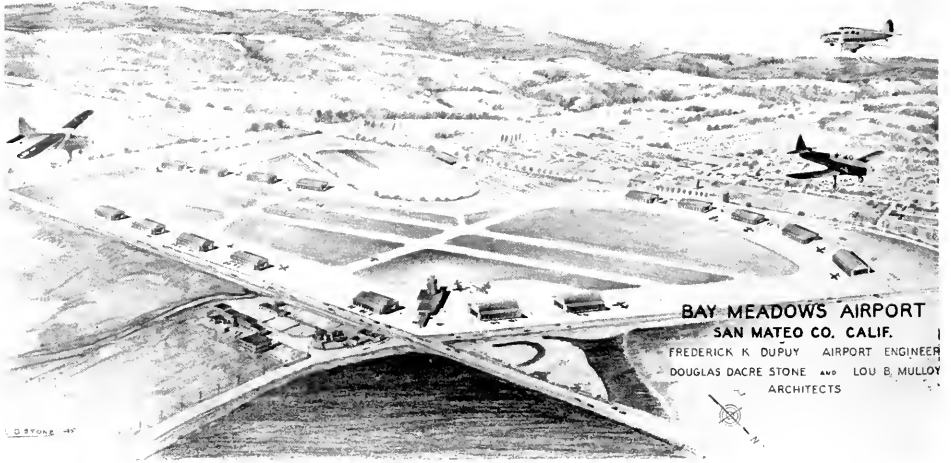

The Bay Meadows Airport

Originally known as the Curtiss Wright Field when it was operated as a student training field, the contemplated Bay Meadows Airport is located about seven miles southwest of the San Francisco International Airport, and is just north of and adjoining the Bay Meadows Race Track.

Midway between the Bayshore Highway and El Camino Real the Airport is served by 19th Avenue of San Mateo on the north and Broadway on the south, as well as the Southern Pacific Railway on the west, thereby being centrally located and easily accessible from a highway, or railway, standpoint.

Ideal visibility and flying conditions make the site superior for an airport.

Preliminary surveys of postwar private-plane activities indicate there will be over 1500 registered aircraft in San Francisco and San Mateo counties, plus from 15 to 25 major sales agencies, which means there must be airport facilities available aside from the regular commercial aircraft terminals. Smaller planes require a slower and more limited traffic pattern.

Flying schools with their student pilots, low cruising speeds, and small aircraft cannot be a

traffic menace to the large fast airliners which must keep exact schedules of arrivals and departures.

The Bay Meadows Airport, therefore, has been designed to (a) accommodate primary flying schools, (b) accommodate aircraft sales agencies, (c) house, park, and service private aircraft, and (d) provide facilities for transients and others.

A spacious Class 3 airport, with ample parking areas is needed to serve San Francisco, San Mateo county and the adjoining areas.

It is proposed to construct the main Bay Meadows Airport runway 5300 feet long by 1200 feet wide, thereby providing for 85 per cent of the landings and take-offs. A second runway 3500 feet long by 800 feet wide, estimated to take care of all other wind conditions, is also proposed.

The extra large size runways have been designed to promote safety and to take care of future peak loads.

It is proposed to use well drained, firm, grass turf runways at first and then as conditions warrant to install dual paved runways on the major flightway, and a single paved runway on the secondary flightway.

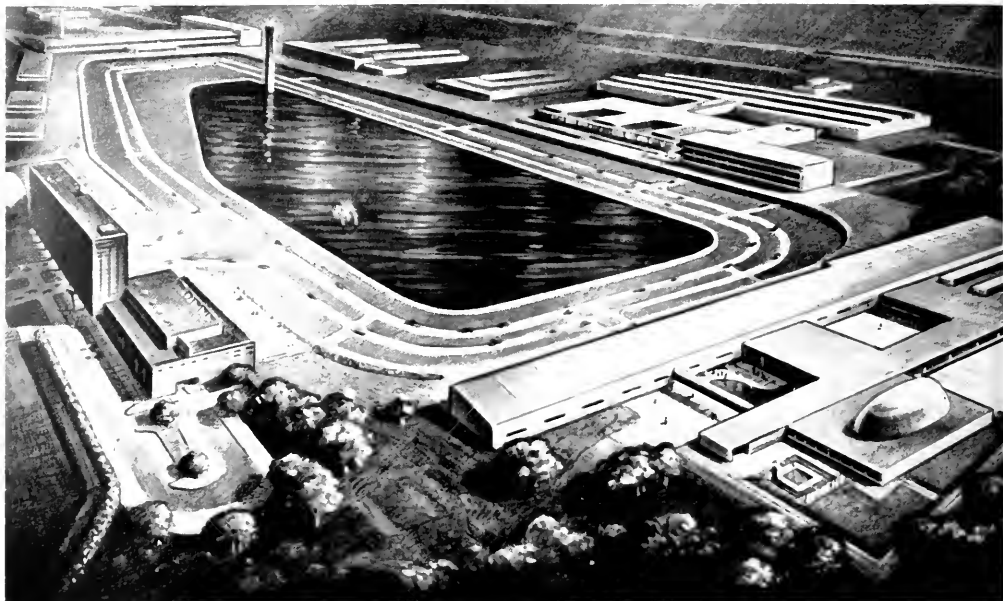

The New General Motors Technical Production Center

Utility and beauty are combined in the overall design of the new General Motors Technical Center, as shown here, which is to be built just outside the automobile center of Detroit.

The view shows the layout of buildings and connecting roadways around the central esplanade and is designed to meet postwar needs of a modern industrial activity which will produce more jobs through research.

The central lake will supply water for cooling as well as lending beauty to the area.

At the lower left is the Administration building, and at lower right is the new Styling Section building. To its left and just to the right of the water tower is the Process Development building, and at the extreme end is the Research Laboratories building.

Other buildings shown in the design are indicative of potential expansion.

THE CONSTRUCTION OUTLOOK

More than 5,000,000 property owners have been unable to make improvements, repairs, and alterations amounting to almost \$2,000,000,000 under the Federal Housing Administration program, Commissioner Raymond M. Foley, recently announced.

Under present regulations of the War Production Board essential repairs can now be made without APB approval if the total cost is not in excess of \$1,000 for one-family houses; \$2,000 for two-family houses; \$3,000 for three-family houses; \$4,000 for four-family houses; and \$5,000 for five-family houses. These limits apply to repair and maintenance work as well as alterations and new construction.

It has been estimated that in the first 12 months after all wartime restrictions can be removed property improvements and repairs probably will amount to about \$3,000,000,000.

HEADLINE NEWS & VIEWS

By E. H. W.

Production of durable goods for civilian economy at present is about \$7,000,000,000 a year. The potential a year from now is \$16,700,000,000 or more than double current production and about 30 per cent more than the 1939 level.

Statistics also indicate that if goods had been available, people would have spent close to \$120,000,000,000 in 1944, whereas they only spent \$98,000,000,000.

The volume of new construction, both private and public, is expected to total slightly more than \$4 billion during 1945 and should increase to about \$5.8 billion next year, provided war production has been substantially reduced by the middle of 1946, according to revised estimates prepared by the Market Analysis Committee of the Producers' Council.

Although the estimate for the current year shows only a slight increase over the amount of new building reported for 1944, the committee's forecast anticipates a rise of 42 per cent in the volume of new private construction, as compared with last year.

The volume of public construction in 1945 is estimated at \$1.8 billion, a decline of 22 per cent from the 1944 total, owing to a probable reduction in the amount of military and naval, industrial, and residential building to be undertaken with government funds. However, the decline in other types of public projects should be offset by an increase of \$130 million in the volume of highway construction.

Every major type of private construction is expected to increase this year, including new private residential building which is estimated at \$700 million as compared with \$499 million last year. This expenditure would permit the building of approximately 165,000 new dwelling units at an average cost of \$4,200, not including the cost of the land.

The volume of new industrial construction in 1945 should amount to \$460 million, against \$234 million in 1944. Farm building is expected to rise from \$170 million last year to \$230 million in 1945, and utility construction this year is estimated at \$620 million, or 16 per cent more than in 1944.

New residential construction is expected to more than double in 1946, with an expenditure of \$1.5 billion, which would mean the building of about 300,000 dwelling units during the year.

Private construction in 1946, other than residential, is estimated at about \$2.3 billion, and the volume of public construction should rise slightly to about \$2 billion."

JOHN A. BLUME, structural engineer, now has offices at 68 Post Street, San Francisco. Telephone SUtter 2673.

The FHA will enter the postwar period ready to back private lending institutions with authority to insure more than \$2,000,000,000 in loans to help families build, buy or improve their homes.

In addition to this \$2,000,000,000, President Truman is, by Act of Congress, empowered to extend to the FHA another billion dollars for home financing.

That the construction industry can and will be the keystone to a prosperous America in the post-war era, is the belief of officials of the Associated General Contractors of America.

Twenty billion dollars annual construction volume, including maintenance and repair, is necessary five years after the war if construction is to contribute its share to national prosperity. This is within the needs of the nation for manufacturing and commercial structures, better homes, new and better highways, airports, railroad lines, public buildings, development of water sources, and thousands of other construction items which add to better living.

That the need for housing for returning service men and for new families formed during the war-time period, when residential construction was held to a minimum, is fully as great as is the need for automobiles, washing machines, and other products which the public has had to do without during the war, is the belief of officials of The Producers' Council, Inc.

As materials and manpower are released from the war production program it is generally conceded that the construction industry will be enabled to start filling the need for new buildings and other facilities, thereby providing employment for construction workers and service men. It is estimated 6,500,000 new housing units will be needed by the end of 1945, while only 160,000 permanent type new dwellings will be constructed this year and only 300,000 units in 1946 unless present restrictions are removed early.

Home building in 13 California cities, Alameda, Berkeley, Fresno, Long Beach, Los Angeles, Oakland, Pasadena, Sacramento, San Diego, San Francisco, San Jose, Stockton, and Vallejo, led 42 regions in the United States last year in point of value and volume.

(See Page 35)

Ingenious Invention Converts Energy In Sun's Rays Into Dynamic Power Units

By EDWIN H. WILDER



Among the many and diversified inventions currently awaiting postwar conversion before going into commercial production, and one which may attract considerable attention in the postwar building and construction field is a photosynthesis generator developed and perfected by Dr. Otto H. Mohr of Middletown, California, internationally

known scientist credited with having invented the principle of the suction cleaner and the so-called indirect method of lighting.

"Photosynthesis" is the same process by which green plants take the energy of the sun's rays and put it into forms that can be utilized by man.

Such a process, however, is extremely compl.

cated and after many years of research and experimentation, Dr. Mohr has devised a simplified, inexpensive process of taking the sun's rays and directly converting them into energy.

The invention, as illustrated here, consists of a series of small, compact units, which are actuated by light rays of the sun. One unit heats an exposed surface of water, another forces vapors from the heated water through a current of electricity generated by the sun's rays thereby converting them into hydrogen and oxygen gases.

These gases are stored in the larger, water sealed expansion tanks and are drawn as needed, providing an unlimited supply of fuel for cooking, lighting, heating and will furnish power for operation of machinery and air conditioning equipment.

According to Dr. Mohr, generation of gas is possible even though the sun rays may be obstructed by fog, or clouds. Adverse weather does not interrupt operation of the plant, and a sufficient quantity of gas may be generated during the day to permit storage for use during nighttime.

Urban and rural areas not served by public utilities, and instances where individual power plants are desired, will be most attracted by this invention.

OPENS OFFICE

Rudolph A. Polley, Architect, has opened offices in the Rowell Building, Fresno, California. He desires the latest manufacturers' catalogues.

SAGA OF DEMING PUMPS

A unique booklet that departs from the traditional "institutional" approach, but instead gives a chronological history of the Deming Pump Company since its founding in 1880, has just been published.

Well illustrated, showing important fields where Deming pumps and water systems are in use and depicting early factories as compared with today's greatly enlarged modern plant, the booklet entitled "Deming Pumps Everywhere" gives the reader a friendly entry into the inside of a large pump manufacturing organization.

The Deming Pump Company is located at Salem, Ohio.

DECORATIVE TRIMS

New color beauty for every interior trim is to be found in the new CHROMEDGE colored aluminum developed by the B & T METALS COMPANY, Columbus 16, Ohio.

Bonded into the metal itself, this postwar product will be available in a choice of colors.

SOME GENISTAS FOR THE GARDEN

By MARDI

The use of common names for botanical varieties leads to many a confusion. Almost any tree that bears a cone is called by some people a "Pine tree." A friend of mine was told that he must be sure to go to Granada while he was in Andalusia and see a beautiful tree in a certain garden there. He was told it was some sort of a pine. He was not interested in pines in particular so he neglected to do so. He later learned that the tree was a *Sequoia sempervirens*, a tree in which he was particularly interested as to its adaptability to southern Spain. The genistas are treated in some such similar manner. Nearly all of them bear yellow flowers and since the common "Spanish Broom" is a genista many people call all genistas "brooms." Here are notes on a few of them.

GENISTA HISPANICA (Spanish Broom). The hardiest, and commonest, of the genistas, a native of Spain along with the *Alfileria* and the lowly foxtail. If allowed to grow wild it becomes leggy but if it is trimmed and shaped it can be made a beautiful shrub, laden with golden bloom.

GENISTA SCOPARIUM (Scotch Broom). Does well in San Francisco Bay regions but seems to find most of southern California a little dry (climatically). It requires plenty of light but not too much heat.

GENISTA MONOSPERMA (Bridal Veil Broom). A white flowered species, reaching its prime in about three or four years when it is a veritable cascade of minute white flowers. It is very hardy but must not be watered too copiously.

GENISTA ANDREANA. With its flowers of brown lipped leaves and yellow above, this French sport is quite the handsomest of the genistas for the garden. They have not done so well in Southern California but should thrive in the San Francisco bay regions in protected places.

GENISTA FRANGRANS (or *racemosa*). Few garden flowering plants can be handled with such freedom as this genista. It can be transplanted readily, even while in bloom; can be easily trimmed and pruned without suffering; needs little water; may be used as a hedge plant; can be shaped as a globe or pyramid and will continue to throw spikes of sulphur yellow flowers if not too roughly treated. If you like sulphur yellow flowers this plant is a treasure. I have seen it used to replace Japanese Boxwood as tubbed specimens with marked success.

There are some 250,000 varieties of plants in the plant kingdom, so if I should omit two or three in this series, forgive me.



Window is easily adjusted so that Baby can play on the floor without danger of draft, while the entire room is adequately ventilated.

These unique windows may be opened to any desired degree, or tightly closed.

A New Window Design for Tomorrow's Ideal Home

Resembling a venetian blind, here is a new type of window which combines modern beauty with the desired element of controlled ventilation plus a maximum of light.

Decorative with any style of architecture the shutters or "louvers" are made of clear, or tinted, plate glass and do not raise up or down, but instead are easily opened or closed by the slight movement of the front, or floating frame.

When the window is open the louvers are horizontal permitting a 90 per cent opening of the window area for maximum ventilation, and when closed the louvers overlap slightly thereby creating a watertight seal that will withstand heavy wind and rain.

Manufactured by the Nu-Air-Wa Company of Los Angeles, California, the windows are made in standard sizes and can be installed in old win-

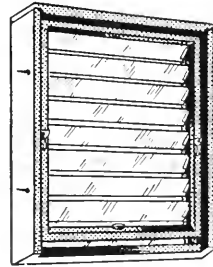

UNIT READY TO INSTALL
1/4 OPEN

dows as well as new homes. Sizes are also available for door use.

They are easily cleaned and do not interfere with regular window screens, and surely represent a postwar innovation to add to your collection of ideas for that home of tomorrow.

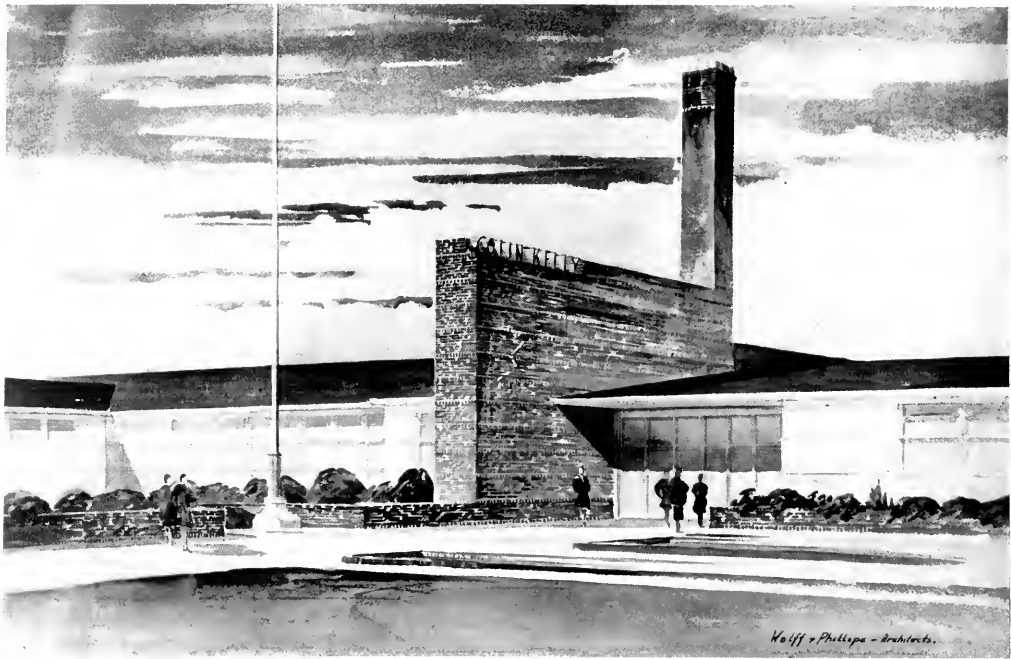

Architect Phillips' sketch of the entrance to the Colin Kelly Junior High School at Eugene, Oregon, which emphasizes residence-type styling.

A Glimpse at the School Plant of the Future

By ARTHUR M. PRIAULX

"What will the school plants of tomorrow be like?"

That puzzler is being asked today wherever school authorities meet, for their's will be the responsibility of spending millions upon millions of dollars for new school plants the nation over. In most cases an honest effort is being made to discover how school districts can get more school per pupil per money invested.

The dream-school-of-the-future for the West Coast certainly will follow many of the features contained in the new and startling Colin Kelly Junior High School at Eugene, Oregon, educators report after a study of the plans for this unusual structure. Since first plans were released by architects Wolf and Phillips, of Portland, late this sum-

mer, northwest educational leaders have besieged both the architects and Eugene's City Superintendent Dr. Henry M. Gunn for more details.

In designing this unique school-of-tomorrow Architect Truman Phillips and Dr. Henry M. Gunn worked very closely together, both contributing from their experiences. Phillips has designed many of the northwest's most interesting school structures and Dr. Gunn was assistant city superintendent at Portland before assuming leadership of the Eugene system two years ago, and is recognized as one of the more progressive younger educators in the northwest.

The \$335,000 Colin Kelly Junior High School embodies the most modern concepts of safety, convenience, usability, utility and structural beauty.

This educational building which stands in the rapidly growing suburban area adjacent to the city on the north is as daring as the young homes which school children of that section selected democratically by ballot.

Located amidst a setting of modern residences, all built within the past few years, the new school is a spreading, single-story, all-wood structure which will conform to the community's homes and become a part of city planning.

"The trend in American school planning," says Dr. Gunn, "is to get off the highways and away from crowded, heavily travelled thoroughfares. We purchased twenty acres for the Colin Kelly unit about three-fourths of a mile off the highway bisecting this residential section. We have eliminated traffic hazards and dangers at once in this selection."

"With this large block of relatively inexpensive land we were able to design a spreading structure of wood which blends beautifully with neighboring homes," Mr. Phillips pointed out. "There is nothing foreboding about this school, which becomes a welcome and integral part of the surrounding residences, which is in sharp contrast to pretentious, multi-storied structures of steel and cement which never seem to be a part of the community.

"It is apparent at once after a close study of

the Colin Kelly plan that we have achieved a plan of high quality of which the homely and practical side and has a warmth and beauty similar to that obtained from a well designed home." Phillips continued in discussing the general aspects of the plan. "There are other advantages, too, in this type of spread-out, single-storied school. This type of building is very flexible, easily enlarged, and added to when the growth of the region requires an important point in most modern communities which have shown a steady growth in late years. We are using wood, which fits well into our great timbered northwest, and making use of materials for construction which are native to our region here in Oregon, Washington and California."

Since modern teaching is to teach by doing, the basic principle governing the design of this school is to make the structure a tool to aid in teaching. The monumental school building has no place in such a plan, Dr. Gunn pointed out.

"There are so many new innovations in Colin Kelly it would be rather difficult to single any one of them out as the most outstanding," the Eugene superintendent went on. "However, if you will study the floor plan, you will grasp what we have done to the old-fashioned class room. A part of each of our ten class rooms is an adjoining conference room, where a progressive-minded instructor will find that privacy they have always

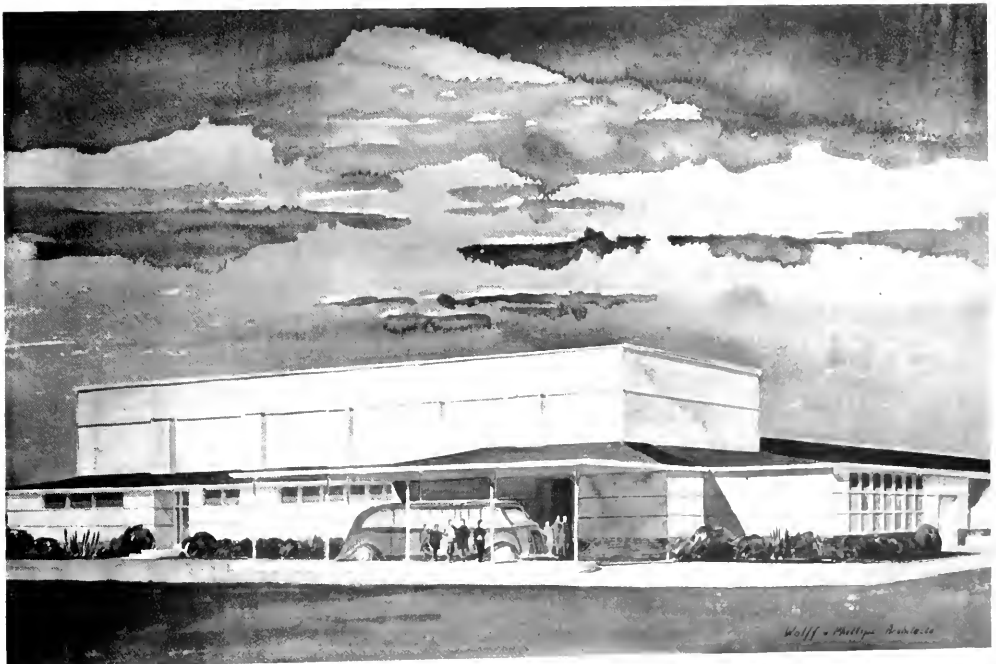

Here is artist's drawing of the rear entrance of the school where busses will disembark their 350 student passengers under a canopy, away from the weather.

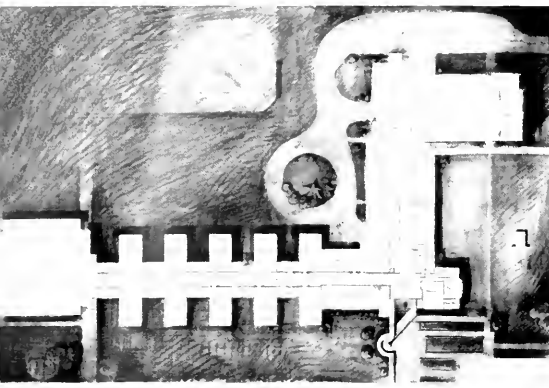

or plan of new school structure which shows many of the features it have attracted interest of school authorities in the northwest.

wanted. A small room for conferences and counseling, and one where students can work on special projects and activities, but one definitely not intended as a "dunce room."

The almost perfectly-lighted classrooms, with three sides in windows, is another departure in design which the superintendent likes. He pointed out that since much of modern teaching is conducted more or less informally around conference tables, or at least since seating arrangement has progressed a pace from the rigid rows of seats, more light is essential. With these well-lighted classrooms students get maximum light on their work from three directions, eye strain is virtually eliminated and work becomes more pleasurable and easy.

Blackboards are placed on only one wall, that backing against the corridor, which conforms to the trend away from blackboard use. The intent

in designing this type of classroom is to create as flexible a teaching unit as possible which can be readily adapted to almost any type of teaching methods. The keynote throughout the building is more light, both natural and artificial, finest possible ventilation and adequate heat to insure maximum health of students and faculty.

The matter of safety has been given particular study by both architect and school planners. No student will ever be more than 150 feet from an outside exit and, of course, with a building of one story, safety from fire should never be a problem. Hallways are wide enough to allow quick passage of the entire student body of 350 students in a matter of seconds. Incidentally, while the present school population in the Colin Kelly area totals 350, the school is being built to accommodate up to 450 pupils without crowding.

Facilities for student activities, apart from the regular curriculum, have become a vital part of this new building. At the end of one wing a fully-equipped boys' gymnasium and basketball court has been provided to allow a well-rounded out physical conditioning program during the entire school year. At the other wing end the girl students have similar facilities and their own gymnasium with the added attraction of a standard-size stage.

The large space reserved for a cafeteria doubles in brass as a band room and the adjoining kitchen serves as a separate teachers' dining room. And right next to the modern administrative offices is a well equipped nurse's suite where several students can be cared for at once.

Then turning to the more conventional school rooms which nearly every present-day school affords, will be large classrooms for homemaking

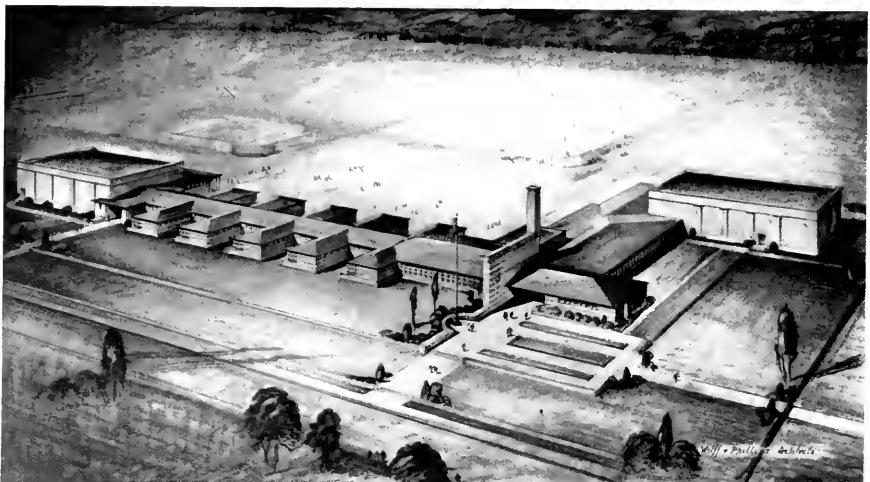

JUNIOR HIGH SCHOOL EUGENE ORE

ARCHITECT AND ENGINEER

for girls and industrial art for boys. Each classroom has library facilities, plenty of boys' and girls' study rooms, with special ones for both men and women teachers, and centrally located to provide maximum efficiency is an ultra-modern heating unit and space for fuel storage.

Not the least of the many advantages of the trend forecast by the Colin Kelly design is the matter of economy to the tax-paying public. This all-wood school would cost approximately fifty per cent more if constructed of hard materials, stone, cement or steel, or somewhere in the neighborhood of \$450,000.

The curse of obsolescence is likewise avoided, for a school district can set up a pay-as-you-go budget plan to take care of changes and enlargement of facilities. The life of this building is standard for public buildings, Phillips points out, but historically the changes have been so revolutionary within a span of 25 to 30 years in the past that school plants built two-, three- and even four-stories high become obsolete and sometimes unusable, and certainly much less flexible and less amenable to adjustment to meet these changes than this compact, single-story building.

School districts of the future who follow this type of educational plant design, will, believes the Eugene school man, avoid costly, long-range bond issues required in buildings having a greater initial cost. "I believe we can get more school plant per pupil for the amount invested in Colin Kelly than ever attained in the past," Gunn stated. "If conditions required it, we could completely re-design this building within five years without a great deal of loss, something not conceivable in other type buildings. This school is being built in a district which will most certainly greatly increase in population within the next few years, and we can add to this building similar units to the one being built now, and retain the original beauty and utility of the structure and it will not look like a patch-work quilt."

Of particular interest to western school districts is this school-of-the-future where land values still permit the acquisition of ample ground space to build the spreading, home-like Colin Kelly-type building. In cities where land costs are high, the matter of floor space on the ground floor is still a problem, and then it becomes necessary to go up in the air, but we should design our schools, the superintendent pointed out, to take advantage of the ground space out here where there is still available many fine school sites close to most of our heavily populated areas.

From a construction standpoint the school will

be no more difficult to build than a one-story plant. With everything on one floor, each classroom, in effect, a small house, without interior partitions. Walls will be of conventional construction and light trussed members will support the roof. Even the plan has been laid out in a 4-foot modular. Alterations at a future date will be simple, and the use of this module will likewise simplify original construction, serving to keep costs down.

Construction work on this unusual school may start sometime in September and is intended to be ready for use before the school year thereafter is completed.

HOME LIGHTING PRACTICE

The first official Recommended Practice of Home Lighting has been released by the Illuminating Engineering Society. The report, developed and prepared by the Society's Committee on Residence Lighting, will be available soon as a separate 40-page 6 x 9 illustrated booklet, with cover.

The I. E. S. Recommended Practice of Home Lighting constitutes an authoritative guide for the lighting of all of the major rooms and various seeing tasks in the home. Its recommendations are based on the findings of home lighting specialists of many years' experience and represent the most comprehensive and official study of this subject heretofore published. In addition to the fundamentals of adequate lighting, the report covers such subjects as color and its relation to light, fluorescent and filament sources in the home, built-in lighting, placement of lamps, and includes also a table of footcandle recommendations for numerous seeing tasks in the home.

Each room in the home is studied separately and specific recommendations made for its lighting, including drawings of suggested light-fixture types. Thirty-six illustrations included in the booklet graphically demonstrate the beauty and excellent seeing conditions achieved by the lighting recommendations presented.

CONSULTING ENGINEERS

The DYSART ENGINEERING CO., a newly organized firm of consulting, designing and construction engineers, with staff specialists in every major engineering field, have opened offices in the Syndicate Building, 1440 Broadway, Oakland, California.

Ronald R. Dysart, who heads the firm, is a professional member of the American Institute for Electrical Engineers.

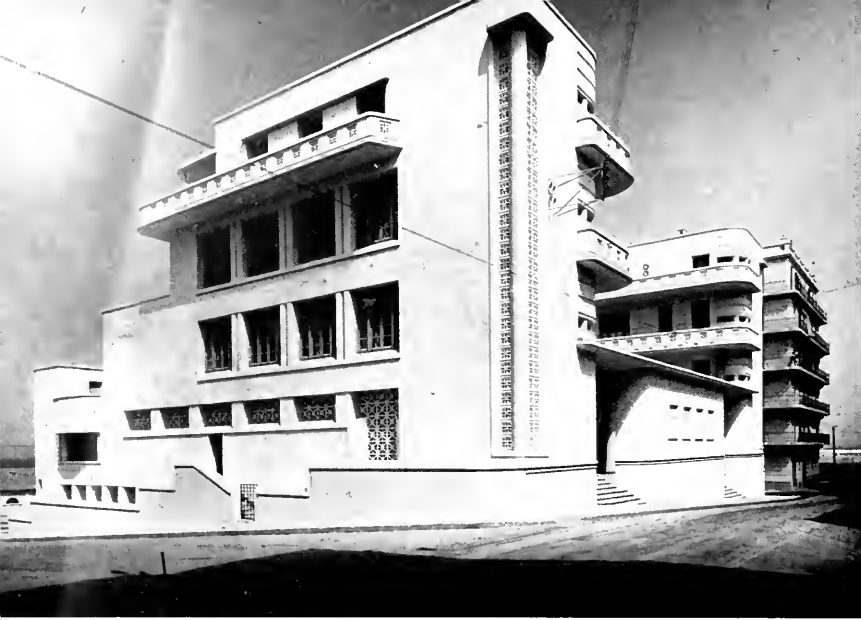

GRAMMAR SCHOOL IN ALGIERS

X. Salvador, Architect

Pre-cast concrete grilles are used for shade, privacy and protection on the first floor, for decoration in balconies and stair wells, while the windows are provided with rolling-wood blinds.

Photo by H. Eichacker

ARCHITECTURE IN NORTH AFRICA

By J. WELLS HASTINGS

Many influences form the background of architecture in North Africa. To understand a country or an area it is necessary to trace its development through its history.

Phoenecian galleys brought men to establish a colony on the shores of Tunisia. They built Carthage, which grew in power as their armies spread along the coast. The small and scattered native tribes could give but little resistance to the Carthaginian steamroller as it crushed all resistance along the Mediterranean from what is now Tunis to Tangier. Roman legions needed grain and overcame the Carthaginians. Temples and villas replaced crude mud and stone dwellings. Huge aqueducts brought water to the grain fields and newly planted forests.



Typical Modern Moroccan Architecture is the Customs House at Mazagan, Morocco.

Photo by E. Starck

Peace lasted until the fire of Allah swept the country from Arabia to Spain. The nomads adopted the Roman plan of dwelling rooms surrounding an arcaded courtyard. Blank exterior walls, perforated only with an arched doorway and small openings for cross ventilation shut out the heat, noise and filth of the street.

Then the Ottomans gained in strength until they dominated the once powerful Arab empire. The great difference between these two was that the Arabs settled in the lands they conquered; the Turks only sent rulers to collect tribute from the colonies, holding those under them in subjugation by their Janizaries, or "pirate soldiers." They closed their eyes to piracy on the seas (some even promoted it), and it was against piracy that the American marines fought in Tripoli and against which the French fought in Algeria in 1830. The French also wanted to hold North Africa for its supply of grain. This is still true today.



Concrete and hollow tile constructed Girls' School of Maison Carree, Algeria. *Eduard Lowe, Architect*



NO. 244. RABAT. LA RÉSIDENCE GÉNÉRALE (FAÇADE)

Residence of the Governor General of Morocco at Rabat—note the cast grilles and rolling-wood blinds at the left and center, ground floor. The roof is of green glazed tile, while the base is formed of faïence mosaic. The two odd shaped blocks by the garden steps are old Moorish column caps. All details of this building are typically Moroccan.



General Post Office at Mazagan, Morocco.

Photo by E. Starck

Even in detailing, these diversified influences are found. For example: Christians were captured by the Barbary Pirates and sold into slavery. It is said that some of these, who were Dutch, taught the natives how to glaze tile. Even now in the old Kasbah Palace of Algiers one can find a Delft blue windmill or garden scene on a piece of tile here and there in a wall surface covered with Mohammedan tile of geometric design. The Moroccans combined the idea of Roman mosaics with glazed tile to make their faience mosaics. In modern buildings colored cement tile is used on floors, glazed tile for baseboards, wainscots and decorative panels.

The Arabic wood grilles for exterior windows are now replaced with precast cement grilles; cement visors take the place of slate formerly used. The arch is used extensively both in native and French architecture. A certain amount of symmetry is used in decoration, but rarely in general masses. Mohammedans will purposely vary a symmetrical design in some manner to show their belief that "Allah alone is perfect."

. VILLA "CANNES".

3 PIECES : L.R., 2 CH.
 PORCHE COUVERTE.
 HALL.
 CUISINE - BUANDERIE.
 SALLE DE BAINS.
 W.C. INDEPENDANT.
 QD. DEBARRAS.
 PLACARDS POUR CUIS ET CHAQUE CH.
 VERANDA.
SURFACES:
 SURF. CONSTRUITE :
 PORCHE ET VERANDA :
TOTAL — :

NOTA: LE PROPRIETAIRE PEUT ÊTRE ASSURÉ QU'AUUCUNE VILLA N'EST SEMBLABLE AUX AUTRES. J.H.

(. COTE JARDIN.)

(- CÔTÉ RUE -)

Plan.

ALGER, 1935, L'ARCHITECTE D.I.E.S.A. : Jean 1937/1943

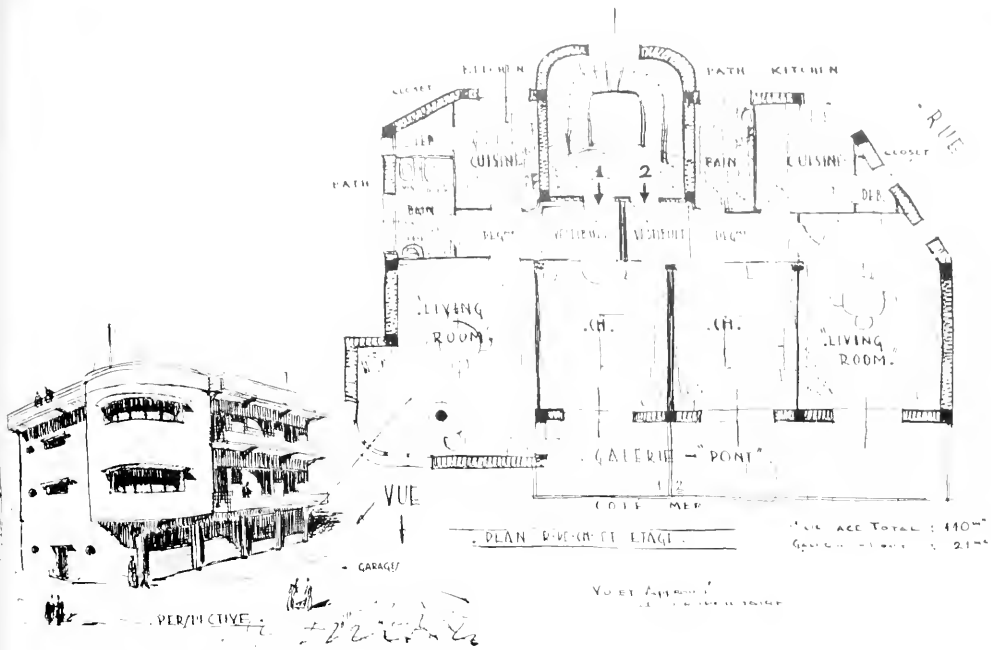

FOUR-FAMILY FLATS BUILT AT POINT PESCADE, ALGERIA

J. W. Hastings, Designer

Slope of ground permits garages in basement. Laundry is on the roof deck. The balconies give unobstructed view of the sea, and provide outside dining area. A baffle separates the balcony on each floor, thus affording privacy for each family. Wardrobes are used instead of closets in bedrooms.

Construction of the building is reinforced concrete and hollow tile. Rolling wood blinds for windows, compressed cement tile floors, and tile roof deck.



Moorish Capital

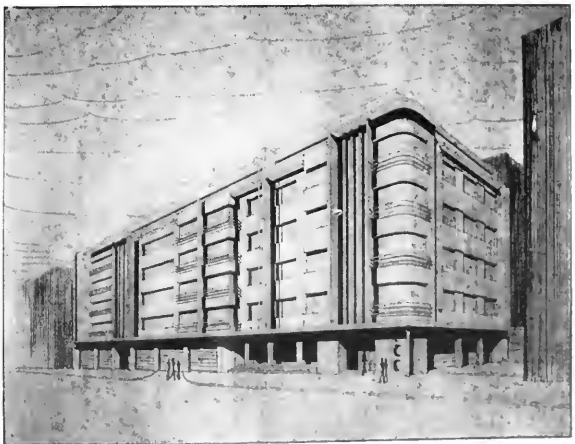

Right—
Stores and Garages on the first floor feature this Apartment House project in Algiers.
Rene Luga, Architect and Engineer



Department Store Project in Algiers. The building is of concrete with exterior in heat resisting glass.

Rene Lujan, Architect and Engineer

Climate and native architecture are not the only influences on present design. The others are the obvious: new types of construction, functional design and the desire to break away from the past. Masonry bearing walls, wood trusses and tile roofs are still used to some extent, but most buildings are now made of a steel or concrete frame with hollow tile floors and walls. Interior partitions are of 2-inch hollow tile, plastered each side. Concrete visors protect openings from the mid-day sun, rolling or folding slatted blinds of wood or steel are used for protection against sun in the day and intruders at night. Ground floor windows are usually barred for protection. Windows are of the French door type or casement. A few double hung steel sash are used, otherwise windows are of wood. Roofs are usually flat, finished in terra cotta tile. Some are of tar and gravel, built up roofing, or cement. Celotex, Thermax and earth are used for insulation. Stairs have marble or terrazzo treads and risers supported by a hollow tile arch with cement rubble fill.

Prefabricated wood cabins have been made, but "prefab" houses were not considered substantial enough for permanent use. Precast cement slabs and grilles have been used extensively. Stock doors were obtainable in 1931, stock steel sash in 1934, but no stock wood windows were made in 1935 so far as I know. Kitchen cabinets were unheard of at that time, nor were there any prefabricated sink tops.

Ribless concrete domes are used to span up to a hundred feet square. Their thickness varies from three feet at the top to five feet at the bottom, their

AVENUE DE FRANCE IN FEZ, MOROCCO

Photo by Chambon



Note: Even in 1930, when this picture was taken, city planning was being carried out in three dimensions throughout Morocco. The "Ville Nouvelle" or "New City" of Fez was built completely separated from the old Moorish city, thus Europeans and natives continued to live their own lives without friction. Business is carried on in both sections of town, but each section retains its individual character. Henri Prost is the City Planner.

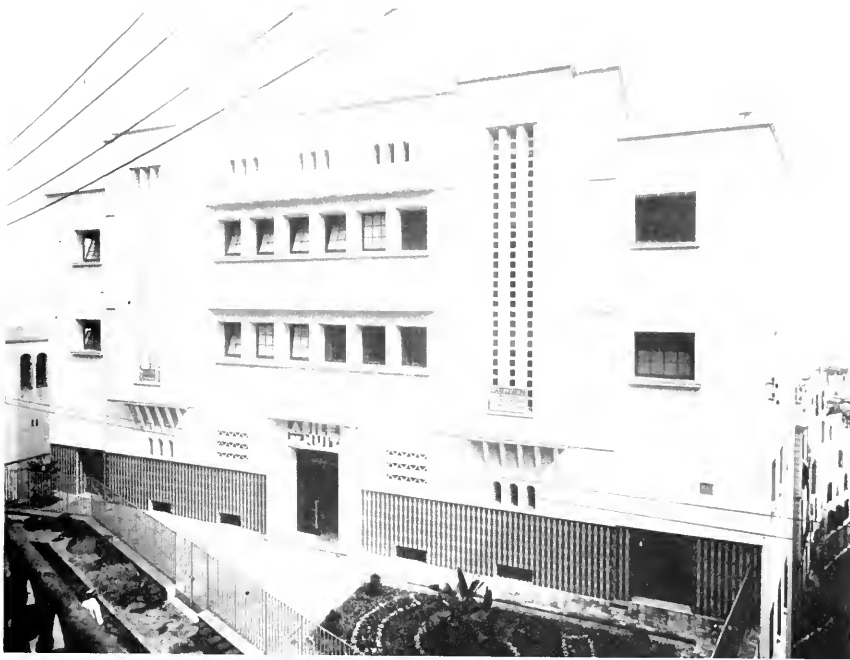

"ASILE DE NUIT"—"The Night Shelter," Algiers

This building of typical Algerian architecture serves as a dormitory for anyone having no place to sleep. Those who can pay a few cents a night, or it is free to those who have no funds.

The treatment of stairways on the exterior is an adaptation of native construction, concrete brackets taking the place of eucalyptus poles. The base wainscot is in blue green and yellow glazed tile. The dormitory is on the edge of the native district and is owned by the city of Algiers. Albert Seiller & M. Lathuillier, Architects. Photo by La Photo Industrielle.

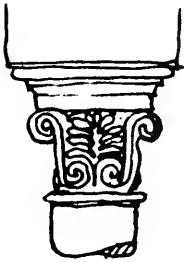

**Arabic
Capital**

**Right—
Bank Building of the Compagnie Algerienne,
Place de France, Casablanca, Morocco.**

Photo by Gillot



Algerian Apartment House by Rene Lugan, Architect and Egnieeer. All apartments in North Africa have balconies or loggias.

Photo by M. de Louvencourt

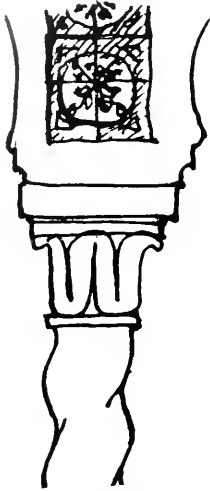

Arabic Capital and Column

strength depending on shape and diagonal reinforcing. Since labor is cheap and materials are expensive compared to construction in the United States, French engineers and architects design for the lightest structures possible. Their concrete formwork is often more complicated than ours, but the results are interesting because character of stresses is clearly defined.

City and Regional planning has been in progress for years throughout all North Africa. Most Moroccan cities are divided into two sections, "Native" and "European." This seems to be the most successful solution. For instance in Algiers (See Page 33)



Defence Windows—Tunis

• VETERANS' MEMORIAL •
 • CIVIC AUDITORIUM • BLDG •
 • SAN DIEGO, CALIFORNIA •
 • JOHN S. SIEBERT, A.I.A. •
 ARCHITECT •
 • SAM W. HAMILL, A.I.A. •
 ASSOCIATE ARCHITECT •

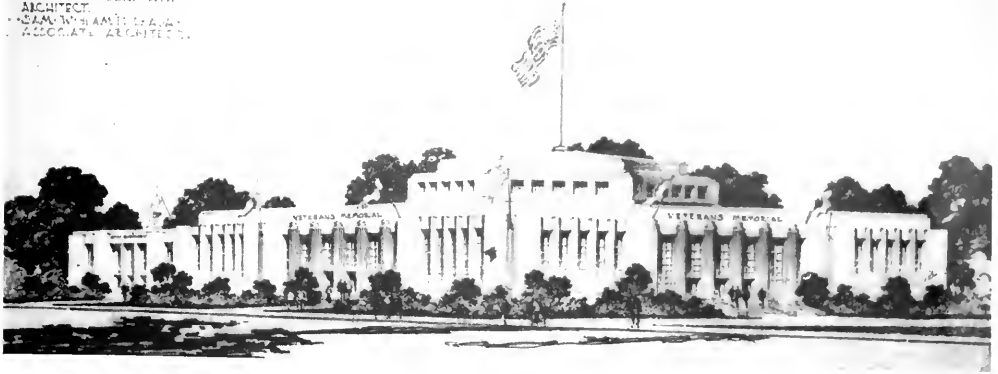

Proposed Veterans' Memorial, Civic Auditorium and Convention Hall for San Diego

By JOHN S. SIEBERT, A.I.A.

The development of this project has entailed some twenty years of patient, painstaking study (involving five different sites), bridging the periods of two world wars. Many meetings have been held with numerous groups having, what appeared at first sight, needs and wants so varying as to be almost impossible of harmony. When one stops to consider that there are about fifty

different posts of war veterans in San Diego County, it would seem an achievement of note to have them finally give unanimous official endorsement to this layout.

A glance at the drawings will show a unique feature, namely, a large central memorial, or trophy, hall through which ready access is had to all parts of the building. This octagonal space (about 100 feet across) extends through two stories and a clerestory and is roofed partly with glass. Entry to this space will be through foyers from each side of the building. All the various features of the entire building are grouped around and are readily accessible from this central space.

ANOTHER PRACTICAL WAR MEMORIAL

The mayor of San Francisco has appointed a committee to investigate and draw up proposals for a suitable war memorial to be built by the city. They must run the gamut of wading ponds, fish pools, marble statues, steel effigies, totem poles and fountains spouting hot and cold clam chowder. What conclusions may be arrived at only time will tell but it is hoped that the well considered plan of a Civic Auditorium, as approved by the veterans of San Diego County, after years of careful study, and designed by John S. Siebert, A.I.A., and Sam W. Hamill, A.I.A., associated architects, will have a wholesome effect on their deliberations.

On the main floor will be various offices, including a veterans' information bureau, a lounge and two meeting halls. On the ground floor, below will be a banquet room to seat about 300, a kitchen, two lodge rooms (about 50 feet by 60 feet), each with its ante room, buffet kitchen, small dining room, and the necessary toilets.

Each ante room will be provided with sufficiently large lockers to store the colors and miscellaneous

Editor.

materials for each post, using that particular lodge room.

The second floor provides four lodge rooms or meeting halls, each about 50 feet by 60 feet, with the same facilities as on the first floor.

Adjoining the main building on one side will be the auditorium seating 2500. Adjoining the main building on the other side will be a Convention Hall to seat 10,000 people. Ample committee rooms, regular stage, toilets and safety exits are provided.

The building site slopes sufficiently to permit a ground floor in which the windows will be practically clear of the ground. Under the Convention Hall, in this ground floor area will be bowling alleys, billiards and pool rooms, a large dining room, the heating and ventilating apparatus and storage rooms.

Entry to the first floor or to the ground floor is by steps and ramp and to second floor by stairs and two automatic elevators. Veterans using wheel chairs will therefore find it easy to go into and to any part of the building, including the auditorium.

Loud speakers and acoustical treatment for walls and ceilings will be installed.

The construction throughout will be that of a Class A building. Over all dimensions about 400 by 600 feet and the estimated cost, without furnishings, about four million dollars; to be defrayed in part by a levy of not exceeding 3 mills per dollar in any one year on the total assessed valuation of San Diego County (as provided by State law) and in part by federal and state funds.

NEW OFFICERS NAMED

N. J. Clarke has been elected senior vice president and J. M. Schlendorf named vice president in charge of sales of the Republic Steel Corporation, according to a recent announcement by Company officials.

Clarke has been a vice president in charge of sales since 1930, while Schlendorf has been serving as assistant vice president in charge of sales since 1936.

HOLMES AND NARVER, engineers, have moved from 639 South Spring Street, Los Angeles, to 626 South Spring Street in the same city.

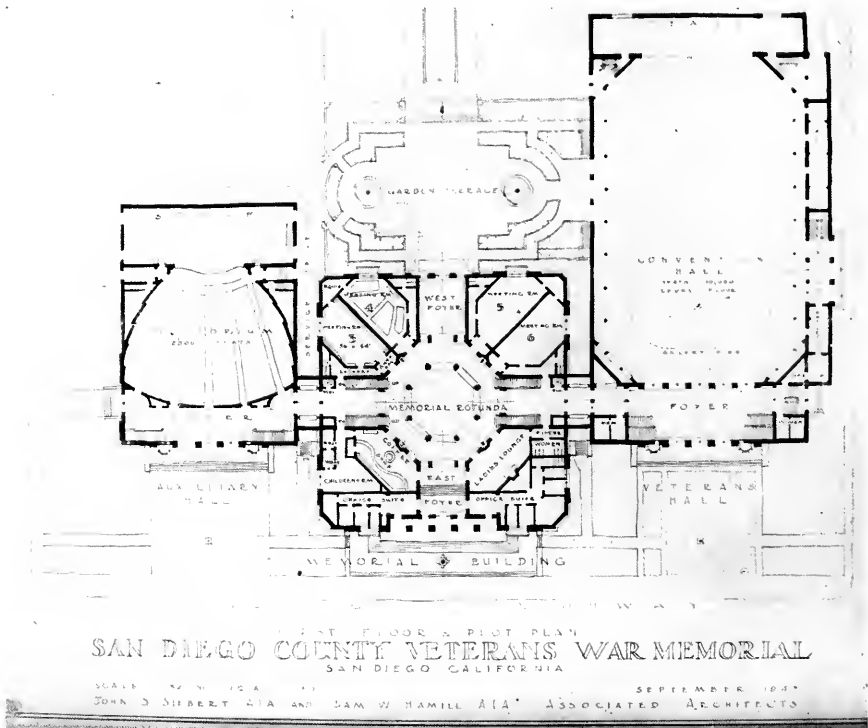

Photo by Herbert R. Fitch

A. I. A. ACTIVITIES



The Bulletin of the Northern Chapter of the American Institute of Architects is out, a little reduced in pages, but still of a quality and character that must be the envy of many a small publication. On the front page is a lengthy quotation from Lewis Mumford's recent book entitled, "The Condition of Man." It is not of a character that is designed exclusively for architects yet they, as well as all thinking men, should read and remember it.

The chapter's custom of publishing the latest list of membership is resumed, thank heaven, for that list is sorely needed in times when the only one available is far out of date.

A new innovation is the introduction of a very few and brief book reviews. This seems to be in line with the Bulletin's plan to make their publication more generally informative to the members of the chapter than merely a recording of chapter happenings; with which most members are heartily in accord. Notes of importance, such as Andrew T. Hass' appointment to a membership on the Government Relations Committee of the Institute are still recorded, as is the announcement that Colonel Charles Masten has reopened offices with James R. Mitchell, architect, at 407 Sansome Street, San Francisco.

The Southern California Chapter Bulletin for September reports the August meeting of the chapter was held in the Architecture Building of the University of Southern California and was highlighted by remarks of Dean Arthur Gallion and Professor Clayton Baldwin.

Paul R. Hunter reported at length on his trip to the Pacific Northwest and his inspection of plywood plants there and his conclusions with respect to the great value and usability of the commodity. The bulletin also announces that the Southern Chapter is working closely with the Association of General Contractors in the establishment of rules of ethical procedure.

The September bulletin of the Washington State Chapter of the A.I.A. contained the announcement that the next Chapter meeting will be held Thursday, September 13, 1945, in the Mirror Room of New Washington Hotel, Seattle. Refreshments, followed by dinner at 6:15.

There were other statements, but they are a little late for this issue. The announcement (See Page 32)



What's Coming from **UTILITY?**

In present appliances and new products to be introduced, the **UTILITY** Trade Mark will be your assurance of proven, dependable equipment for air cooling, ventilating and heating... in residential, commercial and industrial buildings. These appliances include the best features of modern design and construction... produced in assembly-line plants.



UTILITY APPLIANCE CORP.

Formerly Utility Fan Corporation

4851 S. Alameda • Los Angeles 11, Cal.

Manufacturers of the famous Utility Evaporative Air Coolers (the original Dezerit Kooler), Fans, Blowers, Floor Furnaces, Forced Air Furnaces and Fan-Equipped Space Heaters (console type)

WITH THE ENGINEERS

Again the Structural Engineers of Northern California have pulled a ten strike at one of their monthly meetings. They seem to have the happy faculty of doing just that, nearly every time they meet. Their meeting the other day was a sort of a double header. In the afternoon they visited the testing laboratories at the University of California in Berkeley, where they watched the workings of the department's testing methods, after which they convened at the Claremont Hotel for dinner, where Professor L. B. Loeb was the guest of honor and the speaker of the evening.

Professor Loeb's discussion was on the subject of "Atom Smashing" and its relation to the atomic bomb. His talk was most enlightening and more than timely. His description of the manner in which the reaction between the electrons and neutrons took place cleared to a remarkable extent the various misconceptions of what takes place upon the explosion of the bomb, and also laid to rest many of the dreams of free power for everyone by Tuesday at one o'clock. He stated that the report of a locomotive which is soon to be run from New York to San Francisco and back using only atomic power is, in the language of the benighted, plain "bunk."

Undoubtedly, and despite the thought that we are about to enter into the millenium of untold wealth at no cost, our dreams received a severe jolt, but the choice of the subject and the authority of the speaker were a ten strike. Such events are coming with increasing enthusiasm at the meetings of the Structural Engineers Society of Northern California. At this meeting there were 52 members and 94 guests, a record that is undoubtedly due to the energy and foresight of President "Buzz" White.

A.I.A. ACTIVITIES

(From Page 31)

of the September meeting, however, contains an air of rejuvenated freedom that justifies a repetition. Other chapters might well leaven the weighty matter with which they fill their bulletins without losing the value of their knowledge.

First postwar meeting will be informal in order to relax minds wrestling with reconversion. No problems, no priorities, no prohibitions. Major purpose will be: 1. to get acquainted with new members; 2. to see how long one keg of beer will last, and 3. to explore musical talents of the Chapter. All members possessing musical instruments and a suppressed desire to toot, twang, or tinkle are

encouraged to bring them along and give vent. (Note: This encouragement does not apply to baritones yearning to sing "On the Road to Mandalay" who will be regarded unfavorably.)

The September meeting of the Northern California Chapter of the A.I.A. was held on the night of the 14th at the Claremont Hotel in Berkeley.



Front Row: John Bolles, Andrew Hass, Walter Mathews, John Donovan. Standing: Fogar A. Mathews, Wm. Mooser, J. Frances Ward, Ernest Krump (left to right).

The guests of honor were Walter Mathews, 95, and his young brother Edgar A. Mathews, 83. Architect Walter Mathews is, so far as we know, the oldest living architect in the United States. Both Walter Mathews, who was introduced by John J. Donovan, and Edgar Mathews, who was introduced by William Mooser, gave interesting accounts of the development of the practice of architecture in the Bay area. Being the sons of an architect, and both being born in Oakland, they have had the opportunity of watching the developments in the building industry for practically their entire lives.

The Chapter meeting was devoted to subjects based upon the ethics of the profession. It was interesting to note that at times the older men were more progressive in their ideas than were the newer practitioners.

WESTINGHOUSE EXPANDS

The B. F. Sturtevant Company of Boston, Mass., pioneers in the design and manufacture of air handling and processing equipment, has been acquired by the Westinghouse Electric Corporation.

The Sturtevant Company's products cover a wide range in the fan and blower field, heating, cooling and air conditioning apparatus, including application and design of complete air handling and processing for industry.

Headquarters will continue to be in Boston, additional plants being located in Camden, N. J.; La Salle, Ill.; Berkeley, California, and Galt, Ontario.

ARCHITECTURE IN NORTH AFRICA

(From Page 28)

there are no racial restrictions, yet very few Arabs or Europeans buy property outside of their own districts because Mohammedans like one type of living and the Europeans like their own. Henri Prost, Maurice Rotival (now with the U. S. Navy and professor at Yale), Raymond Coqueral and Charles Montaland have each worked extensively on urban and regional plans.

North Africans expect buildings to be interesting. In other words buildings are considered a combination of engineering and art, so blended as

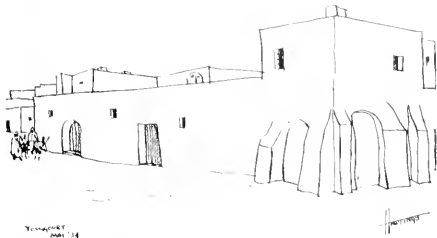

Native Architecture, Oasis of Touggourt, Sahara Desert, Algeria.

to create a certain emotion or feeling in those that have to use them and look at them. "Obvious" you may say, but how many clients here consider anything aside from cost and return?

Summing up then: Algeria has been a French colony for over a hundred years, then Tunis and Morocco came under French authority, yet compared to France they are young. Their architects have not only developed a functional architecture adapted to their climate and living conditions but also have had the courage to use their imagination in creating buildings that have character, strength and rhythm.

KAWNEER'S NEW VICE-PRESIDENT

Luther H. Atkinson of Union, New Jersey, has been appointed vice-president and director of sales for the Store-Front Division of the Kawneer Company of Niles, Michigan.

He will head marketing activities of the company's postwar program in store-front products, including architectural metals, entrance doors, signs, lettering and interior metal finishes which are now marketed through building material firms.

Manufacturing plants are located at Niles, Michigan, and Berkeley, California, with a new plant going in at Lexington, Kentucky.



IT'S ZONE-CONDITIONED

Residence of Mr. and Mrs. Karl R. Levy
Westwood Hills, California
Architect — Allen Ward
Builders — Pollock & Brown

PAYNEHEAT
OVER 30 YEARS OF LEADERSHIP

**GAS FUEL
HAS
EVERYTHING**

This house has *four furnaces* . . . not bulky, heavy heating plants, but compact, streamlined PAYNE units. Each is separately controlled, enabling the owners to vary their "indoor climate" as desired, by "zones," according to need and weather. ★ That's the *modern* conception of heating and ventilation, as pioneered by PAYNE . . . the modern successor to old-fashioned central heating . . . PAYNE ZONE-CONDITIONING. Write for descriptive booklet.

PAYNE FURNACE COMPANY
(One of the DRESSER Industries)
BEVERLY HILLS, CALIFORNIA

FASHION BUILDING

(From Page 14)

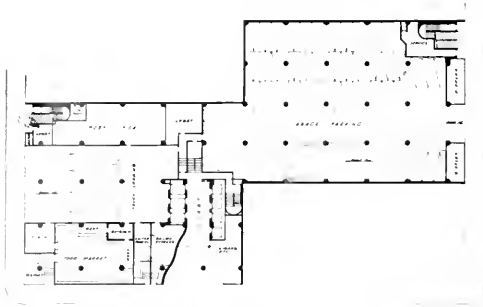

Textile Building, Basement Floor Plan

cial buildings. The Architects were requested to create within the building a "complete garment industry city," providing efficient production flows for the manufacture of garments, large day-lighted areas for display to the buyers, centrally located convenient shipping facilities for the completed

products, and a cheerful atmosphere for employees.

The building, approximately 30,000 square feet in area, has been designed to the maximum size permitted by the building ordinance of the City of Los Angeles; 150 feet in height from the street

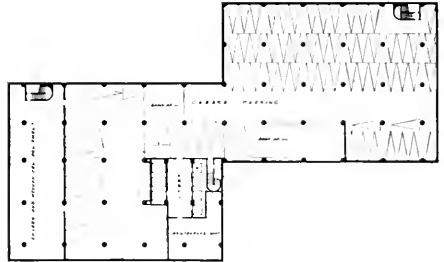

Sub-Basement Floor Plan

to the top floor ceiling and thirteen stories. Two additional basement floors have been provided for shipping facilities and garage parking of tenants' cars. To provide maximum daylight areas for display, the three street fronts have been designed in continuous glass. Interior property line walls are to be constructed of 12-inch square blocks pre-cast in 48-inch square concrete units. The units are designed to be installed as individual masonry

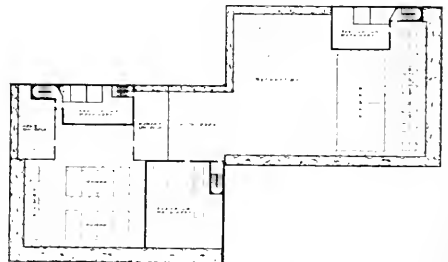

Roof Plan of Textile Building

units. This method has been employed to provide the maximum amount of light through these interior property line walls. (The Los Angeles ordinance permits only 25 per cent of these wall areas in glass.) The building is designed as a reinforced concrete, flat slab, structure.

To obtain maximum production efficiency, all manufacturing areas are provided with complete (See Page 40)

BAXCO
CHROMATED ZINC CHLORIDE

CZC

PRESSURE TREATED LUMBER
● **PROTECTS AGAINST DECAY AND TERMITE ATTACK**

Specify it in your home
Available through Lumber Dealers

LOS ANGELES 601 W. 5th Street Phone Michigan 6294	SAN FRANCISCO 333 Montgomery Street Phone DOugles 3883
---	--

J. H. Baxter & Co.

AGENTS FOR WEST COAST WOOD PRESERVING CO. SEATTLE, WASH

HEADLINE NEWS & VIEWS

(From Page 13)

Volume of new home construction in the country since Pearl Harbor has declined 31.2 per cent from that of the three prewar years, the Bureau of Industrial Service, New York, reports.

The first electric ranges to come off the Edison General Electric (HOTPOINT) Appliance Company's assembly lines since April, 1942, will hardly meet dealer demands for displays.

It will be well into 1946 before any large scale range production is under way and the public will be able to buy electric ranges readily, company officials report.

Public and private construction during the 5-year period beginning with 1947 is expected to reach a volume of more than \$70 billion, according to a revised forecast of the Producers' Council.

A \$10 billion expenditure in 1947 will be followed by \$14.4 billion in 1948, and an average of \$15.3 billion in the three years 1949-51.

It is estimated new residential construction will account for 56 per cent of the private building during the years 1949-51; farm construction 5 per cent, industrial building 5 per cent, utility construction 13 per cent, and commercial building and other community facilities 21 per cent.

NEW VICE PRESIDENT

William E. "Bill" Zipp has been appointed vice president in charge of sales for the manufacturing division of Ceco Steel Products Corporation, with headquarters in the division's plant at Cicero, Ill.



WILLIAM E. ZIPP

Mr. Zipp was manager of sales for Ceco's manufacturing division from June 1944 until his new appointment. He joined Ceco in 1933 to inaugurate the steel window division. Previously, he had wide experience in architectural construction and window fields.

He is a member of the Builders Club of Chicago and the Optimists Club.

His residence is at 1024 North Oak Park avenue, Oak Park, Ill. He was born and educated in St. Louis and is married to Helen Hunicke Zipp, formerly of St. Louis.

THE MEASURE OF A HOME

The degree to which homes of tomorrow can be truly modern will be measured by the convenient, satisfactory operation of their electrical facilities.

Before you complete plans and specifications for new homes, be sure that nothing has been omitted from the wiring plans. Make certain they are adequate for tomorrow and ten years beyond tomorrow.

Are there plenty of convenience outlets, plenty of light switches properly located, wires that are large enough to supply all the appliances that will be used during the life of the house?

Adequate wiring costs so little and means so much to the future comfort of your clients . . . as well as to the resale or rental value of the house itself. It is truly the "measure" of the liveability of any home.

Don't handicap homes of the future with wiring of the past. Insist on completely adequate wiring in every home you plan.



NORTHERN CALIFORNIA
ELECTRICAL BUREAU

1355 Market Street
San Francisco 3



SISALKRAFT

REG. U. S. PAT. OFF.

"More than a building paper"

THE SISALKRAFT CO.

205 West Wacker Drive
Chicago, Ill.

55 New Montgomery Street
San Francisco, Calif.

FORDERER CORNICE WORKS

Manufacturers of

Hollow Metal Products • Interior Metal Trim
Elevator Fronts and Cabs
Metal Plaster Accessories • Sanitary Metal Base
Flat and Roll Metal Screens
Metal Cabinets • Commercial Refrigerators

269 POTRERO AVE.

SAN FRANCISCO, CALIF.

HEMLOCK 4100

STRUCTURAL STEEL

For Class A Buildings,
Bridges, etc.

JUDSON PACIFIC - MURPHY CORP.

1200 SEVENTEENTH STREET
SAN FRANCISCO

Plants: San Francisco - Oakland

BASALITE

CAMBERED SHINGLE TILE

PERMANENT • FIREPROOF • STORM-
SAFE • COLORFUL • ECONOMICAL

Manufactured by

BASALT ROCK CO., INC.
NAPA, CALIFORNIA

IN THE NEWS

RICKKRAFT OPENS WESTERN OFFICE

The Richkraft Company, manufacturers of a complete line of building papers, Richkure Compound for curing airport runways, and Richkraft Curing Spray Machines, opened offices in the Pacific Building, Oakland, California, recently under the management of C. A. Cook.



C. A. COOK
General Manager

The Company also does a large business in striping airport runways, streets and highways in the east and it is expected this work will be extended to airports, highways and streets on the Pacific Coast, using PRISMO reflective paint and other RICHKRAFT traffic paints.

RICHKRAFT products will be distributed in northern California through Pacific Coast Aggregates, Inc., while the Nelson Equipment Company of Portland, Oregon, will serve as distributor for the Pacific northwest.

Cook, a graduate of the University of Illinois Civil Engineering School in 1932, joined the Sisalkraft Co. in 1933 and served in the sales department from 1939 to 1943. Since that time he has been District Engineer for the H. H. Robertson office in San Francisco.

Cook's experience covers every phase of merchandising, sales and service of building papers, in the middle west, east coast, and California, and he brings to the new office a broad knowledge of the construction and building industry.

OFFICES MOVED

JONES and MARSH, architects, have announced the removal of their offices to the Concord Building, 208 SW. Stark Street, Portland 4, Oregon.

ENGINEERING OFFICE

KYLE FORREST, Civil Engineer, has opened offices at 1504 Russ Building, San Francisco 4, California. Specializing in ground water hydrology, Mr. Forrest served with the U. S. Navy Civil Engineer Corps during World War II.

IRVING GOLDSTINE, architect, has opened a temporary office at 2030 Twelfth Avenue, San Francisco, California.

IN THE NEWS

ARCHITECTURAL DIVISION FORMED

The Porcelain Enamel Institute of Washington, D. C., has formed the Architectural Division under chairmanship of H. R. Spencer.

Purpose of the division is to help architects and builders acquire a better knowledge of the possibilities of porcelain enamel uses; to see that high standards are maintained for all porcelain enamel architectural installations.

IMPROVED FAUCET WASHER

Providing an easy method for repairing leaky, noisy faucets, a new "Little Wonder Faucet Washer" has been announced by the DURST MANUFACTURING CO., INC., 462-68 Broadway, New York.

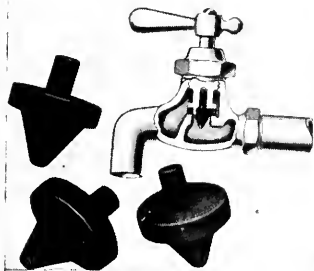

The washer has a permanent seat with positive grip and rotating disc action and is easily installed by simply removing the old style washer, discarding the screw and turning the new washer into place.

Manufactured in three sizes, they meet every faucet requirement.

HOME BUREAU MANAGER

A. J. Brook of St. Louis, Mo., has been appointed manager of the GENERAL ELECTRIC CO.'S HOME BUREAU, a technical and advisory service in electric wiring, equipment, kitchen planning, heating and air conditioning which is offered to architects and builders. His offices will be at Bridgeport, Conn.

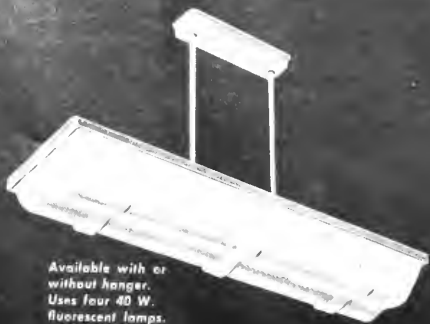

Available with or
without hanger.
Uses four 40 W.
fluorescent lamps.

PLASCOLIER

A new shielded luminaire that is now in production by Smoot-Holman. Extremely efficient, combining minimum surface brightness, maximum diffusion, low absorption. Lightweight plastic diffuser is safe to handle, no breakage hazards. Write for Catalog Supplement No. 22.



Offices in Principal Western Cities—Branch and Warehouse in San Francisco

PRODUCERS' COUNCIL PAGE

Northern California Chapter

The National Organization of Manufacturers of Quality Building Materials and Equipment

Affiliated with the AMERICAN INSTITUTE OF ARCHITECTS



JOHN S. BOLLES

Perspective heightens appreciation and often we get a truer picture of events around us from someone at a distance from the local scene. We turn from our own members this month to take a look at Architect John S. Bolles. The work to which John has unselfishly and aggressively given his time and energy in unifying

the profession in California has attracted nationwide attention. John's multiple duties include, President of the Northern California Association of Architects, President of the California Council of Architects and Secretary of the Northern California Chapter of the American Institute of Architects as well as Chief of the Technical Division of the San Francisco Housing Authority which job, to put it plainly, buys the groceries.

To better know the man we quote from the publication of the National Council of Architectural Registration Boards:

"Versatile John S. Bolles, chief of the Technical Division of the San Francisco Housing Authority, has crowded a varied career into his 39 years. His work has taken him to the four corners of the globe.

"He left his native Berkeley to study civil engineering at the University of Oklahoma, and from there went to Harvard where he obtained a Master's degree in architecture. On graduation, he was employed as chief structural engineer on power plant building in Oklahoma for the H. M. Byllesby Corporation.

"Archeology also interested the young architect and from 1929 to 1930 he was archeologist for the Oriental Institute of the University of Chicago, going for them to Turkey to study Hittite culture. Egypt and France were next on his itinerary.

"From 1931 to 1934 he was associated with the Carnegie Institute of Washington in a study of

Mayan culture at Chichen Itza. Mr. Bolles discovered the lost Mayan cities of Calakmul and Muneca, the former famous for its large number of hieroglyphic monuments.

"Excavations at Persepolis, ancient capital of Persia, next claimed his attention, but in 1936 Mr. Bolles ended his travels by returning to San Francisco to become associated with his father, Architect Edward G. Bolles.

"John Bolles designed several of the buildings at the 1939 Exposition on Treasure Island, among them the state building, Temple of Religion and the Christian Science Monitor Building.

"War housing claimed his attention at the outbreak of the war and he became area project engineer for the Federal Public Housing Authority. In 1943, he joined the San Francisco Housing Authority staff as chief of the technical division, where he has directed the construction of homes for more than 20,000 war workers."

Modular Coordination continues to receive the attention of the Technical Information Committee. On August 24, at the invitation of the Central Valley Chapter of the A.I.A., Chairman Chuck Kraft appeared before that group. On September 5, Chuck Kraft and Ray Brown, fellow committee member, met with the Architectural Club of San Francisco, presenting a program on Modular Coordination, highlighted by slides of the work being done by A. Gordon Lorimer, Chief of the Bureau of Architecture of New York City.

"New Modular Standard for Wood Windows and Sash" has just been published by the National Door Manufacturers Association. Up to now there have been at least 10 different local and regional window and sash standards. Result has been confusion among architects and duplication of producers' and distributors' stocks for each market they propose to serve.

Coordination to the four-inch module will result in important economies in building construction, an increasingly important consideration in the face of the alarming reaction to high building costs. Forecasts of future building volume based on an
(See Next Page)

USE QUALITY PRODUCTS



CONSULT AN ARCHITECT

estimated "need" of 10 million homes means that many homes will be built only if the price is "right." And whether the price is right or not depends upon comparative values of automobiles, radios, washing machines, stoves and all the other things that compete for the consumers' dollar.

Bastian-Morley Co., Inc., manufacturers of water heaters and boilers comes in for direct representation in the Chapter through the appointment of our Secretary, Charles Nicholas, presently with Crane Co., as Northern California Representative. Bastian-Morley products are marketed through the Crane organization.

Congratulations and best wishes in the new job, Nick.

"Reconversion Here" was the title of a report by the S. F. Chronicle on the meeting of the building industry, called by Anson Boyd, State Architect, August 28. President George Quamby appointed Chuck Kraft Regional Director to represent the Council locally, who warned of the inflationary effect of throwing a considerable portion of the State's program on the market at this time.



NEW WESTERN SALES MANAGER

Stuart L. Forsyth of Pittsburgh, Pa., and for the past four years advisory engineer in the New Products Division of the Westinghouse Electric Corporation's East Pittsburgh offices, has been appointed Pacific Coast District sales manager of the company's Home Heating Section of the Manufacturing and Repair Department at Emeryville, California.



STUART L. FORSYTH
Westinghouse Electric, comes to Emeryville, California.

Forsyth has coordinated and expedited development and adoption of new products and processes, super-

vised their analyses to determine technical, production and commercial possibilities, and has planned for their manufacture and sale.

A graduate of the University of Michigan in mechanical engineering, he is a member of the American Society of Mechanical Engineers, American Society of Heating and Ventilating Engineers, is married and has two children.

Be sure you're getting the finest window glass obtainable

it costs no more to specify

PENNUERNON

Distributed by...

W. P. FULLER & CO.
PAINTS • GLASS • WALLPAPER



QUALITY AND DEPENDABLE
Service

are the factors that influence architects and contractors when selecting lumber and mill work — Quality of merchandise — Integrity and Ability of the firm — Service in physical equipment — Experience and Personnel — All these factors contribute to a speedy and satisfactory completion of construction with minimum of time and expense.

MANUFACTURER OR DEALER IN

Douglas Fir — Redwood — Sugar and Ponderosa Pine — Plywood and Concrete Form Panels — Sash and Doors — Millwork — Insulation — Builders' Hardware.

E. K. WOOD LUMBER CO.

"Goods of the Woods" ©
LOS ANGELES • SAN FRANCISCO • OAKLAND

To get
more useful heat
for less money . . .



... specify **J**OHNSON BURNERS

They'll bring your heating costs down because they are engineered to burn the lowest priced fuel . . . burn it *completely* . . . and to *capture* and use an exceptionally high percentage of the heat generated in combustion.

From now on, don't be content with inefficient heating equipment. Get your Heating Engineer or your local Johnson Dealer to show you how Johnson Burners can give you years of new heating economy and new heating contentment. There really is a difference.

Whether you have a hotel or a 5-room house to heat, you'll get happy results with

... *Johnson Oil Burners* ...
S. T. JOHNSON CO.
940 Arlington Ave., Oakland 8, Calif.
401 No. Broad St., Philadelphia 8, Pa.

GET ADVANCE INFORMATION

On building construction projects in Northern California.

ARCHITECT'S REPORTS gives a DAILY summary of projects including the name and location of the project, architect, proposed cost and other pertinent information.

Building material dealers and contractors use the REPORTS to develop new customers.

Subscribe Today — \$10 Per Month

ARCHITECTS REPORTS

Published Daily by
ARCHITECT and ENGINEER, Inc.

68 POST STREET, SAN FRANCISCO EXBROOK 7182

FASHION BUILDING

(From Page 34)

mechanical ventilation and high intensity industrial fluorescent lighting. The building has been planned to permit a continuous 270-foot long production line, from the uncut material to the packaged product ready for display or shipment.

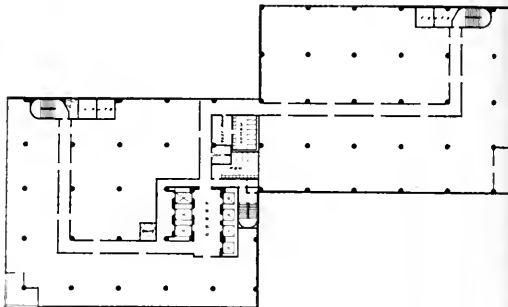

Typical Loft Floor Plan

Three high speed package elevators have been placed at the terminus of the production line, opening directly upon a large shipping platform, thus eliminating the necessity of double handling in any phase of the operations. The package elevators have also been located adjacent to the bank of four high-speed passenger elevators to augment handling of passengers during the peak hours of egress and ingress of employees.

To further expediate shipment of products, a package chute has been provided from each floor to offices of package delivery agencies. A branch post office is provided to facilitate out-of-town mail shipments.

In providing for the comfort and convenience of the large population of employees and in rounding out the "complete city" idea, provisions have been

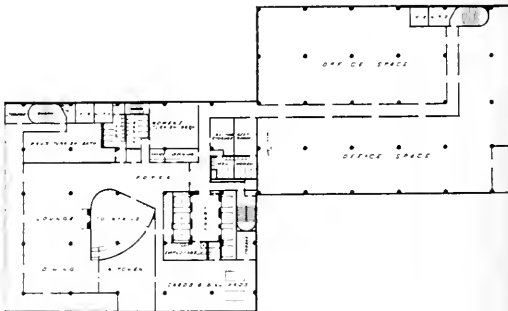

13th Floor Plan of Textile Building

incorporated for radio broadcasts and "piped" music throughout the building. A roof has been provided where employees bringing their own (See Page 44)

ESTIMATOR'S GUIDE

BUILDING AND CONSTRUCTION MATERIALS

PRICES GIVEN ARE FIGURING PRICES AND ARE MADE UP FROM AVERAGE QUOTATIONS FURNISHED BY MATERIAL HOUSES TO SAN FRANCISCO CONTRACTORS. 2½% SALES TAX ON ALL MATERIALS BUT NOT LABOR

All prices and wages quoted are for San Francisco and the Bay District. There may be slight fluctuation of prices in the interior and southern part of the state. Freight cartage, at least, must be added in figuring country work.

BONDS—Performance—\$10 per \$1000 of contract. Labor and materials, \$10 per \$1000 of contract.

BRICKWORK—

- Common Brick—Per 1M laid—\$50.00 to \$60.00 (according to class of work).
- Face Brick—Per 1M laid—\$120 to \$150 (according to class of work.)
- Brick Steps—\$1.60 per lin. ft.
- Brick Veneer on Frame Bldg.—Approx. \$1.30 per sq. ft.
- Common Brick—\$19.00 per M, truckload lots, f.o.b. job.
- \$19.00 per M, less than truckload, plus cartage.
- Face Brick—\$40 to \$80 per M, truckload lots, delivered.
- Cartage—Approx. \$4.00 per M.

BUILDING PAPER—

- 1 ply per 1000 ft. roll..... \$3.50
- 2 ply per 1000 ft. roll..... 5.00
- 3 ply per 1000 ft. roll..... 6.25
- Brownskin, Standard, 500 ft. roll..... 5.00
- Sisal Kraft, 500 ft. roll..... 5.00
- Sash cord com. No. 7..... \$1.20 per 100 ft.
- Sash cord com. No. 8..... 1.50 per 100 ft.
- Sash cord spot No. 7..... 1.90 per 100 ft.
- Sash cord spot No. 8..... 2.25 per 100 ft.
- Sash weights, cast iron, 950.00 ton.
- Nails, \$3.42 base.
- Sash weights, \$45.00 per ton.

CONCRETE AGGREGATES—

- The following prices net to Contractors unless otherwise shown.
- Gravel, all sizes**—
\$1.95 per ton at Bunker; delivered \$2.50
- | | | |
|------------------------|--------|--------|
| | Bunker | Del'd |
| Top Sand | \$1.90 | \$2.50 |
| Concrete Mix | 1.90 | 2.45 |
| Crushed Rock, ¾" to ¾" | 1.90 | 2.50 |

- | | | |
|-------------------------|------|------|
| Crushed Rock, ¾" to 1½" | 1.90 | 2.50 |
| Roofing Gravel | 2.25 | 2.80 |
| River Sand | 2.00 | 2.45 |
- Sand**—
- | | | |
|----------------------|------|--------------|
| River Sand | 2.00 | 2.45 |
| Lapis (Nos. 2 & 4) | 2.85 | 3.15 |
| Olympia (Nos. 1 & 2) | 2.85 | 3.10 |
| Del Monte White | | 84c per sack |

- Cement**—
- Common (all brands, paper sacks), carload lots, \$2.42 per bbl. f.o.b. car; delivered \$2.72.
- Cash discount on carload lots, 10c a bbl., 10th Prox.; less than carload lots \$3.20 per bbl. f.o.b. warehouse or delivered.
- Cash discount 2% on L.C.L.
- | | |
|-----------------|--|
| Atlas White | } 1 to 100 sacks, \$2.50 sack |
| Calaveras White | |
| Medusa White | warehouse or del.; \$7.65 bbl. carload lots. |

Forms labor average \$350 per 1000 sq. feet.

Average cost of concrete in place, 50c per cubic foot, exclusive of forms; \$15.00 per cubic yard. With forms \$1.60 per cubic foot.

DAMP-PROOFING and Waterproofing—

- Two-coat work, \$3.50 per square.
- Membrane waterproofing—4 layers of saturated felt, \$7.00 per square.
- Hot coating work, \$2.50 per square.
- Medusa Waterproofing, \$3.50 per lb. San Francisco Warehouse.
- Tricocel waterproofing.
- (See representative.)

ELECTRIC WIRING—\$12 to \$15 per outlet for conduit work (including switches).

Knob and tube average \$3.00 per outlet. (Available only for priority work.)

ELEVATORS—

Prices vary according to capacity, speed and type. Consult elevator companies. Average cost of installing a slow speed automatic passenger elevator in small four story apartment building, including entrance doors, about \$6500.00.

EXCAVATION—

Sand, 60 cents; clay or shale \$1 per yard.

Trucks, \$20 to \$32 per day.

Above figures are an average without water. Steam shovel work in large quantities, less; hard material, such as rock, will run considerably more.

FIRE ESCAPES—

Ten-foot galvanized iron balcony with stairs, \$150 installed on new buildings; \$160 on old buildings.

FLOORS—

- Composition Floors, such as Magnesite, 50c per square foot.
- Linolite—2 gages—\$1.25 to \$2.75 per sq. yd.
- Mastopave—90c to \$1.50 per sq. yd.
- Battleship Linoleum—available to Army and Navy only—1/6"—\$1.75 sq. yd.
- 7/8"—\$2.00 sq. yd.
- Terazzo Floors—50c to 70c per sq. ft.
- Terazzo Steps—\$1.75 per lin. ft.
- Mastic Wear Coat—according to type—20c to 35c.
- Hardwood Flooring**—Standard Mill grades not available.
- Victory Oak—T & G
 - 3/8" x 2 1/4"..... \$143.25 per M, plus Cartage
 - 1/2" x 2"..... 122.00 per M, plus Cartage
 - 1/2" x 1 1/2"..... 113.50 per M, plus Cartage
- Prefinished Standard & Better Oak Flooring
 - 3/8" x 3 1/4"..... \$160.00 per M, plus Cartage
 - 1/2" x 2 1/2"..... 160.50 per M, plus Cartage
- Maple Flooring
 - 3/8" T & G Clear \$160.50 per M, plus Ctg.
 - 2nd 153.50 per M, plus Ctg
 - 3rd 131.25 per M, plus Ctg.
- Floor Layers' Wage, \$150 per hr.

GLASS—

- Single Strength Window Glass 20c per ft
- Double Strength Window Glass 30c per ft.
- Plate Glass, under 75 sq. ft. . . . \$1.00 per ft.
- Polished Wire Plate Glass 1.40 per ft.
- Rgh. Wire Glass34 per ft.
- Obscure Glass27 per ft.
- Glazing of above is additional.
- Glass Blocks \$2.50 per ft. set in place

HEATING—

- Average, \$1.90 per sq. ft. of radiation according to conditions.
- Warm air (gravity) average \$48 per register.
- Forced air, average \$68 per register.

IRON—Cen. of ornamental iron, cast iron, etc., depends on design.

LUMBER—All lumber at O.P.A. ceiling prices:—

No. 1 Common	\$49.00 per M
No. 2 Common	47.75 per M
Select O. P. Common	52.75 per M

Flooring—

Delivd	
V.G.-D.F. B & Btr. 1 x 4 T & G Flooring	\$80.00
C 1 x 4 T & G Flooring	75.00
D 1 x 4 T & G Flooring	65.00
D.F.-S.G. B & Btr. 1 x 4 T & G Flooring	61.00
C 1 x 4 T & G Flooring	59.00
D 1 x 4 T & G Flooring	54.00
Rwd. Plastic—"A" grade, medium dry	82.00
"B" grade, medium dry	78.50

Plywood—not available

	Under \$200	Over \$200
"Plyscord"— $\frac{3}{8}$ "	\$49.50	\$47.55
"Plywall"— $\frac{1}{4}$ "	45.15	43.30
3 ply— $2\frac{1}{2}$ s— $\frac{1}{4}$ "	48.55	46.60
"Plyform"— $\frac{5}{8}$ "		
Unoilcd	126.50	121.45
Oiled	127.90	122.75

Above prices delivered if quantity is sufficient to warrant delivery.

Shingles (Rwd. not available)—
 Red Cedar No. 1—\$6.75 per square; No. 2, \$5.75; No. 3, \$4.45.
 Average cost to lay shingles, \$3.00 per square.
 Cedar Shakes—Tapered: $\frac{1}{2}$ " to $\frac{3}{4}$ " x 25"—\$8.95 per square.
 Resawn: $\frac{3}{4}$ " to $1\frac{1}{4}$ " x 25"—\$10.65 per square.
 Resawn: $\frac{3}{4}$ " to $1\frac{1}{4}$ " x 25"—\$10.65 per square.
 Average cost to lay shakes, \$4.00 per square.

MILLWORK—Standard.

D. F. \$100 per 1000. R. W. Rustic \$100.00 per 1000 (delivered).

Double hung box window frames, average with trim \$6.50 end up, each.

Complete door unit, \$10.00.

Screen doors, \$3.50 each.

Patent screen windows, 25c a sq. ft.

Cases for kitchen pantries seven ft. high, per lineal ft., \$9.00 each.

Dining room cases, \$9.00 per lineal foot.

Rough end finish about 80c per sq. ft.

Labor—Rough carpentry, warehouse heavy framing (average), \$40.00 per M.

For smaller work average, \$40.00 to \$55.00 per 1000.

MARBLE—(See Dealers)

PAINTING—

Two-coat work	per yard	50c
Three-coat work	per yard	70c
Cold water painting	per yard	10c
Whitewashing	per yard	8c

PAINTS—

Two-coat work	50c per sq. yd.
Three-coat work	70c per sq. yd.
Cold water painting	per yard 10c
Whitewashing	8c per sq. yd.
Turpentine	\$1.03 per gal. in drum lots.
	\$1.08 per gal. in 5-gal. containers.
Raw Linseed Oil	not available.

Boiled Linseed Oil—\$1.38 per gal. in drums. Available only to work with high priority—\$1.48 per gal. in 5-gal. containers.

Use replacement oil—\$1.86 per gal. in 1-gal. containers.

Replacement Oil—\$1.20 per gal. in drums. \$1.30 per gal. in 5-gal. containers.

A deposit of \$6.00 required on all drums.

PATENT CHIMNEYS—

6-inch	1.20 lineal foot
8-inch	1.40 lineal foot
10-inch	2.15 lineal foot
12-inch	2.75 lineal foot

PLASTER—

Neat wall, per ton delivered in S. F. in paper bags, \$17.60.

PLASTERING (Interior)—

3 Coats, metal lath and plaster	Yard	1.50
Keene cement on metal lath		1.80
Ceilings with $\frac{3}{4}$ " hot roll channels metal lath (lathed only)		1.20
Ceilings with $\frac{3}{4}$ " hot roll channels metal lath plastered		2.20
Single partition $\frac{3}{4}$ " channel lath 1 side (lath only)		1.20
Single partition $\frac{3}{4}$ " channel lath 2 inches thick plastered		3.20
4-inch double partition $\frac{3}{4}$ " channel lath 2 sides (lath only)		2.20
4-inch double partition $\frac{3}{4}$ " channel lath 2 sides plastered		3.85
Thermax single partition; 1" channels; 2" overall partition width. Plastered both sides		3.30
Thermax double partition; 1" channels; 4" overall partition width. Plastered both sides		4.40
3 coats over 1" Thermax nailed to one side wood studs or joists		1.65
3 coats over 1" Thermax suspended to one side wood studs with spring sound isolation clip		1.90

Note—Channel lath controlled by limitation orders.

PLASTERING (Exterior)—

2 coats cement finish, brick or concrete wall	Yard	\$1.00
3 coats cement finish, No. 18 gauge wire mesh		2.00
Lime—\$3.00 per bbl. at yard.		
Processed Lime—\$3.10 bbl. at yard.		
Rock or Grip Lath— $\frac{3}{8}$ "—20c per sq. yd.		
		$\frac{1}{2}$ "—19c per sq. yd.

Composition Stucco—\$1.80 to \$2.00 sq. yard (applied).

PLUMBING—

From \$100.00 per fixture up, according to grade, quantity and runs.

ROOFING—

Standard tar and gravel, 4 ply	\$8.00 per sq. foot, for 30 sqs. or over.
Less than 30 sqs.	\$9.50 per sq.
Tile, \$30.00 to \$40.00 per square.	
Redwood Shingles, \$7.50 per square in place.	
5/2" #1-16" Cedar Shingles, 4 1/2" Exposure	\$8.00 square

5/8 x 16"—#1 Cedar Shingles, 5" Exposure	\$9.00 square
4/2" #1-24" Royal Shingles, 7 1/2" Exposure	\$9.50 square
Re-coat with Gravel	\$4.00 per sq.
Asbestos Shingles, \$23 to \$28 per sq. laid	
1/2 x 25" Resawn Cedar Shakes, 10" Exposure	\$10.50
3/4 x 25" Resawn Cedar Shakes, 10" Exposure	11.50
1 x 25" Resawn Cedar Shakes, 10" Exposure	12.50

Above prices in for shakes in place.

SHEET METAL—

Windows—Metal, \$1.75 a sq. ft.
 Fire doors (average), including hardware \$2.00 per sq. ft.

SKYLIGHTS—(not glazed)

Copper, 90c sq. ft. (flat).
 Galvanized iron, 40c sq. ft. (flat).
 Vented hip skylights 60c sq. ft.

STEEL—STRUCTURAL (None available except for defense work).

\$150 ton (erected), this quotation is an average for comparatively small quantities. Light truss work higher. Plain beams and column work in large quantities \$140 per ton.

STEEL REINFORCING (None available except for war work).
 \$100 to \$130 ton, set.

STONE—

Granite, average, \$6.50 cu. foot in place
 Sandstone, average Blue, \$4.00. Boise, \$3.00 sq. ft. in place.
 Indiana Limestone, \$2.80 per sq. ft. in place.

STORE FRONTS (None available).

TILE—

Ceramic Tile Floors—\$1.00 to \$1.25 per sq. ft.
 Cove Base—\$1.10 per lin. ft.
 Glazed Tile Wainscot—\$1.25 per sq. ft.
 Asphalt Tile Floor— $\frac{1}{8}$ " & $\frac{3}{8}$ "—\$.18 to \$.35 per sq. ft. Light shades slightly higher.
 Cork Tile—\$.40 to \$.75 per sq. ft.
 Mosaic Floors—see dealers.
 Lino-Tile, \$.35 to \$.75 per sq. ft.

Wall Tile—

Glazed Terra Cotta Wall Units (single faced) laid in place—approximate prices:	
2 x 6 x 12	\$1.10 sq. ft.
4 x 6 x 12	1.25 sq. ft.
2 x 8 x 16	1.20 sq. ft.
4 x 8 x 16	1.40 sq. ft.

VENETIAN BLINDS—

40c per square foot and up. Installation extra.

WINDOWS—STEEL—

30c per square foot, \$5 for ventilators.

IN THE NEWS

ATOMIC BOMB

Expenditures at Oak Ridge, Tenn.; Pasco, Washington, and Alamogordo, New Mexico, for buildings and facilities in conjunction with the development of the Atomic Bomb totaled \$1,665,000,000, according to War Department reports.

\$1,106,000,000 was spent at Oak Ridge, \$382,000,000 at Pasco, and \$180,000,000 at Alamogordo.

COLOR DYNAMICS PRINCIPLES

One of the wartime industrial developments has been the scientific use of color to promote efficiency and comfort.

A series of four-page booklets giving detail of color application to various types of businesses, in-

cluding printing and cutting operations, has been prepared by the PITTSBURGH PLATE GLASS COMPANY, Color Engineering Department, 632 Duquesne Way, Pittsburgh 22, Pa.

TIME SAVER

A simplified method for handling metal scrap from machining,



has been devised by the ELWELL PARKER ELECTRIC CO. of Loveland, Ohio.

By use of "built-in" pallets, an electric power truck equipped with a swivel-mounted fork, picks up a fully loaded box and transports it to a loading platform where they are elevated and up-ended for quick dumping into street trucks.

VICTOR BOOKLET -52

Highly illustrated in color and containing many interesting scenes of VICTOR equipment in action, a new booklet has just been released by the VICTOR EQUIPMENT CO., 844-54 Folsom Street, San Francisco.

Use of cutting torches and attachments for every purpose in postwar construction is covered in the publication.

1945 BUILDING TRADES WAGE SCALES (JOB SITES) NORTHERN CALIFORNIA

Six- and seven-hour day eliminated on all Government Work. A. F. L. - O. P. M. Agreement calls for eight-hour day.

NOTE: Predeterminations by the Department of Labor, as of July 1, 1944 [the wage-freezing date] have not yet been made in all of the counties listed. The wage scales shown are those being paid and in effect mostly by agreement between employees and their union.

	San Francisco	Alameda and Contra Costa	Fresno	Marin	Sacramento	San Jose	San Mateo	Vallejo	Stockton
CRAFT									
ASBESTOS WORKERS	1.50	1.50	1.25	1.50	1.50	1.25	1.50	1.50	1.25
BRICKLAYERS	1.87½	1.87½	1.75	1.87½	1.75	2.00	1.79-1/6	1.75	1.50
BRICKLAYERS' HODCARRIERS	1.45	1.40	1.05	1.40	1.25	1.50	1.35	1.50	1.14
CARPENTERS	1.50	1.50	1.25	1.43¼	1.37½	1.37½	1.43¼	1.50	1.37½
CEMENT FINISHERS	1.50	1.50	1.50	1.50	1.50	1.50	1.50	1.50	1.50
ELECTRICIANS	1.70	1.70	1.70	1.70	1.70	1.70	1.70	1.70	1.70
ELEVATOR CONSTRUCTORS	1.75½	1.75½	1.75½	1.75½	1.75½	1.75½	1.75½	1.75½	1.75½
ENGINEERS' MATERIAL HOIST	1.50	1.50	1.25	1.50	1.37½	1.42½	1.37½	1.50	1.25
PILE DRIVER	1.75	1.75	1.60	1.75	1.75	1.75	1.75	1.75	
STRUCTURAL STEEL	1.75	1.75	1.60	1.75	1.75	1.75	1.75	1.75	1.60
GLASS WORKERS	1.40	1.40	1.12½	1.40	1.21	1.40	1.40	1.40	
IRONWORKERS' ORNAMENTAL	1.60	1.50	1.60	1.50	1.60	1.31¼	1.50	1.50	
REINF. RODMEN	1.50	1.50	1.60	1.50	1.60	1.50	1.50	1.50	1.75
STRUCTURAL	1.75	1.75	1.75	1.75	1.75	1.75	1.75	1.75	1.37½
LABORERS' BUILDING	1.00	1.00	.90	.87½	.95	.93¼	.90	.90	
CONCRETE	1.00	1.00	.90	.87½	.95	.90	.93¼	.95	1.00
LATHERS	1.75	1.75	1.50	1.75	1.60	1.75	1.75	1.75	1.75
MARBLE SETTERS	1.50	1.50	1.50	1.50	1.50	1.50	1.50	1.50	1.50
MOSAIC & TERRAZZO	1.25	1.25	1.12½	1.25	1.15-5 B	1.12½			
PAINTERS	1.50	1.50	1.28-4/7	1.50	1.43	1.50	1.42-6/7	1.44-2/7	1.37½
PILEDRIVERS	1.54	1.54	1.54	1.54	1.54	1.54	1.54	1.54	1.54
PLASTERERS	1.75	1.83½	1.75	1.75	1.75	2.00	2.00	1.75	1.83-1/3
PLASTERERS' HODCARRIERS	1.50	1.60	1.40	1.50	1.18¼	1.50	1.75	1.50	1.50
PLUMBERS	1.70	1.70	1.53-1/8	1.70	1.68¼	1.62½	1.70	1.70	1.50
ROOFERS	1.50	1.50	1.25	1.37½	1.37½	1.37½	1.25	1.37½	1.37½
SHEET METAL WORKERS	1.50	1.50	1.50	1.50	1.50	1.50	1.37½	1.50	1.50
SPRINKLER FITTERS	1.58	1.58	1.53-1/8	1.70	1.68¼	1.62½	1.70	1.70	1.50
STEAMFITTERS	1.75	1.75	1.53-1/8	1.70	1.68¼	1.62½	1.70	1.70	1.50
STONESETTERS (MASONS)	1.87½	1.87½	1.50	1.75	1.75	1.50	1.75	1.75	1.50
TILESETTERS	1.50	1.50	1.37½	1.50	1.37½	1.50	1.50	1.50	1.37½

Prepared and compiled by

CENTRAL CALIFORNIA CHAPTER, ASSOCIATED GENERAL CONTRACTORS OF AMERICA

with the assistance and cooperation of secretaries of General Contractors Associations and Builders Exchanges of Northern California.

CLASSIFIED ADVERTISING

RATE: 8c PER WORD . . . CASH WITH ORDER

MINIMUM \$1.50 (3 Lines)

ARCHITECT'S REPORTS—A valuable advance news service giving building and construction information daily on projects in Northern California. Name, location, architect, proposed cost, etc., on individual slips. Ideal for securing new business leads. Hundreds of items, total monthly cost only \$10. Don't delay, subscribe today. ARCHITECT & ENGINEER, Room 618, 68 Post Street,

San Francisco, California. Phone DOuglas 8311.

ARCHITECTS—A. McF. McSweeney, Architect, Room 927 Hearst Bldg., San Francisco. New offices. Desires catalogs.

WANTED: Men on good residential working drawings and detailing. Write full qualifications. Roland E. Coate, Architect, 1111 Architects Bldg., Los Angeles, California.

PHOTOGRAPHY—Keep a pictorial record of your building, or construction project. Pictures are of tremendous value to contractors, builders, engineers, architects. For Industrial-Publicity-Aerial photography, see FRED MAE, Room 721-22 Hearst Bldg., San Francisco 3, California.

PRINTING—Printers, bookbinders. See us for commercial printing. Mercury Press, 942 Howard Street, San Francisco.

HOGAN LUMBER CO.

Wholesale and Retail

LUMBER

MILL WORK • SASH & DOORS

Office, Mill, Yard and Docks

SECOND AND ALICE STREETS • OAKLAND, CALIF.

Telephone GLencourt 6861

MALOTT & PETERSON

ROOFING AND FLOORING
CONTRACTORS

20TH AND HARRISON STREETS

SAN FRANCISCO

Phone ATwater 1600

CLINTON CONSTRUCTION CO. OF CALIFORNIA

General Contractors

923 FOLSOM STREET • SAN FRANCISCO

SUtter 3440

SANTA MARIA INN SANTA MARIA, CALIFORNIA

FRANK J. McCOY, General Manager

FERNAND E. PIMENTEL, Manager

On the
Coast
Highway
between
San
Francisco
and
Los
Angeles



American
or
European
Plan
•
Old
English
Top
Room

FASHION BUILDING

(From Page 40)

lunch may enjoy the sun while eating. Also recreation is provided on the roof by means of various games as selected by the individuals. Stores and small shops will be located within the building for the convenience, in particular, of the women employees. Among these will be markets, a drug store, notion store, beauty shop, barber shop and florist shop. Also provided are a bank, telegraph office, restaurant, cafeteria and cocktail lounge.

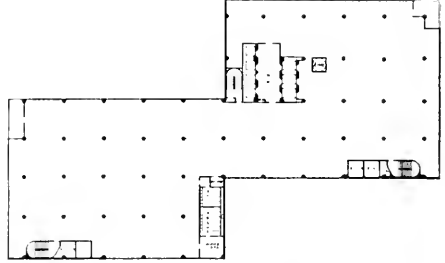

Typical Office Floor Plan

An appealing feature to tenants is the planned private club for the relaxation of the manufacturers, who may become members, and as a convenient place to entertain out-of-town buyers. One half of the top floor and a portion of the roof will be devoted to club facilities, including a lounge, dining room, cocktail lounge, game room, Turkish baths, sun bathing and deck games.

BAY MEADOWS AIRPORT

(From Page 11)

and safety thereby attracting the best in private aircraft interest.

Automobile parking facilities have been expanded to meet anticipated requirements, space being provided around each of the hangars, the central control tower, and administration building.

Selected concessions will be located in and around the control tower and administration building, while three spur tracks from the main line of the Southern Pacific railroad will serve for delivery of gasoline, both for aircraft and automobiles, as well as other materials and supplies.

It is contemplated that during the time horse races are being run at Bay Meadows Track, airliners and private aircraft will make special trips to the airport, therefore provisions have been made to receive, park, service and dispatch private and transient aircraft from airports throughout California and the Pacific Slope states.

The Bay Meadows Airport will be under the direction of William P. Kyne, while Frederick K. Dupuy will serve as Airport Engineer.

BOOK REVIEWS

PUBLIC AFFAIRS PAMPHLET No. 95. "Houses for Tomorrow." By T. R. Carskadon. Public Affairs Committee, Inc., 30 Rockefeller Center, New York 20, N. Y. 10 cents.

This pamphlet is based on American Housing Problems and Prospects, by Miles L. Colean and the Report of the Committee on Housing of the Twentieth Century Fund. The pamphlet is a brief resume of the housing picture and recommends to the construction industry a reorganization of its construction procedures. The pamphlet sums up the report given by the Twentieth Century Fund with this paragraph quoted from its last page:

"As we complete this rapid look at postwar housing prospects in America, we get the impression of great needs and superb opportunities. Can the housing industry meet them? If it continues along in its traditional methods, it cannot do so. We are confronted with difficulties on every side—our land system, our methods of taxation, our builder organizations, our ways of making and selling materials, labor, real estate operators, mortgage lenders, even the government itself. Almost every element in the picture operates on a restricted, insecure, 'let me get mine first' basis."

John S. Bolles.

PROCEDURE HANDBOOK OF ARC WELDING DESIGN AND PRACTICE. Eighth Edition. The Lincoln Electric Company, Cleveland 1, Ohio. Price \$1.50.

The Lincoln Electric Company of Cleveland, Ohio, has brought out an Eighth Edition to their "Procedure Handbook of Arc Welding Design and Practice." With the tremendous developments in arc welding during the war, and with the training given to men in the welding field, it is now incumbent upon the architects and engineers to make use of this information.

This handbook contains over 300 pages of material on the designing of arc welded structures. It is this section that is of the greatest interest to the professional man in the building field. The balance of the handbook, which contains over 1200 pages, is devoted to materials, procedures, techniques, costs, typical applications, and general data reference material.

John S. Bolles.

SOUND PRODUCTION

A 12-page brochure announcing the DUPLEX SPEAKER, a two-way multi-cellular speaker in compact form, has just been issued by the ALTEC LANSING CORPORATION, 1210 Taft Building, Hollywood 28, California.

"AMERICAN - MARSH"

CONDENSATION UNIT

Pumping
Machinery
for
Every
Purpose

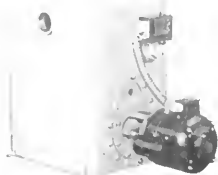

For Service
Call
DOuglas
6794
or
MUtual8322

SIMONDS MACHINERY CO.
SAN FRANCISCO LOS ANGELES
816 FOLSOM 455 EAST 4TH

VERMONT MARBLE COMPANY

Producers and Finishers
of
Domestic and Imported Marbles

Write for new pamphlet describing our
Marble Toilets and Showers

San Francisco and Los Angeles
San Francisco phone: SUTter 6747



The Most Complete Line of
STEELS and BUILDING MATERIALS
Made by a Single Producer



See Sweet's Catalog File or write us for
full information.

REPUBLIC STEEL CORPORATION
GENERAL OFFICES: CLEVELAND, OHIO

DENVER, COLORADO CONTINENTAL OIL BUILDING
LOS ANGELES, CALIFORNIA EDISON BUILDING
SALT LAKE CITY, UTAH WALKER BANK BUILDING
SAN FRANCISCO, CALIFORNIA RIALTO BUILDING
SEATTLE, WASH. WHITE-HENRY-STUART BUILDING

PACIFIC MANUFACTURING CO.

HIGH CLASS INTERIOR FINISH
QUALITY MILLWORK

142 SANSOME ST., SAN FRANCISCO
GARfield 7755

6820 MCKINLEY AVE., LOS ANGELES
THornwall 4196

BUILDERS EXCHANGE, OAKLAND

Real Estate Loans



F. H. A. loans are readily available on existing homes up to 80% of the appraised value. You can buy a home and pay for it in small monthly installments like rent. For example, a 20-year loan of \$4000 would cost about \$33.71 per month, including taxes, insurance, principal and interest.

*Come in and talk with us.
We can help you get the home you want.*

CROCKER FIRST NATIONAL BANK
OF SAN FRANCISCO
California's Oldest National Bank
ONE MONTGOMERY STREET
Member Federal Deposit Insurance Corporation

"KIMSUL"

Controlled Insulation!

THERMAL EFFICIENCY 0.27

Compressed in rolls for shipment and to save storage space, it stretches out over 5 times and when fully stretched gives a uniform designated thickness which insures the same maximum insulation value at all points.

Fire, Moisture and Vermin Resistant
Extremely Light, Clean and Easy to Install.

GUNN, CARLE & CO.
20 Potrero Avenue
San Francisco 3
UN 5480

IN THE NEWS

NEW PUBLIC RELATIONS DIRECTOR

James A. Baubie has been appointed director of public relations for the Westinghouse Electric Corporation with offices at Pittsburgh, Pa., succeeding G. Howard Pendray who is resigning to enter private business.

Baubie joined the Westinghouse organization in 1937.

PRODUCES RADIO SHOW

George Kondolf has been named producer of "The Theatre Guild on the Air," United States Steel Corporation's full-hour dramatic show, heard each Sunday evening over the American Broadcasting Company network.

NEW HOSE COUPLING

Made of lightweight aluminum with only two moving parts, a new industrial hose coupling has been announced by the E. B. WIGGINS OIL TOOL CO., 3424 East Olympic Blvd., Los Angeles.

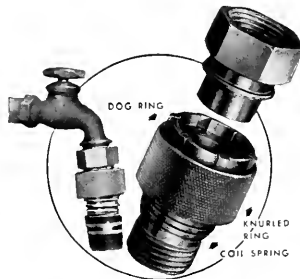

Designed to eliminate waste the coupling will withstand a pressure of 600 pounds per square inch. It is easily fitted to standard threaded faucets, is simple to attach or detach and comes in two convenient standard sizes— $\frac{3}{8}$ inch and $\frac{1}{2}$ inch.

EXCLUSIVE DISTRIBUTOR

The United States Plywood Corporation has been appointed exclusive distributor of "Decorative Micarta," a laminated plastic sheet made by the Westinghouse Electric Corporation.

Available in many colors and patterns and impervious to moisture and stains, "Micarta" was used prior to the war for table and counter tops, booth and store partitions, walls and doors.

BOOKLET AVAILABLE

The Los Angeles Chamber of Commerce is again issuing its handbook, "So You're Going to Build," a compact guide for prospective home builders.

KYLE FORREST

Civil Engineer

Water Supply — Sanitation

Municipal — Private
Consultations — Investigations
Reports — Designs — Valuations
Supervision — Litigation

Ground Water Work a Specialty

Hydrologic studies — wells, de-watering, underdrainage, foundations, conservation, testimony.

1504 Russ Building
San Francisco 4
YUkon 0652

MODELS

- HOMES
- BUILDINGS
- FACTORIES
- ENGINEERING PROJECTS
- REALISTICALLY BUILT TO SCALE

EDWARD OWENS-ASSOCIATES
TECHNICAL MODEL BUILDERS
252 CLAY ST. DO. 2094 SAN FRANCISCO

Scott Company

HEATING . . PLUMBING . . TILE

★

243 MINNA STREET
SAN FRANCISCO
Phone EXbrook 6741

G. P. W.
JENSEN & SON

Building Construction

320 Market Street, San Francisco
Phone: GARfield 2444

JOHN CASSARETTO
COMPANY

—Since 1886—And Still Active—

Building Materials

READY MIX CONCRETE
ROCK - SAND - GRAVEL - LIME
CEMENT - PLASTER - MORTAR
METAL LATH - WOOD LATH
STUCCO - WIRE NETTING

Service Unexcelled

Bunkers
Sixth and Channell, San Francisco
Phones: GARfield 3758 - 3760

MULLEN MFG.
COMPANY

BANK, STORE AND OFFICE
FIXTURES—CABINET WORK
OF GUARANTEED QUALITY
CHURCH SEATING

Office and Factory:
40-80 RAUSCH ST., Bet. 7th and 8th Sts.
San Francisco
Telephone UNDERhill 5815

THE TORMEY
COMPANY

GENERAL PAINTERS
AND DECORATORS

Phone UNDERhill 1913

563 FULTON STREET
San Francisco

IN THE NEWS

NEW CHEMICAL ENGINE

Producing 60 per cent more foam than any other 40-gallon foam engine, this new FOAMITE CHALLENGER is designed to extinguish hot oil fires without danger of re-flash.



THE CHALLENGER

Among scientifically designed features is a metering device and according to its manufacturers, the American-LaFrance Foamite Corporation, Elmira, N. Y., the foam produced from this new model is tougher, more tenacious, and more lasting.

APPOINTS ENGINEER

Recognizing the desirability of having a practicing engineer on the city's Planning Commission, San Francisco's Mayor Lapham has appointed one of our members to that board. He is James J. Walsh, consulting engineer, who has been in private practice in the Bay area since 1915, specializing in harbor development, railroad terminals and reclamation work.

OPENS OFFICE

Walter Wagner, architect and engineer, has opened offices in the Bank of America Building, Fresno, California. Is interested in receiving manufacturers' publications.

Phone GARfield 1164

Thomas B. Hunter

Consulting Engineer

DESIGNER OF HEATING
AIR CONDITIONING
VENTILATING AND WIRING
SYSTEMS, MECHANICAL
AND ELECTRICAL EQUIP-
MENT OF BUILDINGS

41 SUTTER STREET
ROOM 710
San Francisco California

ANDERSON
&
RINGROSE

General Contractors

320 Market Street, San Francisco
Phone GARfield 2245

DINWIDDIE
CONSTRUCTION
COMPANY
•
BUILDERS
•

CROCKER BUILDING
SAN FRANCISCO



HERRICK
IRON WORKS

STRUCTURAL STEEL
REINFORCING STEEL

18TH AND CAMPBELL STS.
OAKLAND, CALIF.
Phone GLEncourt 1747

Independent Iron Works

Structural Steel
Ornamental Iron
Steel Service Stations
Steel Tanks
Standard Steel Mill Buildings
Bridges

821 Pine Street Oakland

George F. Brayer

ELECTRICAL
CONTRACTOR

166 Seventh Street
San Francisco

Phones: KLondike 2-0879
HEmlock 2646

SMITH, EMERY & CO.

Since 1904

Engineers - Chemists

Inspection, Tests, Analyses,
Research, Consultation
Structural Materials, Structures,
Equipment, Pipe, Soils

Associates

Los Angeles and Eastern Cities

Offices and Laboratories

651 Howard Street, San Francisco

A. F. MATTOCK CO.

Builders

★

212 CLARA STREET
SAN FRANCISCO

Index to Advertisers

* Indicates Alternate Months

ALADDIN Heating Corp.....	48
ANDERSON & Ringrose.....	47
ANGIER Sales Corporation.....	*
ARCHITECTS Reports.....	40
BASALT Rock Company.....	36
BAXTER & Company, J. H.....	34
BRAYER, George F.....	48
CASSERETO, John.....	47
CLARK, N., & Son.....	*
CLASSIFIED Advertising.....	43
CLINTON Construction Company.....	44
COLUMBIA Steel Co.....	*
COLOTYLE Corporation.....	*
CROCKER First National Bank.....	46
DINWIDDIE Construction Company.....	47
FORDERER Cornice Works.....	36
FORREST, Kyle.....	46
FULLER, W. P., Co.....	39
GUNN, Carl & Company.....	46
HANKS, Inc., Abbot A.....	48
HAWS Drinking Faucet Company.....	Back Cover
HERRICK Iron Works.....	47
HOGAN Lumber Company.....	44
HUNT, Robert W., Company.....	48
HUNTER, Thos. B.....	47
IMPERIAL Brass Manufacturing Co.....	*
INDEPENDENT Iron Works.....	48
JENSEN & Co., G. P. W.....	47
JOHNSON Company, S. T.....	40
JUDSON Pacific-Murphy Corp.....	36
KRAFTILE Company.....	7
KAWNEER Company.....	*
MALOTT & Peterson.....	44
MATTOCK, A. F.....	48
MULLEN Mfg. Co.....	47
MUELLER Brass Co.....	2
NORTHERN California Electrical Bureau.....	35
OWENS Corning Fiberglas Co.....	*
OWENS, Edward & Associates.....	46
PACIFIC Coast Gas Association.....	5
PACIFIC Manufacturing Company.....	45
PACIFIC Portland Cement Company.....	*
PARAMOUNT Built-in Fixture Co.....	*
PARKER, STEFFINS & PEARCE.....	1
PAYNE Furnace & Supply Co., Inc.....	33
PORTLAND Cement Association.....	*
REMILLARD-Dandini Co.....	48
REPUBLIC Steel Corporation.....	45
SANTA Maria Inn.....	44
SCOTT Co.....	46
SIMONDS Machinery Company.....	45
SISALKRAFT Company.....	36
SMITH, EMERY & Co.....	48
SMOOT-Holman Co.....	37
STANLEY Works, Inc., The.....	*
SOULE Steel Co.....	*
TIMBER Engineering Co., Inc.....	*
TORMEY Company, The.....	47
UTILITY Appliance Corp.....	31
U. S. STEEL Company Inside Back Cover	
VERMONT Marble Company.....	45
WESTERN Asbestos Company.....	Inside Front Cover
WOOD, E. K., Lumber Company.....	39

REMILLARD-DANDINI Co.

Brick and
Masonry Products

★

633 BRYANT ST., SAN FRANCISCO
569 THIRD ST., OAKLAND

A L A D D I N Heating Corp.

Specializing in
QUALITY HEATING
EQUIPMENT

2222 San Pablo Avenue
OAKLAND
TWInoaks 1022

ABBOT A. HANKS, INC. Engineers & Chemists

INSPECTING - TESTING - CONSULTING
CONCRETE • STEEL • MATERIALS
CHEMICAL AND TESTING
LABORATORIES

• RESEARCH AND INVESTIGATION •

TESTS OF STRUCTURAL MATERIALS
DESIGN OF CONCRETE MIXES
SHOP AND ERECTION INSPECTION OF
STRUCTURES AND EQUIPMENT
INVESTIGATION OF STRUCTURES
AND MATERIALS
TESTS AND INVESTIGATION OF
FOUNDATION SOILS
FIRE RESISTANCE AND INSULATION
TESTS

624 Sacramento Street, San Francisco

Robert W. Hunt Company ENGINEERS

Inspection - Tests - Consultation
Schools and Other Structures
Are Built as Designed

When Construction Materials are
Inspected at point of Manufacture
and during Erection by

ROBERT W. HUNT COMPANY

Cement, Concrete, Chemical, Metallurgical,
X-Ray and Physical Laboratories

Chicago - New York - Pittsburgh
Los Angeles - All Large Cities
San Francisco, 251 Kearny Street

ARCHITECT AND ENGINEER



NOVEMBER

1945

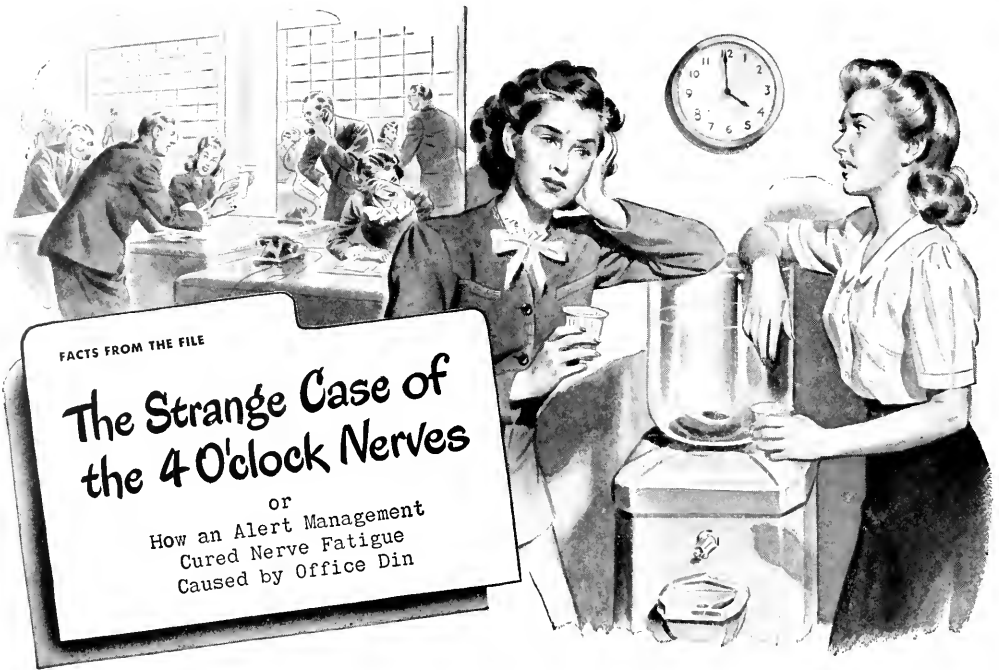

FACTS FROM THE FILE

The Strange Case of the 4 O'clock Nerves

or
How an Alert Management
Cured Nerve Fatigue
Caused by Office Din

THE COMPANY: Petri Wine Company, Famous California Wine Makers, San Francisco, Calif.

THE PROBLEM: Management noted that for some reason office personnel became overly tired in the late afternoon. This situation reduced efficiency, lowered morale and caused absenteeism. After careful study, Petri Wine Company executives found the cause to be the nerve-fraying din from many office machines, phones and conversation which was annoying and distracting everyone.

THE SOLUTION: A quick call went out to the leading authority on acoustical correction—Western Asbestos Co. This experienced sound conditioning organization soon worked out a solution. They advised covering the office ceiling with Acousti-Celotex—the famous perforated fibre tile and most widely used of acoustical materials.

THE RESULT: Says the company, "The change in our offices was actually startling. The sound conditioning installation has hushed the noise of machines, typewriters, phone bells and voices to where it's scarcely noticeable. Everyone notices the big improvement in efficiency, especially toward the end of the day."

Western Asbestos Co. offers a complete sound conditioning service . . . from design to completed installation. The counsel and recommendations of a sales engineer are at your service, entirely without obligation. FREE! Write for the informative booklet "Sound Conditioning for Office Workers."



★ ★ ★

WESTERN ASBESTOS CO.

DISTRIBUTORS • ENGINEERS • CONTRACTORS

ARCHITECT

Vol. 163

No. 2

AND ENGINEER

ARCHITECTS' REPORTS—Published Daily

Telephone DOuglas 8311

MARK DANIELS, A.I.A.
Editor

E. H. WILDER
Associate Editor

JOHN S. BOLLES, A.I.A.
Book Reviews

MICHAEL GOODMAN
Post-War Planning

L. H. NISHKIAN
Consulting Editor

E. N. KIERULFF*
Ass't Editor
*In the Service

Contents for



NOVEMBER

ARTICLES AND MISCELLANEOUS TEXT

RUNNING FIRE	4
By MARK DANIELS	
NEWS AND COMMENT ON ART	8
COVER PICTURE	9
TAYLOR'S INC., Detroit Auto Agency	9
THE CONSTRUCTION OUTLOOK	9
By MARDI	
LET'S BUILD A SWIMMING POOL	11
By EDWIN H. WILDER	
ACHIEVEMENT AND CHARM IN MEXICO	14
By WM. ARTHUR NEWMAN, Architect	
HEADLINE NEWS & VIEWS	23
By E. H. W.	
THE GARDEN AND THE HOUSE	24
By ALBERT WILSON, A.B., A.M., Garden Consultant	
THE HOME OF MR. AND MRS. SAMUEL TAYLOR, Los Angeles	26
RISLEY AND GOULD, Architects	
A.I.A. ACTIVITIES	31
WITH THE ENGINEERS	32
PRODUCERS' COUNCIL PAGE	38
ESTIMATOR'S GUIDE, Building and Construction Material	41
CLASSIFIED ADVERTISING	43
BOOK REVIEWS	44
By JOHN S. BOLLES, A.I.A.	
ADVERTISERS' INDEX	48



ARCHITECT AND ENGINEER (Established 1905) is published on the 15th of the month by The Architect and Engineer, Inc., 68 Post St., San Francisco 4; Telephone EXbrook 7182. President, K. P. Kierulff; Vice-President and Manager, L. B. Penhorwood; Treasurer, E. N. Kierulff, Advertising Manager, V. E. Atkinson, Jr.

Los Angeles Office: 403 W. 8th Street.

Entered as second class matter, November 2, 1905, at the Post Office in San Francisco, California, under the Act of March 3, 1879. Subscriptions United States and Pan America, \$3.00 a year; \$5.00 two years; foreign countries \$5.00 a year; single copy 50c. ARCHITECTS' REPORTS are published daily from this office, Vernon S. Yallop, Manager.



RUNNING FIRE — by MARK DANIELS

A REAL ANALYSIS OF THE HOUSING MARKET

As a supplement to the September issue of the Architectural Forum the publishers have brought out a study of the Housing Market that does the job. At last we have a careful analysis of the possibilities in the designing and building of residences in the United States for the next few years; not one based on wild guesses, or wishes that are so often "father to the thought," but one that is based on factual data gathered by personal interview. From this Forum Study there is much that can be learned by both the architect and the speculative builder.

The burden of the message is pointed for the contractor and builder but there are many details that can be gleaned throughout the well organized analysis that are of value to the architect, for this is about the first study with its feet on the ground, that has come to this office.

There are six items which are of particular value to the architect. They are based on the opinions as stated percentages of persons questioned, and might be listed as follows:

1. Price contemplated by the majority of prospects.
2. The style of architecture.
3. The building height. (Stories.)
4. The prospective client's reason for building.
5. Detail features wanted by the majority of clients.
6. Where most prospective clients are to be found.

An architect contemplating re-entering practice will naturally go, if he can, where he has the best opportunity to get clients and that is where there are the most of them. According to the Forum Study most good prospects will be found in the larger cities, cities of 100,000 and over, although cities of 2,500 to 100,000 population run a close second. One is surprised to find that only four per cent placed the modern style as their first choice and six per cent placed it as their second choice. This is not exactly a fair question until modern architecture is clearly defined, a definition for which I have waited, lo, these many years. Fifty-two per cent of the good prospects planned to keep the cost below \$6,000 while 18 per cent went up to \$10,000. There are those who feel that any one-story house is "modern" but I have seen many one-story shacks in Mexico that were far from "modern." Yet 55 per cent of those questioned wanted one-story houses. By the same token 58 per cent chose the "Cape Cod Type" which leads one to believe that they were a little hazy on that

type also. The list of "what they want" runs about the same as it has for the past few years with almost no mention of "dream house gadgets."

It is not practical to select certain ones of the tables in the Study and disregard the others. They are all inter-related and so well done that they should all be studied together. So, be sure to get the September issue of the Forum and be doubly sure that you get the supplement.

POST WAR WHAT?

In the good old American way we have fastened onto another phrase and, as usual, are working it to death. In this country we invent expressions so fast that they cease to function as cliches before they can get a good start on their careers as such. "Post War" is emphatically one of these. To use that expression to indicate that as soon as the war is over we shall carry out this or that project is logical enough when used in connection with economic conditions, but where we employ it as a description of a style of architecture we are giving in to a catch phrase. There may be a "Post War" walk, a "Post War" swimming stroke, a "Post War" surgery, but it is doubtful if the war will have brought any of them about. Every building has been "Post-some-war-or-another." To refer to activities such as building, legislation, new regulations, revised industry, as "Post War" plans is logical, for they represent work that was held up by that greatest of emergencies, WAR, but to name a style of architecture "Post War" is, to say the least, misleading. The dwellings of the immediate future will be organized substantially the same as for years past, with the possible exception of the barette, and even that may outlast the supplies necessary to make it useful.

WORTH REPEATING

It may look a little like turning the barrel over but I cannot resist repeating, in part, an item of Running Fire in the issue of December, 1942. The partial list of the alphabetical soup that seems to have been the source of the titles to those innumerable bureaus in Washington was all but interminable three years ago, but now it seems definitely so. To quote the item there then "A.D.P., W.P.B., C.A.A., M.E.W., F.S.A., C.I.A.A., B.E.W., I.M.M., C.O.M., B.R., B.P., B.F., J.S.M."—but why go on? Just turn to your file of RUNNING FIRE which, of course, you all keep, and you will get the start of the endless list, which by this time calls for a reference book about the size of a small dictionary.

DEPENDABLE



A
"PACIFIC
PRODUCT"

Produced by
**PACIFIC PORTLAND
CEMENT COMPANY**
San Francisco • Los Angeles
Portland

Sold by
**YOUR BUILDING
MATERIALS DEALER**

UNIFORM - TIME TESTED



Now - MATCH THEIR BEST WITH YOUR MOST IN THE VICTORY LOAN!

Top off your good work on your Payroll Savings Plan with an outstanding showing in the Victory Loan—our last all-out effort!

Help bring our boys back to the homes for which they



Sell the New F.D. Roosevelt Memorial \$200 Bond through your PAYROLL SAVINGS PLAN!

In rallies, interdepartmental contests, and solicitations, promote the new Franklin Delano Roosevelt Memorial \$200 Bond! Better than "cash in hand," Victory Bonds enable the buyers to build for the future—assure a needed nest egg for old age.

Keep on giving YOUR MOST to the Victory Loan! All Bond payroll deductions during November and De-

ceMBER—and give our wounded heroes the best of medical care—by backing the Victory Loan! You know your quota! You also know by past war-loan experience that your personal effort and plant solicitation are required to make your quota.

ember will be credited to your quota. Every Victory Bond is a "Thank You" to our battle-weary men overseas—also a definite aid in making their dreams of home come true! Get behind the Victory Loan to promote peacetime prosperity for our returning veterans, your nation, your employees-- and your own industry!

The Treasury Department acknowledges with appreciation the publication of this message by

ARCHITECT AND ENGINEER



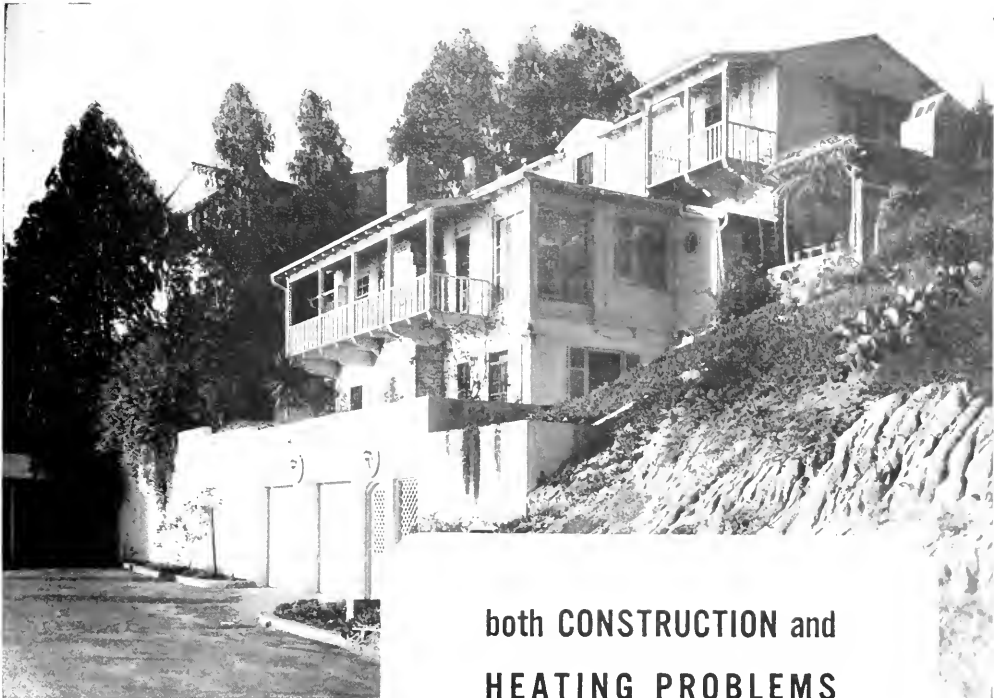

Residence, Mr. W. R. Brent
Laguna Beach, Calif.
Architect: Aubrey St. Clair
Builder: Smith Construction Co.

both CONSTRUCTION and
HEATING PROBLEMS
happily solved

Fitted "like a glove" to its sharply-sloping lot . . . designed to afford maximum enjoyment of a magnificent marine view . . . this seaside home is as comfortable *inside* as it is attractive *outside*. *A time-tested PAYNE gas-fired heating installation provides "zoned" comfort. Two PAYNE furnaces, plus smaller units, separately controlled, assure *flexibility* unobtainable with a single "central" furnace. *Consult a PAYNE Dealer or the Factory Engineering Department on *your* next job.

PAYNE FURNACE COMPANY
(One of the DRESSER Industries)
BEVERLY HILLS, CALIFORNIA



**INVESTIGATE PAYNE
ZONE - CONDITIONING**

Successor to old-fashioned central heating! Circulated winter warmth . . . cooling summer ventilation with forced-air models . . . *controlled by zones, rooms or apartments.*

*Zone-Conditioning Booklet
sent free on request*

PAYNEHEAT
OVER 30 YEARS OF LEADERSHIP



NEWS AND COMMENT ON ART

THE SAN FRANCISCO MUSEUM OF ART, at the Civic Center, is holding the sixty-fifth annual Exhibition of the San Francisco Art Association of Oil, Tempera on Panel and Sculpture, from November 1 to November 25. When you go to see this exhibition, make it a point this time to go to the Art Reference Library. It is located near the main entrance and contains many volumes, paintings and portfolios of the work of such artists as Gauguin, Beaudin, Pignon, Picasso and a host of other greats and moderns whose work is all too little known here in San Francisco.

The California Palace of the Legion of Honor in Lincoln Park will show the last motion picture produced in France, before the German occupation, at 2:30 P.M. on November 24th. It is with sound and entitled SCHUBERT'S SERENADE.

THE DE YOUNG MEMORIAL MUSEUM in Golden Gate Park has received an addition to its permanent collection in the form of a "view of Greenwood Lake, New Jersey," painted by Jasper Francis Cropsey. The painting was a gift from Mr. Gustav Epstein in memory of his wife, Jessica. The title of the painting is a bit trite, but the painting itself is emphatically the reverse. The reproduction in this issue is ample evidence of the beauty of Cropsey's work.

During November drawings by Charles Horton, a local artist, will also be on exhibition at the de Young, as will a collection of drawings and photographs of Modern Architecture in the Netherlands.

"VIEW OF GREENWOOD LAKE, N. J.



Jasper Francis Cropsey

De Young Memorial Museum

AUTHORITY STARTS POSTWAR SLUM-CLEARANCE PROGRAM

The prewar housing program, so long deferred by global war, will be immediately undertaken by this Authority in an all out peacetime effort to provide jobs, remove slums and construct permanent low-rent homes for eligible San Franciscans. This construction will substantially increase our postwar construction job stockpile.

The first project to be constructed in Chinatown will be known as "Ping-Yuen" or "Tranquil Gardens". Chinese living conditions in Chinatown are most serious and have been naturally aggravated by war shortages.

Architects Mark Daniels and Henry T. Howard, who prepared the plans for the project originally, have been reemployed to revise their plans, and to orientalize and embellish the exterior of the apartments. "Ping Yuen" must be truly representative of our Chinese war ally.

The Housing Authority has the complete cooperation of the Federal Public Housing Authority in processing this project. Jointly our efforts will be directed to send the plans to bids within 60 days. The project will be built progressively, the first contract calling for 60 dwelling units, and thereafter the entire 231 units will be progressively completed.

In general, the development will consist of three six-story buildings of modern, modified Chinese architecture. Elevators, community laundries, a health center, a nursery school, roof recreation areas and other playgrounds and gardens will serve the tenants.

STEVENS INSTITUTE WILL ERECT NEW FIELD HOUSE

The gift of a new field house to Stevens Institute of Technology, presented by the Charles Stewart Mott Foundation of Flint, Mich., to be known as "The Charles Stewart Mott Field House," was announced yesterday by Dr. Harvey N. Davis, President of the college. Mr. Mott, President of the Foundation, is a Director and former Vice President of General Motors Corporation, a pioneer in the automobile industry, and an alumnus and Trustee of Stevens.

Permission has been granted by the War Production Board to proceed with the building. Work will be started this fall and the building will be ready for use early next spring. The estimated cost is \$110,000. The architects are Voorhees, Walker, Foley, and Smith. The original design for the building was made by I. Howland Jones of Andrews, Jones, Biscoe and Whitmore.

ARCHITECT AND ENGINEER



DETROIT TO HOUSE AUTO AGENCY

A building mirroring new trends in commercial design and anticipating many features of comfortable post-war living is under construction in Detroit to house the complete "post-war car" and truck headquarters of Taylor's, Inc., a Dodge-Plymouth dealer.

The service building, 188 by 73 feet, was opened in 1945 to keep essential trucks and cars rolling, while the sales office and showrooms will be completed as soon as WPB regulations permit.

Slanting glass is used widely to prevent reflection. Heavy clear glass partitions and inslux glass blocks add to the appearance and provide daylight illumination.

When completed the new building will occupy 40,000 square feet and because of its location in the automobile production center of America will attract many thousands of visitors.

THE CONSTRUCTION OUTLOOK By MARDI

Some contractors feared that the cancellations and withdrawals of work by the government upon the cessation of hostilities would swamp those who were looking forward to the construction boom that was predicted but it does not seem to have worked out that way. On the contrary, the boom is on in full blast despite the cancellations.

A scanning of the daily issues of ARCHITECTS REPORTS, INC., shows that during the latter half of the month of August and part of the first half of September over \$33,000,000 worth of contracts were awarded in the northern part of the state, of which about \$7,000,000 were for business construction, \$2,500,000 for schools and \$4,000,000 for residential work, which last three items would not be affected by government cancellations. True, of the \$33,000,000 some \$19,000,000 was awarded for government contracts, including hospitals, but that

(See Next Page)

COVER PICTURE

The picture on the cover is a photograph by Roger Sturtevant of the sunny terrace commanding an unsurpassed view over Berkeley and San Francisco Bay through the Golden Gate. It forms a central motif of the main floor and garden plan of the residence of two well-known professional women—Miss Emily H. Huntington and Miss Dorothy Manners Williams. The house was designed by Henry H. Gutterson, Architect, and the garden by Geraldine Knight, Landscape Architect. Other pictures will be shown in next month's issue.

BETHLEHEM STEEL MILL DEPOT

Construction of Bethlehem Steel's new Mill Depot at Third and Mariposa Streets in San Francisco was started in October.

Twelve hundred tons of structural steel will be used in erecting the new steel products storage building which will require about four acres of floor space.

According to H. H. Fuller, Pacific Coast vice president of the company, a wide range of structural and merchant shapes will be stocked in the new building ready for shipment.

It is expected the new depot will be put into operation early in 1946.

OPENS DISTRICT OFFICE

The AMERICAN INSTITUTE OF STEEL CONSTRUCTION, INC., recently opened district offices at 120 Russ Building, San Francisco 4, California, in charge of Walter T. Norris, District Engineer.

Representing the structural steel fabrication industry, technical data and general information on the industry may be obtained through these offices.

Architect Sylvester A. Lesswing has moved from 314 Nye Street to 17 Hillcrest Drive in San Rafael, California.

THE CONSTRUCTION OUTLOOK

leaves the large balance of \$14,000,000 in awarded contracts for that short period. Nor does this include such large projects as the \$4,000,000 Apparel Building, designed by Architects J. Francis Ward and John S. Bolles whose plans are about completed. Several other projects are in the same category, although not so large, and they will swell the mountain of work to be done in the near future.

Lumber is beginning to roll, according to the National Lumber Manufacturers Association, and is being held up only when orders are in conflict with direct military orders which are being canceled on every side. This is reflected by the great increase in building permits which has nearly trebled in the last month.

To top all this the State Department of Public Works has released a tentative construction schedule for state buildings to be built in the postwar period under the supervision of the State Architect. It amounts to the staggering sum of \$121,163,457 and is broken down as follows:

DEPARTMENT OF INSTITUTIONS	\$51,943,019
DEPARTMENT OF EDUCATION	\$10,956,090
DEPARTMENT OF CORRECTION	\$21,476,727
YOUTH AUTHORITY	\$ 6,001,098
STATE BUILDINGS	\$14,350,000
STATE FAIR	\$ 2,173,850
PROGRAM PROJECTS NOT IN PROCESS OF PLANNING	\$10,845,670

A few of these projects have already been started.

From the above it is very apparent that any idleness there may be in the construction field will not be because there is nothing to do.

IT'S HERE

The flood of construction work that the ARCHITECT AND ENGINEER has been predicting for the past several months is upon us. The records of the past few weeks fully demonstrate that fact. Both Business and Residential construction have increased in amazing amounts, but the increase in residential work has far outstripped the already swollen business construction activities. Although the individual items in residential work have been comparatively small, the total of contracts has run into large figures. The records of "ARCHITECTS' REPORTS" show that the amounts of actual contract awards were about as follows:

FROM SEPT. 12 TO SEPT. 30, Incl., 19 Days—

Actual Contract Awards	Amount	Per Day
Business Construction	\$2,526,000	\$133,000
Residential Construction	\$ 946,000	\$ 50,740

FROM OCT. 1 TO OCT. 11, Incl., 11 Days—

Business Construction	\$2,389,000	\$217,200
-----------------------	-------------	-----------

Residential Construction \$2,021,000 \$184,000

During the same periods, the prospective work, jobs that have been ordered and are on the draughting boards, showed about \$2,000,000 for the last 19 days in September while in the first 11 days in October the amount ran to over \$10,000,000.

Nor do these figures include many of those large projects that have been announced for the immediate future, some of which have been partially started. A few of these are the Columbia Steel Company's \$25,000,000 development in Pittsburg, California, the Colgate-Palmolive - Peete \$1,000,000 building in Berkeley, the Western Crown Cork & Seal Co.'s factory expansion in San Francisco to cost about \$3,000,000, and about a dozen other projects to run in costs of \$500,000 to \$1,000,000.

These figures are for Northern California and are for private industry only. To arrive at anything like a picture of the possibilities in construction work it is necessary to take into consideration the State program for building and highway work, which will run into \$300,000,000 or more for postwar budgets, as well as the major municipal and county plans, but the figures given will suffice to show that there is an abundance of work in sight to employ all the labor we can get for some time to come. So, the problem has turned over; it is not the question of whether we will have enough work to employ the returning GI's, but how can we get them to take the work.

There has been some question about public work gobbling up all of the available labor. There is a plenty of private work and until public work pays labor at a higher rate than private there will be men to be had in both branches, if they are willing to work, but it is becoming doubtful whether men are willing, or want, to work for a price that any job can pay and break even.

CARNEGIE-ILLINOIS STEEL

Thomas J. Hilliard has been made vice president in charge of sales of the Carnegie-Illinois Steel Corporation. Succeeding him as general manager of sales will be J. Douglas Darby.

A. Paul Selby has been named assistant general manager of sales and Wesley C. Bobbitt promoted to manager of sales in Philadelphia.

SYNTHETIC RUBBER INSULATION

The United States Rubber Company has developed a synthetic rubber latex insulation for electrical and communication wire, which will find widespread use in postwar construction.

Highly resistant to oxygen ageing, it is not affected by exposure to metallic copper or copper salts, and shows resistance to mineral oils.



Photo: Paddock Engineering Co.

Let's Build A SWIMMING POOL

**Whether It Be Public or Private Certain Factors
Are Essential in Design and Construction**

By EDWIN H. WILDER

Entry of the United States into World War II definitely interrupted a rapidly expanding volume of swimming pool construction, particularly in the field of private pools where many home owners were adding the beauty and pleasures of an outdoor swimming pool to their home property.

Schools, clubs, municipalities and business institutions had also discovered numerous benefits accrued in having a modern swimming pool available.

After "Pearl Harbor" the vast physical education programs of the armed forces, involving a keen development of the physical and mental fitness of the individual to meet the rigors of combat life, plus competitive athletic contests in which large

groups participated, have developed a new national consciousness of athletic programs which is certain to be an important phase of postwar planning.

Evidence of this is manifest in the large number of school authorities and municipalities throughout the Pacific Slope States which have already included in their postwar construction program the building of a modern swimming pool.

Some school boards plan on making the facilities of the school district's swimming pool available to the use of the public during the non-school hours and during vacation periods.

Manufacturers of swimming pools and swimming pool equipment tell us that the number of

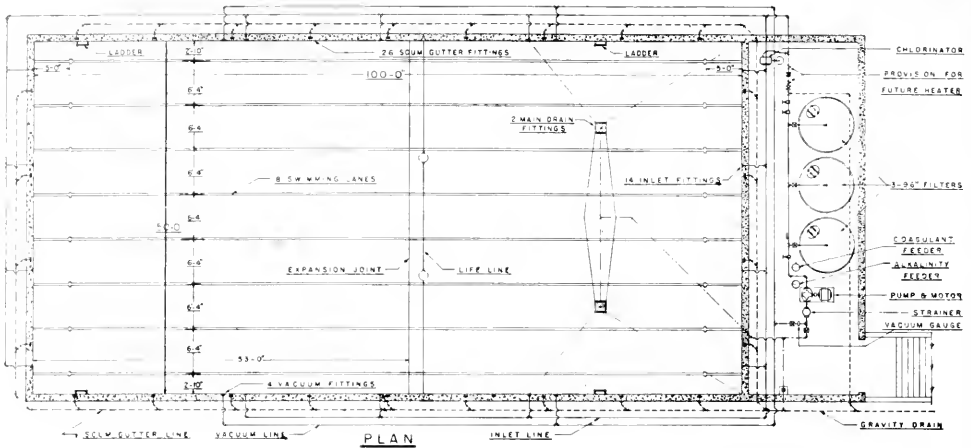

Designed by Paddock Engineering Co.

inquiries from private sources have already indicated a tremendous volume of business will develop as building materials and skilled workmen become available.

However, as the question of swimming pools can easily be divided into two major considerations, (a) the utility installation, and (b) the private home pool, it is our intention in this article to deal principally with the construction of larger size pools.

It is interesting to note, in studying this subject, that much has been learned during the war relative to use of materials and the cost of the private home pool today is relatively small as compared with prewar installations.

In considering the installation of a municipal pool there is always some particular local situation involved, therefore through the cooperation of the Joint Committee on bathing places of the American Public Health Association and Conference of State Sanitary Engineers, also through suggestion of authorities on swimming pool design, construction and maintenance from every part of the nation,

the term "Public Pool" now incorporates certain fundamentals as applied to swimming pools designed for municipal, institutional, therapeutic, club, hotel, apartment house and privately owned income use.

Among authorities consulted in determining these fundamentals were state and local public health officials, recreational directors and swimming coaches, including officers in charge of physical training programs for the Army and Navy, and the data secured has been checked against records of some 2000 artificial recirculation type pools constructed by the Paddock Engineering Company of Los Angeles and San Mateo over a twenty-year period.

It is universally agreed that the essential qualifications for a pool of the highest quality, which will be economical to construct and maintain, properly related to its proposed use, beautiful in appearance, insure physical safety, and embody all equipment necessary to maintain a high standard of pool sanitation, include the following factors.

Location

Convenience of access to existing or proposed dressing rooms is usually the first factor to be considered in establishing the location of the proposed pool, while other factors to be checked and determined include the question of (a) shelter from prevailing winds, (b) direction and amount of sunlight, (c) character of the soil to be excavated with particular reference to any existing fill or hard rock requiring blasting, (d) disposal of excavated material, (e) distance to utility connections including raw water, sewer or storm drain for waste water, electrical supply for motors and lights, and fuel supply for pool heating.

When it is proposed to house the water treatment plant and recirculating equipment in an

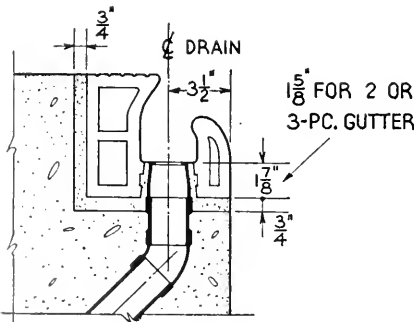

Designed by Kraffile Company

existing structure, the deep end of the pool should be located as short a distance away as possible. A distance of more than 40 feet from the deep end of the pool to the recirculating pump and motor usually necessitates an increase in pipe sizes and mechanical costs.

The relation to landscape is essential and extremely important when planning hotel, club, and resort installations.

Pool Structure

Almost 100 per cent of modern swimming pool structures are constructed of reinforced concrete, either form-poured, or pneumatically applied by the "Gunite" method. The pool should be rectangular in shape, in the great majority of cases, so that the full water area may be used for competitive events and water sports. Departures from this shape are sometimes dictated by special circumstances, but are not considered to be standard.

A national survey indicates the sunken pool is preferred by the great majority of users. However, an elevation from one to three feet above the natural grade provides for the economical disposal of much of the pool excavation and usually simplifies the problem of waste water disposal. In these instances, the slope away from the pool should be gradual rather than abrupt.

The size of the pool is directly related to the bathing load. Twenty-seven square feet of water area should be provided for each swimmer, and ten square feet for each non-swimmer using the pool under peak conditions. It is sometimes impossible to forecast the bathing load with any

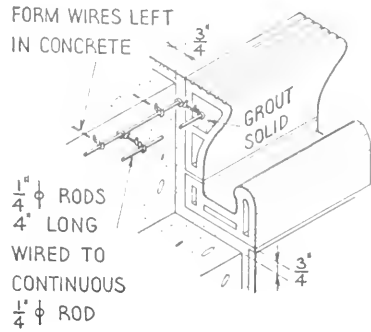

Designed by Kraffite Company

degree of accuracy, however, it may be noted that 20,000 square feet of water area, preferably divided into two or more pools, supplies first class facilities for a city of 100,000 population in mild climate areas. As the population of the district to be served becomes smaller the water area per unit of population should be somewhat increased, and districts with a population of 10,000 to 15,000 should provide approximately 3000 square feet of water area if possible.

A standard size pool is any pool 20 feet by 60 feet or larger, providing the width is increased in units of five feet and the length in units of fifteen feet. Or, the entire length may be measured in meters, 25 and 50 meter pools being the lengths most frequently used. An "Olympic Pool" is a 50 meter pool, usually 65 or 70 feet in width.

(See Page 33)

INVERTED DOME TYPE REINFORCED "GUNITED" POOL by Paddock Engineering Co.



Achievement and Charm in Mexico

By WM. ARTHUR NEWMAN, Architect

How many are familiar with the present status of an eighteen-story building that floats up and down, that can be tilted out of plumb, all in a few hours and returned to position again at the will of the engineer? This is probably the most interesting development in foundation engineering in the present age. The actual-size experiment is being watched closely by leaders of the profession in all parts of the world.

The amazing story of this, the Mexican Government's new National Lottery building in Mexico City, was related to me by Civil Engineer Jose A. Cuevas who designed the edifice now nearing completion to cost over \$1,000,000. It is indeed a remarkably bold and original piece of engineering.

Senor Cuevas is a former Director in charge of

the School of Engineering of the National University of Mexico, a well-known author and lecturer on engineering and architectural engineering, president of the Y.M.C.A., and former president of the Asociacion de Ingenieros y Arquitectos de Mexico.

For the architect and engineer, soil conditions in the business district of Mexico City are considered more difficult than in any other large city in the world. This Capital has been constructed over a former lake, which has been drained, and it is not surprising that there is shrinkage, consolidation of the soil and general settlement, including much of the valley, as pumping of water proceeds. In fact, most of the city is subsiding at the astonishing rate of eight inches a year. Even buildings as old as 400 years are still settling. The Lottery Building is located at the intersection of Paseo de la Reforma and Avenida Juarez, and is surrounded by streets on all sides. It is designed as an office building with an auditorium for drawings of Loteria Nacional.

On the main front the tower rises eighteen stories above the basement and sub-basement. The auditorium at the rear is only one story in height. This building has part steel and part reinforced concrete frame construction with reinforced concrete floors and walls. The foundation is reinforced concrete, divided into two large trussed and ballasted caissons, with a bridge tying them together, connecting the tower with the auditorium.

The soil to a depth of eight feet below street grade is an alluvial granular material. Below this for an additional twenty-two feet is a porous jelly-like slippery clay. From that point to a depth of several hundred feet there is a muddy gruel composed of 93% water and 7% solid matter by volume, interspersed at considerable intervals with thin irregular layers of clay, sand or gravel.



Combined Hotel, Office Building, Apartment
and Theater Project for Mexico City, D.F.

Designed by CARLOS LAGO, JR., Architect

"EDIFICIO
AVENIDA"

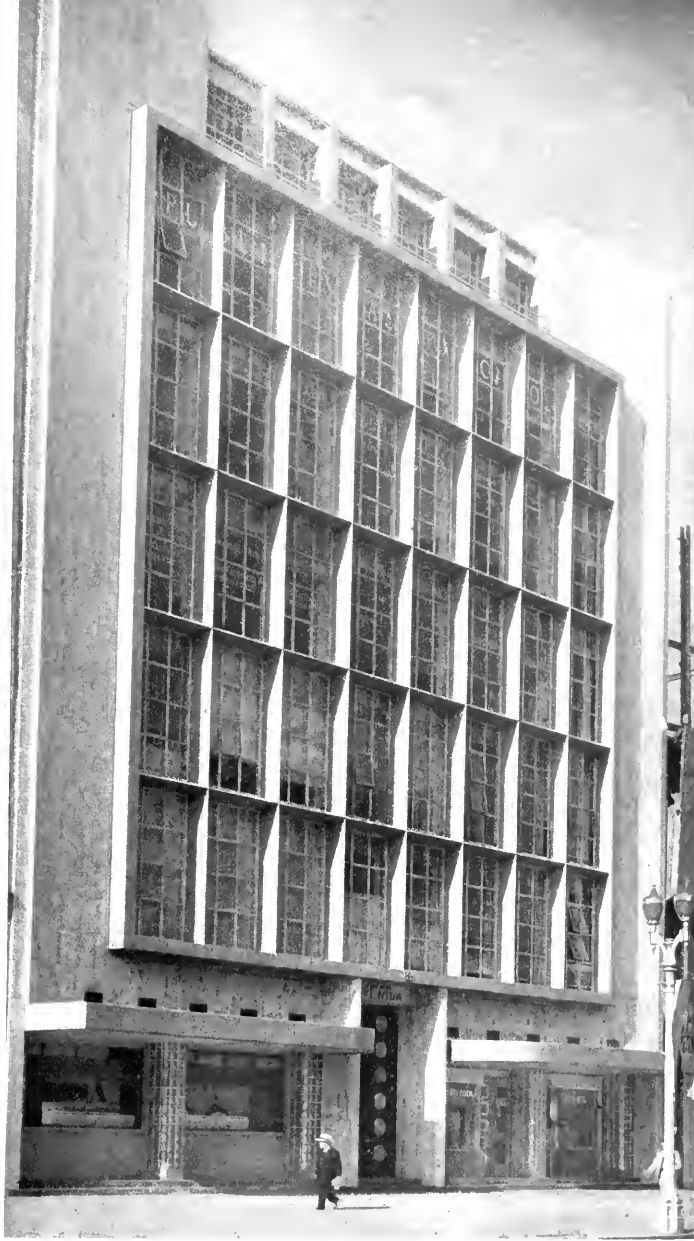

... is truly
modern
Mexico City

Tests in this section of the city indicate that when soil is removed for an excavation, pressure causes an upheaval of the bottom, as the water level is but five feet below street grade. When an applied load is heavier than the material removed, settlement occurs.

It has been Senor Cuevas' theory that a satisfactory foundation could be constructed by removing as much weight of soil as was added by

the weight of the building.

As a delegate from Mexico to the First International Conference on Soil Mechanics and Foundation Engineering held at Harvard University several years ago, he presented a paper on the contemplated foundation for this building to some 400 specialists from all parts of the world.

They could hardly believe the foundation soil was so unfavorable, or that he could control the



Corridors in Casa del Alfenique

Puebla, Mexico

position of the building as he has been able to do.

His control is exercised by removing, adding to, or transferring ballast in the foundation caissons. This ballast is both liquid and solid. Accurate check-ups and measurements are carefully recorded at frequent intervals.

I was delighted to accept Senor Cuevas' invitation to accompany him on an inspection of this edifice, which weighs as much as a battleship, and see how he demonstrates that it is actually floating. With the available materials at hand, in forty-eight hours he has been able to raise this building one-half inch and tilt it two inches in the direction he pleases, returning it again to its original position when he so desires. Few persons have ever witnessed such a demonstration, or believed it to be possible.

Near the Lottery Building is Edificio Avenida on Avenida Juarez — another new office building in Mexico City which indicates one of the present trends in architectural design. It is faced with cream Travertine brought from Peru.

Three blocks distant is the four-story Fire Department building on Calle Independencia which has attracted my attention because of the two large bas-reliefs carved out of dark volcanic stone on the exterior walls at the street intersection. If these depict the gods of Fire and Water, they are among the best examples of the Aztec tradition in a modern building in the capital.

While continuing my stroll along Paseo de la Reforma, I found Architect Carlos Lazo, Jr., viewing the third story columns as they were being poured for the hotel section of the new \$5,000,000



Casa del Alfenique

Puebla, Mexico

hotel, office building and apartment building designed, the first of its kind in Mexico.

This project consists of a group of modern buildings of sixteen stories and a new municipal theater. The first unit now under construction is a hotel, shown on the left of the plan, on the right is an office building, and to the rear is an apartment building. Behind the apartment building will be a theater.

On the ground floor are placed three arcades which extend to the rear, and to the theater. In the basement provision is made for hotel service, automobile parking, etc.

Foundation for the hotel consists of 90 foot to 100 foot wood piles supporting a reinforced concrete pan and the superstructure.

Carlos Lazo, Jr., is one of the busy, younger members of the profession. As heretofore noted in this series, he won the competition for the Delano & Aldrich scholarship, under the auspices of the American Institute of Architects in 1942. In his travel and study in eastern and middle-western states, he was shown every courtesy by the leading universities and the many architects he contacted. His greatest interest was in American national and regional planning, modern housing, new materials, industrial construction and the Tennessee Valley project. As Mexico City has many buildings over 300 years old, he was not so impressed when shown one of the oldest buildings in New York, 200 years old, but to the astonishment of his escort, when he saw the structure of a main gas holder projecting high above the rear of this building, he was at once interested, for no such structure exists in Mexico.

As a result of this scholarship he became better acquainted with American ideals and progress in architecture and engineering, returning to Mexico with his automobile full of technical books and papers.

He expects in the future, when his finances permit, to return the cost of his scholarship to the American Institute of Architects, to arrange a scholarship for an American student to come to Mexico to study the real Mexico and its problems.

While he has already designed some interesting commercial and residential buildings, Carlos Lazo's ambition is city, regional and national planning. He has the commission for city planning of the City of Tampico, and is now developing plans for various districts in the City of Monterrey.

During the past two years he has made a study of the country as a whole, which is of real importance in the planning of future Government appropriations for important improvements. Using dozens of topographical maps he has divided the country into zones or territories, delineating among



Modern Fire Department Building

Mexico City, D.F.



PICTURESQUE MONUMENT to Morelos erected on the Island of Janitzio in Lake Patzcuaro, Mexico, is an interesting sight to see.

other things its general appearance, livestock sections, agricultural resources, industries, population density, communications, factory people (who speak Spanish), architecture, economic conditions, consumption, future possibilities, political divisions, etc. He extends his exchange information with Americans along similar lines.

The experienced city planner has the obligation to correct the mistakes of authorities of the past who governed the country. You will notice there is a certain uniformity in all Latin American cities, this is due to the order of Carlos V. of Spain who standardized city planning. In the center of cities he required a plaza, around which were to be grouped the Palacio municipal, or city hall, any other governmental buildings, the church and the market place. From this center rectangular blocks and rather narrow streets were laid out for business and residential purposes, following the Spanish tradition. Corrections necessary in planning for the needs of modern cities today are oftentimes found to be expensive.

In a glorieta, or circle, at the wooded main entrance to Chapultepec Park is the new Fountain of Diana, as you recall, was the Roman goddess of groves, and she is found here as the bronze guardian of the grove of ahuehuete trees



GASOLINE STATION Mexico City, D.F.
Guzman photo

grouped along the way to the castle. At night the waters of this fountain are beautifully illuminated with changing colored flood lights for the enjoyment of all.

Chapultepec Park has many points of interest for the architect. Even larger than Golden Gate Park, it has been termed one of the most beautiful in the world. The Aztecs first used it as an army post; later it became a pleasure park. On Sundays crowds congregate to hear the band concerts, to view the zoo, enjoy the children's playgrounds, to take a boat ride on the lake or picnic in the



THE CASTILLO DEL ADVINO

Yucatan, Mexico

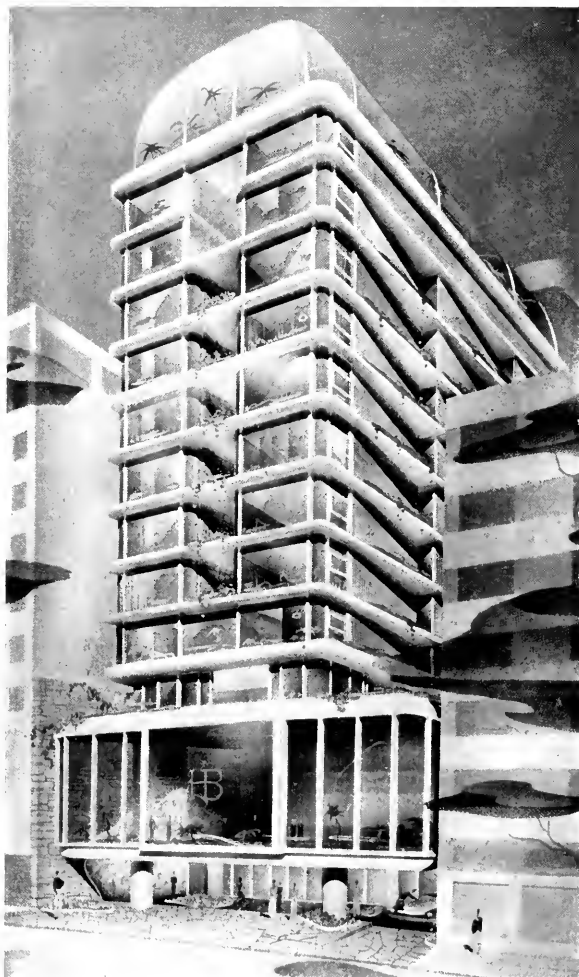

Perspective of New Hotel Under Construction in Mexico City, D.F. It is the first unit of a \$5,000,000 project designed by Carlos Lago, Jr., Architect.

meadows. Near the great conservatory is the celebrated Frog Fountain, of many colored glazed tiles. Not far from the baseball green is a grove of giant trees in which are quiet walks. Near the intersection of two—Calzado de Los Filósofos and Calzada de Los Artistas—is the unique Fountain of Don Quixote, surrounded by a tile platform and four seats. On the back of each of the seats are forty-two glazed tiles, depicting in color different scenes taken from the novel "Don Quixote." A small statue of the Don may be seen on one of the posts.

Just as the people of the United States appreciate the Statue of Liberty, so Mexicans are justly proud of their great Statue of Morelos, who was one of the outstanding heroes of Mexican independence.

This statue is approximately 150 feet in height, located on top of the picturesque Island of Janitzio in Lake Patzcuaro.

Visitors may ascend the stair inside to the up-held arm, for a magnificent view of this lovely lake, the surrounding towns and mountains. The interior concrete walls of the statue are decorated with life size frescoes of incidents in the life of Morelos.

From time immemorial the inhabitants of Mexico have been great lovers of flowers, and centuries before the Spaniards came it was customary each year to hold a festival called the Fiesta de los Flores, as depicted in the mural painting, illustrating the artist's reconstructed Temple of Xochicalco. Processions would form with chiefs and



FROG FOUNTAIN in Chapultepec Park, Mexico City, D.F.

nobles in full regalia carrying offerings of flowers and fruits to the god, accompanied by soldiers marching to the beat of drums, the sound of horns and gourd rattles in the hands of dancing men dressed in leopard skins. Fires alongside the god and on top of the pyramidal temple were kept burning as the festivities proceeded. This small pyramid was constructed over a thousand years ago; the stonework remaining today is well preserved, with excellent bas-reliefs of Toltec and

Mayan sculpture carved on its four sides.

Another small pyramid with a temple at the top, still in good condition is that of Castillo del Advino in Yucatan, Mexico, and is an interesting example of Mayan architecture and engineering of the pre-Columbian era.

Cuernavaca is the delightful little capital of the State of Morelos, fifty miles from Mexico City, where many wealthy families live. One of the recently constructed week-end houses there was



One of Mexico City's Prettiest Is the "Fountain of Diana"



DON QUIXOTE FOUNTAIN in Chapultepec Park, Mexico City

designed by Architect Enrique del Moral. It contains a living-dining room, kitchen, reception room or office, owner's and guest's bedrooms with separate baths, garage, two maids' rooms and watchman's quarters, and was completed at a cost of \$12,000.

Senor del Moral has recently been appointed Director, in charge of the National School of Architecture in Mexico City, which has 385 students enrolled. This school was formerly the Academy of San Carlos, founded in 1791, making it, I believe the oldest architectural school in the Americas. It has numbered among its faculty many of the outstanding architects, sculptors and painters in this country.

A five-year course in architecture is required, followed by six months of post-graduate work, in order to entitle the student to receive his diploma as an architect. This diploma must then be registered in Departamento Central before the architect begins practice. This Departamento has authority to revoke the license for unethical practices.

In the Federal District, in which Mexico City is located, the law requires all plans must be signed by a registered architect or engineer. Architects' fees for professional services have been altogether too low here to enable them to maintain the standard of excellence in the profession, and for the protection of the public. For instance, fees agreed upon with the Hospital Planning Committee are 4 per cent including cost of the superintendent of construction. If the work is less than one million pesos (\$200,000), the Public Health Department pays the superintendent.

One of the latest Pemex gasoline stations is in Lomas-Chapultepec district in the center of a glorieta on Avenida Reforma, constructed of buff volcanic stone, with a large open skylight which gives excellent observation during the servicing of cars.

Among the many beautiful homes in Puebla, capital of the same State, is the 17th century mansion, the Casa del Alfenique, in the Spanish Colony. (See Page 39)

Week-End House in Cuernavaca, Mexico

Enrique del Moral, Architect



CENTRAL VALLEY PROJECT IRRIGATION WATER CONTRACT IS SIGNED

The first long-term water contract for irrigation on the Central Valley Project, now being built by the U. S. Bureau of Reclamation in California, was approved as to form by Secretary of the Interior Harold L. Ickes and is expected to be signed soon at Delano by the directors of the Southern San Joaquin Municipal Utility District.

The contract sets forth the terms under which the Bureau will deliver water from the Friant-Kern Canal for the irrigation of highly productive but inadequately watered lands in the San Joaquin Valley.

"This contract is a milestone in the practical development of the Central Valley Project, being the first of its type negotiated by the Bureau of Reclamation," Secretary Ickes said. "It paves the way for similar contracts to be entered into with other districts in the Central Valley Project. About a dozen other districts in the San Joaquin Valley are preparing to negotiate similar water contracts."

The term of the contract, which was recommended by Commissioner Harry W. Bashore, could extend from the date of its execution for a period of thirty-nine years after the year of initial delivery of water, but could be reduced to a period less than that time in the final negotiations with the District. The Government would be obligated to deliver, and the District receive and pay for 67,000 acre-feet of firm or class 1 water each year. This amount could be increased to 91,000 acre-feet upon action taken by the District within the first fifteen years. In addition to this, the District would receive, to the extent that such water might be available, up to 33,000 acre-feet of class 2 water or 4.5 per cent of the total delivered into the Friant-Kern Canal during the year, whichever is less, but would not be required to take more than 4,700 acre-feet in any one month.

Rates for each class of water would be determined and announced yearly as approved by the Secretary. They would range within a maximum rate of \$3.50 per acre-foot for class 1 water and \$1.50 per acre-foot for class 2 water.

ENAMELER'S CLUB ELECTS

Nathan R. Klein, Caloric Gas Stove Works, was recently elected president of the Eastern Enameler's Club at a postwar organization meeting in Philadelphia. Fred Campbell, American Rolling Mills, was named vice president; J. J. Larduskey, Baltimore Porcelain Steel, secretary; and Dr. George H. Spencer-Strong of Pemco Corporation was chosen treasurer. It was the first meeting of the group since the war started.

HEADLINE NEWS & VIEWS

By E. H. W.

Private enterprise and competition made the great bulk of the nation's postwar housing program variously estimated at a million to a million and a half new houses a year for ten years in the belief of Raymond M. Foley, Commissioner Federal Housing Administration.

Early relief for the home building market, long starved of lumber by military necessity, is predicted by Henry Bahr, director of economic and statistical services of the National Lumber Manufacturers Association.

Bahr declares that more than 80 per cent of current lumber production is now going into civilian channels.

Removal of WPB War Conservation Order L-41, makes it possible for home construction to proceed on a peacetime basis, as far as the Government is concerned.

Recommendations based on more than a year's study by 35 leading engineering and technological specialists have been incorporated in a program for control of German industry to prevent rearmament. The plan has been submitted through the National Engineers Committee to State, War and Navy Departments, and to Foreign Economic Administration and authorities in American occupied zone in Germany.

The Office of War Mobilization and Reconversion has been informed by George T. Gerlinger of Portland, Oregon, president of the NLMA, that home and farm construction will be supplied between five and six billion board feet of lumber during the last quarter of this year.

Relaxation of Federal Reserve Board Regulation "W," will enable home owners to repair and modernize their properties on financial terms available to them before the war.

The Chicago Tribune is offering \$24,000 in cash, comprising 24 awards of \$1000 cash each, in a program to encourage better home designs; to help launch America's building revival, and to create more jobs. Entries are open and consist of simple floor plans, perspective, two elevations, and a minimum of detail. No specifications or working drawings are required. Deadline is December 8, 1945.

(See Page 43)

The Garden and The House

By ALBERT WILSON, A.B., A.M.

Garden Consultant

As everyone knows, the house and the garden belong to a common design. Simple common sense teaches that neither house nor garden can be made to obey first one principle and then another; they must be single in their purpose. But too often when all is done they, and even individual items, assume independence and walk off in divergent directions. Why is this?

For one thing, people quit the design for the oddity. They want something to show off to their neighbors. They yearn for a cupola-den that will smell of manly leather like the master's study in the novel. But it won't work. The present volcanic interest in barbecue pits, for example, will go the way of miniature golf; the monumental rock-pile, disused, will grow into a mere obstruction. If the story book fancies still require such feeble and dogmatic imitations of campfire cookery, they will be satisfied by a metal pit, on wheels, which can be moved to fit season and wind current, and then happily hidden away. And it is the same with the plants. People in their innocence cherish a specimen, greener, or bigger, or queerer than anyone else's. Plants are naturally loose, compact, upright, sprawling, prostrate, or clinging, and with well-considered exceptions, should be adopted for their natural functions. They may not be coaxed, bent, or tortured into strange positions, nor, when they belong in a group, marched out to stand alone. So used, they serve for neither beauty nor for use, and they will not endure. There is no finer folly. The oddity is the salesman's and customer's degenerate love, and should be resisted to the death.

Another cause of disunity is that people, including the designers themselves, start out with a prejudice. Perhaps it is a matter of the names, **garden** and **house**. Perhaps it is a tug-of-war between professional personalities. More rational and adult moods will accept the old art-principle that composition is sovereign. Everyone concerned will have to grant that the house gains value from the garden and the garden from the house, just as one color does from another. The garden vitalizes and lifts the house from dead lumber, plaster, brick, glass, and paint. It enriches the

architecture through the movement of seasonal growth, foliage, and living jewels. It clothes nakedness. It ties the house to the ground, by its walls, walks, and terraces. The garden is more than a pleasing space out-of-doors, or a link between the house and the street; it is another room, or series of rooms. Its planting line should combine with the house line. The tall building may be both supported and adorned by plants whose natural growth follows the perpendicular. Strong corners may be fretted with strong conifers. The piece of beauty is the whole design. The gardener must understand and help to create the picture ideal of the house, the purpose of its lines. If he fails in this, he will merely confuse and despoil.

In the co-partnership, moreover, plants not only enhance or build up, they can subjugate and soften. They conduct mechanical lines off into the ground, subdue perpendicular lines, and erase base lines and sharp edges. They even blot features out. Natural bulk and varying shades of green by contrast shift the attention to a new center. A low, rambling house is shrouded with loose or low growth which raises it. Plants are placed to command or to distract, as at the house corner, at the entry, or at the conjunction of walks.

Still another cause of disunity is that people do not know their plants, nor what their paltry saplings, cuttings, and seedlings will become. Just as the sculptor must see his figure in the stone, so must the designer possess a space-vision of house and garden 10 years hence.

Trees enter every phase. They frame the picture, focus attention on the distant view. They create vistas, they develop either the formal or informal effect. Selections are made for scale and proportion, sun and dappled shade.

Conifers are particularly resourceful; they accept almost any growing condition. Cedars, for instance, spire skyward, while their sweeping lower branches tie into the plan. Their use is best in the large scale. The pine and fir make background screens. Firs are often planted as specimens. But in general conifers are the bulwark of stability because their evergreen foliage is secure in winter and in summer. In foundation

planting they serve as anchors and hold things out especially well the lines of the California landscape. Among the most useful are: Indian cypress, Mount Atlas cedar, Lawson cypress and its variety, incense cedar, redwood, plume cypress, huoki cypress, retinospora, fir, Chinese fir, arbor vitae, and the upright and prostrate junipers.

Trees whose scaffolds of upraised branches support a great rounded head of twigs and leaves are a natural, often dominating feature. Such is the massive oak, the stalwart of the California landscape, especially the evergreen or California live oak, and the deciduous, or California Valley white oak. These trees often draw the eye in the perspective view. Other massive-headed trees are the tulip from the Mississippi Valley, the evergreen magnolia, the honey-perfumed linden, the stately maple, the princess-tree, the catalpa with the heart-shaped leaves, the pepper festooned with shining red berries, the busy mulberry, the St. John's bread, the aristocratic beech, the wide-leaved fig, and the grey-leaved olive.

A shutter tree to provide shade in summer and sun in winter is the plane, or sycamore. Old natives are often noble specimens; the cultivated forms soon grow to make their own smaller effect. But for some tastes the penalty of falling leaves might give pause. Other trees, interesting through foliage or bark, and affording a translucent screen against the hot sun, are the Maiden hair, the delicate birch, the liquidambar, or sweet gum, jacaranda of feathery foliage and blue blossoms, silk oak, Washington thorn, cocks-spur thorn, chestnut, and the deciduous magnolia throwing cup-like blooms. The orange and the grape-fruit, which in time grow to cast shade, are best in the open position, never against the building. They become bulging masses of dark foliage lighted up with golden fruits. Lemons cannot be included here for too often their foliage is yellow, or their branches naked.

Of the flowering shrubs California has an abundance to select from, and the cry now is for the evergreens. Those that are broadleaved certainly deserve their place in the foundation planting. But the deciduous forms must not be excluded. It is in them that the seasons become eventful. Among the heavy evergreens they lighten the effect, they proclaim spring, summer and winter. Well placed their naked winter branches are scarcely seen, and with spring's arrival the flower and leaf buds unfold happily. For color and life, barberry, dogwood, mock-orange, forsythea, lilac, quince, weigellia, golden chain, and spirea offer vivid, delightful blooms.

Climbing vines lend not only cover and color but romance that is like a perfume. They possess grace, give to the garden a luxuriance of growth

and awake imagination. Bougainvillea, wistaria, bignonia, ivy, creeping fig, and Virginia creepers can cover any wall space. Jasmine, honeysuckle, grapes, and Clematis, covering less space, have no less interest and color. The climbing rose, a plant that asks for little but gives much is the "queen of flowers", a perennial bloomer, and always the favorite. But even the most beautiful vine can become a "parasite" and kill the wall. The gardener must never forget that a vine which grows sparingly, reflecting root struggle for anchorage, will never cheat a wall of its character, nor take away the charm of changing shadows upon its surface. Nor must he fail, if the growth is too rampant, to cut back with ruthless persistence and energy.

Unity is contrived not only by plants but also by forms transitional between house and garden, such as walks, steps, terraces, sun-dials, fountains, bird baths, benches, pergolas, arbors, urns, and potted plants. But lest they creep in as pests, these need especially the force of design. The danger is that the Italian urn, or whistling poolboy, or even the terraced wall, may show up with no regard for climate, or setting, or for delightful combinations in which, by long use, they have been developed in their original cultural habitats. Nature and long custom are the great architects which must not be forgotten.

But fear of abuse is no reason for non-use. The real Spanish or Italian garden is exciting and lovely because it is exquisitely adapted to living and to the familiar, much loved, domestic scene. Everything serves in the happy home life, nothing is overdone, all fits, all adds charm and dignity. Terraces are theatres of activity. Steps and potted plants invite movement; paths suggest something beyond, leading away from house to garden or from garden to house. The materials possess hidden character, and beauty is unlocked when they are surfaced and worked. Stone is a natural ingredient for both house and garden. Cement that looks like stone is not much better than wood that looks like marble. But whatever the material, and however it is used, naked stairways, walls, and pools emerge like the horror of exhumed, gray bones. They must be made to look as though they belonged there. The gardener plies his art for the illusion of dell and nook.

In summary, when house-garden design goes six ways at once, or even two, it will wreck itself. In all humility, the writer offers what everyone knows—that the elements of the design must be combined to travel, not always with equal steps, but together and toward the same direction. The causes of disunity can be discovered, and the overwhelming rewards of unity put in command.

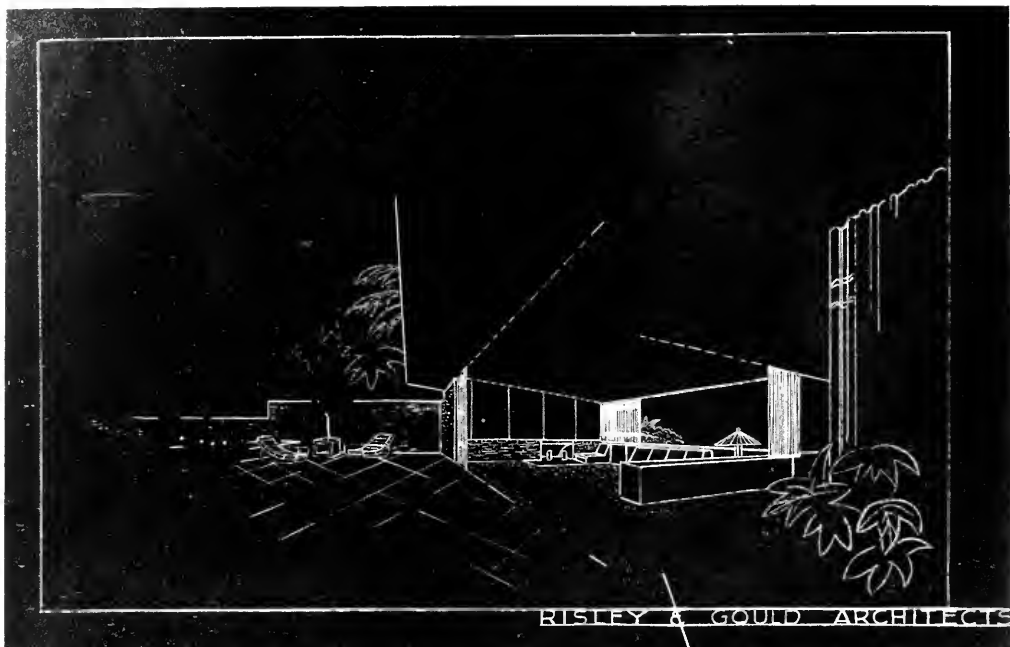

THE HOME

of Mr. and Mrs. Samuel Taylor, Los Angeles

RISLEY AND GOULD — Architects



REAR ELEVATION



FRONT ELEVATION
RISLEY & GOULD ARCHITECTS

ELEVATIONS OF THE TAYLOR HOME

ARCHITECT AND ENGINEER

**THE
TAYLOR
HOME
PLAN**

RISLEY & GOULD
Architects

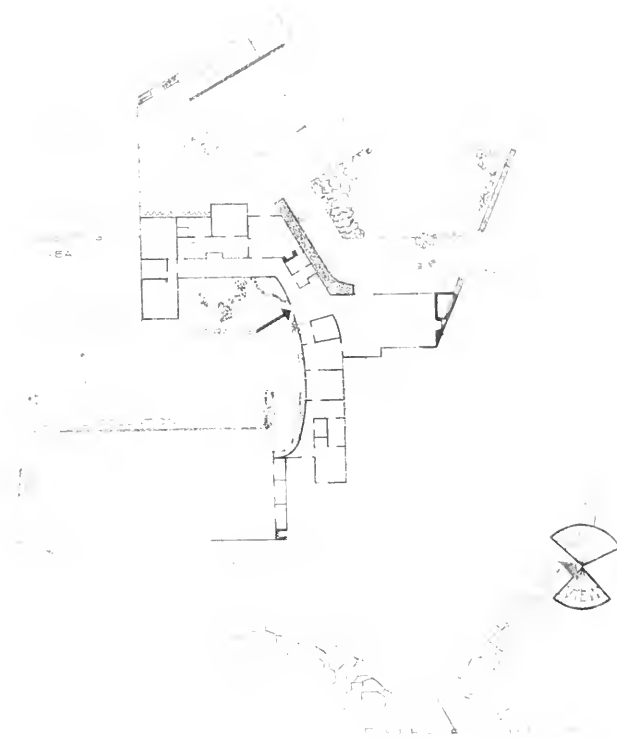

Site

The building site is on the crown of a hill, overlooking the distant mountains on the north and Los Angeles on the south. An electric high power tower, with looping wires, is situated on the eastern edge of the property. This factor largely influenced the plan, as it was felt desirable to blot out this unsightly structure by means of blank walls and planting.

Orientation

The house was oriented to take advantage of the fine mountain view and to have outdoor recreation areas protected by the house against the prevailing winds. All rooms have sunny double exposures, and all rooms except service and one bedroom have the mountain view.

The Plan

The design expresses the idea of a home designed for modern day needs, free from the limitations of traditional styles, and tailored to best fit the needs of its owners. Inasmuch as they may entertain much traveled and somewhat sophisticated people, it was thought desirable to introduce a rather dramatic approach. Thus, as one leaves the car porte, the approach to the front door is by way of a wide covered terrace flanked by lawn, flowers and vines. As one steps through the entrance, the full expanse of the mountain view bursts upon the visitor. On the right is the living room and a dining alcove with double exposures to both view and sun. To the left is the powder room, lavatory and gallery, study and

sleeping rooms. The study is easily accessible to the entrance.

To the right of the entrance is the telephone and room for mechanical equipment. The kitchen is screened from the living portion of the house by the pantry and breakfast room. Service from the street is through the service yard behind the car porte. The maid's room is conveniently located so that she may enter from the street, and has double exposure and sunshine to make hers a livable room. The bath is available from both her room and the service porch.

Recreation Area

The terrace outside the living room has a wide overhanging roof, so that porch furniture may be drawn in out of the weather. The swimming pool is an integral part of the plan. It is screened from the prevailing winds by a glass screen on the west side. It also has a covered porch with a barbecue. The long blank wall facing the pool might well be covered with a bold mural painted with a few firm brush strokes. A bit of lawn and planting helps to keep this portion of the terrace from becoming cold and stiff.

Landscaping

The landscape work was kept simple to reduce maintenance and consists of two lawn areas and planting. The balance of the property could be kept almost natural with ground cover and possible fruit trees. The long line of grass at the entrance side would be flanked by groups of native sycamores. Flower beds and shrubbery are located where they will be most effective in creating livable and pleasing situations.

APPOINTED MANAGER

Ken Winebrenner has been named manager of the Construction Industries Committee of the Los Angeles Chamber of Commerce.

The Committee proposes to: develop jobs for displaced warplant workers and returned veterans; relieve housing shortage by construction of homes; advance the county's construction industry, and stimulate construction activities in general.

LIGHTING EXPOSITION

Bringing together a representative cross-section of the combined talents of the lighting fixture and portable lamp industries, a 5-day lighting exposition will be held in the 17th Regiment Armory in New York City, starting November 26.

Designed to present postwar thinking and trends of the fixture and lamp industries for mass acceptance of buyers and users throughout the nation the event, which is called "The Victory Lighting Jubilee," is being sponsored by GENERAL ELECTRIC, Lamp Department.

LANDSCAPE ARCHITECTURE

Douglas Baylis is opening his office for the practice of landscape architecture at 619 Washington Street, San Francisco.

Mr. Baylis, who worked in several local landscape offices after graduation from the University of California, has been Landscape Architect for the Housing Authority of the City and County of San Francisco during the past two years.

MONARCH LINE CHANGES

The well-known MONARCH line of builders finish hardware has been added to the products made by the CLAYTON & LAMBERT MANUFACTURING CO., according to a recent announcement by Charles E. Lambert, president.

The line includes panic exit devices, sash centers, push and pull bars, kick plates, and associated items.

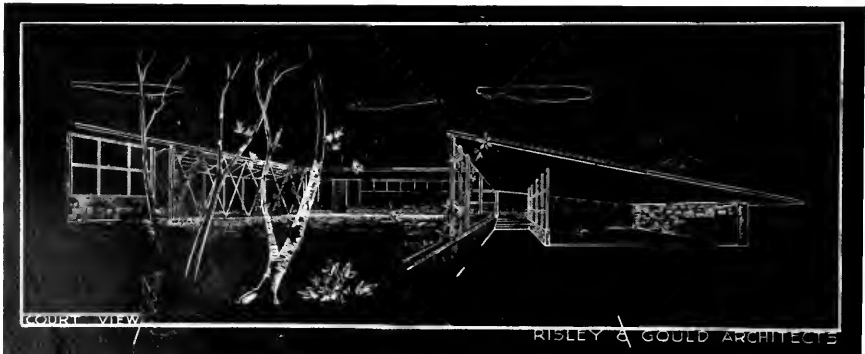

IN THE NEWS

GETS U. S. CHAMBER APPOINTMENT

Kenneth Campbell, manager of the World Trade Department of the San Francisco Chamber of Commerce, has been appointed manager of the Foreign Commerce Department, Chamber of Commerce of the United States in Washington, D. C., succeeding Edward L. Bacher, resigned.

Campbell is well known in foreign trade circles, having served as director of the Foreign Department of the National Association of Credit Men, chief of the Board of Economic Warfare's Exporters'

IMPROVED FOAMGLAS

Several improvements in cellular glass insulation have recently been made by the PITTSBURGH CORNING CORP., Pittsburgh, Pa.

One change increases the number of cells per cubic foot from 5,000,000 to 10,000,000 thus providing additional thermal protection, making it particularly adaptable for use in industrial buildings and equipment.

ALL-STEEL CONVEYOR

A new all-steel conveyor belt made up of a series of steel plates linked at the ends, has been announced by the STEEL PARTS MFG. CORP., of Chicago.

The belt is driven by a drive-sprocket that meshes with hinges of the belt thereby providing a positive non-slip movement. Should a belt plate become damaged, it is only a few moments' work to slip out the damaged plate and insert a new one.

Great versatility in the use of the "STEELOK" conveyor belt is claimed by the manufacturer.

"WATCH DOG" STARTER

A new "Watch Dog" starter for 15 and 20 watt fluorescent lamps, especially suitable for commercial and residential lighting fixtures has been announced by the GENERAL ELECTRIC CO.

With an average rated life of three years the new starter has two outstanding features: precision lamp starting and dead lamp look-out.

Exporters' Association of the United States and Exporters' Trade Association with the National Foreign Trade Council.

UNITED STATES STEEL

David F. Austin has been elected vice president in charge of sales for the United States Steel Corporation. He began his career in 1918 when he became office boy in the corporation's New York office.

VICTORY CLOTHING COLLECTION

Henry J. Kaiser has been appointed by President Truman to lead the second collection of clothing for overseas relief campaign which will start throughout the nation on January 7, 1946.

There is an urgent need for clothing for war victims.

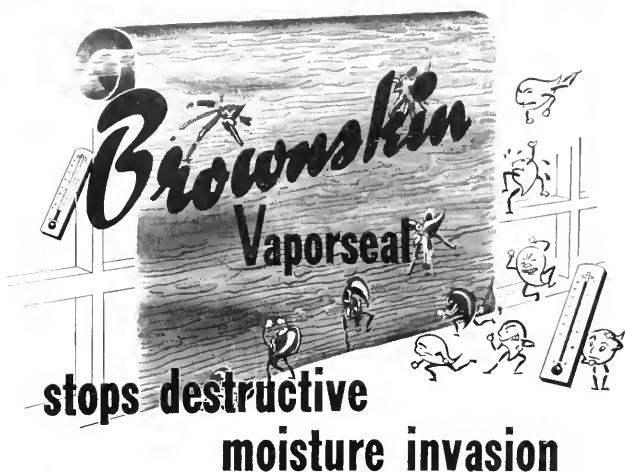

stops destructive moisture invasion

Moisture molecules move with relentless action from hot to cold areas. These massed forces of vapor surround refrigerated rooms and constantly work toward penetrating the cold interior. They pass through warm walls and make insulation wet, soggy and valueless.

That's why **BROWNSKIN VAPORSEAL** is essential to effective and everlasting refrigeration protection. **BVS** stops moisture before it can reach vital insulation to do its destructive work.

Three reasons why **BVS** is the perfect refrigeration protection:

- 1) **BVS** is creped to resist stress and to protect it from strain, tearing and shrinkage. **BVS** S-T-R-E-T-C-H-E-S.
- 2) **BVS** is made of laminated and impregnated kraft, bonded with asphalt to provide vapor and water proofing.
- 3) **BVS** is treated with bituminous compound to resist vermin and fungus and to help prevent deterioration.

If you plan a refrigeration unit of any type, assure effective and everlasting results with **BVS**. **BROWNSKIN VAPORSEAL** samples and complete product information gladly sent on request.



Quality Products Since 1895

ANGIER SALES CORPORATION

Framingham, Massachusetts

PACIFIC COAST OFFICE: 116 NEW MONTGOMERY ST., SAN FRANCISCO 5, CALIFORNIA

DISTRIBUTORS

WESTERN ASBESTOS CO., SAN FRANCISCO
LOCKWOOD WAREHOUSE CORP., SEATTLE
BUILDING SUPPLIES, INC., SPOKANE

WARREN & BAILEY CO., LOS ANGELES
MASON'S SUPPLY CO., PORTLAND
R. W. FRANK & CO., SALT LAKE CITY

WANTED STRUCTURAL ENGINEER \$8,000 Per Year

Old established building construction company has opening for a structural engineer who has ability to direct men. Must be qualified to handle designing and detailing and specification writing for reinforced concrete, structural steel and wood construction for industrial buildings.

Reply in confidence, giving age, education, employment record and earnings.

Also wanted five architectural draftsmen.

BUTTRESS & McCLELLAN INCORPORATED

1013 E. 8th Street
Los Angeles 21, Calif.

Built-In Fixtures for the Post-War Home

Paramount Fixtures will fit your post-war needs . . . investigate our new kitchen ideas which make for convenience and efficiency.

Paramount Built-in Fixtures meet the most exacting requirements. Our "Deluxe," "Moderne" and "Economy" cabinet fixtures are distinctive in design and construction and may be had in stock sizes or built to order.

Catalog for the asking

Paramount
Cabinets
BY
Paramount
BUILT-IN FIXTURE COMPANY
5107 Broadway, Oakland, California
Phone HU1-2100

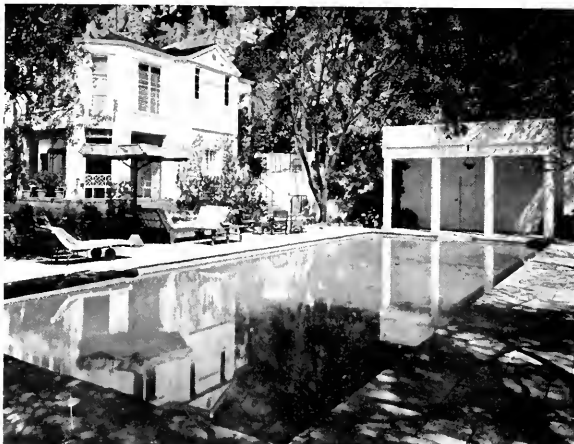

Pool built for George Cukor, Esq., West Hollywood, Calif.

PADDOCK'S OFFICES and experienced crews in both San Francisco and Los Angeles provide Architects with competent coast-wide engineering design and construction service. Write for complete Architects' file of Swimming Pool plans and equipment. Address nearest Paddock office.

PADDOCK ENGINEERING COMPANY
9060 SANTA MONICA BLVD. . . . LOS ANGELES 46, CALIF.
7TH AND BAY SHORE BLVD. . . . SAN MATEO, CALIF.

IN THE NEWS

FAR-AIR FILTERS

Originally designed for railroad service and thoroughly proven in this exacting field, a new type air filter manufactured by the Farr Company of Los Angeles is now



EC 2

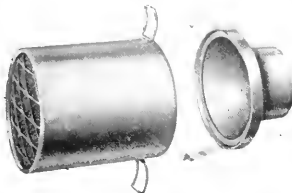

EC 4

available for quick installation on air compressors of all types, and small internal combustion engines.

It is made up in diameters of from 7 to 14 inches, with capacities of 90 CFM to 730 CFM.

Two of the 7-inch types, the EC2 (illustrated above) and the EC4, are available for immediate shipment. Full information is available from the FARR COMPANY, 2615 Southwest Drive, Los Angeles, California.

ARTHUR B. GALLION has moved his offices from Oakland to 1705 Banning Way, San Marino, California.

NEW MODULAR STANDARD

Results of two years extensive study among producers of Ponderosa Pine stock woodwork products are contained in a 32-page brochure just released by the NATIONAL DOOR MANUFACTURERS ASSOCIATION, 332 South Michigan Avenue, Chicago 4, Ill.

A. I. A. ACTIVITIES



The September Bulletin of the Northern California Chapter of the American Institute of Architects announced that the membership of that chapter has increased by 60 per cent. It is to be hoped that these new members had offices before they joined, for it is difficult to do architectural plans in one's lap.

The chapter has been occupied mostly with the Construction Industry Conference which was largely directed by J. Francis Ward, A.I.A., who was the chairman of the Building Industry Conference Board. The three-day conference was one of the most important held in San Francisco in the past few years.

The plan, started a short while ago, to hold an exhibit of plans for small houses to assist G.I.'s and others attempting to build a small home, did not meet with any material success. Only one set of plans was submitted. Apparently there are few architects who can afford the time that must be devoted to this unprofitable work. The Washington State Chapter has taken a different tack and it looks very promising. They also plan to have an exhibit, but with this difference: they will hold a competition with prize awards varying from \$50.00 to \$500.00, which awards are sponsored by the Seattle Trust and Savings Bank. The plans will be for sale, including six sets of blue prints and specifications, for \$50.00.

The project is known as the "STOCK PLAN SELLING BUREAU", held under the auspices of the WASHINGTON STATE CHAPTER OF THE AMERICAN INSTITUTE OF ARCHITECTS and SEATTLE MASTER BUILDERS".

All plans sent in for the competition, according to the rules, will be available for the sales bureau whether they are winners or not. An announcement of the results will be issued in December. The monthly bulletin of the Washington State Chapter was accompanied by the usual very human message and personalities of the TACOMA LETTER.

The October BULLETIN OF THE Southern California Chapter announced the completion of Unification in their chapter and expressed the hope that other A.I.A. chapters in the State will rapidly follow suit and apply for membership as a District Chapter of the California Council of Architects.

THE UNITED NATIONS CENTER

From the INSTITUTE offices in Washington, D. C., comes a copy of a letter from President James R. Edmunds, Jr., to William W. Wurster, Dean of Architecture and Planning at the Massachusetts Institute of Technology, asking if Mr. Wurster would accept the chairmanship of the planning of the site for the United Nations Center. Mr. Edmunds points out that in all probability the environs of San Francisco will be chosen if it is determined that the site shall be within the continental United States.

If this is the case, no selection could be made that would be more logical or satisfactory. Mr. Wurster has lived here and practiced architecture in San Francisco for years. He knows the area as few others do. He has distinguished himself in many ways here and in other parts of this country. Our desire that he act as chairman of the committee is not based on the wish to have one of our men there, but because Mr. Wurster is the logical man for the job.

PITTSBURG PLATE GLASS

Gordon E. P. Wright and Paul A. Ketchum have been appointed assistant general managers of branches of the Pittsburg Plate Glass Company.

Plan in advance for built-in telephone facilities

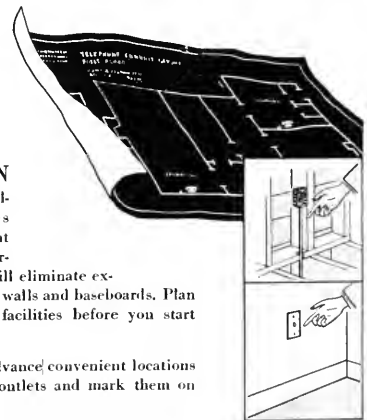

BUILT-IN

facilities for telephone wires and convenient outlets in tomorrow's homes will eliminate exposed wires on walls and baseboards. Plan for telephone facilities before you start to build.

1. Select in advance convenient locations for telephone outlets and mark them on your plans.
2. Specify in your plans that telephone conduit be installed during construction.



THE PACIFIC TELEPHONE AND TELEGRAPH COMPANY

WITH THE ENGINEERS

U. S. BUREAU OF RECLAMATION POSTWAR CONSTRUCTION WORK-POLICY OUTLINED

D. L. Brechner, acting regional information officer in the Sacramento, California, offices of the United States Department of the Interior, Bureau of Reclamation, recently called attention to an announcement from Washington defining the Bureau's policy regarding competitive bidding on postwar construction work planned by the Bureau of Reclamation.

According to the announcement, competitive bidding will continue to be the policy of the Bureau in awarding contracts for construction of multiple-purpose irrigation and power projects.

Commissioner Harry W. Bayshore listed seven major points relative to the Bureau's competitive bidding policy:

(1) Complete specifications for a job will be prepared by the Bureau of Reclamation; (2) Invitations to bid will be widely publicized (3) All legitimate requests for copies of specifications will be serviced by any one of the offices named on the invitation; (4) The list of firms obtaining specifications from each issuing office will be available for public inspection at the respective office; (5) Public bid openings will be the rule, and the name of each bidder and the amount of his bid will be

made public; (6) The Bureau will reserve the right to reject all bids, and (7) Where unusual conditions warrant, the Bureau may elect to advance construction by force-account.

Complete specifications covering the work to be done are made available to contracting firms when a call for bids is advertised in newspapers and technical magazines, and a date is set for the opening of bids.

Under normal circumstances the low bidder is awarded the contract when satisfactory financial responsibility, adequate experience, and compliance with bid requirement is shown.

Special or unique work conditions permit the Bureau to do the job by force-account; however, this is the exception to the rule.

OPA'S BMB AND IMPD

OPA's Building Materials Branch and Industrial Materials Price Division have a plan for rigid control of residential construction which has been drawn up and signed by executives that would demoralize private home building, according to a report on the plan by the Producers' Council.

The plan would authorize OPA to set an individual selling price on each individual house built by private enterprise, would retain price ceilings over all building products, and for the first time would rigidly limit the profit margins of thousands of small businessmen who do the nation's building, including distributors of building materials, contractors, and home builders.

It provides for far more extensive controls over residential construction than ever were attempted at any time during the course of the war, and is continuous in its operation.

COLUMBIA STEEL'S PROGRESS

Users of sheets and tin plate throughout the Pacific Slope will receive better service from the Columbia Steel Company as a result of the company's modernization program, William A. Ross, president of U. S. Steel West Coast subsidiary, disclosed recently.

Modern facilities for increased production of cold reduction sheets and tin plate of the highest quality is being installed at the Pittsburg, California, plant. This represents a continuation of a modernization program started in 1930 but which was interrupted by the war, and will tend to speed up western construction.

FUSES ADVERTISING PROGRAMS

J. M. McKibben, assistant to the vice president of the Westinghouse Electric Corporation, has been placed in charge of all Company advertising with offices in Pittsburgh, Pa.

Currently Westinghouse engages in general advertising, radio programs, motion pictures, and sign identification work.

"GOODS OF THE WOODS"



E. K. WOOD LUMBER COMPANY

LOS ANGELES

SAN FRANCISCO

OAKLAND

WE MANUFACTURE OR SUPPLY

DOUGLAS FIR
REDWOOD
SUGAR PINE
PONDEROSA PINE
SASH AND DOORS
MILLWORK
MASONITE TEMPERED PRESHWOOD
CONCRETE FORM PANELS
CEMENT ASBESTOS BOARD
INSULATION AND
INSULATION BOARD
INSULATION TILE AND PLANK
PLASTER BOARD
FIR-TEX INSULATION PRODUCTS
TRIPLE-SEALED GYPLAP
SISALKRAFT BUILDING PAPER
ROOFING
WOODLIFE WATER REPELLANT
BUILDERS HARDWARE

DEPENDABLE QUALITY



LET'S BUILD A SWIMMING POOL

(From Page 13)

In establishing the depth of the pool, the entire water area is divided into two parts, (a) the deep water, and (b) the shallow water area.

The maximum depth in the deep water area is dictated by the height over the water at which the highest diving board is to be placed. A one-meter board requires water 8 feet 6 inches deep for safe diving and this depth-point should occur not less than 15-feet from the deep-end wall which should have a height of seven feet.

A three-meter board requires 10 feet of water at least 20 feet from the deep-end wall which should be eight feet in height.

The 5-foot depth is usually considered the line of demarcation between deep and shallow water although many authorities use a 4-foot 6-inch depth for this purpose. This point should occur not less than 40 feet from the deep-end wall when the maximum depth is 8 feet 6 inches, and 45 feet from the deep-end wall when the maximum depth is 10 feet.

The depth at the shallow end of the pool should be either 3 or 3½ feet and the pool floor gradient in the shallow water area should not be more than 1 inch to the foot, nor less than 1 inch in 10 feet. When water shallower than 3 feet is required for the use of children, a separate wading pool should be provided.

Structural Design

The pool shell may be designed for the use of either pneumatically applied reinforced concrete, commonly known as "Gunite," or form-poured reinforced concrete. Either structure will provide a pool of highest utility.

When form poured concrete is used it is necessary to design the pool wall as a retaining wall with a cantilever footing. This is a standard form of pool construction which has been in use for many years. The pneumatically applied concrete pool is of more recent introduction and offers a considerable saving in construction time. In districts where this equipment is available the costs are also less than the form poured pool.

According to some authorities the price differential is greater with the smaller pools, form-poured costing approximately 50 per cent more than the Gunite in pools 20 by 60 feet, but, in pools exceeding 75 by 165 feet the cost of the two methods would be approximately the same. There would be a difference in favor of the pneumatic type from a standpoint of time of construction in the larger pools.

Interior Finish

The satisfaction derived from the use of any swimming pool depends to some extent upon the finish.

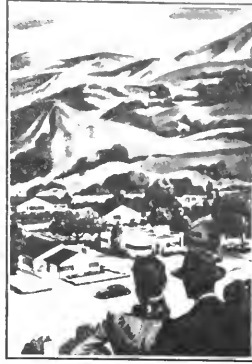

Are YOU

UP-TO-DATE on ELECTRIC HEATING?

Do YOU know—

- that insulated houses, on the Pacific Coast and elsewhere, have been heated for several years at costs of only \$6.00 to \$10.00 per room per year?
- that electric heaters have served continuously as long as 20 years without replacing a heating element?
- that a modern electric home heating system costs less installed than almost any type of fuel-burning central heating plant?
- that electric heating is the only perfect, fully-automatic home heating?
- that WESIX will send you up-to-date information on

WESIX *Auto-matic* *Oil-fired heat*

for homes and larger buildings—plus specification details?

Ask for this new printed matter. You will find it interesting reading, convenient to have in your reference files.

WESIX ELECTRIC HEATER CO.

390 First Street
SAN FRANCISCO 5, CAL.

A white, smooth tile makes a permanent finish and is easily cleaned. Apart from tile a most satisfactory pool interior is a product called "Silicite," a permanent finish pure white material which has been developed by the Paddock Company, after fifteen years of continuous test, which gives a brilliant turquoise appearance to filtered water of pool depth.

Pool paints should never be used except for repair purposes on pools that have been previously painted and then only when for reasons of economy it is impractical to have the old job sandblasted and plastered with "Silicite" or tiled.

Cement base paints all deteriorate in the presence of chlorine and should be removed after three to six months use.

Gutters and Copings

All public pools should be equipped with a continuous scum gutter or overflow trough which establishes the water level of the pool and provides a hand-hold for swimmers. Gutters should be of the semi-recessed type and the distance from the top of the gutter to the top of the coping, curb or deck, should not be less than 6 inches. The gutter should be at least 3 inches in depth and adequate drains should be installed at intervals of not less than 12 feet completely around the pool.

The installation of a curb or coping at the edge of the pool-deck above the gutter is recommended for outdoor pools by most authorities as it prevents



**Popular and Practical Play Equipment—
Hawaiian Swim Bar**

dirt from the deck areas being washed into the pool or overloading the gutter and also stops much air-borne dirt blowing along the surface of the deck and surrounding area. The use of such a curb or coping allows the use of high pressure water lines for washing and keeping the deck in a clean and sanitary condition.

Concrete, tile, terra cotta and cast stone are ideal materials and permit any desired effect in almost any color.

Deck Areas

The paved deck area surrounding the pool, sometimes referred to as walks or runways, should be equal to or exceed in area the water surface of the pool itself. Concrete is used for this construction in the great majority of cases, although quarry tile or cast stone may be used where a more decorative effect is desired. Any of these will make satisfactory paving material providing a non-slip surface texture is specified.

All decks should slope at least 1/4 inch per foot either toward the pool and into the gutter surrounding the pool, or away from the pool to a properly designed drain installed at the edge of the deck. Concrete should have a rotary non-slip finish, or a light brush finish.

If the concrete is marked off into squares or rectangles, adjoining rectangles may be brushed in directions at right angles to each other. The deck should be colored, not only for the sake of appearance, but to avoid glare, and for this purpose a chemical stain should be used after the concrete is fully cured.



CZC

PRESSURE TREATED LUMBER
**● PROTECTS AGAINST DECAY
AND TERMITE ATTACK**

*Specify it in your home
Available through Lumber Dealers*

<p>LOS ANGELES 601 W. 5th Street Phone Michigan 6294</p>	<p>SAN FRANCISCO 333 Montgomery Street Phone DOugles 3883</p>
--	---

J. H. Baxter & Co.

AGENTS FOR WEST COAST WOOD PRESERVING CO. SEATTLE, WASH.

Fencing and Wind Protection

All outdoor pools should be fenced, except the most sheltered locations, if it is determined that this fence be of solid material to provide protection from the prevailing winds. Clearing of trees, shrubs, or vines, on woven wire fencing, may be used, or if a rustic effect is desired several types of woven split-wood fence are available.

Obviously the style of fencing is properly dictated by the architecture of adjacent structures and by the landscaping existing or contemplated in the pool area.

Equipment Housing

Housing or mechanical equipment should be planned when designing the pool and the filtration, chlorination and accessory equipment should be located as near the deep-end of the pool as possible, usually in an underground filter room, the ceiling or roof of which becomes part of the paved deck area. Access to this room should be by a stairway rather than by manhole, and ventilation and drainage are of the utmost importance.

In mild climates where there is no risk that exposed water pipes will be damaged by freezing, consideration should be given to placing the filtration and chlorination equipment on a concrete slab with no housing except to protect the motor and electrical connections if these are not weather proof. The plant may be attractively painted and serves to interest the public in swimming pool sanitation and calls attention to the protection they are getting. In this manner all parts of the plant are available for economical maintenance and chlorine vent problems are eliminated.

Mechanical Equipment

Authorities agree that every public pool installation should be supplied with equipment for filtering, recirculating and chlorinating the pool water, for cleaning the pool walls and the floors while the pool is filled, for cleaning decks and gutters, and for disposal of waste water.

Swimming pool filtration and chlorination should be installed even when an unlimited supply of cheap raw water exists, since such installation provides the most practical method of controlling bacteria, algae and fungi and the average domestic water supply does not have sufficient clarity for swimming pool use. Even the clearest water becomes opaque after a few days use.

A filter capacity must be provided to filter the entire contents of the pool every 8 hours when operated at the rate of 3 gallons of water per minute per square foot of filter bed area.

The recirculation equipment, pump, motor and pool piping should be of sufficient capacity to backwash a single filter unit at a rate of at least 12-gallons of water per minute per square foot of filter bed area. Pool outlets and inlets must

Selling Feature or Handicap?

Tomorrow's home will use more electrical conveniences than ever before. New and better appliances, available for practically every household task, new and better lighting equipment, will all depend upon Adequate Wiring for satisfactory operation.

The two-wire electrical service equipment, with Number 14 wire, in the average home today will be completely inadequate to provide for electrical demands of the postwar home. Overloaded circuits will result in unsatisfactory service, waste of current and even danger.

New homes, inadequately wired, will be obsolete before they are lived in. They will be neither satisfactory nor salable.

That is why architects and builders today are placing Adequate Wiring at the top of the "Must" list, specifying wiring of sufficient size, more convenience outlets, more circuits and better switching—a complete electrical "Service entrance" for all future needs.

Such an Adequate Wiring plan will enhance the value of the home for years to come, and will prove worthy of the architect who designed it.



NORTHERN CALIFORNIA
ELECTRICAL BUREAU

1355 Market Street

San Francisco 3



LINE UP

New Apartment Building Sales with **STANLEY HARDWARE**

All over America, new apartment building plans await materials and labor. Stanley Hardware will be specified and installed by a majority of architects and builders who know they can count on its fine quality and helpful variety.

This preference will give the Stanley dealer an inside track to sizable sales and profits when apartment construction begins again. Plan your stock and aim your selling program to capture this future business in your community. Stanley, as always, will be ready with displays and other material to help you make the most of this approaching opportunity. The Stanley Works, New Britain, Connecticut.

Typical Stanley Hardware Items for Apartment Buildings

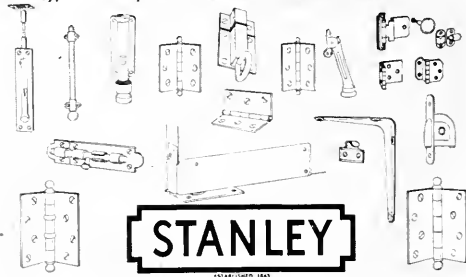

be so located that the entire pool contents will recirculate freely leaving no dead area. Correct design of the recirculation system is necessary for efficient dissemination of chlorine or other sterilizing material, and if a pool heating system is to be installed, efficient recirculation layouts are a requisite to any good pool.

Pool sterilization is usually accomplished by the use of chlorine and whenever chlorine gas in cylinders is available, the use of the solution feed type of chlorinator is recommended. Manually operated machines, available at reasonable cost, are considered adequate for all except the largest pools where automatic machines are usually preferred. Sodium hypochlorite supplies chlorine in solution and may be applied either manually or fed into the recirculating system by means of a hypochlorinator.

Pool and Deck Cleaning

Heavy particles of foreign matter not removed by the pool filters will settle to the bottom of the pool and must be removed by an underwater suction cleaner. Highly efficient equipment of this kind has been perfected and is usually operated by the same motors that recirculate the pool water. Cleaner outlet connections should be placed in the pool wall about 12 inches below the water level at intervals of 50 feet around the pool.

Hose connections from the raw water supply should be provided at the outer edge of the pool deck area at intervals of not more than 100 feet for hosing down the deck areas and washing out the pool gutters.

Waste Water Disposal

The waste water disposal line should be of sufficient capacity to handle the full output of the pool recirculation pump and motor when used for emptying the pool or for backwashing the filters. This line should also be designed to carry any surface water that falls on the deck area or is used in deck cleaning. Pool gutters or overflow trough should have a connection to this waste line.

It is desirable that the waste water line run by gravity to the sewer, storm drain or other outlet, as this does away with the necessity for a sump pump or other specially designed disposal system.

Deck Equipment

Every pool installation includes certain accessory equipment which is referred to as "deck equipment" and includes such items as access ladders, diving standards and towers, springboards, slides, and other recreational equipment and pool lighting—both underwater and for the deck areas.

Modern design recommends that pool ladders should be of the removable type set in deck anchors, and underwater lighting should always be of the wet niche type.

(See Page 40)

*Be sure you're getting the
finest window glass obtainable*

it costs no more to specify

PENNUERNON

Distributed by...

W · P · FULLER & CO.
PAINTS • GLASS • WALLPAPER

it's **PENNUERNON**
FLATTER *flat drawn*
WINDOW GLASS
CLEARER
BRIGHTER

IN THE NEWS

CALIFORNIA STATE AVIATION PROJECT COMMITTEE

Legislation designed to aid air transportation will be considered and recommended to the California State Legislature for consideration by a new State Aviation Project Committee, working in cooperation with the Assembly Aviation Interim Committee which was appointed by the last Legislature.

Members of the new committee include Loyd Wright, chairman; include Lloyd Wright, chairman; Webb Shadle, B. M. Doolin, Dudley M. Steele, Norman Larson, John C. Lee and Robert F. Craig.

Perry Taft of TWA, Howard G. Freas of the State Railroad Commission, R. F. Schmidt of CAA, Pat Hetherington representing the Council of State Governments, Lawrence A. Harvey of the Harvey Machine Company, and Edward P. McCall of the Associated Oil Company have been named advisors to the committee.

EXPANDS

The plant, processes, equipment and personnel of the Plasti-spray Corporation, Hollywood, California, has been acquired by the United States Stoneware Company of Akron, Ohio, and will be operated in the future under the name of the WESTERN PROCESS EQUIPMENT COMPANY.

J. A. Maher has been named vice-president and general manager of the new company, which will in addition to continuing Plasti-spray products, introduce U. S. Stoneware's line to the West Coast.

APPOINTED DISTRIBUTOR

The Western Asbestos Company, 675 Townsend Street, San Francisco, has been appointed exclusive distributors for the Martin-Parry line of movable steel partitions and metal paneling.

Other offices of Western Asbestos are located in Oakland and Sacramento, California.

SMOOT-HOLMAN COMPANY
INGLEWOOD, CALIFORNIA

An open letter to
the Electrical Industry:

Conversion from war to peace production may seem a simple process, but when a plant has been devoted 100% to war work there are many problems which must be overcome.

Smoot-Holman has always stood for the finest in illumination and mechanical construction of lighting equipment. Consequently, rather than to rush conversion and give the public a substandard product, our decision is to take the necessary time to produce equipment, not only equal to, but better than that supplied in the past.

If you are unable to wait for Smoot-Holman quality, avoid lighting failures and high service costs by purchasing industrial equipment with the RLM label or commercial equipment with the Fleurolier label, which assure reliable performance.

C. E. Smoot
President
MS

Yours very truly,

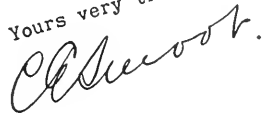

Offices in Principal Western Cities—Branch and Warehouse in San Francisco

PRODUCERS' COUNCIL PAGE

Northern California Chapter

The National Organization of Manufacturers of Quality Building Materials and Equipment

Affiliated with the AMERICAN INSTITUTE OF ARCHITECTS



U. A. FABRIS

Xmas Jinks as a member of Ernie Larson's Committee.

Harry was born and raised right here in San Francisco. The route to his present position led through the Shipping, Purchasing and Exhibit Rooms of Crane Co. and the Plumbing Department of Lewers and Cooke, Ltd., Honolulu of which he was Assistant Manager.

He is married, has three small children, two girls and a boy, and lives in San Francisco.

Sociable Harry belongs also to the Plumbing & Heating Club, California Golf Club and Society of American Military Engineers.

His hobbies are, of course, golf and baseball, bowling, gardening and Western stories, so it doesn't look like he will lack for something to do rain or shine.

Building Industry All-Day Conference voted a success. Most frequently heard comment at the close, "Very worth while. We must have another one next year."

The construction industry in this area is to be congratulated on holding the first such conference of a number to be held around the country this Fall.

A Catechism of questions and answers most commonly raised at lectures on Modular Design

"Harry" Fabris is another new member who has lost no time in making a place for himself in Chapter activities. Alternate from M. Greenberg's Sons Co. representing Josam Pacific Co. on whose products he concentrates as Assistant Sales Manager, Harry is actively working on that bigger and better first postwar

and Dimensional Planning given by A. Gordon Lorimer, Chief of the Bureau of Architecture of the City of New York will be presented in these pages.

And this is as good a time as any to KO one bug-a-boo once and for all.

Question: Does not modular design and the use of the four-inch grid place the Architect in a strait-jacket?

Mr. Lorimer: Decidedly not. A good parallel exists in music. Before the adoption of standard symbols in music, a composer had no way of conveying properly his musical intent to the performer. With the adoption of the standard staff and note placement, creative music became possible of execution in any country and in any age. Similarly, the four-inch grid gives the designer a means of more exactly establishing his wishes for proper execution with available materials.

New Film-Record. "A Scotsman Looks at Modular Coordination" presenting a talk and demonstration given by Mr. Lorimer in a dozen Eastern and Middle Western cities **on his vacation** has been purchased by your Chapter jointly with the Southern California Chapter. This will be available soon through the Chapter for group showings in this area.

"**This Year.**" says Theodore I. Coe, Technical Secretary of the A.I.A., "marks the twenty-third anniversary of the affiliation between The Council and The Institute, which we believe provides a constructive pattern for a closer integration of all of the elements comprising the widely distributed construction industry."



USE QUALITY PRODUCTS CONSULT AN ARCHITECT



ACHIEVEMENT AND CHARM IN MEXICO

(From Page 22)

•
JOSE A. CUEVAS

**Prominent Civil Engineer
of Mexico City, D.F.**

•



lonial style. This has now been made the state museum and contains many historical objects and paintings. The interior patio and court is especially interesting to architects.

This is the closing number of the series, and I trust you have enjoyed, as I have, getting better acquainted with some of the outstanding architects, engineers, and the architecture in our good neighbor country to the south.

Within the limits of these articles it has been possible to sketch but briefly the achievements and charm of the great people of Mexico. During these past three years I have grown to understand and appreciate their aspirations and ability and to join with them in "God bless Mexico."

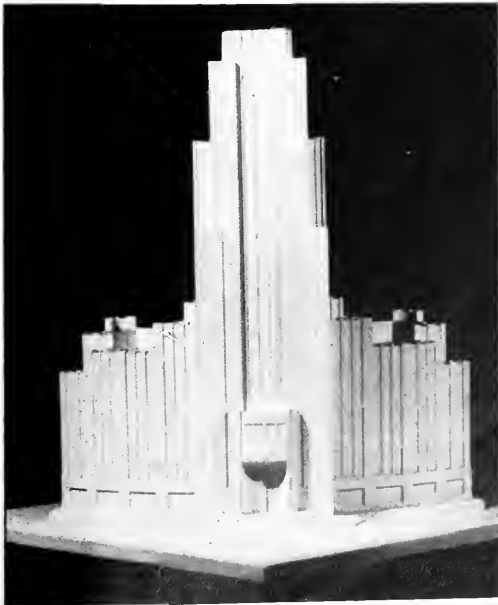

"LOTERIA NACIONAL," in Mexico City, D.F.
A most recent model. Jose A. Cuevas, Civil Engineer

STRUCTURAL STEEL

For Class A Buildings,
Bridges, etc.

JUDSON PACIFIC - MURPHY CORP.

1200 SEVENTEENTH STREET
SAN FRANCISCO

Plants: San Francisco - Oakland

SISALKRAFT

REG. U. S. PAT. OFF.

"More than a building paper"

THE SISALKRAFT CO.

205 West Wacker Drive
Chicago, Ill.

55 New Montgomery Street
San Francisco, Calif.

BASALITE

CAMBERED SHINGLE TILE

PERMANENT • FIREPROOF • STORM-
SAFE • COLORFUL • ECONOMICAL

Manufactured by

BASALT ROCK CO., INC.
NAPA, CALIFORNIA

FORDERER CORNICE WORKS

Manufacturers of

Hollow Metal Products • Interior Metal Trim
Elevator Fronts and Cabs
Metal Plaster Accessories • Sanitary Metal Base
Flat and Roll Metal Screens
Metal Cabinets • Commercial Refrigerators

269 POTRERO AVE.

SAN FRANCISCO, CALIF.

HEMLOCK 4100

LET'S BUILD A SWIMMING POOL

(From Page 36)

Maintenance and Operation

The cost of public pool maintenance and operation varies so greatly under different circumstances that it is impossible to cover the subject adequately. In some cases the cost of operating dressing room facilities in connection with the pool amounts to more than the cost of operating the pool itself, while in other cases this cost is very small. Pool maintenance is frequently performed by a lifeguard who derives a substantial part of his income from swimming and diving instruction.

The actual time required to operate a 50-foot by 100-foot outdoor pool under average West Coast conditions is approximately 100 man hours per month. This includes operation of the filtration plant and chlorinating equipment, backwashing of filters, washing the decks, cleaning the pool and gutters, and making necessary adjustments to the mechanical equipment.

A pool of this size would be operated by a 10 h.p. motor operating 8 hours daily under average conditions. The water used would probably be the equivalent of six complete changes per year and while the cost of chemicals varies, a fair average for such a pool, according to competent authorities, would be chlorine \$10 per month, alum (about

200 pounds) \$24 per month, soda ash \$10 per month, and other items would run about \$5 per month.

All experts in the field of swimming pool construction agree that the first thing to do when contemplating the construction of a new pool, whether it be for the private home or is to be used in the



Progressive Bend Ladder

(Paddock)

category of a public pool, is to employ a competent architect who in turn will secure the services of an organization thoroughly familiar with swimming pool construction and swimming pool problems.

Failure to do this may result in disappointment in the pleasure derived, or operational success of the pool as well as an unnecessary expense.

INDUSTRIAL LOGISTICS

A simple, effective method for handling materials and manufactured products economically and safely is outlined in a 12-page, illustrated booklet recently issued by the ELWELL-PARKER ELECTRIC Company of Cleveland, Ohio.

Correct use of containers, such as boxes, barrels, bags and bales, and standardized sizes of containers on pallets and skids is recommended in the booklet entitled "Industrial Logistics", copies of which may be had by writing Cleveland.

AIR CONDITIONING

A new data folder containing an interesting case history of the application of DOREX Air Recovery equipment to an existing system has just been issued by the W. B. CONNOR ENGINEERING CORP., 114 East 32nd Street, New York City.

Factors, figures and installation drawings are given on the Detroit Bank Building showing how fuel, energy and equipment were saved.

KNOW THE FACTS FIRST

Get in on the ground floor.

Postwar building will offer many exceptional opportunities to the alert executive. ARCHITECT'S REPORTS, issued DAILY, at the nominal total cost of \$10 PER MONTH, give you advance building news on construction projects in Northern California — name and location of work, architect, proposed cost and other pertinent information.

DON'T DELAY • SUBSCRIBE TODAY!

ARCHITECT'S REPORTS

Published Daily by
ARCHITECT and ENGINEER, Inc.

68 POST STREET, SAN FRANCISCO

EXBROOK 7182

ESTIMATOR'S GUIDE

BUILDING AND CONSTRUCTION MATERIALS

PRICES GIVEN ARE FIGURING PRICES AND ARE MADE UP FROM AVERAGE QUOTATIONS FURNISHED BY MATERIAL HOUSES TO SAN FRANCISCO CONTRACTORS. 2½% SALES TAX ON ALL MATERIALS BUT NOT LABOR

All prices and wages quoted are for San Francisco and the Bay District. There may be slight fluctuation of prices in the interior and southern part of the state. Freight cartage, at least, must be added in figuring country work.

BONDS—Performance—\$10 per \$1000 of contract. Labor and materials, \$10 per \$1000 of contract.

BRICKWORK—

Common Brick—Per 1M laid—\$50.00 to \$60.00 (according to class of work).

Face Brick—Per 1M laid—\$120 to \$150 (according to class of work.)

Brick Steps—\$1.60 per lin. ft.

Brick Veneer on Frame Bldg.—Approx. \$1.30 per sq. ft.

Common Brick—\$19.00 per M. truckload lots, f.o.b. job.

\$19.00 per M, less than truckload, plus cartage.

Face Brick—\$40 to \$80 per M, truckload lots, delivered.

Cartage—Approx. \$4.00 per M.

BUILDING PAPER—

1 ply per 1000 ft. roll.....	\$3.50
2 ply per 1000 ft. roll.....	5.00
3 ply per 1000 ft. roll.....	6.25
Brownkin, Standard, 500 ft. roll.....	5.00
Sisalcraft, 500 ft. roll.....	5.00
Sash cord com. No. 7.....	\$1.20 per 100 ft.
Sash cord com. No. 8.....	1.50 per 100 ft.
Sash cord spot No. 7.....	1.90 per 100 ft.
Sash cord spot No. 8.....	2.25 per 100 ft.
Sash weights, cast iron, \$50.00 ton.	
Nails, \$3.42 base.	
Sash weights, \$45.00 per ton.	

CONCRETE AGGREGATES—

The following prices net to Contractors unless otherwise shown.

Gravel, all sizes—		
\$1.95 per ton at Bunker; delivered.....	\$2.50	
	Bunker	Del'd
Top Sand.....	\$1.90	\$2.50
Concrete Mix.....	1.90	2.45
Crushed Rock, ¼" to ¾".....	1.90	2.50

Crushed Rock, ¾" to 1½".....	1.90	2.50
Roofing Gravel.....	2.25	2.80
River Sand.....	2.00	2.45

Sand—

River Sand.....	2.00	2.45
Lapis (Nos. 2 & 4).....	2.85	3.15
Olympia (Nos. 1 & 2).....	2.85	3.10
Del Monte White.....	84c per sack	

Cement—

Common (all brands, paper sacks), carload lots, \$2.42 per bbl. f.o.b. car; delivered \$2.72. Cash discount on carload lots, 10c a bbl., 10th Prox.; less than carload lots \$3.20 per bbl. f.o.b. warehouse or delivered.

Cash discount 2% on L.C.L.

Atlas White } 1 to 100 sacks, \$2.50 sack
Calaveras White } warehouse or del.; \$7.65
Medusa White } bbl. carload lots.

Forms labor average \$350 per 1000 sq. feet. Average cost of concrete in place, 50c per cubic foot, exclusive of forms; \$15.00 per cubic yard. With forms \$1.60 per cubic foot.

DAMP-PROOFING and Waterproofing—

Two-coat work, \$3.50 per square.

Membrane waterproofing—4 layers of saturated felt, \$7.00 per square.

Hot coating work, \$2.50 per square.

Medusa Waterproofing, \$3.50 per lb. San Francisco Warehouse.

Tricocel waterproofing.

(See representative.)

ELECTRIC WIRING—\$12 to \$15 per outlet

for conduit work (including switches).

Knob and tube average \$3.00 per outlet. (Available only for priority work.)

ELEVATORS—

Prices vary according to capacity, speed and type. Consult elevator companies. Average cost of installing a slow speed automatic passenger elevator in small four story apartment building, including entrance doors, about \$6500.00.

EXCAVATION—

Sand, 60 cents; clay or shale \$1 per yard.

Trucks, \$20 to \$32 per day.

Above figures are an average without water. Steam shovel work in large quantities, less; hard material, such as rock will run considerably more.

FIRE ESCAPES—

Ten-foot galvanized iron balcony with stairs, \$150 installed on new buildings; \$160 on old buildings.

FLOORS—

Composition Floors, such as Magnesite, 50c per square foot.

Linoflor—2 gauges—\$1.25 to \$2.75 per sq. yd.

Mastopave—90c to \$1.50 per sq. yd.

Battleship Linoleum—available to Army and Navy only—¼" —\$1.75 sq. yd. ⅜" —\$2.00 sq. yd.

Terazzo Floors—50c to 70c per sq. ft.

Terazzo Steps—\$1.75 per lin. ft.

Mastic Wear Coat—according to type—20c to 35c.

Hardwood Flooring—

Standard Mill grades not available.

Victory Oak—T & G.....

⅜" x 2½"..... \$143.25 per M. plus Cartage

½" x 2½"..... 122.00 per M. plus Cartage

½" x 1½"..... 113.50 per M. plus Cartage

Prefinished Standard & Better Oak Flooring

⅜" x 3¼"..... \$180.00 per M. plus Cartage

½" x 2½"..... 160.50 per M. plus Cartage

Maple Flooring

⅜" T & G Clear..... \$160.50 per M. plus Ctg.

2nd..... 153.50 per M. plus Ctg

3rd..... 131.25 per M. plus Ctg.

Floor Layers' Wage, \$1.50 per hr.

GLASS—

Single Strength Window Glass..... 20c per □ ft

Double Strength Window Glass..... 30c per □ ft

Plate Glass, under 75 sq. ft..... \$1.00 per □ ft

Polished Wire Plate Glass..... 1.40 per □ ft.

Rgh. Wire Glass..... .34 per □ ft.

Obscure Glass..... .27 per □ ft

Glazing of above is additional.

Glass Blocks..... \$2.50 per □ ft. set in place

HEATING—

Average, \$1.90 per sq. ft. of radiation according to conditions.

Warm air (gravity) average \$48 per register.

Forced air, average \$68 per register.

IRON—Cost of ornamental iron, cast iron, etc., depends on design.

LUMBER—All lumber at O.P.A. ceiling prices—

No. 1 Common \$49.00 per M
 No. 2 Common 47.75 per M
 Select O. P. Common 52.75 per M

Flooring—

Delvd.
 V.G.-D.F. 8 & 8 1/2" 1 x 4 T & G Flooring \$80.00
 C 1 x 4 T & G Flooring 75.00
 D 1 x 4 T & G Flooring 65.00
 D.F.-S.G. 8 & 8 1/2" 1 x 4 T & G Flooring 61.00
 C 1 x 4 T & G Flooring 59.00
 D 1 x 4 T & G Flooring 54.00
 Rwd. Plastic—"A" grade, medium dry 82.00
 "B" grade, medium dry 78.50

Plywood—not available

	Under \$200	Over \$200
"Plycord"—3/4"	\$49.50	\$47.55
"Plywall"—1/4"	45.15	43.30
3 ply—2 1/2"—1/4"	48.55	46.60
"Plyform"—5/8"		
Unoiled	126.50	121.45
Oiled	127.90	122.75

Above prices delivered if quantity is sufficient to warrant delivery.

Shingles (Rwd. not available)—

Red Cedar No. 1—\$6.75 per square; No. 2, \$5.75; No. 3, \$4.45.
 Average cost to lay shingles, \$3.00 per square.
 Cedar Shakes—Tapered: 1/2" to 3/8" x 25"—\$8.95 per square.
 Resawn: 3/4" to 1 1/4" x 25"—\$10.65 per square.
 Single: 3/4" to 1 1/4" x 25"—\$10.65 per square.
 Average cost to lay shakes, \$4.00 per square.

MILLWORK—Standard.

D. F. \$100 per 1000. R. W. Rustic \$100.00 per 1000 (delivered).
 Double hung box window frames, average with trim \$6.50 and up, each.
 Complete door unit, \$10.00.
 Screen doors, \$3.50 each.
 Patent screen windows, 25c a sq. ft.
 Cases for kitchen pantries seven ft. high, per lineal ft., \$9.00 each.
 Dining room cases, \$9.00 per lineal foot.
 Rough and finish about 80c per sq. ft.
 Labor—Rough carpentry, warehouse heavy framing (average), \$40.00 per M.
 For smaller work average, \$40.00 to \$55.00 per 1000.

MARBLE—(See Dealers)

PAINTING—

Two-coat work per yard 50c
 Three-coat work per yard 70c
 Cold water painting per yard 10c
 Whitewashing per yard 8c

PAINTS—

Two-coat work 50c per sq. yd.
 Three-coat work 70c per sq. yd.
 Cold water painting per yard 10c
 Whitewashing 8c per sq. yd.
 Turpentine \$1.03 per gal. in drum lots.
 \$1.08 per gal. in 5-gal. containers.
 Raw Linseed Oil—not available.

Boiled Linseed Oil—\$1.38 per gal. in drums. Available only to work with high priority—\$1.48 per gal. in 5-gal. containers.

Use replacement oil—\$1.86 per gal. in 1-gal. containers.

Replacement Oil—\$1.20 per gal. in drums.
 \$1.30 per gal. in 5-gal. containers.

A deposit of \$6.00 required on all drums.

PATENT CHIMNEYS—

6-inch \$1.20 lineal foot
 8-inch 1.40 lineal foot
 10-inch 2.15 lineal foot
 12-inch 2.75 lineal foot

PLASTER—

Neat wall, per ton delivered in S. F. in paper bags, \$17.60.

PLASTERING (Interior)—

	Yard
3 Coats, metal lath and plaster	1.50
Keene cement on metal lath	1.80
Ceilings with 3/4" hot roll channels metal lath (lath only)	1.20
Ceilings with 3/4" hot roll channels metal lath plastered	2.20
Single partition 3/4" channel lath 1 side (lath only)	1.20
Single partition 3/4" channel lath 2 inches thick plastered	3.20
4-inch double partition 3/4" channel lath 2 sides (lath only)	2.20
4-inch double partition 3/4" channel lath 2 sides plastered	3.85
Thermox single partition: 1" channels; 2 1/4" overall partition width. Plastered both sides	3.30
Thermox double partition: 1" channels; 4 1/4" overall partition width. Plastered both sides	4.40
3 coats over 1" Thermox nailed to one side wood studs or joists	1.65
3 coats over 1" Thermox suspended to one side wood studs with spring sound isolation clip	1.90

Note—Channel lath controlled by limitation orders.

PLASTERING (Exterior)—

	Yard
2 coats cement finish, brick or concrete wall	1.00
3 coats cement finish, No. 18 gauge wire mesh	2.00
Lime—\$3.00 per bbl. at yard.	
Processed Lime—\$3.10 bbl. at yard.	
Rock or Grip Lath—3/4"—20c per sq. yd.	
1 1/2"—19c per sq. yd.	

Composition Stucco—\$1.80 to \$2.00 per yard (applied).

PLUMBING—

From \$100.00 per fixture up, according to grade, quantity and runs.

ROOFING—

"Standard" tar and gravel, 4 ply—\$8.00 per sq. for 30 sqs. or over.
 Less than 30 sqs. \$9.50 per sq.
 Tile, \$30.00 to \$40.00 per square.
 Redwood Shingles, \$7.50 per square in place.
 5/2 #1-16" Cedar Shingles, 4 1/2"
 Exposure \$8.00 per square

5/8 x 16"—#1 Cedar Shingles, 5"
 Exposure \$9.00 square
 4/2 #1-24" Royal Shingles, 7 1/2"
 Exposure \$9.50 square
 Re-coat with Gravel \$4.00 per sq.
 Asbestos Shingles, \$23 to \$28 per sq. laid.
 1/2 x 25" Resawn Cedar Shakes,
 10" Exposure \$10.50
 3/4 x 25" Resawn Cedar Shakes,
 10" Exposure 11.50
 1 x 25" Resawn Cedar Shakes,
 10" Exposure 12.50
 Above prices are for shakes in place.

SHEET METAL—

Windows—Metal, \$1.75 a sq. ft.
 Fire doors (average), including hardware \$2.00 per sq. ft.

SKYLIGHTS—(not glazed)

Copper, 90c sq. ft. (flat).
 Galvanized iron, 40c sq. ft. (flat).
 Vented hip skylights 60c sq. ft.

STEEL—STRUCTURAL (None available except for defense work).

\$150 ton (erected), this quotation is an average for comparatively small quantities. Light truss work higher. Plain beams and column work in large quantities \$140 per ton.

STEEL REINFORCING (None available except for war work).
 \$100 to \$130 ton, set.

STONE—

Granite, average, \$6.50 cu. foot in place.
 Sandstone, average Blue, \$4.00. Boise, \$3.00 sq. ft. in place.
 Indiana Limestone, \$2.80 per sq. ft. in place.

STORE FRONTS (None available).

TILE—

Ceramic Tile Floors—\$1.00 to \$1.25 per sq. ft.
 Cove Base—\$1.10 per lin. ft.
 Glazed Tile Wainscot—\$1.25 per sq. ft.
 Asphalt Tile Floor 1/4" & 3/8"—.18 to .35 per sq. ft. Light shades slightly higher.
 Cork Tile—\$.40 to \$.75 per sq. ft.
 Mosaic Floors—see dealers.
 Lino-Tile, \$.35 to \$.75 per sq. ft.

Wall Tile—

Glazed Terra Cotta Wall Units (single faced) laid in place—approximate prices:
 2 x 6 x 12 \$1.10 sq. ft.
 4 x 6 x 12 1.25 sq. ft.
 2 x 8 x 16 1.20 sq. ft.
 4 x 8 x 16 1.40 sq. ft.

VENETIAN BLINDS—

40c per square foot and up. Installation extra.

WINDOWS—STEEL—

30c per square foot, \$5 for ventilators.

ARCHITECT AND ENGINEER

HEADLINE NEWS AND VIEWS

(From Page 23)

Revival of a vast tourist industry on the Pacific Coast, as predicted by Mission Trails Association officials, will unquestionably stimulate construction and reconstruction of ultra modern "tourist" accommodations to serve these travelers.

Some relief for the individual taxpayer and some easing of the excess profits tax on business may be expected from Congress this fall, but politicians are prone to overemphasize pre-chamber action. Easing of Federal taxes will benefit the home building industry.

California manufacturing employed an average of 824,000 persons in actual production work during 1944, representing a payroll of \$2,204,900,000, and an increase of 198.4 per cent in personnel and 502.4 per cent in payroll over 1939, the California State Chamber of Commerce reported recently.

California's Governor Earl Warren is studying reports from nine Citizens' Advisory Committee of the State Reconstruction and Reemployment Commission dealing with the State's postwar plans for labor, industry, business, finance and welfare, and welfare organizations are represented on the Committee.

Plans for building an estimated 800,000 new dwelling units annually for the next 10 years are somewhat overshadowed by the potentialities of home remodeling. For every \$4,000 spent on new housing, another \$1,000 is estimated will go into major home repairs and alterations.

Appointment of a California State Aviation Project Committee to work in conjunction with an Assembly interim committee to study legislation essential to the development of airport projects and air transportation will probably determine the future of "civilian" air activity and interest in the State.

1945 BUILDING TRADES WAGE SCALES (JOB SITES) NORTHERN CALIFORNIA

Six- and seven-hour day eliminated on all Government Work. A. F. L. - O. P. M. Agreement calls for eight-hour day.

NOTE: Predeterminations by the Department of Labor, as of July 1, 1944 [the wage-freezing date] have not yet been made in all of the counties listed. The wage scales shown are those being paid and in effect mostly by agreement between employers and their union.

	San Francisco	Alameda and Contra Costa	Fresno	Marin	Sacramento	San Jose	San Mateo	Vallejo	Stockton
CRAFT									
ASBESTOS WORKERS	1.50	1.50	1.25	1.50	1.50	1.25	1.50	1.50	1.25
BRICKLAYERS	1.87½	1.87½	1.75	1.87½	1.75	2.00	1.79-1/8	1.75	1.50
BRICKLAYERS, HODCARRIERS	1.40	1.40	1.05	1.40	1.05	1.50	1.35	1.50	1.14
CARPENTERS	1.50	1.50	1.25	1.43¾	1.37½	1.50	1.43¾	1.50	1.37½
CEMENT FINISHERS	1.50	1.50	1.50	1.50	1.50	1.50	1.50	1.58	1.50
ELECTRICIANS	1.70	1.70	1.70	1.70	1.70	1.70	1.70	1.70	1.70
ELEVATOR CONSTRUCTORS	1.75½	1.75½	1.75½	1.75½	1.75½	1.75½	1.75½	1.75½	1.75½
ENGINEERS: MATERIAL HOIST	1.50	1.50	1.50	1.50	1.37½	1.67½	1.50	1.37½	1.25
PILE DRIVER	1.75	1.75	1.60	1.75	1.75	1.75	1.75	1.75	1.60
STRUCTURAL STEEL	1.75	1.75	1.60	1.75	1.75	1.75	1.75	1.75	1.60
GLASS WORKERS	1.40	1.40	1.12½	1.40	1.12½	1.21	1.40	1.40	1.40
IRONWORKERS: ORNAMENTAL	1.60	1.50	1.60	1.60	1.60	1.31¼	1.50	1.50	1.50
REINF. ROOMEN	1.50	1.50	1.60	1.50	1.60	1.50	1.50	1.50	1.25
STRUCTURAL	1.75	1.75	1.75	1.75	1.75	1.75	1.75	1.75	1.37½
LABORERS: BUILDING	1.00	1.00	.90	.87½	.95	.90	.93¾	.90	.90
CONCRETE	1.00	1.00	.90	.87½	.95	.90	.93¾	.95	1.00
LATHERS	1.75	1.75	1.50	1.75	1.60	1.75	1.75	1.75	1.75
MARBLE SETTERS	1.50	1.50	1.50	1.50	1.50	1.50	1.50	1.50	1.50
MOSAIC & TERRAZZO	1.25	1.25	1.12½	1.25	1.15-5/8	1.12½	1.50	1.44-2/7	1.37½
PAINTERS	1.50	1.50	1.28-4/7	1.50	1.43	1.50	1.42-6/7	1.50	1.00
PILEDRIVERS	1.54	1.54	1.54	1.54	1.54	1.54	1.54	1.54	1.54
PLASTERERS	1.75	1.83½	1.75	1.75	1.75	2.00	2.00	1.75	1.83-1/3
PLASTERERS' HODCARRIERS	1.50	1.60	1.40	1.50	1.18¾	1.50	1.75	1.50	1.50
PLUMBERS	1.70	1.70	1.53-1/8	1.70	1.68¾	1.67½	1.70	1.70	1.50
ROOFERS	1.50	1.50	1.25	1.37½	1.37½	1.37½	1.25	1.37½	1.37½
SHEET METAL WORKERS	1.50	1.50	1.50	1.50	1.50	1.50	1.37½	1.50	1.50
SPRINKLER FITTERS	1.58	1.58	1.53-1/8	1.70	1.68¾	1.62½	1.70	1.78	1.50
STEAMFITTERS	1.75	1.75	1.53-1/8	1.70	1.68¾	1.62½	1.50	1.70	1.50
STONESETTERS (MASONS)	1.87½	1.87½	1.50	1.75	1.75	1.50	1.75	1.75	1.50
TILESETTERS	1.50	1.50	1.37½	1.50	1.37½	1.50	1.50	1.50	1.37½

Prepared and compiled by

CENTRAL CALIFORNIA CHAPTER, ASSOCIATED GENERAL CONTRACTORS OF AMERICA

with the assistance and cooperation of secretaries of General Contractors Associations and Builders Exchanges of Northern California.

CLASSIFIED ADVERTISING

RATE: 8c PER WORD . . . CASH WITH ORDER

MINIMUM \$1.50 (3 Lines)

ARCHITECT'S REPORTS—A valuable advance news service giving building and construction information daily on projects in Northern California. Name, location, architect, proposed cost, etc., on individual slips. Ideal for securing new business leads. Hundreds of items, total monthly cost only \$10. Don't delay, subscribe today. **ARCHITECT & ENGINEER**, Room 618, 68 Post Street, San Francisco, California. Phone DOugles 8311.

ARCHITECTS—A. McF. McSweeney, Architect, Room 927 Hearst Bldg., San Francisco. New offices. Desires catalogs.

ARCHITECTURAL ENGINEER: Excellent educational, professional and business experience seeks partnership in a young, growing office. Now in military service but will be discharged in 30 days. Write c/o **ARCHITECT AND ENGINEER**.

PHOTOGRAPHY—Keep a pictorial record of your building, or construction project. Pictures are of tremendous value to contract-

ors, builders, engineers, architects. For Industrial-Publicity-Aerial photography, see **FRED MAE**, Room 721-22 Hearst Bldg., San Francisco 3, California.

PRINTING—Printers, bookbinders. See us for commercial printing. Mercury Press, 942 Howard Street, San Francisco.

WANTED: Men on good residential working drawings and detailing. Write full qualifications. Roland E. Coate, Architect, 1111 Architects Bldg., Los Angeles, California.

MALOTT & PETERSON

ROOFING AND FLOORING
CONTRACTORS

20TH AND HARRISON STREETS
SAN FRANCISCO
Phone ATwater 1600

HOGAN LUMBER CO.

Wholesale and Retail
LUMBER

MILL WORK • SASH & DOORS

Office, Mill, Yard and Docks
SECOND AND ALICE STREETS • OAKLAND, CALIF.
Telephone GLencaurt 6861

CLINTON CONSTRUCTION CO.

OF CALIFORNIA

General Contractors

923 FOLSOM STREET • SAN FRANCISCO
SUtter 3440

SANTA MARIA INN

SANTA MARIA, CALIFORNIA

FRANK J. McCOY, General Manager
FERNAND E. PIMENTEL, Manager

On the
Coast
Highway
between
San
Francisco
and
Los
Angeles



American
or
European
Plan
•
Old
English
Tap
Room

BOOK REVIEWS

A HANDBOOK OF ORNAMENT. By Franz Sales Meyer. Published by Wilcox & Follett Co., Chicago 5, Illinois. Price \$2.50.

This book reminds us of the days when we were doing our first problems in architecture. Fortunately, the transition struck before we became bound to the scrolls and urns and figures which had been commonplace in architecture. The publisher recommends this book to art students, designers, interior decorators and jewelers. Apparently, these trades follow the routine which was formerly established for architects who searched through their manuals for girdles, buckles and scale diapers. We must confess, though, that there are times when clients request designs based upon antiquity. If you have such a problem you will find most of the answers in this handbook, even though it is a reprint of the famous "Meyer's Handbook of Ornament" published some forty years ago.

—John S. Bolles.

REVISTA de ARQUITECTURA. By "Sociedad Central de Arquitectos y Centro Estudiantes de Arquitectura de la Facultad de Ciencias Exactas, Físicas y Naturales de la Universidad de Buenos Aires". Price in the United States, \$15.00 Argentine per year.

In the March 1945 issue of the Revista de Arquitectura there is an article on the tenth anniversary of the creation of the tri-color symbol of the organization for planning Buenos Aires. This symbol is based upon air, sun and vegetation which the Directors of the Urban Planning Authority of Buenos Aires feel are the natural trilogies representing the goal toward which they are working.

The issue is interesting in that it makes a great point of the opportunities offered bomb shattered England for urban redevelopment. Most of the text of this issue is devoted to the London plan, and, as the magazine states, "Plymouth also has its plan". The articles on the City of London plan are very well presented and illustrated. One is reminded, in reading the magazine, that there are distinct advantages in obtaining an outsider's summary and commentary on your problems. The Revista de Arquitectura does not, unfortunately, point out the shortcomings of some of the plans which the English have brought forth.

Other issues of the Revista de Arquitectura have carried articles illustrating public and private works within the Argentine. If the material illustrated and published is indicative of the type of

work being performed in that country, and appear to be little reason for the American architect to learn Spanish for the purpose of the Revista.

John S. Bolles

A SHORT DICTIONARY OF ARCHITECTURE. By D. Ware and B. Beatty. Copyright 1945 by The Philosophical Library, Inc., 15 East Fortieth Street, New York, N. Y. Price \$2.75.

This book, of slightly over one hundred pages is an attempt on the part of the authors to acquaint the general public with architectural terminologies. The work was obviously prepared in England, and, as a result, in many respects would be a bit confusing to the American layman. There is, unquestionably, a demand on the part of the public and the first-year student for a work of this kind. Some day, some American Architect will undertake the compilation of a comprehensive dictionary of architecture which can be abridged for public consumption.

—John S. Bolles.

WAR RESTRICTIONS REMOVED ON FEDERAL-AID HIGHWAY PROJECTS

More than \$270,000,000 in Federal-aid highway funds, frozen since the beginning of the war, are now available for construction of projects throughout the Nation, and in addition President Truman has recommended to Congress that funds should be released for starting the postwar highway program authorized by the Federal-aid Highway Act of 1944, which authorizes \$500,000,000 for each of the first three postwar years.

This vast highway program will represent the employment of many persons as it is estimated 30 per cent of the cost of highway construction goes for labor at the site, and for persons thus directly employed about three persons are employed indirectly in industries furnishing materials, equipment, supplies and services required in the construction work.

Funds available for highway construction under the frozen-free Federal-aid program in the 11 Western States total some \$12,816,000, with individual State allocations being: Arizona, \$403,186; California, \$2,599,250; Colorado, \$3,032,400; Idaho, \$734,000; Montana, \$4,030,800; Nevada, \$152,048; New Mexico, \$676,376; Oregon, \$85,000; Utah, \$67,319; Washington, \$93,100; and Wyoming, \$939,444.

Construction of a new two-story research laboratory for the development of improved paints, lacquers, varnishes and new industrial coatings have been announced by The Arco Company, Cleveland, Ohio, paint manufacturers.

VERMONT MARBLE COMPANY

Producers and Finishers of Domestic and Imported Marbles

Write for new pamphlet describing our Marble Toilets and Showers

San Francisco and Los Angeles

San Francisco phone: SUTter 6747



The Most Complete Line of STEELS and BUILDING MATERIALS Made by a Single Producer



See Sweet's Catalog File or write us for full information.

REPUBLIC STEEL CORPORATION
GENERAL OFFICES: CLEVELAND, OHIO

DENVER, COLORADO CONTINENTAL OIL BUILDING
LOS ANGELES, CALIFORNIA EDISON BUILDING
SALT LAKE CITY, UTAH WALKER BANK BUILDING
SAN FRANCISCO, CALIFORNIA RIALTO BUILDING
SEATTLE, WASH. WHITE-HENRY-STUART BUILDING

PACIFIC MANUFACTURING CO.

HIGH CLASS INTERIOR FINISH QUALITY MILLWORK

142 SANSOME ST., SAN FRANCISCO
GARfield 7755

6820 MCKINLEY AVE., LOS ANGELES
THornwall 4196

BUILDERS EXCHANGE, OAKLAND

"AMERICAN - MARSH" CONDENSATION UNIT

Pumping Machinery for Every Purpose

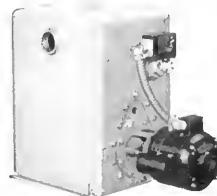

For Service Call DOuglas 6794 or MUtual 8322

SIMONDS MACHINERY CO.
SAN FRANCISCO 816 FOLSOM
LOS ANGELES 455 EAST 4TH

F.H.A. LOANS

TO BUY—
REMODEL—
REFINANCE



Long-term and low-cost F. H. A. loans are still available to finance the purchase of homes already built. Monthly payment F. H. A. loans for buying or refinancing homes are made by this bank for as much as 80% of the appraised value of the property with as long as 20 years to repay.

For further information call at our Real Estate Loan Department

**CROCKER FIRST
NATIONAL BANK**

OF SAN FRANCISCO
California's Oldest National Bank

ONE MONTGOMERY STREET
Member Federal Deposit Insurance Corporation

"KIMSUL"

Controlled Insulation!

HERMAL EFFICIENCY 0.27

Compressed in rolls for shipment and to save storage space, it stretches out over 5 times and when fully stretched gives a uniform designated thickness which insures the same maximum insulation value at all points.

Fire, Moisture and Vermin
Resistant
Extremely Light, Clean and
Easy to Install.

GUNN, CARLE & CO.

20 Potrero Avenue
San Francisco 3
UN 5480

IN THE NEWS

MOVES

Hertzka and Knowles, Architects, formerly of 369 Pine Street, San Francisco, have moved into new offices at 85 Post Street, same city.

"SKID-ROL" DOLLIES

Obtainable in pairs, "Skid-Rol" dollies are ideal for shifting machinery, tanks, boxes, steel blocks, dies, furnaces, and other heavy objects where weights up to 10 to 12 tons are involved.

Steel cleats imbed into wood skids and carry the load only a few inches from the floor.



Load can be rolled by manual power from place to place over all types of hard floors or pavements.

Manufactured by the TECHTMANN INDUSTRIES, INC., 828 North Broadway, Milwaukee, Wis., each dolly is 18½ inches x 10½ inches by 4 inches high and is equipped with four all-steel rollers 3¾ inches in diameter.

CHANGE OF ADDRESS

A new address for the San Francisco sales office of the Pacific States Steel Corporation has been established at 735 Ashby Avenue, Berkeley 2, California, according to a recent announcement by Company officials.

LAMP LOCKING DEVICE

An inexpensive locking device for fluorescent lamps which is designed to eliminate the danger to employees and machinery from falling lamps and which reduces trouble from vibration and improper installation, has just been announced by LADUBY COMPANY, New Haven, Connecticut.

Known as FLUR-O-LOCKS they are easy to install. Catalog upon request.

JOHN D. McLAUGHLIN

Electrical Engineer Consultant
Electrical Designs
Plans - Specifications
Industrial Power and
Lighting Layouts
Airport Lighting Design
Distribution Design

SERVICES FOR
ARCHITECTS AND ENGINEERS

1641 Russ Building
San Francisco, California
Telephone EXbrook 5712

Scott Company

HEATING - - PLUMBING - - TILE



243 MINNA STREET
SAN FRANCISCO
Phone EXbrook 6741

MODELS

- HOMES
- BUILDINGS
- FACTORIES
- ENGINEERING PROJECTS
- REALISTICALLY BUILT TO SCALE

EDWARD OWENS-ASSOCIATES
TECHNICAL MODEL BUILDERS
252 CLAY ST. DO. 2094 SAN FRANCISCO

KYLE FORREST

Civil Engineer

Water Supply — Sanitation

Municipal — Private
Consultations — Investigations
Reports — Designs — Valuations
Supervision — Litigation

Ground Water Work a Specialty

Hydrologic studies — wells, de-watering, underdrainage, foundations, conservation, testimony.

1504 Russ Building
San Francisco 4
YUkon 0652

ARCHITECT AND ENGINEER



Season's
Greetings

December - 1945

You Are Invited to See This 10-Minute Demonstration of M/P Metlwals

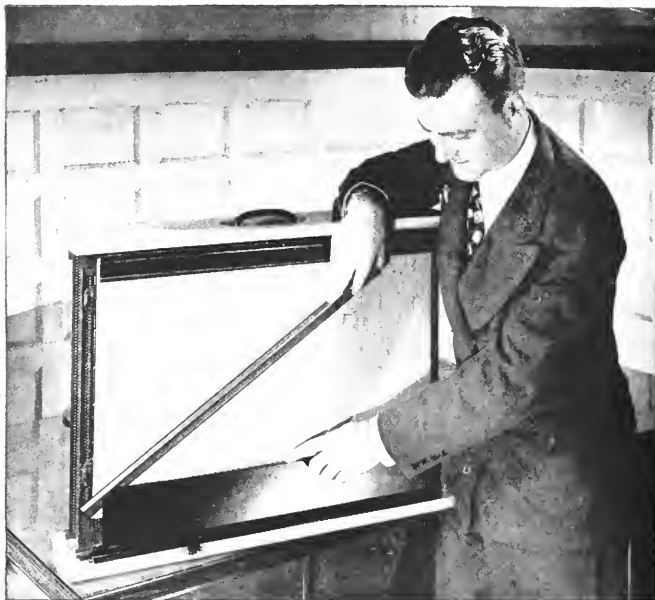

SHOWS SENSATIONAL FEATURES OF THIS NEW IDEA IN PARTITIONS AND PANELING!

YOU ARE INVITED to see a 10-minute demonstration of the exclusive construction features of M/P Metlwal Paneling and Movable Steel Partitions . . . which eliminate the need for plaster in new construction and permit fast, clean, simple installation in modernization or partitioning work.

PRE-FABRICATED! PRE-DECORATED! Made in lifelike wood grains and soft color finishes . . . providing an all-flush surface from floor to ceiling . . . eliminating the need for filler boards of other materials at ends or above the cornice level.



New, high notes in modernity are reached in the treatment of this office lobby with M/P Partitions and Paneling. This new method of partitioning space, covering walls is adaptable to all types of interiors

M/P Metlwals make possible an endless variety of new, modern decorative effects. These distinctive interiors can be used for executive, factory and general offices, stores, banks, hotels, hospitals, schools, residences and other buildings of every kind.

THEY PROVIDE ALL of the recognized advantages of steel: durability, fire-resistance, greater strength, less weight, and low maintenance, plus extra value, due to their flush-type surfaces, bonderizing of all parts, and life-like, baked-on, woodgrain finishes!

PERMANENT IN SERVICE, like stationary, built-in partitions, M/P Movable Steel Partitions and Metlwal Paneling may be easily moved and relocated anywhere with little or no waste! They insure quiet, long-life and economy both in initial and upkeep costs.

FOR A 10-MINUTE DEMONSTRATION, a call or a note to any of our offices will bring a trained expert to your desk. Western Asbestos Co. offers a complete M/P Partition and Paneling service from engineering to completed installation . . . including doors, railings, gates, hardware, and a full line of accessories.

WESTERN ASBESTOS CO.

DISTRIBUTORS • ENGINEERS • CONTRACTORS

675 TOWNSEND STREET, SAN FRANCISCO — HEMLOCK 4884
LATHAM SQUARE BUILDING, OAKLAND — TEMPLEBAR 7474
1224 EYE STREET, SACRAMENTO — SACRAMENTO 2-8993

ARCHITECT

Vol. 163 No. 3

AND ENGINEER

ARCHITECTS' REPORTS—Published Daily

Telephone DOuglas 8311

MARK DANIELS, A.I.A.
Editor

E. H. WILDER
Associate Editor

JOHN S. BOLLES, A.I.A.
Book Reviews

MICHAEL GOODMAN
Post-War Planning

L. H. NISHKIAN
Consulting Editor

E. N. KIERULFF*
Ass't Editor
*In the Service

Contents for



DECEMBER

COVER: A very Merry Christmas and Happy, Prosperous New Year

ARTICLES AND MISCELLANEOUS TEXT

RUNNING FIRE	4
By MARK DANIELS	
NEWS AND COMMENT ON ART	10-11
MARLO PACKING CORPORATION'S NEW PLANT	12
J. FRANCIS WARD and JOHN S. BOLLES, Architects	
THOMAS F. CHACE, Structural Engineer	
NASH, KELLER & GANNON, Mechanical Engineers	
THE CONSTRUCTION OUTLOOK	14
By MARDI	
THE CHILDREN'S HOSPITAL OF THE EAST BAY	16
DOUGLAS DACRE STONE and LOUIS B. MULLOY, Architects	
THE WORLD'S NEW 32-ACRE APPAREL CITY	18
J. FRANCIS WARD and JOHN S. BOLLES, Architects	
GOOD GARDENING	24
By ALBERT WILSON, Botanist	
MARBLE MEN—Architects, Hard Guys and Softies	25
Excerpts from Address by JAMES R. EDMUNDS, JR., President A.I.A.	
HEADLINE NEWS AND VIEWS	27
By E. H. W.	
THE CONSTRUCTION DEMAND	27
A.I.A. ACTIVITIES	29
WITH THE ENGINEERS	30
PRODUCERS' COUNCIL PAGE	36
ESTIMATOR'S GUIDE	39-40-41
Building and Construction Materials, Wages	
CLASSIFIED ADVERTISING	41
BOOK REVIEWS	43
ADVERTISERS' INDEX	46
INDEX PRINCIPAL ARTICLES AND ILLUSTRATIONS—1945	47

ARCHITECT AND ENGINEER (Established 1905) is published on the 15th of the month by The Architect and Engineer, Inc., 68 Post St., San Francisco 4; Telephone EXbrook 7182. President, K. P. Kierulff; Vice-President and Manager, L. B. Penhorwood; Treasurer, E. N. Kierulff; Advertising Manager, V. E. Atkinson, Jr.

Los Angeles Office: Wentworth F. Green, 1709 West Eighth Street.

Entered as second class matter, November 2, 1905, at the Post Office in San Francisco, California, under the Act of March 3, 1879. Subscriptions United States and Pan America, \$3.00 a year; \$5.00 two years; foreign countries \$5.00 a year; single copy 50c. ARCHITECTS' REPORTS are published daily from this office, Vernon S. Yallop, Manager.



RUNNING FIRE — by MARK DANIELS

PRICES HAVE CHANGED

In 1937 Congress established the statutory limit of \$5,000 per dwelling unit on housing projects in which government might participate. Many projects were designed and built on that basis for a few years. Then the war changed the picture by taking most of the materials of construction out of the availability list, but the limit of \$5,000 remained, although the costs of materials that have been released at last, has gone up and the labor of construction upon which the first limit was established has soared to heights untold. In other words, the government established a building cost limit in 1937, forbade the use of most of the materials until 1945, but still held the cost limit the same.

There are four vital housing projects held up for construction in San Francisco, where they are most sadly needed, by this impasse. They are Ping Yuen (Chinatown), North Beach, Bernal Dwellings, and Glen Craggs. Of these four projects, the six-story, class "B" project in Chinatown has been estimated to cost between \$5,000 and \$6,000 per dwelling unit. In view of the fact that all estimating costs are highly unsatisfactory today the commission of the San Francisco Housing Authority has determined to advertise for bids for 53 of the 231 dwelling units of the Chinatown project. Should the cost be less than the statutory limit of \$5,000 per dwelling unit the Authority will award the contract to the low bidder, having notified all contractors that it cannot award a contract in excess of \$5,000 per dwelling unit.

Since the establishment of the 1937 USHA act the wage scales of carpenters, for example, will have risen from \$1.25 to \$1.75 per hour by January 1946. Other wages have risen comparably as have building costs generally. It is really a war loss, aided and abetted by the fact that the government would not let us have the materials of construction until these costs had risen. If there is to be a low-rent housing program in this country and in San Francisco, the USHA Act will have to be amended increasing the statutory limit from \$5,000 to \$7,500 or thereabouts. Under any other circumstances there is little likelihood that any of the low-rent projects in San Francisco will be constructed in 1946.

ANOTHER BUTTON

Now that we seem to be well launched on the way to World War Number Three it might not be amiss to start offering awards for the best design for a third lapel button. The veterans' buttons for World Wars one and two did not cause any violent uproars of enthusiastic approval in the art

world, although that of the first war did have some significant allegorical merit. Why not combine the three wars on one button, somewhat along the lines of English heraldry—a skeleton couchant on a naked man rampant on a field of red, with gules, and all that sort of thing, you know.

THE UNO CAPITAL

The enthusiasm of San Franciscans over the 9 to 3 decision of the United Nations Executive Committee to locate the UNO Capital in the United States was prompted more by an assumption that the decision meant San Francisco than by a burst of national enthusiasm. Of course, it was natural for the residents here to feel that a selection of the United States could only mean San Francisco. But even this vote of the Executive Committee must be ratified by the Preparatory Commission as well as by the General Assembly before the United States is chosen as the official country in which the UNO Capital shall be located. That means that Australia, Brazil, China, Czechoslovakia, Mexico, Russia and Yugoslavia still have time to reverse their opinions and swing over to the side of England, Holland and France which, after all, is unlikely.

And so, with the Executive Committee vote in London being 9 to 3 for the United States, the chances are 10 to 1 that the United States will be selected, and any one (in San Francisco) with half an eye can see that that means San Francisco. The other claimants in the country don't count.

IN DEFENSE OF O.P.A.

Men in my neighborhood have openly and loudly blamed the rationing of food for their slow reduction of weight and the increasing evidences of malnutrition among the children. Perhaps they are justified, but some are unquestionably thriving upon conditions resulting from O.P.A. enforcements, for in my club the flies are fatter than ever before and are indubitably gaining weight.

PREFABRICATED HOMES

Plans for construction of a million dollar new plant at New Albany, Indiana, for the production of prefabricated homes on a production-line basis have been announced by Gunnison Tomes, Inc.

The new plant will have a capacity of 1,650 houses per year when operating on an eight-hour day.

It is expected the plant, a subsidiary of the United States Steel Corporation, will be completed and in operation by mid 1946.



HOW TO KEEP YOUR CLIENTS IN *Hot Water*

"Hot" faucets that actually run hot will greatly enhance the home-owner's appreciation of all your thoughtful planning! It's really *important* to "keep him in hot water" . . . important to you in terms of good will; to occupants, in terms of comfort, convenience, sanitation and health. ★ Yet, it's a fact that *in the majority of all homes, water-heater tanks are made-*

quate in capacity for family needs. And these needs are increasing all the time . . . what with more home laundry and dish-washing machines and better understanding of the value of hot water in everyday living. ★ So we urge you to use the accompanying chart as a guide to advising your clients and specifying new equipment. It is authentic, official and sound.

NEW WATER HEATER SIZING CHART

Developed by a representative Committee of the Pacific Coast Gas Association . . . and unanimously approved by the P.C.G.A. Water Heater Council, including gas utilities and manufacturers.

MINIMUM RECOMMENDATIONS FOR NORMAL, AVERAGE HOT WATER REQUIREMENTS		
Number Bathrooms	Number Bedrooms	Storage Cap'y, Gallons
1	1 or 2	30
1	3 or 4	40
2	2 or 3	40
2	4 or 5	50
3	3	50
3 or 4	4 or 5	75

THE PACIFIC COAST GAS ASSOCIATION



Let's LOOK AT THE RECORD for MODULAR COORDINATION



KRAFT FOODS COMPANY BUILDING, CHICAGO
Architects: Mundie, Jensen, Bourke & Havens Contractor: George A. Fuller Company

"We acknowledge the assistance of the American Institute of Architects in criticizing the subject matter and form of presentation of this publication."



SHOWN ABOVE is the Kraft Building, completed in Chicago in 1938, and planned in accordance with modular principles. Since this early example, the acceptance of modular coordination has grown rapidly and steadily. Today, modular-planned structures of all types are demonstrating its time and material-saving advantages on an ever-increasing scale.

THE REASON is that modular coordination is but another term for "common sense". Modular planning is a time-saving "tool" for the architect or engineer that may be used to produce any desired design or architectural effect. Dimensional coordination is a step toward production economy for the materials manufacturer and the architect. Structural clay products and concrete masonry, steel sash, and wood windows have been announced as modular products and the application of coordinated dimensions to many other products is already under way. Dimensionally-coordinated materials match modular plans with minimum cutting and fitting, substantially reducing wasted time and materials.

By promoting efficiency and eliminating waste, modular coordination offers a promising answer to one of the problems of maintaining wide-scale building activity in the face of rising costs.

NOTE: Contact Kraftile Company for further information

"KRAFTILE CAN ANSWER YOUR SPECIAL CONSTRUCTION PROBLEMS"

KRAFTILE COMPANY · NILES · CALIFORNIA



BUY VICTORY BONDS!

The war is over but we still
have obligations to meet . . .
a last "all out" effort to help
bring our battle-weary men home
and give the finest medical
care to our wounded heroes.

THEY FINISHED THEIR JOB—
LET'S FINISH OURS!



VERMONT MARBLE COMPANY

PRODUCERS AND FINISHERS OF
DOMESTIC AND IMPORTED MARBLES

SAN FRANCISCO • LOS ANGELES



**ARISTOCRAT
OF CONSTRUCTION**

BASALITE

LIGHTWEIGHT CONCRETE BUILDING UNITS

***CHARACTER
ECONOMY
INSULATION
FIRE SAFE
TERMITE PROOF
PERFORMANCE***

for your home specify: **BASALITE**

BASALT ROCK COMPANY, INC.

NAPA, CALIFORNIA

Build with Steel

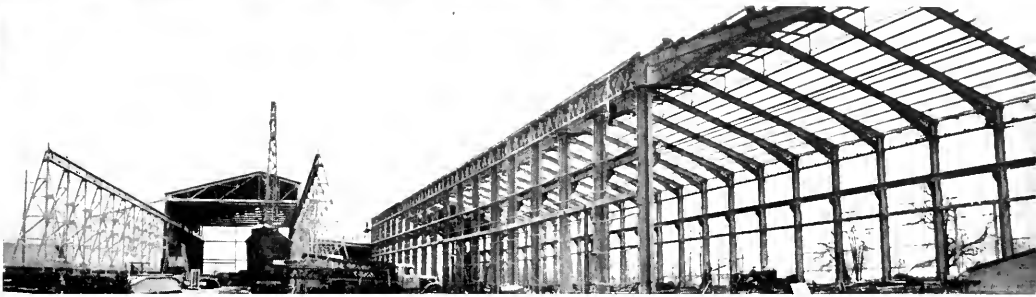

for post-war buildings
use steel . . . fire resistive
strong . . . permanent
economical

Manufacturers of
Fabricated Structural Steel
Steel Buildings
Bridges • Barges • Dredges
Service Stations • Plate Work
Steel Storage Tanks
Steel and Sheet Metal Products
Miscellaneous Iron
Truck Tanks • Road Machinery
Jobbers of
Steel Plates, Shapes, Bars,
and Sheets



OAKLAND, CALIFORNIA





Photo Courtesy Sylvania Electric Products

THE CHRISTMAS TREE . . .

"Peace on Earth, Good Will to Men"

ARCHITECT AND ENGINEER

NEWS AND COMMENT ON ART

CALIFORNIA SCHOOL OF FINE ARTS SUPPLIES A LONG FELT WANT

Photography

Ansel Adams, outstanding U. S. photographer, will conduct two four-weeks' instruction-and-work sessions in photography for advanced amateurs, and professionals, at the California School of Fine Arts, the first beginning on Monday, November 19, and the second on Monday, January 7.

The four Mondays of each session will be devoted to group instruction, from 9 A.M. to late afternoon. In addition, each member of the group, which will be limited to twenty persons, will be given photographic assignments and one period of exclusive, individual instruction each week. Enrollments will be accepted for either or both of the four-weeks' sessions only—each session at \$40, payable in advance.

According to Mr. Adams, the class sessions "will be devoted to the fundamental techniques and esthetics of photography, including visualization, exposure, development, printing, and presentation. They will relate to basic straight photography and its application in various fields." A fully equipped darkroom and other necessities will be installed in the studio.

Ansel Adams has had wide experience not only in creative photography, but in lecturing and teaching as well. A second series of lectures at the Museum of Modern Art in New York City last spring had capacity attendance.

FROM CUBISM TO SURREALISM

"From Cubism to Surrealism" is the title of a brief and concentrated course by Georges Lemaître at the California School of Fine Arts on the evenings of November 5, 7, 9, 12, 14, and 16 from 7:30 P.M. to 9 P.M. Dr. Lemaître, well-known author of critical works on contemporary art and literature, is Professor of French at Stanford University. The course will be given Mondays, Wednesdays, and Fridays for two weeks. For further information call ORdway 2640.

EXHIBITIONS AND EVENTS

Dr. Jermaine MacAgy, Acting Director of the California Palace of the Legion of Honor, Lincoln Park, San Francisco, has announced the following schedule exhibitions and special events for December:

EXHIBITIONS

ECCLESIASTICAL SCULPTURE

Through Jan. 2

RELIGIOUS FOLK ART OF THE SOUTHWEST

Through Jan. 2

ANNUAL EXHIBITION OF THE SOCIETY FOR SANITY IN ART

Through Dec. 31

WATERCOLORS BY BEN NORRIS

Through Jan. 2

PHOTOGRAPHS BY GEORGE BARROWS

Through Jan. 2

The Alma de Bretteville Spreckels Collection of Sculpture and Drawings by Auguste Rodin.

The Mildred Anna Williams Collection of Paintings, Sculpture, Tapestries and Furniture.

The Collis Potter Huntington Memorial Collection of 18th Century French Paintings, Sculpture, Tapestries, Furniture and Porcelain.

KSFO—Uda Waldrop recital broadcast each Saturday at 3:30 p.m. direct from the Sculpture Court of the Museum.

PROGRAM FOR DECEMBER AT THE M. H. DE YOUNG MEMORIAL MUSEUM

Following events have been scheduled for this month, offering a wide variety of interest and subject.

Paintings and Drawings by Contemporary Artists from the Museum Collection, to be shown through December.

Watercolors by H. Halit, shown through December.

The American Century Portraits of Famous Americans by Erit Kaufmann, opened December 8; Mural Paintings from the Caves of India by Sarkis Katchadourian, opened December 11.

Special Lecture

"The Art of Egypt" by Dr. Stephen S. Kayser, illustrated with slides, will be shown on Saturday, December 15, at 2:00 p.m.

Art Classes for Amateurs

Clay modeling, drawing and painting. Children, Saturday morning from 10 to 11:30, and Adults on Saturday afternoons from 1:30 to 3.

PRODUCTS EXPOSITION

Presenting an inspiring drama of tomorrow's wonders, the "International Products of Tomorrow Exposition" has been scheduled for April 22, 1946, in the Coliseum in Chicago.

Lasting 22 days the exposition will feature new types and models in consumer products.

WILLIAM H. YOUNG, architect, after three years of designing with the United States Engineers in San Francisco, is going into private practice. He will be grateful for catalogs and other architectural literature sent to his address at 1153 Garfield Road, Albany 6, California.

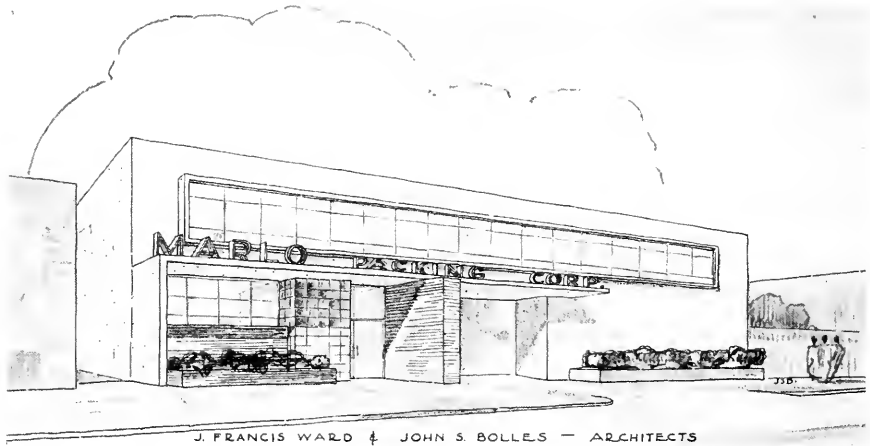

MARLO PACKING CORPORATION'S NEW PLANT

San Francisco

J. FRANCIS WARD, A.I.A., and JOHN S. BOLLES, A.I.A., Architects
THOMAS F. CHACE, Structural Engineer
NASH, KELLER & GANNON, Mechanical Engineers

The Packing Plant for the Marlo Corporation is a good example of the part that the Architect plays in all the functions from the beginning to the final execution of the layout for an industrial plant. These functions roughly divide themselves as follows:

(a) **Planning and Circulation.** — Although the building is primarily shelter for the operation of the manufacturing processes the studies for the building must take into account fundamental nature of the processes and all questions of circulation. In the case of the packing plant under consideration, the products to be manufactured are varied and a high degree of flexibility is necessary to enable the owners to switch to different products the public demands.

(b) **Coordination.** The Architect's function as a Coordinator is nowhere more necessary than in the design of an industrial plant where leadership must be provided for the proper direction of the mechanical and structural engineering problems.

(c) **Executive.** Contact with Government agencies and knowledge of codes is a requirement of the designer particularly for an industry that desires to do interstate business. In addition to the Public Works Department of the City, Health and Fire Departments there must be a high degree of cooperation with the several agencies in the Federal Government.

In the case of the plant in question, it is felt that a successful solution has been found and that the processes can be carried out with a minimum of effort and maximum flexibility and capacity.

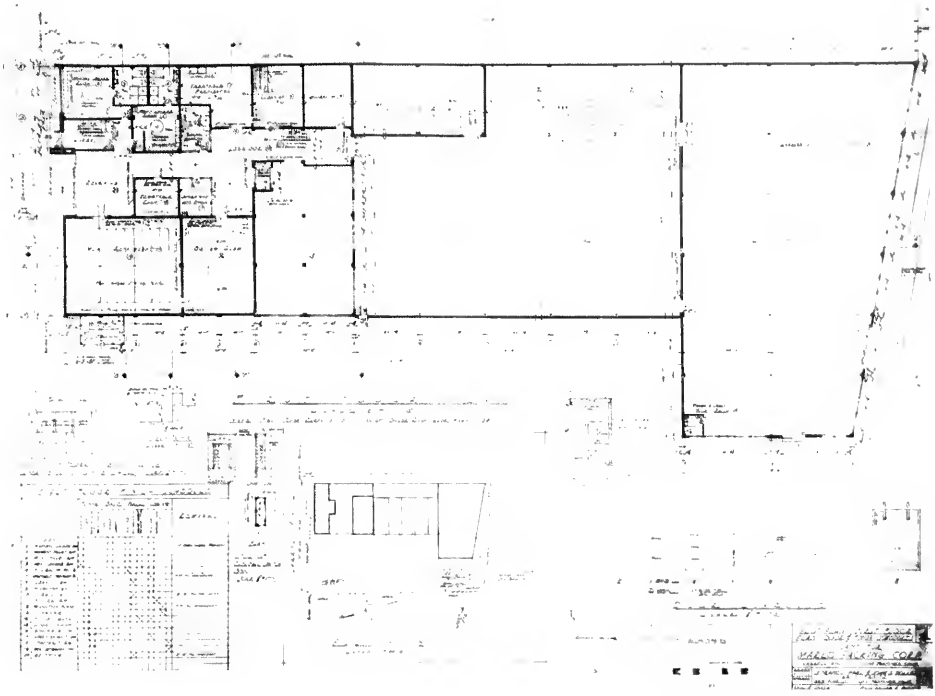

ABOVE: First Floor Plan

BELOW: Second Floor and Roof Plan

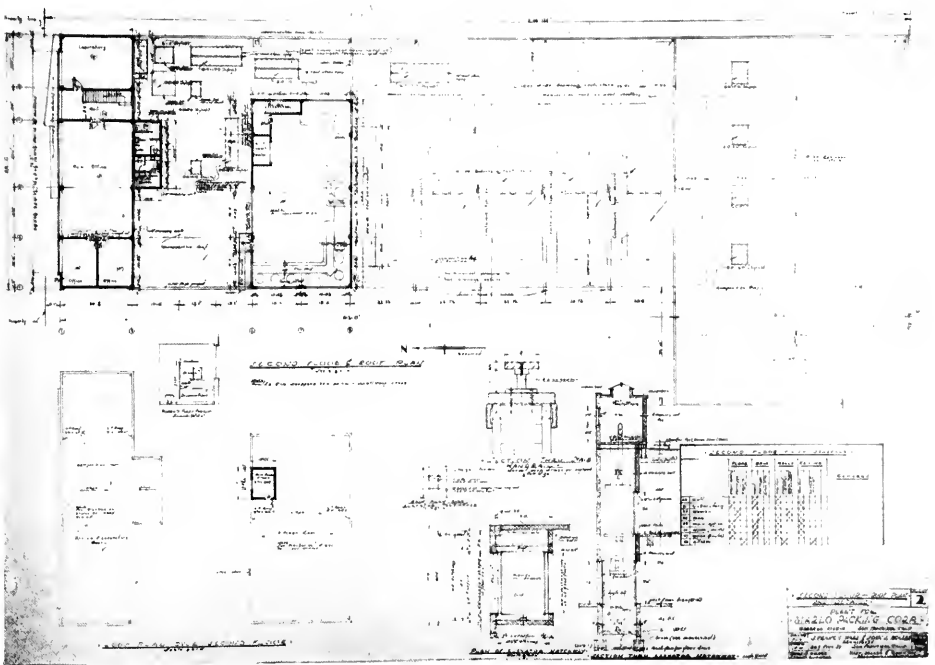

THE CONSTRUCTION OUTLOOK

By MARDI

The activities in the construction field are not abating. On the contrary they are on the increase as we have predicted and are moving into a field of larger and more substantial ventures. This is particularly true of the case of residential construction, which has seen the average cost of residential jobs increase, during the past month, from the somewhat discouraging sum of \$6,000, as high as \$22,000.

In fact, "Architects' Reports" shows a number of houses during November running in cost from \$12,000 to \$15,000 for which contracts were awarded for the first time since V-J day.

From October 12 to November 12 "Architects' Reports" show the following figures:

Residential contracts awarded, \$2,939,000.

Business construction contracts awarded, \$13,171,000.

Actual work on draughting boards, \$17,133,000.

In addition to these substantial sums of actual work in Central California for one month, \$15,432,000 bonds have been voted in Oakland for various construction jobs, and \$1,500,000 in Reno, Nevada.

On January 1st of 1946, Kaiser Company Homes, Inc., will begin their huge project of building 230 dwellings in San Jose and vicinity at a cost of approximately \$1,000,000 which makes it look as if some suspenders will have to come down. Perhaps it is the large amount of actual jobs under construction that has kept the supply of building materials from catching up with us.

NEW ASPHALT PLANT

Contracts for construction of the California Asphalt Corporation's new plant at Willbridge, near Portland, Oregon, were awarded to the Fluor Corporation of Los Angeles, California, and the Chicago Bridge and Iron Company of Chicago.

The process equipment of the new plant will be installed by the Fluor Corporation, while the tankage construction will be done by Chicago Bridge and Iron.

A number of other contracts approximating \$165,000 for grading, paving, concrete work and spur trackage will go principally to Portland contractors.

The new plant is scheduled to be ready for operation by June 1, 1946.

Herman Brookman, Architect, has moved from 3680 S. E. Glenwood in Portland, to 1728 N. W. 32nd Avenue, Portland, Oregon.

MARKETING CONFERENCE

Intensive discussions on how retailers, wholesalers and other business engaged in the distribution of goods and services can step up their postwar operations to develop and maintain a ready market for the flood of products to be turned out by American industry will be highlighted at a series of five Marketing Conferences under sponsorship of the Chamber of Commerce of the United States.

One of the five Conferences will be held in Sacramento, California, on February 11, 1946. The others are to be held in Dallas, Texas, on February 18; Atlanta, Ga., on February 21; New York City, February 25-26, and Chicago on March 4, 1946.

Concrete suggestions for sustaining a volume of postwar business estimated at from 30 to 50 per cent greater than the best prewar level, will be presented by leading American businessmen.

NEW STEEL MILLS FOR WEST COAST

Bethlehem will expand its Los Angeles rod, bar and wire mills and also establish a new open hearth plant at an initial cost approximating \$8,000,000, as part of a long range program of expansion.

New steel-making and finishing facilities costing between seven and eight million dollars are to be built immediately by Bethlehem Steel Company at Los Angeles, California, according to H. H. Fuller, Vice President in charge of Bethlehem's West Coast steel activities.

"Plans are completed for further extensions at least as great as this program, as soon as peacetime markets warrant. Since acquiring West Coast steel properties in 1930 at Seattle, South San Francisco and Los Angeles, Bethlehem has made numerous improvements in a schedule of expansion which is now ready to go forward at an accelerated pace.

"The new mills at Los Angeles will provide a full range of wire rods; a wide range of bars including rounds, squares, flats, angles, spring steel and reinforcing bars; and a wire department for the production of bright wire in 20 gauge and heavier.

"The detailed engineering is now in process and ground will be broken the first of the year."

"Complete cooperation by all industry factors is essential if we are to avoid inflation in prices of homes and other building during the period when the demand for new structures exceeds the supply."—L. C. Hart, president, Producers' Council.

WESTERN ASBESTOS TO DISTRIBUTE MARTIN-PARRY PARTITIONS AND PANELING



H. J. McDEVITT
General Sales Manager,
Martin-Parry Company

Announcement of the addition to its engineering and contracting service of heat and cold insulation, sound conditioning, and corrugated transite roofing and siding of Martin-Parry steel partitions and paneling was made recently by the Western Asbestos Company. Western Asbestos will be exclusive distributor in northern California and western Nevada, according to H. J. McDevitt, general sales manager of Martin-Parry Corporation, who made the appointment.

McDevitt, while on the Pacific Coast, expressed his opinion that the West will be the pace setter for the entire country, both in acceleration of construction and in the leadership in building that western architects and builders will take.

M-P "Metwal Paneling" and "Movable Steel Partitions" provide a system of dry wall construction.

The paneling is made up of a steel sheet and backing sheet corrugated for structural strength and is pre-decorated at the factory in natural wood grain finishes as well as a complete line of durable colors, shades, and finishes. It is permanent, yet movable if need be, fireproof and easily erected.

Modern and streamlined, the Martin-Parry steel partitions are of the flush type, a full 4" thick,

double faced, with but a single line joint from floor to ceiling. They eliminate all need for using fillers. Walls are made solid like those with permanent partitions, yet M-P Partitions are easily moved and relocated with little or no waste, as rearrangement of space requires.

Western Asbestos will render engineering and installation service for Martin-Parry from its head office in San Francisco and from branches in Oakland and Sacramento.

BOTTLENECKS MODERNIZED

Hoarding by Army and Navy supply depots of vast quantities of building materials is delaying construction of badly needed new homes and keeping prices up, reports the Associated Home Builders of San Francisco.

Unsettled reconversion policies, impractical OPA ceilings and worker-employer disputes are given as the most serious factors contributing to the greatest bottleneck in the history of the construction industry, the group asserted.

In the meantime, thousands of families, including many World War II veterans, seek some form of shelter, which they may call "home".

GENERAL CONTRACTORS

Announcement of the formation of the firm of MacDONALD, YOUNG and NELSON, general contractors in the field of building and heavy construction has been made recently.

Graeme K. MacDonald, Dallas Young and C. Edward Nelson comprise the new organization which will maintain general offices at 127 Montgomery Street, San Francisco.

MacDonald was formerly of MacDonald & Kahn, Inc.



Modern office utilizing Martin-Parry Steel Paneling in natural wood grain finish.

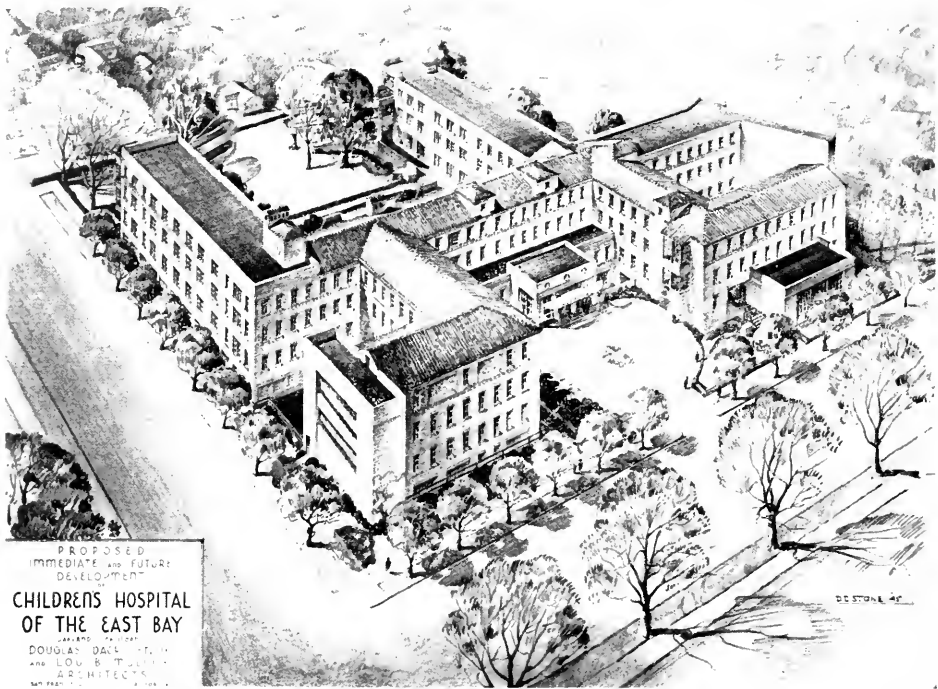

PROPOSED
IMMEDIATE AND FUTURE
DEVELOPMENT
**CHILDREN'S HOSPITAL
OF THE EAST BAY**
JANUARY, 1945
DOUGLAS DACRE STONE
AND LOUIS B. MULLOY
ARCHITECTS
SAN FRANCISCO, CALIF.

OAKLAND, CALIFORNIA

The Children's Hospital of the East Bay

DOUGLAS DACRE STONE and LOUIS B. MULLOY, Architects

After eight years of study the Board of Directors of the East Bay Children's Hospital Association decided to meet the urgent demands for additional beds and facilities, and are now well along with the \$400,000 new wing being built under the able direction of their architects, Douglas Dacre Stone, A.I.A., and Louis B. Mulloy, A.I.A.

Architects' Plan

The Board had hoped that additional beds could be provided by adding a third floor to the east wing of the present building, but the architects found that although the original design provided for a third floor, the city building regulations had changed so that it would be necessary to provide additional reinforcements. This would necessitate the closing of the entire second floor for several weeks. In addition to this, a study showed that

the existing facilities, such as the Laboratory, X-ray, Pharmacy, laundry and storage space for supplies, would be wholly inadequate to take care of the additional beds a third floor would provide.

After an intensive study, the architects submitted an excellent plan for expansion together with estimated costs. The complete development of the Hospital is so designed that it can be built in units as the community grows, and in such a way that the final building can be operated in the most economical way with all departments properly coordinated.

Preliminary Plans Begun January, 1945

The firm of architects, Stone and Mulloy, which specializes in hospital construction, was chosen as architects, and in January, 1945, commenced

the drawing of preliminary plans based on all the material that had been assembled and prepared up to that time. After months of work and change, two plans based on the functioning of the Hospital were ready.

The master plan that evolved from the preliminary studies and subsequent conferences now offers a detailed plan of growth through a series of units which may be completed either singly or together, but in any event, will fit into the functions of each preceding unit and thus provide orderly growth.

The first of these units will accommodate 65 beds through extension of the present main wing and construction of a new ground floor and two-story west wing parallel with the present east wing. Since this first wing is largely devoted to space for patients, certain problems of servicing will remain, but both the Hospital and Out-Patient Department will function more easily and therefore provide better care than in the past.

THE NEW WING WILL CONTAIN:

Ground Floor—

Storerooms for supplies and food.
Enlarged Laboratory.
Purchasing Office. Housekeeping Office.
Dietitian's Office.
Autopsy Room.
Locker Rooms for nurses, volunteers and employees.
Work Shop area.
Class Room for nurses.

First Floor—

Administrative Wing—Administrative Offices.
Business Offices. New Board Room.
Nursing Offices. New Record Room.
Doctors' Room.
Occupational Therapy Department.

Second Floor—

Twenty-five beds for cardiac cases.
Forty beds for medical and surgical cases.
(These will include some beds which may be isolated as needed.)

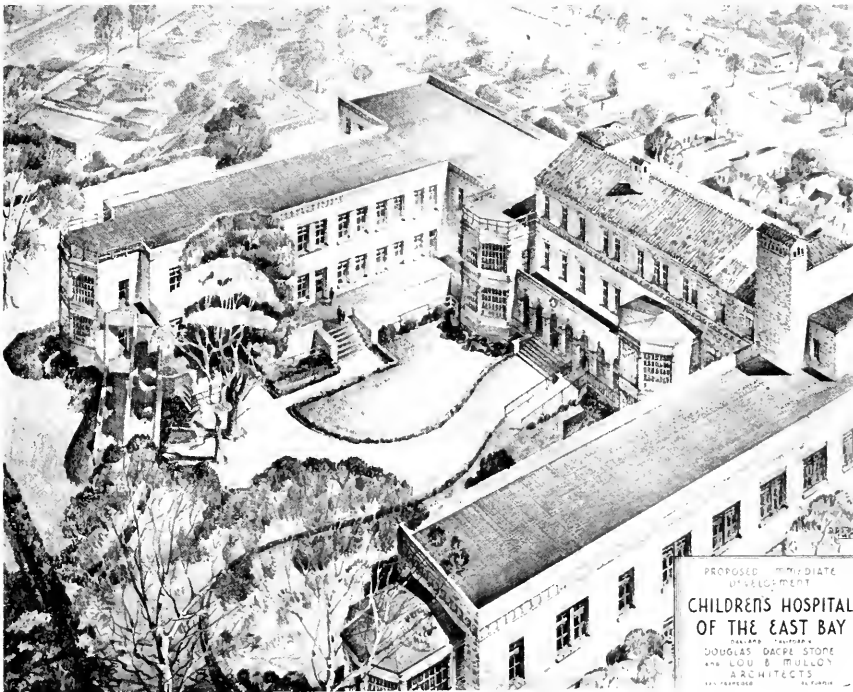

The East Bay Children's Hospital as it will appear upon the completion of the new \$400,000 wing.

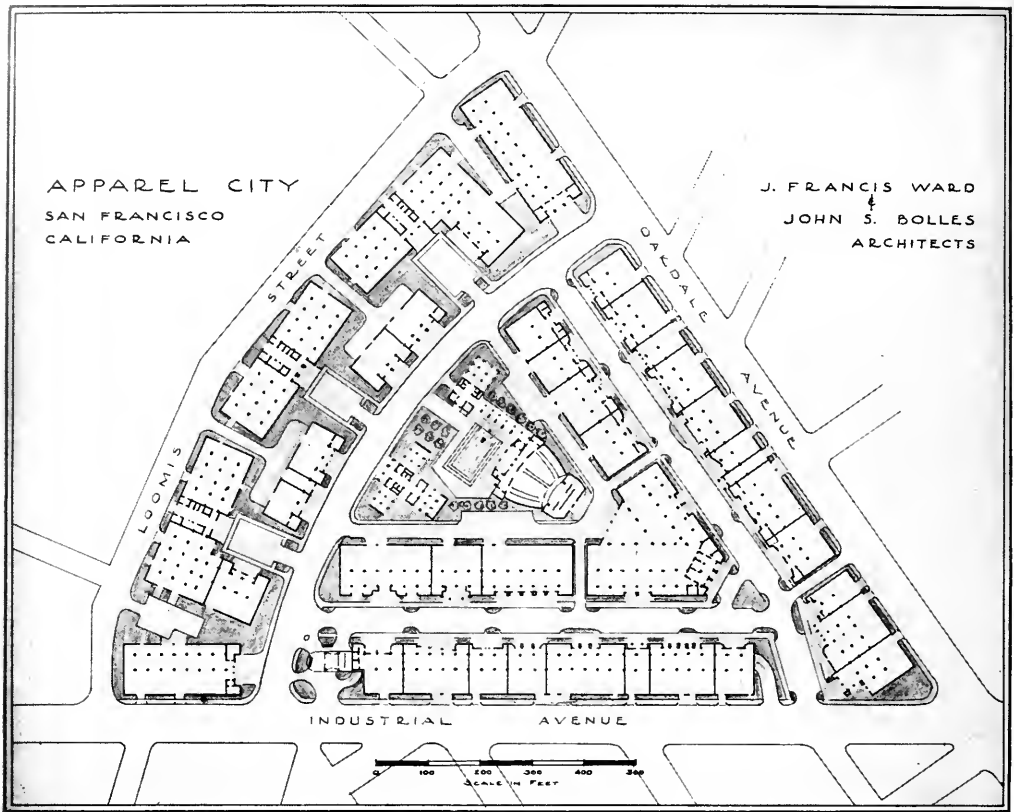

The World's New 32 Acre APPAREL CITY

J. FRANCIS WARD and JOHN S. BOLLES, Architects

Apparel City is an outstanding example of what can be achieved when an industry and their Architects get together at the inception of the project. The garment industry is, in San Francisco, as elsewhere in the country, composed of many individuals and firms operating in congested downtown areas under the most adverse conditions for light, air and service. Only in the

West could a group of such operators conceive the idea of getting together and not only bettering their conditions but making theirs one of the outstanding industrial developments of the time. Among a few who conceived this thought were such men as Milton Dorman and Fred Pruter. They presented their problem to Colonel Alex-
(See Page 22)

1. PLAN

The plan shown is the architectural layout approved by the Apparel City corporation and submitted to the Site Engineer for use in laying out streets and improvements. The plan indicates the varied possibilities for individual front arrangements within the framework of the long one-story buildings which are 100 feet in depth. A garage occupies the basement portion of the structure fronting on Industrial Avenue. The entrance to this garage adjoins the service station at the intersection of Industrial and the principal cross street of the project. The Auditorium, with its recreational facilities, is connected with a three-story structure which will house a library, a museum, and a tea room. The free-standing building in the central triangle is the six-story administration building which also contains restaurant, bar, and shopping facilities.

2. PERSPECTIVE

The perspective is a phase of the development arrived at immediately prior to final solution in the plan. The street pattern remains essentially the same but the increased demand for rental space on the part of the corporation call for a greater structure density than had been developed at the stage of this perspective. The generally open character of the project and the central grouping of the recreational and administrative facilities are illustrated in this sketch.

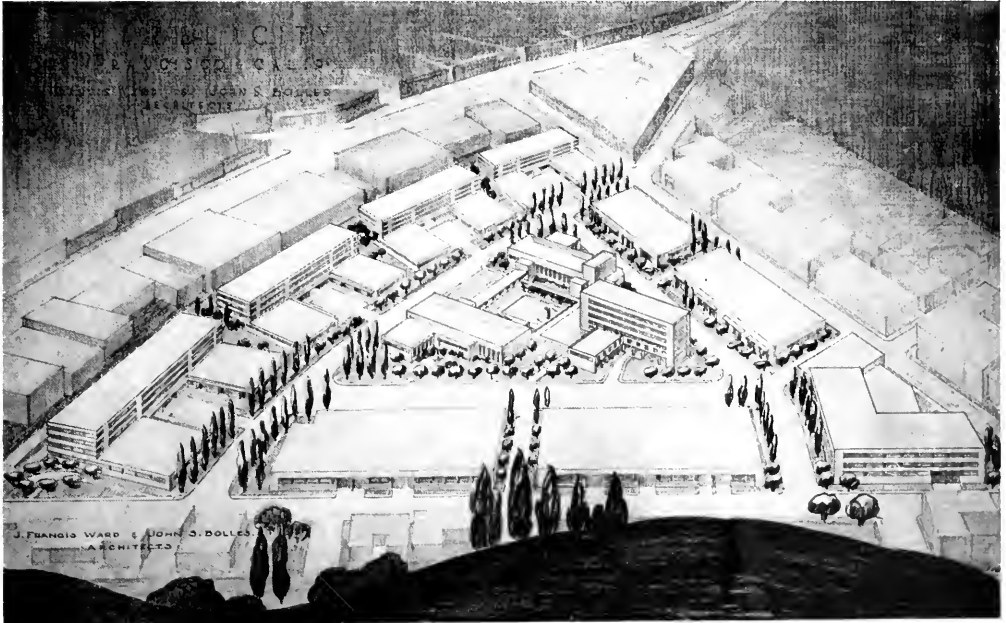

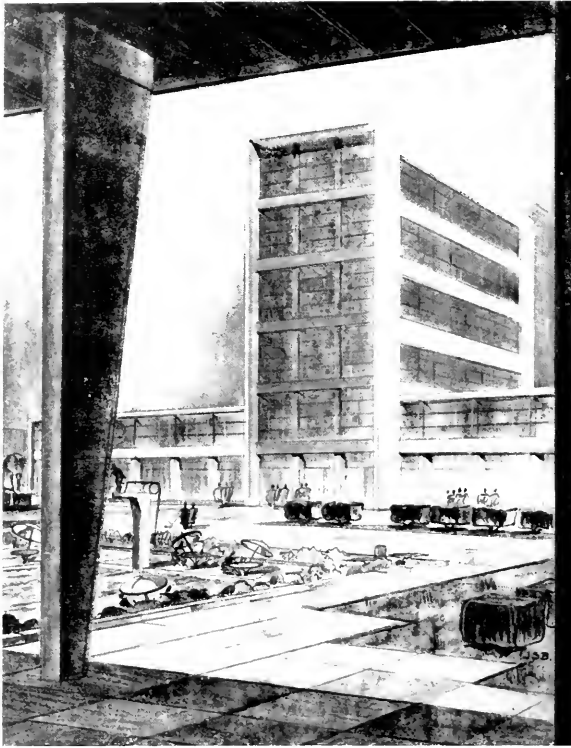

3. ADMINISTRATION BUILDING

This sketch of the Administration Building illustrates the general character of the central grouping. This building will contain offices, a drug store, and shops on the first floor, with restaurants and club facilities on the second and third stories. The balance of the building will be given over to the administrative offices of the corporation and to rental space for manufacturer's agents to sell products to the apparel industry.

BELOW:

Distinctive Individual Entrance. The Architects were faced with the problem of developing loft-type structures which would be sufficiently flexible for their exterior arrangement to permit an individual type of entrance motif without destroying the architectural homogeneity of the project.





INDIVIDUAL ENTRANCES OFFER VARIETY OF ARCHITECTURAL APPEAL



APPAREL CITY

(From Page 18)

ander Heron of the State Reconstruction and Re-employment Commission as one that they considered worthy of his attention and out of which something might be developed. It was Colonel Heron who recommended that they immediately engage their Architects and that the Architects and the manufacturers work as a team to accomplish the desired end.

After a number of conferences, the general size and nature of the project and the desired locations were established. Estimates were set up, the corporation formed, land acquired and preliminary layouts and sketches made. Several sites were considered but the final selection was the 32 acres bounded by Oakdale, Industrial, and Loomis Avenues, in the Islais Creek district near Bayshore and Alemany Boulevards. It was recognized that all the buildings would have to be placed upon piling, but the low land cost offset this increased construction expense. Needless to say, there were a number of small land owners within the area who became holdouts and who were most difficult to deal with. Fortunately, these

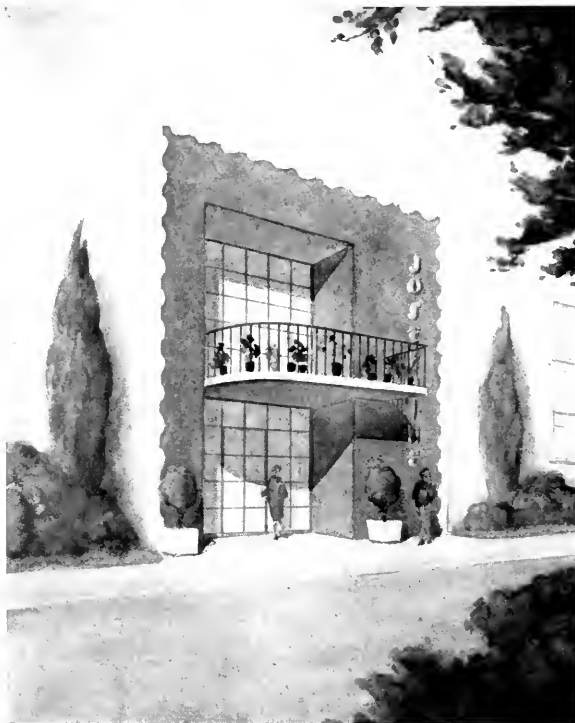
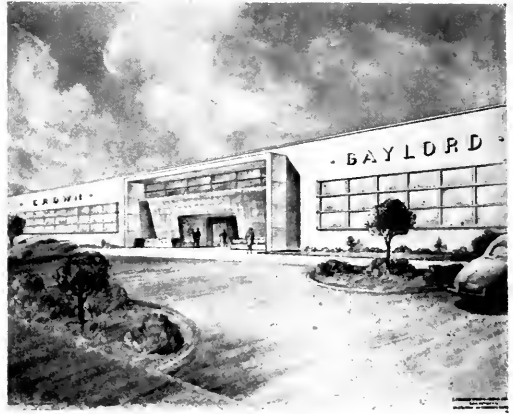

**SKETCHES OF
INDIVIDUAL ENTRANCES**
Showing architectural design
which permits development of
spacious lofts for manufactur-
ers' use without destroying
likeness of over-all project.

**FURTHER STUDY
OF UNIQUE
ENTRANCES**

**Which permit manufacturers
individuality and appeal and
yet conform to structure
types throughout the entire
32-acre project.**

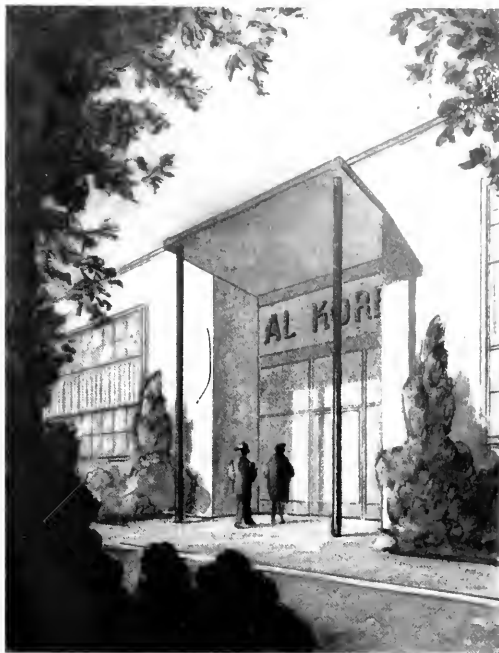

areas were not so big but that the added cost asked could be compromised in the interest of both parties.

The City Planning Commission, the Department of Engineering, and the Board of Public Works, were kept informed of developments since the project was of such magnitude that it materially affected the city's interests in that area. The State Department of Public Works, Division of Highways, under Colonel Skeggs, cooperated to the extent of outlining the proposed clover leaf development at Alemany and Bayshore which would lead into Industrial Avenue and in that way serve the project. The San Francisco Department of Public Works had proposed the opening of Tolan Street. They obligingly abandoned this in favor of another street. Problems also arose regarding intersecting adjacent streets and the necessity of closing some streets within the area. All of these details took time, patience, and cooperation, and, at all times this cooperation was forthcoming from the city and the state.

It was the desire of the owners to keep the project as open in character as possible. The industry, in itself, requires constant light from an artificial source. Sunlight was considered only in its relation to the workers' welfare and to the attractiveness of the project. The garment industry comes in the light manufacturing class and
(See Page 38)



GOOD GARDENING

By Albert Wilson, Botanist

As gardeners we work in the authority of Nature, we work with her materials. We have five co-workers.

1. Soil is the first of these. With certain adjustments we can find soil for most plants in California. A deep loamy soil permits good root development, and lush green growth above ground. A shallow soil grows dwarfs. Soil is as deep as its roots can penetrate, and properly spaded soil enables the roots to travel far. The gardener must know his soil, must know when to dig it, when to leave it alone, when and when not to weed it. If it is adobe, clay, or inclined to be heavy, he will not work it wet, for it will turn to putty, and not a root will grow. Where planting is to be done, prepare the soil thoroughly, and loosely, for plants cannot be hammered into the soil.

2. Humus is our second co-worker; (Rotting oak leaves, compost materials, grass cuttings, vegetative materials returning to the soil makes up humus). Humus is the guardian and guarantor of soil fertility; it is the prime agent of soil production. The ideal form decaying organic matter contributes much to plant welfare. For example, as it breaks down, it releases and contributes its quantity of the essential elements; (there are 10). Further, it holds moisture and provides tiny paths for water through the soil. Humus feeds the useful bacteria, and creates happy homes for mould, fungi, and earthworms, all agents for healthy plant growth. A free use of humus must be made every time there is planting to be done, generous amounts of leaf mold, compost and straw should be worked into the soil. Peat breaks up adobe, oak leaves

loosen any soil. What the gardener strives for is a fluffy soil; one that literally foams through the fingers at planting time. Roots newly planted will then penetrate far and the plant becomes established in vigor. Sand is no substitute for humus, sand, remember, makes cement, and no root grows in cement. The wise gardener will spread humus as the mason spreads his plaster. Humus is the greatest friend of good gardening.

3. Water is our third helper. Water carries to the root ALL of its food, it must always be available. Water must move continuously on the soil and move away, for plants demand drainage. Gardeners must learn both to turn on the faucet and turn it off. Water reaching the deepest roots encourages vigorous growth. Gardeners build basins around their older plants and through them, direct the water to the roots. For annuals and perennials a misty spray imitating the rain is a more kindly method of getting the water to the roots. The desert offers its plants unmerciful competition for water; be sure you do not offer your garden plants such an existence. Water must be in proportion with other essentials. Too much makes a soggy soil, soggy soil is sour and cold and in it roots soon die. Too much will displace the air, and every root must have air. "Air is Lord," said Hippocrates, and this goes for roots as well as for lungs.

4. Cultivation is the fourth helper. Cultivation enables air to reach the roots, it prevents water-logging. Gases such as carbon dioxide must be liberated from the soil and oxygen must become a part of the soil atmosphere. Some of the world's greatest gardeners maintain soil fertility primarily by cultivation and the free use of organic materials. The sun's baking the year before, stores food in the soil, but the use of the hoe well and

(See Page 34)



THE HOUSE ALONE—Before

Home of Albert Wilson, Botanist and Landscape Gardener, Ralph Wyckoff, San Jose, Architect.



THE GARDEN AND THE HOUSE—After

The vine must never cheat a wall of its character, nor take away the charm of changing shadows upon its face.

MARBLE MEN - Architects

Hard Guys and Softies

*Excerpts from an address by Mr. James R. Edmunds, Jr.,
President of the American Institute of Architects, at the
Annual Dinner of the National Association of Marble Pro-
ducers in Knoxville, Tennessee, in October.*

Strangely enough these two are really kinsmen, having a common ancestor. The master mason, who flourished 4000 B.C. in Egypt until (comparatively speaking) yesterday and who furnished all the design quality as well as construction ability required for the "permanent" structure of his time, is the progenitor of us both.

These earliest examples of architecture, what you would now call "public works" were confined largely to tombs and temples; both for the upper strata of society. The common man had but little part in their enjoyment though he furnished all of the sweat and strain; the master mason, the brains.

Later, in Greece, the master mason and architect were trained primarily as sculptors; marble was their medium of expression. With it they produced an architecture which has never been excelled before or since. It was subjected to a refinement far too subtle to be taken into account by the early artisans of Egypt or by the present day modernists to whom "time is of the essence".

Here again, in Greece, the buildings produced in the Age of Pericles were almost entirely of a public nature; tombs, temples and an occasional amphitheatre. In contrast with Egypt, however, they were enjoyed by the entire populace and were erected not by slave labor toiling under a tyrannical despotism but rather by an enlightened and free thinking people who gave generously of their time, labor and skill to erect to their gods these monuments, which have so influenced our own architecture through the ages, even today, and will perhaps (modernists to the contrary) continue to do so for many centuries to come.

In Rome, the master mason or architect had many more diverse problems to solve and a more flexible method of "spanning the void" than the simple post and lintel, the only principle understood and used by their predecessors.

The Roman mason produced the arch. From the arch he evolved the vault which made possible spanning large spaces under a lofty roof, completely free of interfering columns. In these buildings the art and skill of the accomplished

marble and stone worker are still in evidence, though they have been subjected to many ravages of war, time, weather and even the vandalism of curio collectors.

After the fall of Rome, progress in building and architecture took many centuries to become again progressive. Its first faltering steps in the early Christian Era are exemplified by the re-use of material taken from buildings fallen into decay. From these weak beginnings there developed a most glorious style and one which exemplifies the age-old and fundamental conception that the building should express its use and structural quality. The cathedrals of Europe, particularly in their later development, took but little from precedent except the principle of the vault. The emergence of Gothic architecture from the chaos following Rome's fall presents one of the most amazing pictures in our world history. Full credit for this must be placed with the master mason whose was the responsibility, not only for the design, but for the construction.

The beautiful lacelike form of Gothic vaulting and tracery stem from honest efforts to express the functional value and fabrication of the medium employed. In its time, therefore, Gothic architecture was the conscious effort to attain the same objective presently professed by the modernists of our own time; and a highly successful one.

The Renaissance adopted motives and structural principles from all of its predecessors. Walls constructed of masonry still supported the load.

Later, in our times, the masonry wall lost its position as a necessary structural member which supports the load. The steel or concrete frame has become the skeleton of most of our buildings and the masonry is but a skin stretched upon it.

The difference in technique presented by the steel or concrete frame has required many changes in masonry methods and has posed new problems. Some of these have been adequately solved. There are many that still require solution. The architect, the mason and the producer of material of today are engaged in a joint effort to improve both methods and materials available and to learn better how to use them successfully in combination.

(See Page 31)

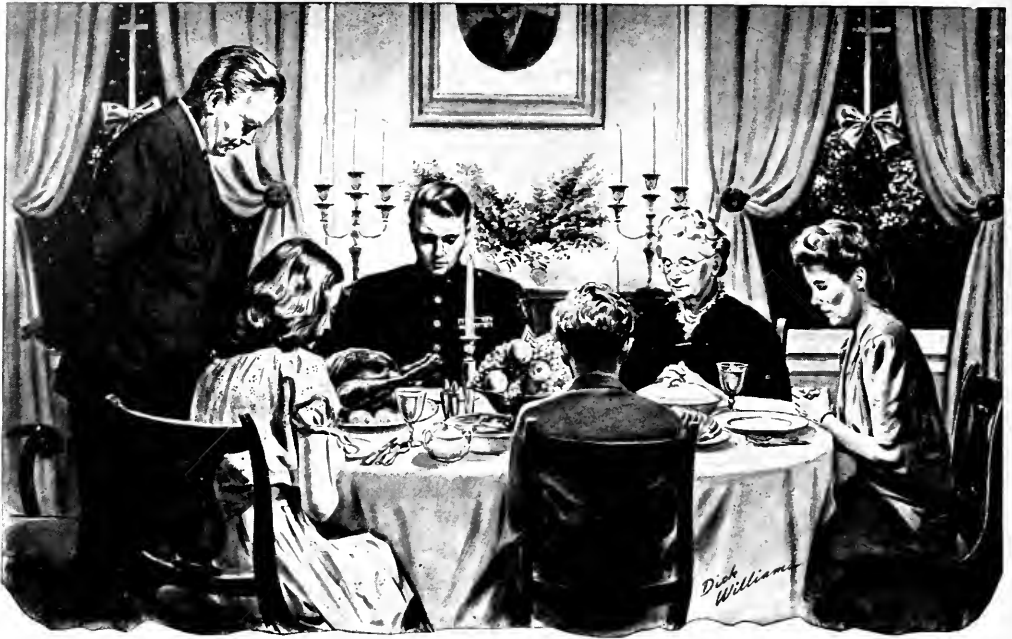

What's the other thing we ought to do this Christmas ?

FOR the last four years, the Christmas phrase "Peace on earth, good will to man" has had a pretty hollow, bitter ring.

This year, it won't.

And surely, one thing each of us will want to do this Christmas is to give thanks that peace has finally come to us—both peace and victory.

One other thing we ought to do:

in our giving, this year, let's choose—first—the kind of gift that helped to bring us peace and victory and will now help us to enjoy them.

★

Victory Bonds take care of the men who fought for us—provide money to heal them, to give them a fresh start in the country they saved.

Victory Bonds help to insure a

sound, prosperous country for us all to live and work in.

Victory Bonds mean protection in emergencies — and extra cash for things we want to do ten years from now.

★

Choose—first—the finest gift in all the world, this Christmas.

Give Victory Bonds!

Give the finest gift of all - VICTORY BONDS!

ARCHITECT & ENGINEER

★ This is an official U. S. Treasury advertisement—prepared under auspices of Treasury Department and War Advertising Council ★

ARCHITECT AND ENGINEER

HEADLINE NEWS & VIEWS

By E. H. W.

Announcement that the Nathan-Dohrmann company have acquired a long term lease of the property at 281 Geary Street, San Francisco, and will rebuild the building to represent one of the largest and finest specialty stores in the Nation is typical of many postwar plans throughout the Pacific Slope States.

* * *

Construction in the eleven western states continued on an even keel without being upset by the sudden ending of the war and the cancellation of war contracts, according to WESTERN BUILDING reports. In some areas volume increased.

* * *

Mrs. Dorothy Rosenman, chairman of the National Committee on Housing, and wife of Presidential Adviser Samuel Rosenman, declared upon returning from a recent trip to England, "The British government now has the power to control architecture and it is going to control the architecture of private as well as public building."

* * *

The Aviation Department of the San Francisco Chamber of Commerce under the direction of Kenneth R. MacDonald, is doing an outstanding job of converting "war time aviation" to peacetime practice through cooperation of the Bay Area Aviation Committee.

* * *

Los Angeles ranks third, San Francisco ninth, and Seattle eighth among the twenty cities of the United States having the greatest building permit values for the first eight months of this year. New York City takes top position.

* * *

A \$20,000,000,000 bond issue was approved by voters of San Francisco at the November election, funds derived from the sale of bonds are to be used in expanding and building the San Francisco Airport.

* * *

U. S. and British air raids on Germany during the war destroyed or heavily damaged 3,600,000 dwelling units (20 per cent of all German housing), made 7,500,000 people homeless, killed 300,000 and injured 780,000, according to a report just released by the War Department.

* * *

Los Angeles continues to lead the West in building volume since V-J Day, while Seattle, Portland, San Francisco, and Oakland continue substantial increases.

CONSTRUCTION DEMAND

The tremendous pent-up volume of construction demand which the end of the war released is exhibited in October building in the eleven western states as reported by the publication Western Building's Monthly Statistical Survey. Also demonstrated was the great resourcefulness of the construction industry in being able to increase the volume of building in spite of the low level of lumber building material stock in retail and wholesale yards.

According to the survey, valuation of construction in 170 western cities was 234.42 per cent above the valuation for October 1944. These cities reported \$54,343,016 of construction, with 22,668 building permits being issued; in October a year ago building volume for these cities was reported at 16,250,071, with 14,818 permits being issued. Thus, while dollar volume was raised 234.42 per cent, number of permits issued went up 52.98 per cent.

For the second straight month the first ten cities in construction volume in the west reported volume in excess of a million dollars. The twenty-five leading construction cities of the west give good indication of the extent to which building is getting under way against the odds of material shortage. October's volume for these twenty-five leaders stood at \$34,983,501, an increase of 37.63 per cent

Expert *Mechanical Equipment*

- HEATING
- VENTILATING
- PLUMBING

Complete mechanical installations
in large and small office buildings,
theaters and manufacturing plants.

ALL TYPES OF INDUSTRIAL WORK

JAMES A. NELSON CO.

Since 1908

1375 Howard Street, corner Tenth Street
San Francisco, Calif. Phone: HEmlock 0140

We Extend **Holiday Greetings**

*to our many friends in the
Building Industry
whom we have served for
nearly thirty years.*

Since 1906



**CONCRETE STEEL REINFORCING
BARS AND ACCESSORIES**
Fabricated and Installed

DISTRIBUTORS FOR

THE SISALKRAFT CO.

Sisalkraft Reinforced Paper

KERLOW STEEL FLOORING CO.

Steel Gratings for power plants,
bridges, etc.

WM. F. KLEMP CO.

Hexteel and Acme Steel Floor
Armor

CALROCK ASPHALT CO.

Asphalt Floor Paving Blocks —
pressed under 22000 lbs. sq. in.

THE DURAFLEX CO.

Duraflex Mastic Flooring

L. M. SCOFIELD CO.

"Permalith" Cement Color
Hardener

KIMBERLY CLARK CO.

"Kimsul" thermal and sound
insulation

SAMUEL CABOT INC.

Collopakes, Creosote Stains, Double
White, Old Virginia White, Tasgon,
Lubri-tasgon

PLASTIC LINING CORP.

L. T. 700, non-corrosive plastic paints

AMBASSADOR VENETIAN BLIND CO.

Venetian Blinds, wood or steel

BENNETT-IRELAND

"Warm-Aire" Fireplaces



GUNN, CARLE & CO.

20 POTRERO AVE.
SAN FRANCISCO
Underhill 5480

over September when these leaders reported \$25,418,465. The October 1945 volume of the twenty-five leading cities was up 207.60 per cent above the same month a year ago.

Los Angeles (incorporated area) led all the cities of the West in building during October, with a permit volume of \$11,186,134. Denver reported \$2,843,680. Grouped closely between the one million and two million mark were San Francisco, Oakland, Long Beach, Portland, Vancouver, B. C., San Diego, Seattle and Spokane.

Illustrating the nature of this flood of construction is the city of Spokane, Washington, with an October volume of \$1,158,037. This figure, almost as great as this city's entire building volume for ten months of 1944, included only 51 residences. Most of Spokane's volume during October was industrial in nature, with warehouses, oil and trucking station developments taking the lead.

HENRY DAVID KENSIT, architect, has opened offices in the Post Office Building, Los Gatos, California. Is interested in receiving manufacturers' publications.

PARAFFINE COMPANIES ELECT

Two new officers were added to the Board of Directors of the Paraffine Companies, Inc., at the recent annual meeting of the corporation.

J. E. Holbrook was named vice president in charge of sales, and R. R. Marsh was named vice president in charge of overseas trade.

The following officers and directors were re-elected:

Officers: R. S. Shainwald, Chairman of the Board; W. H. Lowe, President; R. H. Shainwald, Executive Vice-President; C. C. Gibson, Vice-President and Treasurer; F. M. Tussing, Vice-President, Manufacturing; J. E. Holbrook, Vice-President, Sales; R. R. Marsh, Vice-President, Overseas Trade; A. W. Brown, Secretary; Jean Holmes, Assistant Treasurer; D. B. Strain, Assistant Treasurer; M. F. Stires, Assistant Treasurer; R. E. Dexter, Assistant Secretary; J. F. Haynes, Assistant Secretary.

Directors: Bruce F. Brown; C. C. Gibson; W. H. Lowe; J. B. McCargar; Robert W. Miller; D. J. Murphy; Silas H. Palmer; Herman Phleger; Henry Rosenfeld; R. H. Shainwald and R. S. Shainwald.

William F. Durr, Architect, has moved from Sepulveda Building, San Pedro, to 920 13th Street, San Pedro, California.

Herbert T. Johnson, Architect, has moved from 4716 Reinhardt Drive, Oakland, to 4225 Gregory Street, Oakland, California.

A. I. A. ACTIVITIES



The San Francisco Chapter of the American Institute of Architects has devoted most of the space in its last Bulletin to the activities of the Institute's Washington representative, who has been most active in the interests of the profession in the Capitol. At the present time he is busy in a joint effort with the National Association of Home Builders to bring about "a satisfactory relationship between the architects and home builders." He closes his report with the comment that the pressure created is more for draughtsmen than for architects, a pressure that we on the Pacific Coast can fully understand.

In an item on the Construction Industry, Mr. Samuel E. Lunden, vice-president of the Institute, makes the following statement: "This is the only state in the Union where Architects and Engineers are not allowed to design State work. This situation does not belong with the Architects alone. We all voted for it and probably did not know what it was at the time." That is a sad commentary on the supposed intelligence of an old and honored profession.

THE SOUTHERN CALIFORNIA CHAPTER very logically went to some length in the study of RECREATION FACILITIES. While it is true that Los Angeles presents more areas for year-around outdoor recreation than does San Francisco, a similar study and report on "Parks, Beaches and Recreation Facilities" to augment the report of this city's Mr. Tilton would not be amiss, particularly if they are done along the lines of the one released by the Haynes Foundation on Recreation Facilities for Los Angeles County. The October meeting of the Southern Chapter was given over largely to Mr. Paul Hunter's presentation of Monocoque Construction, which he explained as the building of the exterior of an egg, according to the French dictionary. Anyhow, the principle was used brilliantly by Wallace Neff in the construction of his "Balloon House." The principles are too involved to enter into here. Suffice it to say that they were and will be used in the construction of the concrete ship.

The Los Angeles Chamber of Commerce is advocating the construction of a new, fully equipped civic auditorium designed to hold the largest national meetings and their accompanying trade exhibits.

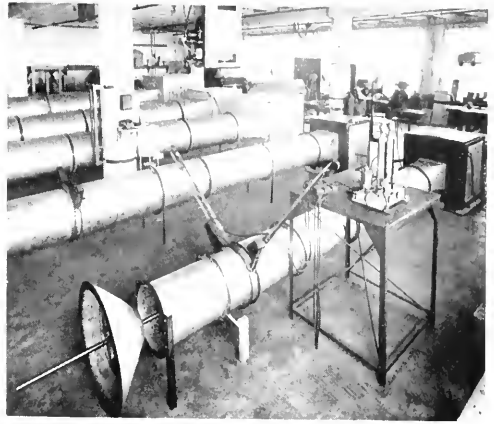

UTILITY AIR COOLERS

*are scientifically tested
in our modern laboratory*

Utility Air Coolers, Fans and Blowers are tested for accuracy and efficiency in this most modern and complete laboratory, in accordance with American Society of Heating and Ventilating Engineers' standard test code.

These extensive testing and fact finding facilities, under the supervision of competent and recognized engineers, are your assurance of properly engineered and efficient products, coming from Utility Appliance Corp.

UTILITY

UTILITY APPLIANCE CORP.

Formerly Utility Fan Corporation

4851 S. Alameda St., Los Angeles 11, Calif.

Manufacturers of Evaporative Air Coolers, Blowers, Fans, Forced Air Furnaces, Circulating Heaters, Unit Heaters and Floor Furnaces.



PROPELLER FANS



EVAPORATIVE AIR COOLERS



SPACE HEATERS



FORCED AIR FURNACES



BLOWERS



FLOOR FURNACES

WITH THE ENGINEERS

A PUBLIC RELATIONS program designed to acquaint the general public with the work of civil engineers has been inaugurated by the American Society of Civil Engineers, according to Col. William N. Carey, secretary and executive officer.

The story of the engineers at war and their essential part in postwar reconstruction throughout the world will be emphasized in the program which is to be carried out from the Society's New York headquarters.

LT. COL. PHILIP I. BAKER telephoned from Switzerland to his wife in San Mateo last month. He served with General Patton's Third Army and expects to be in Bavaria for some time.

CONSTRUCTION INDUSTRY CONFERENCE in San Francisco on Oct. 3, was a remarkable success, due largely to the part the SEANC members played in the arrangements. Many of our members took part in the discussions and 29 attended the banquet.

CLARENCE H. KROMER is now located with the United States Engineers as a civilian doing important investigation of the water resources of California. His telephone number is Sacramento 6-1367.

EDWIN A. VERNER has become associated with

Frank Wynkoop and Associates in Room 909 Pacific Building, 821 Market St., S. F., Telephone YUkon 1761.

LEON H. NISHKIAN has been nominated for vice president of the San Francisco Section, American Society of Civil Engineers. According to established procedure, Theodore P. Dresser, Jr., will become president of the local section, A.S.C.E., next year.

J. B. WELLS has been Acting Dean of the School of Engineering at Stanford University during the summer. We hope soon he will be Dean of the School of Engineering.

EARL C. THOMAS is now operating under the firm name of Thomas and Whipple, Consulting Engineers, 310 University Ave., Palo Alto, Calif. Tel. P. A. 5177.

AL BRINCKMAN is now with Lumber Distributors, Room 674 Monadnock Building, Market Street, Tel. YUKON 1372.

JARO J. POLIVKA has been very favorably described in THE SLAVONIC MONTHLY of New York City.

JACK Y. LONG, previously with Kaiser Engineers, is now established as Consulting Engineer in Oakland. Address: 1928 Trombas Ave., San Leandro.

F. W. PANHORST was recently elected a director of the American Society of Civil Engineers, San Francisco Section. Our congratulations!



IT'S ZONE-CONDITIONED

Residence of Mr. and Mrs. Karl R. Levy
Wainwright Hills, California
Architect—Allen Rusoff
Builders—Pallock & Brown

This house has *four furnaces* . . . not bulky, heavy heating plants, but compact, streamlined PAYNE units. Each is separately controlled, enabling the owners to vary their "indoor climate" as desired, by "zones," according to need and weather. ★ That's the *modern* conception of heating and ventilation, as pioneered by PAYNE . . . the modern successor to old-fashioned central heating . . . PAYNE ZONE-CONDITIONING. Write for descriptive booklet.

PAYNE FURNACE COMPANY
(One of the DRESSER Industries)
BEVERLY HILLS, CALIFORNIA

PAYNEHEAT
OVER 30 YEARS OF LEADERSHIP

**GAS FUEL
(AIR)
EVERYTHING**

MARBLE MEN

(From Page 25)

Program of Cooperation

To this end, the Producers' Council and the American Institute of Architects have initiated a program of cooperation which I will briefly outline to you.

It had been long felt, by the Board of the A.I.A. that the Institute's contribution to the advancement of the technique of building was far from commensurate with its importance. A report of the Joint Technical Committee of the Producers' Council and the Institute, established in 1944, for the purpose of better coordination of the efforts of our two organizations in this field, focused attention upon the accomplishment of the Institute's Department of Technical Services, of which the full use by the membership, had not been realized.

A technical Service Committee was established; its work provided by voluntary membership personnel soon proved to be inadequate. The affiliation between the Institute and the Council resulted in the creation of a Scientific Research Department, later the Structural Service Department and still later the Department of Technical Services.

It is the present intention of the Board to invigorate, insofar as available funds may permit, this important phase of the Institute's work. With the help and advice of the Producers' Council, the Board intends to reorganize and enlarge the Department's activities by: (1) stimulating exchange of ideas and experience in technical matters among our membership; (2) Making available to the members unbiased information concerning materials and construction methods; (3) Supervising laboratory tests of new building material and methods; and (4) Putting such information within easy reach of those of us who want it.

To implement this, the Board intends to appoint a Research and Educational Director, whose full time will be devoted to Institute matters, of which the technical phase forms a very important part. We propose as well to provide him adequate staff. It is hoped by the first of the year this will be a "fait accompli".

One of his first concerns will be with the education of the architect and the builder, as well as the producer of material in the matter of "dimensional coordination".

Bemis Foundation

Such endeavors, if supported and utilized by our profession should prove of great value to it, to the producer of material, and though indirectly, **what is more important, to the building public.**

The days of the "long haired" architect are gone. We must frankly admit that much of the public disrespect we enjoyed in the recent past was honestly earned.



"built-in telephone outlets are inexpensive"



A plan that includes built-in telephone facilities is practical for even modest building budgets. Conduit installed during construction adds

little to building cost...and enhances future value. Even though only one telephone is needed immediately, others may be added later without tearing up the



flooring or bringing wire in along baseboards. ◀ Your clients will approve your foresight in planning built-

in telephone outlets. You are welcome to call on our Architects' and Builders' Service for any needed help at no cost.



The Pacific Telephone and Telegraph Company



MOORE & ROBERTS

Builders

Member Associated Contractors
of America

693 MISSION STREET
SAN FRANCISCO
GARfield 8579

OAKLAND

Too often he considered himself as one who should not be too deeply concerned with many of the phases of the construction industry. This included, at times, the economic soundness of the project in hand, its social value even its approximate cost and in fact almost anything which presented a problem, the answer to which could not be found in "Vignola" or "Concours d'Architecture". These days, thank God, are past.

Today the architect, if he properly conceives his position, finds himself but a part of a much larger field than just architecture: he is a component part of the **construction industry**. With him in this large sector of our national economy are labor, both common and highly skilled, producers of and dealers in material, contractors and sub-contractors, home builders, finance organizations and real estate brokers. It behooves him to fully appreciate this and the responsibility it entails.

The long awaited postwar period is here. It presents great opportunity. It also presents us with grave responsibility. To the architect, what he does and how well he does it during the years just ahead will influence his own status and that of our profession for many years to come.

There is a surging demand for building and rebuilding which will test to the utmost the ability, the diligence and the imagination, not only of the architect, but of all of us in the building industry. As an industry, we are secondary only to agriculture and provide more than ten per cent (10%) of our national economy.

As such we are expected to provide employment for not only the returning veteran, but for those released from war plants. To accomplish this we must needs be prepared to act in unison. Cooperation is mandatory if the industry is to meet the demand upon it.

If the construction industry fails to meet the opportunity presented, the architect will fail with it. The problems of other sectors of the industry are just as surely his own and what contribution he can make to their solution, is in his own interest. We are all in this "jam" together, let's make sure we pull out together and do not fail.

PRESIDENT

T. A. Crawford, general manager of Timken Silent Automatic Division, Timken-Detroit Axle Company, was elected president of the Indoor Climate Institute at the second annual meeting of the group recently held in Detroit.

L. N. Hunter, National Radiator Company, was named vice-president and R. E. Moore, Bell & Gossett Company and E. N. McDonnell of McDonnell & Miller, were re-elected secretary and treasurer.

Heating and air conditioning will command much attention in future home building, officials of the Institute predict.

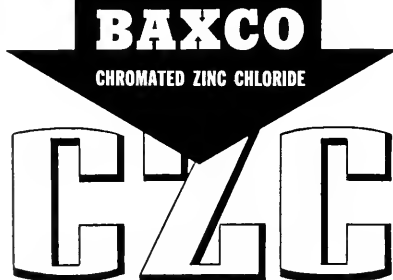

PRESSURE TREATED LUMBER
• **PROTECTS AGAINST DECAY**
AND TERMITE ATTACK

Specify it in your home
Available through Lumber Dealers

LOS ANGELES
601 W. 5th Street
Phone Mlchigan 6294

SAN FRANCISCO
333 Montgomery Street
Phone DOuglas 3883

J. H. Baxter & Co.

AGENTS FOR WEST COAST WOOD PRESERVING CO. SEATTLE, WASH.

IN THE NEWS

HOUSE BUILDING SET-BACK

Home construction on an unrestricted peacetime basis has been delayed as long as a year because of the strike of A.F.L. lumber workers, a survey of building industry spokesmen recently indicated in Portland, Oregon.

Resumption of full-scale building in Middle West and Eastern States depending on lumber imports from Oregon may be stayed as long as 18 months.

The survey, made by the Portland Oregonian, large daily newspaper, quoted contractors, architects and lumber wholesalers reporting building costs up 50 to 65 per cent over 1939, with little prospects of declining for many months.

The survey was made as 60,000 idle A.F.L. sawmill and lumber workers entered the eighth week of their strike for higher wages.

PARTNERSHIP FORMED

Frederick H. Meyer, F.A.I.A., and Albert J. Evers, A.A.I.A., have announced the formation of a partnership to engage in the general practice of Architecture.

Offices of the new association will be located in the Kohl Building, Suite 1201, California and Montgomery Streets, San Francisco, California.

POSTWAR LIGHTING BOOM

At a recent meeting of the Northern California Section of the Illuminating Engineering Society, D. W. Atwater, Bloomfield, N. J., told members only "twenty-five per cent of the nation's stores are now lighted by fluorescent sources."

He predicted seventy-five per cent of America's stores will be fluorescent lighted five years after V-J Day.

CLARENCE W. W. MAYHEW, architect, now located at 127 Montgomery Street, San Francisco, is in need of an architectural draftsman.

CHRISTMAS TREE LIGHTS

Something new in the way of Christmas Tree lights will be available this year, according to the Sylvania Electric Products Company, who announce a round fluorescent bulb especially designed for Christmas tree lighting.

Available in coral, blue, green and maize the lamps give a soft, attractive glow to the tree and are manufactured eight to a string.

They are designed for either indoor or outdoor trees.



*Christmas
Lights
to say*

WELCOME HOME!

This Christmas, of all years, millions of tiny, colorful Christmas lights all over America will say "Welcome Home" to our valiant sons, returning from the darkness and desolation of world battlefields.

On trees and shrubs, on streets, in public parks—but, most of all, in homes—these twinkling lights will tell how glad we are to see them—will symbolize our gratitude, too deep for words.

And like bright stars, brought close to earth, they will proclaim our heartfelt wish for lasting peace, good will toward men.

**NORTHERN CALIFORNIA
ELECTRICAL BUREAU**

1355 Market Street

San Francisco 3

*Be sure you're getting the
finest window glass obtainable*

it costs no more to specify

PENNVERNON

Distributed by...

W·P·FULLER & CO.
PAINTS • GLASS • WALLPAPER

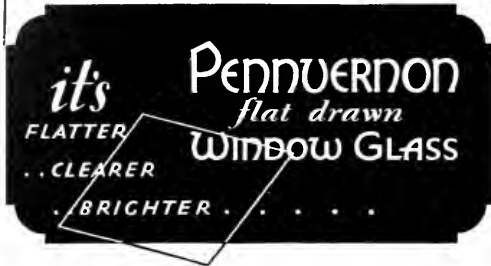

PAYNE FURNACE EXPANSION

Payne Furnace Company, for three years engaged in war production and now well along the road to reconversion, has launched a quarter-million-dollar expansion and building program, designed to double production of its gas-fired heating equipment, E. L. Payne, president, announced.

The plan contemplates the immediate construction of two additions to the factory, totaling 64,000 square feet, and the installation of the most modern new machinery and equipment, such as a battery of paint-drying ovens and conveyor systems to speed line-production and loading. The objective is to fill orders as soon as received, contingent on availability of materials, the announcement said.

"At present," Mr. Payne added, "the company has a backlog of orders equivalent to an entire prewar year's production, which, together with new orders being received daily, indicate unprecedented nationwide demand for gas furnaces, as new construction and remodeling hit their stride."

"Payneheat," said to have achieved prewar leadership as America's largest producer of gas furnaces exclusively, is affiliated with Dresser Industries, Inc., a nationwide group of manufacturers.

GOOD GARDENING

(From Page 24)

deep, brings out of the earth the stored food of last year's sunshine. Cultivation maintains a loose soil, it checks any tendency toward cement-like hardness.

5. Fertilizer is our fifth helper. Dairy fertilizer is the best for our plants. It provides food for the soil and food for the plant roots. It brings into the soil, if in sufficient quantity, an enriched humus bulk. When applied 3 to 6 inches deep it will loosen the soil and enrich the moisture at the root zone. Chemical fertilizer is used additionally, applied during the season of vigorous growth and often in liquid form. Proper use requires thorough study. Chemical fertilizer may complement the organic manures, but they must never replace them. But manure will never do its best without the help of LIME or gypsum. There is an old adage, "It is a poor farmer who uses manure but no lime." Lime is the governor of the soil, and all gardeners must awake to its place in nature's scheme. It is not a fertilizer—it merely conditions the soil for the dress of manure. Generally an application spread on the dry ground once in three years will do the trick. Manure should follow the lime; it must never be placed on the ground with it.

*GOODS OF THE WOODS



E. K. WOOD
LUMBER COMPANY

LOS ANGELES
SAN FRANCISCO
OAKLAND

**WE MANUFACTURE
OR SUPPLY**

- DOUGLAS FIR
- REDWOOD
- SUGAR PINE
- PONDEROSA PINE
- SASH AND DOORS
- MILLWORK
- MASONITE TEMPERED PRESWOOD
- CONCRETE FORM PANELS
- CEMENT ASBESTOS BOARD
- INSULATION AND INSULATION BOARD
- INSULATION TILE AND PLANK
- PLASTER BOARD
- FIR-TEX INSULATION PRODUCTS
- TRIPLE-SEALED GYPLAP
- SISALKRAFT BUILDING PAPER
- ROOFING
- WOODLIFE WATER REPELLANT
- BUILDERS HARDWARE

DEPENDABLE QUALITY

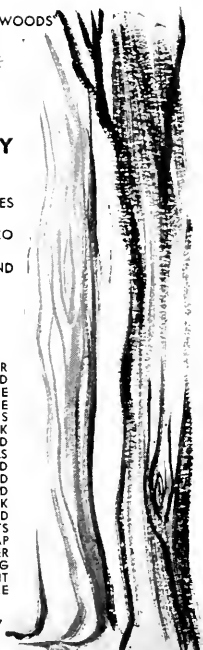

IN THE NEWS

GAS RANGE JUDGE

Gardner Dailey, San Francisco architect, has been named one of four architects and designers throughout the nation which will judge the \$18,000 Magic Chef Gas Range design contest being sponsored by the American Stove Company, in cooperation with a national architectural publication.

QUICK CHANGE BOOM

A simple, easily constructed boom attachment enables use of an ELWELL-PARKER ELECTRIC COMPANY high-lift platform truck for a wide range of intermediary transportation jobs.

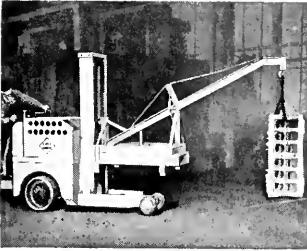

Raw materials, light and heavy weight parts are easily handled by the attachment, according to users.

Trucks and booms are built in the Elwell-Parker Electric Company's Cleveland, Ohio, plant.

NEW ADHESIVE

A new room temperature setting resorcinol adhesive which develops the joint strength, moisture resistance and durability usually associated only with hot press phenolics is announced by the RESINOUS PRODUCTS & CHEMICAL COMPANY of Philadelphia, Pa.

Known as AMBERLITE PR-115, the resin is suited to bonding applications where speed of cure, good adhesion to relatively impervious surfaces, good gap filling qualities and the ultimate in durability are important. Supplied in solution form. Complete information upon request.



Available with or without hanger.
Uses four 40 W. fluorescent lamps.

PLASCOLIER

A new shielded luminaire that is now in production by Smoot-Holman. Extremely efficient, combining minimum surface brightness, maximum diffusion, low absorption. Lightweight plastic diffuser is safe to handle, no breakage hazards. Write for Catalog Supplement No. 22.



Offices in Principal Western Cities—Branch and Warehouse in San Francisco

PRODUCERS' COUNCIL PAGE

Northern California Chapter

The National Organization of Manufacturers of Quality Building Materials and Equipment

Affiliated with the AMERICAN INSTITUTE OF ARCHITECTS

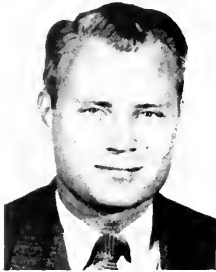

PAUL HERSHEY

Paul Hershey can lay claim (he didn't, so we will for him) to being the first veteran of World War II to join our Chapter ranks. Paul, who was honorably discharged from the Infantry in June of '43, rejoined Armstrong Cork Co. at Lancaster, Pa., his home

town, and was assigned to their San Francisco office in May of last year.

His duties there cover contacts with Architects, Engineers and Contractors on building material products of the diversified Armstrong line.

Councilwise, Paul carries on as Alternate to good friend of the Chapter, Past-President Ken Pinney, and is currently serving as a member of the Xmas Jinks Committee.

Paul was a Sigma Pi at Franklin and Marshall College, and is a member of the American Legion, among other organizations.

He is married, lives in Berkeley and enjoys fishing, hunting, bowling, tennis and swimming. His hobbies are photography and coin collecting, he says; a lot of us try that last one, but somehow the coins slip through our fingers!

Chapter No. 24 was chartered at Buffalo, New York, November 6. Coast Chapters wish the Buffalo boys well in their new activity.

New Council Brochure "Building the Future of the Construction Industry" is ready for distribution through the Chapters. It tells the story of the Producers' Council graphically and forcibly and presents a practical program for the future.

Continuing our process of making mole-holes out of modular mountains, a common question:

"Does modular grid paper eliminate the need for an architect?" is disposed of very quickly by Mr. Lorimer:

"No more than possessing staff paper will make a musician."

4" Module approved by ASA Committee A-62 and submitted by the joint sponsors . . . A.I.A. and The Producers' Council . . . has been approved by the American Standards Council and thereby becomes an **American Standard**.

Something New has been added, wherein we bring our slogan up to date. Start an Architect on a **Modular** plan now, and start the industry on the road to lower building costs. The mere fact that we have to hold conferences to discuss the subject, "Are building costs too high?" is reminiscent of the old adage anent the questionable shirt: "If it's doubtful, it's dirty." Only assurance of a continuing building market and not just a brief boom, is more value for the construction dollar.



USE QUALITY PRODUCTS



CONSULT AN ARCHITECT

IN THE NEWS

ARCHITECT LEON D. LOCKWOOD has moved from 835 South Oxford Street, Los Angeles, to 562 Sutter Street, San Francisco.

SIMPLIFIED PRACTICE—Paints

The proposed revision of Simplified Practice Recommendation, covering paints, varnishes and related products, has been approved by the U. S. Department of Commerce, National Bureau of Standards, and is now known as R144-45.

The revision represents an effort to meet post-war consumer needs.

It will increase the number of colors for some products, add small sizes and a 2-gallon size container for certain items. Copies of R144-45 may be secured from Division of Simplified Practice, National Bureau of Standards, Washington 25, D. C.

DON M. CLIPPINGER, Architect, has moved from 1177 Dexter Horton Building, Seattle, Washington, to Mercer Island, Washington.

ARCHITECT REOPENS OFFICE

Chester H. Treichel, A.I.A. Architect, has reopened offices for the general practice of architecture at 96 Cleveland Street, Oakland 6, Calif.

During the past three years Mr. Treichel was associated with the Federal Public Housing Authority in the development of War Housing projects in Region VI, which comprises the states of California, Nevada, Arizona and Utah.

NEW STANLEY WORKS BUILDINGS

Two manufacturing buildings will be added to the New Britain, Conn., plant of the STANLEY WORKS in the immediate future, according to a recent announcement by R. E. Pritchard, president.

One building will be a seven-story U-shaped structure 222 feet by 95 feet, with two wings each 77 feet by 106 feet. The other building will be six stories L-shaped 77 feet by 201 feet, with the ell 75 feet by 95 feet.

Construction will be in charge of the Turner Construction Company of New York in accordance with plans and specifications prepared by J. H. Fellows, engineer.

The STANLEY WORKS have been leaders in the hardware and building trades tools manufacturing industry for the past 93 years.

WALTER WURDEMAN and **WELTON BECKET**, architects, have moved their offices and are now located at 3757 Wilshire Boulevard, Los Angeles 5, California.

STRUCTURAL STEEL

For Class A Buildings,
Bridges, etc.

JUDSON PACIFIC - MURPHY CORP.

1200 SEVENTEENTH STREET
SAN FRANCISCO

Plants: San Francisco - Oakland

BASALITE

LIGHTWEIGHT CONCRETE
BUILDING UNITS

CHARACTER • ECONOMY • INSULATION
FIRE-SAFE • TERMITE PROOF • PERMANENCE

BASALT ROCK CO., INC.
NAPA, CALIFORNIA

SISALKRAFT

REG. U. S. PAT. OFF.

"More than a building paper"

THE SISALKRAFT CO.

205 West Wacker Drive
Chicago, Ill.

55 New Montgomery Street
San Francisco, Calif.

FORDERER CORNICE WORKS

Manufacturers of

Hollow Metal Products • Interior Metal Trim
Elevator Fronts and Cabs
Metal Plaster Accessories • Sanitary Metal Base
Flat and Roll Metal Screens
Metal Cabinets • Commercial Refrigerators

269 POTRERO AVE.

SAN FRANCISCO, CALIF.

HEMLOCK 4100

Tomorrow's Buildings NEED Adequate Wiring

OUR FACILITIES ARE TOPS
FOR HIGH GRADE ELECTRICAL
WORK THROUGHOUT THE
SAN FRANCISCO BAY AREA

RECENT INSTALLATIONS:

PERMANENTE MEMORIAL HOSPITAL
OAKLAND

BERKELEY GENERAL HOSPITAL
(Under construction) BERKELEY

MATSON ELECTRICAL EQUIPMENT CO.

3781 BROADWAY, OAKLAND, CALIFORNIA
Humboldt 1294

DESIGNED TO USE

In the development of your business . . .
now and in the postwar era.

Many subscribers to **Architect's Reports**
find these ADVANCE building surveys . . .
giving name of project, location, architect,
proposed cost and other pertinent informa-
tion a "must have" service to their business
planning.

Data furnished you DAILY at a cost of \$10
per month.

Phone EXbrook 7182 — Subscribe Today

ARCHITECT'S REPORTS

Published Daily by

ARCHITECT and ENGINEER, Inc.

68 POST STREET, SAN FRANCISCO

EXBROOK 7182

APPAREL CITY

(From Page 23)

therefore had little use for the railroad siding which borders the project on Loomis Street. With a few exceptions, practically all of the transportation of materials will be by pickup truck and express, and the actual movement, in itself, is not great. It was therefore possible to provide periphery servicing for a great percentage of the floor area.

There is one major street transversing the project but this does not cross any of the adjacent arteries. Its primary purpose is for entrance to the project. The other two streets are to serve the workers and the buyers and are designed to provide recess parking facilities. A study of the parking problem and of the transportation available on Bayshore and Alemany discloses that only a small percentage of the workers will drive their own cars.

Normally, an Architect is faced with the problem of providing maximum space within a limited, well-defined area. In this case, the Architects, while not over-endowed with space in which to work, had to strike a careful balance between the economic cost of construction of space within the structures and an appealing amount of open air and landscaping. As finally conceived, the manufacturing areas are in buildings 100 feet deep. In order to provide the approximate million feet of floor area required, this will take almost two miles of building. To accomplish this some of the buildings had to be four stories in height. In the center of the project are the servicing facilities, such as the offices of the corporation, offices for manufacturers' agents, display rooms, theatre, recreation center, swimming pool, drug stores, banks, beauty parlors and barber shops. These have been pleasantly grouped about an open court in the center of which lies the swimming pool. This pool, and its adjacent areas, will be used for open-air fashion shows, while the primary function of the auditorium is for indoor shows and buyers' conventions.

When it was originally proposed to place the project on its present site, some objection was raised because of the distance buyers would have to travel from their hotels in the downtown area. It was easy to show that the time spent by the buyer traveling by taxi from downtown to the project was less than the time normally consumed in going between manufacturers in their present locations in the congested areas. Since the project will not be downtown the most modern in comfort and convenience will be provided for the buyers and the manufacturers, with sumptuous cocktail lounges and cafes in which they can relax and discuss their problems.

(See Page 42)

ESTIMATOR'S GUIDE

BUILDING AND CONSTRUCTION MATERIALS

PRICES GIVEN ARE FIGURING PRICES AND ARE MADE UP FROM AVERAGE QUOTATIONS FURNISHED BY MATERIAL HOUSES TO SAN FRANCISCO CONTRACTORS. 2½% SALES TAX ON ALL MATERIALS BUT NOT LABOR

All prices and wages quoted are for San Francisco and the Bay District. There may be slight fluctuation of prices in the interior and southern part of the state. Freight cartage, at least, must be added in figuring country work.

BONDS—Performance—\$10 per \$1000 of contract. Labor and materials, \$10 per \$1000 of contract.

BRICKWORK—

- Common Brick—Per 1M laid—\$50.00 to \$60.00 (according to class of work).
- Face Brick—Per 1M laid—\$120 to \$150 (according to class of work.)
- Brick Steps—\$1.60 per lin. ft.
- Brick Veneer on Frame Bldg.—Approx. \$1.30 per sq. ft.
- Common Brick—\$19.00 per M, truckload lots, f.o.b. job.
\$19.00 per M, less than truckload, plus cartage.
- Face Brick—\$40 to \$80 per M, truckload lots, delivered.
- Cartage—Approx. \$4.00 per M.

BUILDING PAPER—

- 1 ply per 1000 ft. roll.....\$3.50
- 2 ply per 1000 ft. roll..... 5.00
- 3 ply per 1000 ft. roll..... 6.25
- Brownskin, Standard, 500 ft. roll..... 5.00
- Sisalcraft, 500 ft. roll..... 5.00
- Sash cord com. No. 7.....\$1.20 per 100 ft.
- Sash cord com. No. 8..... 1.50 per 100 ft.
- Sash cord spot No. 7..... 1.90 per 100 ft.
- Sash cord spot No. 8..... 2.25 per 100 ft.
- Sash weights, cast iron, \$50.00 ton.
- Nails, \$3.42 base.
- Sash weights, \$45.00 per ton.

CONCRETE AGGREGATES—

- The following prices net to Contractors unless otherwise shown.
- Gravel, all sizes—**
\$1.95 per ton at Bunker; delivered.....\$2.50
- | | | |
|-----------------------------|--------|--------|
| | Bunker | Del'd |
| Top Sand..... | \$1.90 | \$2.50 |
| Concrete Mix..... | 1.90 | 2.45 |
| Crushed Rock, ¼" to ¾"..... | 1.90 | 2.50 |

- | | | |
|------------------------------|------|------|
| Crushed Rock, ¾" to 1½"..... | 1.90 | 2.50 |
| Roofing Gravel..... | 2.25 | 2.80 |
| River Sand..... | 2.00 | 2.45 |
- Sand**—
- | | | |
|---------------------------|------|----------|
| River Sand..... | 2.00 | 2.45 |
| Lapis (Nos. 2 & 4)..... | 2.85 | 3.15 |
| Olympia (Nos. 1 & 2)..... | 2.85 | 3.10 |
| Del Monte White..... | 84c | per sack |

Cement—

- Common (all brands, paper sacks), carload lots, \$2.42 per bbl. f.o.b. car; delivered \$2.72.
- Cash discount on carload lots, 10c a bbl., 10th Prox.; less than carload lots \$3.20 per bbl. f.o.b. warehouse or delivered.
- Cash discount 2% on L.C.L.
- Atlas White } 1 to 100 sacks, \$2.50 sack
- Calaveras White } warehouse or del.; \$7.65
- Medusa White } bbl. carload lots.
- Forms labor average \$350 per 1000 sq. feet.
- Average cost of concrete in place, 50c per cubic foot, exclusive of forms; \$15.00 per cubic yard. With forms \$1.60 per cubic foot.

DAMP-PROOFING and Waterproofing—

- Two-coat work, \$3.50 per square.
- Membrane waterproofing—4 layers of saturated felt, \$7.00 per square.
- Hot coating work, \$2.50 per square.
- Medusa Waterproofing, \$3.50 per lb. San Francisco Warehouse.
- Tricoccol waterproofing.
(See representative.)

ELECTRIC WIRING—\$12 to \$15 per outlet for conduit work (including switches).

- Knob and tube average \$3.00 per outlet. (Available only for priority work.)

ELEVATORS—

Prices vary according to capacity, speed and type. Consult elevator companies. Average cost of installing a slow speed automatic passenger elevator in small four story apartment building, including entrance doors, about \$6500.00.

EXCAVATION—

Sand, 60 cents; clay & shale \$1 per yard.

Trucks, \$20 to \$32 per day.
Above figures are an average without water. Steam shovel work in large quantities, less; hard material, such as rock, will run considerably more.

FIRE ESCAPES—

Ten-foot galvanized iron balcony, with stairs, \$150 installed on new buildings; \$160 on old buildings.

FLOORS—

- Composition Floors, such as Magnesite, 50c per square foot.
- Linoflor—2 gages—\$1.25 to \$2.75 per sq. yd.
- Mastopave—90c to \$1.50 per sq. yd.
- Battleship Linoleum—available to Army and Navy only—1/8"—\$1.75 sq. yd.
- 3/8"—\$2.00 sq. yd.
- Terazzo Floors—50c to 70c per sq. ft.
- Terazzo Steps—\$1.75 per lin. ft.
- Mastic Wear Coat—according to type—20c to 35c.
- Hardwood Flooring—Standard Mill grades not available.
- Victory Oak—T & G
3/4" x 2 1/2".....\$143.25 per M. plus Cartage
- 1/2" x 2"..... 122.00 per M. plus Cartage
- 1/2" x 1 1/2"..... 113.50 per M. plus Cartage
- Prefinished Standard & Better Oak Flooring
3/4" x 3 1/4".....\$180.00 per M. plus Cartage
- 1/2" x 2 1/2"..... 160.50 per M. plus Cartage
- Maple Flooring
3/4" T & G Clear \$160.50 per M. plus Ctg.
2nd 153.50 per M. plus Ctg.
3rd 131.25 per M. plus Ctg.
- Floor Layers' Wage, \$1.50 per hr.

GLASS—

- Single Strength Window Glass.....20c per □ ft.
- Double Strength Window Glass.....30c per □ ft.
- Plate Glass, under 75 sq. ft.....\$1.00 per □ ft.
- Polished Wire Plate Glass..... 1.40 per □ ft.
- Rgh. Wire Glass..... 1.40 per □ ft.
- Obscure Glass..... .27 per □ ft.
- Glazing of above is additional.
- Glass Blocks.....\$2.50 per □ ft. set in place

HEATING—

Average, \$1.90 per sq. ft. of radiation, according to conditions.
Warm air (gravity) average \$48 per register.
Forced air average \$68 per register.

IRON—Cost of ornamental iron, cast iron, etc., depends on design.

LUMBER—All lumber at O.P.A. ceiling prices—

No. 1 Common	\$49.00 per M
No. 2 Common	47.75 per M
Select O. P. Common	52.75 per M

Flooring—

V.G.-D.F. 8 & Btr. 1 x 4 T & G Flooring	Delvd. \$80.00
C 1 x 4 T & G Flooring	75.00
D 1 x 4 T & G Flooring	65.00
D.F.-S.G. 8 & Btr. 1 x 4 T & G Flooring	61.00
C 1 x 4 T & G Flooring	59.00
D 1 x 4 T & G Flooring	54.00
Rwd. Plastic—"A" grade, medium dry	82.00
"B" grade, medium dry	78.50

Plywood—not available

	Under \$200	Over \$200
"Plycord"— $\frac{3}{8}$ "	\$49.50	\$47.55
"Plywall"— $\frac{1}{4}$ "	43.15	41.30
3 ply— $\frac{2}{8}$ — $\frac{1}{4}$ "	48.55	46.60
"Plyform"— $\frac{3}{8}$ "—		
Unoilied	126.50	121.45
Oiled	127.90	122.75

Above prices delivered if quantity is sufficient to warrant delivery.

Shingles (Rwd. not available)—

Red Cedar No. 1	—\$6.75 per square; No. 2, \$5.75; No. 3, \$4.45.
Average cost to lay shingles	\$3.00 per square.
Cedar Shakes—Tapered: $\frac{1}{2}$ " x $\frac{3}{4}$ " x 25"	—\$8.95 per square.
Resawn: $\frac{3}{4}$ " x $\frac{1}{4}$ " x 25"	—\$10.65 per square.
Resawn: $\frac{3}{4}$ " x $\frac{1}{4}$ " x 25"	—\$10.65 per square.
Average cost to lay shakes	\$4.00 per square.

MILLWORK—Standard.

D. F. \$100 per 1000. R. W. Rustic \$100.00 per 1000 (delivered).
Double hung box window frames, average with trim \$6.50 and up, each.
Complete door unit, \$10.00.
Screen doors, \$3.50 each.
Patent screen windows, 25c a sq. ft.
Cases for kitchen pantries seven ft. high, per lineal ft., \$9.00 each.
Dining room cases, \$9.00 per lineal foot. Rough and finish about 80c per sq. ft.
Labor—Rough carpentry, warehouse heavy framing (average), \$40.00 per M.
For smaller work average, \$40.00 to \$55.00 per 1000.

MARBLE—(See Dealers)

PAINTING—

Two-coat work	per yard 50c
Three-coat work	per yard 70c
Cold water painting	per yard 10c
Whitewashing	per yard 8c

PAINTS—

Two-coat work	50c per sq. yd.
Three-coat work	70c per sq. yd.
Cold water painting	per yard 10c
Whitewashing	8c per sq. yd.
Turpentine \$1.03 per gal. in drum lots. \$1.08 per gal. in 5-gal. containers.	
Raw Linseed Oil—not available.	

Boiled Linseed Oil—\$1.38 per gal. in drums. Available only to work with high priority—\$1.48 per gal. in 5-gal. containers.

Use replacement oil—\$1.86 per gal. in 1-gal. containers.

Replacement Oil—\$1.20 per gal. in drums. \$1.30 per gal. in 5-gal. containers. A deposit of \$6.00 required on all drums.

PATENT CHIMNEYS—

6-inch	\$1.20 lineal foot
8-inch	1.40 lineal foot
10-inch	2.15 lineal foot
12-inch	2.75 lineal foot

PLASTER—

Neat wall, per ton delivered in S. F. in paper bags, \$17.60.

PLASTERING (Interior)—

3 Coats, metal lath and plaster	Yard 1.50
Keene cement on metal lath	1.80
Ceilings with $\frac{3}{4}$ hot roll channels metal lath (lathed only)	1.20
Ceilings with $\frac{3}{4}$ hot roll channels metal lath plastered	2.20
Single partition $\frac{3}{4}$ channel lath 1 side (lath only)	1.20
Single partition $\frac{3}{4}$ channel lath 2 inches thick plastered	3.20
4-inch double partition $\frac{3}{4}$ channel lath, 2 sides (lath only)	2.20
4-inch double partition $\frac{3}{4}$ channel lath 2 sides plastered	3.85
Thermax single partition; 1" channels; $\frac{2}{4}$ " overall partition width. Plastered both sides	3.30
Thermax double partition; 1" channels; $\frac{4}{4}$ " overall partition width. Plastered both sides	4.40
3 coats over 1" Thermax nailed to one side wood studs or joists	1.65
3 coats over 1" Thermax suspended to one side wood studs with spring sound isolation clip	1.90
Note—Channel lath controlled by limitation orders.	

PLASTERING (Exterior)—

2 coats cement finish, brick or concrete wall	Yard \$1.00
3 coats cement finish, No. 18 gauge wire mesh	2.00
Lime—\$3.00 per bbl. at yard.	
Processed Lime—\$3.10 bbl. at yard.	
Rock or Grip Lath— $\frac{3}{8}$ "—20c per sq. yd.	
"A"—19c per sq. yd.	

Composition Stucco—\$1.80 to \$2.00 sq. yard (applied).

PLUMBING—

From \$100.00 per fixture up, according to grade, quantity and runs.

ROOFING—

"Standard" tar and gravel, 4 ply—\$8.00 per sq. for 30 sqs. or over.	
Less than 30 sqs. \$9.50 per sq.	
Tile, \$30.00 to \$40.00 per square.	
Redwood Shingles, \$7.50 per square in place.	
$\frac{5}{2}$ # 1-16" Cedar Shingles, $\frac{4}{1}$ " Exposure	\$8.00 square

$\frac{5}{8}$ x 16"—#1 Cedar Shingles, 5" Exposure	\$9.00 square
$\frac{4}{2}$ # 1-24" Royal Shingles, $\frac{7}{2}$ " Exposure	\$9.50 square
Re-coat with Gravel	\$4.00 per sq.
Asbestos Shingles, \$23 to \$28 per sq. laid.	
$\frac{1}{2}$ x 25" Resawn Cedar Shakes, 10" Exposure	\$10.50
$\frac{3}{4}$ x 25" Resawn Cedar Shakes, 10" Exposure	11.50
1 x 25" Resawn Cedar Shakes, 10" Exposure	12.50

Above prices are for shakes in place.

SHEET METAL—

Windows—Metal, \$1.75 a sq. ft.
Fire doors (average), including hardware \$2.00 per sq. ft.

SKYLIGHTS—(not glazed)

Copper, 90c sq. ft. (flat).
Galvanized iron, 40c sq. ft. (flat).
Vented hip skylights 60c sq. ft.

STEEL—STRUCTURAL (None available except for defense work).

\$150 ton (erected), this quotation is an average for comparatively small quantities. Light truss work higher. Plain beams and column work in large quantities \$140 per ton.

STEEL REINFORCING (None available except for war work).

\$100 to \$130 ton, set.

STONE—

Granite, average, \$6.50 cu. foot in place.
Sandstone, average Blue, \$4.00. Boise, \$3.00 sq. ft. in place.
Indiana Limestone, \$2.80 per sq. ft. in place.

STORE FRONTS (None available).

TILE—

Ceramic Tile Floors—\$1.00 to \$1.25 per sq. ft.
Cove Base—\$1.10 per lin. ft.
Glazed Tile Wainscot—\$1.25 per sq. ft.
Asphalt Tile Floor $\frac{1}{8}$ " & $\frac{3}{8}$ "—\$.18 to \$.35 per sq. ft. Light shades slightly higher.
Cork Tile—\$.40 to \$.75 per sq. ft.
Mosaic Floors—see dealers.
Lino-Tile, \$.35 to \$.75 per sq. ft.

Wall Tile—

Glazed Terra Cotta Wall Units (single faced) laid in place—approximate prices:
2 x 6 x 12 \$1.10 sq. ft.
4 x 6 x 12 1.25 sq. ft.
2 x 8 x 16 1.20 sq. ft.
4 x 8 x 16 1.40 sq. ft.

VENETIAN BLINDS—

40c per square foot and up. Installation extra.

WINDOWS—STEEL—

30c per square foot, \$5 for ventilators.

IN THE NEWS

Norman L. Low, Architect, has moved from 2614 Flower Street, Huntington Park, to 971 South Arapahoe, Los Angeles, California.

Llewellyn A. Parker, Architect, has moved from 816 W. 5th Street, Los Angeles, to 408 South Spring Street, Los Angeles, California.

A. McF. McSweeney, Architect, has moved from 345 Leavenworth Street, San Francisco, to 927 Hearst Building, San Francisco, California.

Paul C. Overmire, Architect, has moved from 65 Buena Vista Terrace, San Francisco, to 1918 North Grace Avenue, Los Angeles, California.

George J. Paulus, Architect, has moved from 2540 Bryant Street, Palo Alto, to P. O. Box 23, Kentfield, California.

Rudolph A. Polley, Architect, has moved from 1320 Farris Street, Santa Maria, to the Rowell Building, Fresno, California.

Eldridge T. Spencer, Architect, has moved his residence from 960 Chestnut Street, San Francisco, to 1030 Vallejo Street, San Francisco, California.

Glenn Stanton, Architect, has moved from 528 Railway Exchange Building, Portland, to 208 S. W. Stark Street, Portland, Oregon.

Paul A. Thiry, Architect, has moved from 458 Stuart Building, Seattle, to 1331 3rd Avenue Building, Room 712, Seattle, Washington.

Casebolt Dukin, Architect, has moved from 434 South Garfield Avenue in Alhambra, to 77 North Lake Avenue, Pasadena, California.

Harry A. Bruno, Architect, has moved from 4875 Harbord Drive, Oakland, to 1440 Broadway, Oakland, California.

Hugh Y. Davis, Architect, has moved from 1130 Parkinson Avenue, Palo Alto, to P. O. Box 1133, Palo Alto, California.

1945 BUILDING TRADES WAGE SCALES (JOB SITES) NORTHERN CALIFORNIA

Six- and seven-hour day eliminated on all Government Work. A. F. L. - O. P. M. Agreement calls for eight-hour day.

NOTE: Predeterminations by the Department of Labor, as of July 1, 1944 [the wage-freezing date] have not yet been made in all of the counties listed. The wage scales shown are those being paid and in effect mostly by agreement between employees and their union.

CRAFT	San Francisco	Alameda and Contra Costa	Fresno	Marin	Sacramento	San Jose	San Mateo	Vallejo	Stockton
ASBESTOS WORKERS	1.50	1.50	1.25	1.50	1.50	1.25	1.50	1.50	1.25
BRICKLAYERS	1.87½	1.87½	1.75	1.87½	1.75	2.00	1.79-1/6	1.75	1.50
BRICKLAYERS, HODCARRIERS	1.40	1.40	1.05	1.40	1.05	1.50	1.35	1.50	1.14
CARPENTERS	1.50	1.50	1.25	1.43¾	1.25	1.50	1.43¾	1.75	1.37½
CEMENT FINISHERS	1.50	1.50	1.50	1.50	1.50	1.50	1.50	1.50	1.50
ELECTRICIANS	1.70	1.70	1.70	1.70	1.70	1.70	1.70	1.70	1.70
ELEVATOR CONSTRUCTORS	1.75½	1.75½	1.75½	1.75½	1.75½	1.75½	1.75½	1.75½	1.75½
ENGINEERS: MATERIAL HOIST	1.50	1.50	1.25	1.50	1.37½	1.62½	1.50	1.37½	1.25
PILE DRIVER	1.75	1.75	1.60	1.75	1.75	1.75	1.75	1.75	1.75
STRUCTURAL STEEL	1.75	1.75	1.60	1.75	1.75	1.75	1.75	1.75	1.60
GLASS WORKERS	1.40	1.40	1.12½	1.40	1.12½	1.21	1.40	1.40	1.40
IRONWORKERS: ORNAMENTAL	1.60	1.50	1.60	1.50	1.60	1.31¼	1.50	1.50	1.50
REINF. RODMEN	1.50	1.50	1.60	1.50	1.60	1.60	1.50	1.50	1.25
STRUCTURAL	1.75	1.75	1.75	1.75	1.75	1.75	1.75	1.75	1.37½
LABORERS: BUILDING	1.00	1.00	.90	.87½	.95	.90	.93¾	.90	.90
CONCRETE	1.00	1.00	.90	.87½	.95	.90	.93¾	.95	1.00
LATHERS	1.75	1.75	1.50	1.50	1.60	1.75	1.75	1.75	1.75
MARBLE SETTERS	1.50	1.50	1.50	1.50	1.50	1.50	1.50	1.50	1.50
MOSAIC & TERRAZZO	1.25	1.25	1.12½	1.25	1.15-5/8	1.12½			
PAINTERS	1.50	1.50	1.28-4/7	1.50	1.43	1.50	1.42-6/7	1.64-2/7	1.37½
PILEDRIVERS	1.54	1.54	1.54	1.54	1.54	1.54	1.54	1.54	1.54
PLASTERERS	1.75	1.83½	1.75	1.75	1.75	2.00	2.00	1.75	1.83-1/3
PLASTERERS' HODCARRIERS	1.50	1.60	1.40	1.50	1.68¾	1.50	1.75	1.50	1.50
PLUMBERS	1.70	1.70	1.53-1/8	1.70	1.68¾	1.62½	1.70	1.70	1.50
ROOFERS	1.50	1.50	1.25	1.37½	1.40	1.37½	1.25	1.37½	1.37½
SHEET METAL WORKERS	1.50	1.50	1.50	1.50	1.50	1.50	1.37½	1.50	1.50
SPRINKLER FITTERS	1.58	1.58	1.53-1/8	1.70	1.68¾	1.62½	1.70	1.70	1.50
STEAMFITTERS	1.75	1.75	1.53-1/8	1.70	1.68¾	1.62½	1.50	1.70	1.50
STONESETTERS (MASONRY)	1.87½	1.87½	1.50	1.75	1.50	1.75	1.50	1.75	1.50
TILESETTERS	1.50	1.50	1.37½	1.50	1.37½	1.50	1.50	1.50	1.37½

Prepared and compiled by

CENTRAL CALIFORNIA CHAPTER, ASSOCIATED GENERAL CONTRACTORS OF AMERICA

with the assistance and cooperation of secretaries of General Contractors Associations and Builders Exchanges of Northern California.

CLASSIFIED ADVERTISING

RATE: 8c PER WORD . . . CASH WITH ORDER

MINIMUM \$1.50 (3 Lines)

ARCHITECT'S REPORTS—A valuable advance news service giving building and construction information daily on projects in Northern California. Name, location, architect, proposed cost, etc., on individual slips. Ideal for securing new business leads. Hundreds of items, total monthly cost only \$10. Don't delay, subscribe today. ARCHITECT & ENGINEER, Room 618, 68 Post Street, San Francisco, California. Phone DOugles 8311.

ARCHITECTS—A. McF. McSweeney, Architect, Room 927 Hearst Bldg., San Francisco. New offices. Desires catalogs.

ARCHITECTURAL ENGINEER: Excellent educational, professional and business experience seeks partnership in a young, growing office. Now in military service but will be discharged in 30 days. Write c/o ARCHITECT AND ENGINEER.

PHOTOGRAPHY—Keep a pictorial record of your building, or construction project. Pictures are of tremendous value to contractors, builders, engineers, architects. For Industrial-Publicity-Aerial photography, see FRED MAE, Room 721-22 Hearst Bldg., San Francisco 3, California.

PRINTING—Printers, bookbinders. See us for commercial printing. Mercury Press, 942 Howard Street, San Francisco.

HOGAN LUMBER CO.

Wholesale and Retail

LUMBER

MILL WORK • SASH & DOORS

Office, Mill, Yard and Docks

SECOND AND ALICE STREETS • OAKLAND, CALIF.

Telephone GLencourt 6861

CLINTON CONSTRUCTION CO.

OF CALIFORNIA

General Contractors

923 FOLSOM STREET • SAN FRANCISCO

SUtter 3440

MALOTT & PETERSON

**ROOFING AND FLOORING
CONTRACTORS**

20TH AND HARRISON STREETS

SAN FRANCISCO

Phone ATwater 1600

SANTA MARIA INN

SANTA MARIA, CALIFORNIA

FRANK J. McCOY, General Manager

FERNAND E. PIMENTEL, Manager

*On the
Coast
Highway
between
San
Francisco
and
Los
Angeles*



*American
or
European
Plan
•
Old
English
Tap
Room*

APPAREL CITY

(From Page 38)

Not only has Apparel City succeeded in unifying an industry composed of individuals and groups who are professionally and artistically zealous of their abilities and jealous of their products but it will provide better housing and better facilities at rental rates which cannot be obtained elsewhere on a comparable basis. The heating, lighting, and general design is built for the industry. Complete sprinkling systems will be provided as well as a filtering system for the air. In order to retain the individuality of the tenant, the Architects will provide facades of a distinctive nature designed for the occupant but in keeping with the basic concept of the project. Once completed, Apparel City will place San Francisco out in front of the entire industry for modern, complete facilities for the manufacture, display, and sales of men's, women's and children's apparel. Domestic and Eastern buyers will be able to accomplish in one day what now takes from two to seven and they will be able to do this with greater ease, comfort and satisfaction.

Apparel City is no longer the dream of a few individuals. The Housing Authority is rapidly abandoning the site upon which they now have war trailers, the Site Engineer has submitted the final street plans to the city for their concurrence, and the Architects and their engineers are preparing plans for the first 400,000 feet which has already been leased by manufacturers. It is expected that actual construction will be under way in January of 1946.

The Architects, J. Francis Ward & John S. Bolles, have associated with them the firms of Punnett, Perez & Hutchinson, Civil Engineers; Nash, Keller & Ganon, Mechanical Engineers; and Thomas F. Chace, Structural Engineer; and Douglas Baylis, Landscape Architect.

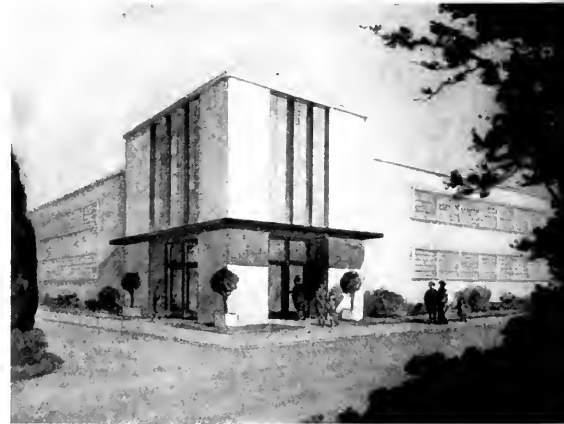

ARCHITECT AND ENGINEER

BOOK REVIEWS

LESSONS IN ARC WELDING. Seventh Printing, second edition. Published by The Lincoln Electric Company, Cleveland, Ohio. 176 pages, 5½ by 8½ inches, 133 illustrations, including photos and drawings. Price, postpaid United States, 50 cents per copy; elsewhere, 75 cents per copy.

"Lessons in Arc Welding," is a revised and up-to-date new printing of the second edition to assist both new and experienced welders as well as all persons interested or concerned with the subject, with complete and thorough instructions in all phases of arc welding.

The book includes 61 lessons in arc welding and has over 200 photos and illustrations to supplement the text. The book sets forth in plain simple language, the practical instruction based on the experiences of Mr. Arthur Madson, head instructor in the Lincoln Arc Welding School.

Published with the objective of aiding those interested in welding to use the process successfully and economically, "Lessons in Arc Welding" explains the fundamentals of this method of joining metals by the fusion principle and incorporates new information such as how to apply the latest types of electrodes and welding techniques developed during the war years.

TRADE ASSOCIATION APPOINTS

E. W. Daniels, president of Harbor Plywood Corp., Hoquiam, Washington, has been named chairman of the management committee of the Douglas fir plywood manufacturers association, which group direct the promotional program of the 30-plant industry producing an \$80,000,000 building commodity.

Other members of the management committee are: Thomas B. Malarkey, Portland, Ore.; N. O. Cruver, Tacoma, Washington; Arnold Koutonen, Olympia, Washington; H. E. Tenzler, Tacoma; Frost Snyder, Vancouver, Washington; B. V. Hancock, Portland; Robert Seeley, Seattle, Washington; and W. E. Difford, Tacoma, managing director of the Douglas Fir Plywood Association.

RE-ESTABLISHES ENGINEERING OFFICE

C. Jefferson Sly, consulting engineer, has secured his release from the U. S. Navy where he served as design superintendent of the Eleventh Naval District, and has opened offices in the Hansford Building, Suite 213, San Francisco, California.

Sly will engage in general engineering practice including designing of buildings, bridges, foundations, airfields, wharves and docks.

The Most Complete Line of
STEELS and BUILDING MATERIALS
Made by a Single Producer



See Sweet's Catalog File or write us for full information.

REPUBLIC STEEL CORPORATION

GENERAL OFFICES: CLEVELAND, OHIO

DENVER, COLORADO CONTINENTAL OIL BUILDING
LOS ANGELES, CALIFORNIA EDISON BUILDING
SALT LAKE CITY, UTAH WALKER BANK BUILDING
SAN FRANCISCO, CALIFORNIA RIALTO BUILDING
SEATTLE, WASH. WHITE-HENRY-STUART BUILDING

PACIFIC MANUFACTURING CO.

HIGH CLASS INTERIOR FINISH
QUALITY MILLWORK

142 SANSOME ST., SAN FRANCISCO
GArfield 7755

6820 MCKINLEY AVE., LOS ANGELES
THornwall 4196

BUILDERS EXCHANGE, OAKLAND

"AMERICAN - MARSH"

CONDENSATION UNIT

Pumping
Machinery
for
Every
Purpose

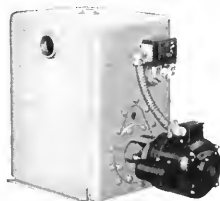

For Service
Call
DOuglas
6794
or
MUtual 8322

SIMONDS MACHINERY CO.

SAN FRANCISCO
816 FOLSOM

LOS ANGELES
455 EAST 4TH

VERMONT MARBLE COMPANY

Producers and Finishers
of
Domestic and Imported Marbles

Write for new pamphlet describing our
Marble Toilets and Showers

San Francisco and Los Angeles
San Francisco phone: SUTter 6747



Real Estate Loans



F. H. A. loans are readily available on existing homes up to 80% of the appraised value. You can buy a home and pay for it in small monthly installments like rent. For example, a 20-year loan of \$4000 would cost about \$33.71 per month, including taxes, insurance, principal and interest.

*Come in and talk with us.
We can help you get the home you want.*

CROCKER FIRST NATIONAL BANK
OF SAN FRANCISCO
California's Oldest National Bank
ONE MONTGOMERY STREET
Member Federal Deposit Insurance Corporation

Swimming Pools of Distinction

Built by technicians with specialized pool construction experience.

Landon Standard Pools

A Northern California Enterprise.

(We have the Background, the Men and the Material)

Telephone 425 Old County Road
Belmont 2312 Belmont, Calif.

START THE NEW YEAR RIGHT
WITH A SUBSCRIPTION TO

Architect & Engineer

68 POST STREET, SAN FRANCISCO

Get the latest, most complete information on West Coast plans of Architects, Engineers and Contractors.

PER YEAR \$3.00

IN THE NEWS

FREE VETERAN SERVICE

The Specification Service, 6121 W. 3rd Street, Los Angeles, maintains a free employment service for architects, draftsmen, and specialists in the building industry who are being separated from military service.

NEW SHORING AID

To reduce cumbersome and time-consuming methods of building shoring for concrete forms the RAY J. MOTHS CO., of Milwaukee, Wisconsin, have announced an invention of tubular steel trusses and tee-posts.

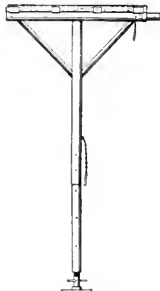

Top: Adjustable Tee-Post

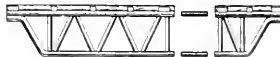

Above: Expansible Trusses

Steel utilized in the tubing has a tensile strength of 110,000 pounds per square inch, and the trusses are built sectionally for ease in expansion or contraction to conform with any architectural design.

The tee-posts have screw adjustments at the bottom and may be used in conjunction for wall shoring, as well as beams and pilasters.

EXHIBIT RESUMED

The Canadian National Exhibition in Toronto will be resumed in August, 1947. The buildings and grounds have been used for military purposes since 1942.

Scott Company

HEATING - - PLUMBING - - TILE



243 MINNA STREET
SAN FRANCISCO
Phone EXbrook 6741

MODELS

- HOMES
- BUILDINGS
- FACTORIES
- ENGINEERING PROJECTS
- REALISTICALLY BUILT TO SCALE

EDWARD OWENS-ASSOCIATES
TECHNICAL MODEL BUILDERS
252 CLAY ST. DO. 2094 SAN FRANCISCO

KYLE FORREST

Civil Engineer

Water Supply — Sanitation

Municipal — Private
Consultations — Investigations
Reports — Designs — Valuations
Supervision — Litigation

Ground Water Work a Specialty

Hydrologic studies — wells, de-watering, underdrainage, foundations, conservation, testimony.

1504 Russ Building
San Francisco 4
YUkon 0652

JOHN D. McLAUGHLIN

Electrical Engineer Consultant
Electrical Designs
Plans - Specifications
Industrial Power and
Lighting Layouts

Airport Lighting Design
Distribution Design
SERVICES FOR
ARCHITECTS AND ENGINEERS

1641 Russ Building
San Francisco, California
Telephone EXbrook 5712

MULLEN MFG. COMPANY

BANK, STORE AND OFFICE
FIXTURES—CABINET WORK
OF GUARANTEED QUALITY
CHURCH SEATING

Office and Factory:
60-80 RAUSCH ST., Bet. 7th and 8th Sts.
San Francisco
Telephone UNDERhill 5815

THE TORMEY COMPANY

GENERAL PAINTERS
AND DECORATORS

Phone UNDERhill 1913

563 FULTON STREET
San Francisco

G. P. W. JENSEN & SON

Building Construction

320 Market Street, San Francisco
Phone: GARfield 2444

JOHN CASSARETTO COMPANY

—Since 1886—And Still Active—

Building Materials

READY MIX CONCRETE
ROCK - SAND - GRAVEL - LIME
CEMENT - PLASTER - MORTAR
METAL LATH - WOOD LATH
STUCCO - WIRE NETTING

Service Unexcelled

Bunkers
Sixth and Channel, San Francisco
Phones: GARfield 3758 - 3760

IN THE NEWS

OPEN OFFICES

Irvin W. Goldstine, A.I.A., and
Bruce E. Heiser have opened of-
fices in the Pacific Building, San
Francisco, for the practice of archi-
tecture.

DWELLING UNITS

Five million new dwelling units
will be built during the next six
years, if national income develops
as expected, Irving W. Clark, man-
ager Better Homes Department,
Westinghouse Electric Corp., re-
cently predicted.

Costs of the "average home"
will be less than \$6000, Clark
thinks.

LEAD HAMMER

Utilizing an entirely new princi-
ple of hammer design this hand
tool is made of virgin tellurium
lead with an antimonial content
which minimizes wear and prac-
tically eliminates danger from fly-
ing chips and splinters.

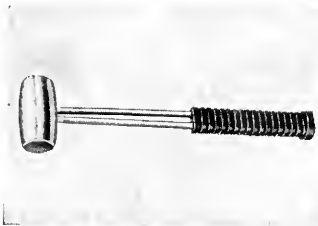

The head toughens with use and
will not blemish from contact with
metal surfaces.

The shaft is a double steel rod
with welded cross members on
both ends absorbing shock and
impact thus protecting hands of
the user from vibration of blows,
while the handle is of durable
plastic, serrated for sure grip.

The weight of the head is 5 lbs.
and is 4 3/4 by 2 inches in size, with
the handle length 7 inches, and is
manufactured by the NU-PROD-
UCTS COMPANY, 1060 Broad St.,
Newark 2, New Jersey.

DINWIDDIE CONSTRUCTION COMPANY BUILDERS

CROCKER BUILDING
SAN FRANCISCO



HERRICK IRON WORKS

STRUCTURAL STEEL
REINFORCING STEEL

18TH AND CAMPBELL STS.
OAKLAND, CALIF.
Phone GLencourt 1767

Phone GARfield 1164

Thomas B. Hunter

Consulting Engineer

DESIGNER OF HEATING
AIR CONDITIONING
VENTILATING AND WIRING
SYSTEMS, MECHANICAL
AND ELECTRICAL EQUIP-
MENT OF BUILDINGS

41 SUTTER STREET
ROOM 710

San Francisco California

ANDERSON & RINGROSE

General Contractors

320 Market Street, San Francisco
Phone GARfield 2245

SMITH, EMERY & CO.

Since 1904

Engineers - Chemists

Inspection, Tests, Analyses,
Research, Consultation
Structural Materials, Structures,
Equipment, Pipe, Soils

Associates

Los Angeles and Eastern Cities
Offices and Laboratories
651 Howard Street, San Francisco

A. F. MATTOCK CO.

Builders

★

212 CLARA STREET
SAN FRANCISCO

Independent Iron Works

Structural Steel
Ornamental Iron
Steel Service Stations
Steel Tanks
Standard Steel Mill Buildings
Bridges

821 Pine Street Oakland

George F. Brayer

ELECTRICAL
CONTRACTOR

166 Seventh Street
San Francisco

Phones: KLondike 2-0879
HEmlock 2646

Index to Advertisers

* Indicates Alternate Months

ALADDIN Heating Corp.....	46
ANDERSON & Ringrose.....	45
ANGIER Sales Corporation.....	*
ARCHITECTS Reports.....	38
BASALT Rock Company.....	8 and 37
BAXTER & Company, J. H.....	32
BRAYER, George F.....	46
CASERETTO, John.....	45
CLARK, N., & Son.....	*
CLASSIFIED ADVERTISING.....	41
CLINTON Construction Company.....	42
COLUMBIA Steel Co. Inside Back Cover	
COLOTYLE Corporation.....	*
CROCKER First National Bank.....	44
DINWIDDIE Construction Company.....	45
FORDERER Cornice Works.....	37
FORREST, Kyle.....	44
FULLER, W. P., Co.....	34
GUNN, Carle & Company.....	28
HANKS, Inc., Abbot A.....	46
HAWS Drinking Faucet Company.....	Back Cover
HERRICK Iron Works.....	45
HOGAN Lumber Company.....	42
HUNT, Robert W., Company.....	46
HUNTER, Thos. B.....	45
IMPERIAL Brass Manufacturing Co.....	*
INDEPENDENT Iron Works.....	9 and 46
JENSEN & Son, G. P. W.....	45
JOHNSON Company, S. T.....	45
JUDSON Pacific-Murphy Corp.....	37
KRAFTILE Company.....	6
KAWNEER Company.....	*
LANDON Standard Pools.....	44
MALOTT & Peterson.....	42
MATSON Electrical Co.....	38
MATTOCK, A. F.....	46
McLAUGHLIN, John D.....	44
MOORE & Roberts, Builders.....	32
MULLEN Mfg. Co.....	45
MUELLER Brass Co.....	2
NELSON, Jas. R.....	27
NORTHERN California Electrical Bureau.....	33
OWENS Corning Fiberglas Co.....	*
OWENS, Edward & Associates.....	44
PACIFIC Coast Gas Association.....	5
PACIFIC Manufacturing Company.....	43
PACIFIC Portland Cement Company.....	*
PACIFIC Telephone & Telegraph Co.....	31
PARAMOUNT Built-In Fixture Co.....	*
PARKER, STEFFINS & PEARCE.....	1
PAYNE Furnace & Supply Co., Inc.....	30
PORTLAND Cement Association.....	*
REMILLARD-Dandini Co.....	46
REPUBLIC Steel Corporation.....	43
SANTA Maria Inn.....	42
SCOTT Co.....	44
SIMONDS Machinery Company.....	43
SISALKRAFT Company.....	37
SMITH, EMERY & CO.....	46
SMOOT-Holman Co.....	35
STANLEY Works, Inc., The.....	*
SOULE Steel Co.....	*
TIMBER Engineering Co., Inc.....	*
TORMEY Company, The.....	45
UTILITY Appliance Corp.....	29
U. S. STEEL Company Inside Back Cover	
VERMONT Marble Company.....	7 and 43
VICTORY Bonds.....	26
WESIX Electric Heater Co.....	*
WESTERN Asbestos Company.....	Inside Front Cover
WOOD, E. K., Lumber Company.....	34

ABBOT A. HANKS, INC. Engineers & Chemists

INSPECTING — TESTING — CONSULTING
CONCRETE • STEEL • MATERIALS
CHEMICAL AND TESTING
LABORATORIES
• RESEARCH AND INVESTIGATION •

TESTS OF STRUCTURAL MATERIALS
DESIGN OF CONCRETE MIXES
SHOP AND ERECTION INSPECTION OF
STRUCTURES AND EQUIPMENT
INVESTIGATION OF STRUCTURES
AND MATERIALS
TESTS AND INVESTIGATION OF
FOUNDATION SOILS
FIRE RESISTANCE AND INSULATION
TESTS

624 Sacramento Street, San Francisco

Robert W. Hunt Company ENGINEERS

Inspection - Tests - Consultation

Schools and Other Structures
Are Built as Designed

When Construction Materials are
Inspected at points of Manufacture
and during Erection by

ROBERT W. HUNT COMPANY

Cement, Concrete, Chemical, Metallurgical,
X-Ray and Physical Laboratories

Chicago - New York - Pittsburgh
Los Angeles - All Large Cities
San Francisco, 251 Kearny Street

REMILLARD-DANDINI Co.

Brick and
Masonry Products

★

633 BRYANT ST., SAN FRANCISCO

569 THIRD ST., OAKLAND

A L A D D I N

Heating Corp.

Specializing in

QUALITY HEATING
EQUIPMENT

2222 San Pablo Avenue

OAKLAND

TWinoaks 1022

	Page
Housing, British Prewar Scheme	Aug. 24
Housing, In-Migrant, A Conversion for (Leonard S. Mosais)	Sept. 9
Housing Project, North Beach (H. H. Gutterson and Earnest Bern)	July 13
Housing Project, North Beach (John S. Bolles)	July 13
Housing, Public, A Fallacy (W. P. Laufenberg)	Mar. 25
Housing Shortage in Britain, How to Be Solved (P. Murray)	April 27

K

Kump Ernest J., Speaks Plainly (E. J. Kump)	Mar. 5
---	--------

M

Marble Men and Architects (Jas. R. Edmunds, Jr.)	Dec. 25
Monument, Column of Independence, Mexico City	July 18
Monument, Morelos, Janitzio, Mexico	Nov. 18
Monument, the Revolution, Mexico City	May 14
Mosaic, Wood (J. Frank Porter)	July 17
Murals, Cuernavaca, Mexico	July 26
Murals, Glass, The Ultimate in Decoration	Sept. 12

O

Office Building, Aztlan, Mexico City	May 27
Office Building, Alameda, Mexico City	Nov. 15
Office Building, Compagnie de Seguros, Mexico City (Enrique y Palomar)	May 22
Office Building, National, Mexico City	May 26
Office Building, Guardiola, Mexico City (Carlos Santacilia)	Mar. 12
Office Building, Seguros de Mener, Mexico City (Louis M. Negrete)	Sept. 22
Office Building, San Antonio, Mexico City (Louis M. Negrete)	Sept. 24
Office Building, United Air Lines, S. F. (Vincent Raney)	July 10
Okinawa Beachhead	Aug. 12

P

Peace Conference, S. F., Delegates	April 12
Petaluma Plans for Postwar Living (J. S. Woodson)	Sept. 17
Portable Ports for Nonmard Invasion	Jan. 30
Portsmouth, England, Reconstruction	April 16
Producers Council Page	Jan.-Dec. 40
Public Building, Chapultepec Palace, Mexico City	July 21
Public Building, City Hall, Mexico City	July 23
Public Building, City Hall, S. F.	April 10
Public Building, City Hall, Petaluma (J. Clarence Felciano)	Sept. 17
Public Building, Civic Auditorium & Rec. Bldg. (J. Clarence Felciano)	Sept. 17
Public Building, Federal Bldg., S. F. (Lewis Hobart)	April 13
Public Building, Fire Dept., Mexico City	Nov. 17
Public Building, National Palace, Mexico City	July 23
Public Building, Netherlands Legation, Mexico City	May 23
Public Building, Old Whaling Station, Monterey (Sketch by A. Hewetson)	April 22
Public Building, Opera House, S. F. (Arthur Brown, Jr.)	April 11
Public Building, Palace of Fine Arts, Mexico City	July 27
Public Building, Post Office, Mexico City	July 23
Public Building, Post Office, Mazagan, Morocco	Oct. 24

	Page
Public Building, Veterans Memorial, and Civic Center, San Diego (J. S. Siebert)	Oct. 29
Pyramids, Yucatan, Mexico	Nov. 19

R

Residence, Acapulco, Mexico (Enrique y Palomar)	May 20
Residence, Avenue President Masarick, Mexico City	May 22
Residence, Avenida Virreyes 155, Mexico City	May 23
Residence, Calle Aristotle, Mexico City	May 21
Residence, Calle Juan de Leyva 145, Mexico City (Carlos Aguayo)	May 24
Residence, Sketch of Cottage (Angelo H. Wetson)	April 21
Residence, Cuernavaca, Mexico (Enr. Del Moral)	Nov. 22
Residence, Dr. Fernando Molina, Mexico City (Jorge Rubio)	Sept. 26
Residence, Flats for 4 Families, Point Pescade, Algiers	Oct. 25
Residence, Governor General of Morocco	Oct. 23
Residence, Mexico City	Sept. 30
Residence, Night Shelter, Algiers	Oct. 27
Residence, Puebla, Mexico	Nov. 16
Residence, Mrs. S. Taylor, Los Angeles (Risley & Gould)	Nov. 26
Residence, U. S. Ambassador, Mexico City	July 22
Restaurant, Sanborns, Mexico City	July 27
Running Fire (Mark Daniels)	Jan.-Dec. 4
Russia Resumes Reconstruction in Moscow	Feb. 35

S

School, Colin Kelley High, Eugene, Ore. (Truman Phillips)	Oct. 18
School, Grammar, in Algeria (X. Salvador)	Oct. 22
School, Colin Kelley, Plan of the Future (Arthur Prialux)	Oct. 18
School, Girls in Algeria (Eduard Lowe)	Oct. 23
Service Station, Mexico City	Nov. 19
Stained Glass in Architecture (Harold W. Cummings)	Feb. 20
Steel, Stainless, in Modern Transportation Construction	Aug. 31
Store Buildings, Apparel City, 32 Acre Project (Jno. S. Bolles and Lou B. Malloy)	Dec. 18-23
Store Building, Auto Sales, Study for (Igor B. Plevitsky)	Aug. 18
Store Building, Fashion Center, Los Angeles (Risley & Gould)	Oct. 14
Store Building, Department, in Algiers (Rene Lugan)	Oct. 26
Store Building, Sales, Dodge-Plymouth, Detroit	Nov. 9
Store Fronts, Glass for Postwar	Aug. 17
Store Fronts for Kawneer	July 30
Swimming Pool, Let's Build A (Edwin H. Wilder)	Nov. 11

T

Terminal, Bay Bridge, S. F.	April 13
Theatre, Fox, S. F. (Thos. W. Lamb)	June 14
Three Dimensional Design (Harold Wallace)	May 14
Trees in Architectural Drawings (Mark Daniels)	Jan. 36
Trees, Sketches by Angelo Hewetson, Feb. 33, Mar. 23, April 33, May 23, June 31, Aug. 35	Feb. 33
Trees, Poem, by Angelo Hewetson	Feb. 33

W

Warehouse, Kaiser Co., Richmond	June 18
Weavers Exhibit, de Young Museum	Jan. 8
Welding Design, Advancements in (J. R. Morrill)	Aug. 20

