

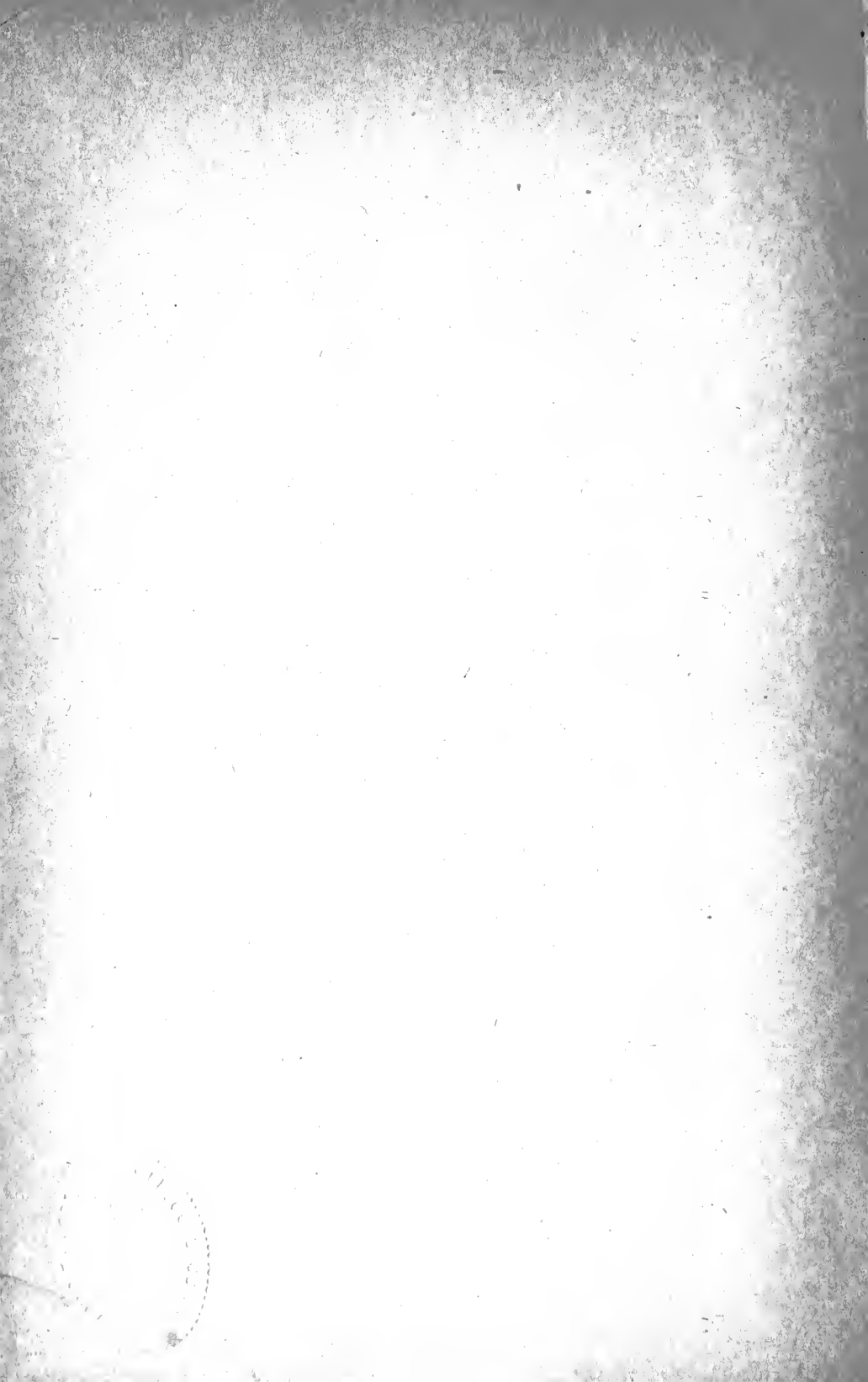

15300
T8

CHAS. E. LAURIAT CO.
IMPORTERS & BOOKSELLERS



Digitized by the Internet Archive
in 2010 with funding from
Boston Library Consortium Member Libraries

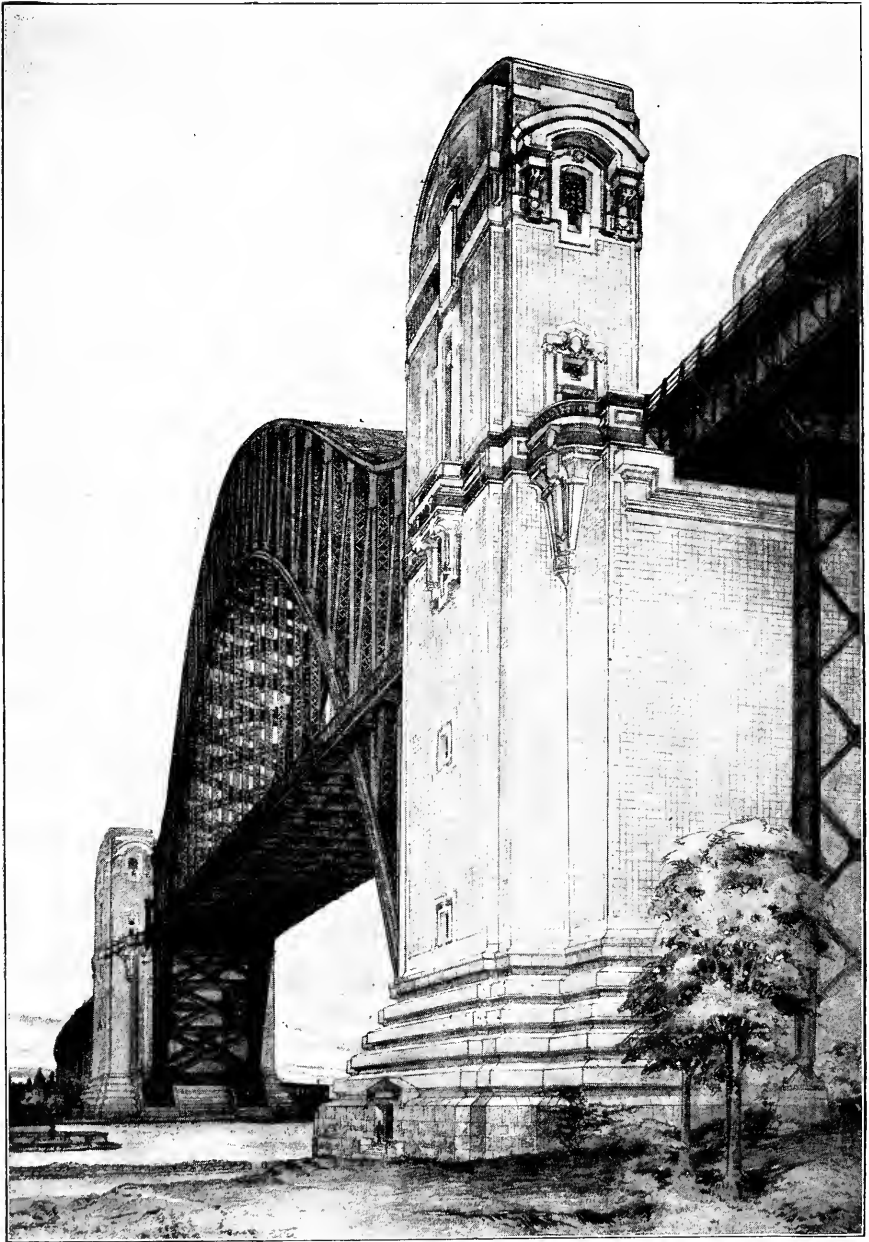

BRIDGE AT HELL GATE, NEW YORK. SPAN 1,000 FEET.

For description see page 89.

ARTISTIC BRIDGE DESIGN

A SYSTEMATIC TREATISE
ON THE DESIGN OF MODERN BRIDGES
ACCORDING TO AESTHETIC PRINCIPLES

BY

HENRY GRATTAN TYRRELL, C. E.

(Toronto University)

Bridge and Structural Engineer

AUTHOR OF

Mill Building Construction (1900); Concrete Bridges and Culverts; History of
Bridge Engineering; Mill Buildings (1910)

WITH AN INTRODUCTION BY

THOMAS HASTINGS

of Carrere & Hastings, Architects

BOSTON COLLEGE LIBRARY
CHESTNUT HILL, MASS.

CHICAGO

THE MYRON C. CLARK PUBLISHING CO.

COPYRIGHTED 1912
BY
HENRY GRATTAN TYRRELL.

57758

PREFACE

A lack of artistic treatment is the greatest fault of American bridges. These structures are worthy of greater thought and study because they are usually such conspicuous objects in the landscape. The lack of art is no doubt partly due to the dearth of literature on the subject and the difficulty in securing good illustrations, and it is hoped that this book will assist in producing better results.

The most important work in connection with any great building enterprise is the preparation of the design, for on this the success or failure of the project depends. If the design is faulty, the money, time and thought spent on its construction are largely wasted, and all the labor of engineers, contractors and artisans is lost. If the design is lacking in beauty, the structure may remain for centuries as a mockery to its originators, unless fortunately it should collapse through structural weakness and give place to another one, more worthy.

The impression has long prevailed that bridge design consists in the development of formulæ, the solution of problems in graphic statics and the computation of stresses in truss frames; whereas, this is not design at all, but merely a part of the process in producing a design. Almost no attention has been given by engineers in America to the artistic character of bridges, and but little to their proper proportions, or to the selection of economic types. For fifty years mathematicians wrestled with purely constructive problems, evolving formulæ and establishing their conclusions, and in this direction there is little left to be desired; but during this time little improvement was made in the visible appearance of their creations. It remains, therefore, for the engineers of the twentieth century to insist upon and to establish a higher standard of bridge

PREFACE

design, based upon the combined standards of economic proportions and æsthetic appearance. Engineers are frequently deficient in artistic training and taste, and architects in constructive knowledge, and the need of improvement is generally admitted. The tendency in this direction is shown by the coöperation between engineers and architects on many of the largest structures, particularly the proposed bridges for New York and Washington.

Mr. Gustav Lindenthal, who is an unquestioned authority on bridge building, says: "It cannot be denied that America is behind the standards of Europe in æsthetic construction. There, the more important bridges, particularly in cities, are invariably designed with a view to their architectural appearance. Details of construction are subordinated to it. The American practice is regulated more from the standpoint of utility, of quick fabrication and speedy erection, not always with the happiest results architecturally. Although the United States has the largest number of steel and iron bridges, it has also the distinction of having the ugliest. There are certain indications, however, of an improvement in taste and it is entirely within the possibilities of the near future that American engineers will be able in foreign competitions to furnish designs for bridges at once architecturally meritorious and economic of cost."

During the writer's twenty-five years experience he has made designs for several hundred bridges, many of which were built, and the suggestions in this book are the outcome of his effort and study to control dominant commercialism which has caused engineers to perpetrate so much vandalism. The book is the development of a series of articles on ornamental bridge construction, written by him and published in *The American Architect* in 1901, though more than fifty half-tones used in those articles have not been reproduced here. The number of illustrations might easily have been increased, only a few being included from the writer's collection of more than a thousand photographs. Certain principles of design have occasionally

PREFACE

been repeated in different chapters, where it appeared desirable for the sake of emphasis or clearness.

There is perhaps no one better able to write on the subject than Mr. Thomas Hastings, who has furnished the introductory chapter, for the work of his firm, Carrère & Hastings, on the great bridges of New York, is very well known. I have received valuable suggestions and illustrations also from Mr. Whitney Warren, architect of the proposed Hudson Memorial bridge, and from Mr. Paul Pelz, architect in chief of the Congressional Library, and designer of the proposed Potomac Memorial bridges at Washington.

In the preparation of this work, I have been assisted by my wife, Maude K. Tyrrell, who is a graduate of the Chicago Art Institute, with practical experience in architectural design.

Some illustrations of European bridges were supplied to me complimentary by the "Gutehoffnungshütte" of Oberhausen, Germany, and a few others were secured from The Concrete-Steel Engineering Company of New York. Benefit has been derived from discussions and illustrations which have appeared in various periodicals and journals, including The Engineer and Engineering of London, Génie Civil, Annales des Ponts et Chaussées, Revue Industrielle, Nouvelles Annales de la Construction, Revista de Obras Publicas, Glaser's Annalen für Gewerbe und Bauwesen, Zeitschrift für Bauwesen, Zentralblatt der Bauverwaltung, Beton und Eisen, Stahl und Eisen, Zeitschrift des Vereines Deutscher Ingenieure, Zeitschrift der Oesterreichischen Ingenieur und Architekten Verein, Allgemeine Bauzeitung, Deutsche Bauzeitung, Annales des travaux publics de Belgique, De Ingenieur, Tijdschrift van het. K. Inst. van Ing., Schweizerische Bauzeitung, Giornale del Genio Civile, Engineering News, Engineering Record, Metropolitan Magazine, Architectural Record, Scientific American, etc., as well as reports from many American and foreign technical and scientific societies.

Evanston, Illinois,

H. G. TYRRELL.

August, 1911.

TABLE OF CONTENTS

CHAPTER	INTRODUCTION BY THOMAS HASTINGS	PAGE
I	Importance of Bridges	9
	Magnitude of Subject	11
	Relation of Bridges to Progress	13
II	Reasons for Art in Bridges	16
III	Standards of Art in Bridges	19
IV	Causes for Lack of Art	24
V	Special Features of Bridges	29
	Kinds of Bridges and Comparative Merits	32
	Selection of Proper Type	34
VI	Principles of Design	38
	Cooperation of Engineer and Architect	38
	General Dimensions	41
	Piers	41
	General Principles	42
	Expressiveness	44
	Symmetry and Simplicity	45
	Harmony and Contrast	46
	Conformity with Environment	47
	Materials and Colors	48
	Use of Ornament	49
VII	Ordinary Steel Structures	50
	Beam Bridges	50
	Truss Bridges	53
	Viaducts and Trestles	55
	Movable Bridges	56
VIII	Cantilever Bridges	67
	Number of Spans	67
	Chord Outline	69
	Ornament	73
IX	Metal Arches	75
	The Deck	75
	Spandrel Framing	75
	Relative Elevations of Deck and Springs	77
	Arch Types	77
	Pins or Hinges	81
	Arch Forms	84

CHAPTER		PAGE
	Piers or Towers	87
	Approaches	88
	Ornament	89
X	Suspension Bridges	90
	Types	91
	Number of Spans	93
	Towers	93
	Cables	97
	Method of Stiffening Cables	99
	Rigid Suspensions	100
	Anchorage	100
XI	Masonry Bridges	101
	Arrangement and Length of Spans	101
	The Deck	103
	Spandrels	104
	Arch Ring	106
	Shape and Proportion	107
	Piers	109
	Space Above Piers	112
	Abutments	113
	Parapets and Balustrades	117
	Material, Color and Surface Finish	125
XII	Illustrations and Descriptions	130

LIST OF ILLUSTRATIONS

Frontispiece Proposed Hell Gate Arch, New York

FIGURE	PAGE
1 Native Bridge in Peru	9
2 Indian Bridge, British Columbia	10
3 Proposed English Channel Bridge	12
4 Old London Bridge	13
5 Ponte Rotto, Rome	14
6 Parallel Chord Truss	16
7 Winona Cantilever	18
8 Sunderland Bridge over the Wear	21
9 Bridge at Portland, Pa.	22
10 Whipple Truss	27
11 Ponte Vecchio, Florence	29
12 Saint Chamas Bridge	30
13 Valentre Bridge at Cahors	30
14 Memorial Bridge, Capitol Park, Hartford	31
15 Auteuil Viaduct, Paris	32
16 Britannia Bridge, England	33
17 Forest Hills Entrance, Boston	34
18 Plauen Stone Arch	34
19 Belle Isle Park Bridge, Detroit	37
20 Spuyten Duyvil, Proposed Hudson Memorial	39
21 Memorial Bridge at Washington, D. C. (Proposed)	40
22 Memorial Bridge at Washington, D. C. (Proposed)	40
23 Bridge in Fayal, Azores	42
24 Forest Park Entrance, St. Louis, Mo.	43
25 Madison, N. J., Park Bridge	43
26 Design for Bridge in Fairmount Park, Philadelphia	44
27 Meadow Street Bridge, Pittsburg, Pa.	45
28 Walnut Lane Bridge, Philadelphia	46
29 Proposed St. Lawrence River Arch	47
30 Saintes Bridge	48
31 Design for Short Span Beam Bridge	51
32 Design for Short Span Beam Bridge	51
33 Proposed Concrete Beam Bridge over the Jordan	52
34 Elizabethtown Bridge over Great Miami River	53
35 New Baltimore Bridge, Ohio	53
36 Kuilenburg Bridge, Holland	53
37 Montreal River Viaduct	54
38 Lethbridge Viaduct, Alberta, Canada	54
39 Proposed Salmon River Trestle, Idaho	55
40 Viaduct at Ogden, Utah	55

FIGURE	PAGE
41 Belah Viaduct, England.....	56
42 La Bouble Viaduct.....	56
43 Double Leaf Bascule Bridge.....	57
44 Proposed Bridge at Washington.....	58
45 Proposed Bridge at Washington.....	58
46 Spanish Bascule.....	60
47 Spanish Bascule Tower.....	62
48 Webster Avenue Swing Bridge, Chicago.....	63
49 Bridge Over the Connecticut River at Middletown.....	64
50 Proposed Design for the Quebec Bridge, by Mr. Fidler..	68
51 Queensborough, or Blackwell's Island Cantilever, New York.....	68
52 Hooghly Cantilever.....	69
53 Cernavoda Cantilever.....	69
54 Villefranche Cantilever.....	70
55 Bridge over the Firth of Forth, Scotland.....	70
56 Weser River Bridge at Hameln.....	70
57 Proposed Bridge over Salmon River Gorge, Idaho.....	71
58 Proposed Bridge over Salmon River Gorge, Idaho.....	72
59 Proposed Bridge over Salmon River Gorge, Idaho.....	72
60 Proposed Harlem River Bridge.....	73
61 Sukkur Bridge, India.....	73
62 Beaver Cantilever.....	74
63 Proposed Salmon River Arch, Idaho.....	76
64 Grunenthal Arch.....	77
65 Niagara Railroad Arch.....	78
66 Salmon River Bridge, British Columbia.....	78
67 Proposed Salmon River Arch, Idaho.....	79
68 Bridge Over the Rhine at Bonn.....	80
69 Duesseldorf Bridge over the Rhine.....	80
70 Harburg Bridge over the Elbe.....	82
71 Proposed Arch over the St. Lawrence River.....	81
72 Alexander III Bridge at Paris.....	82
73 The Garabit Arch.....	83
74 Kaiser Wilhelm Bridge at Mungsten.....	83
75 Yunnan Arch, China.....	84
76 Thermopylae Arch, Greece.....	85
77 Proposed Arch-Cantilever at Mass. Ave., Washington..	85
78 Lincoln Park Arch-Cantilever, Chicago.....	86
79 Stony Creek Arch, British Columbia.....	87
80 Niagara-Clifton Arch.....	89
81 The Ordish Suspension.....	91
82 The Dredge System for Suspension Bridges.....	91
83 Tower Bridge over the Thames, London.....	92
84 Cubzac Suspension over the Dordogne.....	92
85 Williamsburg Bridge Tower, New York.....	94
86 Roche-Bernard Suspension.....	95
87 Danube Canal Suspension.....	95
88 Manhattan Suspension Bridge, New York.....	96

LIST OF ILLUSTRATIONS

xiii

FIGURE		PAGE
89	Manhattan Suspension Bridge, Mr. Lindenthal's Design..	96
90	Proposed North River Suspension	98
91	Proposed North River Suspension Tower Detail	98
92	Proposed Design for Grand Ave. Viaduct, Milwaukee..	103
93	Grosvenor Bridge, England	104
94	Avon Railroad Bridge, Indiana	105
95	Mr. Thacher's Design for Bridge in Schenley Park....	106
96	The Topeka Bridge	106
97	Proposed Railroad Arch in Idaho	108

PIER DETAILS

98	Pons Fabricius, Rome	110
99	Rimini Bridge, Italy	110
100	Ponte Rotto, Rome	110
101	Trinity Bridge, Florence	110
102	Auld Brig o' Ayr, Scotland	111
103	Dunkeld Bridge	111
104	Tongueland Bridge	111
105	Almaraz Bridge, Spain	111
106	Bridge at Mianeh, Persia	111
107	Fredericksbruecke, Berlin	114
108	German Bridge	114
109	French Bridge	114
110	Bridge at Chalons	115
111	Pont Marie, France	115
112	Pont Morand, at Lyons	115
113	Bridge of Neuilly	115
114	Pont Lafayette	116
115	Louis Philippe Bridge	116
116	Rustic Arch	118
117	French Rustic Beam Bridge	118

BALUSTRADE AND RAILING DETAILS

118	Gerrard's Hostel Bridge	118
119	Palissy Bridge	118
120	Bridge over Lea Cut, England	118
121	Ely Bridge	119
122	Stone or Brick Balustrade	119
123	Stone or Brick Balustrade	119
124	Antoinette Bridge, Brick Balustrade	119
125	Andelys Bridge	119
126	Eden Park Bridge, Cincinnati	120
127	Balustrade Design	120
128	Balustrade Design	120
129	Bridge in Garfield Park, Chicago	120
130	Balustrade Design	120
131	Balustrade Design	122
132	Connecticut Ave. Bridge, Washington	122

FIGURE		PAGE
133	Bushnell Park, Hartford	122
134	Balustrade Design	122
135	Balustrade Design	122
136	Balustrade Design	123
137	Louis Philippe, Bridge	123
138	Balustrade Design	123
139	Brick or Stone Balustrade	123
140	Stone Balustrade	123
141	Stone Balustrade	124
142	Terra Cotta, Concrete or Stone	124
143	Italian Renaissance Design	124
144	Gothic Balustrade, Metal or Tile	124
145	Metal Balustrade	124
146	Metal Balustrade	124
148	Ornamental Iron Railing	126
149	Metal Railing	126
150	Ornamental Iron	126
151	Ornamental Iron	126
152	Bordeaux Bridge Railing	126
153	Metal Railing	127
154	Metal Railing	127
155	Metal Railing	127
156	Metal Railing	127
157	French Metal Railing	128
158	French Metal Railing	128
159	Design for Reinforced Concrete Arch Bridge	128

BRIDGE ILLUSTRATIONS WITH DESCRIPTIONS

RUSTIC PARK BRIDGES

160	Bridge in Japanese Tea Garden, San Francisco	131
161	Bridge in Minneapolis Park	133
162	Log Arch at Washington, D. C.	135

STONE PARK BRIDGES

163	Bridge at Belle Isle Park, Detroit, Mich.	137
164	Arch Bridge in Garfield Park, Chicago	139
165	Brick Arch, Lake Park, Milwaukee	141
166	Longwood Bridge, Boston	143
167	Forest Hills Entrance, Franklin Park, Boston	145
168	Stony Brook Bridge, Boston	147

CONCRETE PARK BRIDGES

169	Stockbridge, Mass., Foot Bridge	149
170	Lake Park, Milwaukee, Foot Bridge	151
171	Bridge in Union Park, Chicago, Ill.	153
172	Boulder-Faced Bridge, Washington	155
173	Bridge in Yellowstone National Park	157

LIST OF ILLUSTRATIONS

xv

FIGURE		PAGE
174	Eden Park, Cincinnati.....	157
175	Bridge at Hyde Park on Hudson.....	159
176	Bridge at Hyde Park on Hudson.....	159
177	Como Park Entrance, St. Paul.....	161
178	Newell Avenue Bridge, New York.....	163
179	Columbian Park Bridge, Lafayette, Ind.....	165

METAL PARK BRIDGES

180	Madison, N. J., Park Bridge.....	167
181	Lion Bridges, Lake Park, Milwaukee.....	169

SUSPENSION PARK BRIDGES

182	Bridge in Boston Public Garden.....	171
183	Garfield Park Suspension, Chicago.....	173

STONE ARCH BRIDGES

184	Pont du Gard.....	175
185	Karlsbruecke.....	177
186	Alcantara Bridge at Toledo, Spain.....	179
187	The Rialto, Venice.....	181
188	London Bridge.....	183
189	Cabin John Bridge, Washington.....	185
190	High Bridge, New York.....	187
191	Echo Bridge, Newton Mass.....	189
192	Wissahickon Railroad Bridge.....	191
193	Interlaken Bridge, Minneapolis.....	193
194	Chatsworth Bridge, England.....	195

REINFORCED CONCRETE BRIDGES

195	Proposed Hudson Memorial, New York.....	197
196	Walnut Lane Bridge, Philadelphia.....	199
197	Proposed Potomac River Memorial Bridge.....	201
198	Proposed Potomac River Memorial Bridge.....	203
199	Rocky River Bridge, Cleveland.....	205
200	Big Muddy River Bridge, Illinois.....	207
201	Double Track Railroad Bridge.....	209
202	Zanesville, Ohio, Y Bridge.....	211
203	Washington Street Bridge, Dayton, Ohio.....	211
204	Jamestown Exposition Bridge.....	213
205	Highway Bridge, Marion County, Indiana.....	215
206	Newark, N. J., Bridge.....	217
207	Concrete Bridge at Grand Rapids, Mich.....	219
208	Morris Street Bridge over White River, Indianapolis....	221
209	Northwestern Avenue Bridge, Indianapolis.....	223
210	White River Bridge at Emerichsville.....	225
211	The Topeka Bridge, Kansas.....	227
212	Wayne Street Bridge, Peru, Ind.....	229
213	Green Island Bridge, Niagara Falls.....	231
214	Niagara Falls Reinforced Concrete Bridge.....	233

FIGURE		PAGE
215	Maumee River Bridge, Waterville, Ohio.....	235
216	Bridge at Derby, Conn.....	237

METAL ARCH BRIDGES

217	Proposed Hudson Memorial Steel Arch. No. 1.....	239
218	Proposed Hudson Memorial Steel Arch. No. 2.....	241
219	Proposed Grant Memorial Bridge, Washington. No. 1..	243
220	Proposed Grant Memorial Bridge, Washington. No. 2..	245
221	Niagara-Clifton Highway Arch.....	245
222	Stony Creek Railroad Arch, British Columbia.....	247
223	Panther Hollow Bridge, Pittsburgh.....	249
224	Lincoln Park Arch-Cantilever, Chicago, Ill.....	251
225	Coblenz Arch Bridge.....	253
226	Alexander III Arch at Paris.....	255
227	Worms Highway Bridge.....	257
228	Bonn Bridge over the Rhine.....	259
229	Duesseldorf Bridge over the Rhine.....	261
230	Mainz Bridge.....	263
231	Kornhaus Bridge over the Aar at Berne.....	265

SUSPENSION BRIDGES

232	The Tower Bridge, London.....	267
233	Conway Suspension Bridge, England.....	269
234	Budapest Suspension.....	271
235	The Brooklyn Bridge.....	273
236	Sister Island Bridge, Niagara.....	275

CANTILEVER BRIDGES

237	Bridge over the Hudson at Poughkeepsie, N. Y.....	277
238	Red Rock Cantilever, California.....	279
239	The Forth Bridge, Scotland.....	281
240	Blackwell's Island or Queensborough Bridge.....	283

LATTICE TRUSS BRIDGES

241	Cologne Railroad Bridge.....	285
242	Kehl Bridge over the Rhine.....	287

INTRODUCTION

BY THOMAS HASTINGS

Among all the varied problems of construction which present themselves to human ingenuity, it may be said that the bridge most influences the landscape or transforms the general character of a city. From a rustic bridge which crosses the brook, lending interest to the woodland scenery, to the impressive construction which spans the mighty river without interrupting its circulation, whatever may be its purpose, there is nothing human which may add more to the beauty of a landscape or may so seriously detract from it.

Man more than any other animal has always been migratory, penetrating the most distant regions, and to this end he encircles the world with railroads, pierces the mountains with tunnels, or crosses the intervening valleys with bridges or roads, giving a human interest to nature which, in its primeval condition, it never had. There is no more lasting or permanent construction than that of the bridge, because it does not give way to the changing conditions of the country, or to the growth and development of the city, as does almost any other architectural structure. It is therefore evident that the most serious thought should be given to the character and design of such lasting monuments.

New York is destined to have more bridges of colossal size than perhaps any other great city of the world. The geographical conditions which are most natural, almost like those of Venice, isolate the city on an island, and this island is becoming more and more overcrowded. The large bodies of water in the immediate neighborhood of the metropolis impose varied conditions upon the bridge builder, which will for many generations to come bring about wonderful developments in this rela-

tion; and let us hope that these great bridges will make the city more beautiful. If only municipal authorities continue to take the intelligent interest which some administrations have manifested, this hope may be realized. It would be difficult to picture how beautiful the future city might become when in time these bridges make their impress upon the many miles of water front. We have indeed made too little of these natural conditions and have too seldom realized how much the large bodies of water—the Sound, the Ocean and the Rivers—mean to the inhabitants of the city, not only for purposes of navigation and pleasure, but also for comfort and beauty. These waters, whose tides twice a day bathe our shores, mean more to us than we can realize, and to appreciate this one need only to visit some western inland town to feel a real longing for a coast environment.

New York has grown too large for Manhattan Island, and it must reach out and over the waters as well as under them. Our highways must be extended, giving most interesting problems to the engineer and the architect for many generations to come. Let us hope that the authorities who are doing so much in this direction will some day force the railroads to have more respect for private property instead of destroying, as is so often done, the entire appearance of those portions of the towns they pass through, seeing only the commercial side or how much money can be drained from an ever patient but constantly moving and growing population. It is pitiable indeed to note how often, especially in smaller cities, the railroads build walls through the heart or center of a town, and make them none too good for mere cellar construction with ugly guard rails of pipe, without the slightest consideration of the feelings of the property owners. When one considers the enormous cost of hundreds of miles of railroads from place to place, it is apparent how comparatively small would be the increased expenditure if some thought were given to making such constructions in some way add to the character of any railroad town.

Since the recent manufacture of wrought iron and steel in

large quantities these metals have in a great measure taken the place of the use of stone or wood in bridge construction; this has had a very great influence upon architectural development of bridges. The influence was most generally felt in the building of railroads in the first part of the nineteenth century. There is on record, however, a design made by Thomas Paine, the author, for an iron bridge in the year 1786. It was a segmental arch and this design has formed the basis of many cast iron arched bridges since built. The model for this bridge was placed on exhibition in the house of Benjamin Franklin in Philadelphia, and was afterwards sent to Paris, where it was exhibited at the Academy of Sciences.

It was not until 1840 that any great iron bridges were built in this country, excepting suspension bridges, where iron links were used in the cables and suspenders, the floors being of wood. To realize the great influence railroads have had upon bridge building, we must consider the fact that prior to 1860 the bridges for the railroads were generally designed by the railroad engineers and executed in the shops of the railroad companies. This made an emergency demand, and naturally little thought was given to æsthetics or to the permanent character of such constructions. Later the railroads gave the building of these bridges to construction companies who furnished both designs and bids at the same time, and it is only in recent years that the engineers in this class of work have emerged from these construction companies to enter into the general practice of this profession. In designing bridges and writing specifications their designs were to become the property of the railroad companies, so that they might obtain competitive bids from different contractors.

It is unfortunate that many, though by no means all, of our highway bridges have been designed by engineers who have obtained their education through these channels, so it is not surprising that there has been a marked disregard for the architect and his work. Unquestionably until modern times, most engineers knew more about architecture than they do today,

as also did architects know more about engineering, but with this modern tendency of differentiation and with the multitude of complicated problems brought about by iron construction, there must be more collaboration between engineer and architect in order to produce better results from the practical, as well as from the artistic point of view. This would, indeed, be an advantage not only in that it would make the bridge more beautiful, but there would be an economy of time and money if the engineer and architect would unite in the design. From the first they would work hand in hand to scheme the bridge, instead of the architects being called in at the last moment, as is so often done, merely to design lamp posts, balustrades and other minor details. Planning and designing together, the architect and engineer would produce most satisfactory results. In matters of construction, the architect mainly sees the qualitative side of things, while the engineer sees the quantitative side. A thing builds well that looks well and that follows the laws of architectural proportion and is unquestionably more economical. Alas, a strange sense is that sense of beauty whose absence is as often wanting in human character as is the sense of humor, and the man is as unconscious of this shortcoming in the one case as in the other. He sometimes even seems to have a sort of disdain for any thought of the beautiful, and the deplorable mistakes he makes because of this fact are as incurable and as incorrigible as are hereditary maladies. He shows a total lack of respect for precedents, or the things which have been done in the past. He little realizes that in the history of civilization most things have been destroyed or taken down which were only practical. I really believe that in our conduct of life even a moral law would not be adhered to unless it were in some way and somehow beautifully expressed.

Leaving the architect out altogether in the scheming of a bridge is as though he were to be left out in the designing of tall buildings, because so-called skeleton construction has come into the building practice. Such tall buildings are bad enough

as it is, but they would not be endurable if there were to be an exhibition in our public streets of their unclothed and unadorned skeletons.

There is great hope for the future development of bridges in that there seems to be a tendency among financiers more closely to consider the question of maintenance as related to original cost in large construction enterprises, and this will unquestionably induce them to build more largely of stone and brick than has been the case until this generation. In fact, it is already the policy of the Pennsylvania Railroad to build stone bridges wherever practicable. It means much for art. To everything there is a season, and a time for every purpose under the heavens.

In the construction of stone bridges the Romans were the first great builders. Bridge building was, in fact, one of the most interesting problems they had to solve. In architecture and construction they were indeed a most original and artistic people; too little appreciated and studied by modern Anglo-Saxons. They were the forerunners of our present constructors. Until their time the Greeks had reached that measure of perfection now so much considered, and theirs was the culmination of the slow artistic development through the ages. The Romans, however, had presented to them untried problems to be solved which called for new methods of construction, and of these the bridge or aqueduct was one of the most interesting. They were practically the first people to use the principle of the arch and vousoir construction. (The use of the arch principle, while sometimes attributed to the Chinese, was practically unknown to the ancients of the Western civilization until the Roman conquest.) It has been contended that the idea of the arch principle was first evolved by the Etruscans. If this is true, it is indeed coming near to Rome.

Such wonderful bridges as the one built by Cæsar Augustus at Rimini or the Pont du Gard, the great aqueduct situated about twenty miles from Nîmes, built across the river Gard, and attributed to Agrippa; the bridge of St. Augustus at Rome,

started by Adrian, and many others too numerous to mention have scarcely ever been surpassed. There seems to have been a period between this time and the twelfth century when few bridges of importance were built, and it was between the years 1178 and 1188 that the famous bridge of St. Benezet, at Avignon, was built. Several other beautiful bridges soon followed, similar to it in construction. Then came the early Renaissance bridges, also too numerous to mention—the old Pont Neuf being, perhaps, the finest in Paris; the famous bridge attributed to Ammanati, the architect, in the sixteenth century, at Florence; also the largest stone bridge ever built in the world, with a span of one hundred and eighty-three feet and a rise of sixty feet over the Allier at Vielle Brioude, France; or the bridge at Chester over the Dee, forty feet high with two hundred feet span.

Finally, we come to modern times full of interesting examples too innumerable to catalogue, excepting, perhaps, a few in our immediate neighborhood. The bridges around New York are more interesting from the engineering point of view than from the artistic. It would seem almost a sacrilege to criticise the old Brooklyn bridge, either from the architectural or the engineering standpoint. It is too much a part of us which we have learned to revere rather than to criticise; nor will I criticise the new Williamsburg bridge. I refrain from criticism on general principles, because I believe criticising individual work often does more harm than good.

When we were asked to design in collaboration with the engineers, the new Manhattan bridge, before beginning studies we rode in an automobile over the Brooklyn bridge, returning by way of the Williamsburg bridge. We were much impressed with the added interest in the Brooklyn bridge, due to the fact that the towers of that old structure were of stone rather than of iron, giving more color and variety to the composition. We felt greatly the need of stone above the roadbed in the proposed Manhattan bridge, the third large one to be built across the East river; and with this in view we took advantage of the

great masonry anchorage necessary to receive the four cables pulling each at about the rate of ten millions of pounds. We felt that the masonry should be indicated above the roadbed, and with this in view we designed a colonnade, forming a courtyard of stone as large as a city block and one hundred and twenty-five feet above the water, making a vivid contrast with the necessary forest of iron work.

A much mooted question in the newspapers and elsewhere was whether these bridges were all to be made through thoroughfares, and with this in view, we were asked to design a station at the entrance to the old Brooklyn bridge. An interesting condition confronted us, and one which the critics of this project do not seem to understand. We were asked to design this station in such a way that it should meet the conditions then existing, and at the same time to so build that it would be possible at a small expense to adapt it to new conditions in case of through traffic. In this case such a station would not be a terminal, but a stopping place on the way. It is unfortunate that this fact has been so little understood, as I believe it would silence much opposition. The problem as presented to us by the Bridge Department was in other ways most interesting. It was proposed to design a building in such a way that a vista through a great triumphal entrance arch, showing the old stone towers, might be obtained by people walking on Broadway or in the City Hall Park. Here is one of the greatest bridges in the world, and yet, with the present deplorable and unpractical entrance, one does not know when in this neighborhood that the bridge exists until one is actually launched half way out on its roadbed.

All tramways or trains on the level of the roadbed of the bridge would, according to the new plan, go under ground, and those that are elevated would remain elevated at the entrance, to the height of twenty-five feet, so as to make the desired vista possible. This at the same time would be a wonderful relief to the congestion at this point, because the entire ground floor would be free and open for circulation,

while the waiting rooms or stations would be above and below. This was one of the most interesting architectural problems we have ever had to study, and if carried out, it would offer for further study a most engaging architectural problem. The development of a great city is an evolution, and we need make no effort to find ways to beautify the city; they exist everywhere if we will but recognize them when they are offered.

CHAPTER I

Importance of Bridges

The condition and character of bridges, roads and other public utilities have been measures of civilization in all ages. The homeless savage in trackless wilds had little need for bridges, as his wants were few and achievements small. But as civilization dawned, human needs increased and the desire for greater comforts, better homes and surroundings created a need for transportation and communication. The bridge of fallen logs or swinging vines (Fig. 1*) gave place to better and

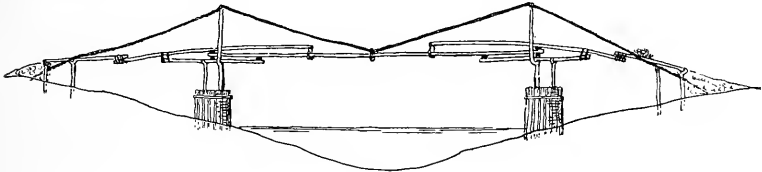

Fig. 1

more commodious ones, over which loaded animals and carts could pass with safety. With the further advance of civilization and the extension of commerce, heavier and better bridges were required, until the coming of railroad transportation in the nineteenth century, when stronger ones were erected to carry trains of cars and locomotives. The earliest bridges, like houses and other structures, were for utility only, and little or no thought was given to their adornment. Primitive races were content with homes which merely sheltered them from the storm and with rude bridges which served only their barest needs (Fig. 2*), but succeeding generations produced buildings in which utility was combined with art. While houses have been adorned and made architecturally attractive, the beautify-

* From "History of Bridge Engineering," by H. G. Tyrrell.

ing of bridges has not advanced in proportion to other arts. Many cities which have splendid buildings, streets and parks, are disfigured with utilitarian bridges, wholly void of art and worthy of existence only in remote regions. The greatest lack of art in bridges is found in America and other new countries, where the need of rapid construction has prevented æsthetic treatment.

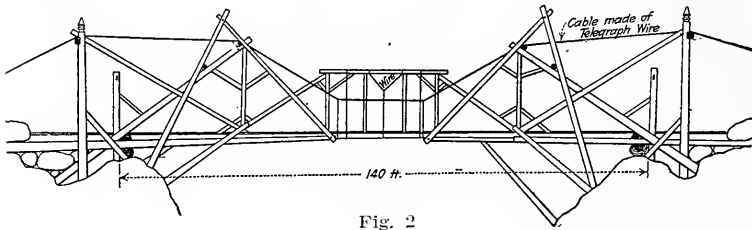

Fig. 2

As the latter part of the nineteenth century was an era in which bridges of great proportions were erected, so the first part of the twentieth century will doubtless witness the beginning and development of bridge architecture in America. Progress in this direction is strikingly illustrated in the city of New York. Thirty years ago the Brooklyn bridge (Fig. 235) was erected as a great utilitarian structure with little or no thought for its adornment, but on some of the later bridge designs in that city, the carrying out of which has unfortunately been prevented by other interests, a great amount of art has been displayed.

Great bridges are a distinctive feature of modern cities and, according as they are attractive or not, they influence public estimation of the place in which they are located. The beautiful bridges of Paris, Berlin and Budapest are of enough interest in themselves to attract travelers to those cities, and the bridges over the Rhine are among the principal features of the region. Progress in America is well illustrated by comparing the old King's and Farmer's bridges at New York, of the seventeenth and eighteenth centuries, with the four great ones over the East river which are the most conspicuous objects in the landscape.

MAGNITUDE OF SUBJECT

(Since the middle of the nineteenth century bridge building has developed into one of the greatest of modern enterprises. In the United States alone there are about 80,000 metal bridges with an aggregate length of 1,400 miles, or one bridge for every three miles of railroad.) In addition to this there are about 200,000 wooden trestles with an aggregate length of about 3,000 miles. The largest ones are those over the great continental rivers of Europe, Asia and America, the most important being in America. (Metal bridges in America alone are valued at \$800,000,000, and the building of them has given employment directly or indirectly to many thousands of men. Mines are equipped and operated to produce the ore and coal, rolling mills to make the finished shapes and plates, and bridge and structural works to fabricate the parts. Other industries are employed in making machinery, tools and supplies for the mines, rolling mills and shops, and still others are engaged in supplying the wants and equipment of those who manufacture the tools. A large amount of capital is, therefore, invested not only in the bridges themselves but also in the mines, mills and shops for producing them. Shipping them gives business to railroad and steamship lines, and the work of erection gives employment to many workmen. The making of travelers, false-work and other appliances is frequently as difficult as the manufacture of the bridges themselves and their erection is often carried on in countries remote from sources of supply. Schools and colleges are equipped and conducted for training engineers, chemists and other technical men, and publishers and printers are employed in supplying technical literature. The effect, therefore, of bridge building, like other great enterprises, is felt throughout the whole world and nearly all people are in one way or another benefited. An industry involving so great capital investment and the labor of so many persons is therefore deserving of the most careful study. If the design is faulty, the money invested and the labor spent, both directly or indirectly, in allied industries, is wasted. This is well illustrated in

the ill-fated Quebec bridge, which fell before completion, and also in many others which are failures in other ways. Ugly bridges in beautiful surroundings are artistically unsatisfactory, and those which must too often be renewed are failures financially because of the selection of a wrong material for the duties imposed upon them. The need for greater attention to design is therefore evident, as upon it the whole success or failure of the structure depends.

No project is now too great for investigation. Designs have been made for a bridge twenty-one miles long, to cross the English Channel (Fig. 3), and though financially impractical, one

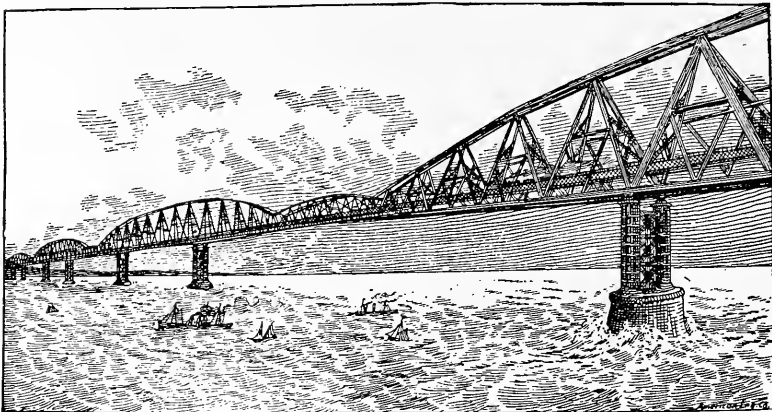

Fig. 3

of America's leading engineers has declared that one on floating piers could be built across the Atlantic, giving railroad communication between the two continents. As far as engineering is concerned, almost any project is possible if enough money is available.

Practical span limits in steel have now been reached, but the investigations of metallurgists and chemists may lead to the production of new building material by the use of which greater lengths will be possible. Long spans are in many cases an evident advantage. The busy water courses of large cities like London and Paris are most useful when unobstructed with piers,

and since larger spans have become possible, many old bridges with shorter ones have been replaced by others with longer openings. The present London bridge with four river piers replaced one (Fig. 4) which had nineteen piers, obstructing two-thirds of the river channel, and the Seine at Paris and Tiber at Rome are now crossed with single spans. The bridges of New York

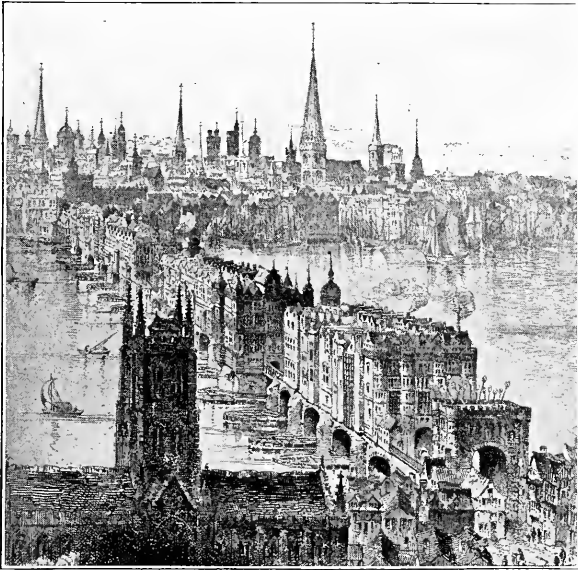

Fig. 4

and some other cities are far more conspicuous, especially from the river, than all their great buildings, which have cost untold millions.

RELATION OF BRIDGES TO HUMAN PROGRESS

Rivers have often been a dividing line between races and nations. Before the days of bridges, each tribe was content with the products of its own territory, but as a desire grew to enjoy the good things of adjoining countries, the rivers and territorial boundaries were crossed, and adjoining tribes exchanged their commodities with each other. Such intercommunication, from which the benefit was great and evident, naturally

developed and increased. The founding and building of empires has always been dependent on roads and bridges. The Romans saw that the requisites for a great nation were a fertile soil, natural resources and abundant means of transportation, and the excellence of the Roman roads has scarcely been surpassed. Their roads and bridges (Fig. 5*) have endured for

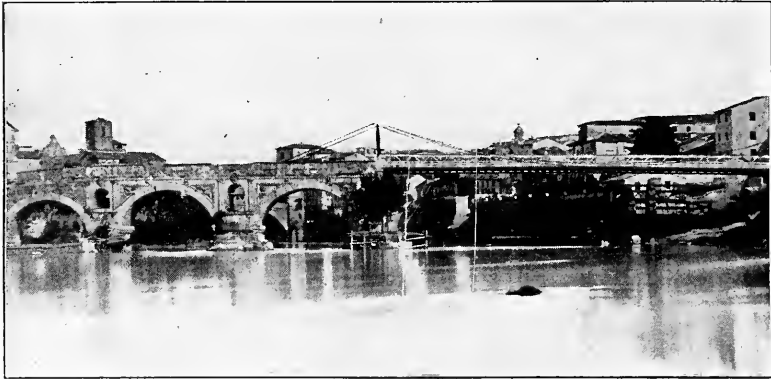

Fig. 5

more than twenty centuries, and are used by the present generations. Without roads, the settlement of a country is impossible. In the opening up and development of the United States, Canada, Africa and Australia, an extensive policy of road construction has been carried out, often at the expense of the national government, for when roads are built, the settlement of the country and the growth of towns and cities is assured.

The building of roads and bridges has therefore been the greatest factor in the development of nations and empires, and the condition of these utilities has always been a measure of their civilization and greatness. In the middle of the eighteenth century, France realized its need, and created a Department of Bridges and Highways in the national government, and fifty years later England constructed more than a thousand miles of highway under the able direction of Thomas Telford.

* From *Concrete Bridges and Culverts*. By H. G. Tyrrell.

Few works are of greater service to mankind. Commerce is created and the products of civilization can be distributed for the benefit of all. Workers in crowded metropolitan quarters are permitted to live in rural or suburban districts amid more healthful surroundings; sickness is avoided and the lives of workmen and their families are lengthened and made more secure. The building of highways and railroads opens up new tracts and increases land values enough many times to repay their cost.

BOSTON COLLEGE LIBRARY
CHESTNUT HILL, MASS.

CHAPTER II

Reasons for Artistic Bridges

Bridges are frequently the most conspicuous objects in the landscape. Unlike buildings in crowded city squares which are partly concealed by their surroundings, a bridge can often be seen for a great distance. The greatest injustice to public taste or feeling is the building of an ugly bridge, for the most prominent and useful structures should be the most beautiful; and yet the reverse has been the custom, particularly in America. City halls, postoffices, and other public buildings which are less prominent, and of much less use or value, have been adorned with art, and bridges have been neglected. Cities have failed to realize that it is as important to ornament their bridges as their city halls or court houses. Consistency is lacking even to a greater extent on railroads than on municipal buildings, for great terminal depots are erected in the cities, and smaller but architecturally beautiful ones at suburban stations, while adjoining bridges which are often more conspicuous than the stations are left utterly void of art. This condition is too evident to need special reference. Often within a few blocks of a great terminal station, common truss bridges (Fig. 6) may be seen spanning the streets, suitable only for

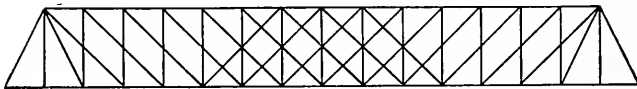

Fig. 6

remote or rural districts where they would be seldom or never seen. The custom in America has already begun to change, for all structures, including bridges and stations, were formerly designed by railroad engineers, without architectural assistance, and had little or no pretention to art. But now both metropol-

itan and suburban stations are the work of architects or the combined work of architects and engineers, and there is no doubt that bridges will soon be similarly treated. It will be impossible much longer to tolerate the discord or lack of consistency and harmony between the beautiful station and the purely utilitarian bridge adjoining it. Whichever one is the most conspicuous is most deserving of decoration, and finials or other decorative features are quite as appropriate on a bridge as the spires and towers on the adjacent building. If the appearance of a bridge is of no importance, the buildings should then be made to correspond, and be similarly devoid of art.

Another reason for building ornamental bridges is that their form and location are frequently inviting for artistic treatment. The curved lines of the arch and suspension are in themselves attractive, and may be beautified without much effort. It is easy, therefore, to make a bridge one of the most beautiful and interesting objects in the landscape. No structure more clearly shows its object and use, and the opportunity is therefore offered for truthful construction, a prime requisite for good design. Bridges, and especially high ones, are naturally impressive, and no objects in the landscape are longer remembered. Returning travelers often retain the picture of a bridge in mind after monumental buildings have been forgotten.

Bridges should be made beautiful because people delight to congregate and loiter upon them, particularly in the summer time. For this reason a bridge is especially suitable for a memorial, as it can be appreciated and admired during leisure hours. Among the memorial bridges of America are the Witmer bridge, near Lancaster, Pa., erected by Mr. and Mrs. Witmer in 1800; the memorial bridge at Milford, Conn.; one at Hartford, Conn. (Fig. 14), and the Schell memorial at Northampton, Mass. Large ones have been proposed at Washington and New York (Figs. 217-220).

Bridges should be beautiful because the presence of ornamental structures enhances the value of the surrounding property. Those entrusted with the expenditure of public money

should realize the economy of building artistically in and around large cities and centers of population, for money thus spent is frequently a good investment. Fine bridges give a distinctive feature to a city. Those in France and Germany and some few in America show possibilities in artistic metal construction. The thirty-two bridges over the Seine at Paris are in most cases models of elegance, standing out in sharp and



Fig. 7

charming contrast to those in some American cities, like Chicago. But the time for better ones in America seems to be at hand. Bridges devoid of art (Fig. 7), which were excusable in the early days of the republic, should no longer be tolerated. The wealth and commerce of America have so increased that the uncouth forms of past generations are no longer permissible as representative works of a great nation.

CHAPTER III

Standards of Art in Bridges

The bridges and structures erected by a people or nation reveal their degree of æsthetic taste and are a measure of their culture and civilization. Bridges should be strong enough to last, and beautiful enough to be worth preserving. Some old Roman, Chinese and Persian stone bridges display an amount of art which has hardly been surpassed in modern times.

In adopting standards of art for bridges, it must be borne in mind that these structures should be pleasing not only to the engineer and architect, but also to people who may have no more than ordinary appreciation of art. Taste depends largely upon environment from infancy. Those who live in primitive and rustic surroundings have not the æsthetic sense so highly developed as their more favored brothers in the vicinity of educational and cultured centers, and yet all have some appreciation for objects of beauty. The architectural standards of other ages cannot always be applied, for modern conditions and building materials are different, and instead of adhering to the art standards of the ancients, a better way is to do as they did, and make the best construction that conditions will permit. Standards in architecture have been established for centuries, and buildings which harmonize with them are satisfying. These standards may and frequently are applied to stone bridges with excellent results, but different ones are needed for concrete and metal. Steel bridges have been the subject of much unjust criticism, due to comparison with wrong standards. Framed trusses are so different from stone arches that they must be judged differently, and as the public learns their meaning and the difficulty of designing them, they will be more appreciated.

The best standards are those suggested by nature. Objects in a natural landscape harmonize with each other. The trunks of trees taper towards the top as less strength is required, and at the base the roots spread out and anchor them to the ground. Limbs branch out on all sides to give them poise. Limbs and branches, which are the framing, are covered with beautiful foliage, and the earth is covered with green and flowers. Mountains slope upward from their bases and have the greatest area where it is needed, at the bottom. The purpose of natural objects is generally evident and rarely concealed. The sun furnishes light; the rivers, water; and the trees, shade in summer. Curves are the lines of nature, and ornament is displayed where it can be seen and appreciated. As a general rule, therefore, when structures conform with nature, they are pleasing, and they displease when they lack such harmony or contradict it. In nature we find the branches of certain trees and shrubs are hollow, as also are the stalks of corn and cane, and the stems which bear the heads of wheat and other grain. The engineer has therefore selected hollow members as an effective structural form, and they may be found on many important bridges such as that over the Firth of Forth in Scotland.

Bridges are therefore considered beautiful when they fulfill the following requirements:

1. Conformity with environment.
2. Economic use of material.
3. Exhibition of purpose and construction.
4. Pleasing outline and proportions.
5. Appropriate but limited use of ornament.

1. A bridge must conform with its surroundings and environment. In a wild mountain gorge large spans of bold design without applied ornament are the most appropriate, while in wooded parks a rustic bridge (Figs. 161-162*) fits better into the landscape. In a city park or public square, where finer ornament is in evidence, a bridge with fine detail, smooth face

* D. G. Tyrrell, in *American Architect*, Aug. 24, 1901.

and smaller ornament is preferable (Fig. 182). The setting or surroundings greatly affect its appearance. A bridge crossing a river at a great height (Fig. 8) is naturally imposing, while the same one at a low level would lack much of its charm. Those which are exposed to the river view are seen and more appreciated than others amid sordid surroundings partly hidden by adjoining objects.

2. Economic use of material is another standard of excellence. Beauty exists in every structure which is designed according to the principles of economy, with the greatest simplicity, the fewest members and the most pleasing outline consistent with construction. Requirements of utility may neces-

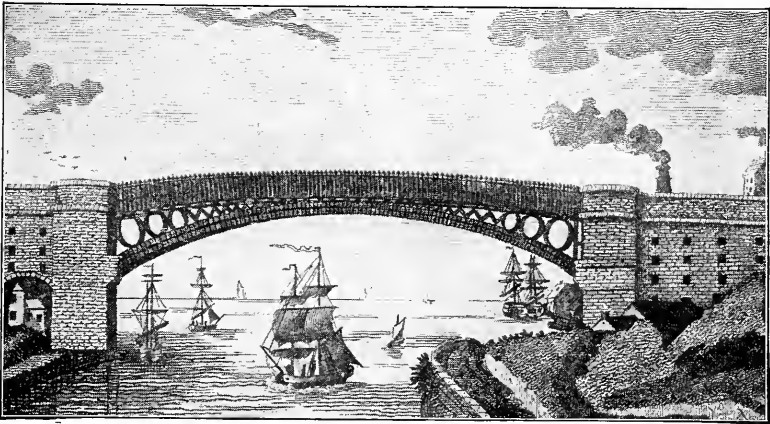

Fig. 8

sitate certain forms unfamiliar to the public mind, but as the purpose and design of bridges are better understood, these forms will be more appreciated. The principle is an essential of design and must overrule public preference. Strength and economy are the controlling motives, but art, though secondary, must not be neglected.

3. The purpose of the bridge should be plainly evident, and generally the construction should be revealed. Expressiveness, to many people, is the chief source of beauty. Strength

and boldness should predominate. Imitation or deception must be avoided and the design truthfully shown. If spandrels of masonry bridges are hollow they should appear open on the face rather than enclosed with curtain walls. A girder should not be formed to imitate an arch, and false members in trusses should be avoided or used with caution.

4. A bridge is beautiful if its primary form or outline and its relative proportions are well and properly chosen. A spectator is more impressed by the general form than by an endless wealth of detail, and when the outline is correct, little detail ornament is needed. The proportions must satisfy the eye and the æsthetic feeling, and have optical harmony. Projections and corresponding heavy shadows on masonry give an appearance of strength and introduce contrast, which is one of the elements of beauty. Voids and solids should be arranged

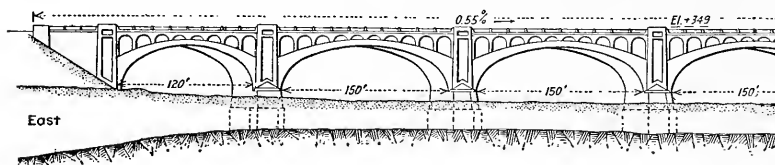

Fig. 9

in satisfying proportion. The lines of the arch (Fig. 9) and suspension are in themselves enough to give a fine effect. Arches must be *perfect* curves and false ellipses with less than nine or eleven centers should be avoided. Curved lines are more beautiful than straight ones, but the outline selected must be consistent with economy. Small bridges should have finer outlines and a larger amount of detail than greater ones.

5. As the bare skeleton of a tree or animal is beautified with foliage or covering, so the framing and construction of a bridge should be ornamented. The relative weight of timber and leaves on a tree is suggestive of the extent to which ornament is permissible on structures. Superfluous decoration has a minifying effect and is sometimes ridiculous. The bridge at Callowhill street, Philadelphia, originally faced on each

side with sheet metal arcades, was an illustration of excessive ornamentation. A somewhat similar design, made in 1867 by George A. Parker for a bridge at Havre de Grace, showed the proposed structure covered on the outside with ornamental iron. It was illustrated at the time in the *Journal of the Franklin Institution*, and was considered a fine piece of work. The covering met with so much disapproval that it was soon removed. The beautiful Bonn bridge (Figs. 68-228) over the Rhine—one of the finest in Europe—has elaborate detail ornament on the metal portals, which would be inappropriate elsewhere, though perhaps suitable in its place. Ornament is not architecture, and a bridge of beautiful outline may easily be spoiled with an excessive amount of detail.

CHAPTER IV

Causes for Lack of Art

No objects in America more greatly mar the landscape than the bridges, and none in Europe are more attractive. In and about American cities ordinary truss bridges are common, and many of the most conspicuous ones are artistically worthless. Adjoining the beautiful Back Bay Railway Station in Boston, within a few blocks of Copley Square and the finest residential district, stood an ugly truss carrying Dartmouth street over the railway tracks. The contrast was striking as the traveler emerged from the handsome building on his way to the finest portion of the city, to be at once confronted with this uncouth structure, suitable only for some remote factory district or region. The reasons for lack of beauty in American bridges are as follows:

1. Indifference of engineers and their lack of artistic training.
2. Competition and commercialism, resulting in use of contractors' plans.
3. Lack of coöperation from architects.
4. Absence of art standards for metal bridges.
5. Haste in construction.
6. Railroad bridges used as prototypes for others.
7. Legal and financial hindrances.
8. Inadequate material.
9. Unsuitable or unsymmetrical location.
10. Absence of state or municipal supervision.

1. Little or no literature on artistic bridge design was available for engineers and no instruction was given on the subject in American engineering schools. In France, conditions were

quite different, for there a teacher of architecture is associated with these institutions. Engineers in America were therefore ignorant of the principles of æsthetics, or had given no time or thought to the cultivation of their taste in this direction. Where there is no desire for artistic production, it is certain that none will result. Many engineers not only neglected this feature of design, but actually ridiculed æsthetics, gaining for themselves the title of "eminent engineers but professional vandals." Pleasing outlines were discarded and preference given to purely utilitarian forms. Their only object has been to design bridges of sufficient capacity and strength, and accomplish this result with the least expenditure of money. Ugly designs were often made when artistic ones would have cost no more. After selecting a general outline that was absurdly far from the proper one, many engineers would then compute the stresses in the selected forms, carrying their figures out to decimals, when the primary assumptions might never be realized within one hundred per cent or more. In reference to this custom of fine proportioning, when writing particularly about computations for engine loadings, Professor William H. Burr says: "Nothing is to be gained by this figment of ridiculous refinement; in fact, much is to be gained by its relegation to obscurity. A solacing memory will always be preserved for the awe-inspiring literature" on the subject "which has been written to show what splendid mathematical gymnastics can be performed in its treatment. But it can be confidently asserted that no single structure has ever been made a shade better for its purpose, or more creditable in its design, by the use of the method." Another critic declares that "some engineers exhibited a willful, and most engineers a careless, indifference for design; for after executing some especially revolting work, painted in triumphal red, they exulted over the disfigured city or the insulted landscape like a conquering savage."

2. Commercialism and competition are responsible to a great extent for a lack of art in American bridges, for as a general rule, the cheapest bridge, and consequently the plainest

one, was accepted, and ornamental designs at greater cost were discarded. These designs were prepared by contractor's engineers, whose chief and often only motive was personal gain. Under these conditions, it was generally useless to make artistic designs, and engineers became accustomed only to the cheapest forms, and were inexperienced in any other.

3. Coöperation of architects was considered unnecessary, and none was given. The architect knew little of engineering, and the engineer nothing of architecture, each finding that all his time and energy were required to master his own work. Railroad terminals and depots were formerly the work of engineers, and not till lately has the aid of architects been invoked on these structures. When members of the two professions work together on bridges as they do now on large buildings, the results should be more fortunate.

4. Another reason for the lack of art was that no standards for metal bridges were available, and precedent in stone was of no value. Metal was declared to be a hard material to beautify, and until recently there has been little or no experience in this direction. Early efforts in ornamental wrought iron bridges in America were a failure, and some in Europe, including the Bonn bridge over the Rhine (Fig. 228), which is graceful in almost every particular, have rather unfortunate decorative features.

5. Hasty construction is perhaps responsible for more ugly bridges than any other cause. New countries like the United States of America and Canada were opened up to settlement, by projecting long lines of railroad across the continent. As further construction was dependent on the completion of bridges over which work trains and supplies could pass, the greatest possible haste was necessary, and temporary bridges and timber trestles were extensively employed. The usual policy has been to complete the road and have it open for travel at the least possible first cost. This haste and the desire for the least expense has resulted in the general adoption of metal trusses with parallel chords (Fig. 10), which were

cheaply made and quickly put together. These types therefore became the prevailing ones and were erected all over the American continent. In Europe, conditions were different, for the railroads there were constructed through thickly settled regions and extensive business was at once assured. Under these conditions, temporary and low cost bridges were less in evidence, and better ones were made during the first construction.

6. The American railroad truss bridge, which was the common and almost only form, became the prototype for town and city bridges, and these ugly structures may now be found

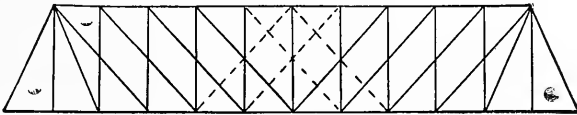

Fig. 10

both in remote regions and in the center of great cities. Smaller spans are usually the worst appearing, for their height is out of proportion to their length, and they have no other indication than mill and factory products. In bridges, as in other things, custom governs to a large extent, and up to the present time the prevailing fashion is the economical though unsightly truss.

7. The financial limitation or necessity for low first cost of railroad bridges was equally evident in towns and cities, where the lowest tender offered, often on the bidder's own design, was usually accepted. A common explanation of unsightly bridges is therefore the excuse of insufficient funds or appropriation. The plea is evidently without foundation, for cities which spend millions on their public buildings could better afford to beautify their bridges, which are often much more conspicuous. Legal hindrances may also interfere with the erection of suitable designs.

8. Suitable material for ornamental work is not always at hand, but this need not prevent the adoption of artistic forms, for bridges, even of the rudest character, may often be beautified without adding greatly to their cost.

9. The location may be such that any bridge of an ornamental character would be out of place. No one would consider a monumental one for a rural district where it would be little seen, and in such locations ornamental bridges are unsuitable. The site also affects its appearance, for if the surroundings are beautiful the bridge will be more attractive. If the profile or ground contour is unsymmetrical, it is more difficult to make a symmetrical and satisfactory arrangement of spans.

10. The absence of state or municipal supervision of bridges permitted the acceptance of uncouth designs which might have been prevented. But the municipal art commissions, now active in many large cities, instead of promoting art, have often hindered it, as is well illustrated in New York by the rejection of several bridge designs of unusual merit, and the ultimate abandonment of the whole projects. State commissions are fortunately more successful, and in some states bridge designs must be approved by the commission before construction can be started.

CHAPTER V

Special Features of Bridges

Bridges have had many uses in addition to forming a passageway for travel, and ancient and mediæval ones were frequently lined on either side with shops, or used as a gathering place for citizens. Old London bridge (A. D. 1177), Ponte Vecchio (Fig. 11) over the Arno at Florence (A. D. 1345),

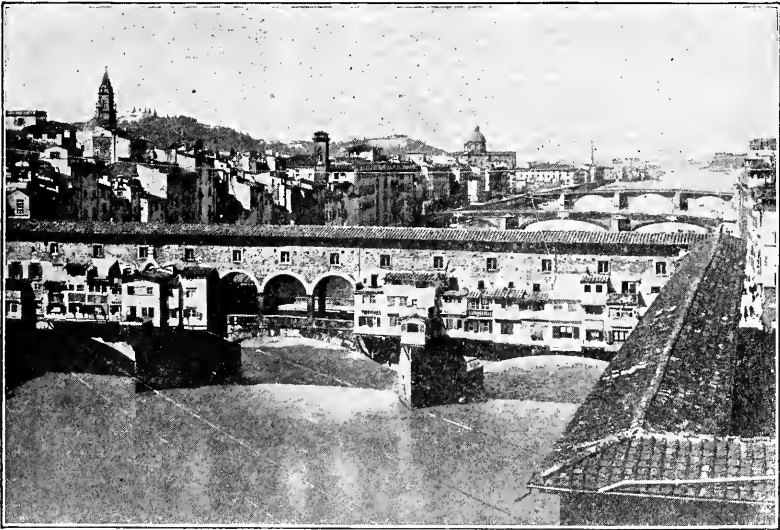

Fig. 11

and the Rialto (Fig. 187) at Venice (A. D. 1588) were roofed over and provided with shops on each side, from which merchandise was sold. The bridges of Martorell, St. Chamas (Fig. 12), Alcantara, Saintes, and many others, had triumphal or memorial arches above the roadway. Others, like the bridge of St. Benezet at Avignon, had chapels at the ends or side, and many others were guarded with fortification towers. The Val-

entre bridge (Fig. 13) over the Lot at Cahors had double towers at the ends, and others over the center pier. The magnificent bridges at Ispahan, Persia, which have hardly been surpassed, had covered galleries or colonnades at each side, with

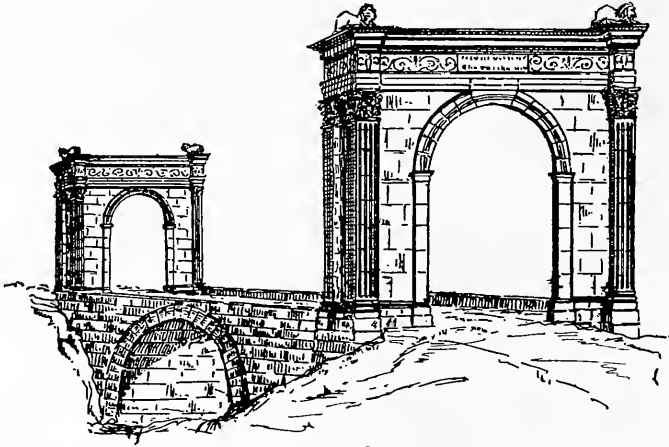

Fig. 12

upper and lower walks, and one of these had a grand central pavilion. Later covered bridges with colonnades are those at Pavia, Italy, and the modern Auteuil viaduct or Pont du Jour in Paris. The Pont de Chenonceaux, France (A. D. 1556), has six arches surmounted by a building or castle of several stories, the castle being the most prominent feature.

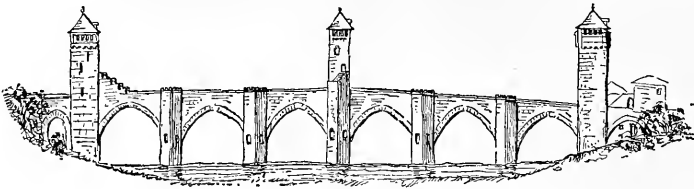

Fig. 13

Statuary is a common adornment on the bridges of Paris, Berlin and other European capitals, instances being the bridge of St. Angelo at Rome, Trinity at Florence, Pont Neuf at Paris, the Schloss and Friedrichs bridges in Berlin. Features of this kind are notably absent in America, only very few con-

taining anything more than structural requirements. Memorial bridge (Fig. 14) in Capitol Park, Hartford,* has a beautiful arch above the roadway at one end, and the new covered bridge at Monterey, Mexico, has a covered roadway with market stalls on each side.

All of these features and many others are appropriate. As people delight to congregate on a bridge in summer, foot walks or promenades should be wide with plenty of benches and occasional outlooks in the balustrade. Fountains, booths and rest-



Fig. 14

ing places, with space for plants and flowers, may take the place of fortification towers, and shelters or lavatories be substituted for shrines. A central music pavilion would permit the sound to travel over the water in the natural amphitheatre, and be enjoyed by residents on the neighboring hill sides. Upper and lower decks may sometimes be appropriate, as on the Girard avenue and Callowhill bridges in Philadelphia, the Eads bridge at St. Louis, or the proposed memorial bridge

* H. G. Tyrrell, in *American Architect*, March 30, 1901.

at Washington (Fig. 219). The lower deck, which is suitable for car tracks, may, in masonry bridges, be directly above the main arches, and the upper deck supported on open colonnades, or the lower deck may be the principal one, with a central arcade and elevated platform for cars, as on Pont du Jour at Paris (Fig. 15).

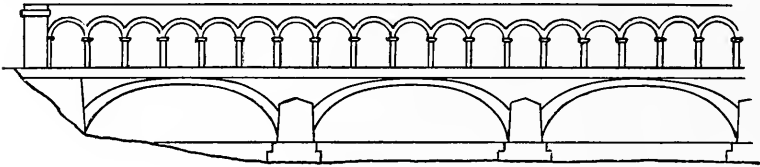

Fig. 15

The best opportunity for large decorative features is at the portals, especially when the ends are well exposed. These may take the form of entrance archways, waiting pavilions, pedestals and statues, or other monumental or memorial features suitable to the location. Hooded shelters at drawbridge ends, with seats for waiting passengers, are useful and expressive, and emphasize by their presence the position of the open span. Excellent examples of portal decorations are on the old Karlsbrücke (Fig. 185) at Prague, and the Bonn (Fig. 228), Düsseldorf (Fig. 229), Cologne (Fig. 241), Worms (Fig. 227), and Mayence bridges in Germany. In America, portal decoration seems to be restricted to the placing of lions or similar sculptures on the ends, a practice common in China for centuries, and used by Stephenson on the Britannia bridge (Fig. 16).

With abundant wealth everywhere there is no longer any reason or excuse for confining bridge design to the calculation of stresses in truss frames, and the erection of public disfigurements.

KINDS OF BRIDGES

The cables of suspension bridges are in tension always, and arch ribs are always in compression, while beams and trusses are subject to both tension and compression and resist

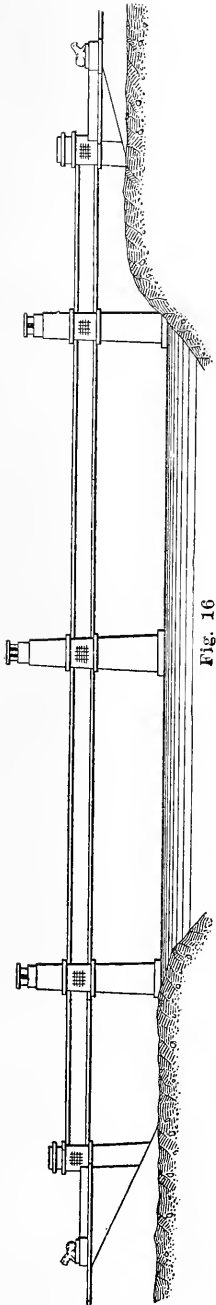

FIG. 16

bending by the counteracting moments in the upper and lower chords. The cantilever is only a special form of truss. Arches and suspension bridges with only single chords are lighter than truss bridges, but generally they cost as much or more. Masonry bridges, including those built of concrete, are the most permanent, though suitable for comparatively short spans, the longest of any kind being the 328-foot reinforced concrete arch just completed (1910) over the Tiber river at Rome, and the longest one of stone the 295-foot arch at Plauen (Fig. 18), Germany. The proposed 703-foot reinforced concrete arch (Figs. 20-195) over Spuyten Duyvil creek at New York would contain more metal in its reinforcing than would be required to build an all-steel arch of the same length. Steel and iron, on account of their liability to rust, are less favored for permanent or memorial bridges than masonry, and the two beautiful Hudson Memorial designs with metal arches of 400 and 825 feet (Figs. 217-218) were rejected by the Municipal Art Commission of New York on that account. When steel is not painted, it will lose one-quarter of an inch on each face by rust in a century, and this liability is its chief objection. The duration of metal bridges depends, therefore, on painting, which may be overlooked, or corrosion may attack inaccessible parts. Of the three metals, cast iron, wrought iron, and steel, cast iron is least subject to rust, and steel the most easily attacked. The most desirable ma-

terial is, therefore, the least permanent. Ordinary metal bridges rarely last more than thirty to forty years, while the great monumental ones which are best protected can hardly be expected to endure more than two or three centuries.

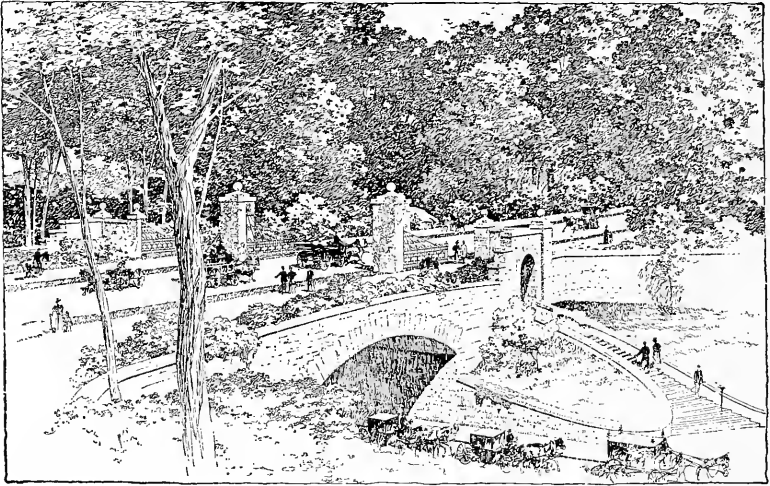

Fig. 17

A frequent objection to steel bridges is the supposed difficulty in beautifying them, but this is largely owing to the absence of precedent in this material. Art standards for wood and stone have been established for centuries, but none were available for metal.

SELECTION OF PROPER TYPE

An unfortunate practice, in America at least, is the making insufficient appropriations for constructing bridges, and the

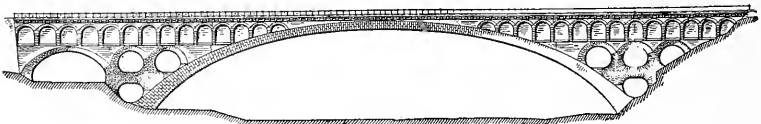

Fig. 18

need of suiting the design to the available funds. The reverse method should be followed, for the design should first be made to suit the location and the money afterwards provided. When

appropriations must be made in advance, they should be large enough to avoid detrimental limitations. It is assumed in the following pages that all such limitations are absent, and that the form and type best suited to the place may be selected. But even when designed under a restricted cost, it is usually possible to retain artistic features and outlines, and to economize, if necessary, by making a less width or capacity.

The principal features of the bridge must be selected arbitrarily to suit the requirements. The width of deck, number of spans, and the live load which the bridge must support are all constructive or engineering questions, and the amount of æsthetic or architectural treatment must also be arbitrarily determined. The degree of permanence required is another prime factor greatly influencing the cost. Long spans are usually preferable to shorter ones for river interests, because of less obstruction from the piers, but when arches are used, the roadway grade may be so near the water that enough rise is not available for long spans, and shorter ones are then obligatory. Long spans also have a greater relative cost than short ones, the cost increasing in proportion to the square of the span. The Alexander III. bridge (Fig. 72) at Paris, one of the most beautiful in Europe, has insufficient rise to exhibit an appearance of strength. The outline resulted from a fixed street grade, and a purpose to avoid river piers.

The degree of ornament must be determined according to the importance of the location. In great cities, adjoining monumental buildings, the beauty of the bridge should surpass or at least equal its surroundings, so the eye will naturally be attracted to it. The same applies to bridges in parks or private estates where beauty is the first essential. In such places artificial lagoons are made as ornamental features, that they may be crossed by beautiful bridges, and no limit should be placed on the amount of art which may appropriately be displayed. Less ornament is generally sufficient in smaller towns, and only in remote districts, seldom or never seen, should æsthetic design be neglected.

The selection of a proper outline will to a great extent determine its artistic merit. Curves are preferable to straight lines, and should be adopted wherever construction requirements will permit. But in choosing a form, and afterwards in designing the bridge, the ultimate object should always be kept in mind, which is, to provide a platform of suitable width, strength and beauty, over which travel may safely pass.

Deck bridges are nearly always preferable to other kinds, and should be used in towns and cities wherever under clearance will allow. Through bridges obstruct the river view, which is usually attractive, and the framing is often the cause of injury to loaded vehicles, especially during crowded periods or in case of fire. Everywhere in and about American cities numerous illustrations exist of bridges unsuited to their location. The creation of a municipal art commission in each city should remedy much of this evil, for these supervising bodies should realize that fine monumental bridges add character and distinction to their cities.



FIG. 19. BRIDGE IN BELLE ISLE PARK, DETROIT.

CHAPTER VI

Principles of Design

Nature exhibits two distinct elements in her creations: First, the constructive, and second, the æsthetic. The first of these is purely utilitarian, and in taking nature as his guide, the engineer finds that structures must first be considered from the constructive standpoint, and attention given to their capacity, strength, economy and proportions, and the secondary motive is their adornment. The great majority of American bridges have unfortunately been planned with no thought whatever for their appearance, merely as "tools of transportation." But the age of design by mathematics only, has fortunately passed, and the era of a higher ideal in bridge design has been revived.

It is generally easier to beautify a simple structure than one containing different materials, for in the latter case the light framing is apt to clash too seriously with the heavier masonry. The contrast is illustrated in the 825-foot arch design for the Hudson Memorial bridge at New York (Fig. 218).

CO-OPERATION OF ENGINEER AND ARCHITECT

In large or important bridges, unless the engineer himself is proficient in æsthetics, which is seldom the case, it is better to have an architect associated on the work from the first, not merely to decorate the bridge after the engineer's work is finished, but to assist in the design from its inception. If a wrong outline be selected in the beginning, no effort of the architect and no amount of decoration can remedy the error or make a beautiful bridge of an ugly one. But when æsthetics are considered from the start, the design should then develop harmo-

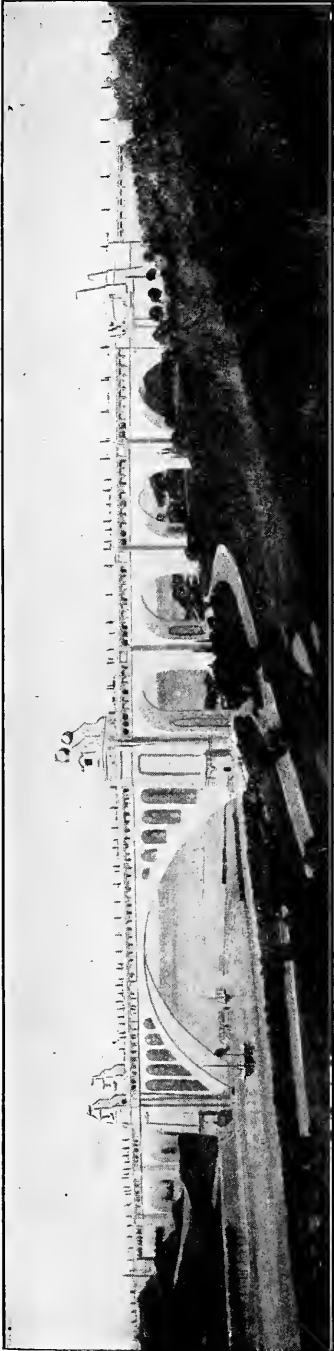

Fig. 20

niously into beautiful construction. Unfortunately, a lack of harmony between the two professions has been a hindrance to successful co-operation, for the architect declared that the only bridges with any real beauty are those which antedate the days of engineering, while the engineers know that nearly all the great modern bridges are the work of engineers alone, and that to engineers more than any other class is due the rapid progress of the last century. The members of each profession now realize that all their time is occupied in mastering their own special studies, and the engineer is willing to admit himself deficient in the training of his æsthetic taste, and the architect confesses his lack of constructive knowledge. With this mutual understanding, there should be no more difficulty in working harmoniously together on bridges than on buildings, which is already a common practice. The finest designs ever produced in America are those which are the combined

work of engineers and architects, including the memorial bridge designs (Figs. 21-22) for Washington, and the several bridges for New York City. It is now plain that the great bridges of the future will not be the product of either engineer or archi-

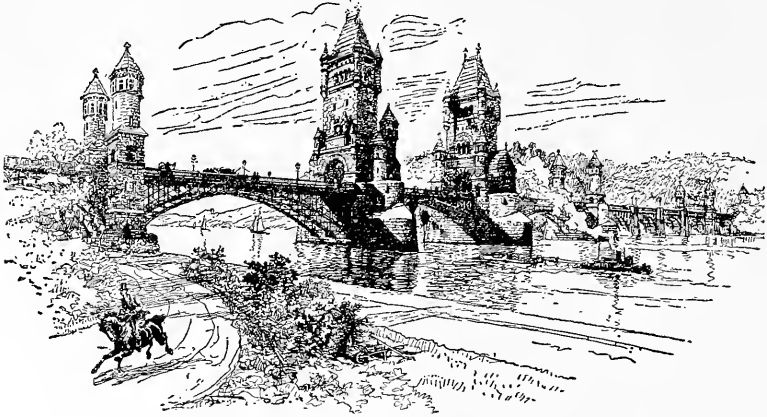

Fig. 21

tect alone, but of both combined. That this condition of coöperation now exists in Germany is clearly shown by some of the recent bridges in that country, including those at Worms (Fig. 227), Mainz (Fig. 230), Düsseldorf (Fig. 229), and Cologne (Fig. 241). The railroads, which have been amongst the worst offenders in America, no longer leave the design of

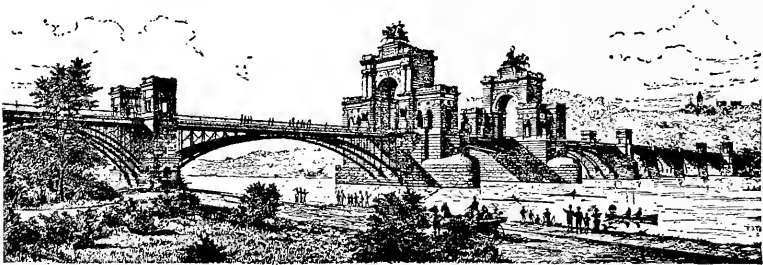

Fig. 22

stations and other buildings wholly to engineers, but use the combined service of engineers and architects, and the same coöperation must soon apply to bridges, which are frequently more conspicuous than stations. It will then be no longer possible for a "professional vandal" to be an eminent engineer.

The artistic motive is not the prevailing one and must be subservient to construction, but it must not be neglected. The tendency in architecture is frequently to add excess material in order to secure satisfactory proportions, while the object of the engineer is usually to eliminate all useless weight, which only requires additional framing to sustain it. It is only by working together that correct results are obtained. Factory designing of bridges resulted in much economy, and competitions were the cause of great progress, but the relation of engineer to factory or bridge shop now should be precisely the same as the corresponding relation between architect and building contractor.

GENERAL DIMENSIONS

The purpose of a bridge should at all times be kept in mind during the progress of the design, the object being to construct a platform of suitable strength and width to convey travel safely, and at the same time provide openings under the bridge suitable to the local requirements. Small spans are no longer desirable, though they may sometimes be permitted over quiet water. Long spans are demanded for river travel and commerce, or for crossing deep or rapid water. The span lengths should seem to fit the river width, for if longer, they appear excessive, and if shorter, they look insufficient. Deck bridges are preferable to through bridges, for framing above the floor is an obstruction to the river view, and a menace to travel. Panels or other subdivisions should be proportioned to the whole. The arrangement and grouping of spans should be carefully considered, and the same kind of construction used to meet similar conditions.

PIERS

A bridge with too many piers (Fig. 23) is little else than a perforated dam, and it is a serious obstruction in running or navigable water. The thickness of piers should be carefully proportioned to their height, and base courses and copings

suited to the pier body. The height of substructure and superstructure should also be proportioned to each other. Double cut-waters, though not a structural requirement excepting in

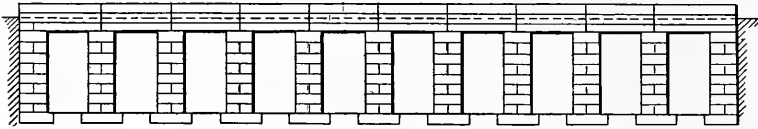

Fig. 23

tidal channels, give a more symmetrical appearance, and may prevent scour on the rear end of piers.

PRINCIPLES OF DESIGN

The general principles of artistic design are:

1. The selection of the most artistic form consistent with economy.
2. Expressiveness.
3. Symmetry.
4. Simplicity.
5. Harmony and contrast.
6. Conformity with environment.
7. Proper combination of materials.
8. A judicious use of applied ornament.

1. The elevation of a bridge is more seen than any other view, and spectators are most impressed by its general outline and proportions. If a wrong outline be selected, the effect artistically is sure to be a failure, for no amount of detail or applied ornament can remedy the error. And yet in some cases where straight lines are imperative applied ornament may be effective and is permissible, as in the Forest Park entrance bridge at St. Louis (Fig. 24). Where artistic form and outline are obtainable, as in a great suspension bridge with cambered floor, the outline may in itself be sufficient, without any applied detail. In fact, small ornamentation on great structures frequently produces a diminutive effect, and is not desirable. Structural requirements must predominate, especially in

large bridges, and even though the public now lacks appreciation for correct structural forms, the vital principle must be maintained that “there is beauty in any useful structure designed on lines of true economy with the utmost simplicity and



Fig. 24

fewest parts.” The best effect is secured from the most pleasing outline consistent with economy, and a very limited use of applied ornament. The æsthetic outline may be close enough

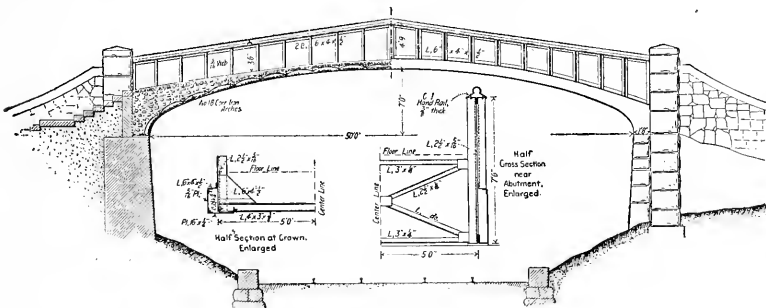

Fig. 25

to structural requirements to be quite as effective, and have no greater cost. From the standpoint of beauty, curves are always preferable to straight lines, and of certain forms like the semicircle or ellipse the eye never tires. When arches are

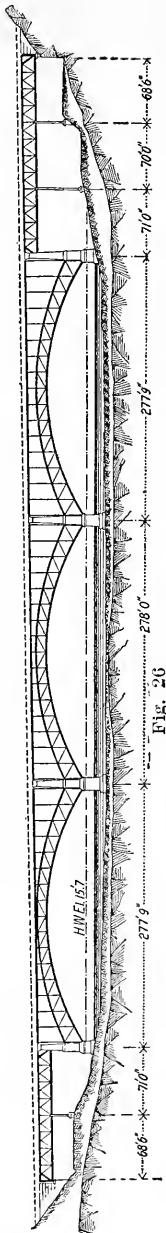

Fig. 26

impossible, a decided camber on a truss or girder is often effective. The upward curve of the floor lends as much beauty to the Brooklyn bridge (Fig. 235) as the downward sweep of the cables. The beautiful park bridge at Madison, N. J.* (Fig. 25), has cambered girders, the satisfactory effect of which cannot be questioned. In any case, to avoid the appearance of sag, a small floor camber is desirable.

Similar means should be used towards similar ends, but a change of constructive form should not be made without an evident purpose. Small side arches may adjoin large central ones, where the height changes, as in crossing a valley. An uneven number of spans is always preferable (Fig. 26), for the eye is better satisfied with an opening rather than a pier at the center. Bridges with several spans should have the longest at the center, and adjoining ones should decrease in length toward the ends.

EXPRESSIVENESS

2. Expressiveness in a structure is, with many people, the greatest element of beauty, and the visible parts and lines should show their purpose. Imitation and deception are most contemptible when carried out in constructive forms. A bridge must be a truthful creation and its appearance should show its purpose. If the spandrels of a masonry bridge are hollow they should so appear, and should not be concealed with curtain walls. As strength is a chief requisite, this element should be emphasized. Some recent metropolitan bridges of long span, where only a small

* H. G. Tyrrell, in *The Engineer*, London, Nov., 1900; *Engineering News*, Aug., 1900.

rise was available, lack the appearance of strength and fail to impress an observer with a feeling of security. Expressiveness is also obtained through special or ornamental features. A memorial bridge relates its own story by its statues, friezes, and inscriptions. Sentimental or historical traditions are well illustrated on the portals of many European bridges, such as those at Kehl, Bonn, and Mayence. The Gothic portal of the Kehl bridge (Fig. 242), somewhat resembling cathedral architecture, might be a historical representation of the times when bridges were erected and preserved by the clergy of Pontifices, under the direction of the Pontifex Maximus. Remains of many bridges built by this religious order are still extant. Combinations of different types in one structure such as in the arch-cantilever, or in the arch truss which was common in wooden bridges, are lacking in simplicity and definite action, and such forms are therefore not so desirable as single systems. Expressiveness is very easily obtained in the abutments of metal arch bridges, which may be made of such size and form as to clearly show their duty and action. In this case extreme economy may sometimes be ignored for the sake of emphasizing the abutment action.

SYMMETRY AND SIMPLICITY

3. One of the most important factors of good design is symmetry. If conditions will at all permit, the general outline on each side of the center should be the same, or nearly so

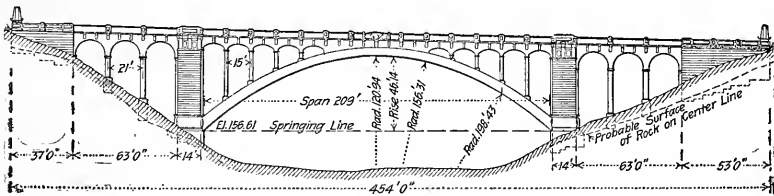

Fig. 27

(Fig. 27). It should at least partake of the same general arrangement in reference to the number and length of spans. There is no greater jar to æsthetic feeling than to see a bridge

in which this principle is violated, with large spans at one end and smaller spans at the other, or with the principal span noticeably out of center (Fig. 28). The beautiful design for the proposed Hudson Memorial bridge (Fig. 20) is unfortunately marred by an unsymmetrical ground contour, necessitating approaches of different lengths. The presence or absence of

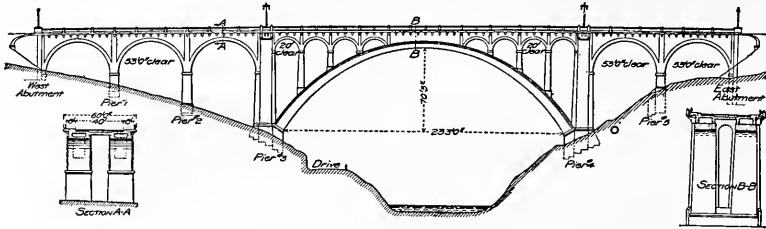

Fig. 28

symmetry, and the resulting effect, is well illustrated by the many designs for the Washington bridge at New York. Those in which symmetry is observed are satisfying, while others are not. The absence of symmetry should be permitted only when the ground contour or other conditions are such as to make a symmetrical arrangement impossible. Sub aqueous conditions may necessitate an uneven arrangement of spans, but as the reason for the change in such cases is not evident, the design is æsthetically unsatisfactory.

4. Simplicity is important, though not so essential as symmetry. Too many members are confusing, and a less number of larger pieces are preferable. The confusing effect is best realized when a bridge is viewed in perspective, from which position the bracing in all directions is evident, and the lines may appear to cross each other at many angles.

HARMONY AND CONTRAST

5. An abrupt change is sometimes better than a gradual one. When approaches are of very different construction from that of the central span, the two should be conspicuously divided (Fig. 29), as with a heavy pier. Short end spans should have a character of their own and not be miniatures of the larger ones. Spans arranged in groups produce a better

effect than a succession of similar ones, and groups should preferably contain three spans or more. The comparative æsthetic effect is exemplified in tall viaducts. Those in which alternate long and short spans are supported on braced towers appear better than a succession of equal length bays, the improvement being due to contrast. The type of construction should not change unless the reason for such change is evident, as in the

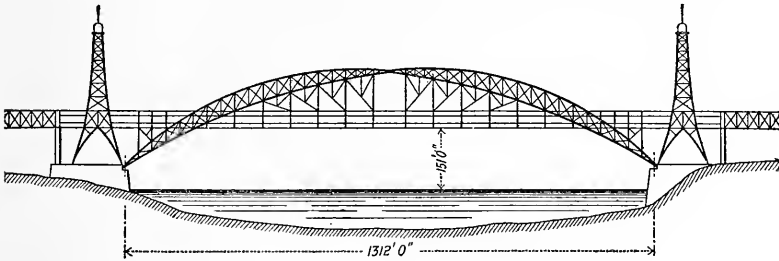

Fig. 29

use of steel framing for the center span of a stone viaduct. Some of the competitive designs for the Washington bridge proposed, with insufficient reason, very mixed types of construction, and the artistic effect was thereby injured.

CONFORMITY TO ENVIRONMENT

6. A highly ornamental bridge would be inappropriate in a rough district, and an unsightly truss bridge is out of place in a park or city among beautiful surroundings. In a wild mountain region the bridge should be bold, while in a park it should contain fine ornament, and have a more finished appearance. The rule, generally, is to make the bridge more striking than its surroundings, so the eye will be naturally attracted to it. The modern method is to make separate photographs of the site and the design to the same scale, and after placing the proposed bridge in the landscape view, to rephotograph the combination. Features of the design which fail to conform with the surroundings will then appear, and changes can be made until it is satisfactory. The Conway suspension bridge (Fig. 233) is an excellent example of one harmonizing

with its surroundings, the towers being made to resemble those in the adjoining castle. The architecture of the Tower bridge (Fig. 83) was intended to conform with the near-by Tower of London, and the Saintes bridge (Fig. 30) over the Charente had triumphal arches over the roadway similar to the openings in the adjoining castle wall. A rustic bridge of either wood or

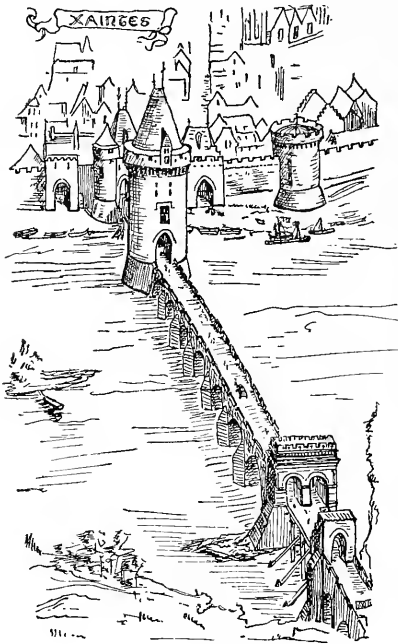

Fig. 30

stone is appropriate in a wooded park or rural district. In a park with rough and rocky surroundings, no form is more suitable than a bold-faced masonry arch, while in a garden or private estate surrounded by landscape gardening, a finer class of work would naturally be preferred. In the latter case, stone work would be finely cut ornamented with corner and belt courses, and the road guarded with a highly ornamented railing. Landscape gardening about the approaches adds greatly to its beauty, and should be

carried out when possible. In any case, even in rural or out-lying districts, the site should be cleaned up and left in a trim and neat condition. The principle of conformity to landscape is therefore one of the most important.

MATERIAL AND COLORS

7. The laws of harmony and contrast apply also to the selection of material and colors. Heavy projections and deep shadows produce an effect of strength which is not easily secured without them.

Color combinations produce harmony or discord on the

senses similar to combinations of sounds. Soft colors are preferable to bright ones, and if two or more are used, they should, if possible, emphasize the construction lines. The arch stones and trimmings may be of one colored material, and the spandrel walls of another. If paint is used on wood or metal, it should harmonize with the stonework and surroundings. Concrete blocks, hard brick in different shades, cut stone and concrete of different tones may all be used to good effect.

USE OF ORNAMENT

8. A distinction must be made between those structures which are naturally graceful, and others on which decoration is evident. A design should please without apparent effort. Ruskin's rule to "decorate construction without constructing decoration" applies to bridges as well as buildings. Superfluous ornament may render a bridge ridiculous, and an excessive amount, especially on large ones, is not commended, though a judicious use is right and fitting. In this matter, nature must again be the guide. The skeleton of trees or plants are covered with leaves and flowers, and the rough hill sides with beauty and verdure. So with structures, a limited amount of ornamental features is appropriate, but excessive ornament which would add greatly to the imposed loads cannot be permitted, especially on framed bridges, as all added weight requires extra framing to support it. The use of ornament to this extent is contrary to the fundamental principle of economy. For this reason, very little or no heavy ornament should be allowed on steel spans between the piers. Small decorative features are suitable only when they can be closely observed, as on the balustrade or railing. Panels should be either square or decidedly long. Features which can be seen only from a distance should be large, or the general form or outline may supply the only ornamentation. The ends or portals offer the greatest opportunity for embellishment. In this position, weight is not added to the bridge, but only to the piers or abutments, and as the ends are usually exposed, decorative features are easily seen.

CHAPTER VII

Ordinary Steel Structures

Large metal bridges should always be proportioned according to the rules of economy and service, depending for their artistic effect on their general form, and very large spans must always be framed in steel. Steel bridges have not been long enough used to win for themselves the public appreciation which they deserve, and when better understood they will be more admired. A limited amount of ornament may be used on the spans and on the balustrade, lamps, trolley poles or brackets; and a large amount on or above the piers. Framed bridges should have the smallest possible number of parts, for excessive bracing appears confusing, and when viewed obliquely the lines seem to lack proper arrangement. Arches and suspensions are the most artistic forms, though cantilevers with curved outlines like those at Budapest and Pittsburg may be equally pleasing. Skew bridges should, if possible, be avoided. Steel bridges are usually more difficult to beautify than masonry, and their chief interest must result from their outline. The need of painting is the chief objection to metal, for if this be neglected, the metal soon deteriorates. Half through girders are improved when the outer ends are curved to a quarter circle.

BEAM BRIDGES

Small spans are worthy of careful consideration and treatment, for they greatly outnumber the larger ones, and horizontal beams are frequently necessary to give the proper height below. Beam bridges are much used for street subways under railroad tracks where the latter are elevated on banks to avoid level crossings. In such cases, the required head room above

the street is first established, and adding to this the thickness of the floor, gives the height of track above the street. It is frequently desirable to use a thin floor, for any increased thickness would raise the height of the whole embankment by the same amount. When the span is long enough to require a greater depth for the main girders than can be allowed beneath

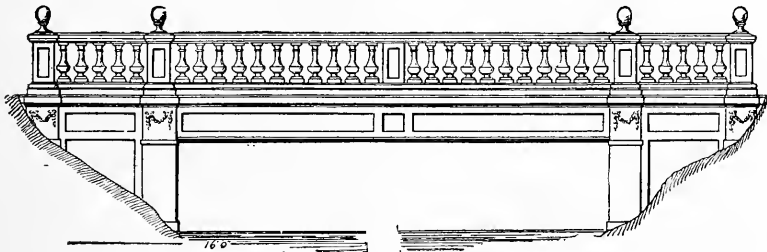

Fig. 31

the upper floor or track, half-through framing may be necessary, with a system of floor beams supported by side girders far enough apart for track clearance. This arrangement was used at the entrance to Forest Park, St. Louis (Fig. 24), the steel girders being concealed by an outside ornamental concrete facing. As the side area of the beams is usually small, the chief opportunity for adornment is on the abutments and balustrade. That good effect can be secured is shown by the

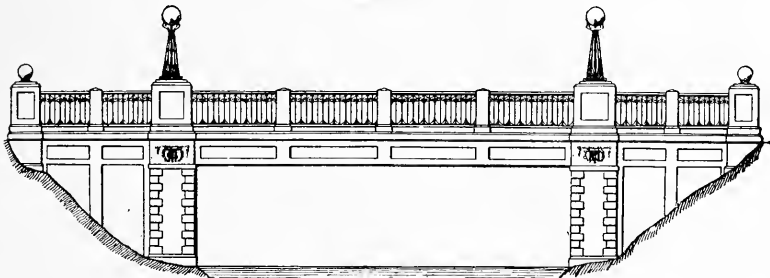

Fig. 32

illustrations. Fig. 25, with side girders in arch form, is not as sincere as Fig. 24, and over a street the curved soffit might leave insufficient head room above the sidewalk, but it nevertheless

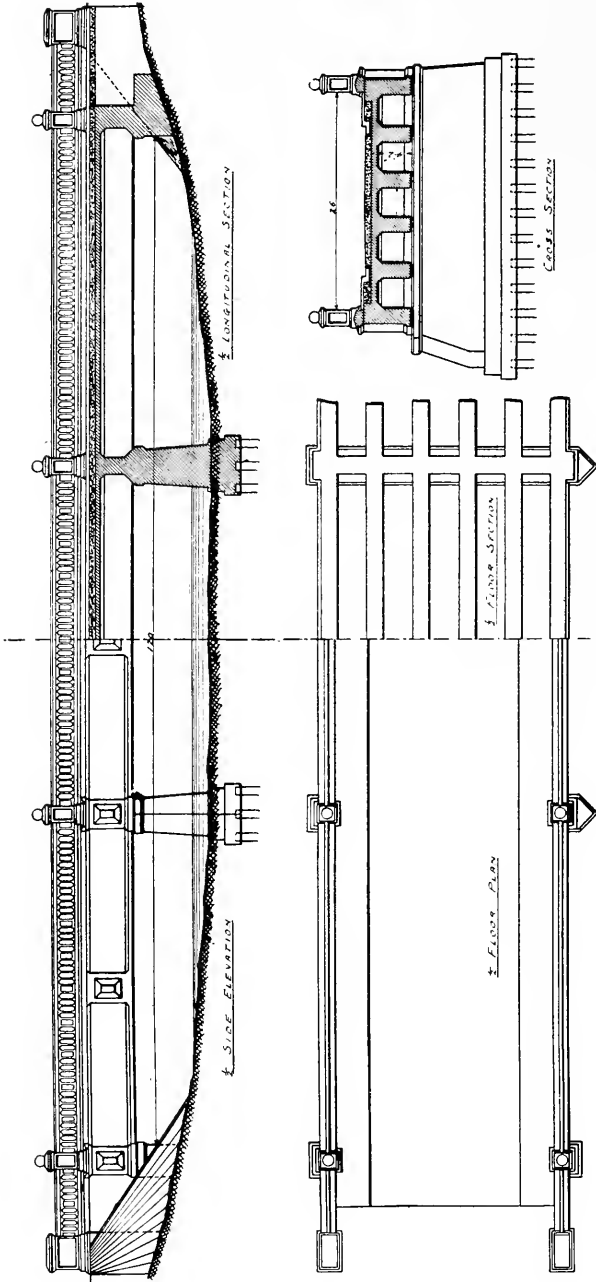

Fig. 33

looks well. The writer's three original designs in reinforced concrete (Figs. 31-32-33) show some other possibilities with this type, the first two being well suited for parks.

TRUSS BRIDGES

A few years ago most truss forms were patented, and the outline of a bridge at once revealed its originator. But the process of elimination has been active, and a few only of the

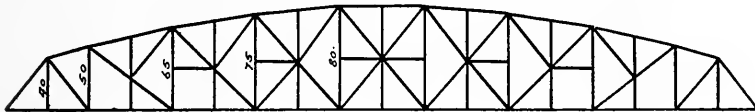

Fig. 34

most approved forms are now favored for ordinary spans, though special study is usually given to longer ones. Trusses have a greater weight than arches or suspensions, but their

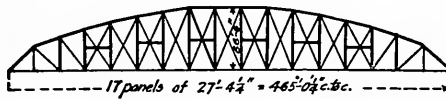

Fig. 35

cost is generally less than either. Upper chords when curved should have the principal panel points on a parabola (Fig. 34*), with straight sections between, and in the case of through truss bridges the curves should continue only between

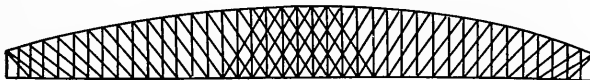

Fig. 36

the upper ends of inclined end posts, and not down to the shoes. If the end posts are a continuation of the upper chord curve, their inclination is not sufficient to produce a sense of strength and security. Figs. 35 and 36 have insufficient end

* Elizabethtown Bridge.

* H. G. Tyrrell, in *Canadian Engineer*, November, 1909.

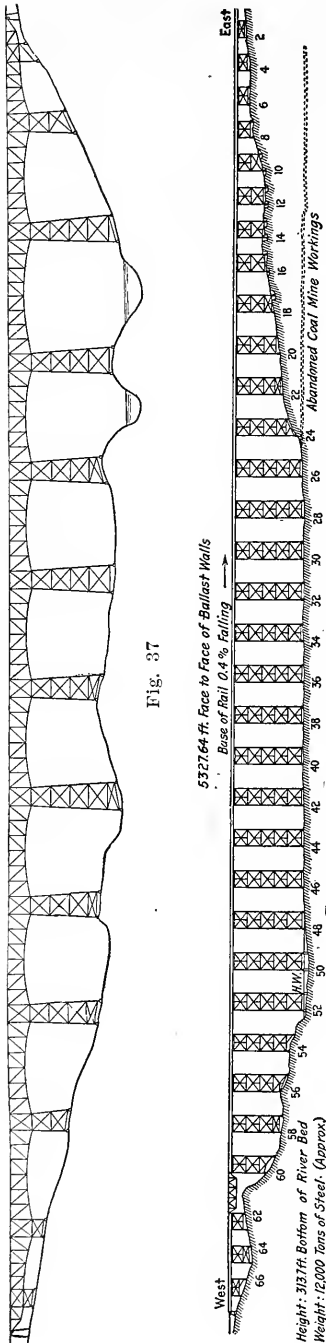

Fig. 37

Fig. 38

depth for appearance, and too many web members, the double panels and simpler outline of Fig. 34 being more satisfying and preferable. Trusses with curved upper chords and ties at or below the floor level, like those at Mainz and Worms, are meeting with much favor in Europe, but are discussed under Arches, because of their close resemblance to the true arch bridges at Bonn and Düsseldorf, which have inclined pier thrusts. Curved connection plates in trusses must have curves tangent to the members, and not segmental. Other general principles of artistic design, such as symmetry and simplicity, should be applied wherever possible. The inclination of web members should be as nearly uniform as possible, approaching an angle of 45 degrees, but uniform inclinations should not be obtained at a sacrifice of simplicity in the floor system. In designing the 586-foot trusses of the Elizabethtown bridge, an outline was considered with diagonals at uniform inclinations, and panels increasing in length towards the center, but on account of the irregularity which

would result to the floor system, it was not favored. The plan has, however, been carried out since in the trusses on the Municipal bridge at St. Louis.

VIADUCTS AND TRESTLES

The best effect in this class of structures is secured when the length of intermediate spans is great in proportion to the length of towers, as in the Fribourg viaduct in Switzerland, or the Dowery Dell in England. When the length of tower and intermediate spans are the same or nearly equal, as in the artistically unfortunate viaduct (Fig. 38) recently erected in

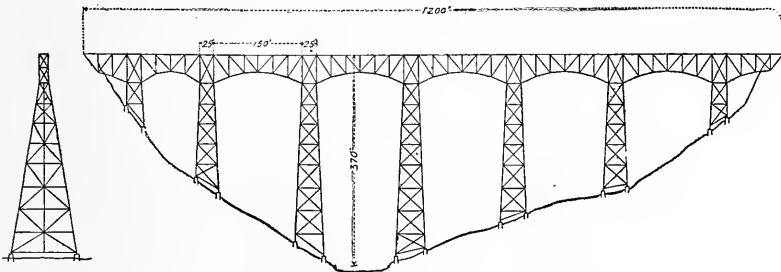

Fig. 39

Northwestern Canada, all semblance to beauty is lost. Intermediate spans may have curved bottom chords, as in the high viaduct (Fig. 37) designed by the writer for the Montreal river crossing in Algoma.* They have the additional merit of facilitating erection by their cantilever action, and permitting the use of a comparatively short boom traveller. Towers

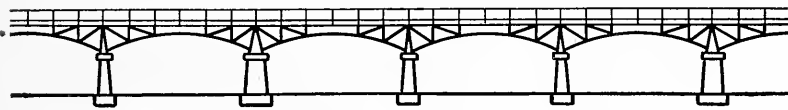

Fig. 40

should have the necessary transverse batter, and a slight longitudinal taper of about half inch per vertical foot, on each column. The comparative æsthetic effect of towers with and without longitudinal column batter, is seen by comparing Figs. 37, 39 and 42 with 38 and 41. Towers with vertical bents have an awkward or top-heavy appearance. Fig. 39, designed

* Economic length of trestle spans.

* H. G. Tyrrell, in Railroad Gazette, December, 1904.

by the writer for heavy railroad travel over Salmon river gorge, represents the best American practice. The extra cost of shop work on the connection plates is small, and is warranted by the improved appearance. Fig. 40, part of the writer's design for a 2,600-foot viaduct at Ogden, is a form which is suitable for carrying streets over railroad yards, the curved bottom chords having a better effect than horizontal ones. It is good practice to use abutment piers at intervals of three to five spans, and these may be of metal or masonry, as desired.

MOVABLE BRIDGES

Ugliness in bridge design may usually be attributed either to the incompetence of the designer or to the restrictions imposed upon him which are beyond his control. The latter excuse is,

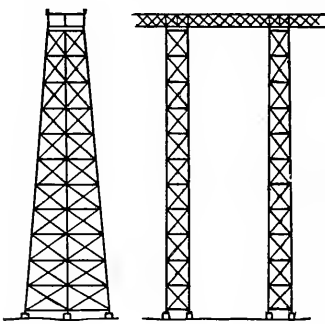

Fig. 41

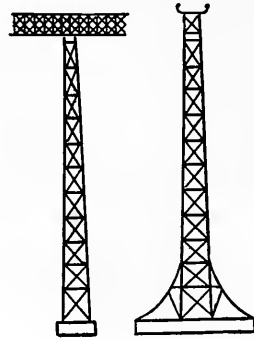

Fig. 42

however, too frequently offered where it is not sufficient. Some of these limitations are as follows:

- (1) Number of decks and their relative position.
- (2) Elevation of deck above water.
- (3) Under clearance required.
- (4) Angle of crossing, whether square or skew.
- (5) Grade.

A great many kinds of opening bridges have been devised, and it is difficult to conceive of new forms which have not been previously used. In fact, most of the patented inventions of

the last twenty years are merely revivals of projects which were studied out or built by others during the last century. Many features of modern bridges, originality for which is claimed by recent proprietors, may be found in use before the advent of the present generation, and there is, therefore, no branch of engineering in which a knowledge of history is more essential.

Movable bridges show a greater lack of æsthetic treatment than almost any other form, and many of them are about as ugly as could be imagined. Like other kinds, they must depend chiefly on their outline for their appearance, and their form should, so far as possible, show their purpose and action. If a wrong outline is chosen, no amount of after-treatment can remedy the error, as was so well proven by the balanced bridge over the Royal Canal at Dublin.

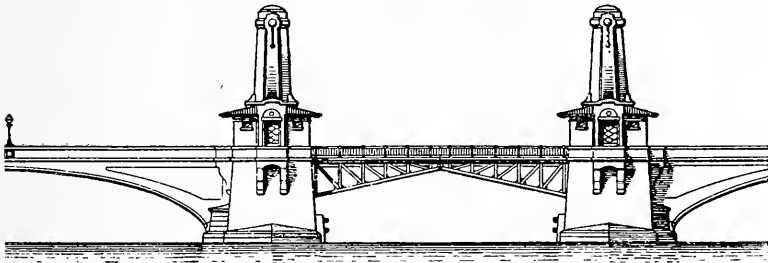

Fig. 43

Each individual case requires different treatment, and a form which would be most suitable for one location might be quite unsuited to another. Bridges in cities like Chicago, London and Berlin, where the land adjoining the river is low, are perhaps the most difficult to treat satisfactorily; and yet these cities, especially the last, have many examples of much merit.

The number of decks and their height above the water, greatly influences the design, and the required under-clearance will usually fix the bottom outline. Deck bridges are nearly always preferable to through ones, and should be used wherever

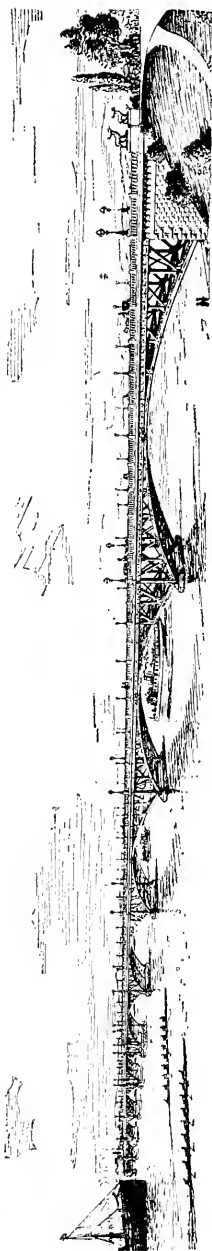

Fig. 44

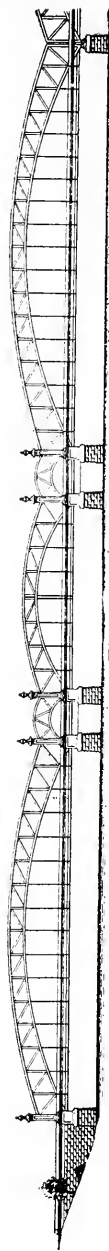

Fig. 45

enough height is obtainable beneath the floor for framing. Parts above the deck obstruct the view, and may be a serious hindrance to travel, especially during crowded hours or in such emergencies as fire. When enough height is available, a curved form generally looks better than a straight one, though the latter leaves more space for the passage of boats and river craft. The height of floor above water, the length of span and number of leaves, will also determine whether the floor must be above the principals or between them. The design is also influenced by the angle of the crossing, whether squared or skewed, and by the approach grades. In some cases, where the piers must stand parallel with the current, the angle of the skew may be small enough that the ends above the piers may be arranged as though the bridge were square, enough space being available on the top of piers for arranging the shoes to the proper angle. In any case, skewed end panels, as on the bascule over Fort Point channel, Boston, and near Kinzie street, Chicago, should be avoided where possible.

Features which may usually be arbitrarily selected are:

- (1) Number of principals.
- (2) Kind of principals, truss or girder.
- (3) Number of leaves.
- (4) Outline of principals.
- (5) Bracing.

The surroundings of a structure greatly affect its appearance. They should always be neat, and, when possible, should have enough open space adjoining so the bridge will stand out conspicuously. Landscape gardening at the ends is most appropriate, such as may be seen adjoining the old Budapest suspension.

Double leaf bascule bridges are the best form for decorative treatment, for the outline of the two leaves can be made to correspond with the curves of the adjoining spans. Single leaf bascules are not artistic, for they lack symmetry, but an effort must be made to beautify them if any grace is to

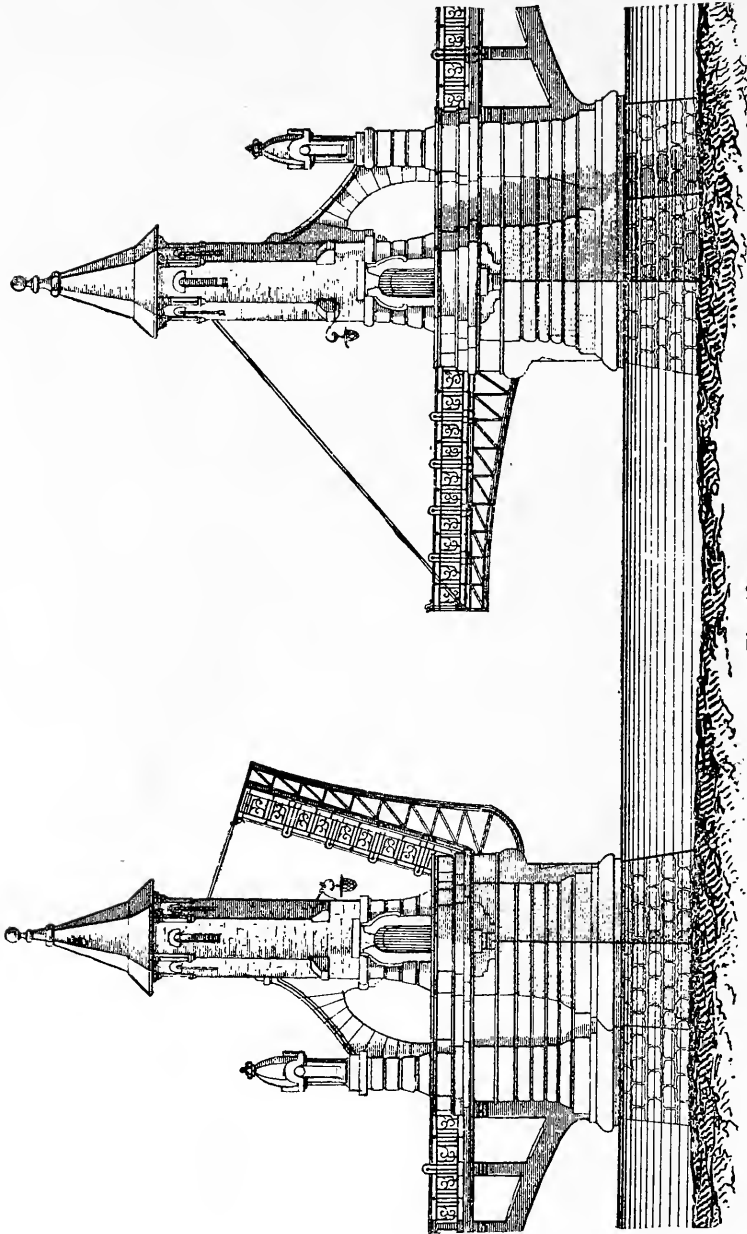

Fig. 40

appear. Combined bascule and cantilever, such as those patented by Messrs. Shaw and Newton, have a greater clear width between the piers, but the leaves when raised are unprotected, and none of this kind have yet been constructed.

A curved outline for the bottom chord usually looks well (Figs. 44-46), and is suitable when the necessary height is obtainable, the form being used in 1839 for the Ouse river bridge at Selby, which acted as a true arch under live loads. In other cases, through arches can be used, as at Stettin over the Oder, completed 1905, and at St. Petersburg over the Neva; a somewhat similar one (Fig. 45) being proposed in 1906, to cross the Potomac at Washington. Double cantilevers with a horizontal bottom chord and a curved upper one following the lines of a stiff suspension, are used for bascule bridges over Newton creek at New York and at Twenty-second street, Chicago, and, as far as outline is concerned, are fairly satisfactory.

The number of leaves depends chiefly on the length of span, single ones being suitable up to about 150 feet. For appearance, two are preferable to one, as the arrangement is then symmetrical, besides making a deck structure possible, where a single leaf might need through trusses. Though more expensive, two are always preferable to one for highway bridges, and the leaves, when raised, form a substantial barrier against road travel. But double leaves are not suitable under trains and locomotives, as the center connection is too uncertain, and liable to cause derailment. A double leaf bridge for heavy loads was used at Rhyl previous to 1871, and proved to be a mechanical failure because the center lock was insufficiently secure. The Fijinoord bascule at Rotterdam (1875) and the later one at Duisburg (1906) have two double-leaf bascules, close together, the latter having space between the adjoining bridges for the operators' house.

Bascule towers (Figs. 43-46-47) are the chief opportunity on these bridges for adornment. Schwedler's prize design, made in 1850 for a bridge over the Rhine at Cologne, had a

double bascule at the center, with imposing central towers connected with an overhead footbridge, similar to the Tower bridge at London. A bridge with smaller portal tower, overloaded with excessive ornament, may be seen at Camden, N. J., the tower frame being covered with concrete on ex-

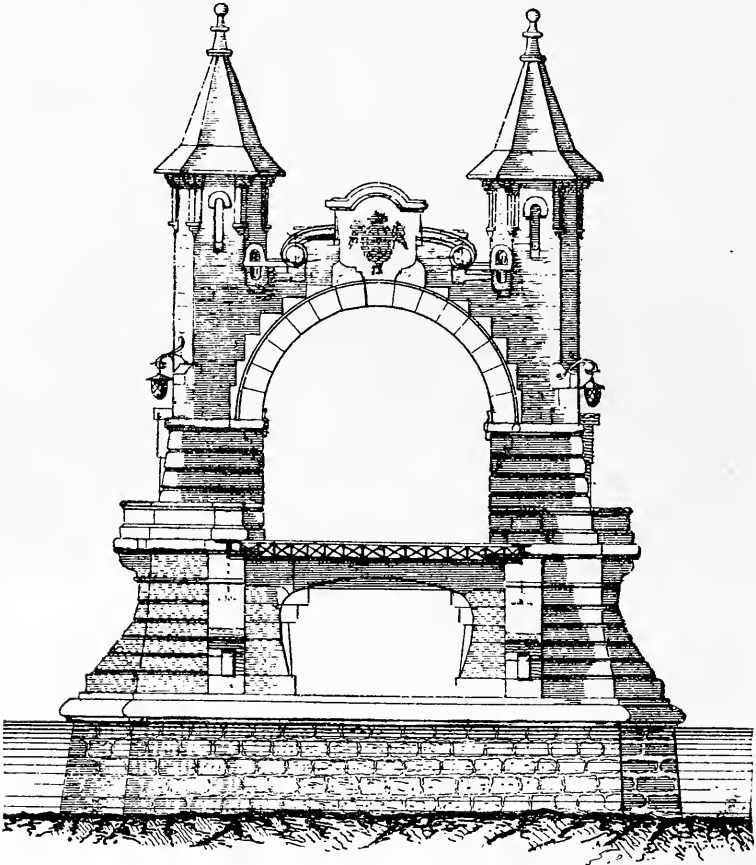

Fig. 47

panded metal. Portal towers and arches are also used at the ends of the swing bridge over Passaic river at Fourth street, Newark, N. J., the iron framing being covered with boards and sheet copper. Besides marking the limits of the opening, these features are useful and expressive, and serve as guard-houses and shelters.

The position of the trunnion and counterweight greatly influences the appearance of bascule bridges, and careful study should be given to these features. In the Brayton patent the trunnions are elevated to avoid the need of counterweight pits, and the presence of the counterweight is emphasized. On many other designs the counterweight is so disposed as to make any æsthetic treatment almost impossible.

Swing bridges are unsightly and the part above the pier has no meaning or use when the bridge is closed, unless in those where the dead weight is at all times transferred to the center



Fig. 48

pier. Reverse curves on the upper chord, and portal and tower ornaments or finials may be used with good effect. The full benefit of swings is obtained only when two channels are crossed with equal arms. Unequal arms of either truss or plate girder fail æsthetically through lack of symmetry, and, including the counterweight on the shorter arm, they have excess weight. Reverse curves on the upper chord, such as used on the Third avenue and Willis avenue bridges at New York, and at Norwich, England, are believed by some to look more graceful than straight lines between the panel points, but they need a greater number of web members, and the result at best is not so good as may be secured from some other forms. Continuous segmental curves for the upper chord

were generally used on the early timber swings in America, such as shown at Webster avenue, Chicago (Fig. 48). Those at New London and Duluth are examples of swings with upper chord points on a curve, and straight members between, while that over the Connecticut river at Middletown (Fig. 49), designed by the writer in 1896, has upper chords in a straight line. The last has a length of 450 feet, and is the longest highway swing span ever built.* Two other examples of the best that is obtainable in through swing bridges, are the Ship

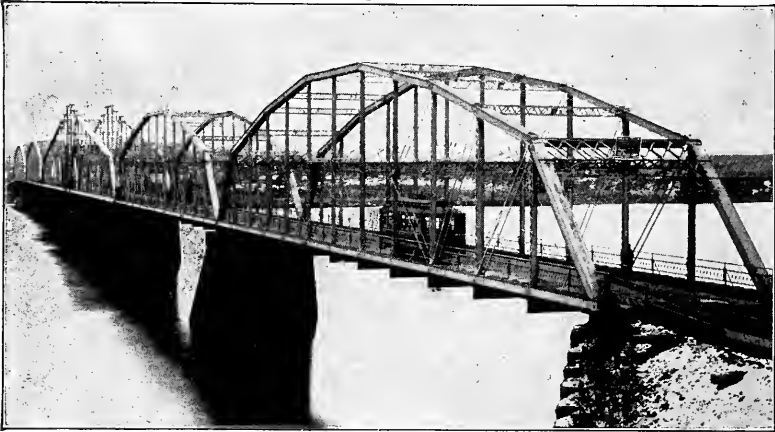

Fig. 49

Canal and the Seventh avenue swings at New York, the only deserved criticism of the former being an unfortunate break in the upper chord at the second panel from either end. The masonry and approaches on these bridges are carried out with graceful lines and fine detail.

The tower and center panel of swing bridges frequently contain features which affect their appearance, such as toggles at the upper chord, as used by the Erie railroad on their bridge at Hammond. The tower usually contains the operator's house and platform, and as the house is conspicuous, it should be made an architectural study, with choice detail, and it can easily be made attractive, as there are few limitations. The

* H. G. Tyrrell, in *The Engineer*, London, March 1, 1901. *Railroad Gazette*, Dec. 27, 1901.

center tower of an old wooden bridge over the Arun river at Arundel (1845) might well be used as a model by some recent designers. The appearance of swings may also be improved by enclosing the turn-table with an ornamental cast-iron housing, moulded in graceful lines, with projecting ring courses, as was done on several swings in England. But as such enclosures add to the weight and cost, and make inspection more difficult, they are not favored in America.

The best æsthetic effect in swing bridges is illustrated by the Lubeck and Libau double swings, though, like other double-leaf bridges, they are suitable only for highways, the center connection without a pier being too uncertain for heavy trains and locomotives. A somewhat similar outline with a single swing between adjoining cantilevers, has a good appearance, but, without piers under the ends, is subject to the same criticism as those at Lubeck and Libau.

Lift bridges of the South Halsted street type, with towers at each side, are easily made attractive, good results having been obtained by W. Moorsom in 1850 in his design for a lift bridge over the Rhine at Cologne, with an under-clearance of 104 feet, and by Oscar Roper in 1867 in his design for a lift bridge over a wide river, with a span of 300 feet. An elaborate design with stone towers was made by T. E. Laing (1873) for crossing the Tees at Middlesborough, the moving span having a clear width of 200 feet and an opening for ships, of 90 feet beneath it, when raised. Five years later, M. H. Matthyssens prepared elaborate designs for a lift bridge over the Scheldt at Antwerp, the central moving span rising to a clear height of 130 feet between towers 131 feet apart. A still more elaborate design was made in 1883 by J. P. Bayley for a lift bridge over the Thames at London, the moving portion rising between a pair of great metal arches, leaving a clear passage of 90 feet for ships with masts. Many smaller ones were designed and built throughout Europe, including those over Grand Surrey canal (1848), Ourcq canal (1868), Rue de Crimee (1886), and at Dijon. The many

designs appearing in America since their introduction on the Erie canal, include those at Duluth, Chicago, Kansas City, New York, Keithsburg and Portland. Framed towers have the best appearance when the rear columns have either a straight taper or are curved, as on the lift over Grand Surrey canal (1848). The connection framing between the tower tops should have a curved lower chord in the form of a flat segment or ellipse, as on Moorsom's design of 1850 for Cologne.

Transporter or Ferry bridges with side towers and a platform at great height, can easily be made beautiful and impressive, especially when the center span is borne by cables, with their graceful curves. The moving car and the landing platforms at each end may have moderate adornment suitable to their location.

CHAPTER VIII

Cantilever Bridges

Cantilever bridges are a modern application of an ancient principle. Most of the early designs contained no trace of ornamental features, and no effort was made to beautify them. Because of their newness they were said to be a difficult type to make attractive, an excuse which has since proved groundless, as some recent designs are among the most artistic ones ever produced.

The proper use of cantilever bridges was at first, and is still often misunderstood. They were used in places where no scientific reason could be given for their presence, and in many cases no other explanation can be found for their existence than to provide experience for their designers.

The cantilever or bracket bridge has merits peculiarly its own, but it is economical only when erection false work would be very difficult or impossible. In other places, with easy erection, simple spans are preferable, for they are stiffer and contain less metal. Structural requirements must always prevail, but it is no more difficult to make a cantilever attractive than a suspension or arch. The form and outline should indicate the use of the cantilever principle. In this respect such bridges as the Queensborough (Fig. 51), Borcea and Forth (Fig. 239) are a success, while others, like the Hooghly cantilever (Fig. 52) at Calcutta, have a wrong outline and fail to show their real action.

NUMBER OF SPANS

The three-span cantilever, like that at Niagara, is the best known form, the two anchor arms being erected on false work, and the main span built out to meet in the center.

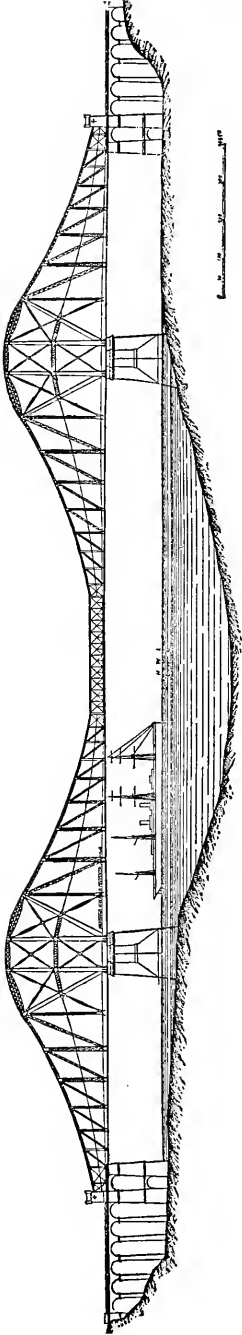

Fig. 50

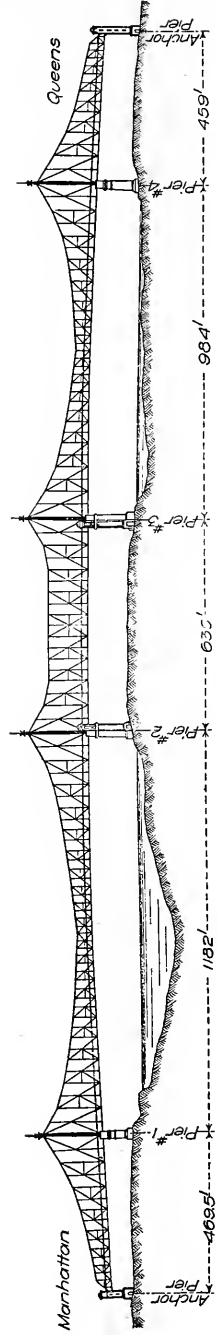

Fig. 51

Bridges of this type have horizontal upper chords and their outline shows little or no beauty. Similar ones with lower chords horizontal are illustrated by the bridge at St. Johns, N. B. A more artistic treatment with like natural conditions is shown in Pont de la Gryonne, where the truss depth of the side spans increases gradually from the abutments to the piers, and the lower chord of the center span is curved. The first artistic cantilever was erected in 1884, over the Danube Canal at Vienna, and three years later the Budapest competition brought out several fine designs, one of which was built.

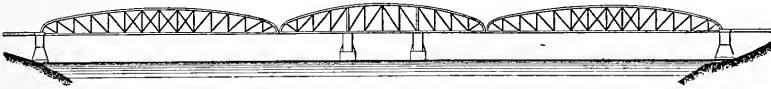

Fig. 52

Cantilevers with many spans are those at Cernavoda (Fig. 53), Poughkeepsie (Fig. 237) and Thebes, all of which are symmetrical, and in contrast to these are the unsymmetrical ones over the Mississippi at Memphis, the Ohio at Marietta, and the East river at New York (Fig. 51), the last being unsymmetrical in respect to length of channel openings.

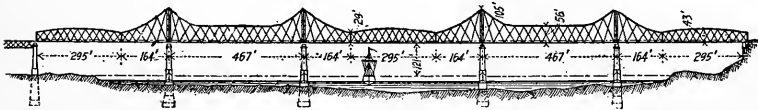

Fig. 53

The presence of a central suspended span has been given as a reason for lack of art in cantilever bridges, and in some of them, as at Blackwell's Island, this element has been omitted.

CHORD OUTLINE

The cantilever, like other large steel bridges, should have a graceful outline if beauty is desired, and curved chords are preferable artistically to straight ones. Curves may be used for either one or both chords, as conditions will allow. The center span bottom chord may be made a segment of a circle

and the bottom chord of the two adjoining anchor spans made to correspond with the middle one, as in the Villefranche bridge (Fig. 54), which is one of the finest of its kind. Somewhat similar cantilevers are at Budapest, Mannheim, and at Highland Park in Pittsburg, though the last lacks the

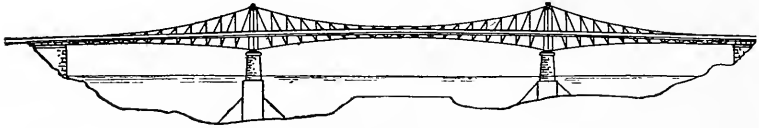

Fig. 54

expensive ornament of the European bridges. The lower chords of the Forth bridge (Fig. 55) are segmental curves of great radius and are quite satisfying, but the end approaches to the bridge have hardly sufficient dignity to harmonize with the rest.

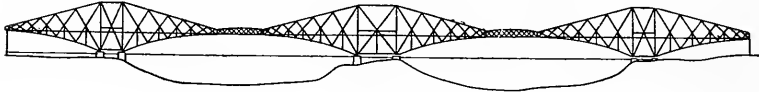

Fig. 55

Chord outlines resembling those of arches and suspensions are best suited to cantilevers which have no suspended span, for if such be introduced, the continuous curves produce a less truss depth at the span center than at the ends—the reverse of requirements. The bridge over the Weser at Hameln (Fig. 56), which replaced an old suspension, was made of the

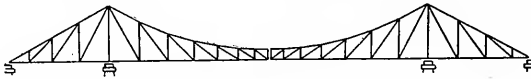

Fig. 56

same outline as its predecessor. but a similar one over the Delaware at Easton has a fifty-foot center span. In both cases the upper chords are continuous curves. The designers of other bridges, like the Hassfurt and Posen cantilevers, have preferred to emphasize the construction by making only a

panel-point connection between the cantilever arm and the adjoining span, a method which is well illustrated by the Tolbiac street bridge in Paris and by a proposed design for the Harlem river bridge at New York. (Fig. 60.) But continuous framing is preferable, and the false connecting members between the adjoining spans add stiffness to the whole.

Chords may also be curved over the piers, as in Mr. Fidler's design for the Quebec bridge (Fig. 50) and the smaller Pines bridge at Croton Lake. While these curved lines add to the general appearance, they necessitate extra framing, and straight lines above the pier are preferable. Cantilever trusses with parallel chords, as on the Dixville and Minneapolis bridges, fail to represent truthfully the stress requirements which need the greatest depth above the piers.

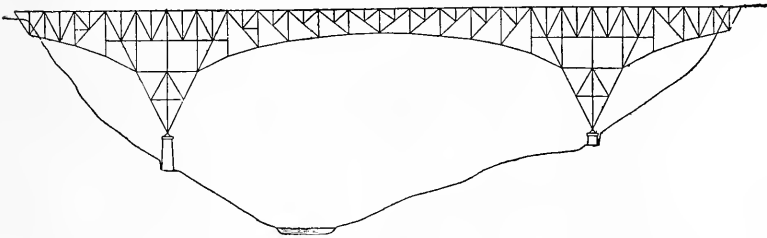

Fig. 57

Satisfactory outlines may be secured by locating the chord points on continuous curves, and using straight members between these points. Several designs for the Quebec were so made, though the one prepared by the Board of Engineers, and the later one by the Dominion Bridge Company, had chords in straight lines. In both of the latter designs the question of æsthetics was apparently not considered. The proposed system of K web bracing in the last design is its first important use in main trusses, though it has previously been used in the lateral system of several bridges in Europe. The approaches in Mr. Fidler's design, with heavy masonry arches contrasting beautifully with another type of construction in the main por-

tion, are much superior to the light trestle approaches on some of the later plans.*

Greater stability is secured by sloping the truss planes towards each other at the top, as in the Forth and Cernavoda bridges, and whenever the cross section is very evident, a mod-

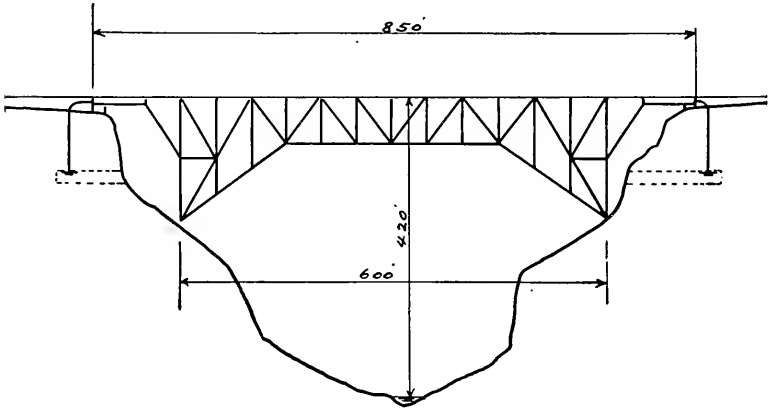

Fig. 58

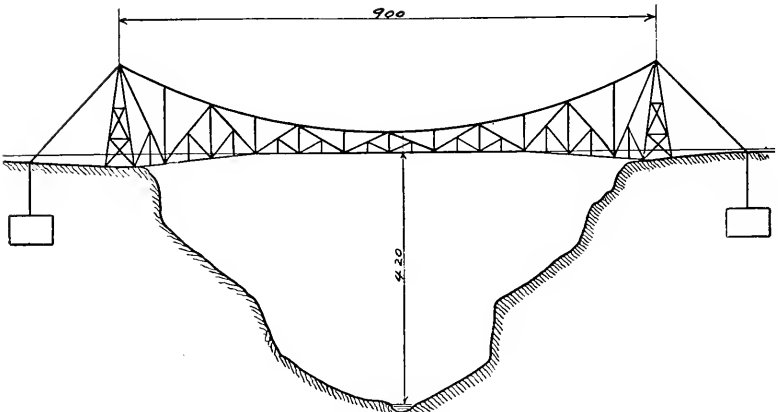

Fig. 59

erate truss inclination, like the entasis of a column, will prevent the appearance of overbalance.

Braced towers beneath the trusses should always taper in both directions, as in the Niagara bridge, rather than stand

* See report of Mr. Gustav Lindenthal, *Engineering News*, Nov. 16, 1911.

vertical, as at Verrugas and Pecos, for if vertical, they have a very awkward appearance.

Cantilevers of the Mingo and Beaver type have become almost standard in America. The lower chord is horizontal for the platform connections and the upper chords curved with the greatest truss depth above the piers where needed.

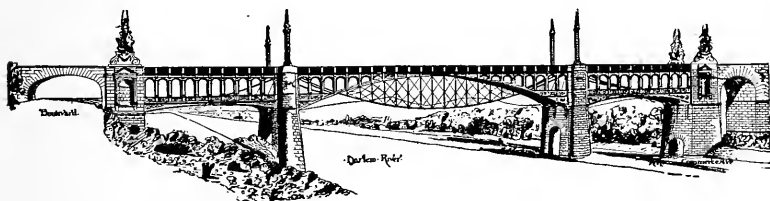

Fig. 60

Figs. 57, 58 and 59 are designs prepared by the writer for bridges over mountain gorges in Western America, one gorge having a depth of 420 feet. Fig. 59 somewhat resembles in principle the Sukkur bridge over the Indus river (Fig. 61) with a span of 820 feet. (For outlines of many other cantilevers, see Tyrrell's "History of Bridge Engineering.")

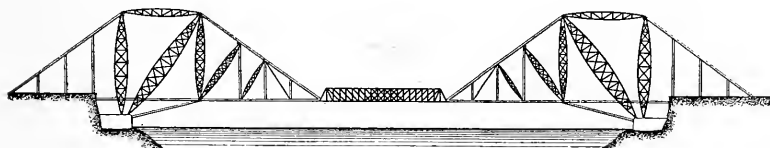

Fig. 61

ORNAMENT

In addition to the usual ornamental features at the balustrade and roadway, the portals and towers offer opportunity for finial decorations, and the Forth bridge has been much criticized because of the absence of these features.

The most artistic cantilevers are those at Budapest, Mannheim, Villefranche, Highland Park and Easton, while others

in which art is utterly absent and extreme disregard shown for pleasing outlines are those at Moline, Ill., Muscatine and Clinton, Ia., Winona, Minn., and Lewiston, Ida. The Alexandria bridge at Ottawa, Canada, and the Beaver bridge

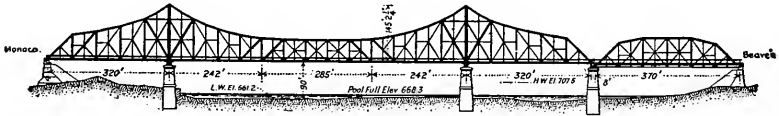

Fig. 62

(Fig. 62) are in the cantilever portion excellent, but their symmetry is injured by the presence of simple truss spans at one end only.

CHAPTER IX

Metal Arches

Metal arches should exhibit a character of their own, and should differ from, rather than resemble masonry arches. They contain three essential parts: (1) the platform, (2) the platform supports or spandrel framing, and (3) the arch ring.

THE DECK

The deck should be arranged symmetrically with space for cars, vehicles and pedestrians. The appearance of bridges which are otherwise attractive has been spoiled by placing car tracks with open timber floor off to one side. Where there are two decks, the lower one is best suited for tracks and the upper one, with unobstructed view, for vehicles and pedestrians, this arrangement being also the most economical. Half through deck construction is suitable for railroad bridges, the side girders forming a safeguard in case of derailment, an idea which was carried out on the Garabit arch. A decided roadway camber is not only useful for drainage, but adds grace to the whole.

SPANDREL FRAMING

Floor supports or spandrel framing of arches are similar to viaduct or trestle bents, and are similarly proportioned, the economic distance between columns depending on the height from arch to floor. But as too many members cause confusion, a few large bents are artistically preferable to a greater number of smaller ones, and several of the largest arches are made in this way, with only three to six bents or towers supporting the roadway girders. Economy is secured when flat arches with small rise have a greater number of spandrel columns, but

arches with great rise should have those supports further apart. If braced piers are used in the spandrels to support the deck, they should preferably taper in four directions, and correspond in outline and detail with similar parts, if any, in the approaches. When the end bents support part of an approach span in addition to a floor panel above the arch, the bent should then be double, or at least appear larger and stronger than the regular ones (Fig. 63). The end bents of spandrel braced

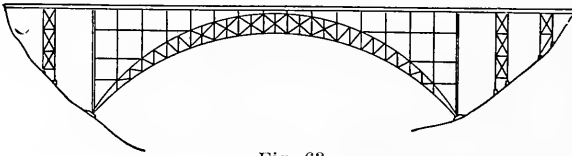

Fig. 63

arches with approach spans should have sufficient prominence to mark the limits of the central opening, and they should be indicated above the roadway by a conspicuous feature. A good effect may be secured by a series of small cast iron spandrel arches just below the floor cornice, an arrangement which appeared on the prize designs for the Washington bridge over the Harlem river at New York. Where the crown depth of a spandrel braced arch is small, web plates may be used for a short distance each side of the center, as in the Cedar avenue bridge at Baltimore. Tapering compression members with greater center than end widths, as in the Viaur viaduct, are not artistic and are rarely economical; parallel ones are preferable. An objection to numerous light spandrel bents is that the slender columns need supporting at one or more intermediate points, but the condition may be remedied by using a smaller number of heavier bents or towers. Many old cast iron arches, as the St. Peters bridge at Paris, had a series of iron circles in the spandrels, but circular forms are not the best for sustaining weight, and the æsthetic effect was not satisfactory. A shield on the center pier of the cast iron arch at Chestnut street, Philadelphia, bears the date of construction.

RELATIVE POSITION OF DECK AND SPRINGS

The relative elevations of roadway and springs give to metal arches their chief character. Individuality is best exhibited when a form is selected which is impossible in masonry, and for this reason through or partly through metal arches are

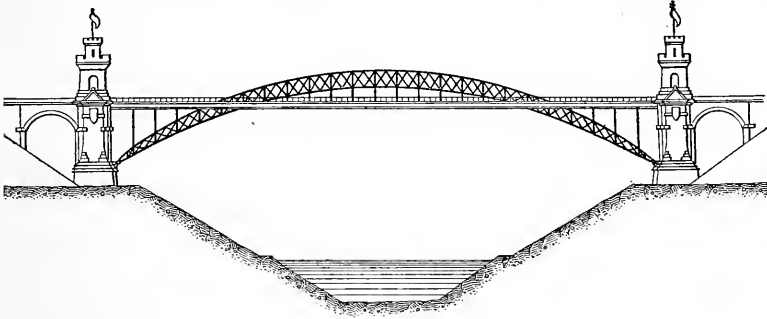

Fig. 64

often preferred, like those at Grüenthal* (Fig. 64) and Straubing, the crescent shape contrasting with stone arches and revealing the special character of steel.

ARCH TYPES

The three common arch types are (1) plate girder ribs, (2) spandrel lattice, and (3) curved lattice ribs. Plate girder arches are illustrated by the Washington bridge at New York, the Forbes street bridge at Pittsburg, and the Constance-Baden bridge in Switzerland. The Harvard bridge at Boston, made to imitate an arch, is really a plate girder curved on the under side. The Manhattan Valley viaduct in New York, with twenty-four semicircular sixty-five-foot arches, is not economical, the form being adopted for its better appearance. Small plate girder arches may be curved on the under side only, with upper side on three or more straight lines, as on the Constance-Baden bridge.

Spandrel braced arches are illustrated by the Niagara railroad bridge (Fig. 65),* and the Lake street bridge at Minne-

*From "History of Bridge Engineering," by H. G. Tyrrell.

apolis, and the Salmon river bridge in British Columbia (Fig. 66). The action or purpose of this type is not so evident as with curved girder or lattice ribs and, sincerity or truthful expression being an essential of good design, spandrel braced

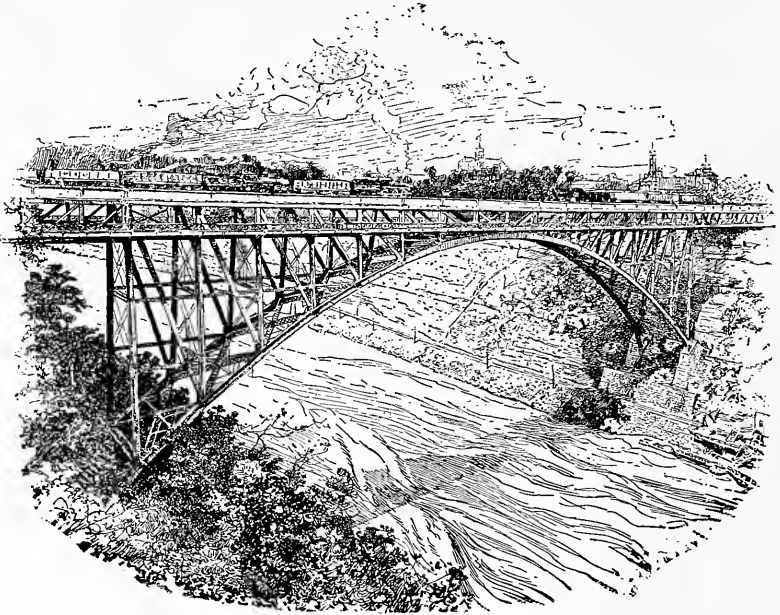

Fig. 65

arches are not so desirable as other forms. Care should be taken to secure effective angles of inclination for the web members. The truss depth and panel length at the center



Fig. 66

should be such that diagonals will not have too flat an angle, and those near the ends may cross two panels with sub-trussing at the middle (Fig. 67), as in the Minneapolis bridge, which is preferable in this respect to the one at Niagara.

Lattice rib arches are either deck or through, the latter type being used chiefly in Europe, and none of these forms are suitable for spans much less than 300 feet. The Coblenz bridge of 1864 (Fig. 225), which was the first important wrought-iron arch, was a deck bridge, as also are the two metal arch designs (Figs. 217-218) for the proposed Hudson memorial bridge at New York, which are among the finest

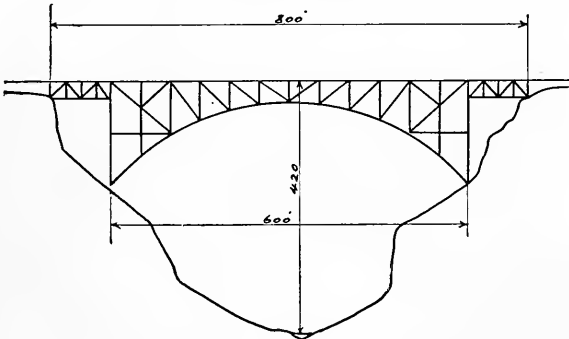

Fig. 67

designs of the kind ever produced. Through arches are illustrated by those at Bonn (Fig. 68), over the Rhine, and at Magdeburg, over the Elbe. The Bonn bridge has true arches with inclined pier thrusts, but those at Magdeburg, Mainz and Worms, though of similar outline, have tension members beneath the floor to resist the arch thrust, and the pier reactions are vertical. They are known as "braced tied arches." The Mainz bridge (Fig. 230) is somewhat injured by the presence of hand railing on the upper chords, which detracts from its dignity. The Worms bridge (Fig. 227) has magnificent stone portal towers adorned with figures of lions and clocks over the roadway—a very appropriate feature. Through arches have an artistic outline, and as the trussing adjoins the upper chord, and the web contains vertical hangers only, there is little framing to obstruct the river view. The appearance is further improved in some bridges, as at Bonn, by bending the chord sections to a uniform curve, though the expedient necessitates an increase in chord section of about twenty per cent. Curved

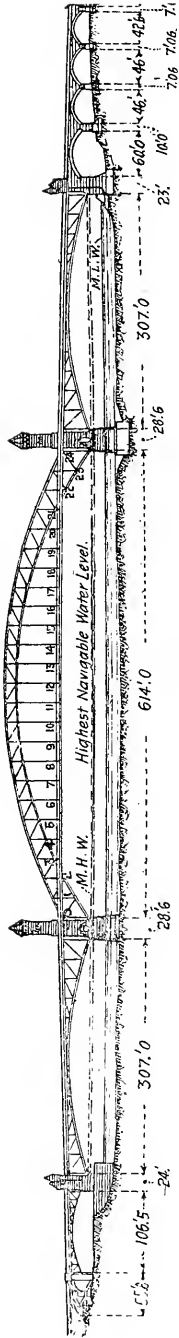

Fig. 68

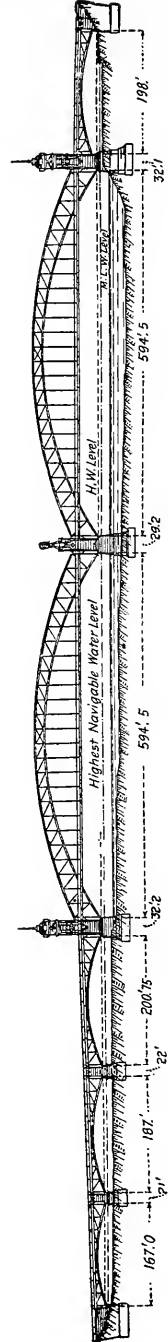

Fig. 69

arch ribs are well suited for ornamental foot bridges over canals or railroad tracks, and have also been used in spans of great length, such as the Eads bridge at St. Louis and the proposed ones over the St. Lawrence river at Montreal and the North river at New York, with spans of 1,000 to 3,000 feet. Mr. Charles Steiner's design for one at Montreal with a central span of 1,250 feet, is shown in Fig. 71. The span arrange-

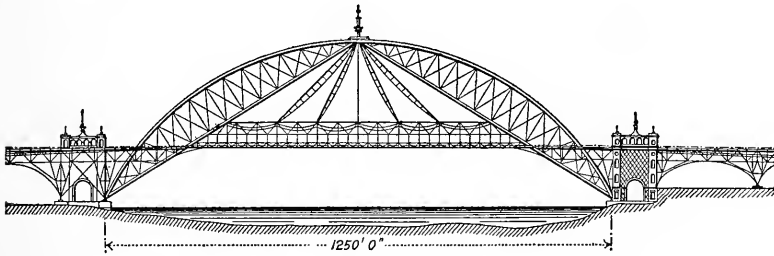

Fig. 71

ment on the Dusseldorf bridge (Fig. 69) over the Rhine, is hardly as satisfactory as that at Bonn (Fig. 68), for the latter has a large central arch with a smaller one at each side, making the bridge nearly symmetrical.

PINS OR HINGES

The form of arch depends chiefly on the bearings, which may have either three, two or no hinges. The three-hinged arch, with joints at the ends and center, must be stiff between these points, but may taper to a small depth at the bearings. An excellent and expressive example of the three-hinged bridge is the recent one at Yunnan, China, which is simply a triangular frame supporting the deck at the center and the two quarter points. The Alexander III. bridge at Paris is probably the most beautiful example of a three-hinged arch (Fig. 72), though its small rise causes it to lack the appearance of strength, which is so essential to good design.

Two-hinged arches are illustrated by the Pia Maria at Oporto, and the Garabit (Fig. 73), Grüenthal, Bonn and

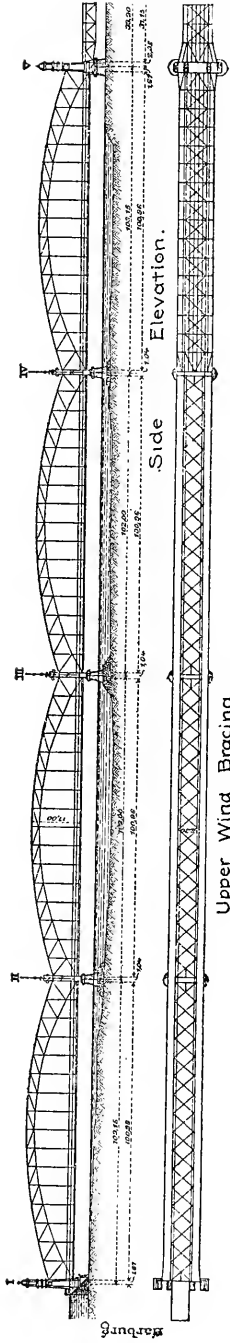

Upper Wind Bracing
Fig. 70

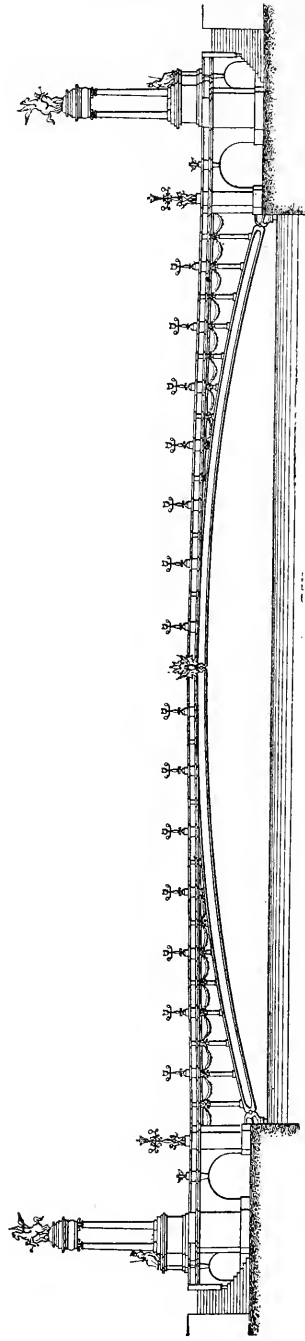

Fig. 72

Niagara-Clifton (Fig. 80) arches. These are stiffer and have a finer appearance than those with three hinges. The lattice ribs may either have parallel chords, as at Niagara-Clifton, or may taper from the required center depth to the end pins, as in Garabit and Grünenthal, though any of these forms truthfully show the stress conditions.

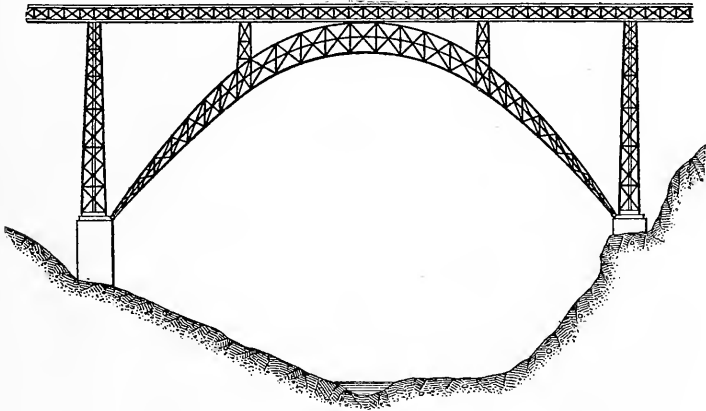

Fig. 73

Bridges with no hinges have the best appearance and require the least material, but there is often difficulty in realizing the assumed bearings. They have frequently been erected at first on end hinges, as at Coblenz (Fig. 225), and after

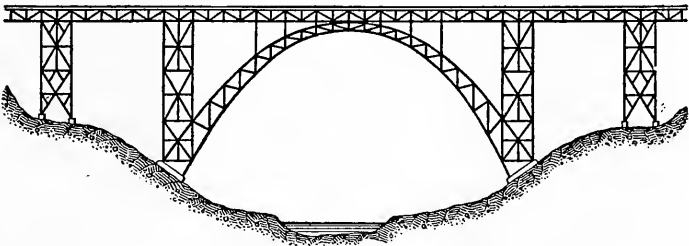

Fig. 74

completion the ends wedged up solid against their bearings. Square-ended arches should increase in depth from the center to the springs similar to masonry arches, as in the Luiz I arch at Oporto and the Mungsten bridge (Fig. 74).

ARCH FORMS

In comparing spandrel braced arches with plate and lattice ribs, the last are by far the best appearing, especially for long spans. Circular segments, parabolas or hyperbolas have all been used, and any of them are suitable for arches of small rise, though for a condition approaching uniform loading, the parabola is nearest to the line of pressure. Circular segments are more easily drawn and they never fail to satisfy the eye. Parabolic arches of large span and rise, like the Garabit and Mungsten bridges (Figs. 73-74), though structurally correct

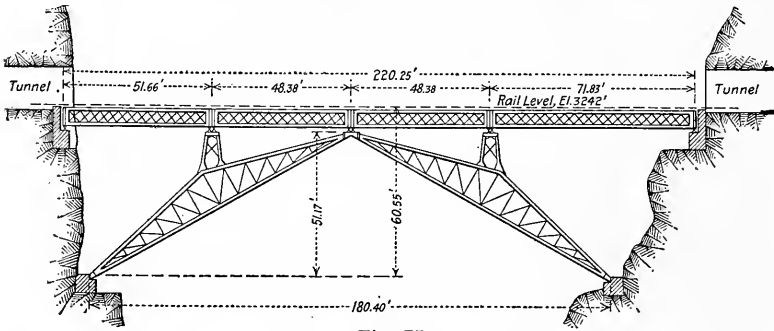

Fig. 75

are not artistic. Hyperbolic arches, as in the Menominee bridge, have nothing to recommend them, and a straight triangular form is preferable. The triangular arch is indeed often a more truthful representation of the constructive principles involved, and for this reason they are a delight. Mystery and deception, so often carried out in construction, should be eradicated. Simple forms are preferable to complex, especially when they are more sincere. The beauty of the Yunnan arch (Fig. 75) lies in its simplicity—its purpose is so evident—and the same is true of the new Thermopylæ arch (Fig. 76) in Greece. Even the triangular railroad arch over an Alaskan gorge, wholly of straight lines, is preferable in some respects to others in which the action is obscured or concealed. Arches made with double lenticular trusses meeting at the crown hinge, like the 500-foot spans proposed by Mr. Eads for the St. Louis bridge, are not artistic, though perhaps economical.

Curved ribs with parallel chords have a better appearance than any other form. Alternate web members of the lattice ribs should be vertical for convenience of connections, though they are otherwise arranged in the Eads bridge, and two proposed designs for the Harlem river, the latter having web posts normal to the chords. Lattice ribs with the lower chord curved, and the upper one in three straight lines, as in the Brooklyn-

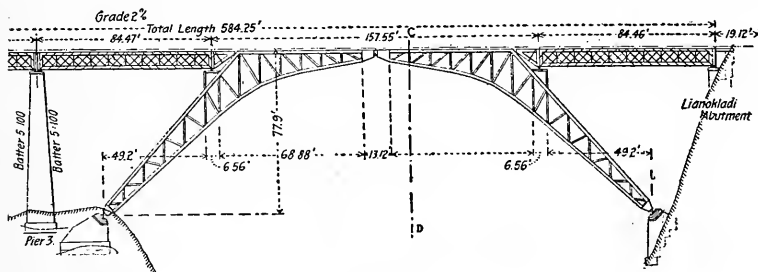

Fig. 76

Brighton viaduct, are not so attractive as parallel curves, though the cost of bending is partly avoided. Some designers have even curved the sections between the panel points at an increased cost, in order to make a perfect outline. The same kind of web should be maintained throughout, rather than a combination of plate and open lattice, as in the Riverside arch

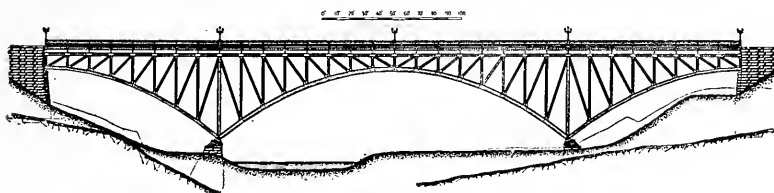

Fig. 77

at Cleveland. Plates are necessary and permissible at the ends, but should appear as minor features and not extend out to the quarter points.

Unsymmetrical arches are correct and acceptable when used for approach spans where the rising hillside necessitates a higher spring at the abutments than at the intermediate piers in the valley. But the semi-arch of the unsymmetrical span

should be of the same form as the adjoining valley arch, as in the St. Sylvestre bridge, Switzerland. A violation of this requirement is found in the Rio Grande cantilever arch in Costa Rica, where no harmony is seen between the approach and center outline. The finest cantilever arch ever executed is the Vieur viaduct in France, though a similar one (Fig. 77) was proposed the same year to carry Massachusetts avenue over Rock Creek at Washington. A very beautiful small one crosses the Eibe-Trave canal at Molln, and another (Fig. 78) may be seen in Lincoln Park, Chicago.

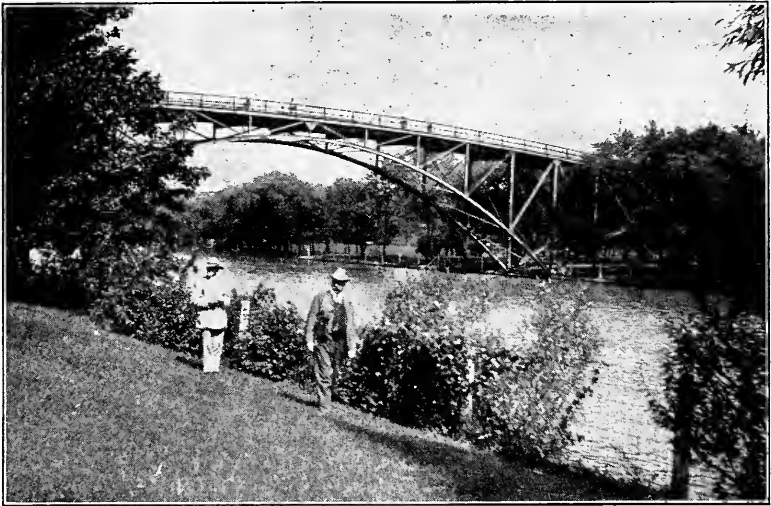

Fig. 78

Springs should be at different elevations when the deck is on a very noticeable grade, the difference in their height corresponding with the floor grade, as in the Kornhaus bridge (Fig. 231). A difficult mountain site may naturally place the springs at different elevations, as in the Surprise Creek bridge, though wherever possible lack of symmetry should be avoided. Further study of the site might show that a small change of outline, span length or position would result in level springs and equal end heights.

Arches should have sufficient rise to display their strength, as in the Stony Creek bridge (Fig. 79), which crosses the gorge in a single span. When too flat, the arch appears like a lattice girder, and its true action is not sufficiently evident. A large relative rise is, in fact, one of the chief beauties of the arch, and many which are otherwise imposing, fail by insufficient rise, to display their strength and security. When an arch contains

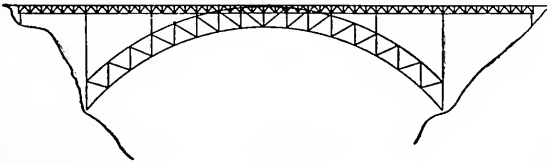

Fig. 79

only two ribs, strength is shown by placing them in sloping planes further apart at the shoes than at the platform. The roadway trusses above the arch may stand vertical, as in the Paderno bridge, which has double decks.

PIERS OR TOWERS

Masonry towers between adjoining spans should continue up to or above the roadway for the best effect. In this respect the Washington bridge is superior to either the Main street bridge at Minneapolis or the Kirchenfeld bridge, which have metal towers. The piers of the Hell Gate arch (Frontispiece) were to be of red granite concrete on gray granite base. Metal piers when used in spandrels or approaches should have a slight taper in two directions, like the trunks of trees, rather than standing vertical, but the taper must be small or the appearance will not be improved. The general style of bracing on all the piers should be uniform instead of changing, as in the Mungsten bridge. Piers which resist the thrust of approach arches, as in the Kornhaus and the old Coalbrookdale bridges, must be proportioned for their stresses, and should appear to have sufficient strength. When insufficient construction funds

are available at first, stone piers may be erected complete and temporary timber arches placed between them, to be replaced with steel or masonry when the timber has served its temporary purpose.

APPROACHES

Symmetry is the principal requisite for artistic approaches. When the sides of a valley rise at different inclinations, an approach should first be designed for the shorter end, and the nearest possible reproduction made of it on the other or longer end. The remaining part of the longer approach should then be carried out in a different type of construction, divided from the symmetrical part by some prominent feature. This expedient separates the central part from the rest, and shows that natural disadvantages have been overcome. Open arch approaches are more artistic than heavy retaining walls with solid filling which have a massive appearance, but abutments should correspond with the main bridge, and heavy plate arches, as in the Manhattan Valley viaduct, need heavy abutments.

Large metal arches with masonry approaches should have towers or other forms above the deck dividing one kind of construction from the other. The finest single arch designs are those (Figs. 217-218) for the proposed Hudson Memorial bridge, and if any criticism of them were possible, it is that since a steel arch was imperative for the center span, metal might have been more appropriate for the approaches. One of these designs showed curved extensions in the end retaining walls, forming retreats which were covered with shelters and provided with seats, a most appropriate utility on a large bridge. The position of these shelters was further indicated by four columns at each end. The beauty of the world's greatest arch (Fig. 80) has unfortunately been marred by the entrance spans, which have no conformity with the central one. The form is said to have resulted from a desire to leave the view of Niagara Falls unobstructed. A wide plaza at the terminus, as on the Riverside viaduct, New York, might be partly

occupied by a monument or statue, and shafts or columns might bear inscription plates as on the Garibaldi bridge at Rome, which give the dates of Garibaldi's victories.

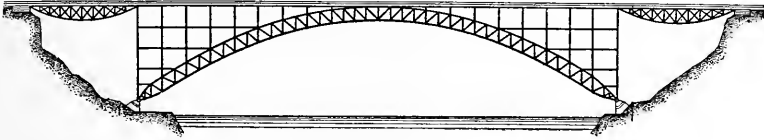

Fig. 80

ORNAMENT

The principal and almost the only ornament ordinarily applied to metal arches is a fascia of cast iron. Elegance may be displayed in pylons, columns, statuary and lamp clusters as on the Alexander III (Figs. 72-226), or the entrance bridge at the Pan-American Exposition. The proper place for features on the deck is above the piers rather than at the span center, though the latter position may be appropriate to mark the middle of a long bridge or series of spans. Triumphal roadway arches were extensively used on old Roman bridges, and new decorative forms have been devised on some recent designs like the proposed memorial bridge at Washington.

HELL GATE ARCH

The proposed Hell Gate arch of 1,000 ft. is one of the largest ever projected. It is part of a prospective viaduct three miles in length, connecting the Pennsylvania railroad with the New York, New Haven & Hartford railroad, from the mainland to Ward's Island. Provision was made on the plans for four tracks on a stone ballast deck 140 ft. above the water, while the arch crown would rise to a height of 300 ft. The towers are shown in red granite concrete on grey granite bases, and the total estimated weight of steel in the whole viaduct is 80,000 tons. The design is the work of Gustav Lindenthal, engineer, and Palmer and Hornbostel, architects. (See Frontispiece.)

CHAPTER X

Suspension Bridges

The suspension is one of the easiest types to beautify, and it can hardly fail to be attractive unless through deliberate purpose or utter negligence, for the cables naturally assume a perfect curve. The floor is often given an upward rise or roadway camber, which is evident by day and outlined by lights along the deck at night. From the very nature of the types, the best and most truthful appearance is obtained when the floor is hung below the cables of suspension bridges, and mounted on walls or columns above an arch.

Suspension bridges are among the very oldest forms, but previous to 1796 the cables were drawn taut and the floor laid directly thereon. It was not till after the introduction of level platforms suspended from the cables that they came greatly into favor, and then for half a century many of the finest bridges were suspensions. They are suitable only when the imposed loads are so small in comparison with the weight of the bridge that the live load will cause no change in the curvature of the cable. Suspension bridges are serviceable in small spans for pedestrian travel, or other light loads, and are economical for extremely heavy bridges such as those at New York, where the weight of several trains is small in proportion to the weight of the bridge itself. They contain less metal than truss bridges but frequently cost more. The great suspensions at New York, costing twenty to thirty millions each, are the most prominent objects about the city, and have never been equalled in carrying capacity, though designs have been made for much longer spans, including one by the eminent engineer, M. Oudry, with four spans of 1,000 meters each to cross Messina straits.

TYPES

Suspension bridges are of the Roebling, Ordish, Dredge or Gliscard type, the first being the common and almost only kind in America. The floor in the Ordish bridge (Fig. 81) is supported by straight tension members from the panel points of the roadway to the tower tops, the tension bars being sup-



Fig. 81

ported by a curved cable above them, the only purpose of which is to carry the working members. The type is illustrated by the Albert bridge at London, and two bridges over the Moldau at Prague. In the Dredge type (Fig. 82) cables from the towers support the whole weight, but the suspenders from the cables incline from the floor towards the towers, instead of

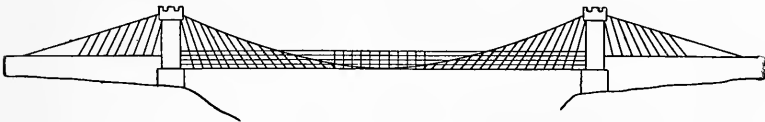

Fig. 82

hanging vertical. A bridge of this description was erected over the Spey. The Gliscard bridge has numerous tension members radiating from the towers, and the type is extensively used in France, and many designed by French engineers have been exported to other countries.

Schwedler's design for a bridge over the Rhine at Cologne (1850) may be called a type, for it contained two side suspension spans and a pair of very handsome center towers, with a double bascule span between them. A similar design was adopted for the Tower bridge at London, though with very different architectural treatment. In these designs the tension on the towers from the cables of the side spans is resisted by members between the towers above the channel. In the Tower bridge (Fig. 83) these ties are concealed by two

high level foot walks reached by elevators, but the foot walks and concealed tension bars fail to exhibit their real purpose, and in this respect the design is faulty. The architectural



Fig. 83

treatment of the towers has been severely criticized by English architects, who declare that the stone facing, which is nothing more than an enclosure for the metal which sustains the

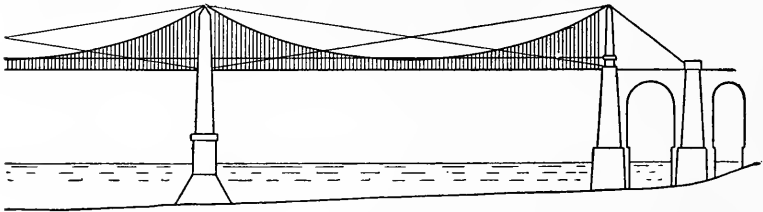

Fig. 84

loads, is a false representation and made to appear like a structural part of the bridge. The horizontal belt courses on the towers also produce a diminutive effect, and the central ones should have been omitted.

The towers of the Cubzac bridge (Fig. 84) over the Dordogne (1839), with five spans, were braced together with diagonal ties above the cables, but the presence of the ties greatly injured its appearance.

NUMBER OF SPANS

The æsthetic appearance of bridges is greatly influenced by the number of spans. Suspension bridges generally have two towers, but they have been erected with only a single one, as at Gotha and Prague, or with many towers, like the old Smithfield street bridge at Pittsburg. The Seventh street at Pittsburg, the Lehigh river bridge at Easton* and the Lambeth bridge at London each had three towers, while the Newburyport bridge had four and the Nicholas bridge over the Dnieper had five.

TOWERS

When the foundation is in water the piers are usually separate from the towers, though when both are masonry, the latter are merely an extension of the piers. The purpose of each is, however, quite different, and they should receive different and individual treatment. Piers when in water should have pointed ends up to or above high water level, and in rapid northern rivers they may require ice breakers. They must be structurally sufficient to sustain the loads and any elements are appropriate which emphasize strength, such as deep stone courses, projecting footings, and rough stone face. Cut waters on both ends are a necessity in tidal channels with alternate currents in both directions, and in any case they prevent scour and make the pier more graceful and symmetrical, as is well illustrated in the old suspension bridge at Budapest (Fig. 234). When not in water the piers may be rectangular masonry pillars either separate or connected beneath the roadway by arches, as in the Jefferson Street bridge at St. Louis. If cylinder

* H. G. Tyrrell, in *The Engineer*, London, Sept. 20, 1901. *Scientific American* Supplement, Sept. 28, 1901. *Engineering News*, Nov. 22, 1900.

piers are adopted, the appearance should and can easily be made more pleasing than in the Lambeth suspension at London.

Bridges have occasionally been made with only one central tower, as in the foot-bridge at Prague which supported two adjoining spans of 158 feet, but two or more are the usual custom. They must first fulfill their structural requirements, which is to form a support for the cables, without obstructing

the road and walks, but when this is accomplished the next requisite is adornment. Towers are so prominent from any point of view that plain construction without beauty is inexcusable, for the additional cost of such work is small in comparison with the whole outlay. The difference in effect is easily seen by comparing the beautiful ones of the Budapest, Fribourg, Chelsea, St. Louis or Tower (Fig. 83) bridges, with the simple structural towers of the Brooklyn (Fig. 235), Williamsburg (Fig. 85) or Lambeth bridges. It may be noted that the beautiful Buda-

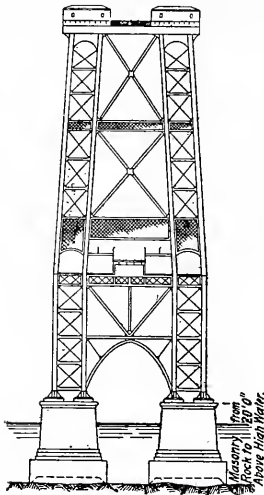

Elevation of Tower.
Fig. 85

pest bridge in Austria (Fig. 234) is the work of the eminent Irish engineer W. Tierney Clark, who after completing it placed at each end a pair of British lions.

Towers have been made of stone, cast iron, steel and wood, all the early ones being of the first two materials. Cast iron has the merit of lending itself readily to ornamental treatment, and many of the early bridges, as those at Seraing, Chelsea and several in Pittsburg, including Roebling's eight-span bridge at Smithfield street (1845) were thus constructed. When treated with true individuality, cast-iron towers were often artistically satisfactory, but the iron should not be made to represent stone or any other material than itself, as was done in the piers of the ill-fated Tay bridge.

The beauty of masonry towers depends on general outline

and proportion, and also on detail, two fine examples being those in the old Hammersmith bridge at London and the Budapest bridge of 1845. Other excellent stone ones are in the Lorient bridge of 1847 and the Nicholas suspension over the Dnieper. Towers should appear to support their cables with easy grace. Statuary, frieze courses, or smaller features,

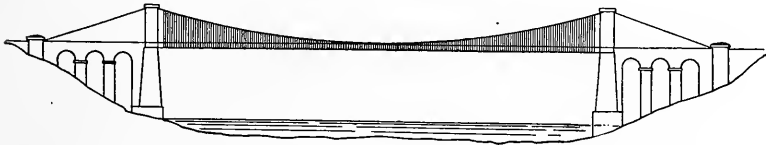

Fig. 86

such as fountains, are appropriate. As they occupy the usual sidewalk space, the footways may be curved out around them and supported by structural members from the piers. When the piers or towers support land arches in addition to the cables, as on the Menai and Roche Bernard bridges (Fig. 86) they must be heavy enough to resist the combined stresses. The Menai piers, though hollow, are very heavy and substantial, corresponding with the other work of Mr. Telford.

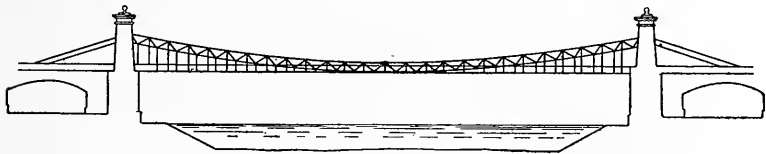

Fig. 87

The towers of many suspension bridges in America, such as those at Montmorency Falls, Charleston and Elizabethtown, consist of single disconnected tapering masonry shafts, with appropriate caps and bases. In rustic surroundings or parks, different treatment may occasionally be appropriate, as in the recreation park in Paris, where the towers of a suspension bridge are of natural rock with a roadway cut between them. The supports for a suspension bridge at Oak Park, Ill., consisted of natural growing trees on each side of the river.

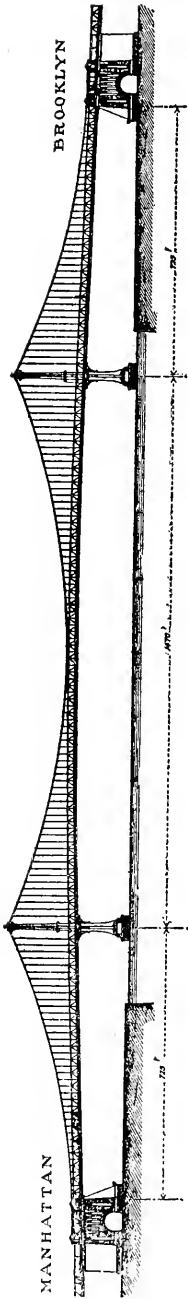

Fig. 88

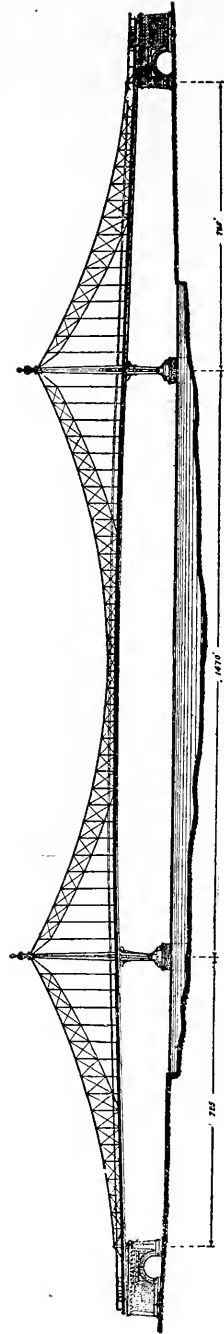

Fig. 80

Steel towers are the newest form, and are well illustrated by the two latest suspensions over the East River, and in the proposed one over the North River at New York. They permit of rocker action at the base, as in the Manhattan and new Budapest bridges, both of which exhibit the highest degree of merit yet attained. The towers for the proposed North River bridge (Fig. 91) were to be octagonal, 625 feet high, tapering out at the bottom like the trunks of great trees. The designs for the Budapest, Manhattan (Fig. 88) and North River bridges are the combined work of engineers and architects, and their beauty contrasts strongly with some other utilitarian structures.

Wooden cable supports are occasionally used for light or temporary bridges, and when well enclosed and protected from the weather may last for half a century. The supporting members are heavy timber, which are enclosed with sheathing on wooden purlins. They may be battened or shingled like the old Newburyport towers, and painted in one or more colors.

CABLES

Cables are now made either of high tension wire or eye bars, the first, with the greatest working strength, being the lighter but requiring the longer time to erect. Steel eye bars are more quickly erected, but with a lower tensile strength are proportionately heavier. The cables of early suspension bridges were made of chain links, flat iron plates, or links fastened together with bolts; but these forms are no longer considered. No æsthetic treatment can be given to the cables themselves, for they are purely structural members, but much can be exhibited in the method of loading and stiffening them. Loaded cables in the end spans, as in the Brooklyn bridge, with end curves corresponding to the center span, are more beautiful than straight ones, as on the Williamsburg bridge, though the latter may have structural preference. When the end cables are unloaded, the platform may be supported on metal framing and piers, as at Williamsburg, or on a series of stone arches,

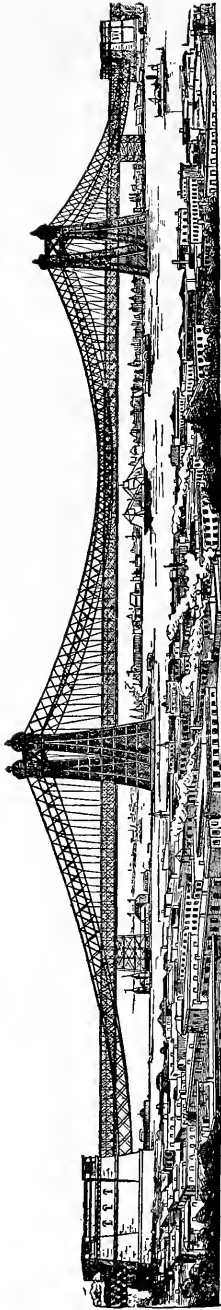

Fig. 90

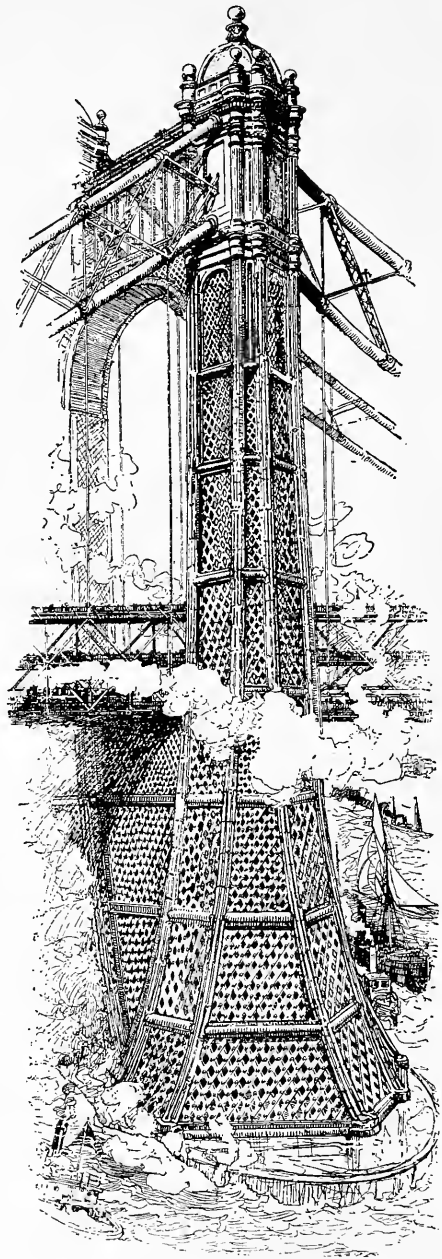

Fig. 91

as in the Roche Bernard bridge, but a combination of arches and loaded end cables, as in the Menai bridge, is useless, for either one without the other would sustain the platform. When terminal arches are used, the same number of openings should appear at each end, instead of the unsymmetrical arrangement of the Menai bridge.

METHODS OF STIFFENING CABLES

Flexible suspension bridges are stiffened with trussing, either adjoining the cable or parallel with the roadway. The former method with stiffened cables is illustrated by the two Danube Canal bridges at Vienna (Fig. 87), the Jefferson Avenue bridge at St. Louis, the Seventh Street and Point bridges at Pittsburg, the Tower bridge at London (Fig. 83), and Mr. Lindenthal's designs for the Manhattan (Fig. 89), Quebec and North River (Fig. 90) bridges, but horizontal trusses are used on the East River suspension bridges as they were finally built.

Braced cables involve the use of eye bars with a lower tensile strength than wire, and this has been a hindrance to a more general adoption of the method. That the result is satisfactory and correct cannot be doubted, after an examination of some good example like that at St. Louis. Crescent-shaped cable bracing, as on the old Point bridge at Pittsburg or the Tower bridge, London (Fig. 83), is not as beautiful as parallel chords, and wherever possible, preference should be given to the latter and more pleasing form. Comparative estimates for a suspension at Cologne with a 720-foot center span showed that while stiffened eye bars had a greater weight than wire, the cost of the designs was about the same, and the eye bars could be erected in much less time. But whether the stiffening trusses adjoin the road or cables, provision for expansion must be made at the center, for large suspension bridges like those at New York have a daily center rise and fall of several feet, due to change of temperature. For this reason stiffening trusses

for long spans are frequently half the length between the towers, meeting at a center pin.

RIGID SUSPENSIONS

Rigid suspensions with stiff bracing between the cable and a horizontal chord at the floor level are suitable when the live load is small enough in comparison to the dead load, that compression will never occur in the vertical suspenders. The type is not as sincere as other forms, for it is easily confused with cantilevers, and is therefore not as desirable. But when a stiffened suspension is used, care should be taken to adopt a correct outline and avoid the disturbing effect illustrated in the Loschwitz stiffened suspension bridge, the upper curve of which is a hyperbola. More satisfactory ones are those at Frankfort over the Main and Easton over the Delaware.

ANCHORAGES

The anchorage is purely a structural part, hidden from view below the ground, and æsthetic treatment is possible only on such erections as are carried above the roadway. The creation of massive monuments above the anchorage is appropriate to show where they are buried, and to add extra weight where it is useful. The importance of the bridge need be the only limit to the amount of art displayed. Very fine anchorages are shown on the Elizabeth bridge at Budapest, and elaborate studies were made for one of the large bridges at New York. Lateral guy ropes or anchor cables which are frequently used on light bridges detract greatly from their appearance, as they betray weakness in the structure itself.

CHAPTER XI

Masonry Bridges

Masonry bridges are more easily made attractive than any other type, for the arch outline is beautiful, and abundant precedent is available. Engineers and architects are both accustomed to the form and very little special study is needed, but architects generally prefer masonry bridges to steel, as the æsthetic treatment of them corresponds more nearly with the design of buildings. The bridges which are most difficult to ornament are those which contain large steel spans between masonry approaches. The two kinds of material and types of construction must be treated according to different standards of art, and æsthetic and economic principles are involved in different proportions. Until near the end of the eighteenth century bridges were made exclusively of wood and stone. The introduction of iron and steel in the nineteenth century, and the production of these materials at low cost, caused metal construction to supersede masonry, but in the twentieth century the combination of the two materials in reinforced concrete and the economic production of cement indicates a rapid return to the more permanent and substantial masonry type. The lasting quality of steel bridges was at first greatly over rated, and those with solid floor which are only semi-permanent often cost more than masonry. The desired degree of permanence should therefore receive full consideration before selecting between steel and masonry. The beautiful bridges at the great expositions of the last half century were splendid illustrations of designs which might be reproduced.

ARRANGEMENT AND LENGTH OF SPANS

More than ninety per cent of all masonry bridges have spans less than 150 feet, and the greatest one ever attempted—

recently completed at Rome—has a length of only 328 feet. Masonry spans are therefore always short in comparison with steel, and the long ones of the future will doubtless continue to be of metal.

The length of span is usually determined by local conditions, short ones being best suited for shallow water with little current, while longer ones are more appropriate over deep and rapid rivers or busy navigable channels. Bridges of many spans appear best when the center one is longer than the others, and adjoining ones decrease in length towards the ends. Trajan's six-span bridge at Alcantara (A. D. 105) was of this form, for the two center openings were the longest, and at each side were smaller ones. The arches were semi-circular, with crowns at the same elevation and springs rising towards the abutments.

Unsymmetrical curves are suitable and permissible for approach spans over sloping hillsides, as in three-span bridges over railroad cuttings where the abutment springs, to be above the ground, must usually be higher than those over the two central piers. But when the shore spans are shorter than the adjoining ones, and springs are retained at a uniform level, the crowns may all be kept at the same level and a greater angle of curvature used in the side spans. Or, if the same angle is retained in all, the crown of the side spans will be lower than the others and the roadway over them may be graded, as in Ponte Rotto (Fig. 5)* and other old Roman bridges. Too much roadway grade is, however, neither attractive nor convenient, and some which were steeply graded, like Pont-y-Prydd and the Claix bridge in France, have now more convenient bridges built beside them, with level roadway.

Much economy results from using separated twin arch rings, as at Luxemburg, and Walnut Lane (Fig. 196), Philadelphia, which are possible in stone, and still greater economy in reinforced concrete by eliminating all useless material and

*From *Concrete Bridges and Culverts*. By H. G. Tyrrell.

retaining only structural members, as in a steel arch. When carefully treated with graceful curves, the ribbed arch with its lighter appearance may be made more artistic than the more solid ones with spandrel filling. Excellent examples are those at Sandy Hill, N. Y., over the Hudson, which is faced with concrete blocks, and a proposed design (Fig. 92) for the

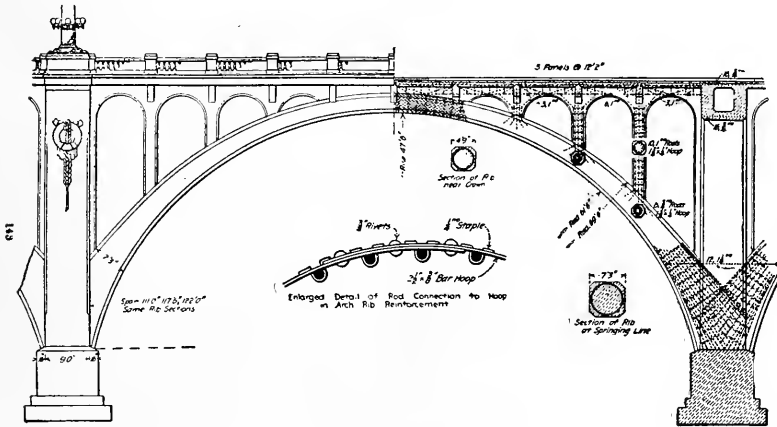

Fig. 92

Grand Avenue viaduct at Milwaukee. A less fortunate concrete cantilever arch crosses the Vermilion river at Wakeman, O., which, though original constructively, is lacking in æsthetic treatment.

THE DECK

Masonry bridges, like all others, should have their decks symmetrically and carefully arranged, with enough space for traffic. Provision must be made for pipes and wires in covered and accessible chambers beneath the roadway, and the mistake in the London bridge avoided where these utilities are placed on the main cornice outside the railing, greatly marring its elegance.

Change of roadway grade should follow a uniform vertical curve rather than straight planes, and in the absence of a cornice the roadway should be indicated on the face by a belt course.

SPANDRELS

Spandrels are of two kinds, solid and open. Solid spandrels, with face walls either to retain earth filling or as a curtain, may be treated in several ways which are different for stone and concrete. Monolithic concrete should be moulded in continuous curves and cornices, as on the Grosvenor bridge (Fig. 93), England, while stone or other block structures should have the lines or joints accentuated. The Grosvenor

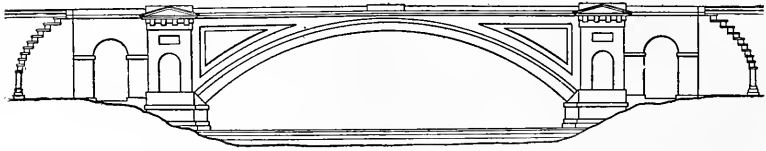

Fig. 93

and Schenley Park bridges have sunken triangular spandrel panels, which are more suitable for small bridges than large ones. The great 295-foot arch at Plauen (Fig. 18) has circular recesses in the spandrel walls similar to Pont-y-Prydd, the effect of which is good, and others like the London and Waterloo bridges have no other marking than the horizontal chisel drafts on the stone courses. An elegant effect is shown on a small bridge in Golden Gate Park, San Francisco, and still better treatment is displayed in the carvings of the spandrel panels on Ponte Rotto and the Rialto (Fig. 187), the last containing figures of angels.

Large plain surfaces should be broken up with belt courses, pilasters or other markings, for without them small irregularities in plumb and level lines are more evident. But panels on

large bridges must not be too small or fine, for they then produce a diminutive effect. False arches on the face wall with pilasters between them relieve otherwise flat surfaces, but such arches lack sincerity. Hollow spandrels should show hollow on the face and should not be concealed by curtain walls. This type offers much opportunity for artistic treatment, and may be made either with arcades or colonnades. Transverse arcades are suitable only for comparatively narrow bridges, for a slightly oblique view on wider ones obstructs the sight through the arcade and injures the contrast (Fig. 94). A

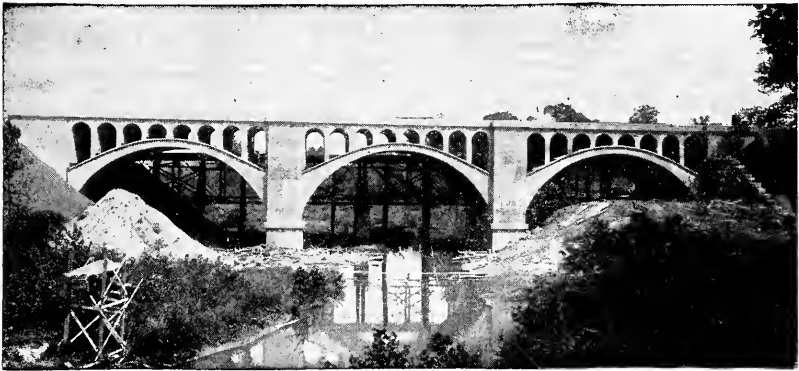

Fig. 94

really elegant effect in open spandrels is secured with a central arch above the pier and an adjoining one in each span, as in the Tarn River bridge at Albi,* the idea being borrowed from the Romans. The spans of transverse spandrel arches supporting the roadway should increase towards the abutments with their greater height, as in the Salcano bridge in Austria. When these minor arches are of uniform width, the arrangement usually appears inconsistent.

An excellent and very economical design for a concrete arch of 150-foot span, is illustrated in Fig. 95. In some respects

* American Architect, Oct. 19, 1901.

the curtain walls cause the design to be insincere; the walls, however, serve the useful purpose of enclosing the metal spandrel framing from the weather and at the same time allow the interior hollow portion to remain in a rougher or less finished condition, thus saving expense. The thickness of arch ring is

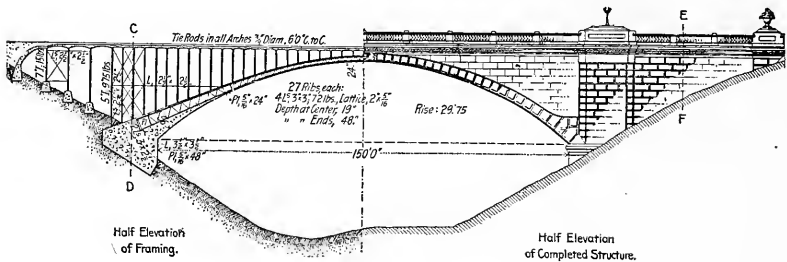

Fig. 95

shown on the face, and at each side of the opening are heavy pilasters. The foundations also are worthy of note. The Topeka bridge (Fig. 96), by the same engineer, is quite different from the last, for it has flatter arches with solid earth filling in the spandrels.

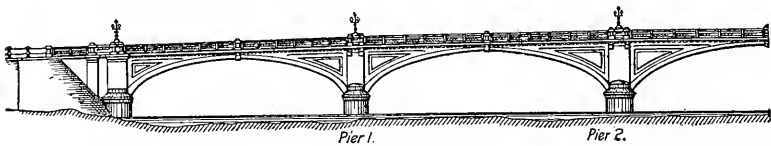

Fig. 96

ARCH RINGS

Arch rings should be truly represented on the face with thickness increasing towards the springs, and when surmounted by solid spandrels the rings should be indicated and emphasized by a projecting stone course. Moulded outlines only are suitable in concrete, and in this material keystones or other

imitative features are inappropriate and untrue. The practice which is common in buildings, of making arch rings deeper at the center than at the springs, should be avoided in bridges, as it is an untruthful representation and gives the effect of overbalance. It frequently results from making voussoir joints match the horizontal spandrel courses, the upper side of the arch stones being cut with vertical and horizontal faces, that the horizontal thrust of the backing may be effective.

SHAPE AND PROPORTION

The appearance of masonry bridges depends chiefly on the arch curve, and a form should be selected which is the most pleasing consistent with construction. The common forms are (1) the semicircle, (2) the ellipse, and (3) the circular segment. The first is preferable for long series of arches or high viaducts, and it was universally used on Roman aqueducts and on many later ones, such as Roquefavour and High Bridge at New York (Fig. 190). The semicircle and ellipse are always satisfying, the ellipse being merely an oblique view of the circle. But neither of these forms correctly shows the line of pressure further than the point of rupture, for any portion of the arch below that point is really part of the pier or abutment. For comparatively flat arches, a curve of the same rise half way between a segment and an ellipse corresponds closely with the line of pressure, but departure from exact curves produces optical discord. The segment is the correct constructive form exhibiting greatest strength, but the semicircle and ellipse are acceptable for their fine appearance. Ellipses seem to be weak when they have too small a rise, the flat central part contrasting with the greater curvature at the springs. Lines are appropriate on the face of semicircular and elliptical arches, which represent the true line of thrust, material below this line near the springs being ineffective excepting for appearance. Segmental and elliptical arches appear to best advantage on low bridges, for the form originated from

insufficient space for a greater rise. The conoidal form, originated by Perronet, with segmental face tapering to an ellipse at the center of the soffit, was used on the Neuilly (Fig. 113) and Dora Riparia bridges near Turin, and was quite economical of material. The form offered

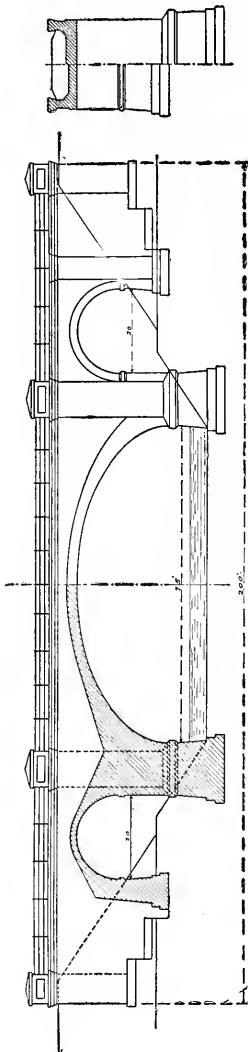

less obstruction to the passage of water and drift than a complete elliptical arch.

Ellipses should be exact curves or drawn from at least nine to eleven centers. The usual three or five-center approximations to the true curve betray their inaccuracy. The amount of rise is essential and should be enough to exhibit strength. Ellipses which are too flat, appear weak and insecure, a rise of one-fourth the span giving the most pleasing proportion. A good æsthetic effect is produced by using an ellipse for the center span, with smaller semi-circular arches at the side, as in the railroad bridge (Fig. 97) designed by the writer for crossing an irrigation canal in Idaho.

Springs appear best when at the same level. They should be marked by copings and should always be above high water, rather than occasionally submerged, as in old bridge at Avignon. In this respect the Roman bridges were lacking, for they frequently had springs at different levels, as in Trajan's bridge at Alcantara.

When the space beneath the bridge is so small that the base of semi-circular arches would be under water, the choice then must be between shorter spans and flatter curves. Over foot paths or

side walks, there should be at least six feet headroom at the springs, and if this is impossible a railing or partition wall should divert travel away from the lower part, rather than leave the path exposed and pedestrians liable to injury, as on the Longwood bridge (Fig. 166).

Arches supporting sidewalks are sometimes made flatter than those under the roadway, and piers somewhat thinner, as on Telford's bridges at Cartland Craigs, and Edinburgh. The method may also be used to advantage for widening old bridges, for the new flat arch is not an extension of the old one, and the addition is not so evident.

PIERS

Piers are of two kinds, (1) those which support high level bridges and (2) low piers such as those for ordinary flat bridges. All river piers must have cut waters, and these are most prominent on low structures, frequently being the most notable portion. Piers are either simple supporting, or abutment piers. The Romans generally used all of the latter type, and to their presence is due the partial preservation of many old Roman bridges such as Ponte Rotto (Fig. 100) and Avignon. Ponte Rotto, which was first constructed of stone during the years B. C. 178-142, continued in use until A. D. 1890, when it was replaced by a skew bridge with steel trusses on piers parallel to the current. In modern practice low and long spans require heavy piers, while high and short spans need lighter ones. When a pier occupies a central position in a bridge of more than one span, it should be large, or conspicuous enough to be a predominating feature, and the effect is improved if erections are continued above the deck. When drain pipes from the roadway are conducted down their side, they should be built into the masonry rather than exposed on the face or placed in grooves.

The chief parts of piers are the base, the body and the coping. Tall ones should have a batter on all sides and the

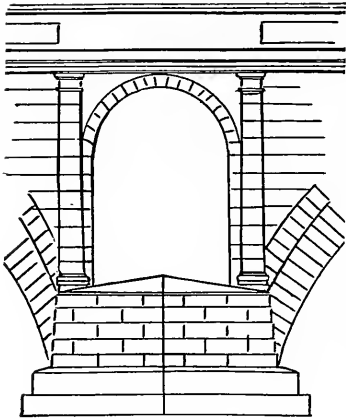

Fig. 98

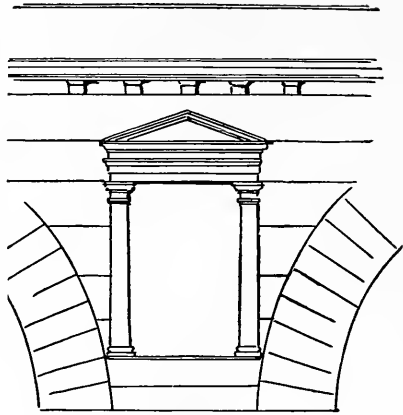

Fig. 99

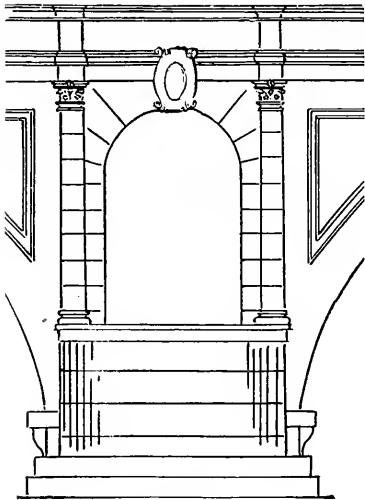

Fig. 100

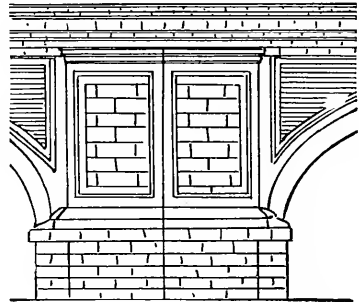

Fig. 101

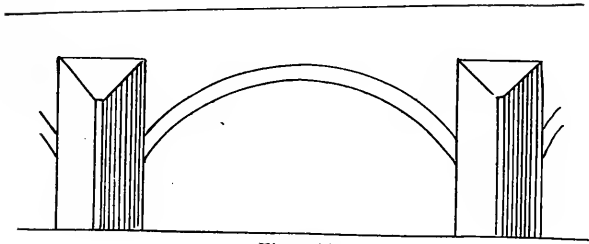

Fig. 102

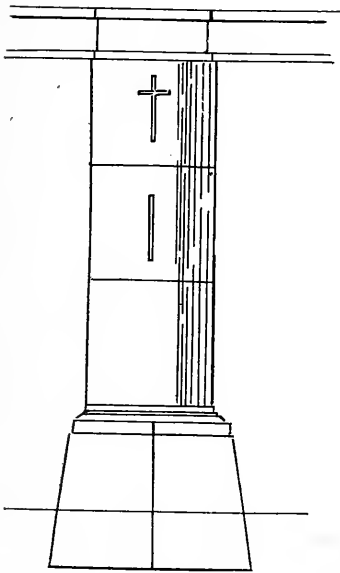

Fig. 103

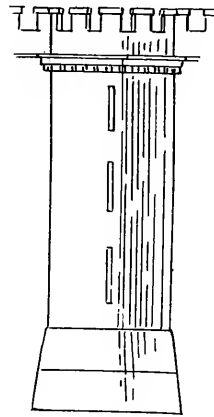

Fig. 104

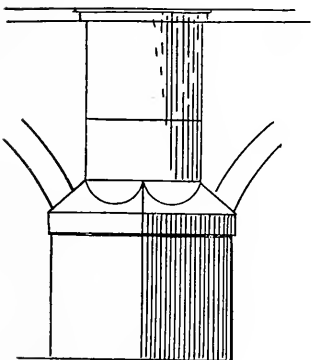

Fig 105

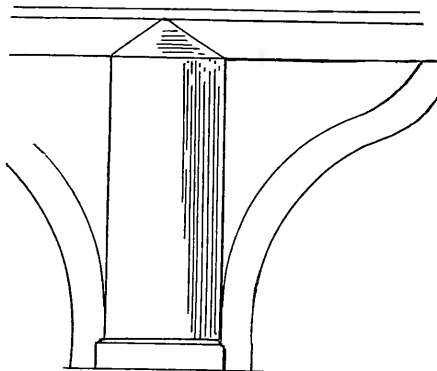

Fig. 106

body may be varied by one or more belt courses, though height is emphasized by an unbroken shaft. Sides slightly curved, as on the approach piers to the Forth bridge, appear very graceful and give the desired extra width at base.

Footing courses, cut waters and nosing are the principal parts below the springs. Pointed ends are more effective than round ones, and they should have a hard stone or iron nosing, but round ends are more pleasing. Curved outlines for piers as on the Maumee river bridge (Fig. 215) at Waterville, are appropriate in concrete, and show a correct use of moulded material, in contrast to stone.

SPACE ABOVE PIERS

Piers which seem to terminate at or about the springs, usually have a stunted appearance, and most of the finest bridges have decorative features up to or above the balustrade. This position is in fact the principal opportunity for displaying ornament. The Romans frequently used small arch openings through the piers above the springs as in Fabricius (Fig. 98), and Rotto (Fig. 100), which gave extra water way in flood seasons. On both these bridges at each side of the minor arches were semi-columns. The bridge at Rimini was ornamented with panels (Fig. 99) at each side of which were columns supporting a pediment. Bridges of the middle ages like those at Dresden and Limoges, had cut waters continued up to the deck, the upper part forming retreats in the balustrade. The heavy cut waters of the Dresden bridge are its principal characteristic. As the purpose of columns is to sustain weight, when they are used above the cut waters they should at least appear to support a load such as an extension of the sidewalk, a statue, or lamp cluster. Some of the finest bridges in Berlin (Figs. 107, 108) and London are adorned on the spandrels above the piers with statuary, and the Chatsworth bridge (Fig. 194) on a private estate in England, shows similar treatment. The new Cambridge bridge over the Charles river at Boston

exhibits the prow of a boat emerging from the pier, and a similar feature may be found on the old Margaret bridge at Budapest. Double pillars as on Rennie's Waterloo and Kelso bridges, are striking ornaments, but appear less substantial than the plain pilasters of London bridge. Single large semicolumns above the triangular cutwaters of Pont Neuf at Paris, support sidewalk retreats, the position of which are emphasized by double lamp standards at each side.

Niches in piers are features more suited to small bridges than to large ones. Most of the features on the spandrel face above the piers which are described above, interfere with and seem to cross the ends of the arch rings, though this is avoided in the design of Fig. 107.

ABUTMENTS

The design of abutments should harmonize with the piers, and they should not only be sufficient, but should appear heavy enough to resist the thrust upon them. The apparent strength of abutments is often injured by the presence of smaller arches which penetrate them just where weight is most needed. Abutment faces should have a batter, for without it they seem to be top heavy and unstable. The base or lower part should be plain, and the amount of detail ornament increased towards the parapet. Curved wing walls add greatly to the æsthetic effect, and even when plain girders are imperative as at the entrance to Forest Park, St. Louis, carefully designed abutments may in themselves add enough beauty to the bridge. Cantilever wing walls as on the Topeka bridge, are possible in reinforced concrete, and are much lighter than solid ones which must depend on their weight for stability. On the writer's design for an ornamental park bridge (Fig. 159), the arches shown on the abutment faces may be merely wall decoration, in which case the bridge floor may be carried either on solid earth filling or on interior framing. If, however, the arch ways are required open for foot walks or for other pur-

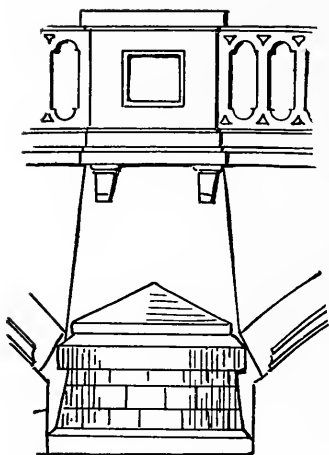

Fig. 107

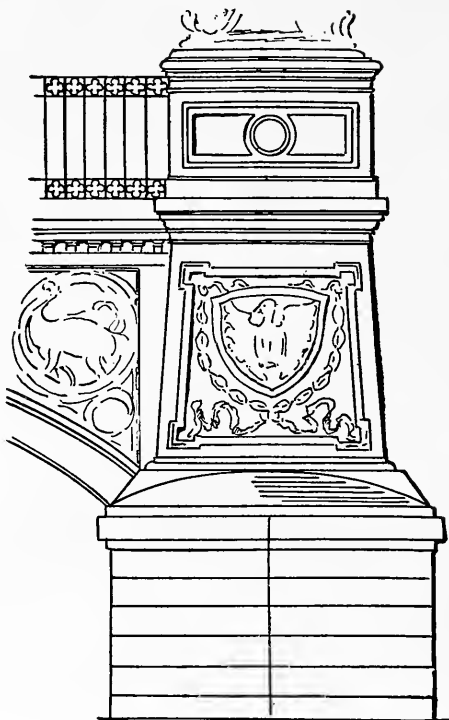

Fig. 108

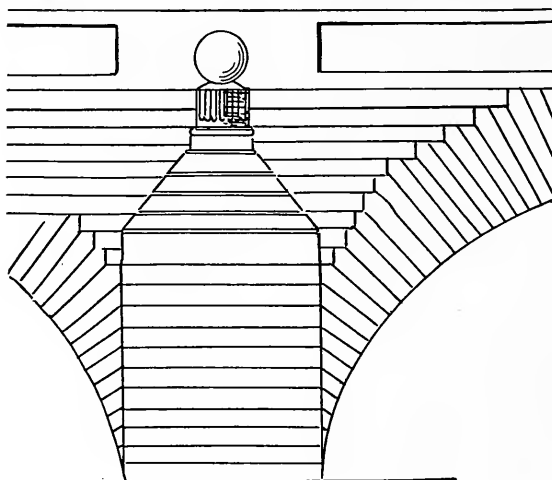

Fig. 109

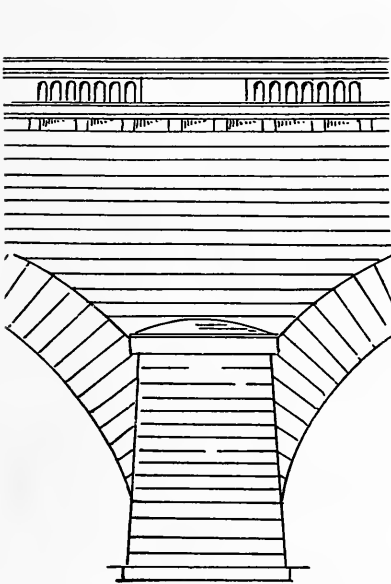

Fig. 110

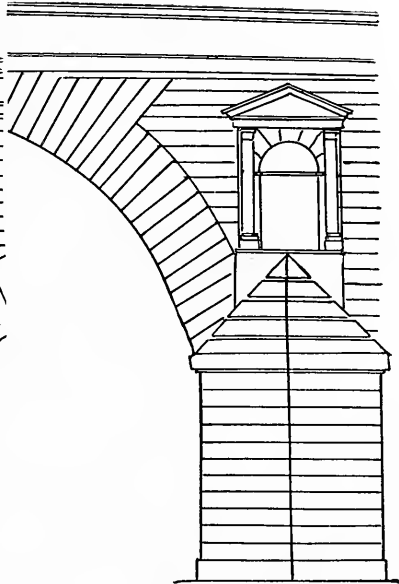

Fig. 111

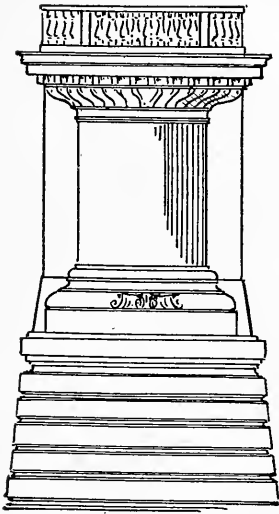

Fig. 112

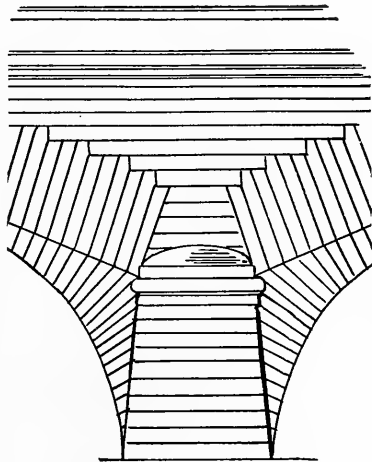

Fig. 113

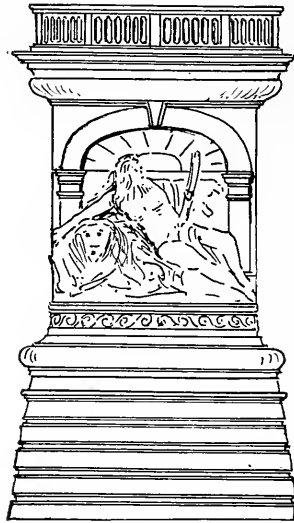

Fig. 114

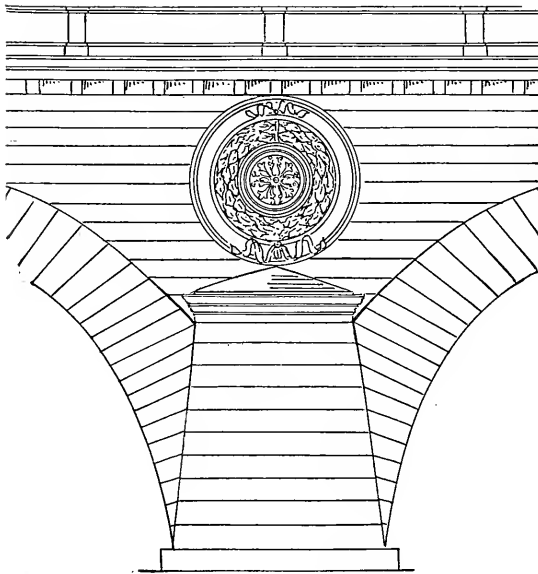

Fig. 115

pose, the filling will then be placed above the arches. The latter method, though costing more, will give a better effect than the arrangement with false arches, for the end and center openings will have the additional interest of contrast.

PARAPETS AND BALUSTRADE

No part of a bridge is more often seen than its parapet, and in no place is fine ornament more appropriate. The degree of art displayed should correspond with the importance of the structure and the amount of travel which passes over it. Railroad bridges with little or no pedestrian travel may need no balustrade, and even when sidewalks are present, embellishment cannot be so well enjoyed as on street bridges, and the latter class should therefore exhibit the finest effects.

Balustrades are either solid or open. Solid ones over thin arch rings appear to add greater depth and strength to light designs and for this reason they are often preferred. But parapets should not be so heavy as to make it seem that the only duty of the arch was to support them. Excellent examples of solid railings are on Ponte Rotto at Rome, and Pont Neuf at Paris. On the contrary very heavy arches should have a light open railing like the metal ones on High Bridge (Fig. 190) at New York. Municipal bridges are generally heavy enough to make an open and more ornate balustrade preferable. Their height varies from three to five feet, the usual being three and one-half feet.

The parts of balustrades are the cap or coping, the dado or central part, and the plinth or base, the latter part sometimes including a cornice. A smooth coping is most appropriate, forming a convenient hand rest and the neatest finish, a fine effect being shown on the Forest Hills Cemetery bridge, which has white stone over a grey rustic dado. In other cases the coping is made of the same material as the cornice and arch rings, with intervening parts of a different nature and color. The embrasures of battlemented copings as on the Tongueland (Fig. 104) and Cahors bridges, should be

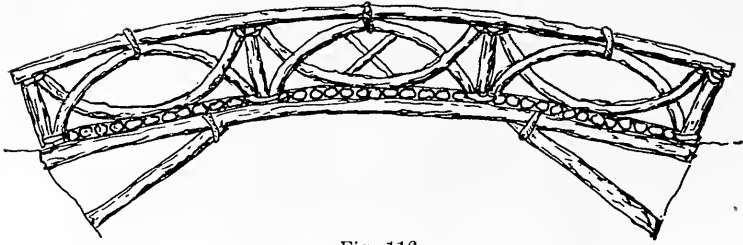

Fig. 116

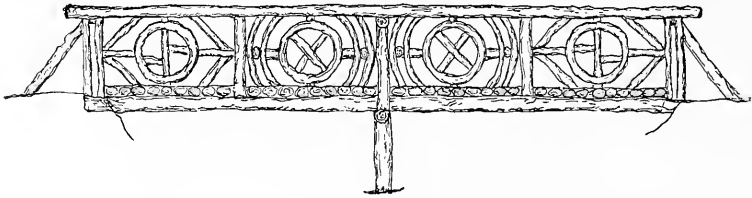

Fig. 117

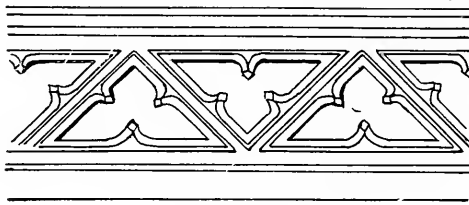

Fig. 118

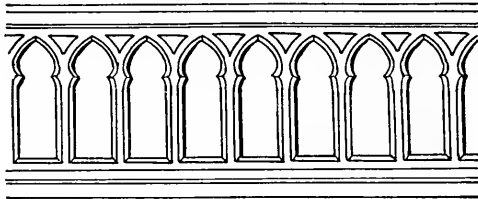

Fig. 119

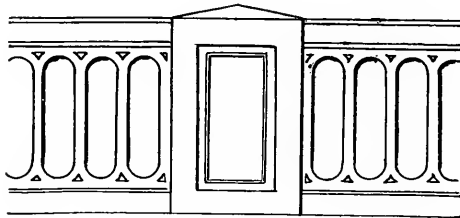

Fig. 120

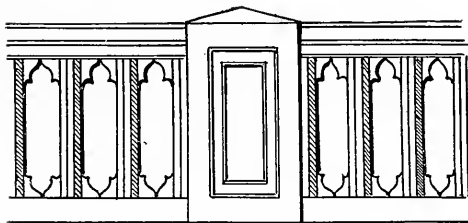

Fig. 121

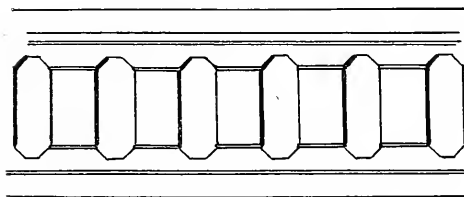

Fig. 122

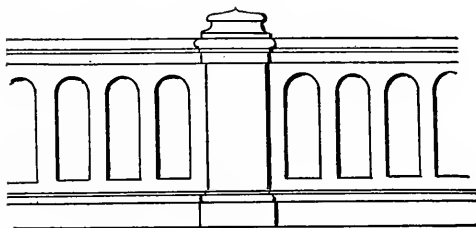

Fig. 123

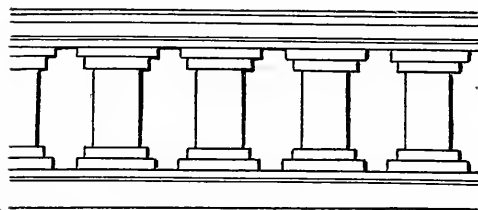

Fig. 124

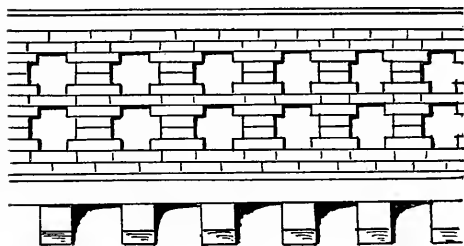

Fig. 125

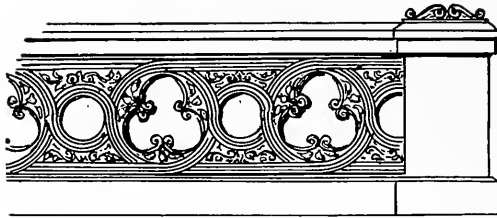

Fig. 126

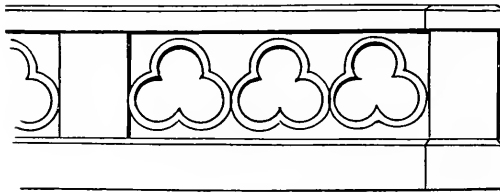

Fig. 127

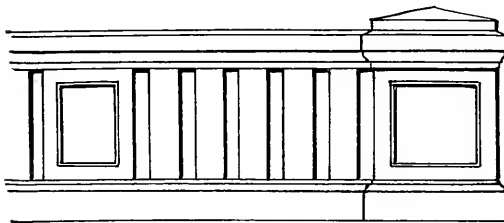

Fig. 128

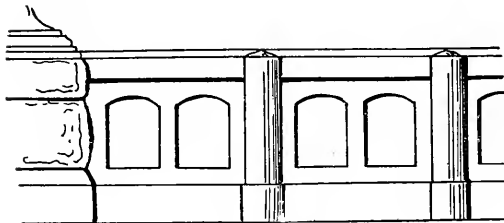

Fig. 129

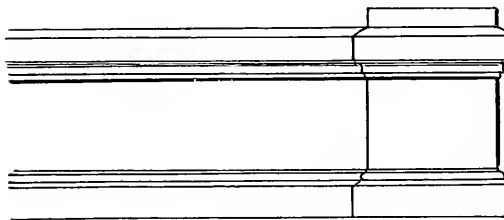

Fig. 130

guarded with metal rods to avoid openings of too great a size. A rustic coping may be made by placing thin stones on edge embedded in the wall beneath them, as on the Cresheim Creek bridge at Philadelphia, but the design is suitable only in rough surroundings, or where the balustrade is intended to be repellent.

The dado or central part is usually the most elaborate, the amount of ornament being limited only by the prominence of the structure. The base course or plinth should in the absence of a cornice indicate the grade of the road or sidewalk by a projecting string course. A decided camber is appropriate on low bridges, showing the useful purpose of increased clearance underneath, but high bridges may have a flatter grade. Foot bridges over railway cuttings or canals, which have excessive grade or stepped approach, may have level courses in the parapet capped with an anchored coping, or the coping may be stepped at intervals corresponding with the rising floor, as on the bridges at Torcello, Italy, and Belle Isle Park, Detroit. The cambered coping of the Boylston bridge is one of its most interesting outlines. Intermediate pedestals are not desirable in balustrades with excessive camber, for their plumb and horizontal lines are out of harmony with the sloping lines of the balustrade adjoining them. But on flatter bridges they are most appropriate, and offer much diversity of design and treatment. They should be placed over the piers and at the ends, and a few intermediate smaller ones in the railing add variety. End pedestals should be the largest and most prominent, and in some bridges they have been made large enough to represent toll houses. Two intermediate ones, dividing the railing over each arch into three panels, produce a good effect and were used on the beautiful Wellesley bridge at Limerick; but they may be more numerous as on the Rittenhouse Lane bridge at Philadelphia. Turned stone balls are good balustrade ornaments, as on Kings Bridge, Nuremburg, or on one in Golden Gate Park, San Francisco. Balustrades may be made of several materials and in great variety. A few designs are illus-

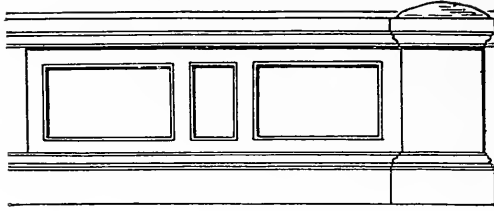

Fig. 131

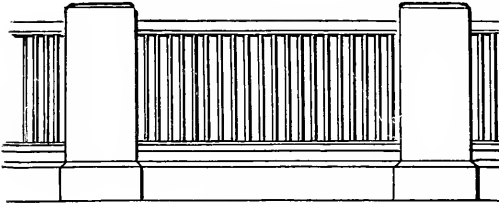

Fig. 132

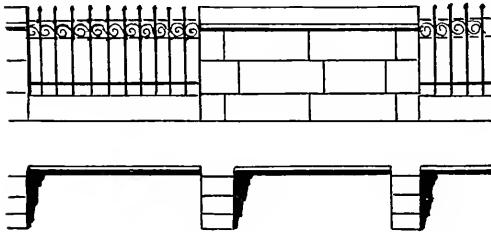

Fig. 133

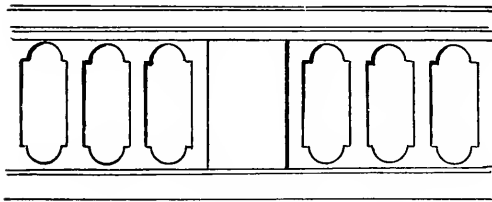

Fig. 134

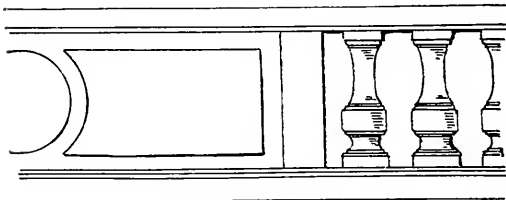

Fig. 135

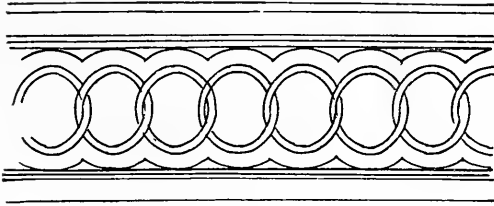

Fig. 136

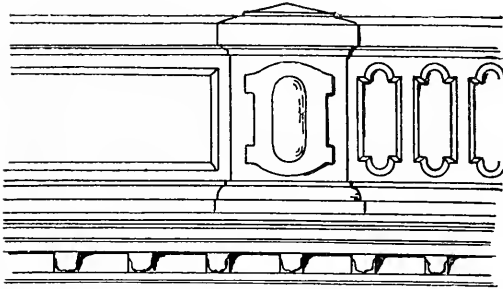

Fig. 137

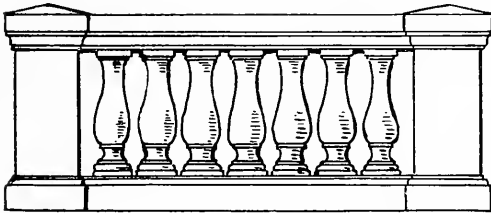

Fig. 138

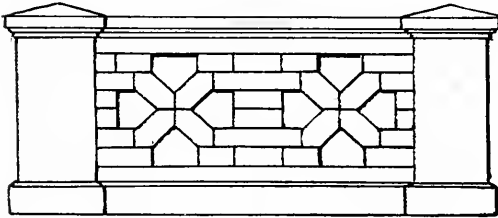

Fig. 139

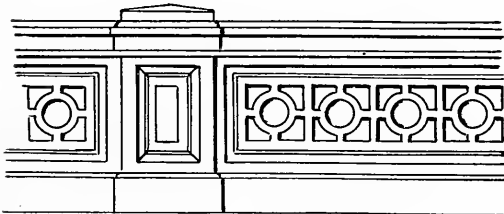

Fig. 140

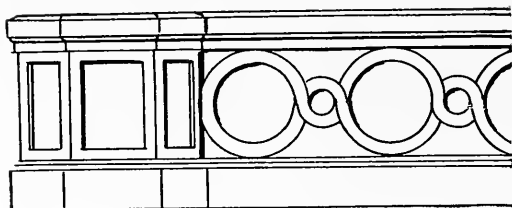

Fig. 141

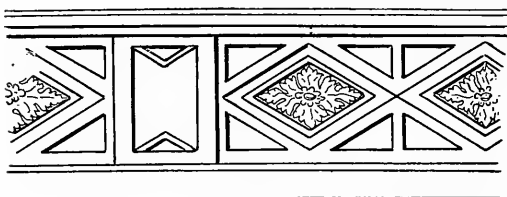

Fig. 142

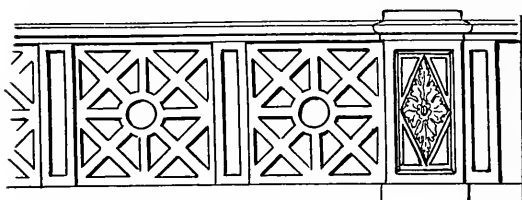

Fig. 143

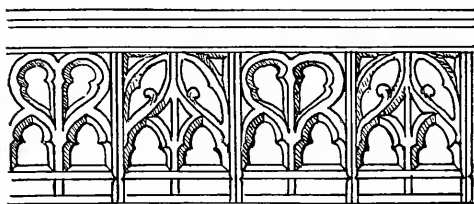

Fig. 144

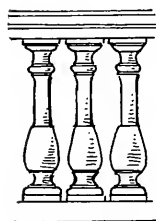

Fig. 145

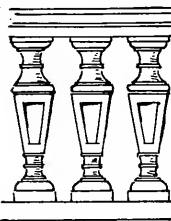

Fig. 146

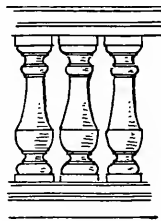

Fig. 147

trated, in rustic wood, cut stone, brick, artificial stone, terra cotta, cast iron and wrought metal, though some designs which have been executed in one material are equally appropriate in others. Fig. 116 and Fig. 117 are suitable for foot bridges in wooded dells of private estates or parks, while Figs. 118, 119, 120, 121 and 144 could be made in cast iron or terra cotta. Figs. 122, 124, 125 and 139 could be nicely executed in brick, and Fig. 132, which is the balustrade on the Connecticut avenue bridge at Washington, has beauty of contrast, with light iron railing between heavy masonry supports. Fig. 133 is the balustrade on the beautiful Memorial bridge at Hartford, designed by George Kellar and more fully shown in Fig. 14. Turned balusters of stone or metal, Figs. 135, 138, 145, 146 and 147, are more used on the fine bridges of Europe than any other form. They frequently correspond with parts of adjoining buildings, and the detail is never tiresome. Large dado openings as on the Garfield Park bridge (Fig. 129) should be guarded with embedded metal bars. Figs. 148 to 158 are suitable in bronze or iron.

MATERIAL, COLOR, AND SURFACE FINISH

Harmony of color affects the senses in a similar way to harmony of sounds. Structural parts like arch rings and piers may be appropriately emphasized in material of a different color to the rest, as in the Rock River bridge at Watertown, Wis. A fine mottled effect with beauty of contrast, is obtained with a concrete surface finish of crushed black stone, showing the grey concrete body between the facing pebbles.

Below the springs, piers may be made of rougher or darker material than the part above that level, as on High Bridge at New York (Fig. 190), or the Chatsworth bridge (Fig. 194), which has rough stone piers and smooth spandrels. Concrete must not be made to imitate stone, for the result is not only false but disappointing. Glazed brick in different shades contrasts well with stone and is used with fine effect in the spandrels of the Sixth street bridge at Des Moines, Iowa, and in the soffits

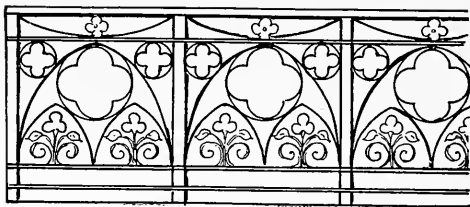

Fig. 148

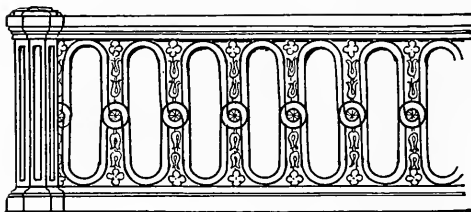

Fig. 149

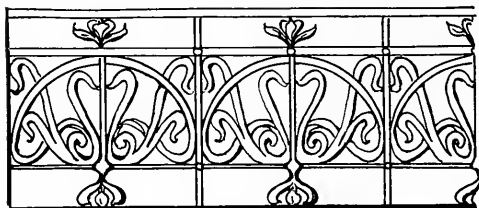

Fig. 150

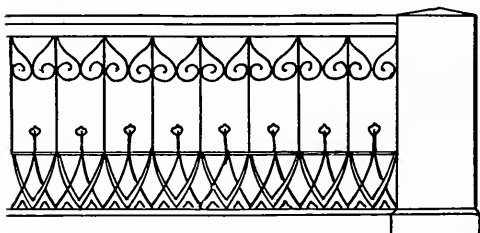

Fig. 151

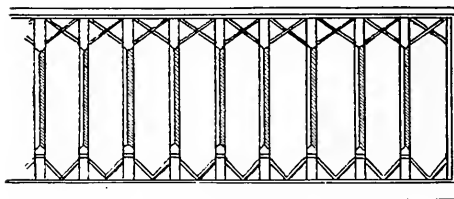

Fig. 152

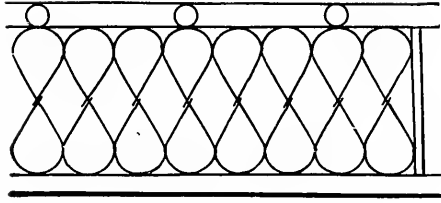

Fig. 153

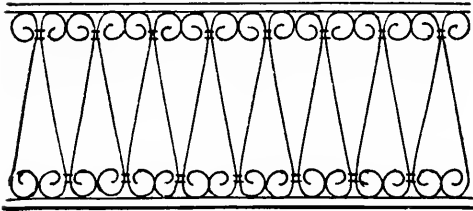

Fig. 154

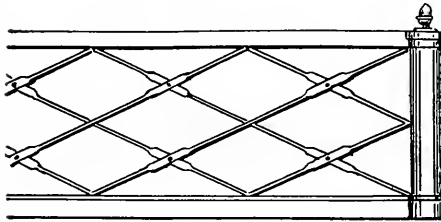

Fig. 155

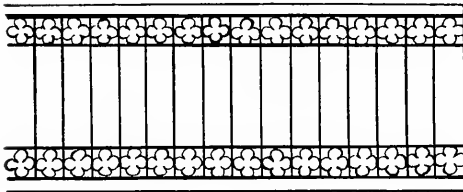

Fig. 156

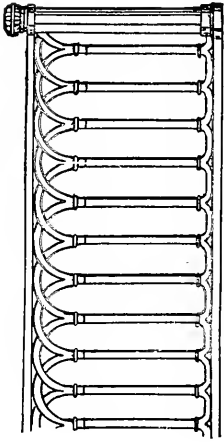

Fig. 158

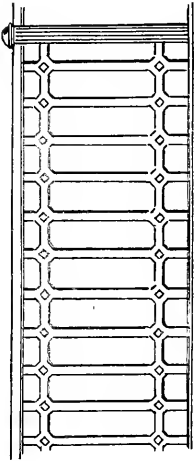

Fig. 157

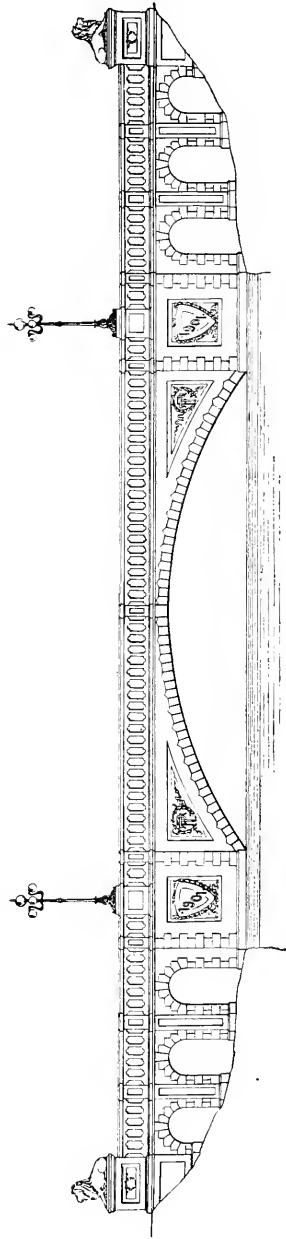

Fig. 159

of Stony Brook bridge (Fig. 168) in the Boston Fenways, while greater elegance is shown by the light colored frieze course on the portal tower of the Hartford Memorial bridge. Excellent color combination in grey and reddish concrete, is exhibited in Piney Creek bridge at Washington. Rough stone face is the most appropriate for heavy bridges in rural districts as on the railroad bridge (Fig. 192) over the entrance to the wooded Wissahickon valley, and a more rustic appearance is displayed in the Waldi-Tobel bridge in Austria. A fine surface finish is secured with moulded concrete facing blocks, as in the Connecticut avenue and Sandy Hill bridges and on the ornamental park bridge (Fig. 159) designed by the writer ten years ago. In the last case the arch ring and all corners and moulding are of concrete blocks, while the balustrade is of artificial stone. The two piers at each side project out past the face of the arch and are ornamented with shields, and above the piers the balustrade is offset two feet, forming retreats from the sidewalks in which seats are provided under the electric lamps. Unsightly and irregular marks on concrete surfaces are avoided by placing triangular strips over the plank joints, which produce horizontal lines on the finished masonry. The expedient is not an imitation of stone courses, but is used rather to emphasize the form joints since they cannot be avoided. On flat surfaces irregularities are too evident, and this method of lining the face produces an effect similar to that on the spandrels of London bridge. Roman bridges with concrete bodies were usually faced with travertine, but as moulded concrete blocks are now easily obtainable, they are usually more appropriate.

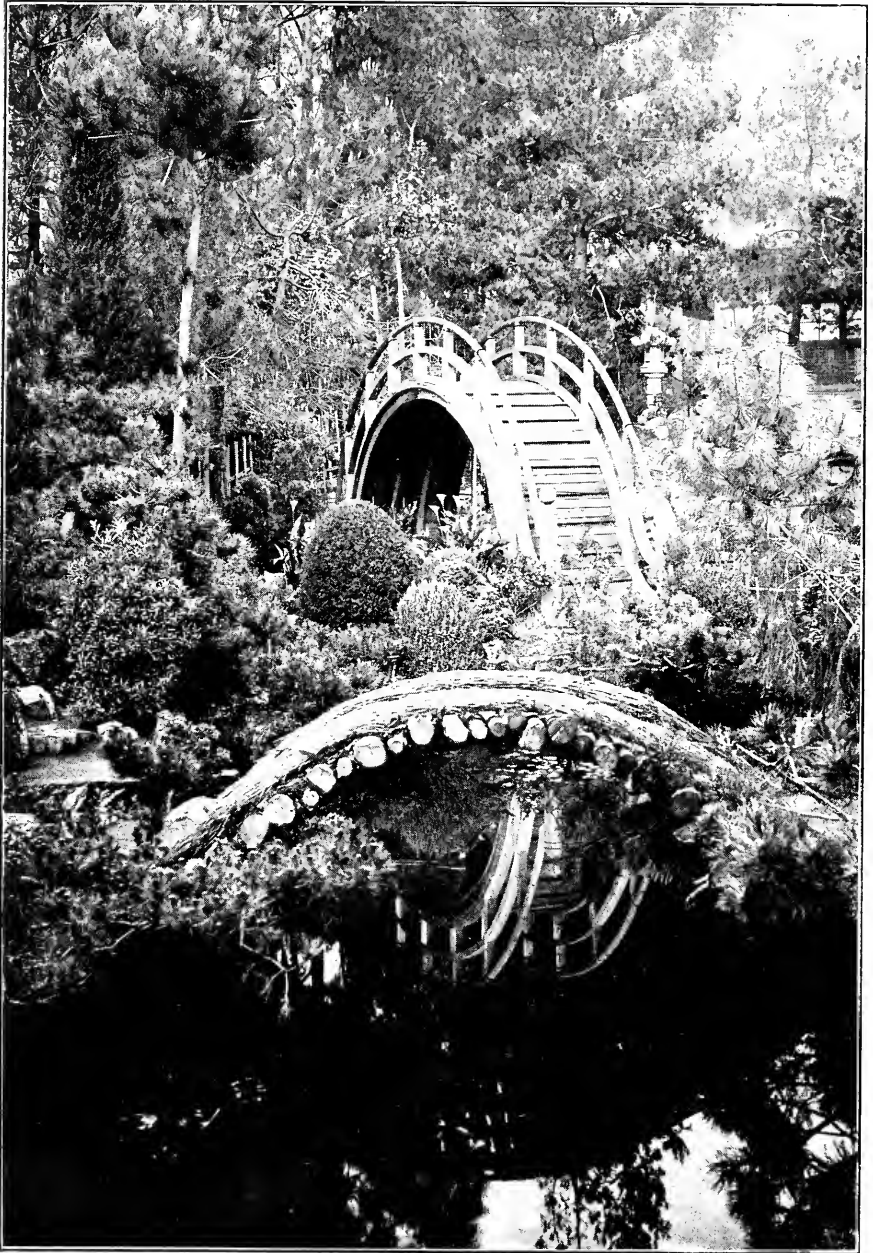

Fig. 160

FIGURE 160. Bridge in Japanese Tea Garden, San Francisco

These little rustic bridges are typical of many found in Japanese gardens. They are called "Drum" or "Bow" bridges and are curved upward, giving space for the passage of boats. The drum is provided with steps for climbing the ascent, and it has a railing at each side. They are quite ornamental and appropriate for Japanese gardens, of which there are many in cities outside of Japan.

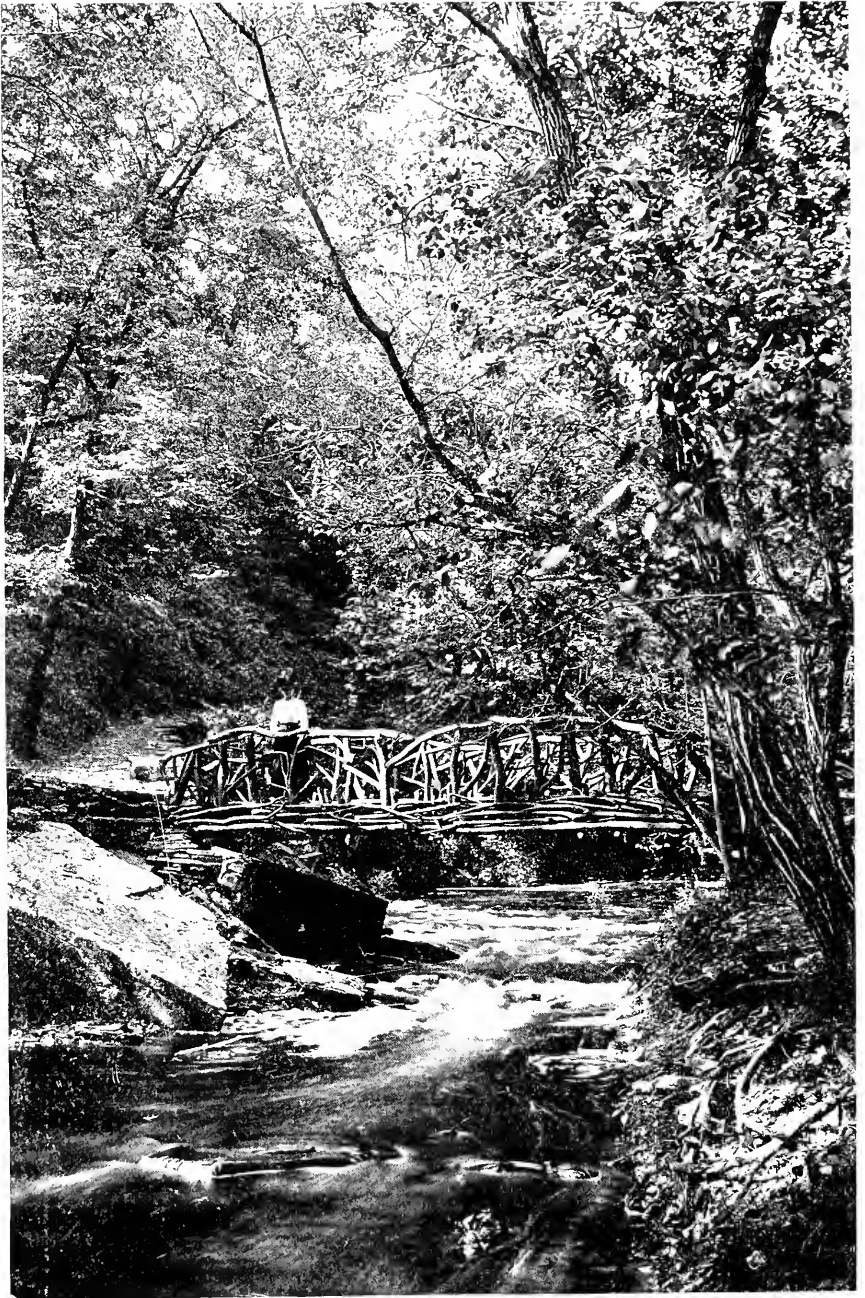

FIG. 101

FIGURE 161. Rustic Bridge in Minneapolis, Minn.

Located among the trees and across the path, in a small ravine, is a very appropriate little foot bridge. It is extremely well suited to the surroundings, and was built in 1893. The design is ordinary but satisfying, because of its fitness.

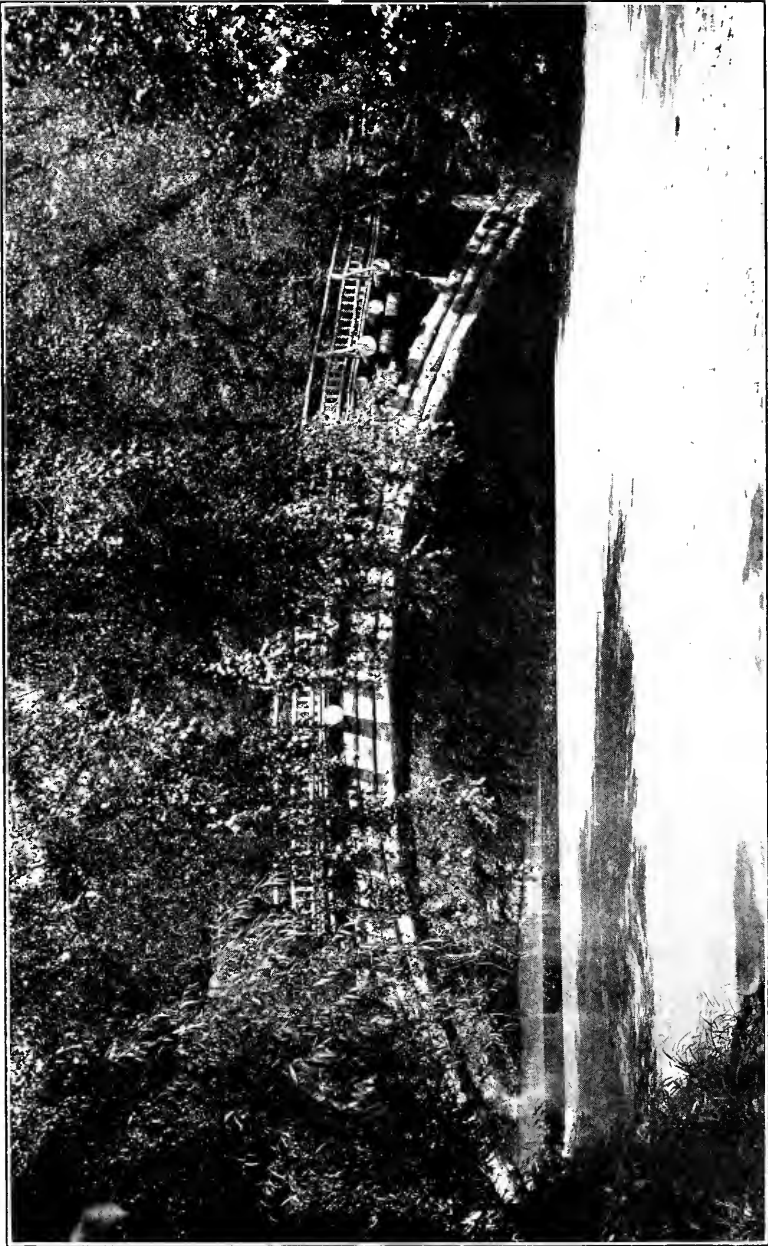

Fig. 162

FIGURE 162. Log Bridge at Washington, D. C.

A very interesting and unusual example of rustic construction was built a few years ago in the National Zoological Park at Washington. It is a log arch of 75 ft. span and 30 ft. wide. The total cost, including macadam roadway and foot walks, was about \$3,000.

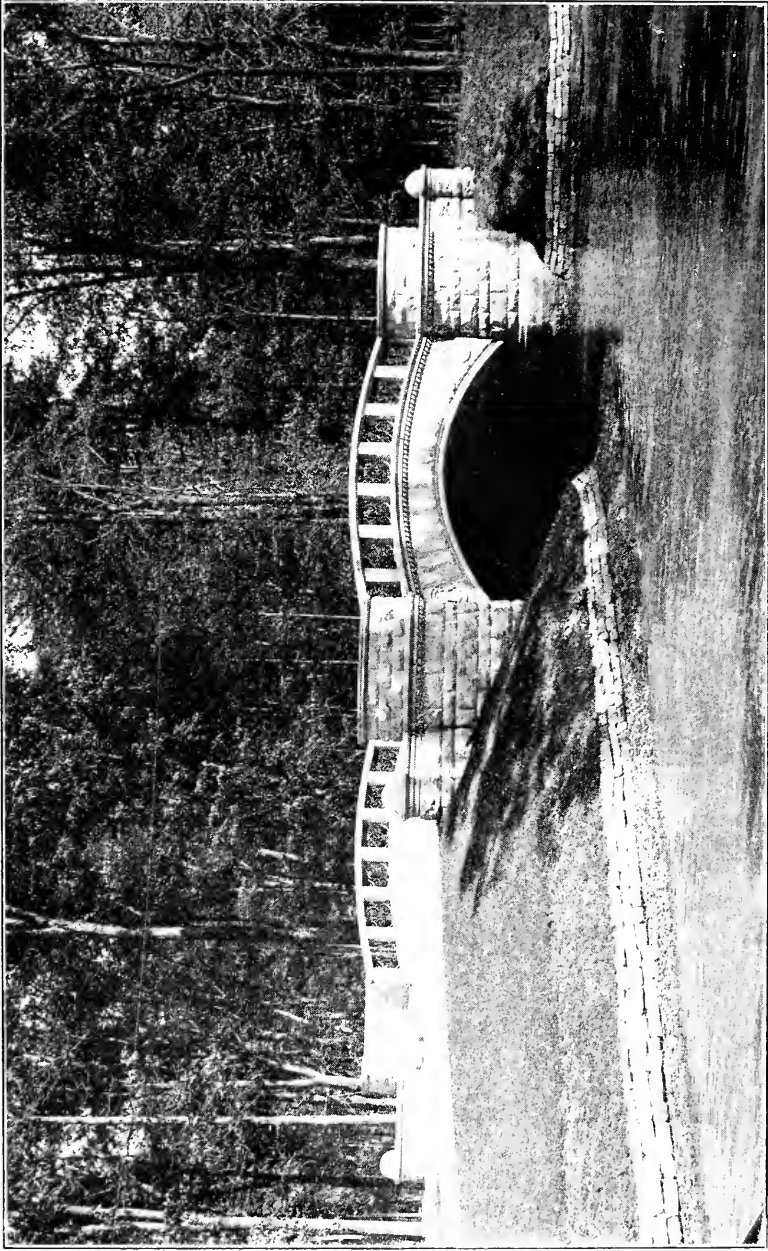

Fig. 163

FIGURE 163. Bridge at Belle Isle Park, Detroit, Mich.

Belle Isle Park at Detroit is approached from the city by crossing several bridge spans having through metal trusses, which are suitable only for some outlying district where they would be seldom seen, but within the park are several very attractive bridges, one of which is herewith illustrated. The long, uncouth and gaunt steel bridge over one channel of the river, from the city to the park, stands out in striking contrast to the beautiful bridges among the foliage, and shows the difference between factory-made products and those designed by an engineer artist.

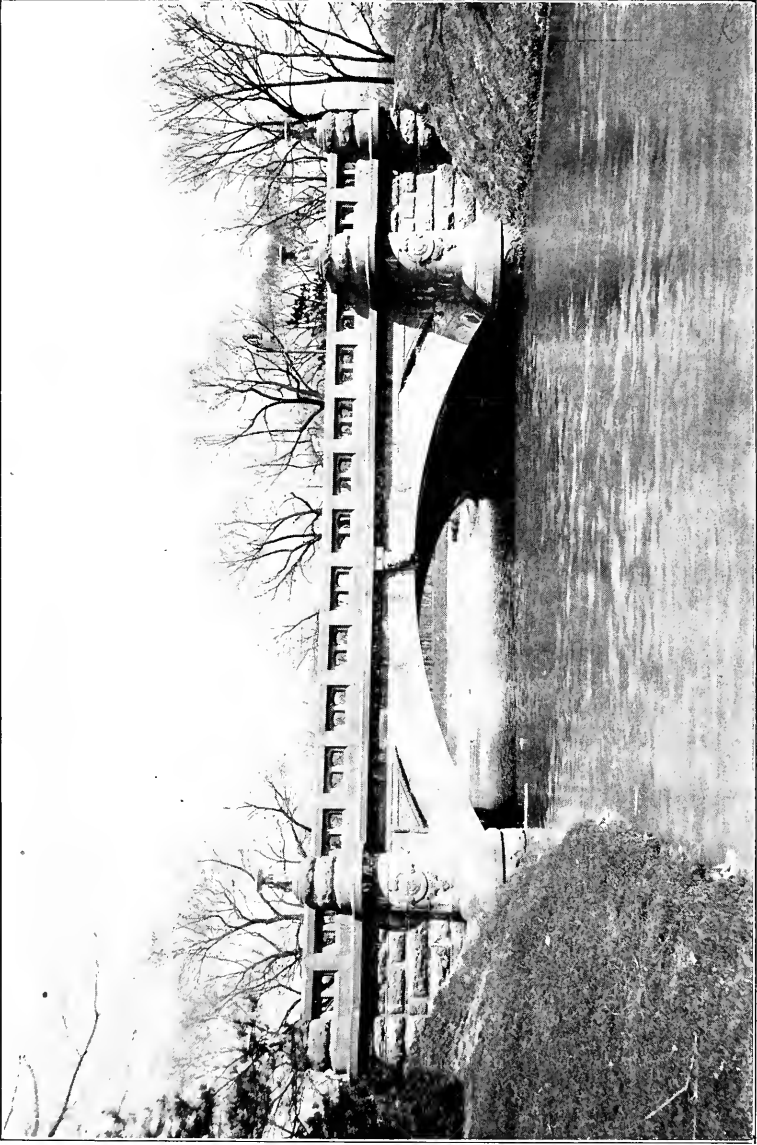

Fig. 164

FIGURE 164. Arch Bridge in Garfield Park, Chicago

In this bridge the semi-columns at the terminus of the arch and the end newels, together with the ornamental coping and heavy open balustrade, unite to produce a very pleasing effect. At either side are medallions bearing the park initials in monogram, and on the spandrels is the date of construction, 1893.



Fig. 165

**FIGURE 185. Brick Arch Bridge over North Ravine, Lake Park,
Milwaukee**

This arch was built in 1893, and has a clear span of 35 ft. The arch stones and trimmings, as well as the railings, are of terra-cotta, the spandrel faces and wing walls of brown face brick, and the body of the arch of five rings of hard burned sewer brick laid in cement. It has a 26-foot roadway and two walks each 6 ft. wide and its total length is 100 ft. It is the design of Oscar Sanne, and was completed at a cost of \$10,500.

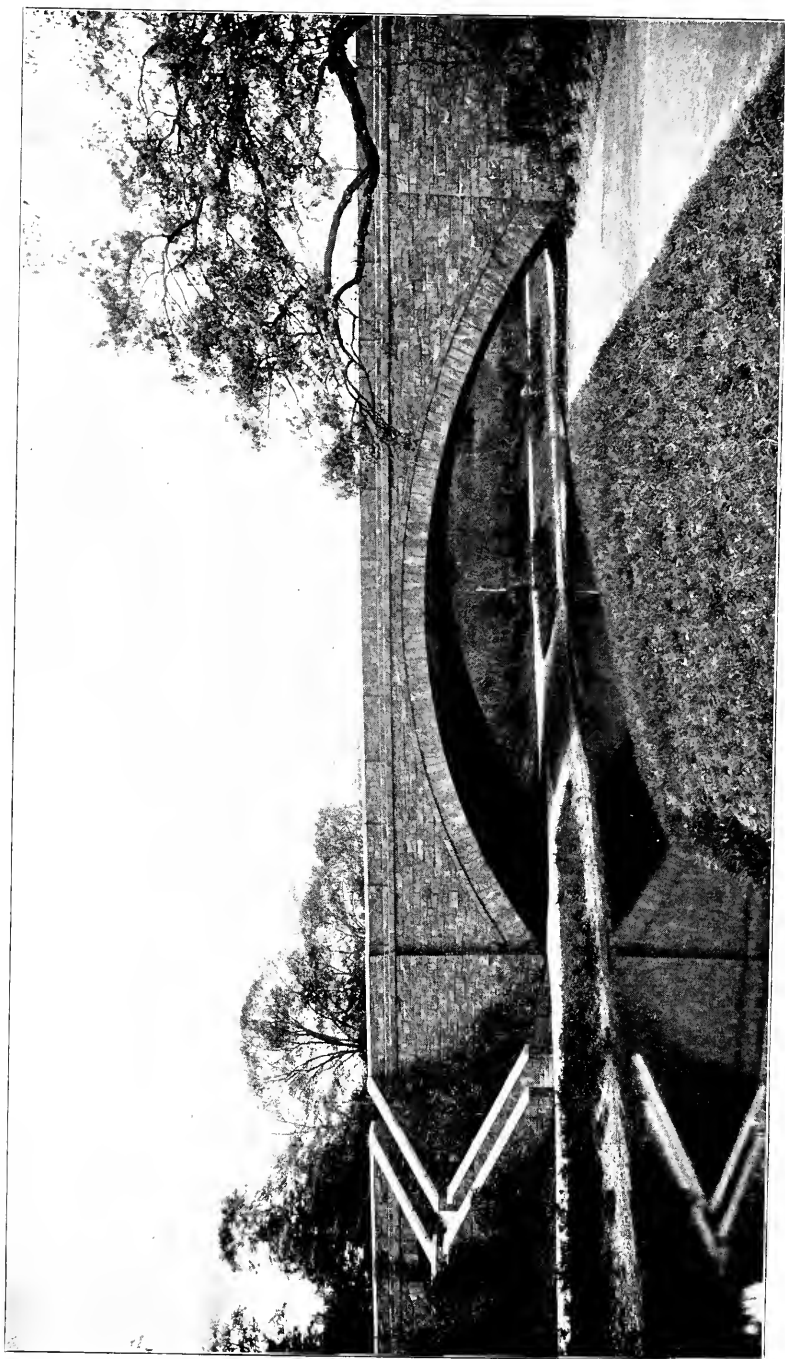

Fig. 166

FIGURE 166. Longwood Bridge, Boston, Mass.

The view shows Longwood bridge, in the Boston Park system, which is a modification from the plan prepared by Shepley, Rutan and Coolidge, architects. The estimate on this bridge in rock-faced ashlar with soffits of brick, was \$153,000. The original sketch showed steps at both ends, leading from the bridge to the walks underneath, and also showed more decorative features, such as blind abutment arches, medallions at the spandrels, and heavy pilasters at the ends of the arch, carrying sidewalk lookouts or retreats. The grade of the street is so low that there appears to be insufficient head room for the paths beneath, an objection which might have been overcome by using three spans instead of one. The balustrade is solid without openings, and has a coping of different material.

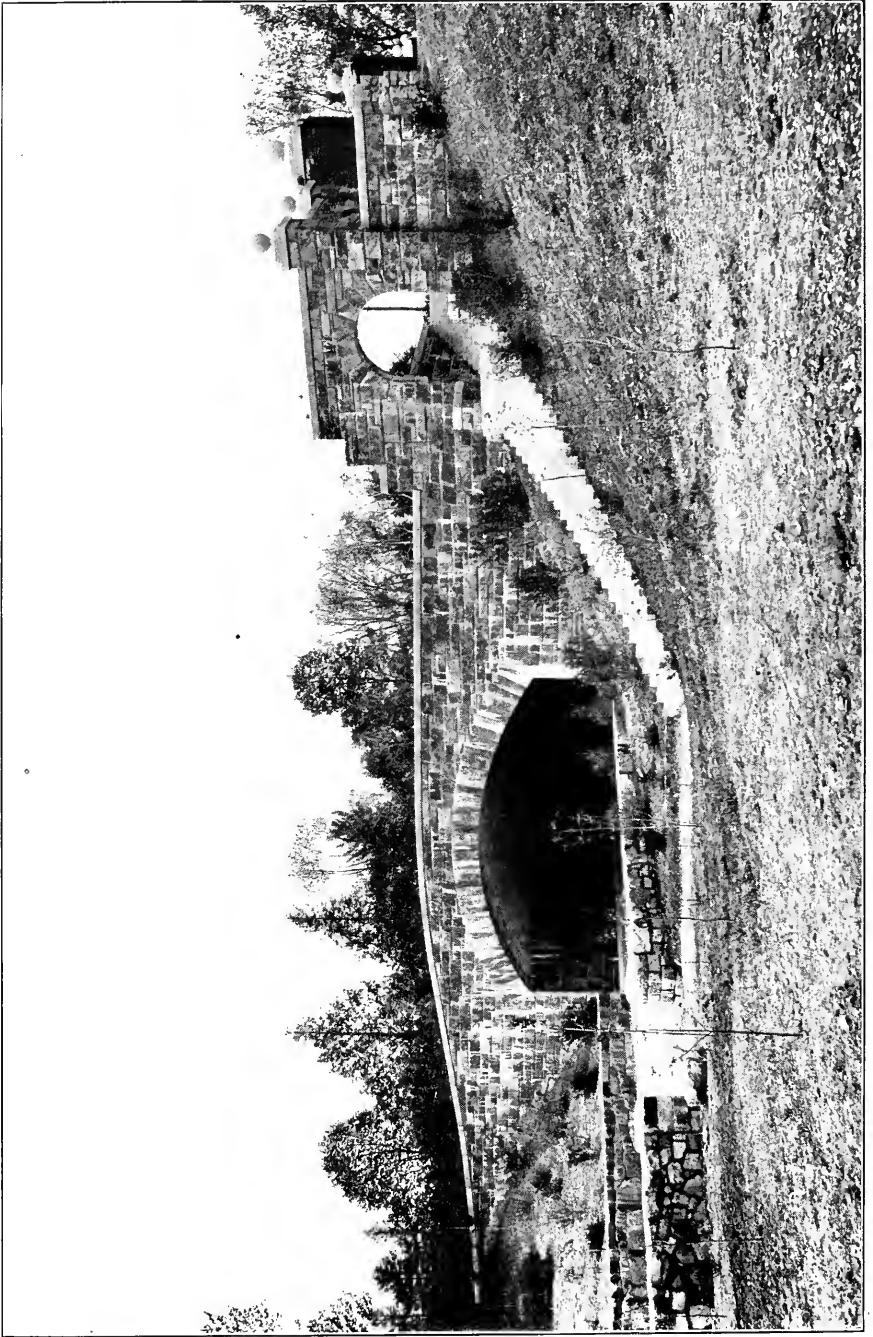

Fig. 167

FIGURE 167. Forest Hills Entrance to Franklin Park, Boston

A beautiful structure in Franklin Park, Boston, was built to carry the parkway over the traffic road from Forest Hill street to Forest Hills Cemetery. This bridge is 125 ft. long, and the main span is a segmental arch of 45 ft. A stairway connects the walk over the bridge with a footway along the traffic road beneath, and the slopes of the bank are supported by retaining walls. Crossing the parkway over the bridge is a gateway, the masonry piers for which have been built. This gateway has three openings, one each for the drive, the walk and the road. The piers of the side gates are connected with the parapets of the bridge, forming a continuous structure. At one side of the gateway is a recess, with seats and a drinking fountain. The total cost was \$51,000. The exposed surface is of seam-faced granite, excepting the coping and cap stones, which are red granite. The soffit of the arch is light colored brick, while the remainder is common brick. Shepley, Rutan & Coolidge were the architects.

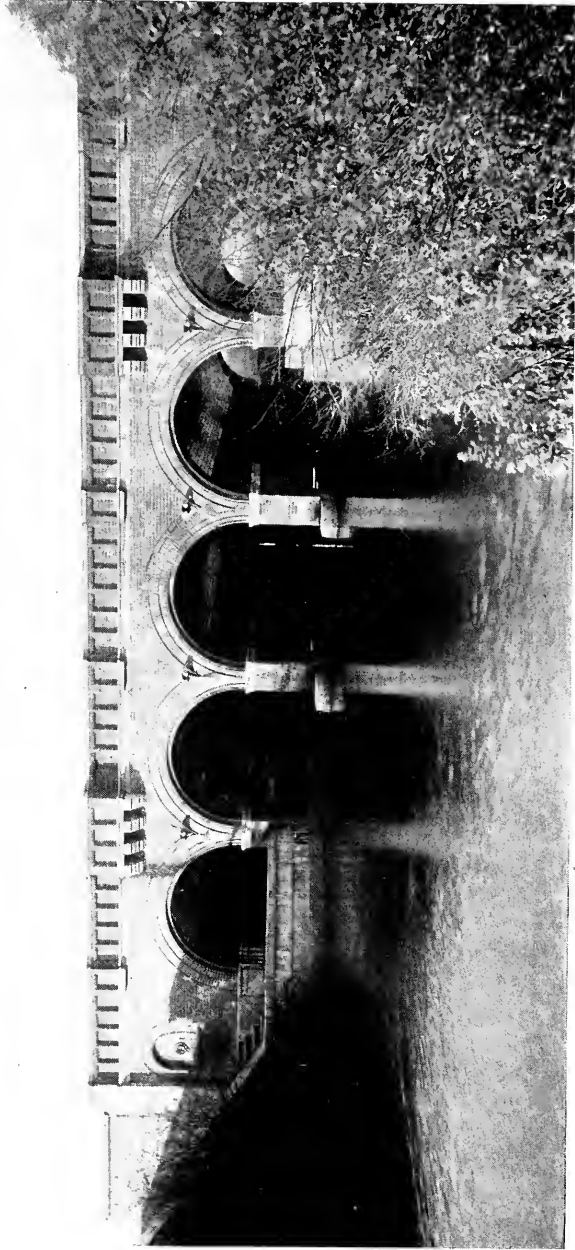

Fig. 168

FIGURE 168. Stony Brook Bridge, Boston, Mass.

A number of beautiful bridges have been constructed during the last few years in the city of Boston, in and about its park system. One over Stony Brook, in the Fenways, was built in 1891, consisting of five stone arches of 10 ft. span, three being over the waterway and two over the footpaths at each side. The bridge is 85 ft. wide between parapets, and the arches are supported by piers. There is at each end a flight of steps from the sidewalk on the bridge to the footwalks beneath it, and at each stairway is a drinking fountain. The face work of the masonry is speckled brick with trimmings of Milford granite. The barrel vaulting is lined with glazed brick of different colors, in patterns. The total cost was \$40,000, and it was designed by F. L. Olmstead & Company, and Walker & Kimball, architects.

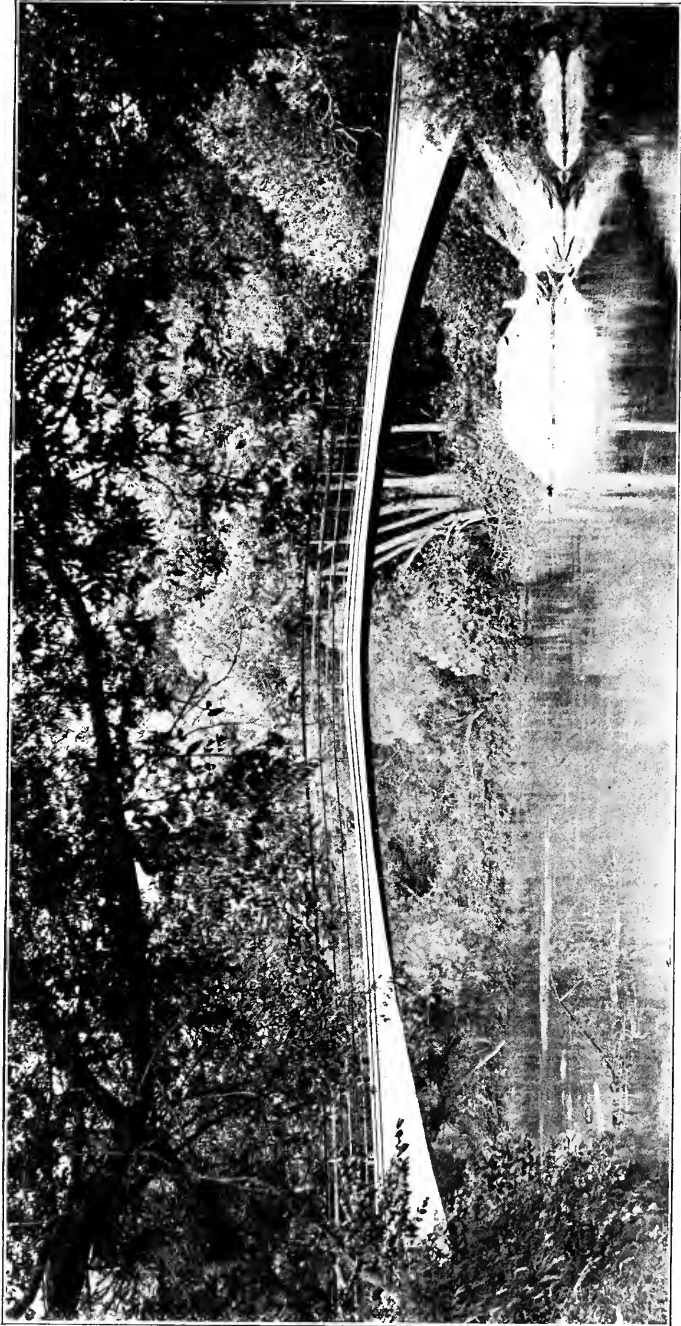

Fig. 169

FIGURE 169. Stockbridge, Mass., Foot Bridge

One of the lightest concrete bridges ever built is the one at Stockbridge, over the Housatonic river, connecting Laurel Hill with Ice Glen. It has a clear span of 100 ft., rise of 10 ft. a total length of 124 ft. and a 7-ft. roadway. The crown thickness is only 9 inches, increasing at the haunches to 30 inches. It is reinforced with 7-inch curved steel beams 28 inches apart. The foundation is rock and the whole structure contains only 22 cubic yards of concrete. It was built in 1894 at a cost of \$1,475, and, after completion was tested with a load of 25 tons.



Fig. 170

FIGURE 170. Lake Park, Milwaukee, Foot Bridge

This structure carries a foot path in Lake Park, Milwaukee, across a ravine 59 ft. deep. It is located quite near to the pavilion and is much seen, especially in the summer time. The clear span is 118 ft. between abutments, rise of arch is 18 ft., and the width 14 ft. There are two reinforced concrete ribs, 12 inches wide and 54 inches deep, with an inner flange 9 x 9 inches on the lower side of the arch ribs. These ribs are placed 12 ft. apart in the clear, and support the spandrel walls which carry directly the 6-inch reinforced floor slab. At distances of about 12 ft. apart longitudinally, there are cross walls and struts connecting the main arch ribs, and between them is a double system of lateral bracing consisting of steel angles with the ends securely fastened into the concrete. The spandrel walls are 12 inches thick, and there are expansion joints at each end adjoining the abutments, but the arch ribs and abutments are monolithic. The floor is cambered 8 inches longitudinally for drainage, and the total length is 214 ft. The abutment sides are connected with cross walls which carry a floor slab similar to that on the bridge. Professor Turneure, of Madison, was consulting engineer and the Newton Engineering Company, contractors.

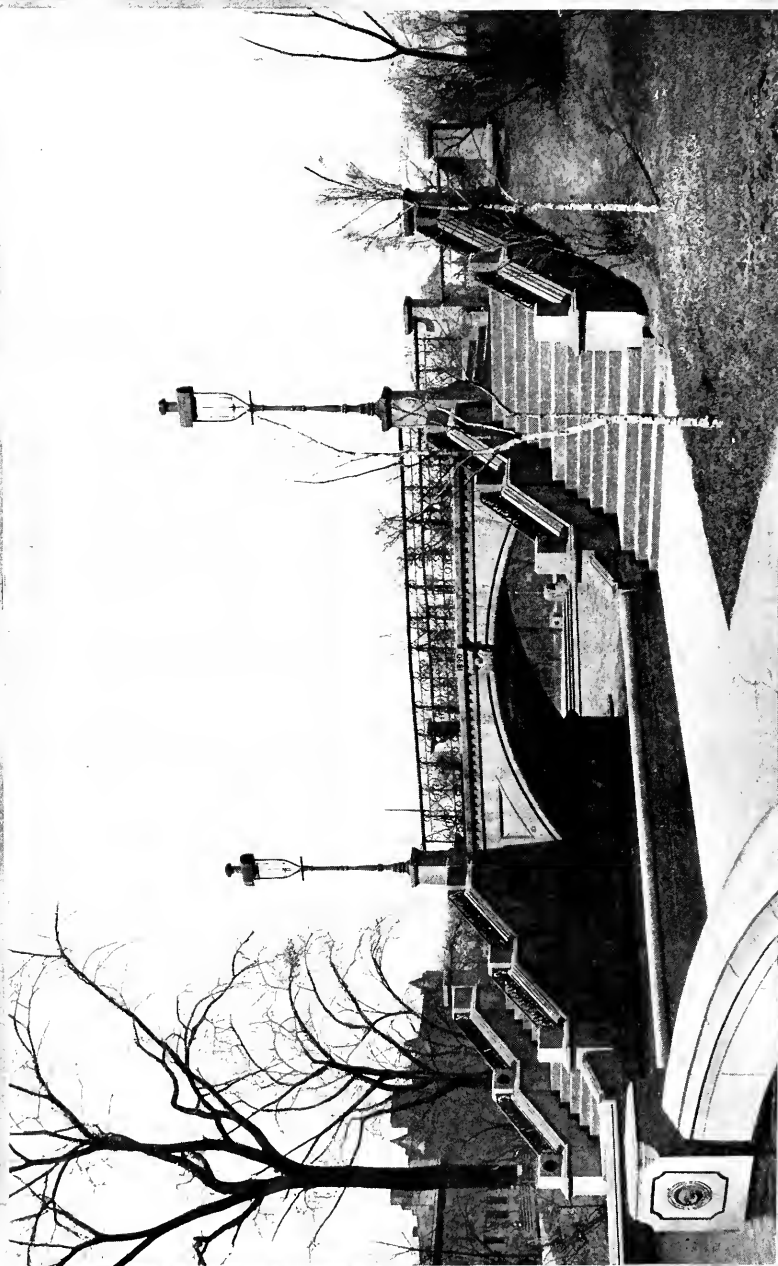

Fig. 171

FIGURE 171. Union Park, Chicago, Foot Bridge

Union Park, in Chicago, contains a fine example of an ornamental park bridge, the sides of which are a continuation of the wall enclosing the pond. It is apparently more of a decorative feature than for use, though it fulfils both conditions. It was built in 1890 and has ornamental lamps and railing, with urns containing growing plants and flowers in the summer time.

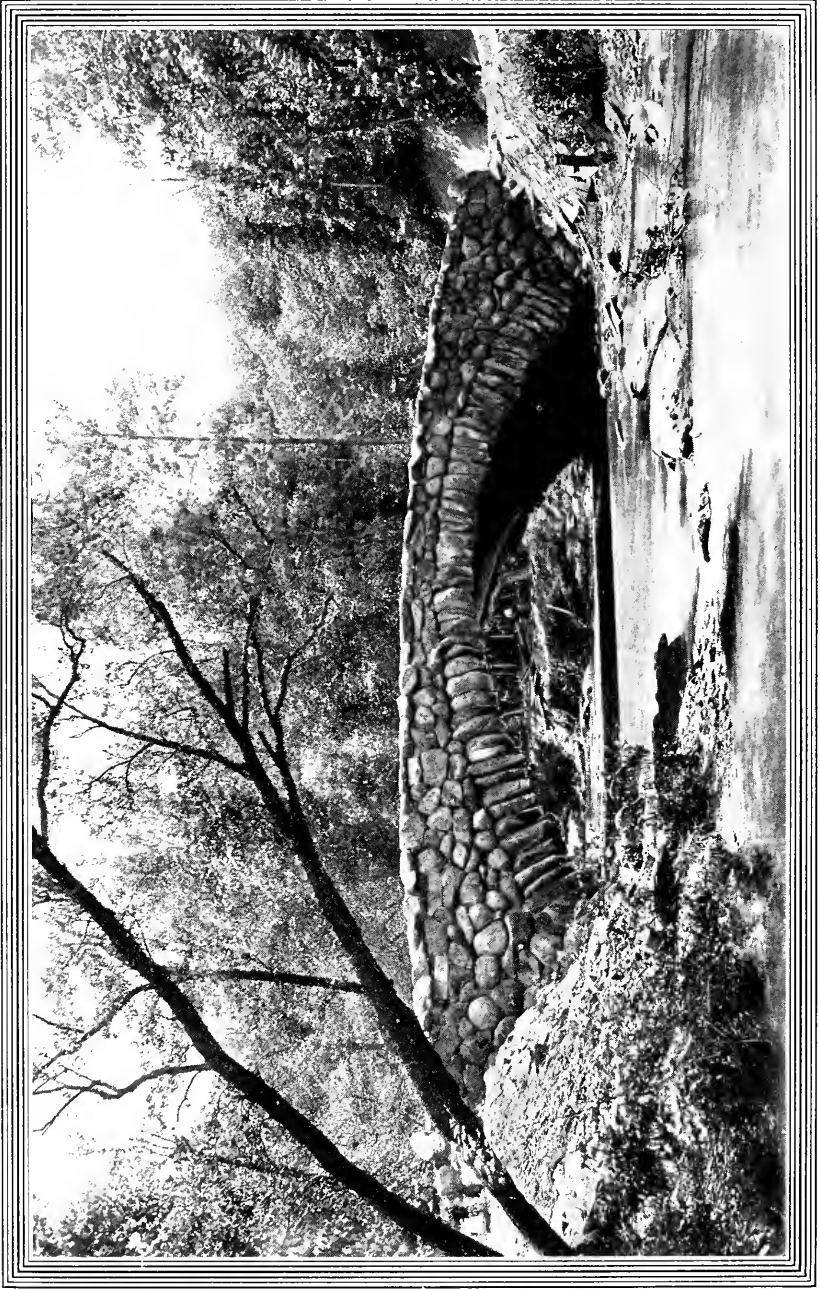

Fig. 172

FIGURE 172. Boulder Faced Arch, Washington

This is a segmental concrete arch of 80 ft. span, crossing Rock Creek. The rise of the arch is 15 ft., the clear roadway 23 ft., and total outside width is 27 ft. The body of the arch is concrete, reinforced with steel on the Melan system, and the face boulders of the arch project down 6 to 18 inches below the concrete arch soffit. It is located in a very beautiful part of the valley and is greatly admired. The total cost was \$15,000, and it was designed under the direction of Captain L. H. Beach, engineer commissioner of the District of Columbia, and built under his direction and that of his successor, Col. John Biddle, assisted by Captain H. C. Newcomer, and W. J. Douglas, bridge engineer.



Fig. 173



Fig. 174

FIGURE 173. Yellowstone Park Concrete Arch

The most desirable point at which to bridge the Yellowstone river in the National Park, was just below the Upper Falls, but as this location would, to some extent, obscure the falls, the site for the bridge was changed to a point above the Upper Falls of the Yellowstone, over the rapids. The bridge has a clear span of 120 ft., a total length of 160 ft., and a rise of 15 ft. The roadway at the center has a camber of $2\frac{1}{2}$ ft., and the clear width inside the railing is 15 ft. At the center the bridge floor is 43 ft. above the water.

FIGURE 174. Eden Park Bridge, Cincinnati, Ohio

Eden Park has a very handsome Melan arch with a span of 70 ft. and an extreme width of 33 ft. It was built in 1895 and crosses Park Ave., one of the main drives. It has an 18-ft. roadway and two walks of 5 ft. each. The rise of the arch is 10 ft. and the crown thickness is 15 inches, increasing to 48 inches at the springs. It is reinforced with 9-inch curved steel beams spaced 3 ft. apart. An effort was made to have the whole structure ornamental, for the soffit of the arch is paneled and the balustrade is rich in detail, with heavy mouldings and panels on the spandrels and abutments. It was designed and built by F. von Emperger for the sum of \$7,130. Bids for a stone bridge ran as high as \$12,000, and it is probable that the contract price did not include the entire cost of completion, for the original plans showed vases and other ornamentation which have not yet been provided.



Fig. 175



Fig. 176

FIGURES 175-176. Bridge at Hyde Park, on Hudson

A reinforced concrete arch carries the driveway over Crum Elbow Creek, with a clear span of 75 ft. The concrete railing is of fine design, with turned balusters, and the elliptical arch and curving wing walls give the whole a very artistic appearance.



Fig. 177

FIGURE 177. Como Park Foot Bridge, St. Paul

This bridge was built in 1903 to provide an entrance into Como Park for the passengers of the Twin City Rapid Transit Company. It has a clear span of 50 ft., with a 15-ft. roadway. A very neat structure was desired and, in order to avoid form marks, the surface of the centering was covered with metal lath and plaster, before placing the concrete. The length between abutment piers is 83 ft., and total width of arch 17 ft. 8 inches. The arch has a rise of 12 ft. 6 inches, and is 10 inches thick at the crown. Span openings over the spandrels and abutments are 12 ft., and the thickness of the skew back piers is 2 ft. In the concrete are five latticed steel Melan arch ribs.

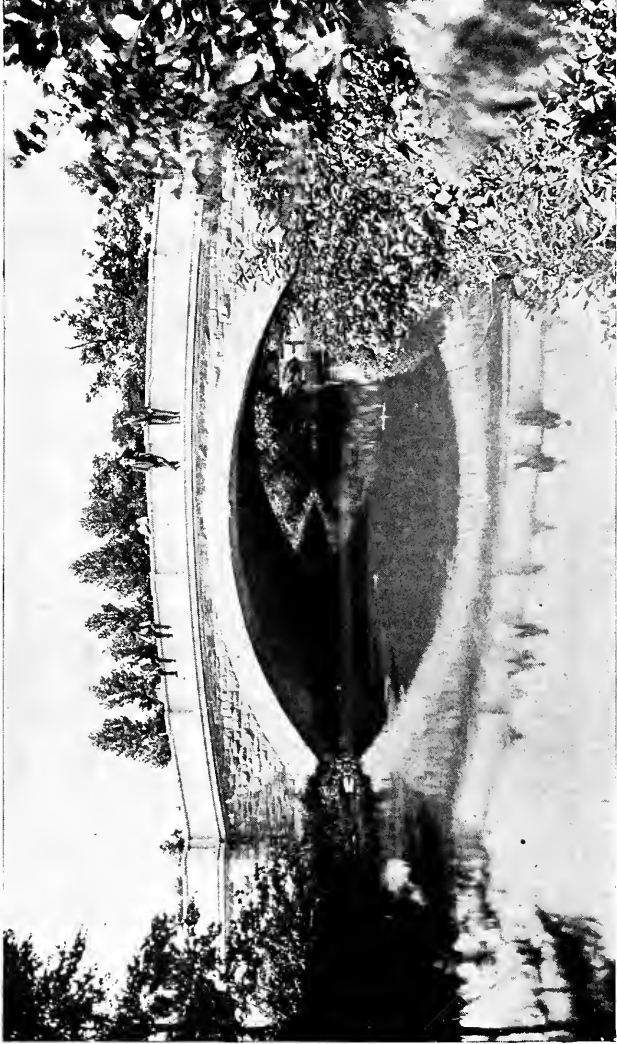

Fig. 178

FIGURE 178. Newell Avenue Bridge, New York

Located in the Botanical Gardens, this bridge has a clear span of 50 ft. and is faced with granite, though the body of the arch is of reinforced concrete on the Emperger system. The outlines, together with the varied kinds of surface finish and its setting in the foliage, produce a satisfying effect.

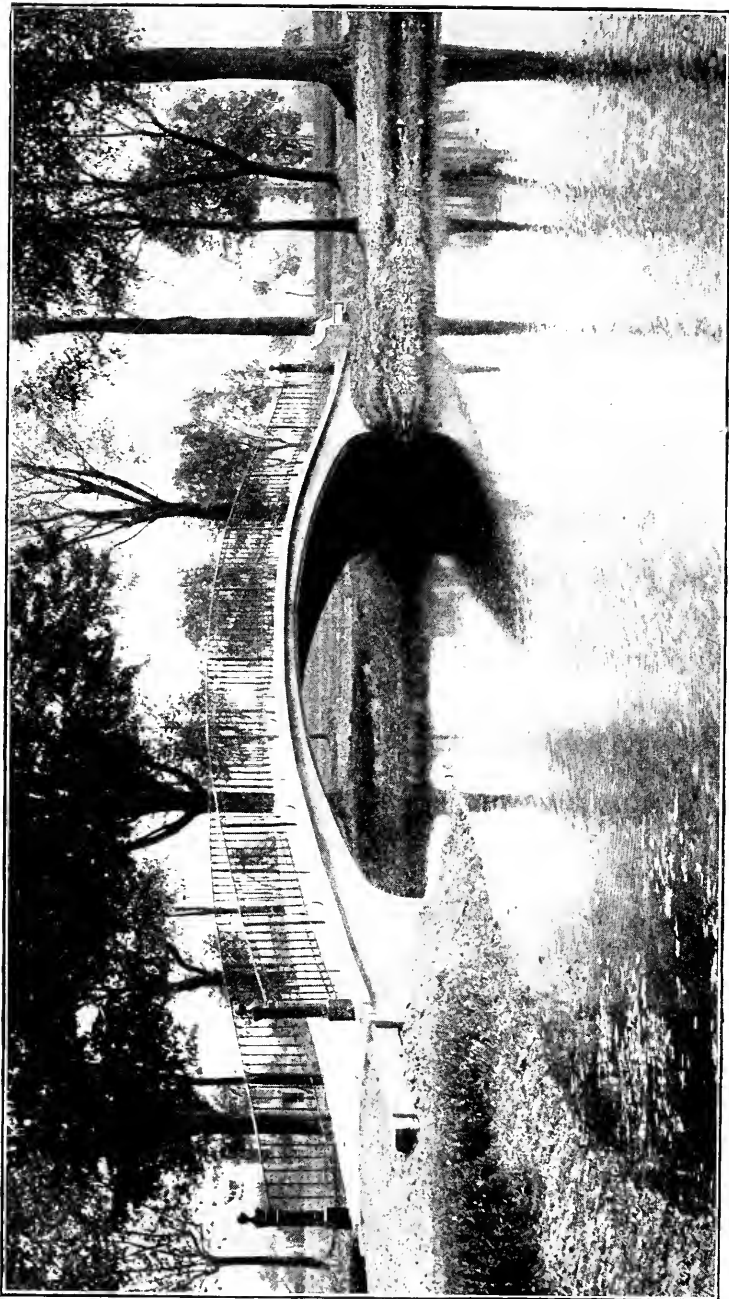

Fig. 179

FIGURE 179. South Bridge, Columbian Park, Lafayette

The foot bridge in Lafayette, shown here, has a clear span of 40 ft., and a rise of 4 ft., with a headroom underneath of 8 ft. It was designed in 1902 according to the Luten patents, and has a length of 56 ft. and a clear width of 6 ft. The crown thickness is 10 inches and the arch thrust is resisted by tension rods embedded in concrete beneath the water.

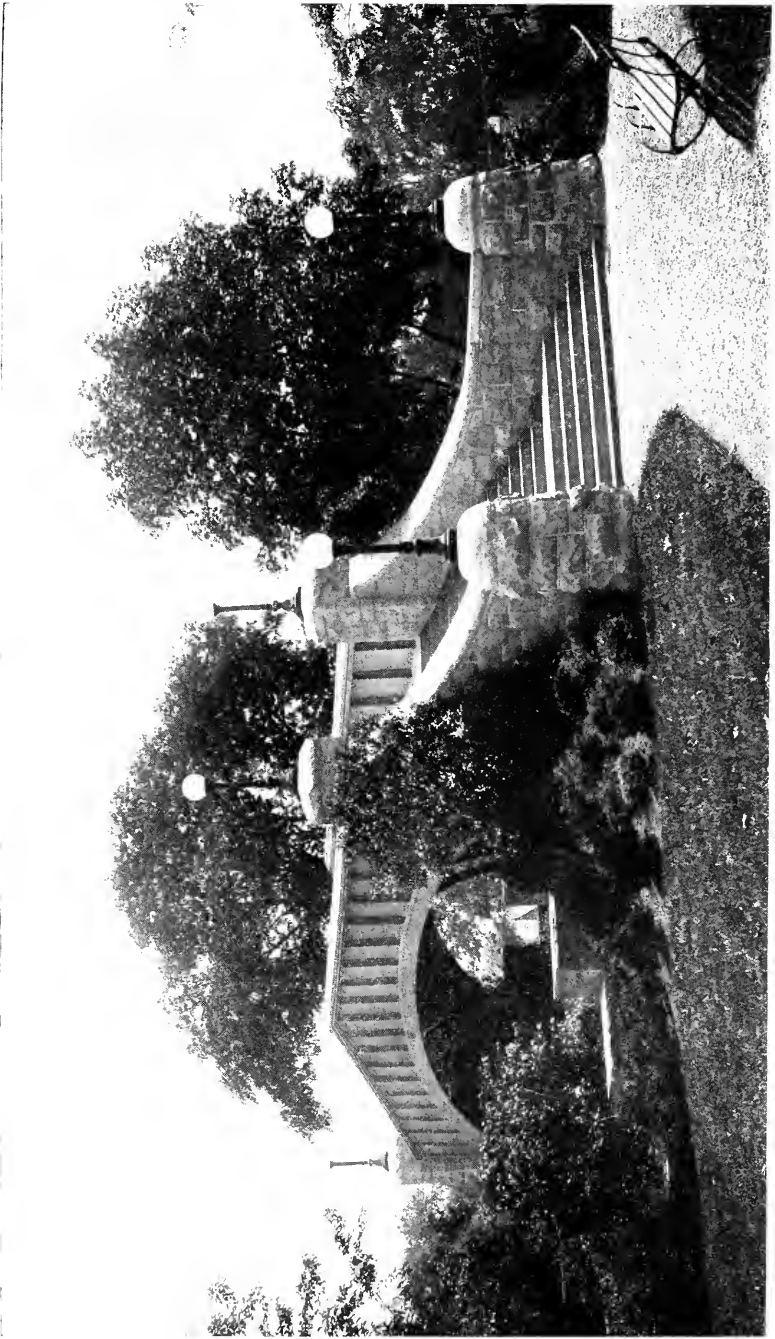

Fig. 180

FIGURE 180. Park Bridge, Madison, N. J.

Some critics have stated that a combination of two materials, such as steel and stone, in one structure, is offensive to the artistic sense, but this is disproven in the design of the park bridge at Madison, as well as in many others. The bridge spans two railroad tracks and has an opening of 50 ft., with a 10-ft. walk, and steps of stone and concrete leading up to the deck at each end. The object was to construct the center part of steel, and to produce the appearance of an arch mounted by a plate iron railing. To secure this effect, a thin fascia, 9 inches wide at the crown, increasing to 2 feet at the springs, was built on the lower external girder faces. The girders have ornamental cast-iron copings, and each of the stone piers is mounted with an electric globe. The whole is surrounded with shrubs and flowers, and altogether presents a very fine appearance. A full account of this bridge, with drawings, may be found in *The Engineer of London*, and in the *Engineering News of New York*, in 1900.

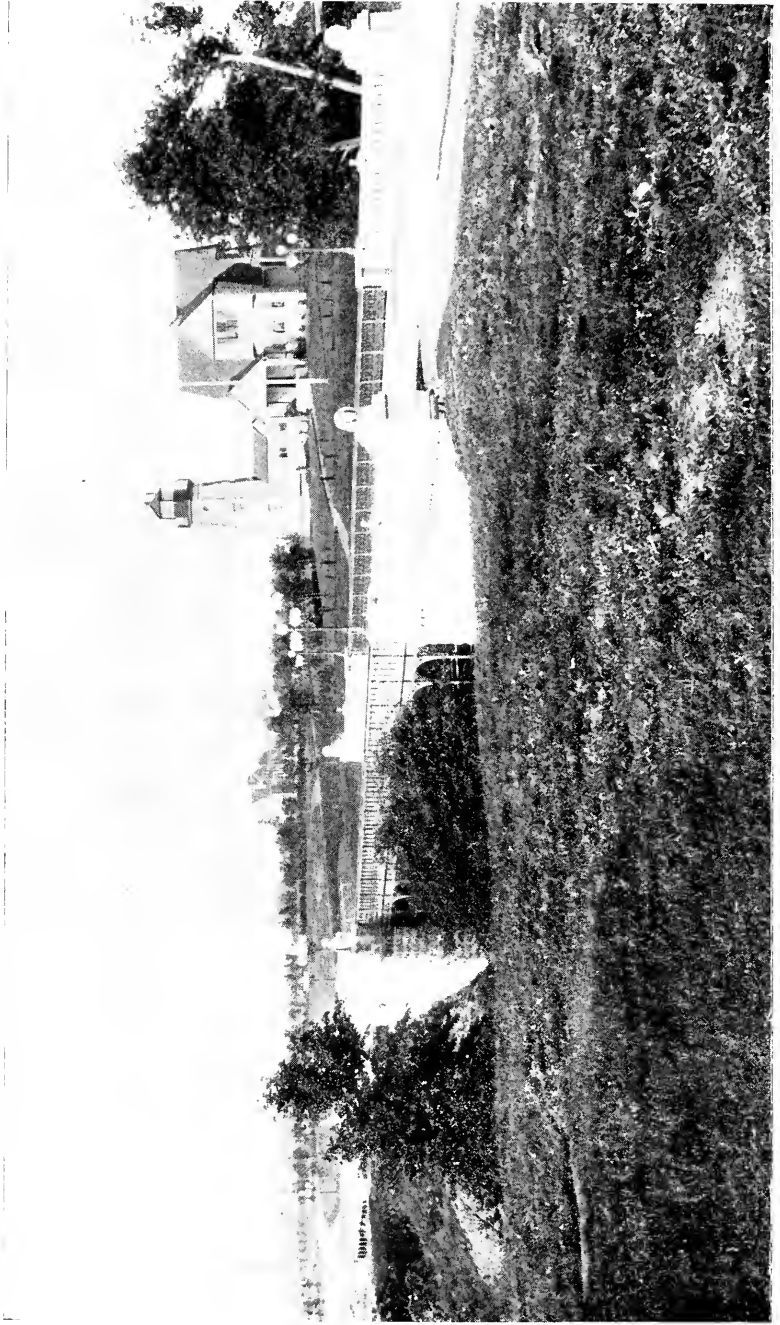

Fig. 181

FIGURE 181. Lion Bridges, Lake Park, Milwaukee

Spanning the North and South Ravines, near the Government lighthouse in Lake Park, Milwaukee, are twin bridges of artistic design. Each bridge has a span of 87 feet, and the total cost of both was \$36,500. They were designed by Oscar Sanne, and built during the year 1897. Each bridge has six two-hinged steel ribs, supporting a floor of beams and buckle plates, with asphalt roadways and cement sidewalks. The abutments are of fine coursed ashlar, surmounted with a Bedford stone railing. Over the arches the railing is of ornamental iron and steel, while at the ends are ornamental lamp posts supporting clusters, and further decorated with figures of reclining lions on pedestals.

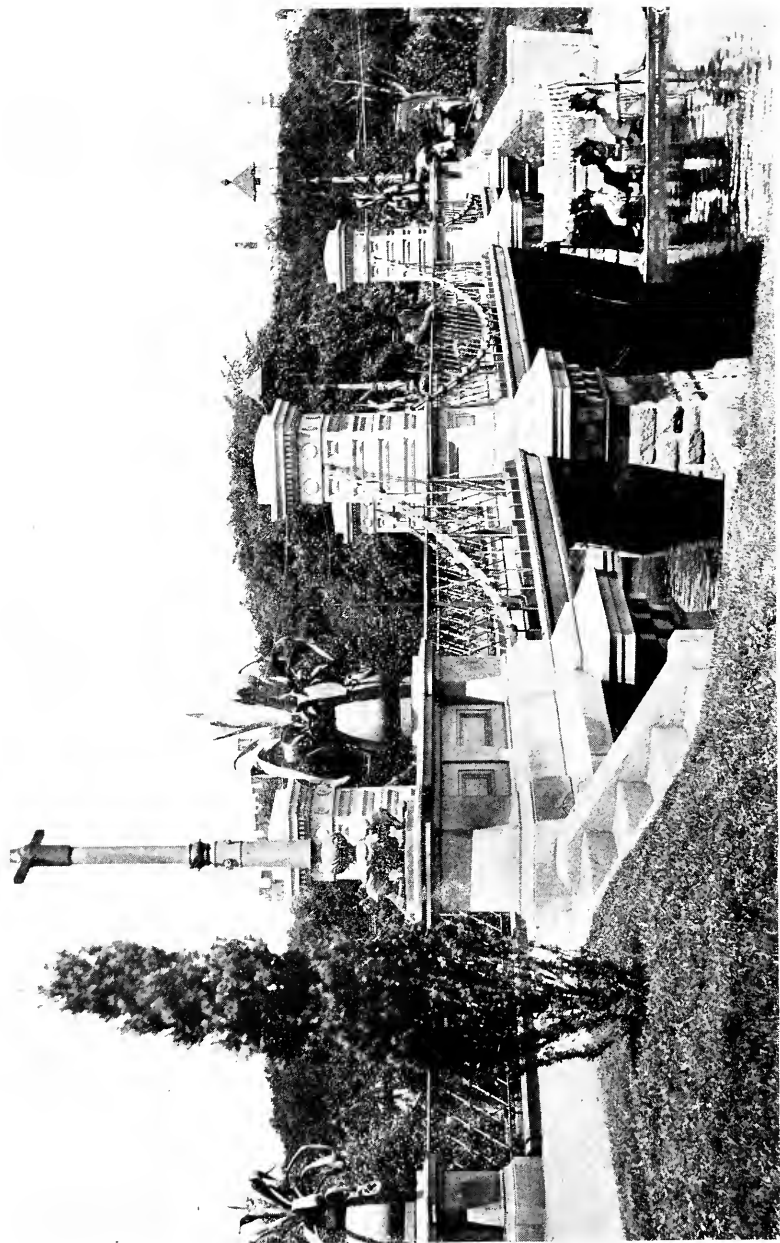

Fig. 182

FIGURE 182. Bridge in Boston Public Gardens

A sight which is very familiar to New England people is the beautiful little suspension bridge in the Boston Public Gardens. It is difficult to say whether the bridge in itself, or its beautiful surroundings, are the more attractive. The graceful curves of the cables, passing over ornamental stone towers, together with the stairways and electric lamps at either end, make it a most attractive feature of the Garden. In the summer the bridge is surrounded with a great variety of plants and flowers, and is perhaps seen and appreciated by more people than any other work of a similar nature in the district. The lake which the bridge crosses is a favorite resort for pleasure-seekers, and seats near the water edge beneath the trees form a shady retreat for pedestrians in the hot days of summer.



Fig. 183

FIGURE 183. Garfield Park Suspension, Chicago

It is difficult to say which of the two bridges in Garfield Park is the more attractive in design, the stone arch or the suspension. The two types of construction add varied features to this beautiful city park.

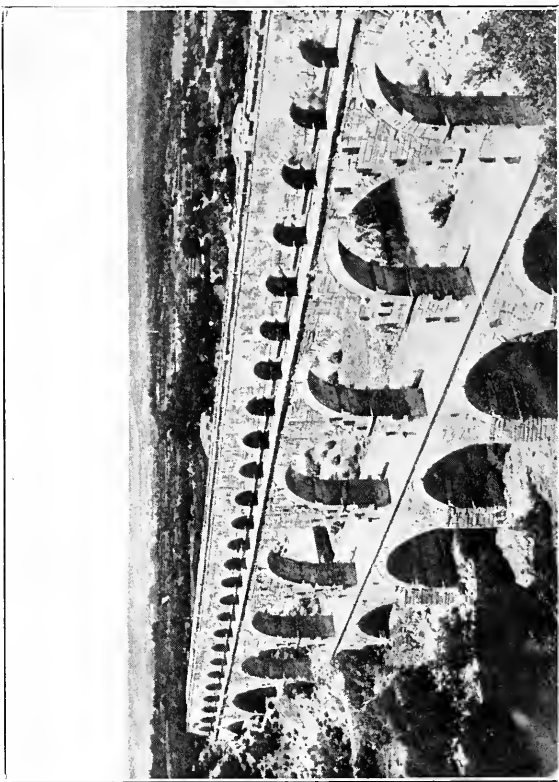

Fig. 184

FIGURE 184. Pont-du-Gard, at Nimes, France

This old Roman aqueduct was built in the year 19 B. C., to supply water to the city of Nimes, a place which has many remains of Roman civilization. It was built during the reign of Emperor Augustus, probably under the direction of Agrippa. There are three stories, the lower one containing six arches and the second story eleven arches of the same span, while the upper or third has thirty-six smaller arch openings supporting the water duct. The total length of the upper tier is 885 feet and its greatest height above water is 160 feet. In the year 1743 extensive repairs were made, and the lower tier of arches was widened enough to carry a roadway on one side, so the present structure serves the double purpose of aqueduct and bridge, the length of roadway being 465 feet. The lower arcade was originally made of four separate rings side by side and not bonded together, and the second tier of three smaller rings, the original width of the lower being 20 feet 9 inches, and the second and third tiers 15 feet and 11 feet 9 inches respectively. The largest central arch over the Garden River has a clear span of 80 feet 5 inches, while the adjoining ones on either side vary from 51 to 63 feet. The smaller arches in the top story have a uniform length of 15 feet 9 inches, and all arches are semi-circular. The structure carries a single waterway 4 feet wide and 4 feet 9 inches high, and is built of cut stones tied together with iron clamps without cement excepting in the water channel on top. It is said to have been partly destroyed by the barbarians in the fifth century, but was soon repaired.

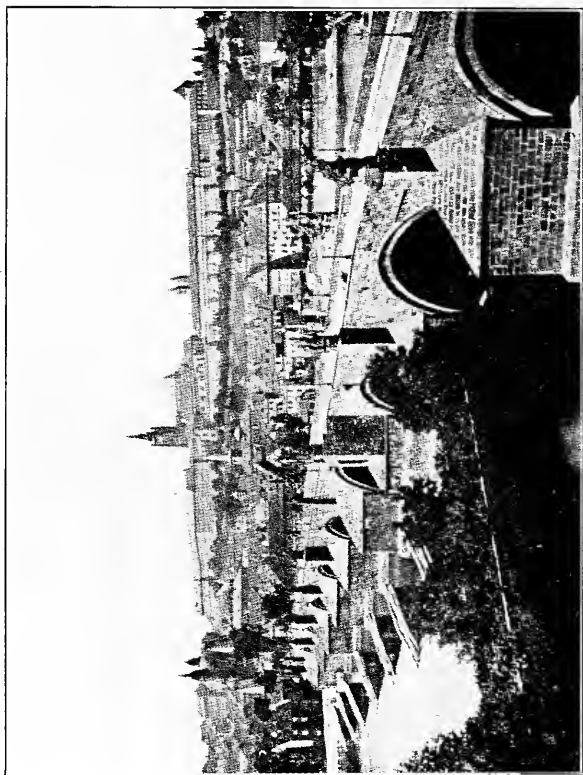

Fig. 185

FIGURE 185. Karlsbrucke over the Moldau at Prague

Begun in 1348 by Emperor Charles IV, this bridge was not completed until 1507. There are sixteen spans, and over the piers on either side are thirty statues and groups of saints. The total length of the bridge is 1,855 feet, and at the ends are gate towers with unsymmetrical roofs. Notwithstanding the unusually heavy piers and ice-breakers, the bridge was seriously damaged by floods in 1890, but has since been repaired. The large bronze statue was erected to the memory of St. John Nepomuc, patron saint of Bohemia, to visit which thousands of pilgrims annually come. It is said that St. John had received confidential information from the Empress, and upon refusing to betray these secrets, the Emperor caused him to be thrown from the bridge and drowned. The statue to his memory was therefore placed so that it might overlook the scene of his death. It is related further that Ferdinand II, after defeating the Protestant King of Bohemia in the battle of White Mountain, near Prague, in 1620, caused twenty-seven Bohemian noblemen to be beheaded and their heads hung in iron cages from the tower.

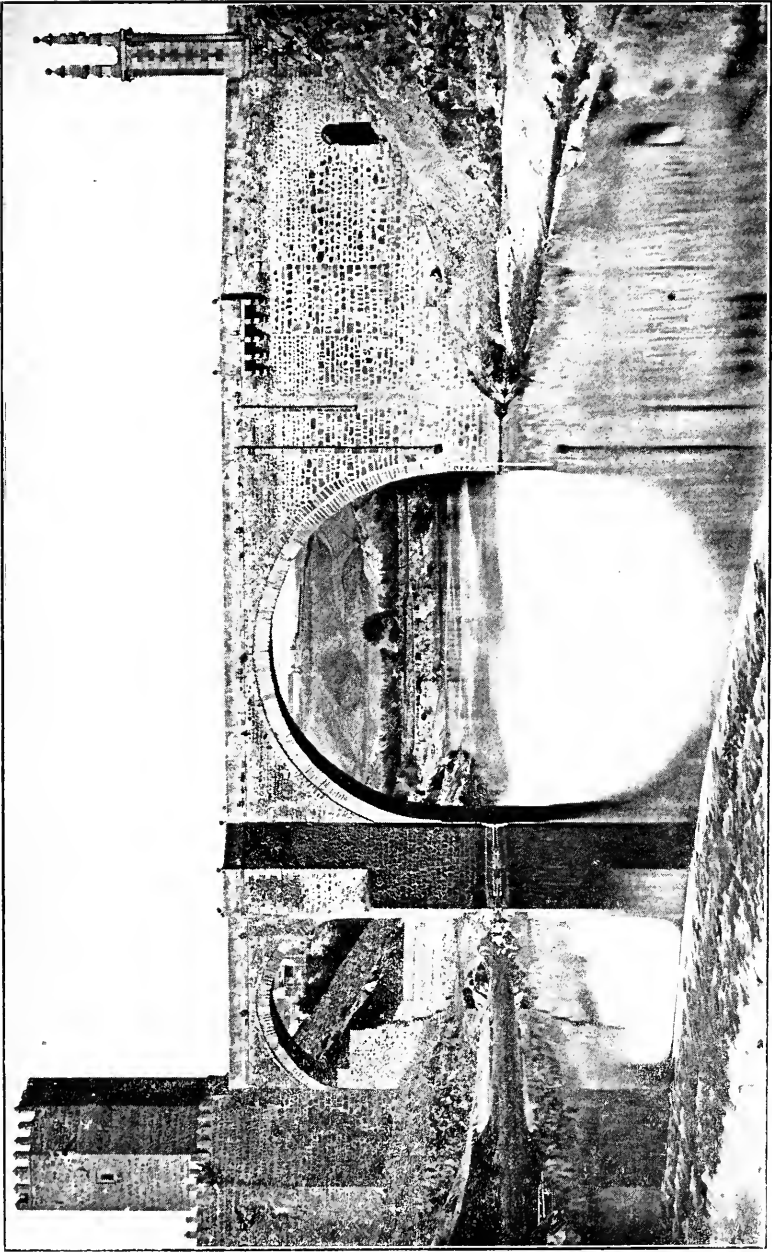

Fig. 186

FIGURE 186. Bridge of Alcantara at Toledo

Several fine old bridges at Toledo, Spain, still remain after the lapse of many centuries. The one illustrated dates from 997 A. D., and is still in good condition. The arches have spans of 93 and 52 feet and are semi-circular, indicating Roman origin. Of the two portal towers, the left one with battlements seems to symbolize strength and defence, while the other one is lighter and more highly ornamented. The small Moorish arch and many other features are quite unexplainable in this age. Two retreats are bracketed out on each side of the long abutment, and above the triangular cutwaters are two other retreats.

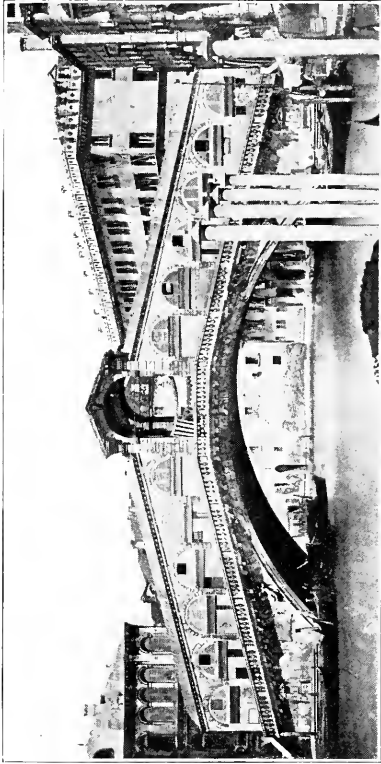

Fig. 187

FIGURE 187. The Rialto, Venice

A bridge which is perhaps more widely known than any other is the Rialto at Venice. It crosses the Grand Canal and was built during the years 1588 to 1591, from designs by Antonio da Ponte, though other designs are said to have been prepared for it by Michael Angelo and Palladio. Referring to the former, the *Encyclopædia Britannica* says: "Erroneous statements are often made that this bridge was built from a design by Michael Angelo. The mistake has arisen from the misinterpretation of a passage in the works of Vasari." The bridge has a clear span of about 95 feet with a rise of 25 feet, a total length of 158 feet and width of 72 feet. On the roadway are two rows of shops with a passageway between them. There are six shops in each row on each side of the center, or twenty-four in all. In the middle of the bridge is an open passage connecting the roadway with the walks, the whole arrangement forming an arcade. The regular footways are on the outside and are carried on projecting brackets. As the grade of the floor is quite steep, the walks are provided with marble steps, and are enclosed with ornamental balustrades of beautiful design. The arch ring and spandrels are ornamented on the face with figures of angels, and there are tablets with inscriptions. The form of the arch is segmental, being about one-third of a circle, and the material is white marble. Steps at either end of the bridge lead up from the foot walks along the canal, and the arrangement of arches on the rising grade, together with the central passageway and arch above it, present a general effect of beauty and harmony.



Fig. 188

FIGURE 188. London Bridge

The present London Bridge was constructed during the years 1821 to 1830, and replaced the old one that was lined with shops and houses. The bridge is a fine example of the highest class of stone arch construction. It has five elliptical arches, the center one being 152 feet long, the two adjoining ones 140 feet, and the end ones 130 feet. The face work is of granite. Its entire length is 928 feet, and it is estimated that 120,000 foot passengers and 25,000 vehicles cross it daily. The design was prepared by the elder John Rennie, and it was constructed under the direction of his sons, John and George Rennie. The cost was 425,000 pounds sterling. During the years 1902 to 1905, the original width of 54 feet was increased by 11 feet, at an additional cost of \$500,000, under the direction of E. Cruttwell and Sir Benjamin Baker, engineers.

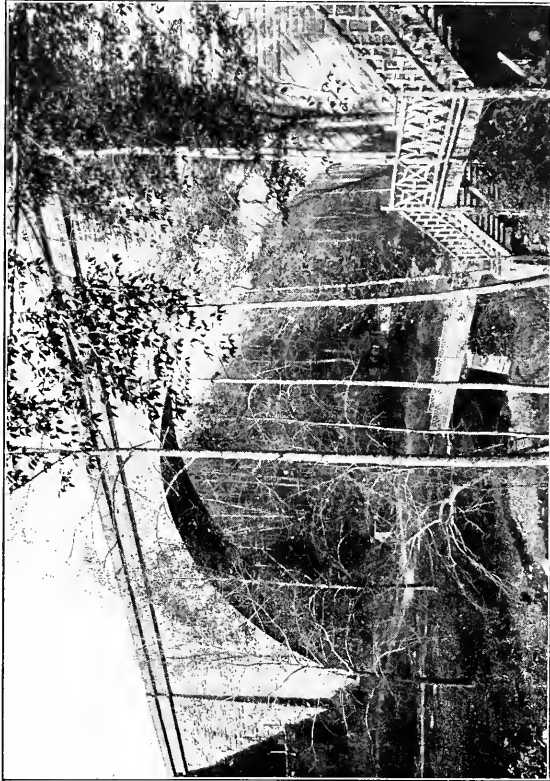

Fig. 189

FIGURE 189. Cabin John Bridge, Washington

For many years Cabin John Bridge, spanning Rock Creek at Washington, held the record for being the longest stone arch, though it has since been exceeded by those at Luxemburg, 278 feet; at Plauen, 295 feet; and Salcano. There are also several concrete bridges either completed or under construction with longer spans. This bridge carries a road and the aqueduct for the city of Washington, and was built under the direction of Gen. M. C. Meigs, during 1857 to 1864. The span is 220 feet, rise 57 feet, and the center crown radius 134 feet, the roadway being 101 feet above the water. The material of the arch ring is granite, with spandrels of sandstone, the ring being 4 feet deep at the crown and 6 feet at the springs. Backing for some distance beyond the arch ring is laid with radial joints, thus adding greatly to its strength. The arch is a segment of 110 degrees and the entire work is very simple in character. The bridge has a total width over parapets of 20 feet, and the flatness of the face is relieved by two projecting courses.

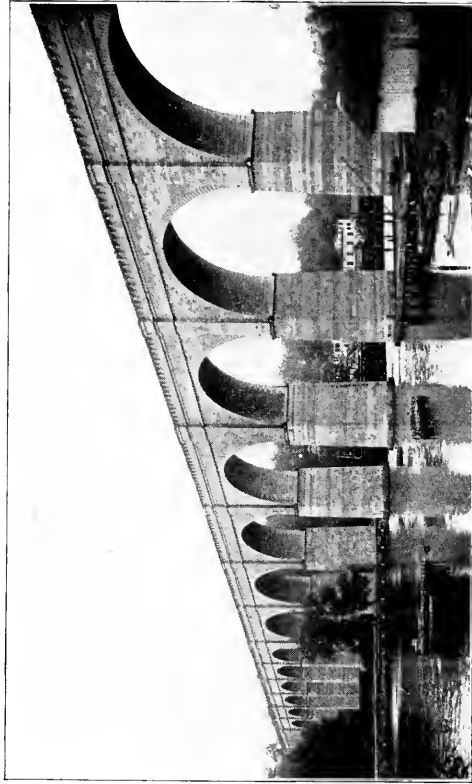

Fig. 190

FIGURE 190. Croton Aqueduct Bridge (High Bridge), New York City

The Manhattan water supply is brought into the city in pipes carried on a series of arches known as High Bridge. At high water the Harlem River has a width of 620 feet, and the demands of navigation made it imperative to provide a clear headroom of 100 feet beneath the bridge, with openings not less than 80 feet in width. There are, therefore, over the water, eight spans of 80 feet each, with six spans of 50 feet at the end next the mainland, and one of 30 feet at Manhattan Island. The total length is 1,460 feet and the height above high water is 116 feet. The width over parapets is 21 feet, and the faces of spandrels and piers batter out on each side at the rate of one inch in 4 feet. It originally carried only two lines of cast-iron water pipe 36 inches in diameter, but a third pipe 90 inches in diameter was added later. The deck carries a driveway and two walks, which are guarded by light but ornamental railings. Above the arches are ornamental belt courses and a coping on corbels, and at the piers are pilasters extending from the springs to the coping, the whole presenting a very satisfactory effect. It was designed under the direction of John B. Jervis, Chief Engineer of the Croton Aqueduct, and built during the years 1837 to 1842, at a cost of \$737,800.

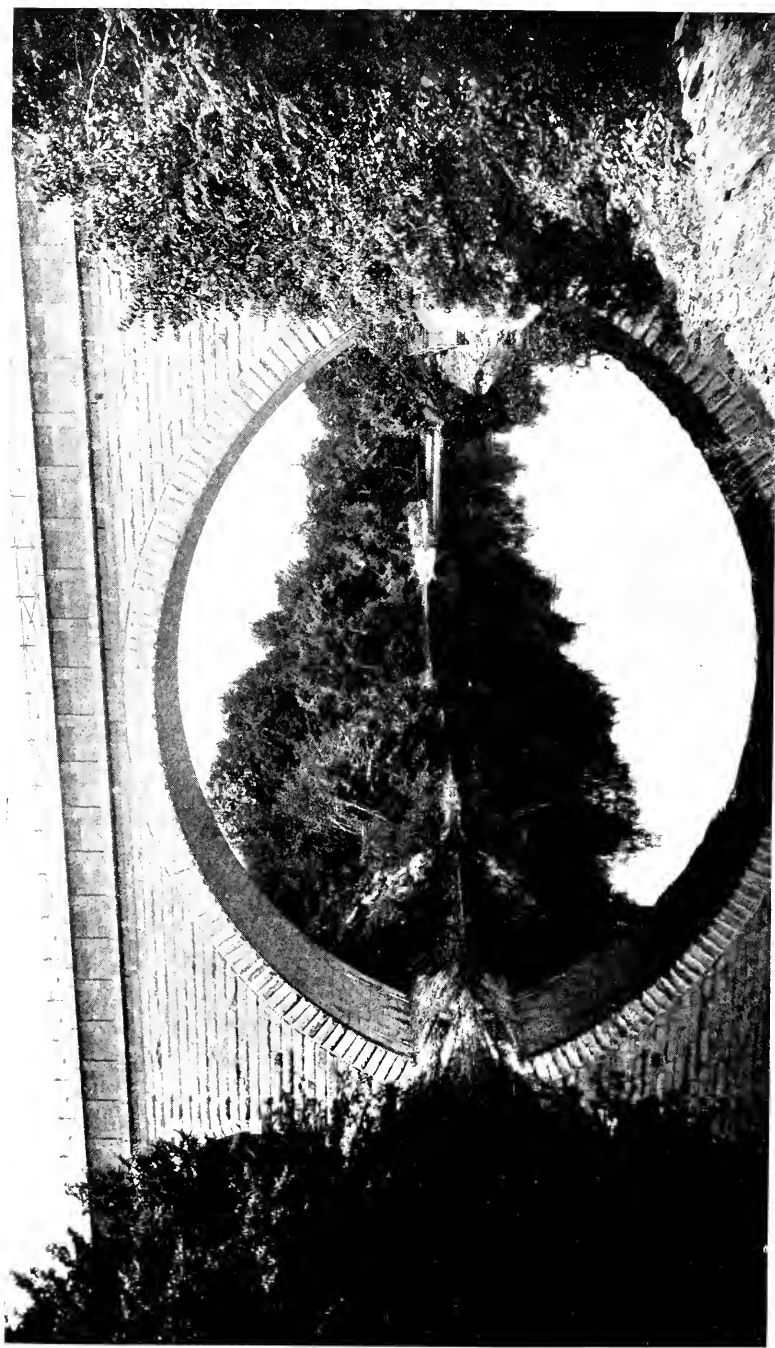

Fig. 191

FIGURE 191. Echo Bridge, Newton

This stone bridge was built in 1876, under the direction of Chief Engineer Fitzgerald, by the Boston Water Commission, to carry a conduit across the Charles River. It has one span of 129 feet and 42 feet rise, one span of 34 feet, and four of 37 feet, the coping being 78 feet above the river. It is within the Metropolitan Park System and is a familiar sight to Boston residents, especially in the summer season. The illustration shows the details of the largest span, the smaller ones being at one end. When the whole bridge is seen, its unsymmetrical arrangement is not pleasing, but the smaller spans are so obscured by foliage that the large arch, only, is evident.

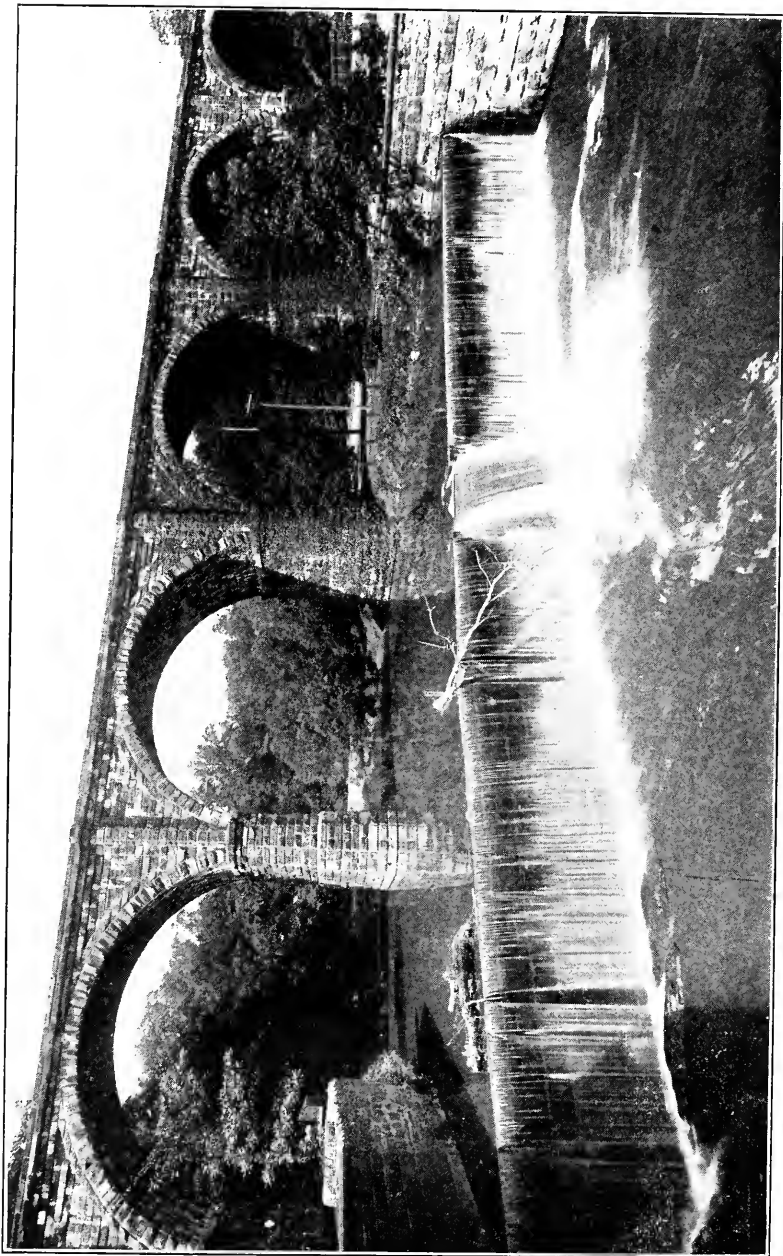

Fig. 192

FIGURE 192. Wissahickon Railroad Bridge

Prominently situated, crossing over Wissahickon Creek where it flows into the Schuylkill River, is the Philadelphia and Reading railroad bridge, which can be seen for a distance of a mile or more up and down the river and from either bank. It was erected in 1881, from the designs of C. W. Buchholz, Chief Engineer for the railroad company. There are five spans of 70 feet each, and 23 feet rise, the thickness of arch rings being 3 feet, and pier thickness at springs $9\frac{1}{2}$ feet. The width of the bridge is 28 feet for two tracks, while the total length, including the four 10-foot arches, two in each abutment, is 510 feet. The deck is 80 feet above the drive beneath it and 103 feet above the foundations. It contains 15,400 cubic yards of Talcose slate masonry, and cost \$275,000. The valley crossed is a part of the Fairmount Park system.



Fig. 193

FIGURE 193. Interlaken Bridge, Minneapolis

Spanning two lines of electric car tracks, with clear opening of 38 feet and side walls 82 feet long, is this bridge built for the Board of Park Commissioners of Minneapolis. It supports a 40-foot roadway with a 10-foot walk at one side and a 10-foot bicycle path at the other, making an extreme width of 63 feet. The arch ring of the face walls and the skewbacks and copings are of Kettle River sandstone, but all other face work is blue limestone. The body of the arch is the Melan system of concrete steel construction. It is the work of W. S. Hewett, contractor, and Harry Jones, architect.

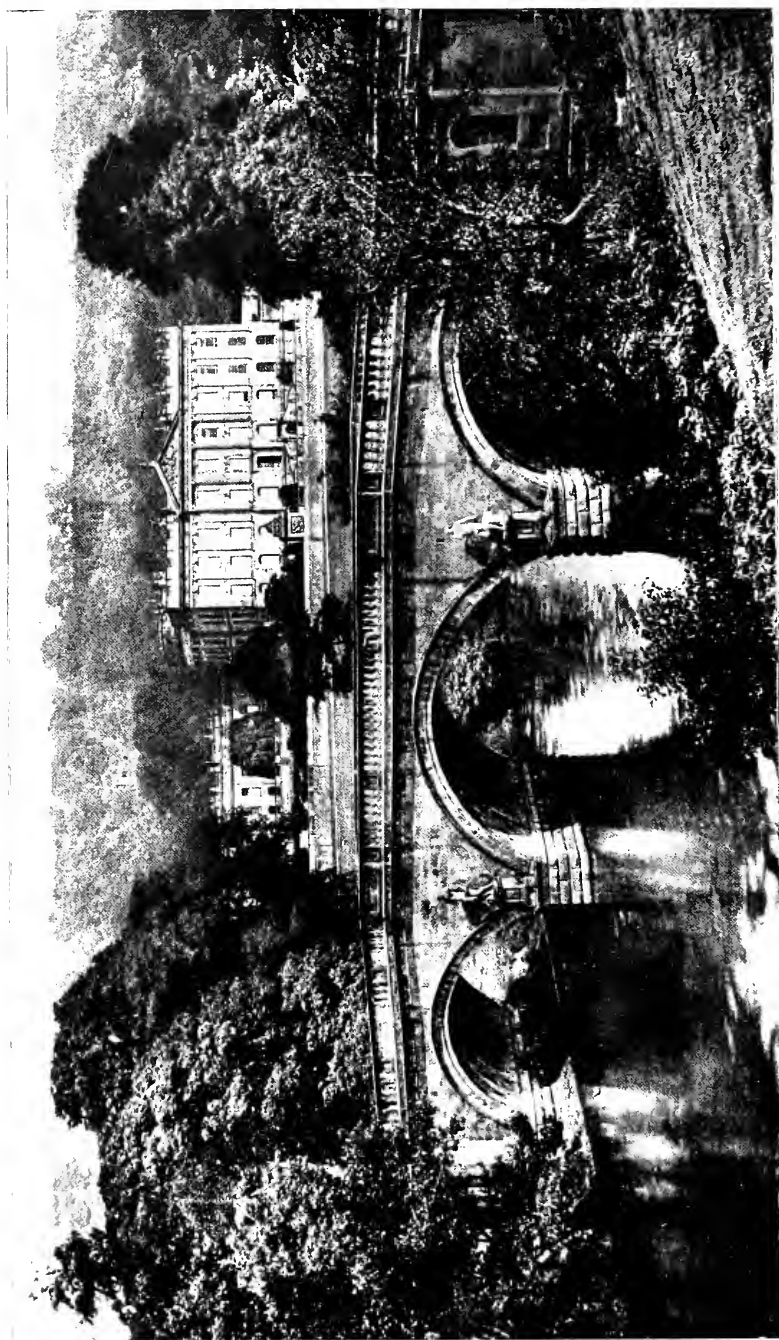
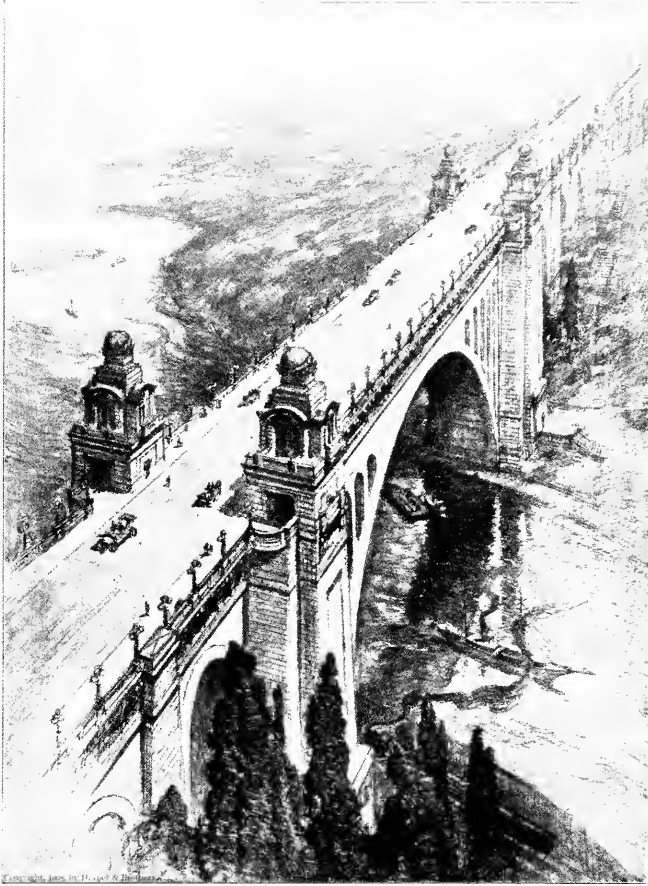

Fig. 104

FIGURE 194. Chatsworth Bridge

This bridge is located on one of the private estates of England, with statues on the piers above the water.



The accepted design for The Hudson Memorial Bridge
1908 Whitney Warren architect.



Fig. 195

FIGURE 195. Proposed Hudson Memorial Bridge

It has been proposed to erect on an extension of Riverside Drive in New York City a memorial bridge over Spuyten Duyvil Creek, to commemorate the discoveries and explorations of Henry Hudson. The design accepted by the Municipal Art Commission of New York is illustrated. Several others of great merit were prepared and submitted, the reason for their rejection being that all in steel were unsuited for a great memorial. In this design there would be one span with a clear span of 703 feet, and seven other semi-circular spans with clear lengths of 108 feet, the total length of the structure being 2,840 feet. The main arch span has a rise of 177 feet, and is to contain a large amount of steel, used not as concrete reinforcement ordinarily is to resist tensile stresses, but rather to assist in resisting the compressive stresses and thereby reduce the amount of masonry. The arch with crown thickness of 15 feet is to support two decks, the upper one with a 50-foot roadway and two 15-foot walks, and the lower one 70 feet wide for four lines of electric railway, though it is intended to omit the construction of the lower deck when first building. The design provides for a clear headroom of 183 feet under the main arch. The principal piers are to be 180 feet wide, and the estimated cost of the whole structure is \$3,800,000. The design was prepared by the Bridge Department of the City of New York, C. M. Ingersol, Chief Engineer, L. S. Moisseiff, engineer in charge, Wm. H. Burr, consulting engineer, and Whitney Warren, architect.



Fig. 196

FIGURE 196. Walnut Lane Bridge, Philadelphia

Over this bridge Walnut Lane crosses the Wissahickon valley at a height of 147 feet above the river bed, connecting Roxborough and Germantown, two residential suburbs of Philadelphia. When first completed it was the largest concrete bridge, having a clear span of 233 feet. It consists of two separate arch rings, 18 feet wide at the crown, increasing to $21\frac{1}{2}$ feet at the springs, and at the crown the rings are separated by a space of 16 feet. The main arch is an approximate ellipse with a rise of 73 feet, and carries ten cross-walls which support the floor system, but there are also five semi-circular approach arches with clear spans of 53 feet. The roadway is 40 feet wide, with a 10-foot walk at each side. The whole structure is of solid concrete reinforced only in minor parts. The surface finish is rough, somewhat similar to pebble dash, but of coarser grain, and the exposed surface shows stone chips of not over $\frac{3}{8}$ inch size, formed by washing before the cement was hardened. The total length of bridge over all is 585 feet, and cost \$259,000. George S. Webster was Chief Engineer and Henry H. Quimby, Bridge Engineer.

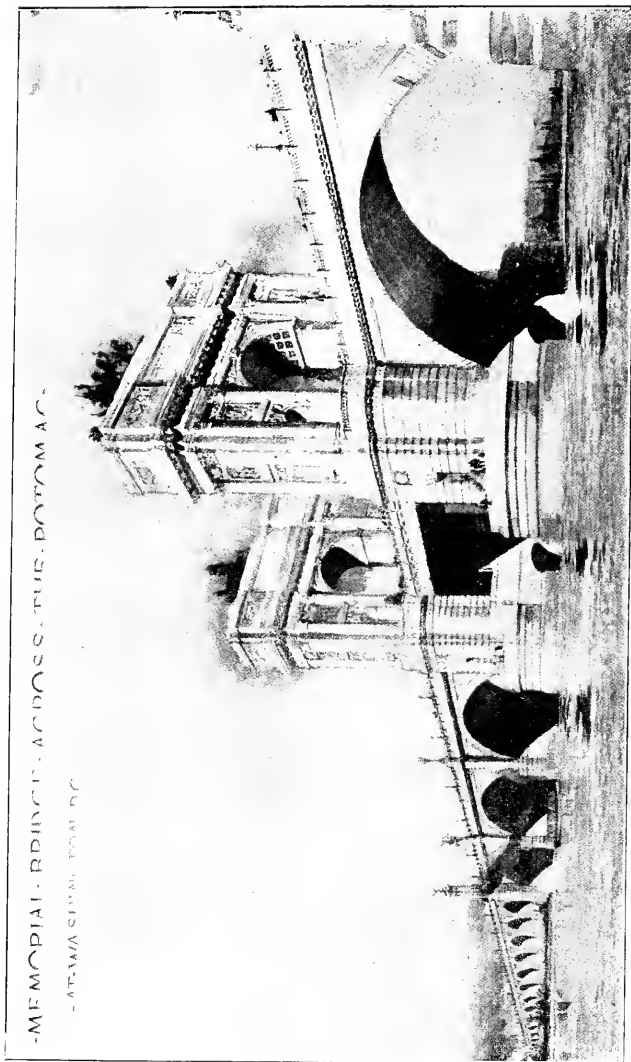

Fig. 197

FIGURE 197. Proposed Potomac Memorial Bridge No. 2

On this design there is but one deck, with no provision for car tracks. It is 60 feet wide and the total length of open bridge is 3,400 feet. In the central part are six segmental masonry arches, 192 feet in clear length, with a double leaf bascule draw of 170 feet in the center. The Washington approach has twelve semicircular masonry arches of 60 foot span and 550 feet of embankment, and the Arlington approach fifteen similar spans and 1,350 feet of embankment. All work is granite faced, with reinforced concrete body, and the estimated cost is \$3,680,000.

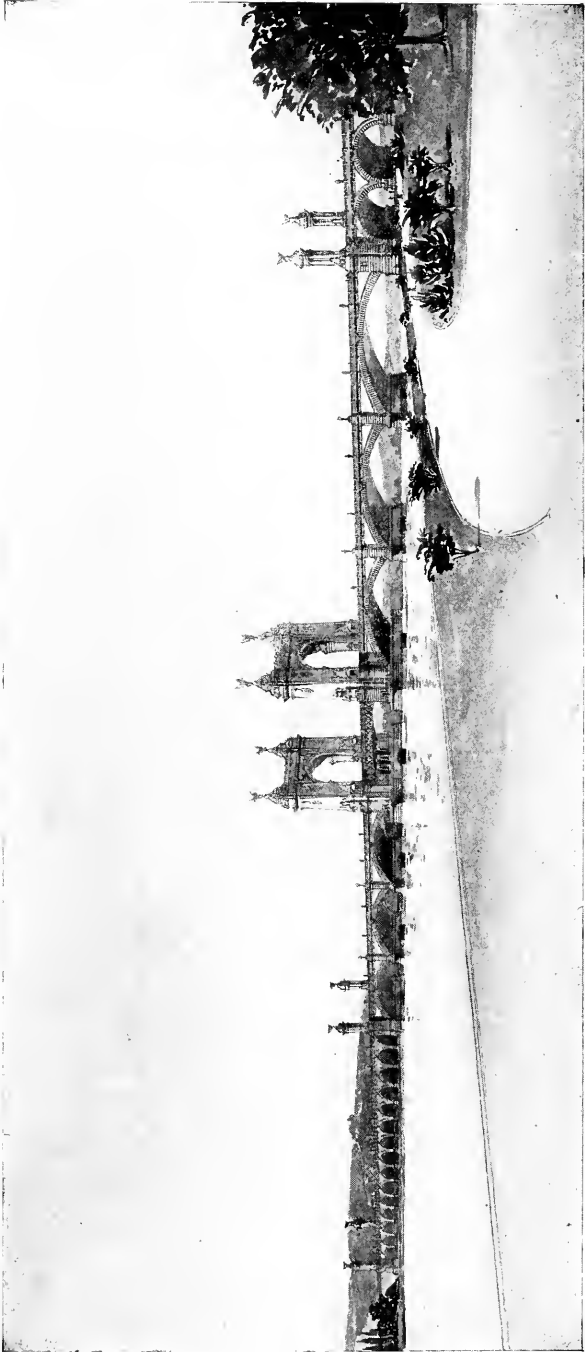

Fig. 198

**FIGURE 198. Proposed Potomac Memorial Bridge, Washington, D. C.
Washington, D. C.**

This is a modification of Mr. Burr's plan No. 2 (Fig. 197) for a bridge over the Potomac river at Washington, with the central towers of his Plan No. 1 substituted for those previously shown. In all other respects the plan is identically the same as that shown in Fig. 197, and is the design as finally accepted.

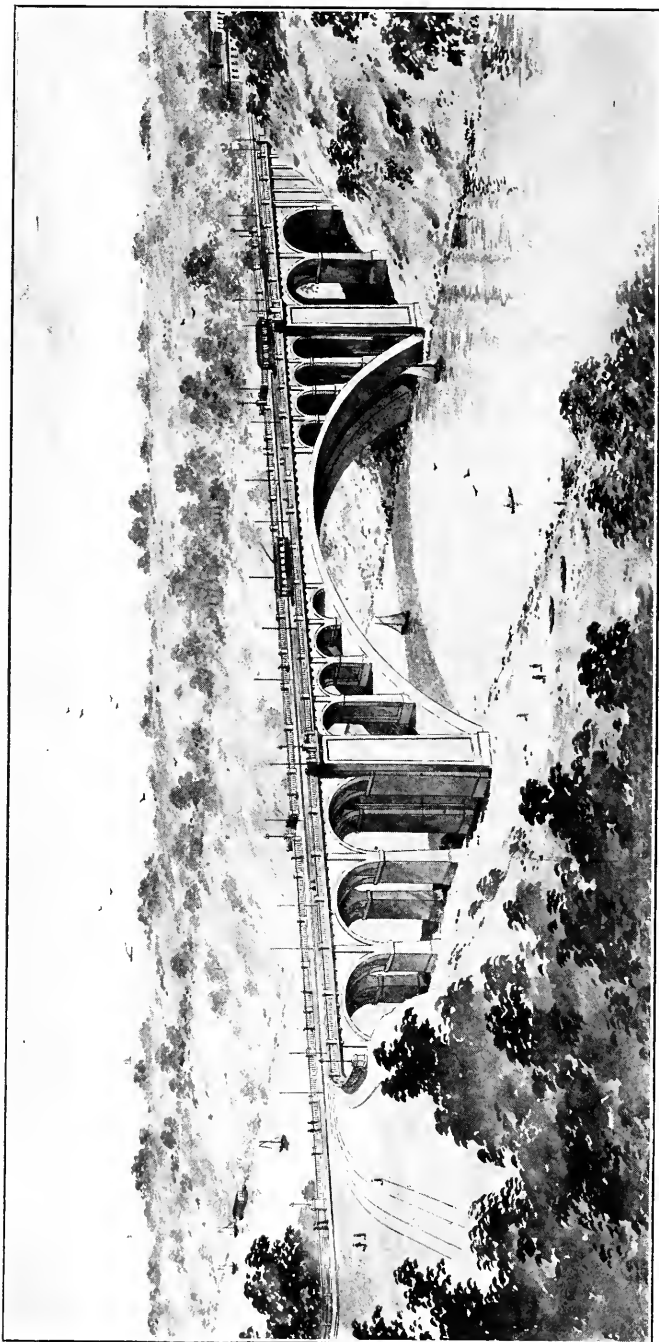

Fig. 199

FIGURE 199. Rocky River Bridge, Cleveland

One of the largest masonry spans in America is over Rocky River on Detroit Avenue, at Cleveland, Ohio. The central span is 280 feet and the five terminal spans are 44 feet each, making a total length of 780 feet. The width over railings is 60 feet, the roadway being 40 feet and the two sidewalks 8 feet each. The main span consists of two separate arch rings 18 feet wide at the crown and 16 feet apart, by which the deck is carried on cross spandrel walls. The roadway is 94 feet above low water, and the pavement is of brick with two lines of track for heavy suburban cars. Beneath the floor are two subway chambers 3 by 11 feet, for pipes and wires. The main arch rings contain no steel reinforcing, as calculations showed that tension cannot occur in any part of the arch. The sidewalks project about 5 feet over the face walls, and are supported on brackets. The whole structure is of concrete and is quite similar to, and 47 feet longer than, the Walnut Lane bridge.

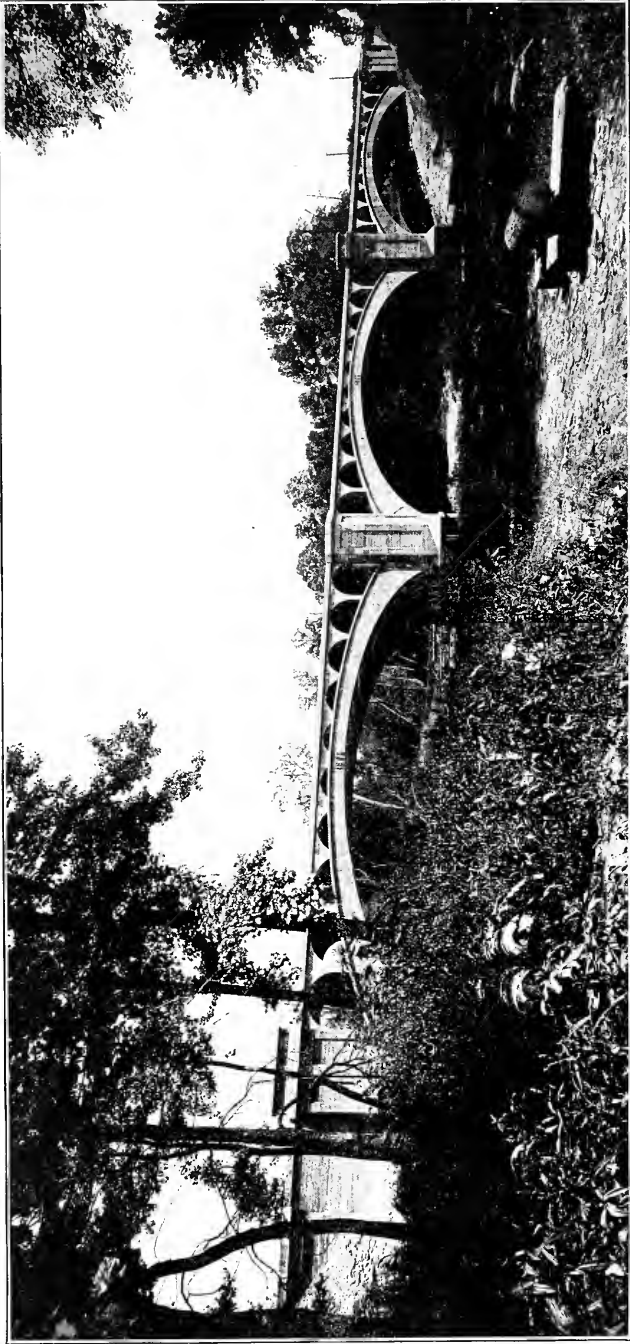

Fig. 200

FIGURE 200. Big Muddy River Bridge

The Big Muddy River bridge at Grand Tower in Southern Illinois, carries two tracks of the Illinois Central Railroad, and was completed in 1902, after a period of twenty months in construction. It replaced an old three-span metal bridge with piers 9 to 10 feet thick, and was renewed without interfering with the operation of trains. Preliminary estimates showed that a new steel bridge with solid floor would cost \$125,700, or slightly more than the one selected in solid concrete. In comparison with reinforced concrete the latter showed no economy, and much delay might have resulted in waiting for reinforcing steel. The bridge contains three arches of 140 feet, with true ellipses for the intrados, and semi-minor axes of 30 feet, though the rise on line of pressure is somewhat less. Open spandrels, though costing more than solid ones on so flat an arch, were preferred in order to decrease the load on the foundation piles, and light metal reinforcing frames in the spandrels were used for convenience in erection. The bridge is 463 feet long, and the width is 32 feet extreme, or 26 feet inside the copings, the crown thickness of the arch being 7 feet. Piers are 22 feet high to the springs, and the new ones, which are $22\frac{1}{2}$ feet thick, were built around the old ones as centers. The spandrel arches have a length of 13 feet. Provision was made for expansion, but after completion none was found. It contains 12,000 cubic yards of concrete, or one yard for each square foot of roadway, and 150 tons of steel. The final cost was \$124,900, equal to \$10 per square foot of floor, or \$5.40 per cubic yard of concrete. The bridge is quite similar to one previously built at Verdun, France.

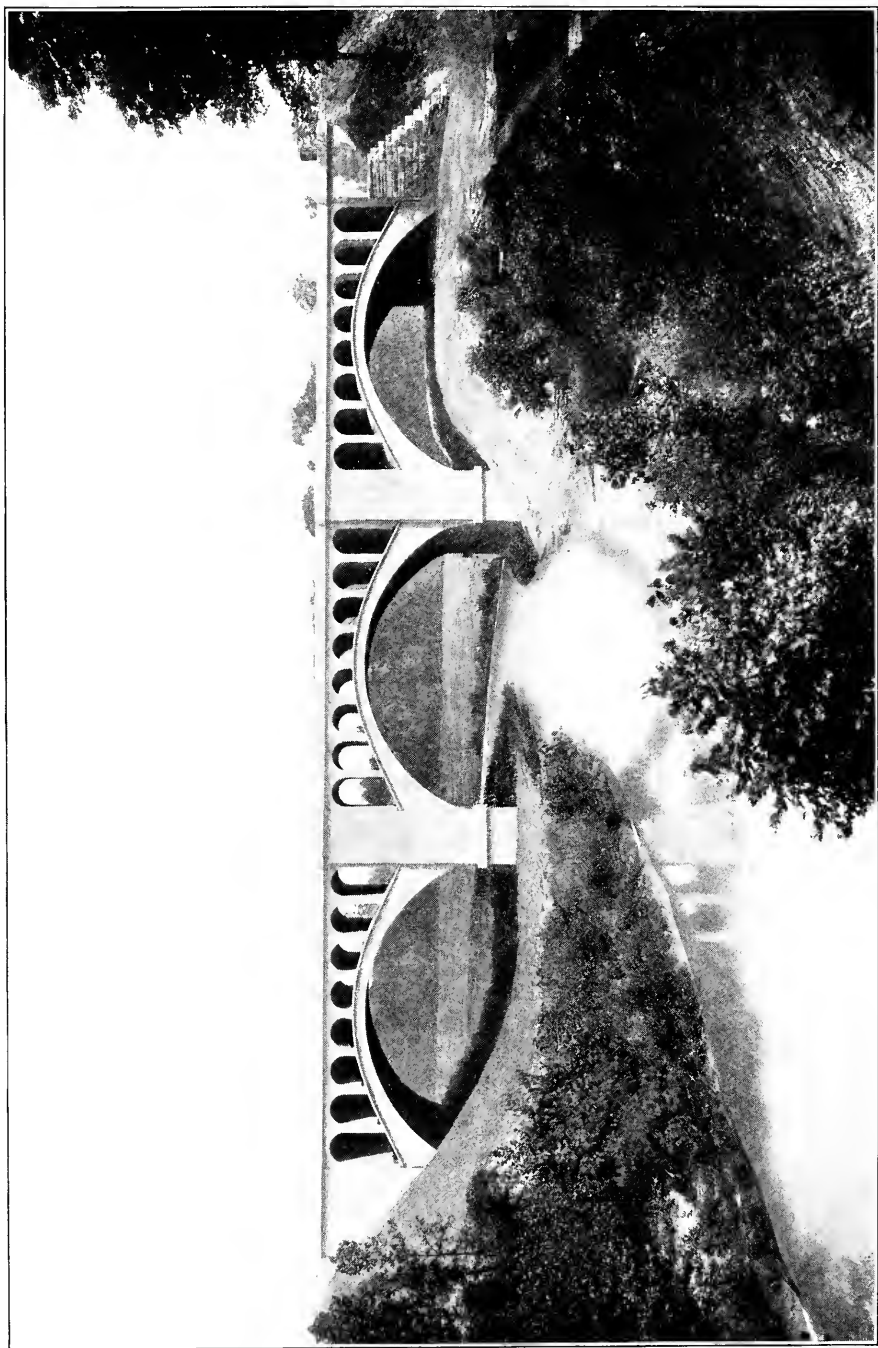

Fig. 201

FIGURE 201. Double Track Railroad Bridge

On the line of the Cleveland, Cincinnati, Chicago and St. Louis Railroad, between Terre Haute and Indianapolis, Indiana, is an interesting railroad structure of concrete with three spans of 75 feet in the clear. W. M. Dunne was Chief Engineer.



Fig. 202

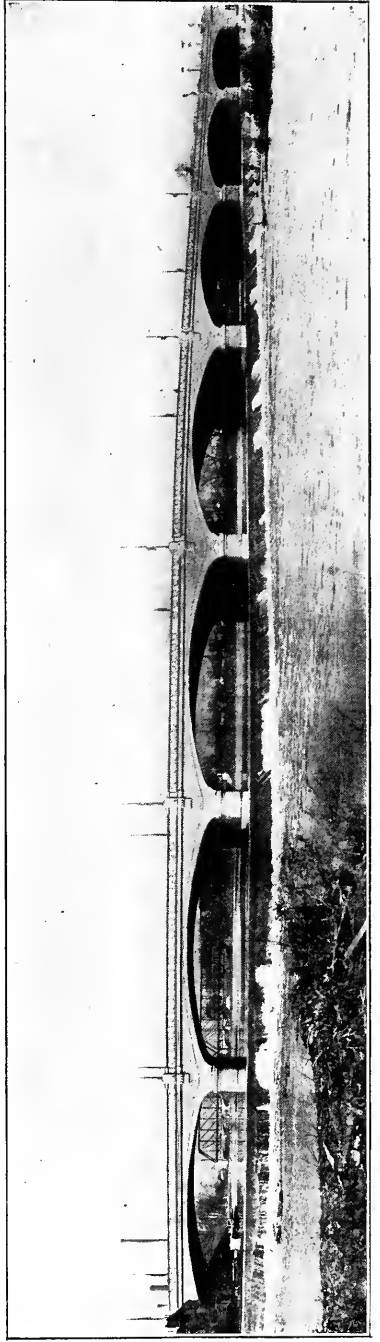

Fig. 203

FIGURE 202. Zanesville, Ohio, Y Bridge

The concrete bridge across the Muskingum and Licking Rivers at Zanesville is the fourth one on the site, former ones having been either wrecked or removed. In spanning the two rivers at their junction, it was necessary to build the bridge with three arms meeting at the center pier. The east arm is 400 feet long with three spans of 122 feet; the west arm is 250 feet long with two spans of 122 and 90 feet, while the north arm is 250 feet with three spans of 81 feet. The foundation in all cases rests on solid shale rock. Shallow arches were used on account of the small distance between the desired floor grade and the high-water level. It has a 30-foot roadway and two 6-foot walks, making a total width inside of railings of 42 feet. The contractors were Bates and Rogers of Chicago, and the engineers The Osborne Engineering Company and E. J. Landor.

FIGURE 203. Washington Street Bridge, Dayton, Ohio

Washington Street Bridge was the third one of the kind built by the city over the Great Miami River. It replaced an old steel bowstring truss bridge that had become too light for the heavy car travel. It was erected during the years 1905-06, by F. J. Cullen, contractor, from plans prepared by the Concrete Steel Engineering Company. It contains seven spans of the following dimensions:

One center span, 90 feet; rise, 11.5 feet.

Two adjacent spans, 86 feet; rise, 10.5 feet.

Two next spans, 80 feet; rise, 9.3 feet.

Two end spans, 74 feet; rise, 8 feet.

The total length face to face of abutments is 620 feet. It is built on the Melan patents, with steel reinforcing ribs 3 feet apart. Its total cost was \$122,000.



Fig. 201

FIGURE 204. Jamestown Exposition Bridge

The United States Government built a bridge at the Jamestown Exposition of 1907, to connect the outer ends of two piers. It is of reinforced concrete, with a clear span of 151 feet and 26 feet rise, and is 36 feet wide, for pedestrians only. It consists of two reinforced concrete ribs carrying the roadway on four longitudinal walls, the ascent of the road being made on a series of steps and landings. The abutments are cored out and each one rests on twenty-six plumb and 126 batter piles. The design was made and executed by the Scofield Company of Philadelphia.

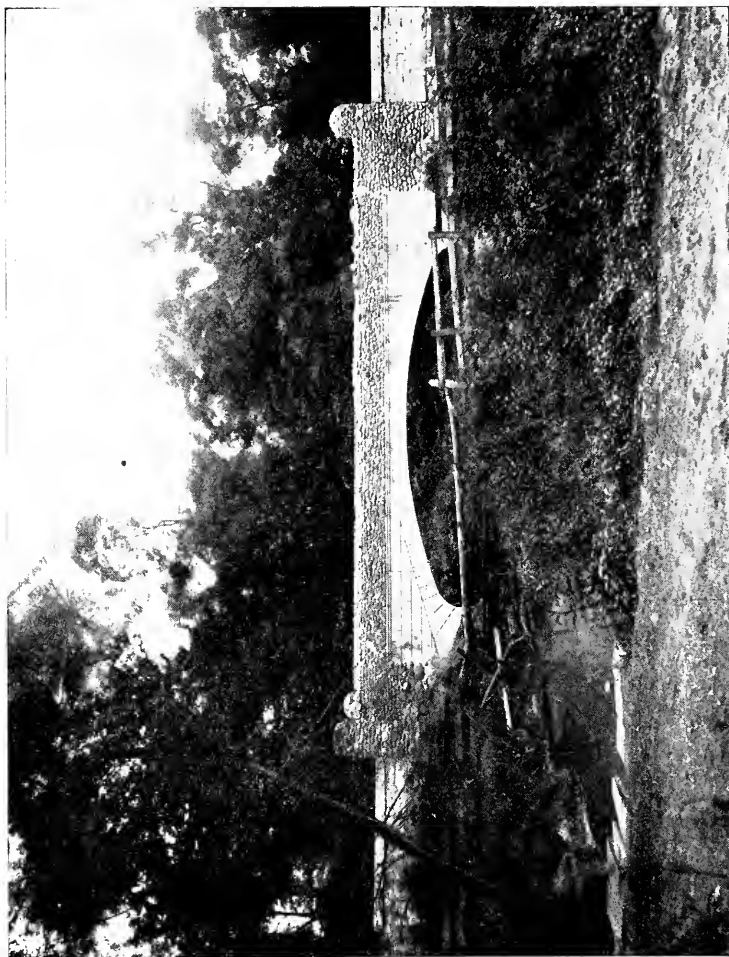

Fig. 205

FIGURE 205. Marion County, Highway Bridge

This reinforced concrete bridge, with its rustic parapet walls, was built on the Melan system, with a span of 32 feet. It is one of many small highway bridges built throughout the middle West to carry country roads over small streams and ravines, the rustic finish being quite suitable for rural districts or wooded parks.

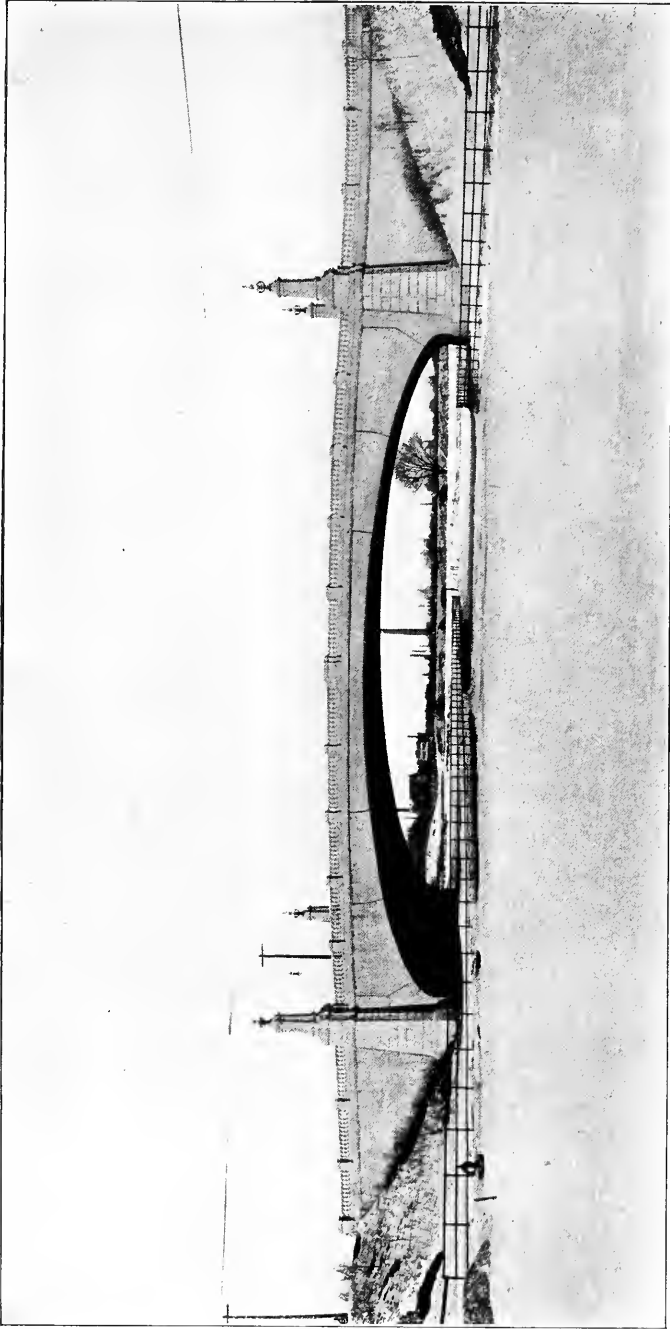
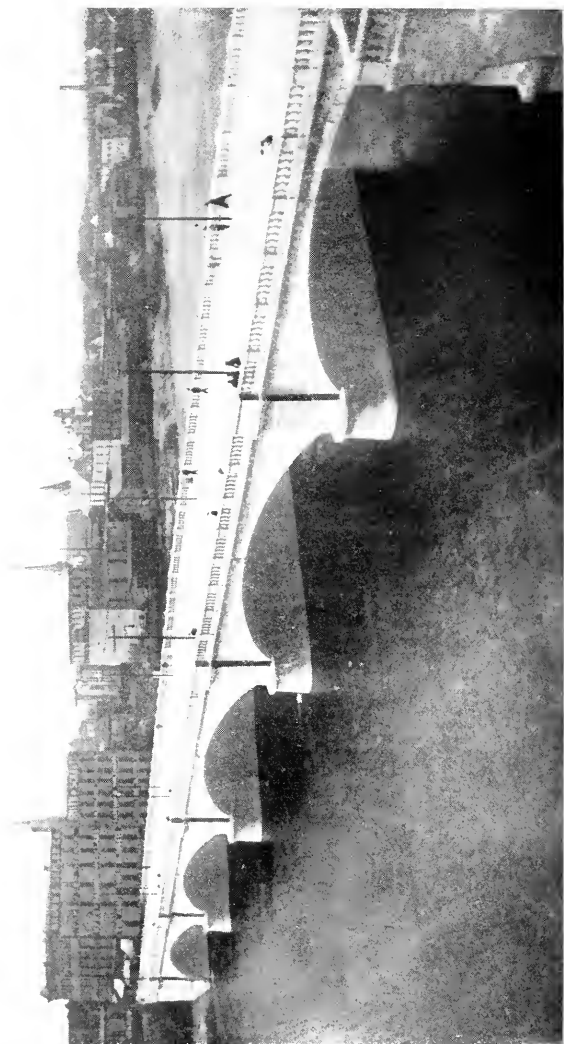

Fig. 206

FIGURE 206. Newark, N. J., Park Bridge

In Branch Brook Park at Newark there is a bridge of reinforced concrete, carrying Park Avenue over a waterway, the side view of which is shown. The span of arch is 132 feet, clear width inside of railing 70 feet, and total length 244 feet. It has a 40-foot roadway and two 15-foot walks with a clearance underneath of 22 feet, and contains 6,200 cubic yards of concrete and 124 tons of steel. The total cost without pavement was \$84,000. Work was carried on from August, 1904, to January, 1905, under the direction of the Park Commissioners of Essex County. A. M. Reynolds, engineer; Babb, Cook & Willard, architects.



• Fig. 207

FIGURE 207. Grand Rapids, Concrete Bridge

This is a good example of the best American practice in concrete construction. It has a roadway 64 feet wide. Of the five spans, the center one is 87 feet, the two adjoining ones 83 feet, and the two end spans 79 feet each. It was designed by Wm. F. Tubesing, bridge engineer for L. W. Anderson, City Engineer, and was constructed in 1904 by J. P. Rusche, contractor, of Grand Rapids.

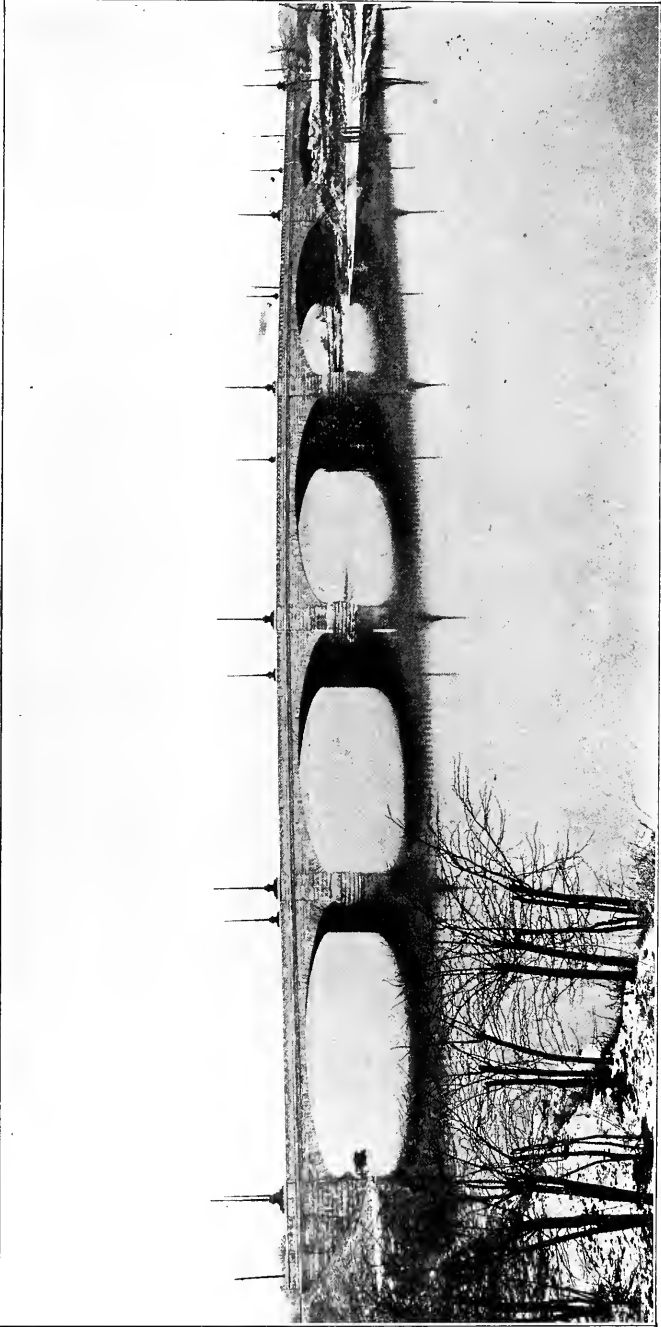

Fig. 208

FIGURE 208. White River Bridge at Morris Street, Indianapolis

Five spans of Melan concrete arches ranging in length from 90 to 110 feet compose this bridge, the exposed parts, excepting arch soffits, being faced with stone. It presents a very neat appearance.

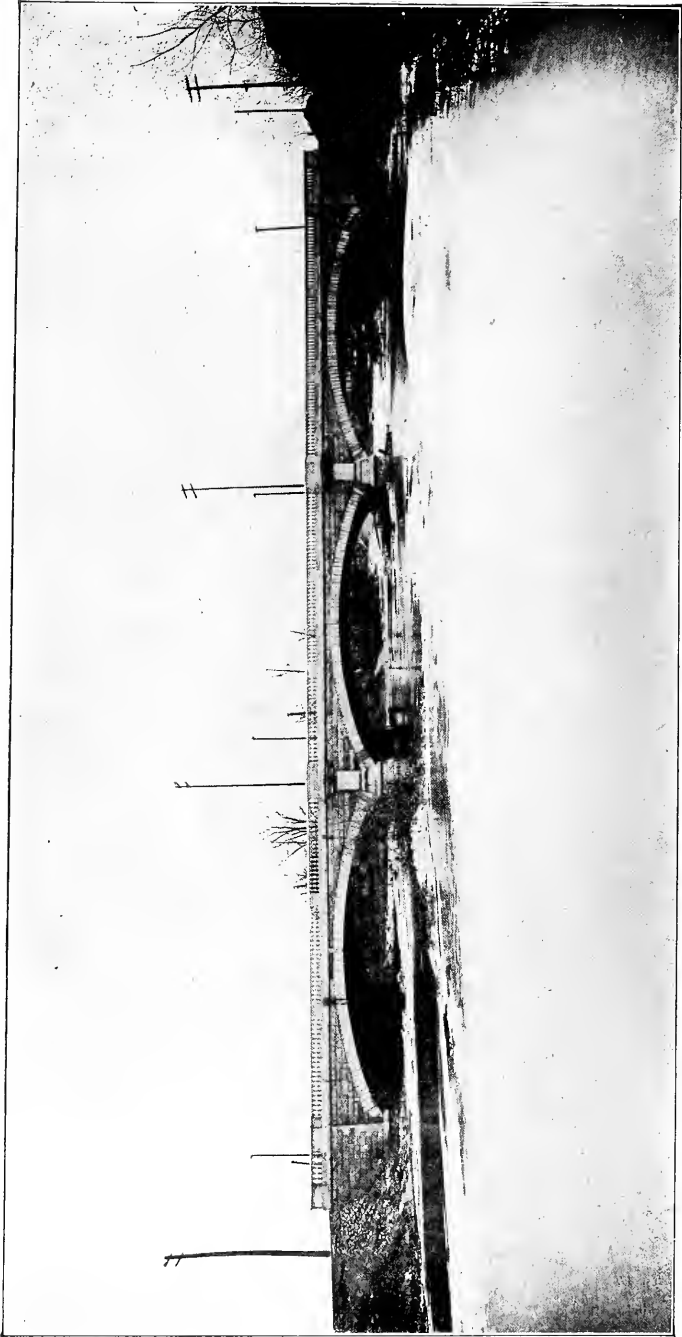

Fig. 209

FIGURE 209. Northwestern Avenue Bridge, Indianapolis

This is one of the bridges recently built by the city of Indianapolis. It has three spans 74 feet long each, on the Melan system of reinforced concrete, the exposed parts of piers and arches being faced with stone. Above the piers are semi-columns carried up to support retreats. It crosses Fall Creek and is somewhat similar to those at Illinois and Meridian Streets, excepting that Northwestern Avenue bridge has a more ornamental balustrade.



Fig. 210

FIGURE 210. White River Bridge at Emerichsville, Ind.

There are few bridges in America with entrance arches, but this has a fine archway over the roadway at the end adjoining the park. The spans have a length of 110 feet each and the three arches are ornamented on the face and spandrels with panels and elaborate mouldings above the piers. With adjoining landscape and boulevards, it would be a fine example of ornamental work.

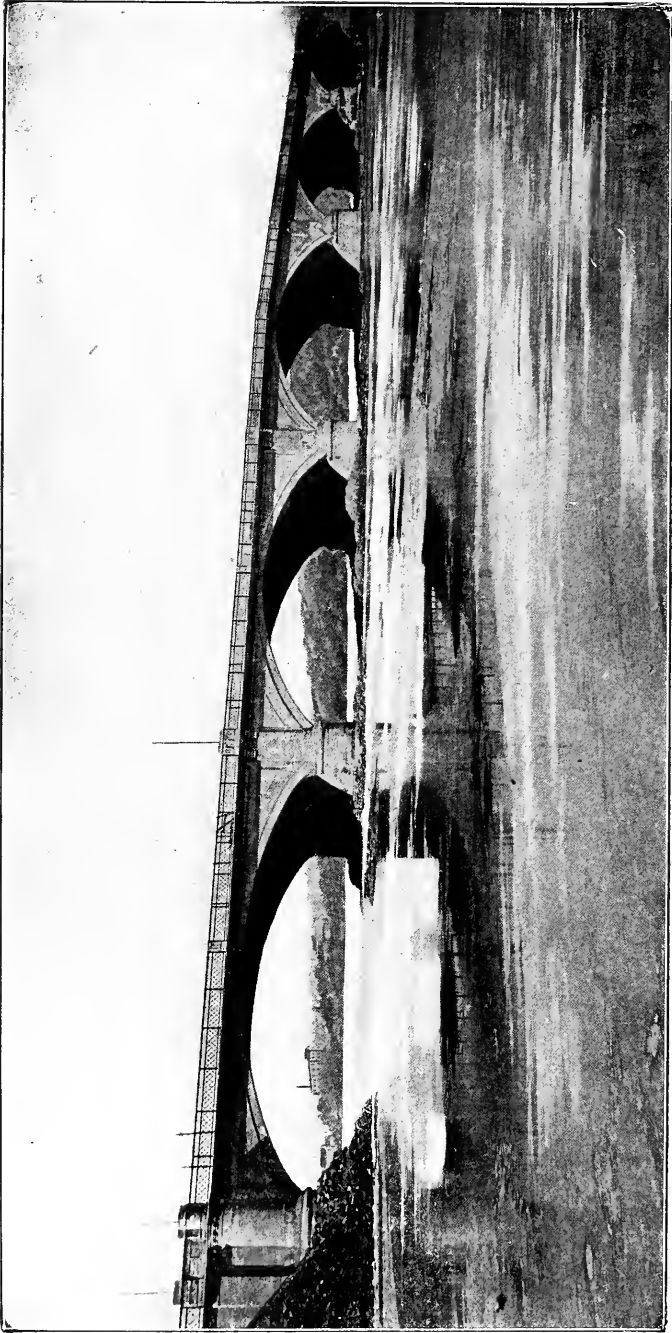

Fig. 211

FIGURE 211. Topeka Bridge over the Kansas River.

An interesting example of concrete construction is at Topeka, across the Kansas River. It has one span of 125 feet, two of 110 feet, and two of $97\frac{1}{2}$ feet, and at the time of building was the largest one of concrete-steel in existence, though it has since been surpassed by several others. The roadway is 26 feet, and the two walks 7 feet each, making a total width of 40 feet. It was built during the years 1896-97, and cost complete \$150,000. The twelve lines of steel reinforcing ribs are 3 feet apart on centers. Keepers and Thacher were the designers, and H. V. Hinckley, resident engineer.

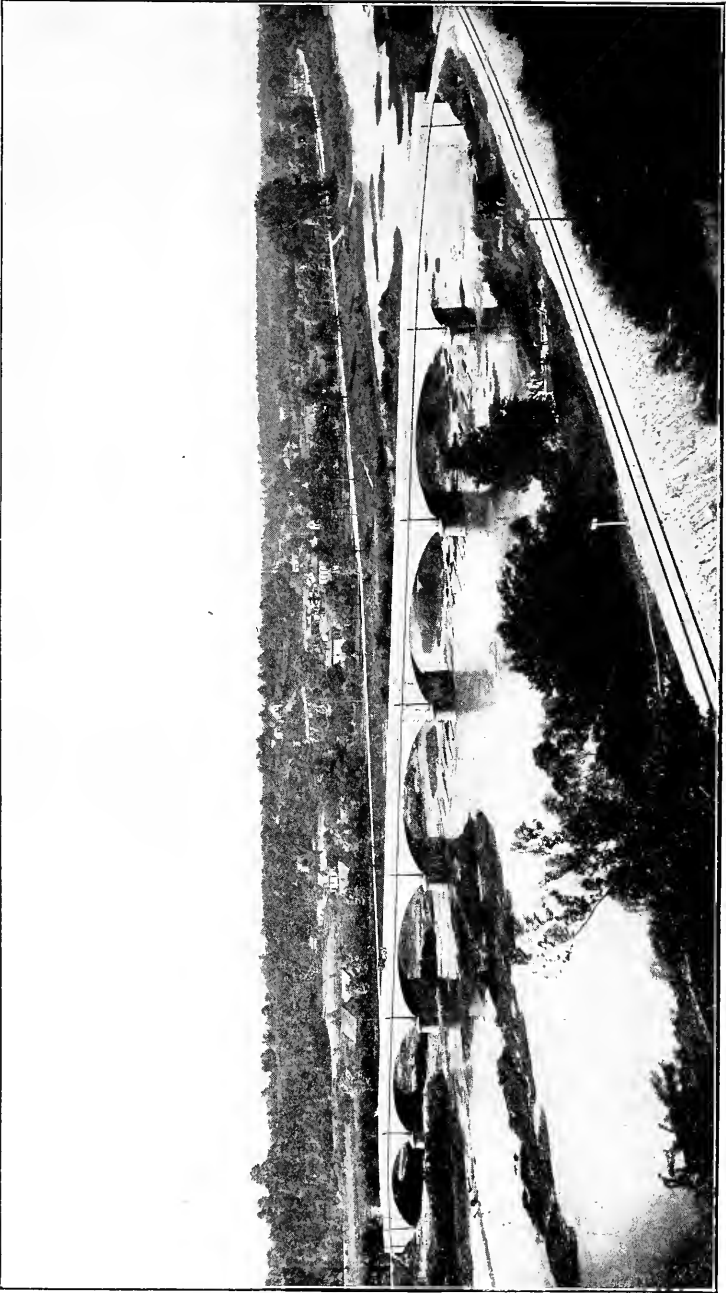

FIG. 212

FIGURE 212. Wayne Street Bridge, Peru, Ind.

The Wayne Street bridge was built under the direction of the County Commissioners of Miami County, in the six months from June to December, 1905. It has seven spans, the center one being 100 feet and the others 95, 85, and 75 feet, respectively, towards the ends. The roadway is 30 feet wide, with a clearance above low water of 24 feet. The thickness of arch rings vary from 21 to 25 inches at the crown, and the rise from 13 to 15 feet. Piers are 6 feet thick at the springs, and stand on bed rock. The bridge contains 5,200 cubic yards of concrete and 50 tons of steel reinforcing. In January, 1907, it had a severe test, when the Wabash River rose to within five feet of the soffits, and the approaches at both ends were under two feet of water, but no injury was sustained.



Fig. 213

FIGURE 213. Green Island Bridge, Niagara Falls

Crossing from Green Island to the American side of the Niagara River, over the main channel, is a three-span reinforced concrete arch bridge of the Melan type, with stone facing. It stands over the rapids, where water runs at a velocity of 24 miles per hour, and just below it are the American Falls. It has a center span of 110 feet and two side spans of 100 feet each, and for arches of so flat a rise the design is quite artistic. The stone arch rings and facing, together with the belt course of different material, above the crown, and the smooth stone coping, as well as the semi-columns at the piers, all unite to produce a pleasing effect.



Fig. 214

FIGURE 214. Bridge Over Niagara River, from Green Island to Goat Island.

This is smaller than the Green Island bridge illustrated on page 231, the center span being 55 feet and the end ones each 50 feet 6 inches.

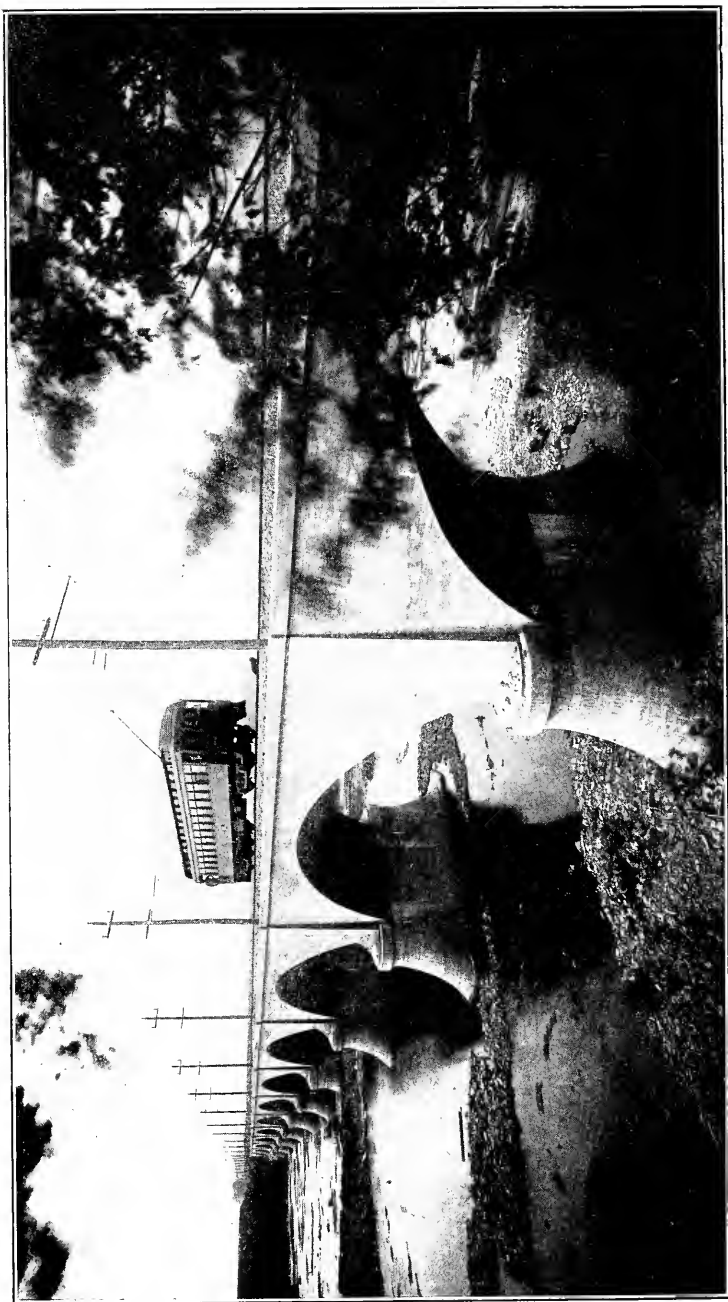

Fig. 215

FIGURE 215. Maumee River Bridge at Waterville, Ohio

This structure is comprised of twelve spans of reinforced concrete, with arches varying in length from 75 to 90 feet, and rise of about 25 feet. The total length is 1,200 feet and the deck is 45 feet above low water, with a width of 16 feet in the clear. It was erected in 1908, to carry a single track of Lima and Toledo Traction Company, which was built for the Ohio Electric Railway Company of Cincinnati. The bridge crosses the Maumee River fifteen miles southwest of Toledo, and contains 9,200 cubic yards of concrete and 100 tons of reinforcement. Piers stand on bed rock and are 10 feet thick at the springs. It was designed by The National Bridge Company, Daniel B. Luten, President, the contract price being \$77,000.

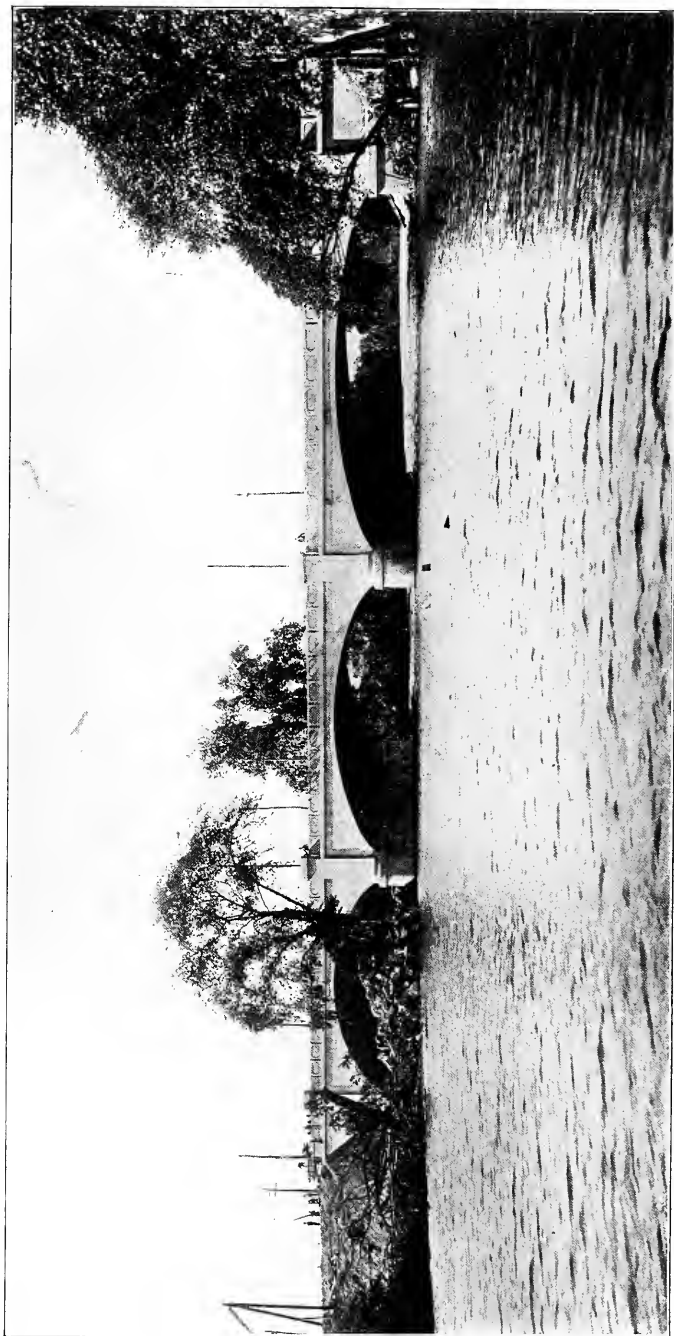

Fig. 216

FIGURE 216. Concrete-Steel Bridge at Derby, Conn.

The three spans are each 72 feet in the clear, and the bridge is 54 feet wide. The parapet is a solid concrete slab paneled on the faces.

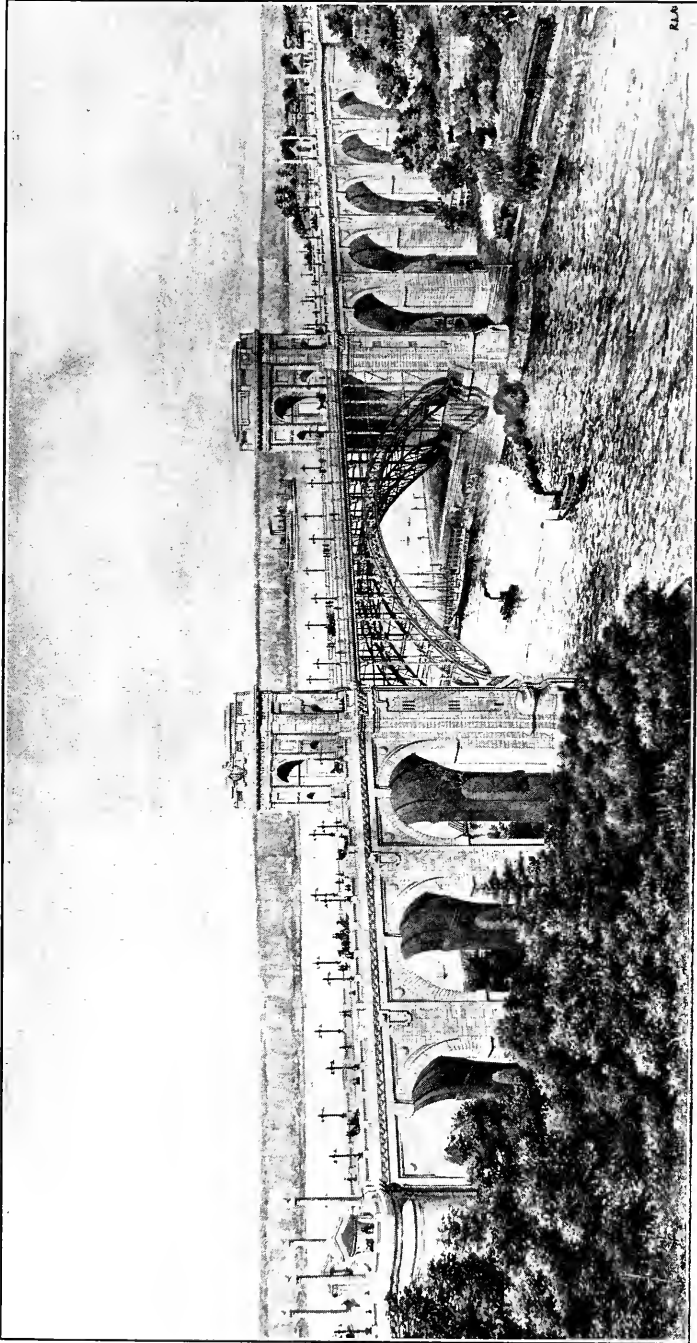

Fig. 217

FIGURE 217. Hudson Memorial, Design No. 1

A design for the Hudson Memorial bridge made by Boller and Hodge contemplates the use of a 400-foot steel arch, but the plan was rejected by the Municipal Art Commission of New York, as construction in steel was considered unsuitable for a great memorial structure. The drawings show three terminal spans at the south end and five at the north, all 80-foot semi-circular arches. The massive piers are shown with interior chambers, the two principal ones being continued above the deck in monumental arches over the roadway. The masonry could be carried out in either stone or concrete, or a combination of the two materials.

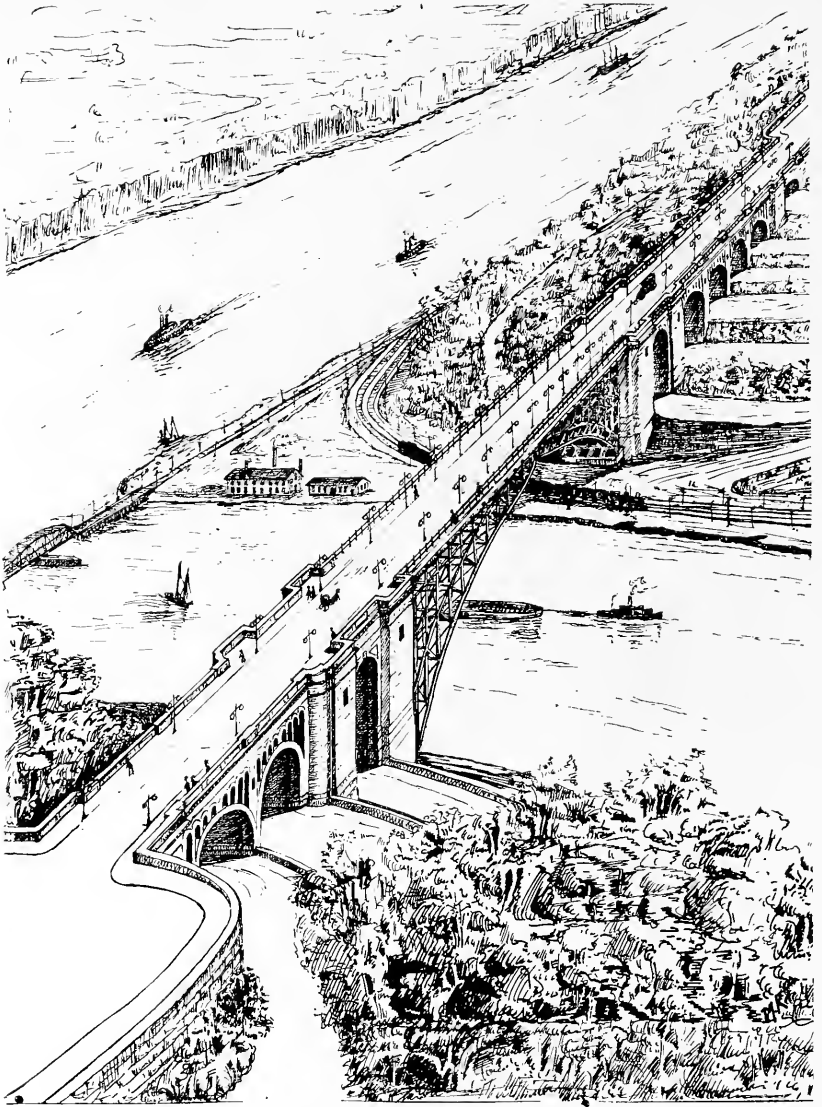

Fig. 218

FIGURE 218. Hudson Memorial, Design No. 2

Another design for this memorial bridge provides a main span of 825 feet in length, framed with two pairs of three-hinged steel arch trusses, carrying a roadway 100 feet in width and 170 feet above the water. The length as planned is 2,500 feet. Seven masonry approach spans of 90 feet are shown, and two through the abutments with clear spans of 65 feet and a height of 120 feet. It was the intention of the designer to erect a statue of Hudson on a massive pedestal in the plaza at the southern end, but this feature does not show in the view. The design was prepared by Messrs. Boller and Hodge of New York.

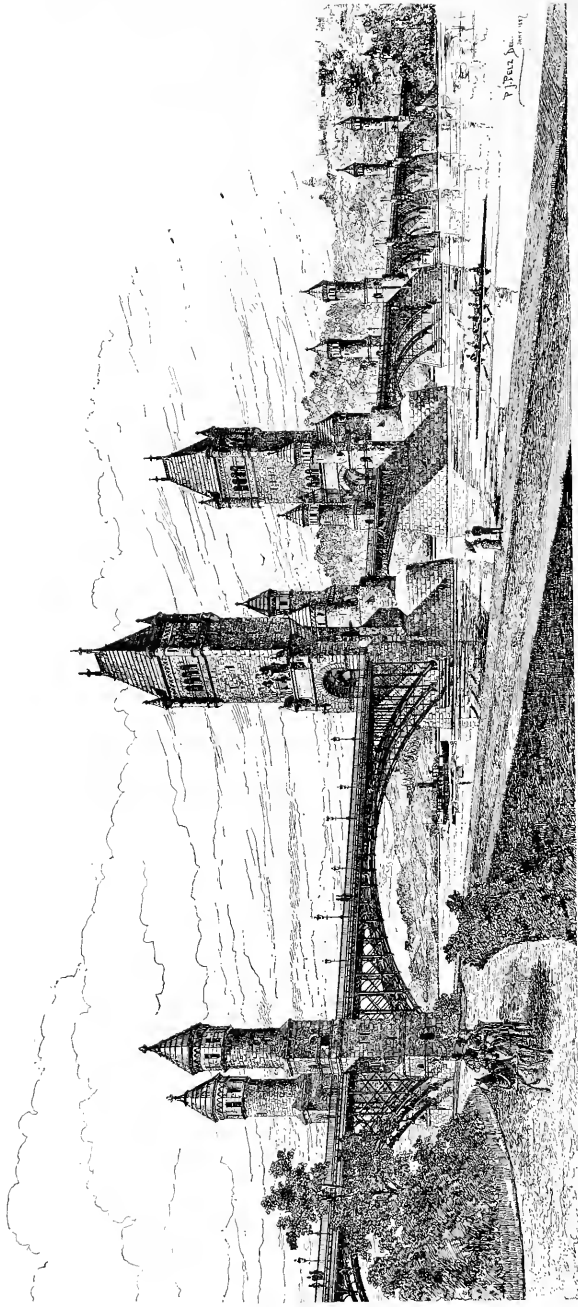

Fig. 219

FIGURE 219. Grant Memorial Bridge, Washington

Several designs were prepared in 1886-87 by Paul Pelz, architect, and Capt. T. W. Symonds, engineer, for a Grant Memorial Bridge across the Potomac River, which are among the finest ones produced in this or any other country. The proposed site was midway between the Long Bridge and the aqueduct, and Congress proposed an appropriation of \$500,000 to begin the work, but it was postponed. One of these plans has two central towers 230 feet above the water and 160 feet apart, with a double bascule span between them and a series of steel deck arch spans at each side. The roadway is 40 feet wide with 10-foot sidewalks, and at the piers are minor towers. The design as a whole is well conceived and strong, and harmonious in all its parts, the details being in Mediæval style of architecture.

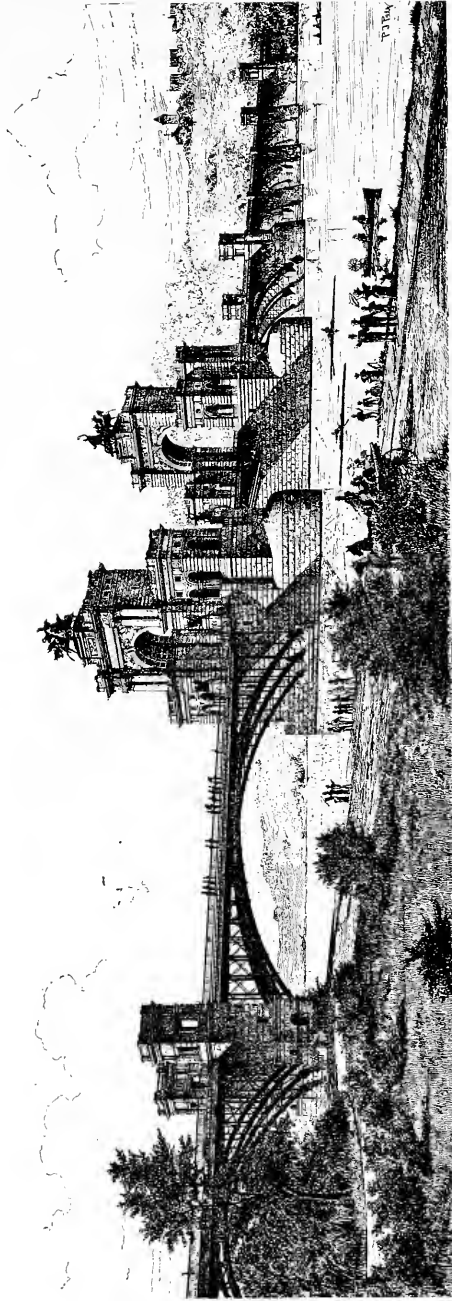

Fig. 220

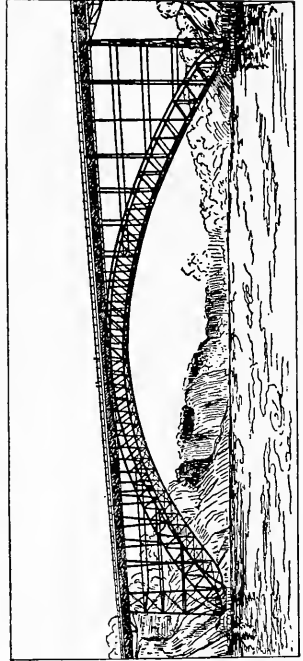

Fig. 221

FIGURE 220. Grant Memorial Bridge, Washington, No. 2

Another design for the same project as the previous one was made in 1887 by Mr. Pelz, in classic style, with two triumphal arches mounted with equestrian groups in bronze, and lower towers at the sides, with arched openings. The details of the columns are Corinthian, as are also those on the minor towers nearer the end. These great arches on their heavy piers, with rounded ice-breakers, form a massive central feature and mark the position of the bascule span and channel. The materials used are steel and granite, as in the previous design, and the metal arches are of nearly the same style. It is to be greatly regretted that such designs as these, reflecting so much credit upon the æsthetic phase of bridge building in America, should not come to fruition, as have others in Europe.

FIGURE 221. Clifton Highway Arch, Niagara Falls

The Clifton-Niagara bridge over the Niagara River, 1,000 feet below the Falls, has a center span of 840 feet, with terminal spans at each end, and is the longest arch in existence, though several larger ones have been projected. It replaced the old suspension of 1868, which had a span of 1,268 feet, and is the third bridge to occupy the site. The deck is 46 feet wide and 200 feet above the water, with two car tracks in the center. The two ribs have parallel chords 26 feet apart, with pin bearings at the ends, and are 30 feet apart on centers at the crown, sloping out to 69 feet at the shoes. The main arch contains 1,825 tons of steel, and the whole bridge 2,260 tons. It was erected cantilever similar to the method used for the Mungsten bridge, and was opened for travel in August, 1898. Water under it is believed to be 180 feet deep.

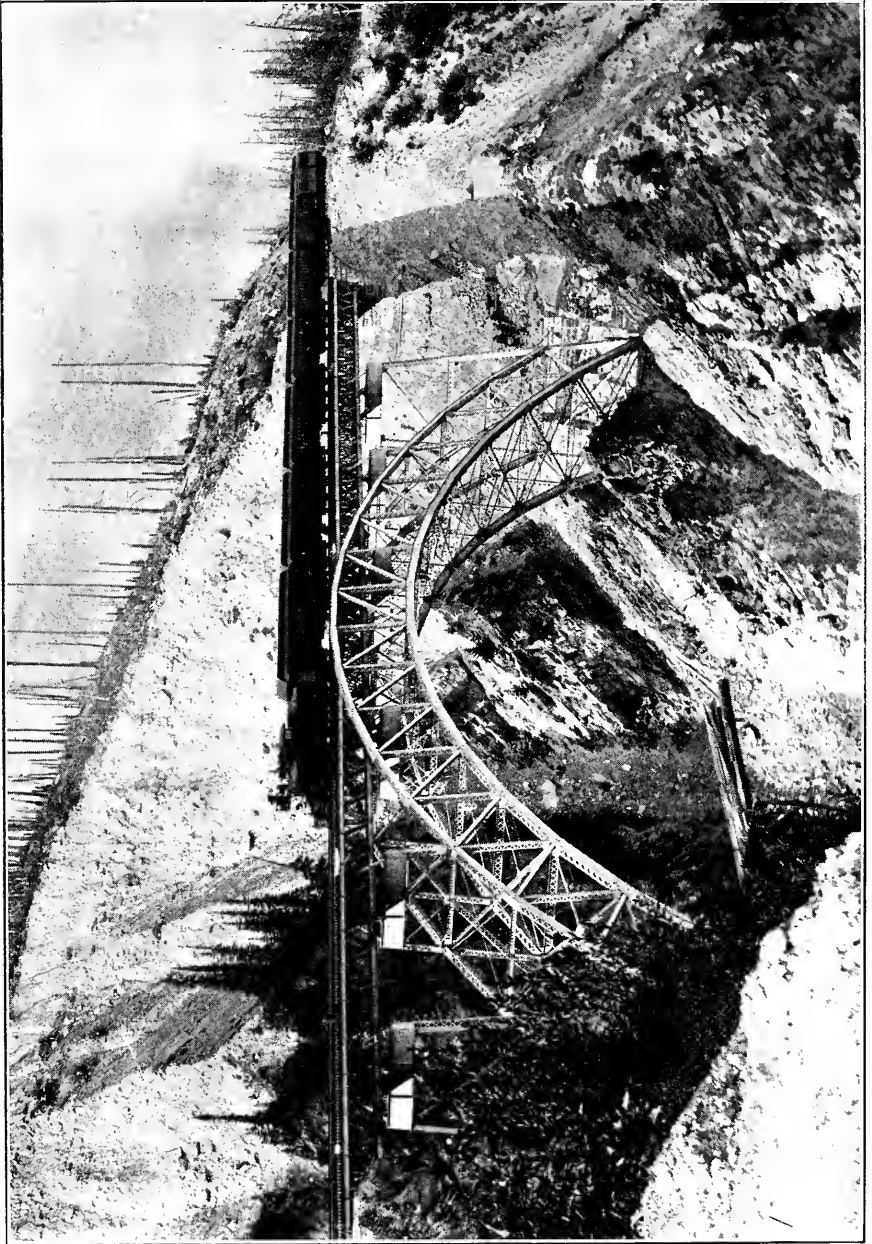

Fig. 222

FIGURE 222. Stony Creek Arch, British Columbia

The Canadian Pacific Railway crosses Stony Creek in British Columbia on a steel arch 340 feet above the valley. The location is very picturesque. The sides of the gorge are so steep and rocky that the place is naturally inviting for an arch. When first building the road, in 1885, the track was carried on four Howe trusses over wooden towers, designed and built under the direction of W. A. Doane, G. H. Duggan and T. K. Thomson, engineers, and this remained in use for about ten years. The steel arch has a span of 336 feet and a rise to the under chord of 80 feet, the curved trusses being 26 feet deep at the ends and 20 feet at the center. The total length of the bridge, including the terminal spans, is 485 feet. Arch trusses are 24 feet apart on centers at the crown, and batter out one in ten. They are pin connected, but all bracing is stiff and riveted, and the riveted deck trusses carrying the track are 9 feet apart on centers. The weight of steel in the arch is 524 tons and in the entire structure 771 tons. At the time of building, the Chief Engineer for the railroad company was P. A. Peterson, and H. E. Vautelet, Bridge Engineer.

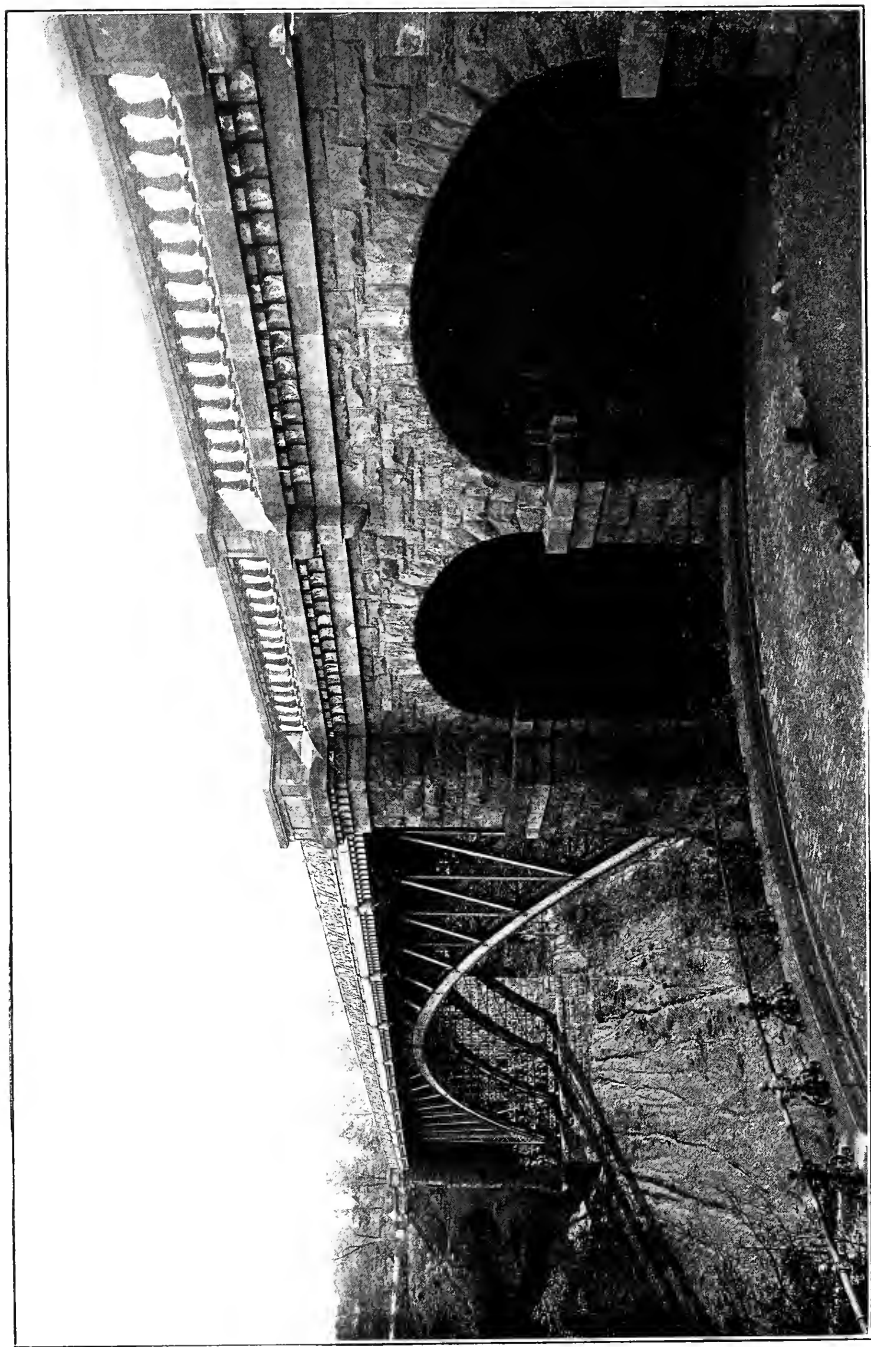

Fig. 223

FIGURE 223. Panther Hollow Bridge, Pittsburgh

This bridge carries a roadway over Panther Hollow, a ravine about 120 feet deep, and crosses from the Phipps Conservatory to the Speedway. There are four 28-foot stone arches, two at each end, and a main parabolic steel arch of 360 feet and 45 feet rise. The four, three-hinged steel ribs stand vertical and $12\frac{1}{2}$ feet apart on centers, and are 50 feet deep at the ends and 5 feet at the middle. The bridge is 615 feet long and was built in 1896 at a cost of \$170,000. The road is 40 feet wide and two 10-foot sidewalks are carried on cantilever brackets, both roadway and walks having asphalt paving on steel trough flooring. The end pedestals are mounted with bronze figures of panthers.

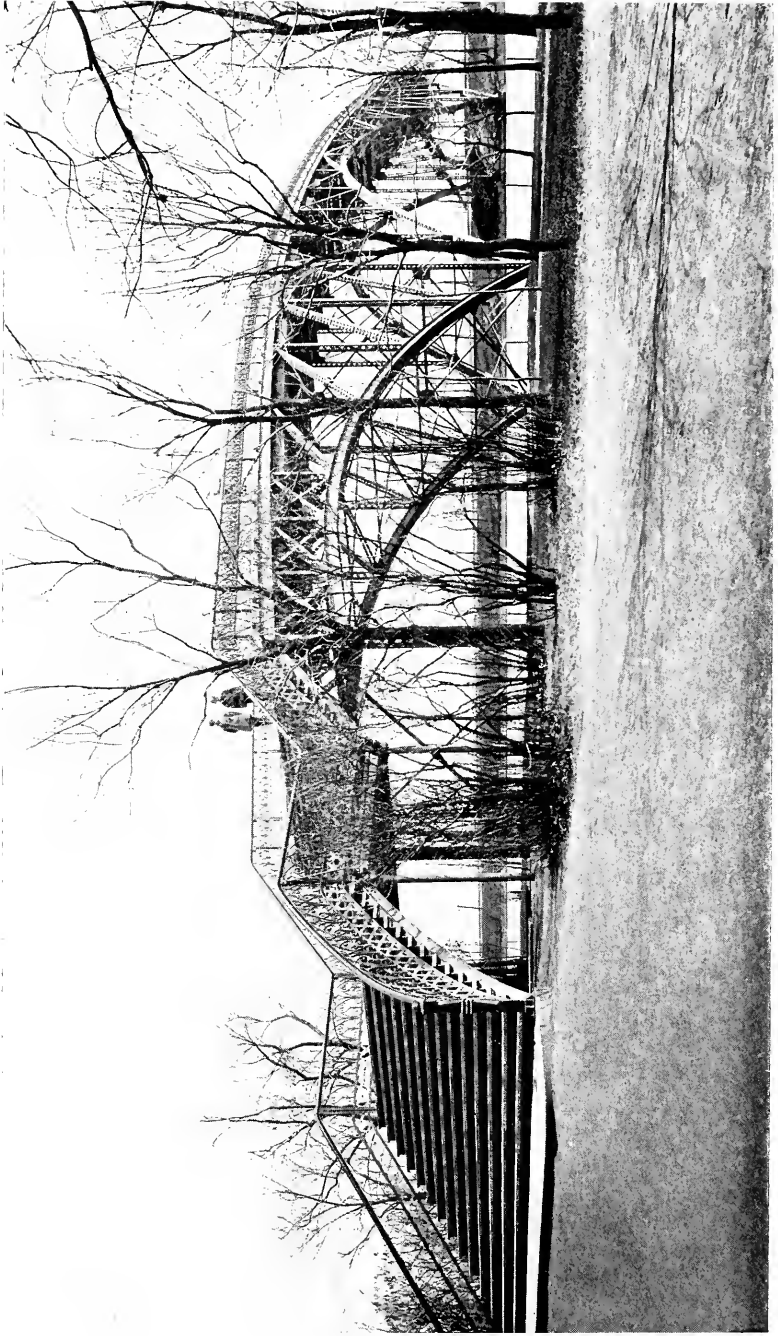

Fig. 224

FIGURE 224. Lincoln Park, Chicago, Arch Cantilever

Lincoln Park, Chicago, has a lagoon nearly a mile in length, parallel with the lake and only a short distance away, which is crossed by two bridges. As small boats and launches come into the lagoon, it was necessary in constructing bridges to build them high enough so sail boats could pass under. The arch cantilever form as shown was adopted, the bottom chords of the end brackets conforming to the curve of the main arch. The west end of the bridge has a wide set of steps, while the east end is reached by stairs leading up from the north and south. It has an ornamental iron railing and is altogether an interesting feature of the park.

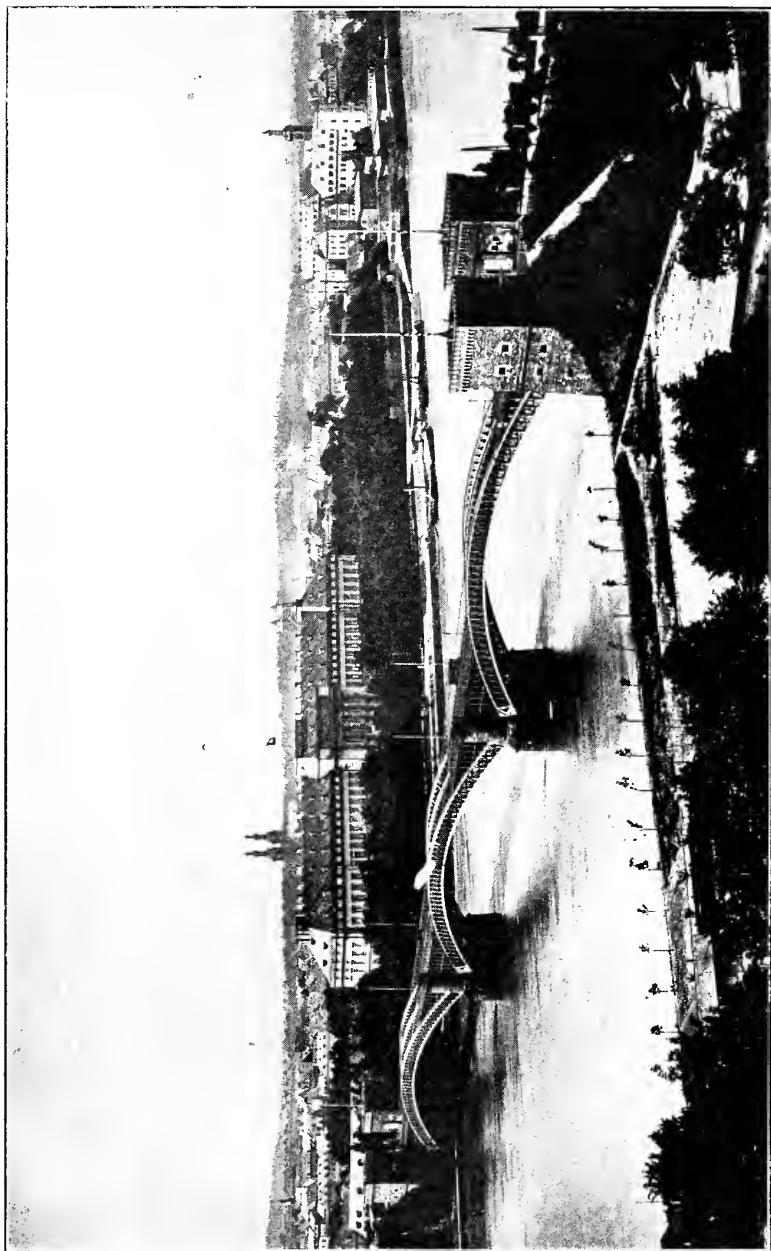

Fig. 225

FIGURE 225. Coblenz Railroad Bridge

The bridge over the Rhine at Coblenz with three deck metal arches of 315 feet, completed in 1864, was the first braced wrought iron arch with curved parallel chords. The ribs were first erected on end hinges and after completion the ends were blocked up solid against their bearings. It carries two lines of railroad, and is one of Hartwich's designs.

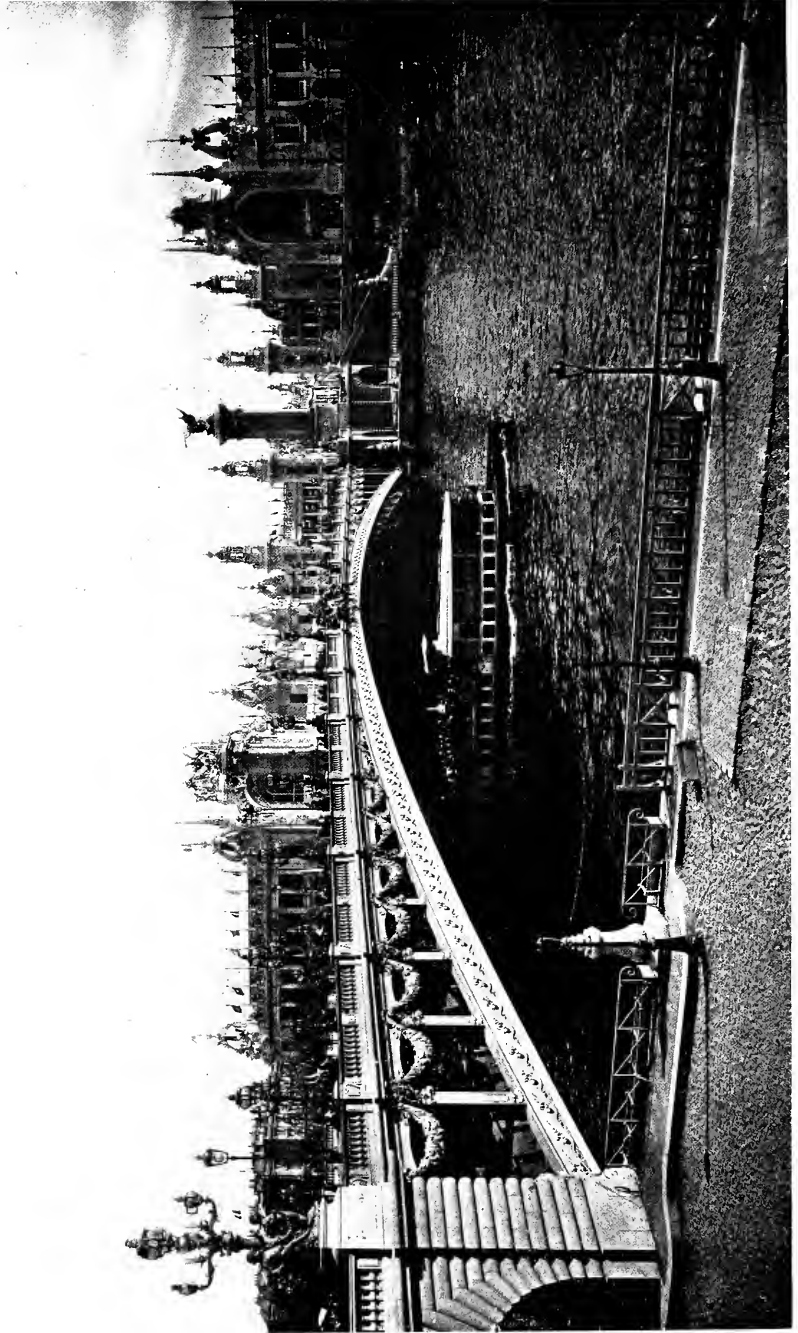

Fig. 226

FIGURE 226. Alexander III Bridge, Paris

This is the widest bridge in Paris, and is remarkable for its width and flat arch rise. It crosses the Seine at the Fair Ground and connects the Champs Elysees and the Esplanades des Invalides. The width is 40 meters (131 feet), one-half of which is roadway and the remaining half divided between the two walks or promenades. There are fifteen lines of three-hinged cast steel arch ribs, 353 feet long between end pins, the ribs being placed slightly less than $9\frac{1}{2}$ feet apart. The roadway is 32 feet above water and the arches have a rise of only $20\frac{1}{2}$ feet, or about one-seventeenth of the span. It was named in honor of the Czar of Russia, and is monumental in character, as there are at the ends ornamental towers, the tops of which are 75 feet above the road. The faces of the arch and spandrels are adorned with festoons and panel work in iron, and the balustrade is rich and heavy with round balusters and moulded top. At either end is sculpture, and along the balustrades are ornamental standards supporting clusters of lights.

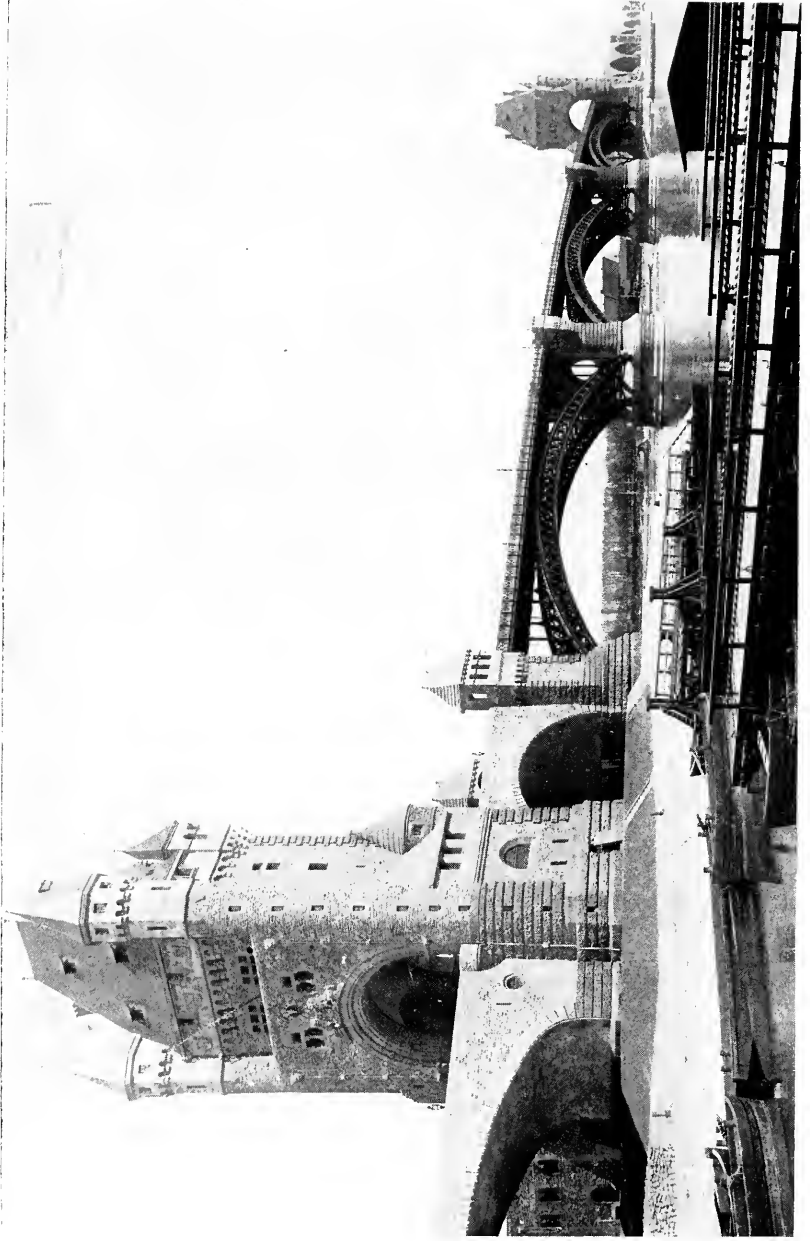

Fig. 227

FIGURE 227. The Worms Highway Bridge

The highway bridge over the Rhine at Worms, completed in 1900, has a 22-foot roadway and two 7-foot walks, supported over the river on a central deck arch of 345 feet and two side ones of 330 feet, the chords being curved to circular arcs. The two lines of braced arch ribs are two-hinged crescent shaped, 25 feet apart on centers, and the weight of metal in the three river spans is 1,200 tons. At the ends are many approach masonry arches, and at either side of the water are beautiful portal towers.

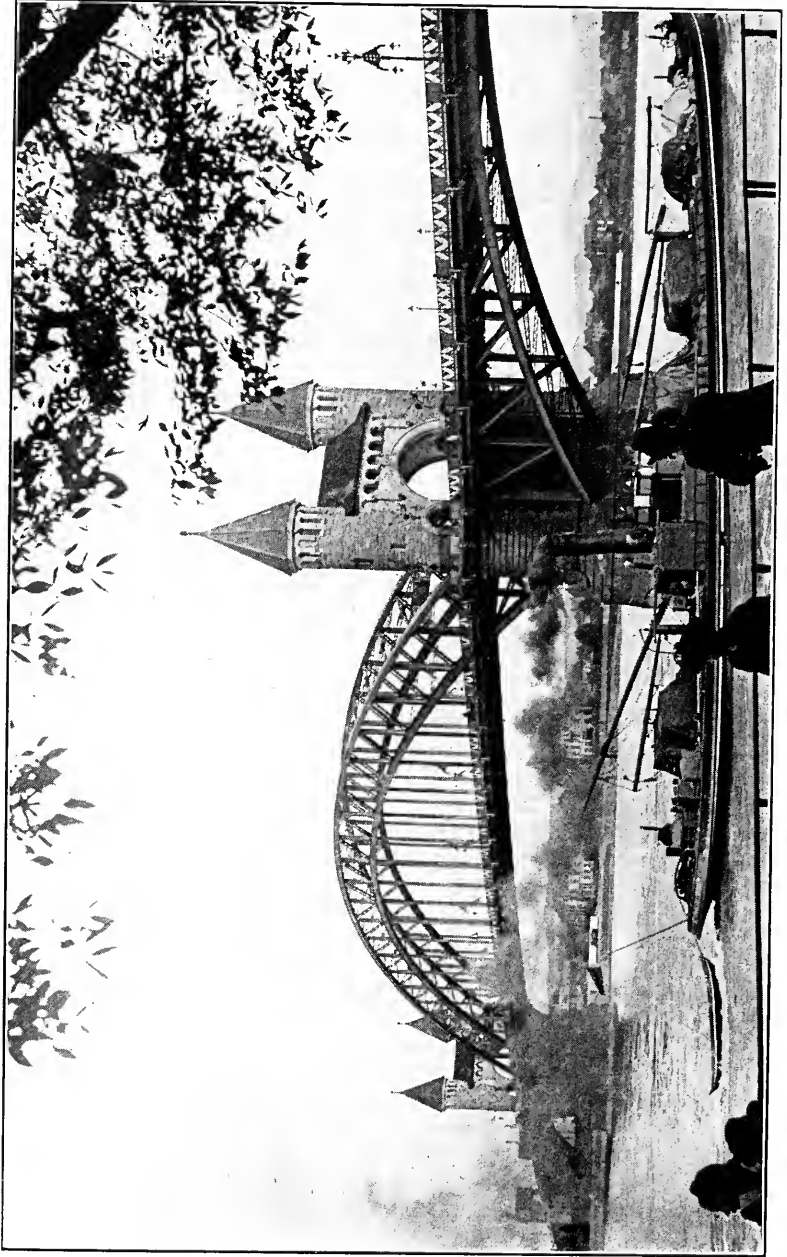

Fig. 228

FIGURE 228. The Bonn Bridge

In the competition of 1895 for the Bonn bridge over the Rhine, sixteen designs were submitted, and the one prepared by Reinhold Krohn and Bruno Moehring was awarded the first prize. It contains a central 614-foot half-through braced arch, with a 307-foot deck arch at each side, and at one end a smaller arch of 106 feet, all ribs being true two-hinged arches. The large central span is divided into $25\frac{1}{2}$ -foot panels, and the rise of the lower chord is 97 feet, while the highest part of the arch is 136 feet above water. Trusses are vertical and $29\frac{1}{2}$ feet apart, $15\frac{1}{2}$ feet deep at the center and $34\frac{1}{2}$ feet at the ends, the chord sections being curved to true circular segments, an expedient which adds about 20 per cent to their cross section. The road is 23 feet wide with provision for two car tracks, and at each side is a 11-foot walk, the whole being paved with wood blocks on galvanized iron buckle plates. All members are stiff with riveted joints, and the arches were erected on false work. The 3,332 tons of steel cost \$257,000, and the whole bridge when completed in 1898 cost \$637,000.

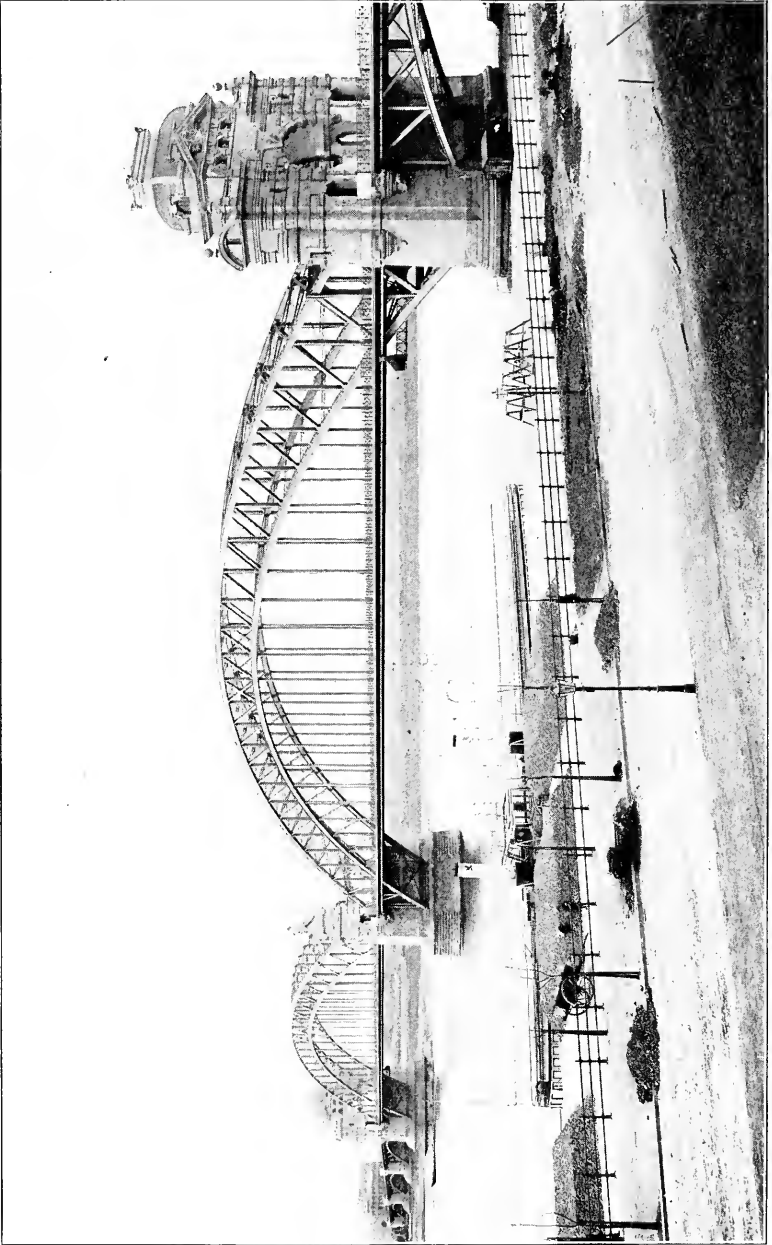

Fig. 229

FIGURE 229. The Dusseldorf Bridge

The Düsseldorf Bridge, over the Rhine, crosses the water with two through braced arches of 595 feet, with a lower chord rise of 90 feet. At one end are three approach deck arches of 167 to 200 feet, and at the other end a single span of 198 feet, but these spans are of very different construction to the central bridge, and are separated from it by prominent portal towers in Renaissance style. The design is almost above criticism, though a larger center pier might have been more fitting. The braced arch ribs are two-hinged circular arcs about 32 feet apart transversely, $16\frac{1}{2}$ feet deep at the center and 40 feet at the ends, subdivided into 24-foot panels. The crown of arch is 129 feet above mean water, and the deck 62 feet above the river and $46\frac{1}{2}$ feet wide, with 27-foot road and two 10-foot walks. Paving is with wood blocks on buckle plates, the maximum grade being one in forty. The whole bridge is 2,100 feet long and the total weight of steel is 5,130 tons, including 160 tons of railing. The metal cost \$440,000 and the whole work \$905,000. It was completed in 1899 under the direction of R. Krohn, Chief Engineer.

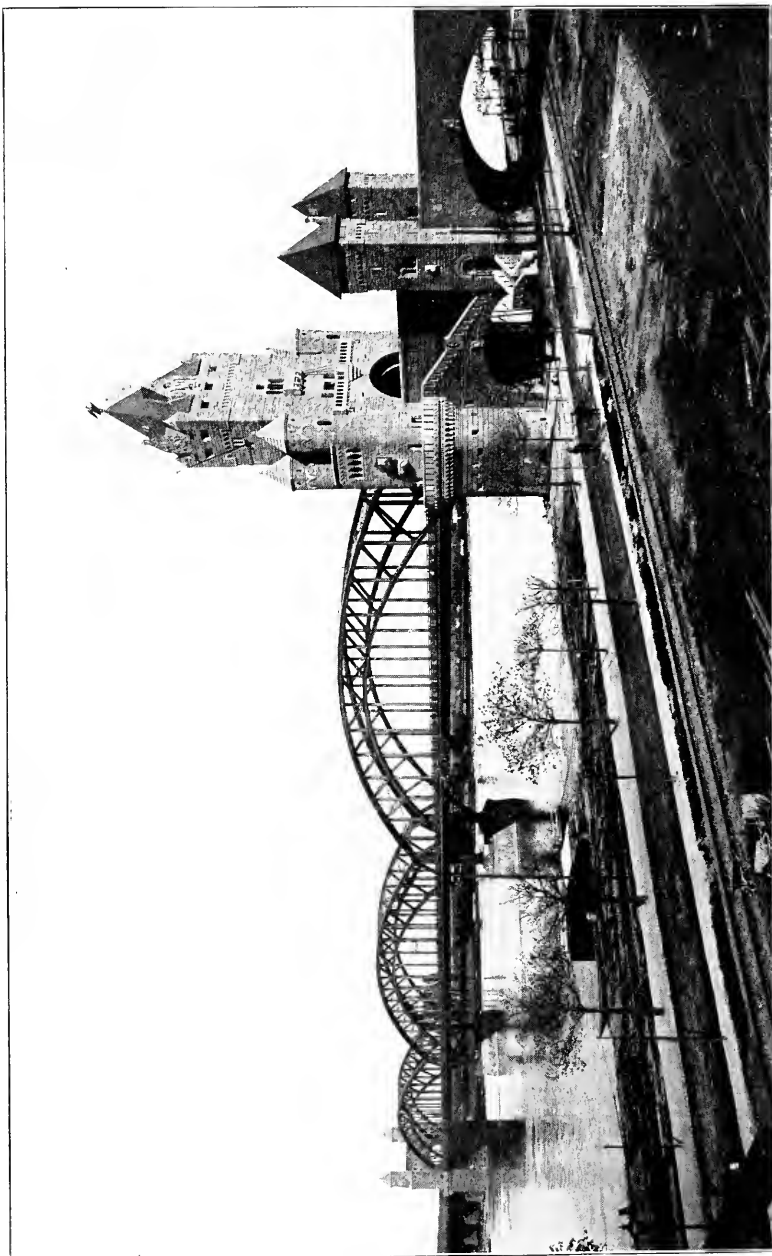

Fig. 230

FIGURE 230. The Rhine Bridge at Mainz

The Rhine Bridge at Mainz crosses two arms of the river with three and two spans, respectively, and an island with six spans of 130 feet. The channel spans are through tied arches of 306 to 382 feet, similar in outline to that at Bonn, but with vertical pier reactions. The most striking parts of the bridge are the beautiful portals with their minor towers and stairs. It carries two tracks and two footwalks and was completed in 1904 at a cost of \$1,300,000.

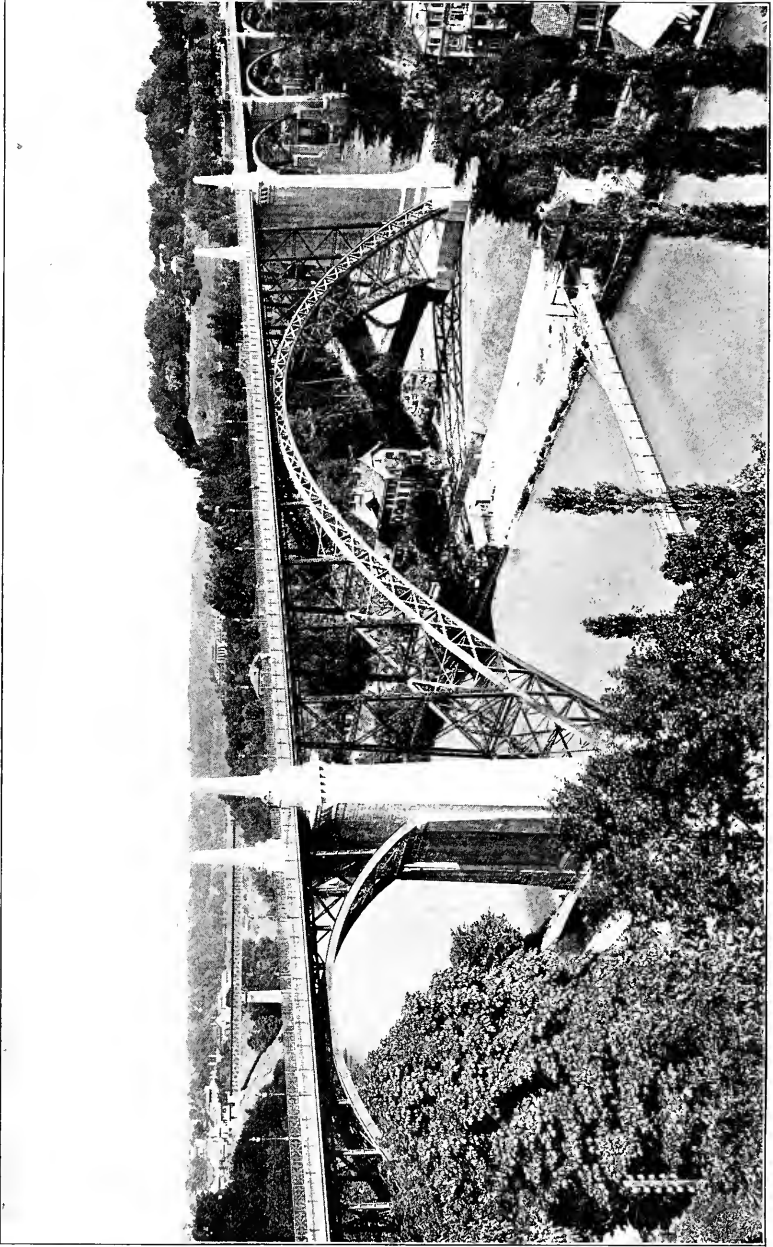

Fig. 231

FIGURE 231. The Kornhaus Bridge

The Kornhaus Bridge over the Aar at Berne, opened in 1898, carries a 41-foot highway at a height of 160 feet above the valley, on one large steel arch of 384 feet, and five smaller ones of 113 feet. The floor is on a 2.7 per cent grade, and the bridge was erected on full timber centering planked over, as for a masonry arch. The largest span contains two braced parabolic ribs without hinges, divided into thirty-four panels, the depth being 5.2 feet at the crown, increasing to 14.7 at the springs. The ribs, which have a rise of 104 feet, are 26 feet apart on centers at the crown, and slope out at the rate of one inch per foot to $43\frac{1}{2}$ feet apart at the shoes. Floor beams are 17 feet apart and the road is paved with wood blocks on concrete and galvanized buckle plates. The large arch is approached by a single one of 113 feet at one end, and by four of the same length at the other end. These small ones are plate box girders, 36 inches deep with about 38 feet rise. The weight of the main span is 991 tons, and the whole bridge, 1,995 tons, the cost, including foundations, being \$426,000.

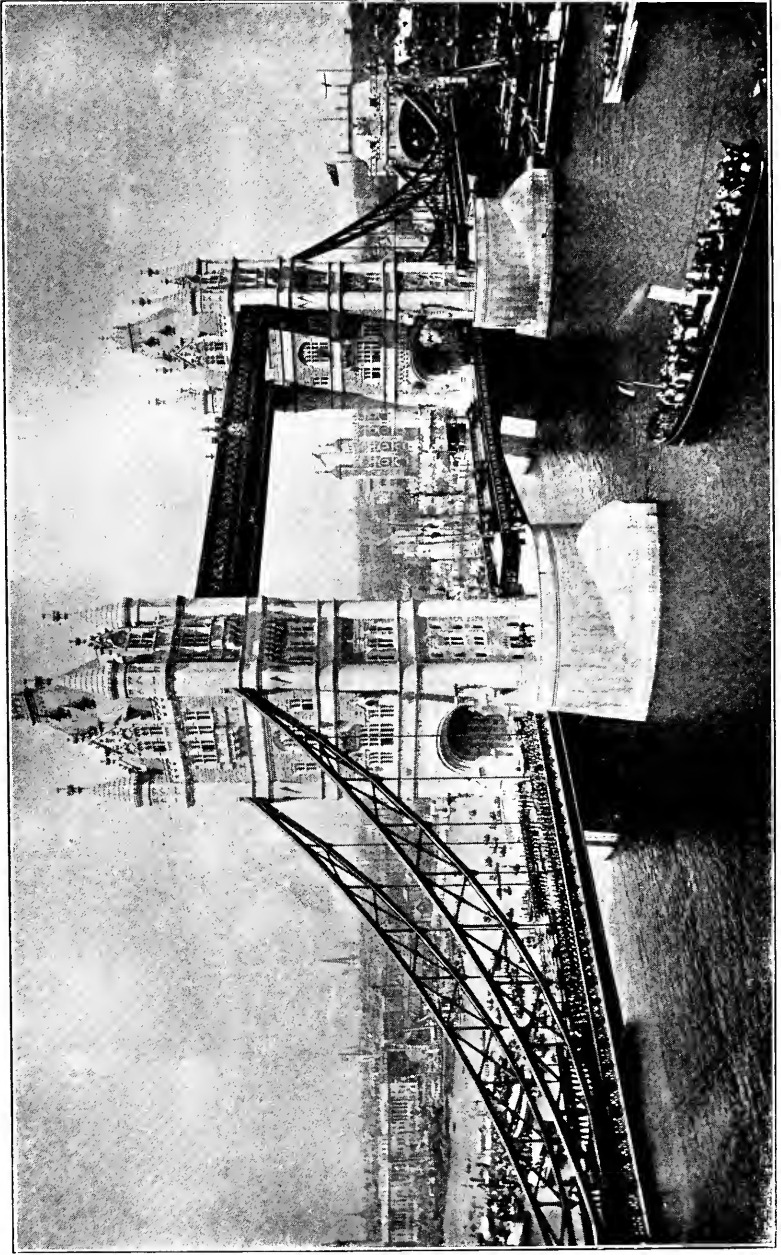

Fig. 232

FIGURE 232. The Tower Bridge, London

For twenty years or more, this bridge was the subject of discussion by engineers, architects and city officials, all of the designs, and especially the one built, being very severely criticized. It was under construction from 1886 to 1894, and formally opened for travel on June 30th. The engineer was Sir J. Wolfe Barry, and the architect Sir Horace Jones. The steel work alone cost \$1,685,000, and the entire structure \$4,146,800. The clear distance between faces of towers in the center span is 200 feet, and each of the two end spans has a clear width of 270 feet. Between the towers are two foot bridges with a headroom under them of 139 feet. These are reached by elevators and are used for pedestrian travel when the bascule leaves are open for the passage of ships. The total width between parapets is 50 feet on the open span, and 60 feet on the side spans and approaches. The structural parts of the towers are of steel enclosed with stone casing, and this feature and the method of cable stiffening, have been most severely criticized. The north and south approaches are 1,000 and 800 feet long, respectively, and the total length of the structure is 2,640 feet.

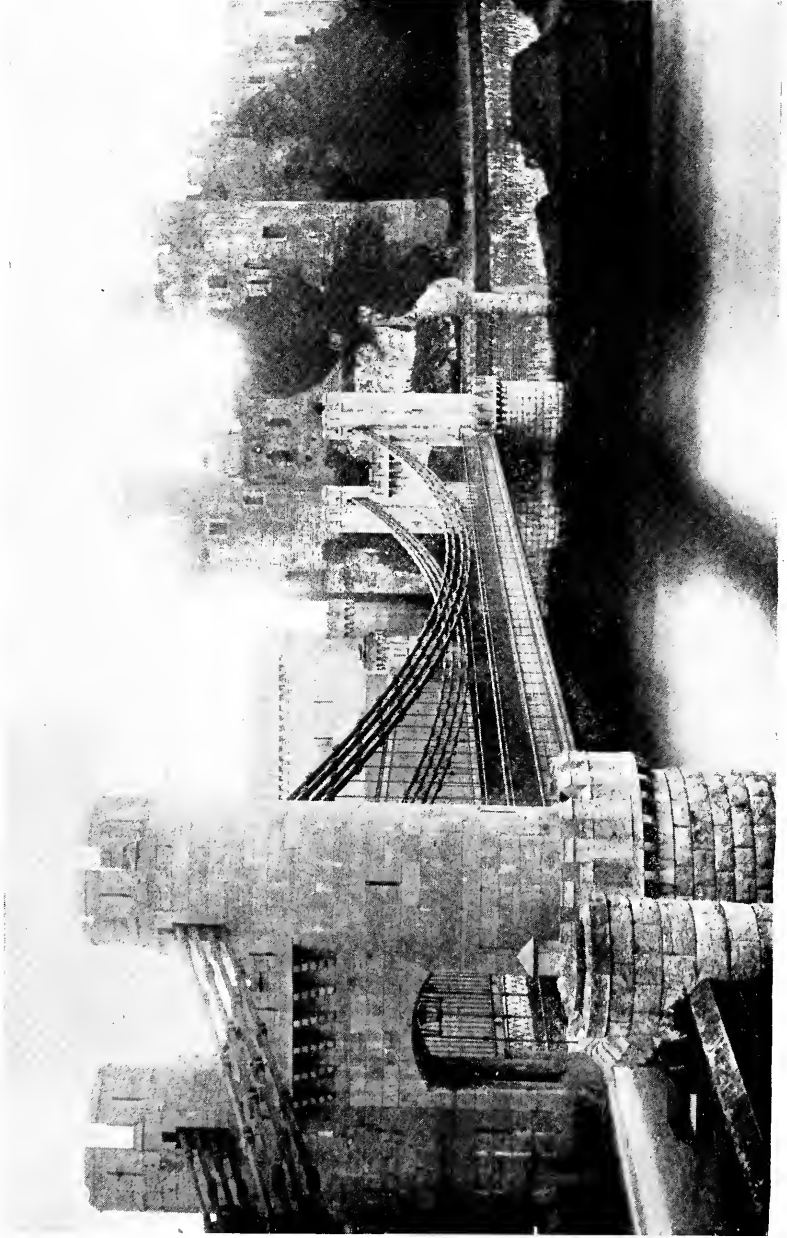

Fig. 233

FIGURE 233. The Conway Suspension

The town of Conway is situated on the east bank of the Conway river, Wales, and is the site of the famous old Conway Castle, now in partial ruins. The bridge has a span of 327 feet, and was designed by Thomas Telford, and constructed in 1826. On account of its proximity to the castle it was made to harmonize with its architecture, with round towers and battlements. For over eighty years it remained in its original condition, but was then found insufficient for modern loads, and was strengthened in 1904 by the addition of new anchorages, cables, suspension links and stiffening girders. A new 6-foot walk was also added on the north side, the cost of reinforcing being 6,500 pounds sterling. The engineers on reconstruction were J. J. Webster, Chief Engineer, and J. F. Jones, Resident Engineer.

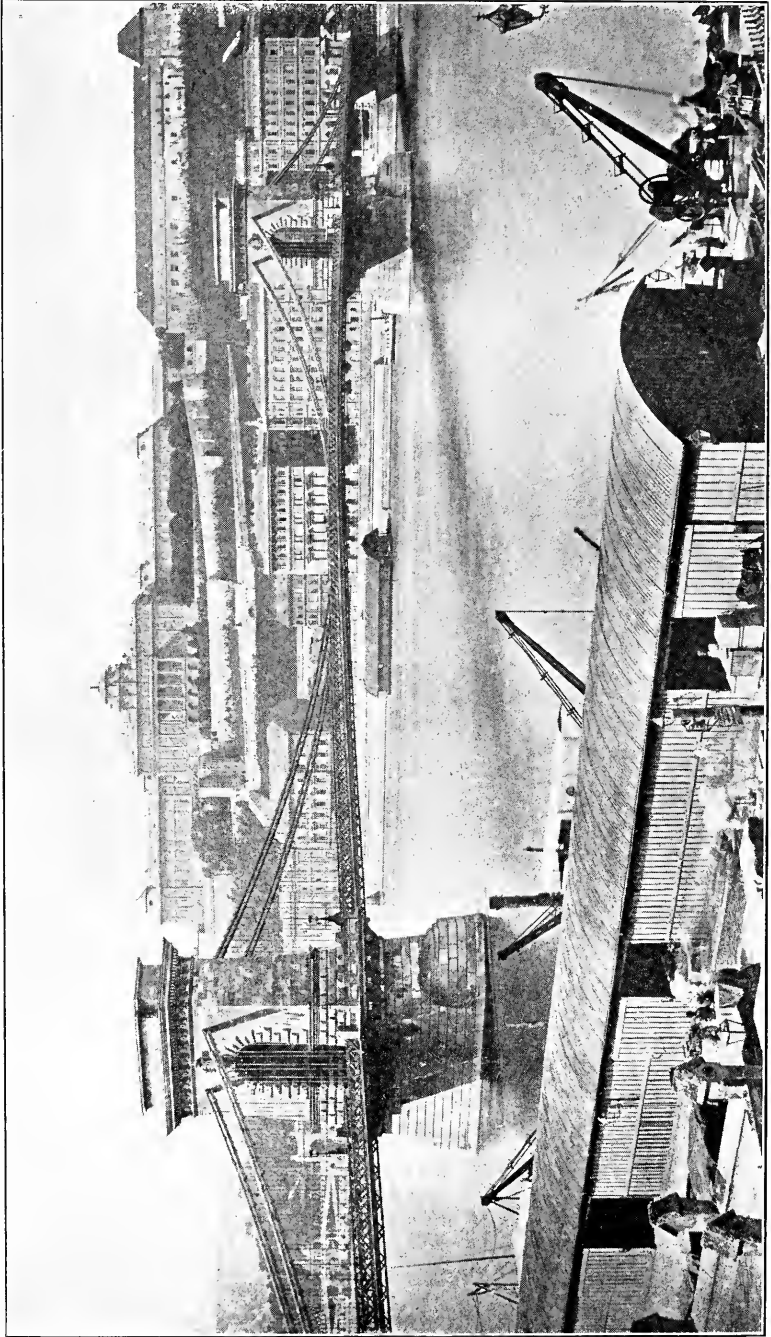

Fig. 234

FIGURE 234. The Budapest Suspension (1846)

Budapest has two very fine suspension bridges, perhaps the most beautiful ones in existence. The new Elizabeth bridge is exemplary in all its parts with chain cables and rocker towers. The bridge illustrated was designed by W. Tierney Clark, and was built during 1839 to 1845. It has a central span of 600 feet, and a total water way of 1,250 feet. The main piers show artistic treatment, both in outline and detail, and the combination of dressed and rock-faced stone work is pleasing. Piers are symmetrical, with cut-waters at both ends. The walks are carried out around the piers on brackets, and the parapets at this point are of stone, conforming with the other masonry. For some distance above the roadway the towers are of rock faced ashlar, terminating with a moulded cornice, above which, to the main cornice they are dressed stone ashlar, excepting the ring stones for the roadway arch, which are rock-faced. The upper cornice is heavily moulded and has modillions in its design. Over the sidewalks at the piers are heavy ornamental lamp standards rising from stone bases in the balustrade. At the four corners of the abutments adjoining the river, are pedestals surmounted by figures of reclining lions. Not content with beautifying the bridge itself, the city laid out gardens on the river bank about the entrance, thus making a proper setting for the structure.

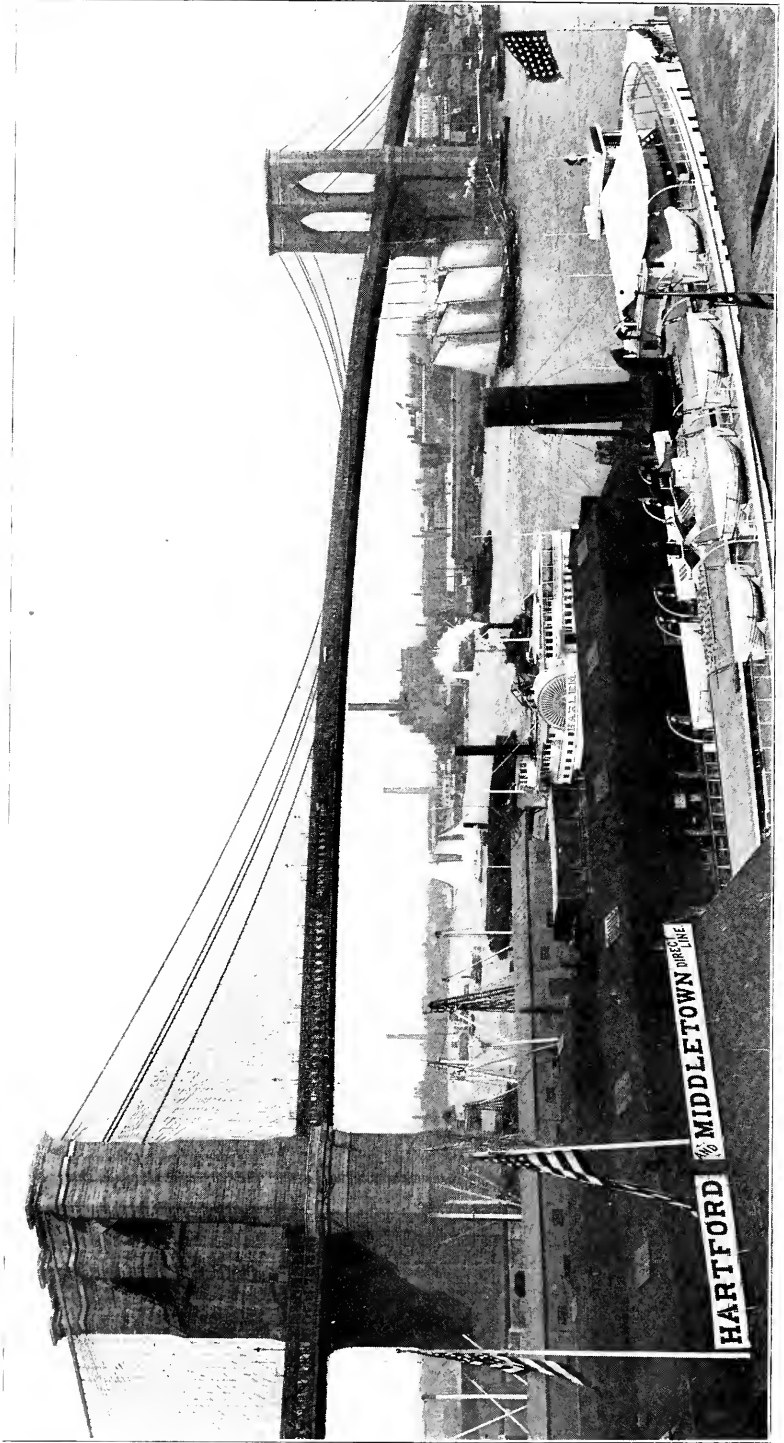

Fig. 235

FIGURE 235. The Brooklyn Bridge

For many years the most striking feature in the landscape about New York was the old Brooklyn Bridge, and although there are now three others over the East River; the first remains the most conspicuous from lower New York or from the harbor. It was started by John A. Roebling in 1870, and completed in 1883. The towers are 1,595 feet apart on centers, and the floor is carried by four cables, each $15\frac{3}{4}$ inches in diameter. The end spans are each 930 feet long, and it has a carrying capacity of two elevated railway tracks, two trolley tracks on the two 18-foot roadways, and a center 15-foot promenade. Its total width is 85 feet, and the length of the New York approach is 971 feet, the Brooklyn approach being 1,562 feet, making a total length of 5,989 feet. The height of towers above high water is 278 feet, and the clear head room under the bridge is 135 feet, the floor grade being $3\frac{1}{4}$ feet per hundred. The original cost of the bridge was approximately \$9,000,000, and the land \$7,000,000 more, making a total of \$16,000,000. Previous to the building of this bridge the longest suspension was only 1,000 feet. Plans were recently prepared for strengthening it by providing deeper stiffening trusses and an entirely new floor system. It is reported that not less than \$21,000,000 has been spent on this structure, including repairs, land and terminals. It extends from Park Row, New York, to Sands and Washington streets in Brooklyn.



Fig. 236

FIGURE 236. Sister Island Bridge, Niagara

Between the two Sister Islands at Niagara, and crossing the rapid water, is an unusual small suspension bridge shown in the accompanying illustration. From the two wire cables, the floor is suspended, and the whole is stiffened with wooden trusses. The location affords the sightseers a good opportunity to view the rapids. Niagara is famous throughout the world for its long span bridges as well as for its wonderful water falls, but some of the smaller bridges display more art than the larger ones.



Fig. 237

FIGURE 237. Poughkeepsie Bridge over the Hudson

The Central New England Railroad Company owned this bridge, and leased it to the New York, New Haven and Hartford Railroad Company. It was built in 1889 with two anchor spans of 525 feet, and three alternate cantilever spans of 548 feet, with two end spans of 200 feet each. The east approach is 2,640 feet long, while the west approach is 1,033 feet, the total length being 6,747 feet, and the track 212 feet above water. It was arranged for two tracks and originally had two lines of trusses 30 feet apart on centers, but in 1906 it was strengthened to carry heavier loads by inserting another line of trusses midway between the original ones and adding new columns in the towers. The longer approach spans were also reinforced and the shorter ones replaced by new plate girders. The reinforcing was done at a cost of \$1,300,000, the amount of new steel being 15,000 tons. The trusses have a depth of 37 to 57 feet, and the towers are approximately 100 feet high, standing on stone piers. The water under the long spans is 60 feet deep, making the cost of false work very high. Reconstruction was carried on under the direction of Mace Moulton, Engineer.

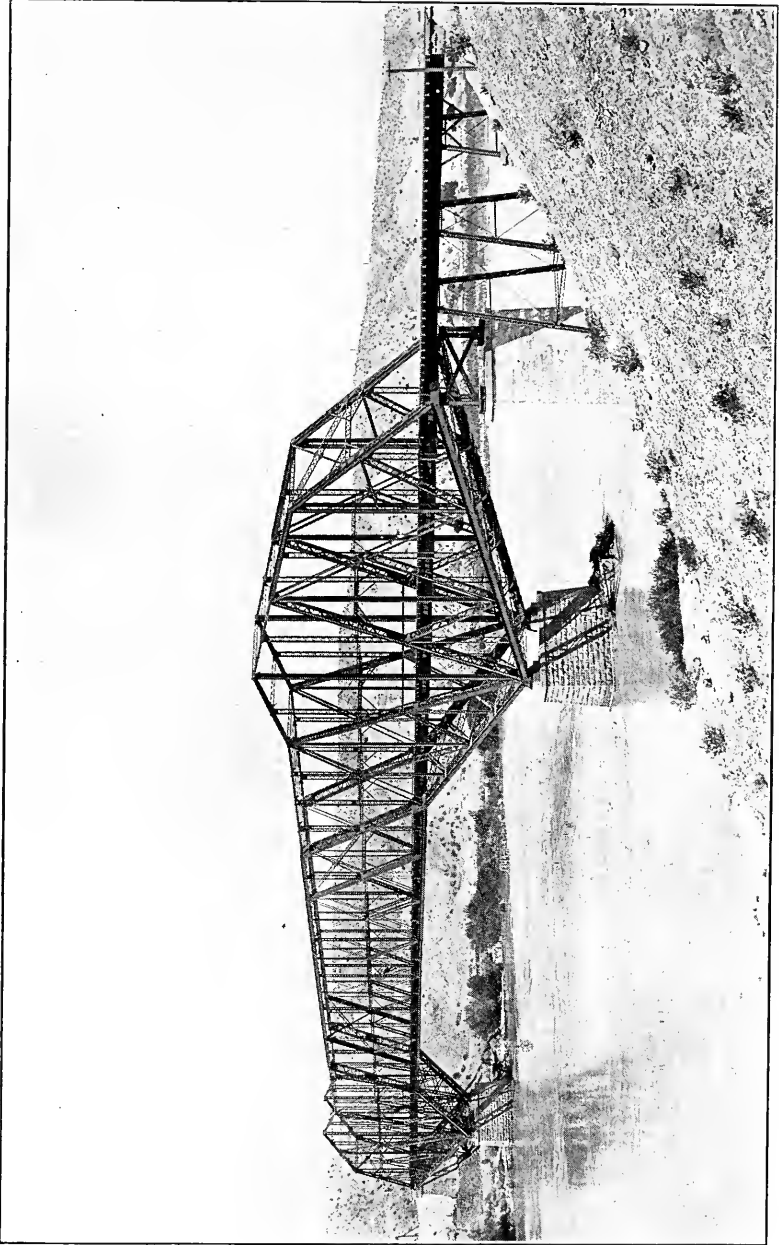

Fig. 238

FIGURE 238. Red Rock Cantilever

This structure carries a single line of railroad, and was completed in 1890. The shore and river arms of the cantilever are each 165 feet long, and the center suspended span is 330 feet, making the total length 990 feet. It was designed by J. A. L. Waddell, and at the time was the largest cantilever span in the United States. It contains 1,750 tons of steel and was erected in eighty days. The trusses are 25 feet apart on centers, and there is a clear under head room of 41 feet. It crosses the Colorado river and connects the states of Arizona and California.

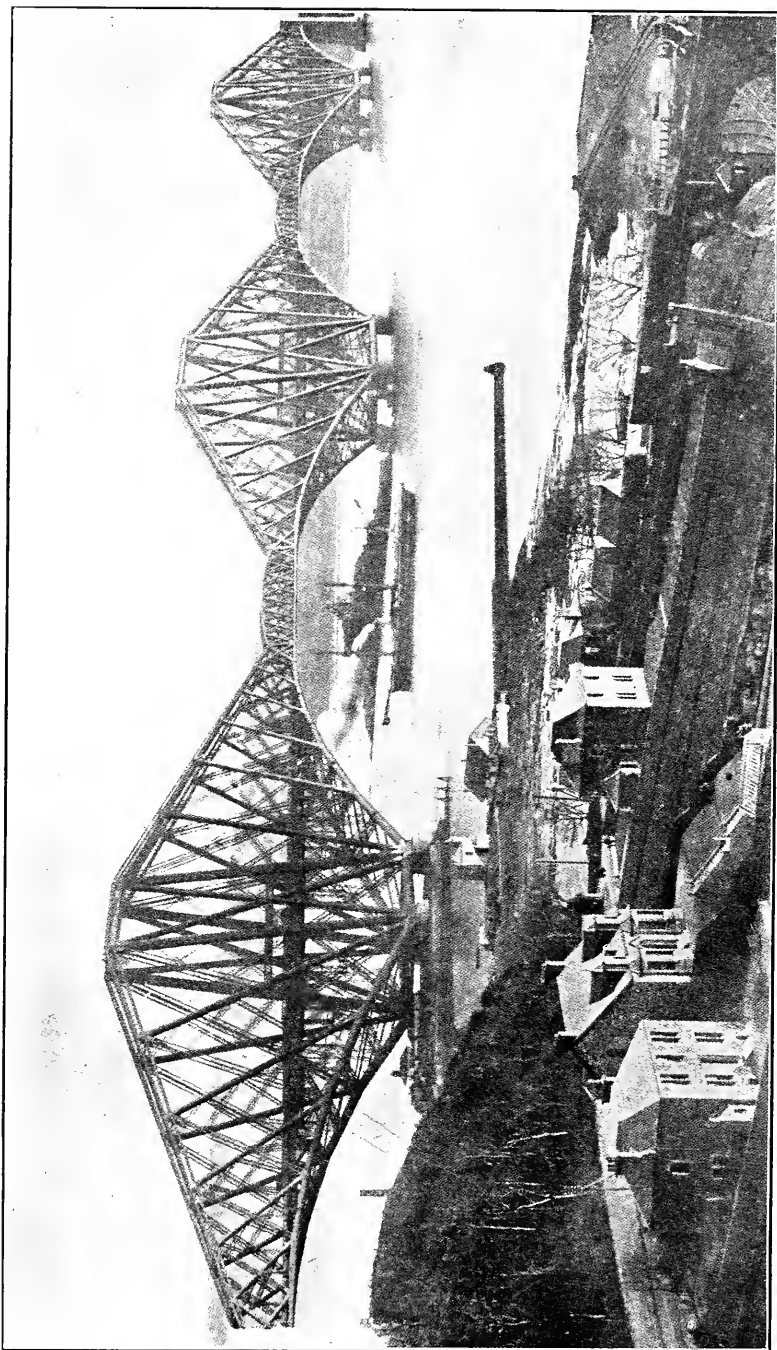

Fig. 239

FIGURE 239. The Forth Bridge

Several designs for a suspension bridge to cross the Firth of Forth, near the site of the present cantilever were made in 1818 by James Anderson of Edinburgh, with an estimated cost of about \$1,000,000. His outlines showed three spans with a space beneath of 90 to 110 feet for ships. It was not, however, until 1880 that a contract for the construction of a stiffened suspension with two spans of 1,600 feet, to cost \$10,000,000, was awarded on the plans of Sir Thomas Bouch, engineer of the first Tay bridge, but the collapse of the latter after only two years of service caused the contract for the Forth bridge to be annulled and new plans ordered from Messrs. Fowler and Baker. Foundations were commenced in January, 1883, and the structure was completed in 1890, after a period of seven years. It carries two lines of railroad, forming a direct connection between the north of Scotland and the south of England. The channel, which has a depth of 218 feet, is crossed by two spans of 1,710 feet with 680 feet anchor arms, between center and end towers 270 feet and 155 feet long, respectively, making a length of 5,360 feet, though the total length of bridge, including fifteen spans of 168 feet and five of 25 feet, is 8,296 feet. It was built by William Arrol & Company, the largest number of men employed at any one time being from 4,000 to 5,000. Clay under the foundations is loaded six tons per square foot. After completion it was found that the maximum center deflection under full loads was six inches. The bridge, without approaches, cost \$13,000,000, or \$16,135,000 total, equal to \$2,400 per lineal foot.

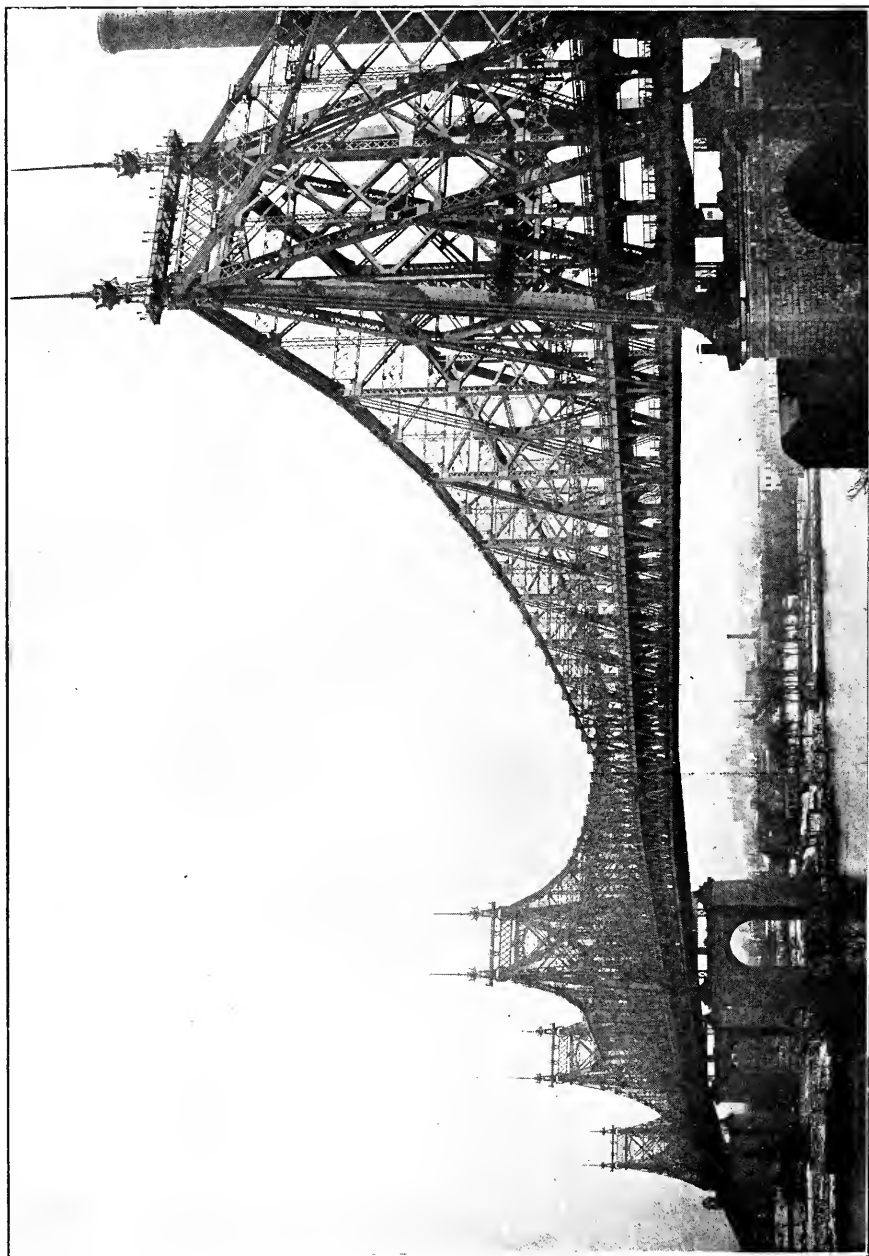

Fig. 240

FIGURE 240. Blackwell's Island, or Queensborough Bridge

The Blackwell's Island bridge (1901-09) is a continuous cantilever with unequal channel spans of 1,182 and 984 feet, at either side of the 630 foot anchor span over the island, the west and east shore arms being 469 and 459, respectively. The channel trusses are connected at the center without suspended span, making the stresses indeterminate. Two lines of parallel and vertical trusses, 60 feet apart on centers, support on the lower deck a center carriageway, with two car tracks on each side, the outer track the trusses, making the deck 86 feet wide. The upper platform being on a cantilever extension of the floor beams outside the trusses with cantilever promenade at each side. It is the first instance in which nickel steel has been used extensively for tension members and pins, and it contains approximately $13\frac{1}{2}$ tons of steel per lineal foot, costing $5\frac{1}{2}$ cents per pound in place. It was designed by the Bridge Department of the city of New York; contains the longest cantilever span in America, and is proportioned for heavier loads than any other bridge.

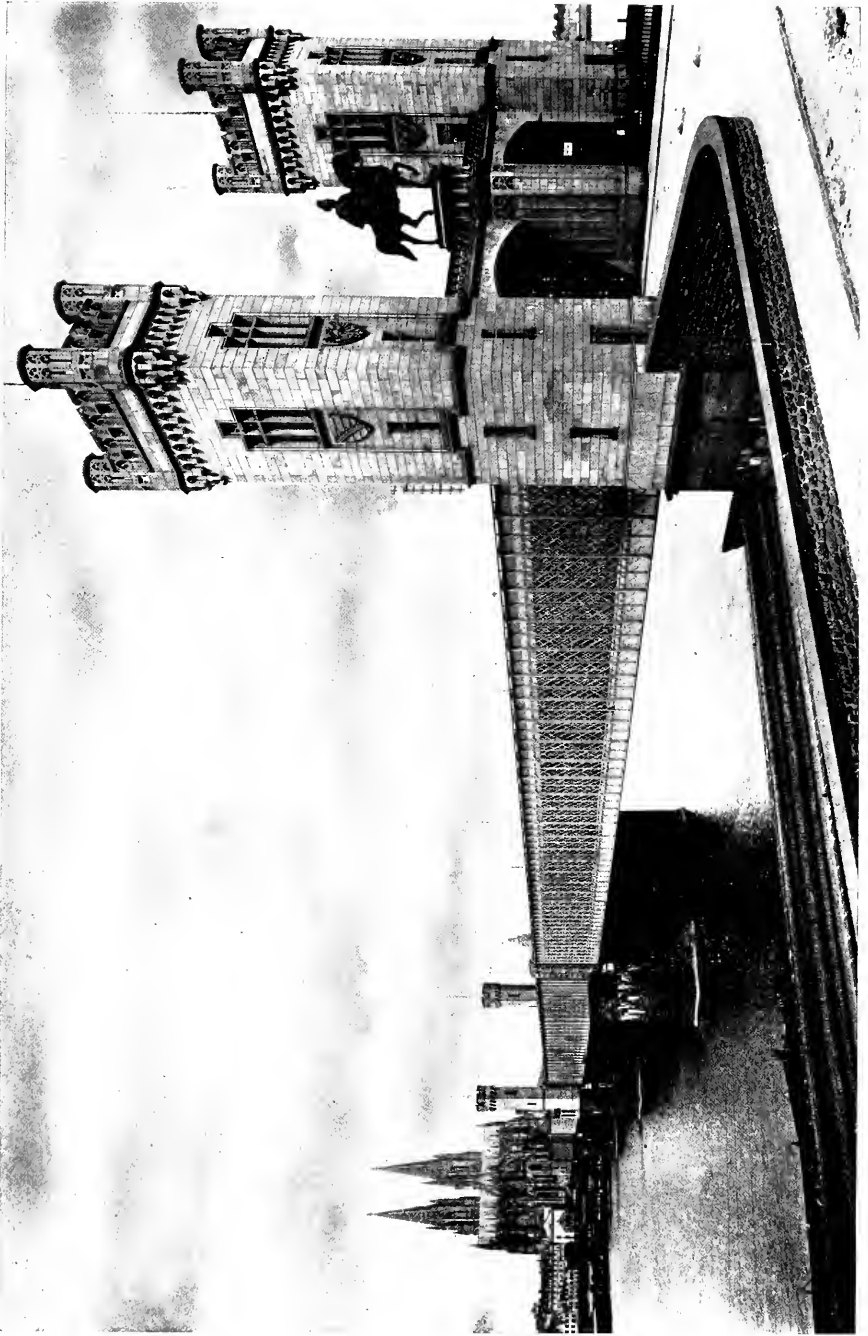

Fig. 241

FIGURE 241. Cologne Railroad Bridge

Crossing the river Rhine east of the great Cologne cathedral, is a railroad bridge of four spans, each being 322 feet, and the whole length 1,362 feet. It carries both railroad and highway in separate passages between the three lines of lattice girders. It was built during the years 1855 to 1859, and is 47 feet above average water level. Over the entrance on the Cologne end is an equestrian statue of William IV in bronze, while at the other end is a similar statue of William I, both of which were erected in 1867. The bridge connects Cologne on the left bank of the river with Deutz on the right. Square masonry towers on either side of the entrance are ornamented with battlemented cornice.

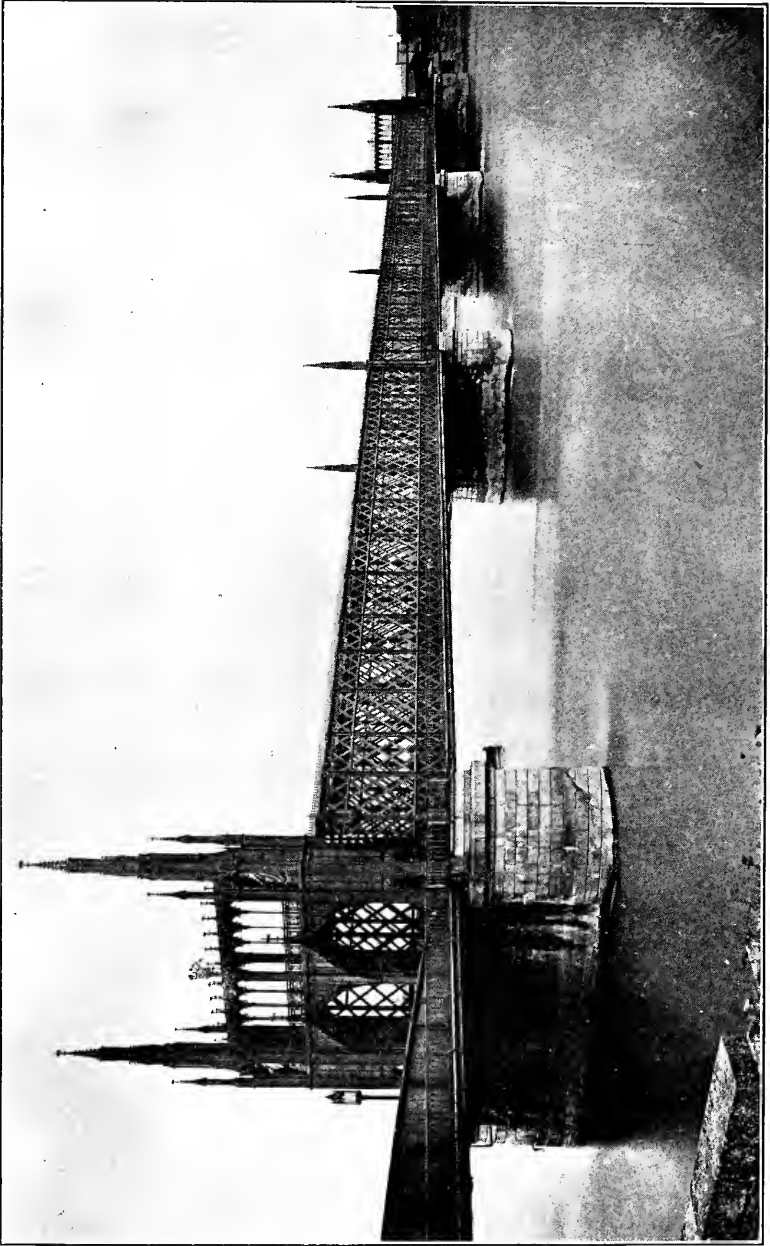

Fig. 242

Figure 242. Kehl Railroad Bridge

This bridge crosses the River Rhine at Kehl, about two miles from Strassburg, Germany, and carries two lines of the Baden State Railway. It was built during 1858-60, and was designed by Keller. There are three main lattice girder spans 197 feet in length, continuous over the piers, and each span has three girders with single lattice webs, while at one end are four additional spans of 85 feet and a draw. The footpaths at the sides are supported on brackets from the outer trusses, and the outside length is 303 meters. Gothic portals at the entrance are fine examples of ornamental iron work, and there are also iron towers over the river piers. The portal arches, with their statues and crosses, are suggestive of cathedrals. In ancient times the building of bridges was considered a sacred duty, and the work was often entrusted to priests, who were given the name of Pontifices. It is appropriate, therefore, that decorative features should sometimes be ecclesiastical in character in memory of the traditions of early bridge building.

INDEX OF PERSONS

PAGE		PAGE	
Adrian	6	Kellar, George	125
Agrippa	5, 175	Krohn, Reinhold	259, 261
Anderson, L. W.	219	Laing, T. E.	65
Anderson, James	281	Landor, E. J.	211
Angelo, Michael	181	Lindenthal, Gustav	72, 89
Antonio da Ponte	181	Luten, D. B.	235
Arrol, Sir William & Co.	281	Matthyssens, M. H.	65
Augustus, Caesar	5	Meigs, General M. C.	185
Babb, Cook & Willard	217	Michael Angelo	181
Baker, Sir Benjamin	183, 281	Moehring, Bruno	259
Barry, Sir John Wolfe	267	Moisseiff, L. S.	197
Bates & Rogers	211	Moorsom, Captain	65
Bayley, J. P.	65	Moulton, Mace	277
Beach, Capt. L. H.	155	Mueser, Wm.	Preface
Biddle, Col. John	155	Newcomer, H. C.	155
Boller & Hodge	239, 241	Newton Engineering Co.	151
Bouch, Sir Thomas	281	Newton, Ralph	61
Buchholz, C. W.	191	Olmstead, F. L. & Co.	147
Burr, Wm. H.	25, 197	Osborn Engineering Co.	211
Clark, W. Tierney	271	Oudry, M.	90
Concrete Steel Engineering Co.	Preface	Palmer & Hornbostel	131
Cruttwell, E.	183	Paine, Thomas	3
Cullen, F. J.	211	Parker, George A.	23
Doane, W. H.	247	Pelz, Paul	Preface, 243, 245
Douglas, W. J.	155	Perronet, Jean R.	108
Duggan, G. H.	247	Peterson, P. A.	247
Dunne, W. M.	209	Quimby, H. H.	199
Eads, Capt.	31, 84	Rennie, John	113, 183
Emperger, F. von	157	Rennie, George	183
Fidler, T. C.	71	Reynolds, A. M.	217
Fitzgerald, Mr.	189	Roebbling, John A.	273
Fowler, Sir John	281	Roper, Oscar	65
Hartwich, M.	253	Rusche, J. P.	219
Hastings, Thomas	Preface, 1	Sanne, Oscar	141
Hewett, W. S.	193	Schwedler, Herr	91
Hinckley, H. V.	227	Scofield Co.	213
Ingersoll, C. M.	197	Shaw, Edward S.	61
Jervis, John B.	187	Shepley, Rutan & Coolidge	143, 145
Jones, J. F.	269	St. Benezet	6
Jones, Sir Horace	267		
Keepers & Thacher	227		

	PAGE		PAGE
Steiner, Charles	81	Tyrrell, H. G.	43, 52, 53
Stephenson, George	32		55, 64, 71, 72, 76, 79, 167
Symonds, Capt. T. W.	243	Vautelet, H. E.	247
Telford, Thomas	14, 95, 109	Waddell, J. A. L.	279
Thacher, Edwin	227	Walker & Kimball	147
Thomson, Thomas K.	247	Warren, Whitney	Preface
Trajan	102	Webster, George S.	199
Tubesing, W. F.	219	Webster, J. J.	269
Turneure, Prof. F. E.	151	Witmer, Mr. and Mrs.	17

GENERAL INDEX

PAGE	PAGE		
Abutments	113	Chinese Bridge Builders	5
Alcantara Bridge	29, 179	Chord Outline on Cantilevers	69
Alexander III Bridge at Paris	82, 255	Clearance under Bridges	56
Algoma, Bridge in	54	Cleveland Concrete Bridge	46, 205
Anchorage for Cables	100	Coblenz Steel Arch	253
Approaches	88	Cologne, Designs for	65
Arches, Metal	75	Cologne, Truss Bridge over Rhine at	285
Arches, Type	77	Color of Materials	125
Arches, Form of	84	Columbian Park, Lafayette	165
Architects, Services of	4	Competition, Result of	24, 25
Architects, Co-operation of	24, 26, 38	Como Park, Bridge	161
Art Standards	19	Concrete Beam Bridges	51, 52
Art Standards, Absence of	24	Concrete Park Bridges	149 to 165
Art, Cause for Lack of	24	Conformity with Environ- ments	20
Artistic Bridges, Reasons for	16	Contrast	42, 46
Atlantic, Bridge over	12	Conway Suspension	269
Auteuil Viaduct, Paris	30, 32	Croton Aqueduct Bridge	187
Avignon, Bridge at	6	Cubzac Suspension	92
Balustrades, Designs for	117	Curve of Arch	107
Bascule Bridges	58, 59	Dayton Bridges	211
Beam Bridges	50	Derby (Conn.) Bridge	237
Belle Isle Park Bridges	37, 137, 164	Deck Bridges	36, 41
Blackwell's Island Cantilever	283	Decks, Number of	56, 57, 59
Bonn Bridge over the Rhine	23, 80, 259	Deck and Springs, Relative Position of	77
Boston Bridges	24, 143	Deck of Masonry Bridges	103
Boston Public Garden	171	Design, Principles of	38
Britannia Bridge	32	Detroit, Bridges at	37, 137
Brooklyn Bridge	7, 273	Dimensions, General	41
Budapest Suspension	271	Dominion Bridge Co.	71
Cabin John, Washington	185	Dredge Suspension	91
Cables	97	Duesseldorf Bridge over the Rhine	80, 261
Cahors, Bridge at	30	Easton Suspension Bridge	93
Cantilever Bridges	67	Echo Bridge, Newton, Mass.	189
Cantilever Bridges, Views of	277 to 283	Economic Use of Materials	20, 21
Cernavoda Cantilever	69	Eden Park Arch	157
Chatsworth Bridge, England	195		
Chicago Swing Bridges	64		

	PAGE		PAGE
Elizabethtown Bridge	53	Indianapolis Concrete Arches	221, 223
Ellipse	108	Interlaken Bridge, Minneapo-	193
Emerichsville Arch Bridge	225	lis	193
Engineers, Training of	24	Jamestown (Va.) Concrete	213
English Channel Bridge	12	Bridge	52
Environment, Conformity with	20, 42, 47	Jordan River Bridge	177
Expressiveness	42, 44	Karlsbruecke at Prague	287
Features of Bridges	29	Kehl Bridge over the Rhine	32
Financial Limitations	24	Kinds of Bridges	86, 265
Florence, Italv, Bridges	29, 30	Kornhaus Steel Arch at Berne	24
Forest Hills, Boston	145	24
Forest Park Entrance, St.	43	Lack of Art, Causes for	165
Louis	43	Lafayette (Ind.) Bridge	151, 169
Form of Metallic Arches	84	L a k e Park (Milwaukee)	24
Forth Bridge	281	Arch	93
Garfield Park Suspension	139, 173	Legal Hindrances to Art	86, 251
.	83	Lehigh River Suspension	24
Garabit Arch	91	Lincoln Park Steel Arch	65
Gliscard Suspension	45	Literature on Artistic Design	28
Gothic Portals	56	Lift Bridges	135
Grade of Bridges	103	Location, Effect on Design	13, 183
Grand Avenue Bridge, Mil-	219	Log Arch at Washington	143
waukee	207	London Bridge	35, 41
Grand Rapids Concrete Arch	207	Long Spans	65
Grand Tower (Ill.) Con-	231	Lubeck Swing Bridge	43, 167
crete Bridge	104	Madison (N. J.) Park Bridge	11
Green Island Bridge, Niag-	77	263
ara	65	Magnitude of Bridges	96
Grosvenor Stone Arch	42, 46	Manz Steel Arch over the	215
Grunenthal Metal Arch	31	Rhine	101
Halsted Street Lift Bridge	24, 25	Manhattan Suspension	101
Harmony	187	Marion County Concrete	139 to 147
Hartford Bridge	24	Span	42, 48
Hasty Construction, Effect	73	Masonry Bridges	20
of	89	Masonry Park Bridges	24, 27
High Bridge, New York	239, 241	235
City	39, 197	Maumee River Bridge, Water-	17
Hindrances to Art	159	ville	239 to 265
History of Bridge Engineer-	9	Memorial Bridges	167 to 169
ing	9	Metal Arch Bridges	167 to 169
Hell Gate Arch	9	Metal Arch Park Bridges	167 to 169
Hudson Memorial, Proposed	9	167 to 169
Steel Arch	9		
Hudson Memorial B r i d g e	9		
.	9		
Hyde Park Bridge	9		
Importance of Bridges	9		

	PAGE		PAGE
Metal Bridges, Beginning of.	3	Philadelphia Bridges	31, 44
Middletown Swing Bridge	64	Piers	41
Minneapolis Park Bridges	133	Piers of Masonry Arches	109
Monterey (Mexico) Bridge	31	Piers of Metal Arches	87
Montreal River Bridge	54	Pins or Hinges for Metal Arches	81
Motive in Design	41	Plauen, Arch at	34
Movable Bridges	56	Pont du Gard	5, 175
Mungsten Arch	83	Ponte Vecchio, Florence	29
Nature, A Guide in Design	38	Pontifex Maximus	45
Newark (N. J.) Concrete Arch	217	Portal Decorations	32
Newell Avenue Bridge, New York	163	Potomac River Bridge, Pro- posed	40
Newton Creek Bridge	61	Potomac Memorial, Washing- ton, D. C.	201, 203, 243, 245
New York City Bridges	1, 2, 6	Poughkeepsie Cantilever	277
Niagara Arches	78, 89, 245	Prague, Bridge at	91
Niagara Falls Concrete Arch	231, 233	Primitive Bridges	9, 10
Niagara Suspension	275	Professional Vandals	25
Northampton (Mass.) Bridge	17	Progress in Bridge Building	10
North River Bridge, Pro- posed	97, 98	Purpose, Exhibition of	20, 21, 41
Northwestern Avenue, Indian- apolis	223	Quebec Bridge	12, 68, 71
Ogden Viaduct, Proposed	55, 56	Queensborough Bridge	68
Oporto Arch	83	Railings	122
Ordish Suspension	91	Railroads, Effect on Bridge Building	3
Ornament, Use of	20, 42, 49	Railroad Bridges as Proto- types	24, 27
Ornament, Degree of	35	Reasons for Artistic Bridges	16
Ornamentation of Cantilevers	73	Red Rock Cantilever	279
Ornamentation of Metal Arches	89	Reinforced Concrete Bridges	197 to 237
Outline, Pleasing	20, 22	Relation of Bridges to Human Progress	13
Panther Hollow Bridge, Pittsburgh	249	Rialto, The, at Venice	29, 181
Paris Bridges	13, 30, 255	Rigid Suspensions	100
Parapets	117	Rimini, Bridge at	5
Park Bridges	43	Roads and Bridges	14
Park, Bridges, Concrete	149 to 165	Roche Bernard Suspension	95
Park Bridges, Masonry	139 to 147	Rock Creek Bridge, Wash- ington	155
Park Bridges, Metal Arches	167 to 169	Rocky River Arch, Cleveland	205
Park Bridges, Rustic	131 to 137	Roebing's Suspension	94
Park Bridges, Suspension	171 to 173	Rome, Bridges at	13, 33
Persia, Bridges of	30	Roman Bridges	5, 6
Peru (Ind.) Concrete Arch	229	Ruskin's Rules of Art	49
		Rustic Park Bridges	131 to 137
		Rustic Bridges	9, 10

	PAGE		PAGE
Saintes Bridge	48	Suspension Park Bridges	171 to 173
Salmon River Cantilever..	71, 72	Swing Bridges	63
Salmon River Steel Arch...	247	Symmetry	42, 45
Salmon River Viaduct, Pro-		Symmetry, Absence of.....	24
posed	55	Symmetry of Approaches....	88
San Francisco Park Bridges.	131	Symmetry, Lack of in Stone	
Schwedler's Design for Co-		Bridges	102
logne	91	Terminals, Railroad	26
Schenley Park Arch.....	106	Terre Haute Concrete Arch.	209
Seine River at Paris.....	82	Thermopylae Metal Arch....	85
Shape of Masonry Arches..	107	Topeka Concrete Arch. 106,	227
Shelters at Movable Bridges.	32	Tower Bridge, London. 92,	267
Simplicity, A Principle of De-		Towers of Bascules.....	61, 62
sign	42, 45	Towers for Metal Arches... 87	
Sister Island Suspension, Ni-		Towers for Suspension Bridges	
agara	275	93, 97
Skew Crossings	50	Training of Engineers.....	24
Spandrel Framing of Metal		Transporter Bridges	66
Arches	75	Trestles, Steel	54
Spandrels of Masonry Arches.	104	Truss Bridges ... 53, 285 to	287
Span Limits	12	Type, Selection of.....	34
Spans, Number of, in Suspen-		Ugly Bridges	18
sion Bridges	93	Union Park, Chicago.....	153
Springs of Arches, Eleva-		Value of Bridges in Amer-	
tion of	86	ica	11
Springs of Masonry Arches..	108	Venice Bridges	1, 29
Spuyten Duyvil Creek Bridge	33	Walnut Lane Bridge, Phila-	
St. Angelo, Rome.....	30	delphia	199
St. Chamas Bridge.....	29	Washington, Proposed Bridge	
St. Louis, Mo.	43	at	17, 40
Standards of Art.....	19	Washington (D. C.) Pro-	
State Supervision, Absence of		posed Memorial at... 243, 245	
.....	24, 28	Waterville, Bridge at.....	235
Steel Bridges, Objection to..	34	Wayne Street Bridge, Peru,	
Steel Structures	50	Ind.	229
Stiffening of Cables.....	99	White River Bridge, Indian-	
Stockbridge (Mass.) Concrete		apolis	221
Arch	149	Williamsburg S u s p e n -	
Stone Arch Bridges.. 175 to	195	sion Bridge	94
Stony Brook Bridge, Boston.	147	Wissahickon Creek Arch....	191
Surface Finish	125	Worms, Highway Steel Arch.	257
Suspension Bridges, History of	90	Yellowstone Park Arch....	157
Suspension Bridges, Illustra-		Yunnan Steel Arch, China..	84
tions of	267 to 275	Zanesville Concrete Arch... 211	
Suspension Bridge Type....	91		

BOOKS

BY

HENRY GRATTAN TYRRELL, C. E.



CONCRETE BRIDGES AND CULVERTS

Flexible leather; $4\frac{1}{2} \times 6\frac{3}{4}$ inches; 272 pages; 66 illustrations. Price, \$3.00



HISTORY OF BRIDGE ENGINEERING

Cloth binding; 6 x 9 inches; 480 pages; 330 illustrations. Price, \$4.00



MILL BUILDINGS

A Treatise on the Design and Construction of

MILL BUILDINGS AND OTHER INDUSTRIAL PLANTS

Cloth binding; 6 x 9 inches; 450 pages; 650 illustrations. Price, \$4.00



ARTISTIC BRIDGE DESIGN

A Systematic Treatise on the Design of

MODERN BRIDGES ACCORDING TO AESTHETIC PRINCIPLES

Cloth Binding; 6 x 9 inches; 300 pages; 150 illustrations. Price, \$3.00



Date Due

MAR 5 '36			
FEB 23 '50			
FEB 23 '50	<i>765</i>		
JUL 19 1990			
MAR - 6 1992			
MAY 17 1994			
NOV 13 1994			
JAN 18 1996			
Ⓢ			

3-

58758

BOSTON COLLEGE



3 9031 01513710 2

58758
Tynard, H. G.
AUTHOR

Artistic Bridge Design
TITLE

BOSTON COLLEGE LIBRARY
UNIVERSITY HEIGHTS
CHESTNUT HILL, MASS.

Books may be kept for two weeks and may be renewed for the same period, unless reserved.

Two cents a day is charged for each book kept overtime.

If you cannot find what you want, ask the Librarian who will be glad to help you.

The borrower is responsible for books drawn on his card and for all fines accruing on the same.



