



THE LIBRARY
OF
THE UNIVERSITY
OF CALIFORNIA
LOS ANGELES

Gift of
Dr. C. R. Darwood

Penwood, M.T.



TABLET TO CRAWFORD W. LONG
First to use ether as an anæsthetic in surgery, March 30, 1842.

THE ART OF ANAESTHESIA

BY
PALUEL J. FLAGG, M.D.

LECTURER IN ANÆSTHESIA, FORDHAM UNIVERSITY MEDICAL SCHOOL, ANÆSTHETIST TO
ROOSEVELT HOSPITAL; INSTRUCTOR IN ANÆSTHESIA TO BELLEVUE AND
ALLIED HOSPITALS, FORDHAM DIVISION; CONSULTING ANÆSTHETIST
TO ST. JOSEPH'S HOSPITAL, YONKERS, N. Y. FORMERLY ANÆS-
THETIST TO THE WOMAN'S HOSPITAL, NEW YORK CITY

136 ILLUSTRATIONS



PHILADELPHIA AND LONDON
J. B. LIPPINCOTT COMPANY

COPYRIGHT, 1916, BY J. B. LIPPINCOTT COMPANY

*Electrotyped and Printed by J. B. Lippincott Company
At the Washington Square Press, Philadelphia, U. S. A.*

HC
-20
F597
1716

To
I. H. S.
MY DEAREST MASTER
THIS BOOK
IS HUMBL Y DEDICATED

624469

PREFACE

THE proper administration of an anæsthetic is more than a mere mechanical performance, it is an art.

The *Art of Anæsthesia* is acquired by becoming familiar with the laws which govern its administration and by developing the ability to properly correlate and apply these laws.

It will be perceived that while a knowledge of laws is essential, yet this knowledge is superseded by the ability to properly apply them. This controlling element is what constitutes the essence of the art. Experience begets dexterity, tact and skill. These qualities, while somewhat intangible, are nevertheless indispensable. They imply a correct and spontaneous response to the demands of the patient.

The *Art of Anæsthesia* is not contained within any particular mode of administration. So-called empirical, percentage and shock-absorbing methods have their place, but should not be permitted to dominate over the art in its broader sense. They are its tools and must be observed from a point of view which considers the surgeon, the patient, the time, the place and many other factors.

Since familiarity breeds contempt, the anæsthetist must never forget to approach each case with a certain degree of courtesy and respect, for the possibilities of success as well as of failure in each are almost unlimited.

A thousand anæsthesias, instead of leading to crudeness, should make one a thousand times more careful. As one proceeds, one should try to formulate laws, and these one should strive to prove by the next case.

The *Art of Anæsthesia* implies an intimate knowledge of general medicine, pathology, surgery, therapeutics, psychology and special branches. Those who are not familiar with these subjects cannot understand the language of anæsthesia.

For example, how can a lay person intelligently form an opinion upon such vital matters as acidosis, toxæmia, carbon dioxide, stimulation, and depression? How can he unravel and relieve the untoward symptoms which might arise in a case complicated by respiratory obstruction, morphine depression, and reflex inhibition?

Death, due to anæsthesia, is not an unheard-of thing in lay conversation. As a consequence some timidity exists towards the taking of an anæsthetic. Intelligent people often ask: "How does Dr. — know that I can safely take an anæsthetic?" This fairly common query implies not only the necessity of a preliminary examination, but of an examination by a physician. Aside from this consideration, a surgeon can ill afford to let the public know that he is willing to risk the patient's life at the hands of an anæsthetist who is not a medical man. Does not this very evident lack of concern imply to the mind of the thoughtful patient a greater lack of care which may include the operative procedure?

A layman who administers an anæsthetic is like a blind guide who is led by the patient, instead of leading him. Unable to properly anticipate the stages of an operation he cannot judge the indications for artificial stimulation.

Those who relegate anæsthesia to the layman, place the responsibility of the outcome on their own shoulders.

To give an anæsthetic is one thing, to practice the *Art of Anæsthesia* is another.

This book, therefore, is intended as a groundwork, upon which the student, interne, and general practitioner may acquire a more comprehensive knowledge of the *Art of Anæsthesia*. Without an understanding of the broad truths which underlie present day anæsthetization, clinical experiences and reference reading will lose much of their value.

It is proposed to describe anæsthesia as the student will actually find it.

The *history of anæsthesia* has been briefly considered. A resumé of the entire field of anæsthesia is then attempted by defining and describing *general, local* and *mixed* anæsthesia. *General anæsthesia* is then taken up in detail. A classification of the stages of anæsthesia based upon circumstances present in all methods and by all anæsthetics is much to be desired. It has been found in practice that a classification made up of the stages of *induction, maintenance and recovery* meets these requirements admirably. Such a classification is easily demonstrated and grasped. At the conclusion of an elaboration of these stages we have appended a summary, which will be found valuable for reviewing and quizzing purposes.

The *classification of the stages of anæsthesia* forms a basis upon which we may intelligently attack the problem of the *signs of anæsthesia*. Ether being the most widely used anæsthetic, we have thought it wise to use this type of anæsthesia as a basis.

The *classification of the stages of anæsthesia* forms a basis upon which to consider the *administration of ether anæsthesia*. The various methods employed, *oral insufflation, intrapharyngeal insufflation, intratracheal insufflation, rectal* and *intravenous methods* are fully discussed.

General anæsthesia by *ethyl chloride, chloroform, nitrous oxide, nitrous oxide and oxygen*, and *nitrous oxide oxygen ether* are then taken up, the *stages of anæsthesia* in each case forming a common basis for the administration and the signs described.

In accordance with the resumé suggested above, *local anæsthesia* is then discussed. A chapter on *mixed or spinal anæsthesia* follows.

Medication preliminary to anæsthesia is next taken up. This is followed by a chapter on *carbon dioxide and re-breathing*. Bearing in mind the needs of the *general practitioner*, a chapter on *emergency anæsthesia* has been prepared. Last, but not least, we recommend the *patient's point of view* to the earnest anæsthetist.

The collection of table positions which are presented in connection with the *classification of the stages of anæsthesia* is, it is believed, quite complete.

Chapters I, II, III, IV, XIII, XIV, XVIII and XX have been written with the needs of the trained nurse in mind.

In conclusion the author wishes to take this opportunity to thank Dr. G. W. Crile for the hospitality extended him while in Cleveland, during which visit he was enabled to study the method of *anoci association*, so earnestly and constantly advocated by his charming host. He is also indebted to Dr. John B. Murphy for courtesies extended while visiting his clinic in Chicago, and is under deep obligations to Dr. Charles Mayo for a delightful visit to his remarkable clinic: to the gentlemen of the American Surgical Society indebtedness is expressed for many privileges extended while visiting in the West.

To Dr. C. N. Dowd the author is indebted, not only

for innumerable courtesies, but for the help which he has offered in curtailing crudeness in this book; to Dr. Lucius Hotchkiss for having made much of this book possible; to Dr. Karl Connell for having explained the use of the Anæsthetometer, and for the loan of original illustrations; to Dr. L. Booth for illustrations on intratracheal insufflation. To the Attending Staff of Fordham Hospital and to the Faculty of Fordham University Medical School indebtedness is acknowledged for much encouragement and support, as well as to the Attending Staff of the Woman's Hospital, with whom many pleasant hours have been passed.

Acknowledgment is made to Dr. K. Dwight for assistance in the classification of the stages of anæsthesia. To Berchman Bittl, O. M. Cap., and an old friend Robert Getty for reading the proofs. To Dr. A. Bruno for assistance in preparing many of the illustrations. To Dr. L. De Yoe for preparing the index. To the daughters of the late Dr. C. W. Long, the discoverer of ether anæsthesia, grateful acknowledgment is made for photographs and pamphlets relating to the discovery of ether anæsthesia.

For the loan of illustrations credit is due Appleton & Co., *The Modern Hospital Magazine*, *The Journal of the American Medical Association* and *Old Penn*.

Finally to J. B. Lippincott Co. gratitude is expressed for the patience and courtesy which they have shown in the preparation of this book.

P. J. F.

120 Central Park South,
New York City.

CONTENTS

	PAGE
INTRODUCTION (HISTORY).....	1
PART I	
BEARING UPON THE CLASSIFICATION OF ANÆSTHESIA, ITS CHARACTERISTIC SIGNS AND ITS ADMINISTRATION BY THE VARIOUS METHODS ORDINARILY EMPLOYED	
TYPES OF ANÆSTHESIA	
A. GENERAL ANÆSTHESIA. B. LOCAL ANÆSTHESIA. C. MIXED ANÆSTHESIA.	
A. GENERAL ANÆSTHESIA	
CHAPTER	
I. GENERAL ANÆSTHESIA	11
1. Complete. 2. Incomplete.	
II. GENERAL ANÆSTHESIA A DETAILED CONSIDERATION	15
1. Induction. 2. Maintenance. 3. Recovery.	
III. SIGNS OF ANÆSTHESIA	82
1. Respiration. 2. Color. 3. Muscle. 4. Eye. 5. Pulse.	
IV. ETHER ANÆSTHESIA. GENERAL CONSIDERATIONS.....	120
1. Oral Insufflation. 2. Intraparyngeal. 3. Intratracheal. 4. Oil Ether Rectal. 5. Intravenous.	
V. ETHYL CHLORIDE.....	181
General Consideration. Technic of Administration.	
VI. CHLOROFORM.....	185
General Consideration. Technic of Administration.	
VII. NITROUS OXIDE.....	201
General Consideration. Technic of Administration.	
VIII. NITROUS OXIDE OXYGEN ANÆSTHESIA.....	214
General Consideration. Technic of Administration.	
IX. NITROUS OXIDE OXYGEN ETHER ANÆSTHESIA	223
General Consideration. Technic of Administration. Anoci Asso- ciation.	
B. LOCAL ANÆSTHESIA	
X. UNUSUAL METHODS.....	249
1. By Freezing. 2. By Pressure. 3. By Regional Intravenous Injec- tions of Novocaine.	
XI. USUAL METHODS.....	255
1. By Surface Application. 2. By Infiltration Anæsthesia. 3. By Conductive Anæsthesia.	
C. MIXED ANÆSTHESIA	
XII. GENERAL CONSIDERATION.....	261
XIII. METHOD OF ADMINISTRATION.....	265

PART II

BEARING UPON FACTORS INCIDENTAL TO THE ACTUAL ADMINISTRATION OF THE ANESTHETIC

CHAPTER	PAGE
XIV. PRELIMINARY MEDICATION IN ANÆSTHESIA.....	277
XV. POST-OPERATIVE TREATMENT OF THE PATIENT; DUTIES OF THE NURSE BEFORE, DURING AND AFTER ANÆSTHESIA.....	285
XVI. CARBON DIOXIDE AND REBREATHING.....	296
XVII. EMERGENCY ANÆSTHESIA.....	308
XVIII. THE ANÆSTHETIST'S RECORDS.....	318
XIX. ASPIRATORS.....	321
XX. THE POINT OF VIEW OF THE PATIENT.....	328
BIBLIOGRAPHY.....	325
INDEX.....	337

ILLUSTRATIONS

FIG.	PAGE
Tablet to Crawford W. Long.....	<i>Frontispiece</i>
1. Homer.....	3
2. Du Bartas.....	3
3. Shakespeare.....	3
4. Dr. C. W. Long.....	3
5. A Documentary Reference to the Existence of Ether Frolics.....	4
6. The First Suggestion of the Use of Ether as an Anæsthetic.....	4
7. An Account of the First Anæsthesia.....	4
8. Long's Discovery no Secret.....	5
9. Curve of Complete Anæsthesia.....	12
10. Curve of an Incomplete Anæsthesia.....	13
11. Correct Control of the Head, the Patient Across the Bed.....	24
12. Incorrect Control of the Head, the Patient Parallel with the Bed.....	24
13. The Boxwood Mouth Wedge.....	34
14. The Author's Modification of the Connell Throat Tube.....	34
15. Throat Tube in Place.....	35
16. Table in Trendelenburg Position.....	38
17. Patient Ready for Trendelenburg Position.....	38
18. Patient in Trendelenburg Position.....	39
19. Table in Position for Trendelenburg Position—Feet Straight.....	39
20. Patient in Trendelenburg Position—Feet Straight.....	41
21. The Simms Position.....	41
22. Position Favoring Brachial Paralysis.....	43
23. Position Favoring Musculospiral Paralysis.....	43
24. Position for Exploration of Knee-joint.....	44
25. Prone Position.....	44
26. Prone Position for Sacral Operation.....	45
27. Position for Operation on Sacrum.....	45
28. Table with Gall-bladder Kidney Rack in Position.....	46
29. Patient in Kidney Position Over Rack.....	46
30. Patient in Gall-Bladder Position Over Rack.....	49
31. Table Broken Instead of Raising Rack.....	49
32. Kidney Position on Broken Table.....	50
33. Gall-bladder Position on Broken Table.....	50
34. Ordinary Neck Position for Goitre Operation.....	51
35. Ordinary Neck Position for Glands of Neck.....	51
36. The Rose Position.....	52
37. The Elevated Neck Position.....	52
38. The Table Set for Elevated Neck Position.....	53

39. Patient in Elevated Neck Position.....	53
40. Table Set for Lithotomy.....	55
41. Patient in Lithotomy.....	55
42. Table Set for Closure of Upper Abdominal Wounds.....	56
43. Patient in Position for Closure of Upper Abdominal Wounds.....	56
44. The Walcher Position.....	57
45. Diagram to Explain the Walcher Position.....	58
46. Curve Showing Variable and Constant Maintenance.....	61
47. Diagram Showing Vapor Tension of Ether in Alveolar Air During the Three Stages of a Complete Anaesthesia.....	65
48. Vapor Pressure of Ether in Tidal Air for Induction and Maintenance of Full Anaesthesia.....	68
49. Plot of Ether Vapor Pressure in Pulmonary Tidal Air.....	69
50. Plot of Ether Tension in Body.....	70
51. Zones of Ether Anaesthesia.....	73
52. Recovery by Crisis.....	76
53. Recovery by Lysis.....	77
54. Gauze on Upper Lip Moistened with Essence of Orange.....	80
55, 56. Sylvester Method—Artificial Respiration.....	93, 94
57. Simple Form of Mercury Manometer.....	95
58. Lewis Pendulum Swing.....	96
59. Normal Movements of Diaphragm.....	104
60. Movement of Diaphragm Before a Fatal Issue.....	104
61. Diagram Showing Enervation of the Dilator and Sphincter Pupillæ.....	109
62, 63. Intravenous Administration of Saline.....	115, 116
64. Hypodermoclysis.....	118
65. Yankauer Gwathmey Drop and Vapor Mask.....	123
66. Making the Ether Drop Bottle.....	124
67-71. Ether by the Semi-open Drop Method.....	128-131
72. The Author's Apparatus for the Administration of Ether by the Closed Drop Method and for Gas Oxygen Ether Anaesthesia.....	134
73. Wire Gauze Roll.....	135
74, 75. Bennett Apparatus.....	139
76. Apparatus for the Vapor Method of Oral Insufflation and for Intraparyngeal Insufflation Where Concentrated Vapor of Small Volume is Employed....	147
77. Vapor Mask.....	148
78. Anæsthetometer.....	150
79. Foot Bellows.....	151
80. Steam Pump for Air Supply at Roosevelt Hospital.....	152
81. Large Reservoir Tank and Wash Tank into Which Air from Steam Pump is Delivered before being Piped to the Operating Rooms.....	152
82. Electrical Unit (Connell).....	153
83. Nasal Tubes.....	154
84. Nasal Tube in Place.....	154

ILLUSTRATIONS

xv

85, 86. Intraparyngeal Anaesthesia.....	155
87. Portable Anaesthetometer.....	161
88. Intratracheal Catheter.....	162
89. Jackson Laryngoscope and Rheostat.....	163
90, 91. Intratracheal Anaesthesia.....	165-166
92. Intravenous Apparatus.....	177
93. Chloroform Containers.....	182
94. Ethyl Chloride Container, Spray Type.....	182
95. Various Sizes N ₂ O Tanks, 100-3200 Gallons.....	202
96. Reducing Valve.....	203
97. Label on N ₂ O Cylinder.....	204
98. Plan of Apparatus Installed in Lakeside Hospital for the Manufacture of Nitrous Oxide.....	205
99. The Author's Cylinder Holder.....	209
100. The Author's Cylinder Holder Clamped to the Edge of a Table.....	210
101. Cylinders Lying on a Chair Supported by the Author's Holder.....	211
102. Cylinder Clamp Fastened to a Window-sill.....	212
103. A Simple Wooden Stand for Three Cylinders, Suitable for Hospital Use.....	215
104-105. Face Piece and Controlling Valves.....	230
106. Face Piece, Miller Apparatus.....	231
107. Miller Apparatus.....	232
108. Zones of Nitrous Oxide Oxygen Anaesthesia in Normal Man without Supplemental Narcosis.....	234
109. Connell Nitrous Oxide, Oxygen, Ether Flow Control.....	235
110. Esmarch Bandage.....	251
111, 112. Bandage for Regional Intravenous.....	253
113. Case Containing Outfit for Intraspinal and Local Anaesthesia.....	257
114. Relative Sensitiveness of Tissues.....	259
115. The Relations of the Lumbar and Dorsal Interspaces to the Crests of the Ilii and Lower Ribs.....	266
116. Localization of the Spinal Interspaces.....	267
117. The Point of Skin Puncture is Anaesthetized by Freezing.....	269
118. The Needle is Introduced in the Middle Line Forward and Inward.....	270
119. As the Dura is Pierced, the Cerebrospinal Fluid Escapes and May be Collected in Test-tube for Further Study.....	271
120. The Syringe Containing the Proper Dose of Stovaine is Attached to the Needle and Slowly Injected.....	272
121. Nurse Grasping Patient's Wrists.....	286
122. The Fowler Position.....	292
123. The Shock Position.....	293
124. Tracing of Experiment in Respiration.....	306
125. Making the Cone.....	313
126. Funnel with Tube for Intraparyngeal Anaesthesia.....	315
127. Funnel with Tube for Intratracheal Anaesthesia.....	316

128. Front of Anaesthesia Record Card.....	318
129. Reverse of Anaesthesia Record Card.....	319
130. Foot Aspirator.....	322
131. Water Aspirator.....	323
132. Electrical Aspirator.....	324
133. Ejector for Steam Aspirator.....	324
134. The Steam Pump Aspirator Complete with Aspirating Tongue Depressor.....	325
135. Aspirating Tongue Depressor.....	326

THE ART OF ANÆSTHESIA

INTRODUCTION

THE HISTORY OF ANÆSTHESIA

THE history of anæsthesia may be broadly divided into two periods: the *pre-anæsthetic period* and the *anæsthetic period*. The *pre-anæsthetic period* ends and the *anæsthetic period* begins with the discovery of ether in 1842 and its general introduction in 1846.

THE PRE-ANÆSTHETIC PERIOD

(Before 1842)

The beginning of the use of anæsthesia is not known; it dates from the earliest antiquity. The following commonly accepted references prove that narcotics were used in *pre-anæsthetic* times.

Homer (Fig. 1), in "The Odyssey," says: "Helen dropped into the wine of which (the soldiers) drank a drug, an antidote of grief and pain inducing oblivion to all ills. He who drinks of this mingled cup sheds not a tear the livelong day were death to seize his venerated sire or her who gave him birth, or were the sword buried in the bosom of his brother or greatly loved sister, no tear would even then bedew his cheeks."

In 484 B.C., Herodotus refers to the inhalation of the vapors of hemp (*Cannabis Indica*) to produce intoxication.

In 23 A.D., Pliny, the Roman author, speaks of the juice of certain leaves taken before cuttings and burning to produce sleep.

In 134 A.D., Galen, the physician, speaks of the power of mandragora to paralyze sensation and motion.

In 250 A.D., Lucian, the Greek historian, refers to the narcotic effects of mandragora.

In 1250, Hugo de Luca, physician, refers to a certain oil with which he put patients to sleep before operations.

In 1544 Du Bartas implies a custom by writing:

Even as a Surgeon, minding off to cut
Some cureless limb, before in use he put
His violent engines on the viscious member
Bringeth his patient in a senseless slumber.

In 1613, Shakespeare (Fig. 3) in "Cymbeline," Act I, Scene VI, implies the use of a narcotic. (Cornelius plans to give a secret drug which)

Will stupify and dull the sense awhile,
No danger in what show of death it makes.

In 1772, Priestly discovers nitrous oxide.

In 1804, Sir Humphrey Davy suggests the use of nitrous oxide as an anæsthetic.

In 1818, Faraday notes resemblance between nitrous oxide and ether.

The narcotic effects secured in ancient, mediæval and modern times, during the period which we have designated as *pre-anæsthetic* (previous to 1842), were brought about chiefly by the use of:

Mandragora root (related to belladonna).

Cannabis indica, a certain kind of hemp, smoked as haschisch.

Secret Chinese mixtures.

Pressure on blood-vessels and nerve trunks.

Hypnotism.

The *anæsthetic period* was foreshadowed by the sporadic use of nitrous oxide both in England and America. At about this time it became a common practice for persons to

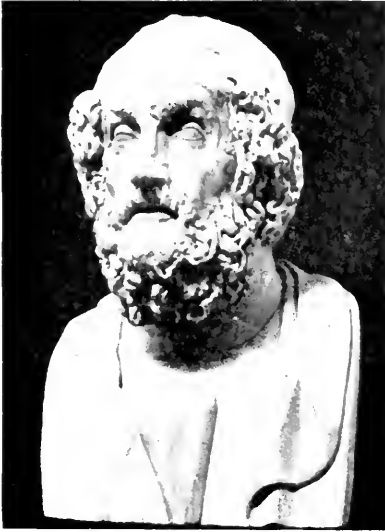

FIG. 1.—Homer.



FIG. 2.—Du Bartas.



FIG. 3.—Shakespeare.



FIG. 4.—Dr. C. W. Long, from a crayon drawing made in 1842.
(Courtesy of Florence Long Bartow.)

Homer, Du Bartas and Shakespeare, Poets of the pre-anæsthetic period who wrote of the use of narcotics for the control of pain. Dr. C. W. Long, of Georgia, who opened the anæsthetic period by employing ether, to secure unconsciousness during an operation which he performed in the spring of 1842.

inhale the fumes of ether for the exhilarating effects. This practice sometimes formed the chief entertainment at country parties. These *ether frolics* probably suggested the use of this agent as an anæsthetic, for during these frolics, the stage of excitement occasionally led to unconsciousness and loss of sensation. A portion of a document, sworn to by one R. H. Goodman of Georgia, shown in Fig. 5, "refers to these ether frolics."

THE ANÆSTHETIC PERIOD

(From 1842 to the present time)

The proper discovery of anæsthesia involves the names of four investigators: Crawford W. Long of Georgia; William T. Morton of Hartford; Horace Wells of Hartford and Charles T. Jackson of Boston.

Dr. Crawford Long (Fig. 4) of Georgia, having observed the loss of sensation incidental to injuries received during ether frolics, concluded that sulphuric ether might well be used to allay the pain of surgical operations. This idea occurred to Dr. Long late in the year 1841, as may be seen in Fig. 6. In the spring of 1842 Dr. Long put his theory into practice. After having rendered his patient, one James Venable, unconscious with inhalations of ether, he successfully removed two small tumors from the man's neck. The documents reproduced in Figs. 6 and 7 give brief accounts of the first operation ever done under ether.

H. Wells of Hartford had a tooth extracted under the influence of nitrous oxide. He subsequently used it upon his patients with such good results that he attempted a demonstration at the Harvard University Medical School. His exhibition was a failure and so disheartened him that he later committed suicide.

W. T. Morton was a student under Wells and conse-

Jefferson July 24. 1842

Dear Rob

I am under the necessity of troubling you a little, I am entirely out of Ether and wish some by tomorrow night if it is possible to receive it by that time - We have come girls in Jefferson who are anxious to see it taken
- Your friend
G. W. Long.

I Certify that on the first of January 1842 I resided in Jefferson Jackson County Georgia and that about that time myself with several other young men were in the habit of meeting at Doct. G. W. Long's Shop and other rooms in the Village and inhaling ether which he administered to us, - We took it for its exhilarating effects, - On the 20th of January of the same year I removed to Athens in the above named State when I introduced the inhalation of ether. -

I and several of my young associates frequently assembled our selves together and took it for the excitement it produced, after that I know it became very common to inhale ether in Athens and that it was taken by a great many persons in the place, and was frequently taken in the College Campus and on the Streets

August 4th. 1849

R. W. Goodman
of the firm of Matthews Goodman & Co
of Athens Georgia

This letter written to me by Dr. C. W. Long in which he ordered the ether that he performed the first surgical operation on a patient under the influence of that drug - a man was removed from the neck of a young man - Mr. James Venable without giving him any pain - it was a complete success - This statement is true as I learned it from Dr. C. W. Long R. H. Goodman

Mr. Robert Goodman

Athens Geo

In November 1841
 Dr. C. W. Long told me that he believed an operation could be performed without the patient feeling pain by giving him ether to inhale in April 1842 he told me his experiment on James Venable was successful I also saw James Venable the same morning who told me that he felt no pain during the operation

Witnessed

R. H. Goodman

Wm. H. Cobb,
 (Wm. Russell Cobb)
 Gallie Pipe Stanley.
 Oct. 10. 1905

Courtesy Dr. Allen I. Smith, Old Penn.

FIG. 6.—The first suggestion of the use of ether as an anæsthetic.

Atlanta D. Hall Co Ga.

April 3rd 1853

C. W. Long M. D.

It affords me pleasure to certify & I do hereby affirm that I saw you perform an operation upon Mr. James M. Venable to wit the cutting out & removing of a tumor from the neck of the said James M. Venable.

The operation was performed when Mr. Venable was under the influence of Sulphuric Ether produced by inhaling the same. I was intimate with Mr. Venable at the time of the operation; & afterwards frequently conversed with him upon the subject & he often told me that the operation produced no pain. The operation was performed in the Town of Jefferson Jackson County & State of Georgia in the year One Thousand Eight Hundred & Forty Two. Yours &c,
W. S. Thurmond

705 b

Athens Georgia Aug 10th 1848

This certifies, that in the month of May 1843,
I was present & operated Dr R.D. Moore of this place
in amputating a leg. He said to his three
students (I being one) If I had of thought
of it, before we left home, I would have tried
Dr. Long's discovery. Producing insensibility
by inhalation of Aether.

Attest
New Market
Andrew of
James Carnack M.D.
Charles Cunningham

quently was familiar with the use of nitrous oxide. While serving as a medical student under the preceptorship of C. T. Jackson, the latter suggested that he use ether in place of nitrous oxide. Morton did so and after several experimental successes gave a demonstration at the Massachusetts General Hospital, October 16, 1846.

As the operator, Dr. Warren, remarked at the conclusion of the operation, "Gentlemen, this is no humbug," so subsequent events proved this public demonstration to be the birth of a new era. The crudeness of pre-anæsthetic methods is vividly depicted by Hayden, who describes an operation performed on a woman: "With a meek, imploring look and the air of a startled fawn, as her modest gaze meets the bold eyes fixed upon her, she is brought into the amphitheatre crowded with men, anxious to see the shedding of her blood, and laid upon the table. With a knowledge and merciful regard as to the intensity of the agony which she is to suffer, opiates and stimulants have been freely given her which, perhaps at this last stage, are again repeated. She is cheered by kind words and the information that it will soon be over and she freed forever from what now afflicts her; she is enjoined to be calm and to keep quiet and still; and with assistance at hand to hold her struggling form, the operation is commenced.

"But of what avail are all her attempts at fortitude! At the first clear, crisp cut of the scalpel, agonizing screams burst from her, and with convulsive efforts she endeavors to leap from the table: but force is nigh. Strong men throw themselves upon her and pinion her limbs. Shrieks upon shrieks make their horrible way into the stillness of the room, until the heart of the boldest sinks into his bosom like a lump of lead.

"At length it is finished and, prostrate with pain, weak

from her exertions and bruised by the violence used, she is borne from the amphitheatre to her bed in the wards, to recover from the shock by slow degrees.”

A short time after this demonstration at the Massachusetts General Hospital, Morton and Jackson patented ether and called it letheon. The secret soon leaked out, however, because of the characteristic odor of the new preparation. Petition was later made before Congress for recognition. The honorarium consisted of one hundred thousand dollars. Morton, Jackson and a friend of Wells, who had since died, became claimants. As the controversy was about to close, Jackson recognized the claims of Long, which had just been received. The bill was thereupon dropped and never again presented.

In recalling the facts pertaining to the discovery of ether we should remember that Dr. Crawford Long of Georgia was the first to use ether as an anæsthetic. He made no secret of his discovery, as is seen in Fig. 8, but his comparative isolation and the fact that he had no large institutional backing prevented his discovery from becoming widely known. Four years later the use of ether as an anæsthetic became universal through the sanction which its employment received at the Massachusetts General Hospital, where it had been introduced by Morton and Jackson. In the following year, 1847, chloroform was introduced into England by Sir J. Y. Simpson. The employment of nitrous oxide as an anæsthesia by H. Wells, in 1844, foreshadowed the use of nitrous oxide and oxygen by E. Andrews, of Chicago, in 1868. In 1844 Koller, of Vienna, introduced cocaine. Ethyl chloride, although recognized as an anæsthetic in 1847, did not become widely used until about 1900. About five years later H. Braun suggested employment of novocaine as local anæsthetic.

PART I

**BEARING UPON THE CLASSIFICATION OF
ANÆSTHESIA, ITS CHARACTERISTIC SIGNS
AND ITS ADMINISTRATION BY THE VARIOUS
METHODS AND AGENTS ORDINARILY EMPLOYED**



CLASSIFICATION OF ANÆSTHESIA

TYPES

GENERAL, LOCAL, MIXED, OR SPINAL

DEGREES OF GENERAL ANÆSTHESIA

COMPLETE INCOMPLETE

COMPLETE GENERAL ANÆSTHESIA

(1) INDUCTION		(2) MAINTENANCE		(3) RECOVERY	
	Evidences	Cerebral.			
		Muscular.			
		Physiological effects of the ether. Lack of any preparation or faulty preparation Alcoholism. Temperament. Ether <i>per se</i> over concentration of the anæsthetic. Excessive smoking. Sexual. Previous unsatisfactory anæsthesias. Nasal obstruction. Almost the rule in children. Failure to understand what anæsthesia means. Excessive fear. Remarks which the patient hears before losing consciousness.			
(a) Excitement	Causes	Preliminary visit		(a) Suggestive therapeutics.	(b) Examination—History
		Indirect		Heart	Lungs
		Direct		Teeth	Urine.
	Control	Preliminary medication {Diet. Morphine.			
		Place of starting anæsthesia			
		Dilute ether. (Cooing or driving reflexes.) Attendance of restraining. N ₂ O for induction. Control of head Quietness in room.			
(1) INDUCTION Loss of consciousness to general relaxation.	Evidences	Voluntary and involuntary muscles. Jaw, head, abdomen, legs.			
		1 Excitement.	Indirect	Pressure.	1. Cerebral
		2 Obstructed respiration			2 Pharyngeal
(b) Rigidity	Causes	3 Too early operation	Direct	3. Laryngeal	4 Pulmonary
		4 Dilatation of sphincters			
		5 Gall-bladder and pelvic manipulations			
	Control	The specific treatment of 1, 2, 3, 4, 5, 6, 7, 8 and 9, as above. Special consideration to position of patient (10)			
		Pseudo-relaxation. Signs of true relaxation			
		1. Muscular relaxation. 2 Absent lid reflex.			
(c) Relaxation	Causes	Not mere absence of rigidity, but loss of normal tone. Theory of r ile			
		Control			
		Refer back to control of rigidity.			
(2) MAINTENANCE From complete relaxation to the beginning of the personal reduction of the anæsthetic.	(a) Variable	Less ether. Common method. Special apparatus not necessary End result depends upon the skill of the anæsthetist.			
		Control of each			
		Affected by induction. Character of respiration. Amount of ether necessary. Anæsthetist as pilot. The neglected patient—lies—vomits. Control of vomiting. Surgeon's point of view. Symptoms of patients index as to amount of anæsthetic.			
(b) Constant	More ether. Ideal for surgeon and anæsthetist. Requires special apparatus.				
	(a) Evidences	1. Return of reflexes		Respiration. Pharyngeal (Swallowing. Retching. Vomiting)	
		2. Return of consciousness		Rigidity Eye (Lid. Pupil. Globe.	
By Crisis Causes		N ₂ O Free respiration Alcoholism Short maintenance. Close method + (1) + (2). Surgeon.			
(5) RECOVERY	(b) Types	By Lysis Causes		Ether. Long maintenance Morphine. Apnoea Obstructed respiration. Close method with cyanin Begin soon as possible Vomiting finished in operating room. Free airway.	
		To return of reflexes			
		To return of consciousness		In home or in hospital. Time of return of consciousness. Recovery with cyanosis, stimulation. Recovery with pallor, depression. Control of olfactory vomiting.	

PART I

ANÆSTHESIA—ITS THREE TYPES

ALL anæsthesia is included in one of three types: A, *general anæsthesia*; B, *local anæsthesia*; C, *mixed anæsthesia*.

GENERAL ANÆSTHESIA is that type of anæsthesia in which the *central nervous system*, consisting of the brain and spinal cord, and the *peripheral nervous system*, consisting of afferent nerves, efferent nerves and tactile end organs, are brought under the influence of the anæsthetic.

LOCAL ANÆSTHESIA is that type of anæsthesia in which only the *peripheral nervous system* is brought under the influence of the anæsthetic.

MIXED ANÆSTHESIA is that type of anæsthesia in which the *spinal cord* and the *peripheral nerves* are brought under the influence of the anæsthetic.

GENERAL ANÆSTHESIA

In order to produce *general anæsthesia*, it is necessary that the anæsthetizing substance enter into the general circulation. Through this medium only can the higher centres be brought under control.

General anæsthesia may be brought about *indirectly* as follows:

(1) by *insufflation*, oral, pharyngeal and intratracheal;
(2) by administering the drug *per rectum*. *Directly* as follows: by *intravenous anæsthesia*.

LOCAL ANÆSTHESIA

Local anæsthesia is the anæsthetization of the end organs or nerve trunks, and may be produced by the fol-

lowing means: (1) by freezing the part; (2) by pressure on the nerve trunks or by pressure producing ischemia of the part; (3) by regional intravenous injections of novocaine; (4) by the injection of novocaine or some other drug into the skin or deeper tissues.

MIXED ANÆSTHESIA

Mixed anaesthesia is the anaesthetization of the spinal cord and nerve trunks. This may be brought about by injections of novocaine, tropacocaine or some other drug into the spinal canal.

CHAPTER I

A. GENERAL ANÆSTHESIA THE FIRST AND MOST IMPORTANT TYPE OF ANÆSTHESIA

THERE are two classes or degrees of *general anæsthesia*: *complete* and *incomplete*.

COMPLETE ANÆSTHESIA

Let us first identify *complete anæsthesia*. With the clear understanding of this class, there will be no difficulty in understanding *incomplete anæsthesia*.

Complete anæsthesia is divided into three distinct stages:

- (a) *The stage of induction.*
- (b) *The stage of maintenance.*
- (c) *The stage of recovery.*

The *stage of induction* is further divided into three periods.

- (a) The period of excitement, cerebral and muscular.
- (b) The period of rigidity.
- (c) The period of relaxation.

The *stage of maintenance* is not subdivided.

The *stage of recovery* is further divided into two periods:

- (a) The return of the reflexes.
- (b) The return of consciousness.

The *stage of induction* extends from the beginning of the administration of the anæsthetic to the point where general muscular relaxation has been brought about. This stage, leading the patient as it does from consciousness to deep anæsthesia, is the most difficult and important of the

three stages. The undervaluation of this importance is responsible for the failures which one sees in otherwise un-complicated anæsthesias. To completely induce anæsthesia takes from six to eight minutes. The correct control of this stage seriously affects the stage of *maintenance*, which is to follow.

The *stage of maintenance* extends from the completion of relaxation to the point where the anæsthetic level, which has been carried, is permitted to drop, with a view of allowing the patient to recover.

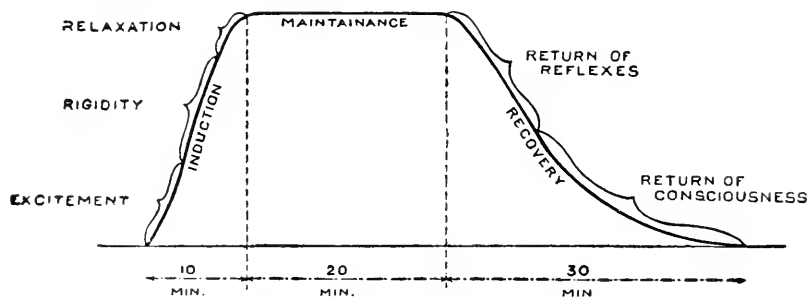

FIG. 9.—Curve of a complete anæsthesia.

The *stage of maintenance* should begin just before the time of the first incision and should cease shortly before the conclusion of the operative procedure. In maintaining anæsthesia, our problem is to supply to the patient the ether which he loses through his respiration, exposed capillary surfaces, through the destruction of the ether radical, etc., after anæsthesia has been properly brought about. While strictly speaking there are no periods of maintenance, yet there are levels of lightness and depth where certain reflexes may be retained or abolished.

The *stage of recovery* is the inverse of the *stage of induction*.

The *stage of recovery* begins when the constant level, which has been carried during the *stage of maintenance*, is permitted to permanently drop with a view of stopping the administration altogether. The *stage of recovery* ends with the return of consciousness.

Our problem in this stage is when to permit its appearance and how best to hasten its onset and completion.

Induction anæsthetizes the patient.

Maintenance keeps him anæsthetized.

Recovery returns him to consciousness.

These stages forming a *complete anæsthesia* may be represented as shown graphically in Fig. 9.

INCOMPLETE ANÆSTHESIA

The term *incomplete* or *partial anæsthesia* may be applied to a large number of anæsthesias induced for opera-

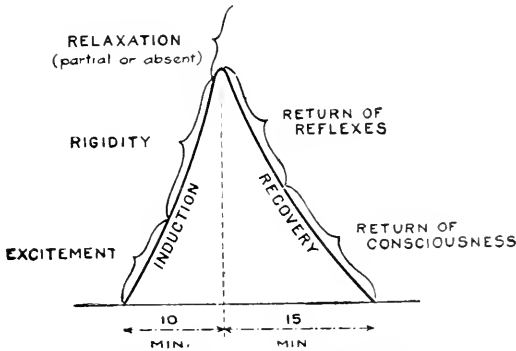

FIG. 10.—Curve of an incomplete anaesthesia.

tions, which do not require complete relaxation, and which may be accomplished in a short period of time. The opening and curetting of an abscess, or the dressing of a wound may be done with perfect satisfaction to surgeon, patient and anaesthetist in the presence of an *incomplete anaesthesia*.

In an *incomplete anaesthesia* there is no *stage of maintenance*. This stage, it will be remembered, does not appear until general relaxation obtains. Strictly speaking, one cannot expect the patient to pass from consciousness to the period of excitement or rigidity and then continue along an even plane at the convenience of the anaesthetist. The patient will either become light and vomit, or will pass more deeply under the influence of the anaesthetic and become relaxed.

The curve of an *incomplete anaesthesia* may be represented as shown in Fig. 10.

Before starting the anaesthesia, the anaesthetist should decide the question—Does this patient require complete or incomplete anaesthesia?

CHAPTER II

THE DETAILED CONSIDERATION OF A COMPLETE GENERAL ANÆSTHESIA

COMPLETE general anæsthesia is conveniently divided into three stages: *induction*, *maintenance* and *recovery*.

The stage of *induction* is further subdivided into three periods: *excitement*, *rigidity* and *relaxation*.

I. INDUCTION

THE PERIOD OF EXCITEMENT

We shall now take up in detail the first period, that of *excitement*, touching upon its evidences, causes and control.

A. THE EVIDENCES OF THE PERIOD OF EXCITEMENT.—Excitement shows itself in an anxious expression, unusually rapid pulse, irregular sighing respirations, licking of the lips, a constant clearing of the throat or fidgety movements of the hands and feet.

A woman sometimes complains of the odor of the anæsthetic in the room or that the face piece is uncomfortable. She holds her breath after the first whiff of the anæsthetic. This is often followed by shallow breathing and movements of the head from side to side. Later, she may talk, laugh or scream. Following a period of fairly satisfactory breathing, she may suddenly begin to struggle violently, tearing off the mask, flexing her thighs on her abdomen and rolling off the table if not restrained. In a man the muscular movements frequently begin slowly but with great strength, requiring the combined assistance of those

present to restrain him. Jactitation or convulsive movements of the arms or legs, grinding of the teeth and expectoration into the face piece are not uncommon. In children, bladder movements are of frequent occurrence.

B. THE CAUSES OF THE PERIOD OF EXCITEMENT.—Over-concentration of the anæsthetic; lack of any preparation or faulty preparation; temperament; alcoholism; excessive smoking; sexual; remarks which the patient hears before losing consciousness; physiological effects of the ether; failure to understand what anæsthesia means; nasal obstruction; moving patients while in the early stages of induction; excessive fear, especially in children, and previous unsatisfactory anæsthesia, are all causes of excitement.

We must differentiate excitement *per se* and the sudden determination on the part of the patient to have the operation postponed.

If the patient is rational and has not received any of the anæsthetic, she must never be forcibly anæsthetized. Such a procedure may give grounds for a suit. In this connection it must be said that the patient should never be anæsthetized without the presence of one or more witnesses.

C. THE CONTROL OF THE PERIOD OF EXCITEMENT.—Excitement is controlled by applying *indirect* and *direct means*.

The Indirect Control of the Period of Excitement.—(a) The routine preliminary visit; (b) preliminary diet and medication.

The Routine Preliminary Visit.—The preliminary visit should be made for two reasons: first, for the purpose of physical examination; second, for the purpose of applying suggestive therapeutics.

In making the physical examination there are at least five points which should be covered.

1. Anæsthetic history: Was the patient ever anæsthetized before? Was the course of anæsthesia smooth or stormy, and was there much after-sickness?

2. Has a urine examination been made? If so, is there sugar, acetone or albumen present?

3. Listen to the chest; rule out or determine the presence of tuberculosis, bronchitis or asthma.

4. Examine heart. Note whether there be heaving apex impulse, tachycardia, irregularity in rhythm or murmurs. Note color of lips and circulation beneath the finger-nails. The patient should be asked to hold the breath as long as possible in the manner prescribed as follows: He is requested to breathe deeply two or three times through the nose; at the end of an inspiration the nose is pinched by the anæsthetist and the patient is asked to hold the breath as long as possible. If it is impossible for him to do so for 40 seconds, acidosis or poor cardiac compensation may be suspected.

The anæsthetist is not usually considered proficient in physical diagnosis. He has exceptional opportunities to become so, and should never miss the opportunity to do thorough work.

5. Look into the mouth: first, that you may observe false teeth, loose teeth or chewing gum; second, that you may become familiar with the manner with which the teeth approximate, noting the best position for the insertion of an emergency mouth prop or gag.

Suggestive therapeutics are invaluable.

The patient is concerned for her safety. She wishes you to assure her that her heart is "*perfect*;" that she will safely pass through the anæsthesia. Your questions and physical examinations will in themselves comfort her, and

you may advance your negative findings as proofs of her ability to take the anæsthetic. Win her confidence and you will have done much to control the period of excitement and to lessen shock.

Preliminary Diet and Medication.—Morning operations are more satisfactory than those done later in day.

Suppose an operation for appendectomy to take place Monday morning at 9.00 A.M. At the preliminary visit, which may be Saturday evening, an ounce of castor oil is ordered to be taken at bedtime. Sunday, the usual diet is permitted, and in addition half a pound of some good candy is suggested. By supplying an excess of glucose, candy helps to neutralize the acidosis caused by the anæsthetic. This treatment is harmless to those with normal digestion, and is usually most grateful to the patient. If she is a poor sleeper, restless and apprehensive, she should receive 7 gr. veronal in hot milk before retiring Sunday night. She should be encouraged to sleep as late as possible Monday morning. Should she wake at 7.00, she may receive a cup of light broth but no solid food. At 8.30, a hypodermic of $1/6$ gr. morphine sulphate and $1/150$ gr. atropine should be given.

We are now confronted by the question—where shall we induce the anæsthesia? It may be done in one of four places: (1) in the patient's bed; (2) in the anæsthetizing room on a stretcher; (3) on the operating table in the anæsthetizing room; (4) on the operating table in the operating room. Two considerations should influence our decision: (a) The patient should not be moved after the anæsthetic is begun; (b) the patient should be spared that which will cause anxiety: *i.e.*, the sight of instruments. In the *home* the anæsthetic should invariably be induced

upon the bed or table where the operation is to take place.

In the *hospital*, the anæsthetic should be induced *on the operating table in the anæsthetizing room*.

If this be impossible, choose the lesser evil of frightening the patient and induce the anæsthesia in the operating room upon the operating table. Most patients are not frightened, however, if the circumstances are explained before hand.

Patients, who are not moved after the anæsthetic has commenced, usually have a smoother induction. They may be scrubbed up upon the first signs of relaxation and it is not necessary to lift their dead weight.

The *indirect control of the period of excitement* may therefore be summarized as follows:

Preliminary visit	{	For suggestive therapeutics. Examination: History, heart, lungs, urine and teeth.
Diet and medication	{	General diet with candy. Sleep, with veronal if necessary. Preliminary morphine where not con- traindicated.
Place of anæsthesia	{	On operating table in anæsthetizing room. On operating table in operating room.

The Direct Control of the Period of Excitement.—The direct control of the period of excitement may be described as that control which we exert *after* the patient has reached the place of operation.

If the indirect control has been conscientiously carried out, *i.e.*, if the patient has received a preliminary visit, the confidence won, a good night's rest secured and preliminary morphine received, the period of excitement will be conspicuous by its absence.

This ideal, however, is not always obtained in private work and seldom in the hospital, where the anæsthetist often meets the patient for the first time in the anæsthetizing room, lying on a stretcher swaddled in blankets and strapped to a frame. The alcoholic, the inveterate smoker, crying children, hysterical women, and those who fail to understand what anæsthesia means are placed before him without any effort having been made to investigate their various needs. The treatment of these *intrinsic* causes of excitement resolves itself into a sympathetic attitude on the part of the anæsthetist. He may express this by his manner of approach, his touch, and his tone of voice. It is never too late to inquire into urine analysis, false teeth, chewing gum, previous anæsthetization, etc. The patient should be instructed to hold his breath. If he cannot do so for a period of, at least, 30 seconds, acidosis or poor cardiac compensation may be suspected. The *extrinsic* causes of excitement may, however, be more directly controlled.

The normal reflexes of the pharynx and larynx are to be abolished. These membranes must be rendered insensitive to *any* concentration of ether vapor. In the presence of these reflexes, the patient will not be anæsthetized. Vapor which is intolerable to these membranes in their normal state is of insufficient strength to put the patient to sleep.

We may abolish these reflexes by *coaxing* or by *driving* them to sleep.

Coaxing should always be the method of choice.

This is best accomplished by the employment of the drop method. If the open drop method is employed, invite the patient to count slowly and loudly; or if a child, to blow the smell away. If the patient holds the breath or coughs, stop until the breathing is once more regular; then start again and increase as rapidly as the tolerance will

permit. The point will soon be reached where the maximum amount (as much as can be vaporized) is being given. It is only a question of a few moments then to the completion of induction.

Driving the reflexes to sleep.

Some patients exhibit an abnormal degree of sensitiveness to ether vapor. If it is found that even diluted vapor cannot be tolerated, the following must be considered: In the normal case the necessity to breathe or the "Besoin de respire" overcomes whatever inhibition may exist by reason of the slightly irritating effect of the ether vapor. In the abnormal case in question the inhibition is not overcome by the "Besoin de respire." Our indications are therefore:

1. To increase the necessity for breathing.*
2. To abolish the reflexes by shocking them through the use of very concentrated ether vapor.

The first is accomplished by using an air-tight apparatus which limits oxygenation, and by rebreathing affords the stimulating CO₂.

The second is accomplished by having convenient means whereby the concentration of the ether vapor used may be rapidly increased.

The patient must breathe, and in doing so quickly paralyzes the membranes, thereby doing away with the cause of the inhibited respiration.

Should this treatment result in severe spasm and cyanosis, it must be temporarily abandoned and the patient given fresh air. As soon as breathing is again resumed the mask is reapplied.

There is no use in pouring ether at a patient, who is not breathing.

After the mucous membranes have lost their sensitiveness, careful administration of a vapor moderately concen-

trated will avoid spasm of the larynx, which may otherwise occur.

When N_2O is used for induction ether should be given without removing the apparatus from the face. The CO_2 of the respirations collecting in the apparatus deepen the respirations (see page 299). The deeper and freer the respirations, the easier it is to saturate the circulation with ether.

The *direct* control of the excitement demands the presence of one or more assistants. Someone besides the anæsthetist should not only be present but unsterile. When the patient is on a stretcher, linen bandages or special restraining straps are used. Upon a bed, sheets or blankets may be employed.

The following is a case in which the anæsthetist "took a chance," and started anæsthetizing the patient without assistance at hand. The surgeon and nurse were "scrubbing up" in another room. The patient lay *across* the bed unrestrained, in preparation for an obstetrical operation. The *induction* progressed with perfect smoothness until all at once the patient developed sharp excitement. She laughed, threw her hands over her head, and tore off the face piece. She drew up her knees and writhed about, winding up in an inaccessible position parallel with the bed. She was with difficulty pulled back into place and the face piece reapplied. A moment later the bed spring gave way at the head of the bed and the patient slid into a hole, from which she was finally extricated before consciousness returned. After the operation she awoke quickly, without sickness and grateful for a delightful anæsthesia.

Insist on having complete control of the patient's head.

The author recalls a case in which he failed to insist upon this arrangement. The operation was for paracentesis of the ear drum, complicated by a valvular lesion and

poor compensation. Proper extension of the head was not obtained. Respiratory obstruction resulted, and when the anæsthesia was stopped the patient suffered from grave cardiac dyspnœa (see Fig. 11, illustrating the correct and Fig. 12, the incorrect control of the head).

The sense of *hearing* persists after the loss of smell, taste, sight, and touch. This is particularly true when *nitrous oxide* is used. A short time ago a patient was anæsthetized with nitrous oxide and oxygen. When almost ready for operation, the surgeon said to the anæsthetist: "Let me know when you are ready." A few moments later the operation was performed, the anæsthesia being perfectly satisfactory. Upon recovery the patient reported that the last thing she knew was Dr.—remarking: "Let me know when you are ready."

One should be careful not to make any remark which may be remembered by the patient, or possibly arouse a subconscious fear.

The *direct control* of the period of excitement may therefore be summarized as follows:

1. By the concentration of the anæsthetic.
2. By assistance to help restrain the patient.
3. By the use of N_2O and a close apparatus for induction.
4. By the proper control of the patient's head.
5. By quiet in the anæsthetizing room.

THE SECOND PERIOD OF INDUCTION: RIGIDITY

Taking up the second period of *induction*, *rigidity*, we shall consider its *evidences*, *causes* and *control*.

A. EVIDENCES OF RIGIDITY.—Rigidity may be seen in all classes of muscles, in voluntary as well as in involuntary muscles. We may conveniently divide these classes into:

- (a) Those muscles which usually act under the direct

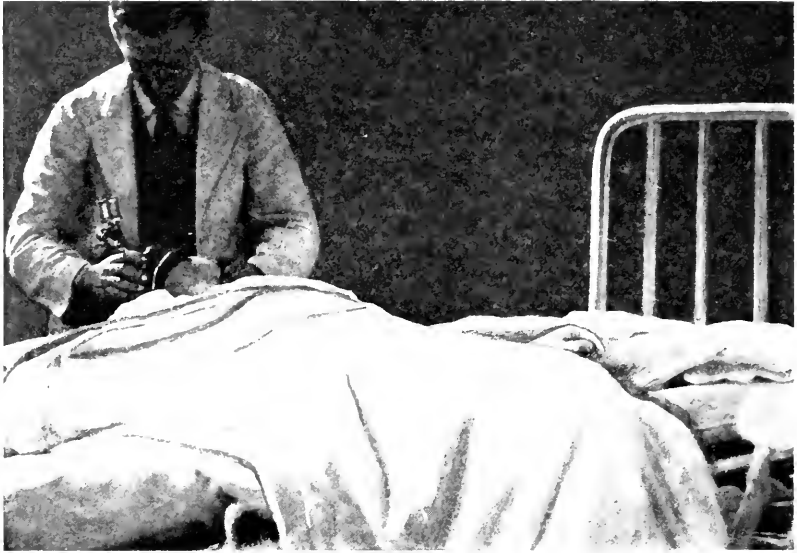

FIG. 11.—Correct control of the head, the patient across the bed.



FIG. 12.—Incorrect control of the head, the patient parallel with the bed.

control of the will, *i.e.*, the muscles of the arms, legs, masticators.

(*b*) Those muscles which usually act reflexly, *i.e.*, the sphincter muscles, respiratory muscles, uterine muscles.

Graphically we may describe the patient who is rigid as follows:

The arms and legs tend to flex, the fingers are clenched, the muscles of the neck resist the effort on the part of the anæsthetist to turn the head to the side. The teeth are tightly closed, and it will be found that the lower jaw, when grasped, cannot be made to open freely. The respiration is usually obstructed and the accessory muscles of respiration stand out hard and prominently. The eyelids are tightly shut. The breathing is thoracic, the abdominal muscles, in vigorous subjects, showing clearly beneath the skin, tense and board-like. These signs may appear together or separately.

Pseudo-rigidity, or rigidity due to faulty position, abdominal distention and unusually well-developed musculature, occasionally occurs. This should be recognized and differentiated from the rigidity which is due to incomplete anæsthesia.

CAUSES OF RIGIDITY

1. *Prolonged Excitement from any Cause*.—The nervous mechanism, whose activity gave rise to the stage of excitement, is the same power which furnishes the stimuli for muscular contractions.

Rigidity is the tonic or tetanic contraction of muscle as a result of continuous stimuli. We see these stimuli in the early stages of excitement resulting in voluntary and occasional movements. Later the stimuli increase, become more frequent and of a clonic nature, conveniently

spoken of as muscular excitement. Lastly we see the effect of an overwhelming flow of stimuli, giving rise to an apparently continuous contraction and resulting in what we term rigidity. This summation of stimuli not only causes the muscle to contract but also to become actually shorter.

When we realize this hardening and shortening of the rigid muscle, particularly in the case of the abdominal muscles, we will easily understand how rigidity may interfere with intra-abdominal manipulations.

2. *Obstructed Respiration*.—Obstructed respiration is one of the most constant causes of muscular rigidity for, by decreasing the tidal volume of the respired air, it prevents us from introducing the proper quantity of the anæsthetic into the circulation. The circulation must be saturated with ether to the extent of 1 to 400 parts or at a vapor tension of 48 mm. (see page 64), before the full effect of the anæsthetic is obtained. In addition to this, a lack of sufficient oxygen *per se* is frequently the cause of rigidity.

If the progressive increase is interfered with at the time of *induction*, the anæsthetization is not only delayed but almost immediately becomes lighter, and in the presence of this lighter stage, vomiting and muscular rigidity often supervene. *Induction* must constantly progress to the stage of *maintenance*, if the best results are to be secured.

We may conveniently consider obstruction to the respiration as occurring:

- (a) Outside the respiratory system.
 - (b) In that portion bounded externally by the nares and lips, internally by the epiglottis.
 - (c) From the epiglottis to the bronchi.
 - (d) From the bronchi to the alveoli.
- (a) Among the most common forms of obstruction to respiration occurring outside of the respiratory tract are:

Improper apparatus with a restricted airway. The respirations should not be obliged to pass through a tube whose area is less than the trachea, or about $\frac{3}{4}$ of an inch. This is particularly true during the stage of *induction*, when the respirations are increased in rapidity and volume. It will often be found that, even when the airway is free [before it is packed with gauze] after this has been placed *in situ*, this airway becomes very much restricted.

External pressure should be avoided. Dressings placed in preparation for neck operations should be loose. Too tight strapping of the patient or the weight of assistants on the neck or chest will naturally obstruct the respiration.

Intra-abdominal growths or fluid, by pressing against the diaphragm, may seriously affect the breathing.

Within the respiratory tract, but external to the airway proper, pleurisy with effusion, empyema and enlarged bronchial glands frequently form complications, which must be thoughtfully dealt with.

The position of the patient, Trendelenburg for pelvic work, prone for operations on the coccyx, all more or less embarrass the respiration. It is surprising, however, how well patients do in spite of the embarrassment, which their positions might suggest. The habitual semiprone or prone position in natural sleep may perhaps be accountable for the unexpected successes which we meet in these cases.

(b) *Obstruction occurring between the lips, nares and epiglottis.* Obstruction to the respiration, which cannot be accounted for through external embarrassment, will usually be traced to obstruction in this location, as from adenoids, polypi, deviated septum, enlarged turbinates and paralyzed soft palate, which obstruct the nasal respiration.

Oral obstruction may occur through teeth which coapt

perfectly upon themselves, or which are closed in spasm on the tip of the tongue. The lips of toothless persons, which flap valvelike to and fro without admitting air, paralysis of the tongue, which causes it to drop back into the pharynx and enlarged faucial tonsils may also cause obstruction.

(c) *Obstruction occurring from the epiglottis to the bronchi.* Obstruction here may be caused by œdema of the glottis, spasm of the vocal cords, giving rise to crowing respiration, external pressure of glands or goitre, mucous or vomited material inspired.

(d) *Obstruction occurring below the bronchi.* This is caused by anything which involves the alveoli, as for example, pulmonary tuberculosis, pneumonia, asthma, bronchitis, bronchiectasis or abscess of the lung. This type of obstruction will become evident by the fact that even with the oral and laryngeal respiration free and no cardiac insufficiency having been found, yet the patient tends to persistent cyanosis.

3. *Operations Begun Before the Skin Reflexes are Abolished.*—This procedure, by sending a flood of sensory impulses to the cord and higher centres, may give rise to a reflex which results in tetanic muscular contractions or rigidity. This rigidity may be local or general, involving the general musculature or limited to the painful locality.

4. *Dilation of the Sphincters.*—Even after anæsthesia has been well induced and satisfactory relaxation obtained, the dilation of the anal sphincter of primiparous cervix may give rise to stimuli, which are sufficient to send motor impulses along those nerves whose normal irritability has been hitherto lowered by the influence of the anæsthetic.

Upon the cessation of this profound stimulation, the patient will be found to be in a satisfactory anæsthetic

state. If the amount of the anæsthetic has been increased so as to totally abolish all effects of this stimulation, when the dilation has been accomplished, the patient will be found to be unnecessarily "deep." Therefore, as long as these reflexes do not interfere with the surgeon, they may be permitted to persist.

5. *Manipulations in the Region of the Pelvis or Gall-Bladder.*—In presence of a moderately deep anæsthesia, reflexes from these sources may, by increasing the depth or possibly obstructing the respirations, produce transient rigidity. Relaxation usually follows upon their cessation.

6. *Faulty Position of the Patient.*—Pseudo-rigidity, or apparent rigidity, may appear where an improper position of the patient obtains. This is frequently the case where the desired position has not been completely obtained. Operation upon the neck, gall-bladder, kidney, coccyx and female pelvic organs occasion most of these embarrassments.

7. *Operation in the Upper Abdomen Per Se.*—Complete relaxation in operations involving an incision through the upper abdomen is, as a rule, difficult to obtain. Thus, operations upon the stomach, pancreas, liver, spleen, etc., imply a profound anæsthesia, and special attention to the position and the respiration of the patient.

8. *Distention of the Abdomen.*—In this case a *pseudo-rigidity* is likely to be seen when the closure of the wound is being done, the operation in itself having failed to relieve the distention, *i.e.*, an operation for intestinal obstruction in obese patients.

9. *The Anæsthetic Used.*—A certain degree of rigidity is quite constantly to be expected when the anæsthetic is *nitrous oxide and oxygen*. This holds good even during a stage of satisfactory *maintenance*.

We may then summarize the causes of *rigidity* as follows: (1) Excitement; (2) obstruction to the respiration; (3) operations begun too early; (4) sphincter dilatation; (5) gall-bladder and pelvic manipulations; (6) faulty position; (7) operations on upper abdomen; (8) distention of the abdomen; (9) the type of anæsthetic used.

FURTHER EXPLANATORY NOTES ON RIGIDITY.—The evidences of rigidity having become apparent and the immediate causes enumerated, it may not be amiss to consider briefly its deeper meaning as expounded by G. W. Crile of Cleveland.

This investigator's altogether fascinating theories on shock will serve to throw some light upon the phenomena of that rigidity due to the pain of the first incision and the subsequent rigidity arising from reflex stimulation, such as dilation of the sphincters, manipulations about the gall-bladder or in the pelvis.

According to Crile, among the most highly developed reflexes are those which respond to pain stimuli. In the normal man, to inflict physical pain is to imply a muscular reaction, an expression of reflex self-defense. For example, if the finger were cut or burned, the hand would immediately be withdrawn. When the skin of the abdomen is cut or when the peritoneum is irritated, the abdominal muscles become board-like. This rigidity comes about apparently for the purpose of protecting the deeper structures.

Crile maintains that anæsthesia does not prevent the flow of afferent or pain sensations to the cord and brain.

What the anæsthetic does do to a greater or less extent is to interfere with the motor power of the muscles normally included in this reflex.

If the pain stimuli of an early incision reach the cord

before the motor portion of the reflex arc has been completely obliterated by the anæsthetic, the result will be the contraction of those muscles normally affected by this reflex, and rigidity will result. Dilation of the sphincters gives rise to pain and results not only in muscular rigidity, but acts more deeply by affecting the respiration and more rarely the pulse.

Since anæsthesia does not abolish the effects of actual pain upon the nervous system, the profound exhaustion and shock, which one would expect in the case of a prolonged operation without an anæsthetic, also obtains in all operations with anæsthesia, the difference in the two cases being that with the anæsthetic the patient is spared the conscious pain and unpleasant memories.

Whether or not, and to what degree the pain impulses to the cord and brain are affected by the anæsthetic is still a matter for discussion. We may safely conclude, however, that all irritability is not subdued, for manipulations about large nerve centres and undue roughness on the part of the surgeon will frequently cause shock even in the face of a brief and profound anæsthesia. The significance of rigidity associated with pain stimuli and its disappearance in the face of deeper anæsthetization is not, therefore, a license to unnecessarily damage or destroy tissue.

If Crile's premises are true, profound anæsthesia is like obscuring abdominal pain by the use of morphine. It covers over but does not remove or cure the underlying condition, which in this case is not disease but surgical trauma.

Local anæsthesia does prevent afferent stimuli or pain impulses to the cord or brain. If all necessary manipulations are done under cover of this nerve blocking, as is Crile's constant technic, and if all unnecessary trauma is

avoided, then a light anæsthesia becomes not only the method of choice but enables the surgeon to detect pain, which he may unwittingly occasion and desire to avoid.

Rigidity then may have a deeper significance than would appear upon a superficial consideration. When caused by pain, it is more than a mere mechanical embarrassment. It is a crying out on the part of the organism against the trauma which is being inflicted upon delicate and sensitive tissues. We deepen the anæsthesia and figuratively choke off this sign of the patient's resistance. The result, according to Crile, is the creation of an illusory protection, which in all likelihood the nervous system of the patient does not experience.

C. THE CONTROL OF THE PERIOD OF RIGIDITY.—We have seen what evidences of rigidity we may expect. We have considered the most important causes of the condition. To imply the method of the removal of these causes is not sufficient; we must patiently consider in detail the methods we will use to arrive at the desired end. The proper control of rigidity will tax the art of the anæsthetist to the utmost.

1. Since *excitement* is one of the most common causes of rigidity, it may not be amiss to recall the control which was suggested for this stage, namely:

Indirect	{	Preliminary visit.	{ For symptoms.
			{ For suggestive therapeutics.
	{	Preliminary medication.	Diet.
Sleep.			
Preliminary morphine.			
Beginning the anæsthetic on the operating table.			

Direct	}	Concentration of anæsthetic.	{	Dilute for coaxing. Concentrated for driving.
		Attendants for restraining. Control of the head. Use of N ₂ O and close apparatus. Quiet in anæsthetizing room.		

2. *The Control of Obstruction to the Respiration.*—The obstruction which is due to occlusion of the nasal airway may be ignored by providing satisfactory respiration through the mouth.

When the teeth are clenched, causing an obstruction which results in cyanosis and light anæsthesia, they must be separated or air otherwise introduced to relieve the spasm. It will be found that there is often a space between the last molar and the jaw. The finger may be introduced here and the tongue depressed. Occasionally a tooth is missing, which leaves a space for the introduction of the mouth gag or finger. One should be careful to protect the finger, otherwise a serious bite resulting in a septic wound may result.

A large catheter passed into the pharynx through one of the nostrils will, by admitting air, often relieve the spasm.

Finally, the teeth should be separated and a throat tube introduced. The best thing for this purpose is a boxwood wedge and tube, as shown in Figs. 13 and 14.

The teeth are gently separated by the sharp edge of the wooden wedge. When sufficient space has been secured, the tube may be slipped into the mouth over the top of the tongue (Fig. 15). An adequate airway will thereby be immediately secured and the spasm and rigidity will pass off. It is impossible to laud too highly this tube, which may be called the "Sine qua non" of the anæsthetist.

Obstruction between the epiglottis and the bronchi. (Edema of the glottis, secondary to burns or inspiration of liquid ether, must be dealt with vigorously. Diagnosis of this condition is made by excluding nasal obstruction, laryngeal spasm, and a history, which might lead one to suspect obstruction below the epiglottis. One of two things



FIG. 13.—The boxwood mouth wedge.

must be done—intratracheal intubation or tracheotomy.

Spasm of the vocal cords is a peculiar and annoying type of obstruction. Its causation is obscure and its relief often difficult. A hurried induction hampered by obstruction is often its precursor. Occasionally it follows an incision which has been made too early. A change of the anæsthetic state to shallowness when the patient is deep, or

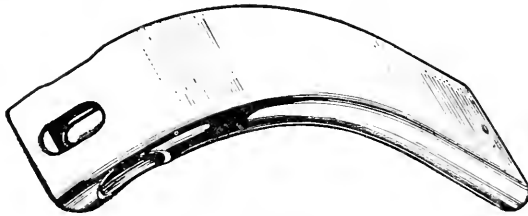

FIG. 14.—The author's modification of the Connell throat tube.

deeper when the anæsthesia is slight, is often beneficial. Strange as it may seem, if in the course of a comparatively deep anæsthesia with persistent crowing respirations, pelvic, gall-bladder or other deep reflex be stimulated, the crowing will lessen and often disappear. The attention of the nervous system has been distracted, so to speak. Rhythmical traction of the tongue may relieve this disturbance.

Mucus, saliva and vomited material may be drained by

the use of the Trendelenburg position or by the sucker, commonly found in the operating room (see page 323). Or the pharyngeal reflexes may be permitted to return and expel the foreign material. The preliminary use of morphine and atropine, by reducing the secretion and the irritability of the pharyngeal mucous membranes, often acts as a prophylactic against this type of obstruction.

Obstruction due to glands and goitres must be dealt with in such a way that the period of *excitement* will be reduced to a minimum. Anything which tends to increase blood-pressure at the induction must be avoided, as for example, the use of *nitrous oxide* without *oxygen*, or pushing the concentration before the patient is deeply enough "under" to accept it.

The control of the obstruction occurring below the bronchi. Obstruction result-

ing from pneumonia, asthma, etc., should be met by employing *oxygen* with the ether administration.

3. Rigidity, which is caused by an *incision* made before satisfactory *induction* has taken place, will usually disappear on deepening of the anæsthesia. Unless occurring during consciousness, or associated with respiratory obstruction, it need cause no alarm, if ether is the anæsthetic.

4. Rigidity during the *dilation of the sphincters*, unless interfering with the surgeon, may well be permitted; for

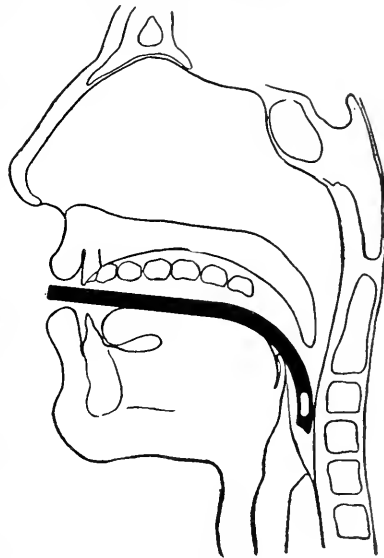

FIG. 15.—Throat tube in place.

this usually gives place to relaxation, when the excessive reflex has ceased.

5. Transient rigidity, which occurs during *pelvic and gall-bladder work*, must be temporarily abolished, if it proves inconvenient to the surgeon. When these manipulations have been completed, the patient may be permitted to "come out" somewhat. The important point to be borne in mind is that the patient is not necessarily light if he shows some disturbance in the face of these profound reflexes.

6. The *position* of the patient is such an important factor in producing rigidity that it seems wise to illustrate comprehensively the positions most used. (Figs. 16-45).

The Trendelenburg Posture (Figs. 16, 17, 18, 19, 20).—The Trendelenburg posture is one in which the patient lies on the back on a plane inclined about 45 per cent., the feet and legs elevated hanging over the edge of the table, the weight of the body supported by shoulder braces. Table set for Trendelenburg position is shown in Fig. 16.

The patient is first placed in the dorsal position upon the horizontal table. The knees are so placed in relation to the break in the foot of the table, that when the latter is dropped, the legs will be parallel to this portion. If the patient is not sufficiently near the end when the foot of the table is dropped, the knees will not be properly flexed and the feet will stick up in the air. If, on the other hand, the patient is too far down when the table is broken, she will not receive the proper support, for in this case she will rest entirely upon the shoulder braces. The patient should be pulled down toward the foot of the horizontal table until the break is about opposite the junction of the middle and lower third of the thigh. If the patient's calves are thick and muscular the distance should be greater than if they be emaciated and relaxed.

When the knees are properly placed in relation to the break in the table (Fig. 17), the arms are extended, brought close to the patient's sides and the hands with the fingers extended are placed out of sight under the buttocks.

The shoulder braces are next placed in position. They should invariably be used. Where the patient is obliged to support her weight by her knees, she is liable to develop paralysis by pressure upon the peroneal nerve.

With the knees properly placed, the hands under the patient and the shoulder braces in place, the table is elevated and the feet are dropped. The position shown in Fig. 18 then obtains.

Some operators believe that better abdominal relaxation results if the knees are not flexed, as shown in Figs. 19 and 20.

The object of the Trendelenburg position is to secure better exposure of the pelvic organs by virtue of the displacement by gravity of the abdominal viscera. It is most advantageously used in thin subjects. It is contraindicated in cases presenting free pelvic pus. This position produces engorgement of the blood vessels of the head and neck. The pharyngeal structures and the tongue are swollen and often give rise to obstructed respiration. Where there is danger of acute cardiac dilatation through a preceding acute infection or fatty degeneration, this position should not be used because of the increased strain thrown on the right heart.

In fat people the use of this position has been followed by intestinal obstruction. Volvulus of the ileum and of the large intestine have also occurred. When the Trendelenburg position has been employed, the omentum should be spread out in its normal position after the table is raised.

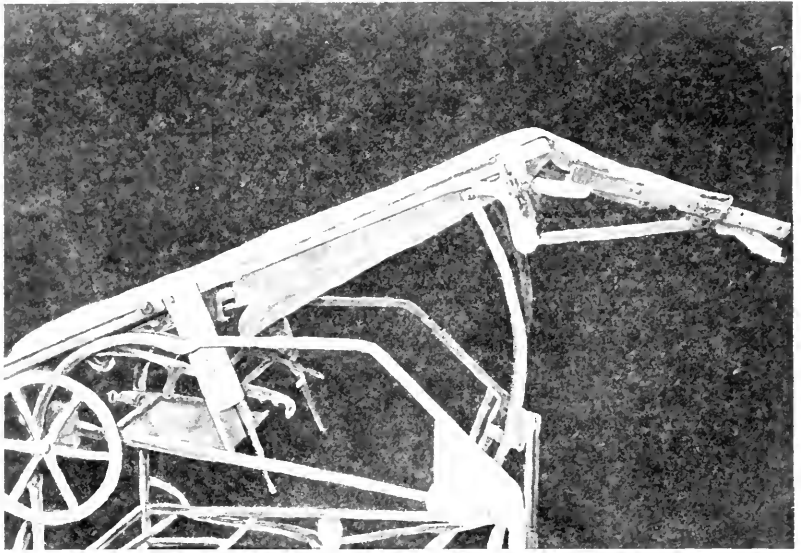

FIG. 16.—Table in Trendelenburg position.

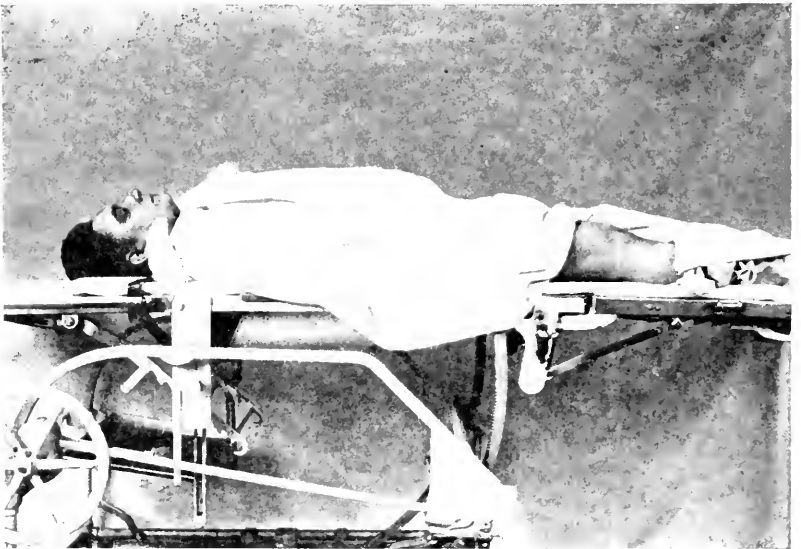

FIG. 17.—Patient ready for Trendelenburg position.

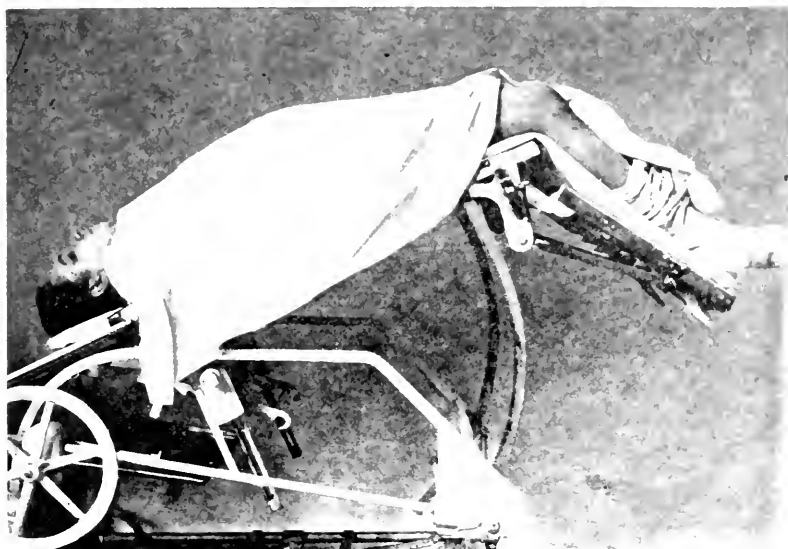

FIG. 18.—Patient in Trendelenburg position.

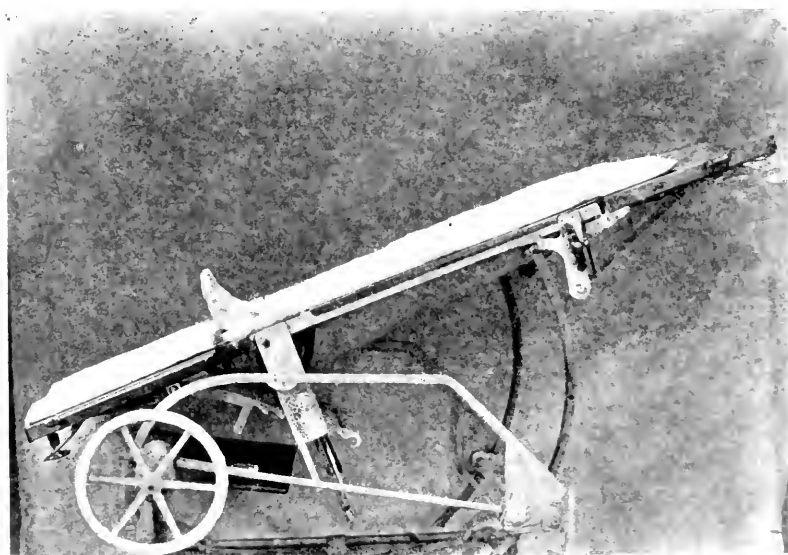

FIG. 19.—Table in position for Trendelenburg position—feet straight.

On the other hand this position presents many distinct advantages. It is the safest in which to administer chloroform. Mucous and saliva which have collected in the pharynx drain off by gravity. In very sick cases the cerebral circulation is thus best maintained. Patients, who have been carried upon a comparatively light anæsthesia in the horizontal position, frequently "come out" somewhat when the head is lowered. The converse is also true.

The patient should be returned from the Trendelenburg position to the horizontal slowly. If the horizontal is obtained too quickly, cerebral anæmia and circulatory shock may follow.

Positions Favoring Paralysis (Figs. 22 and 23).—In addition to a pressure paralysis of the peroneal nerve, which has been taken up in connection with the Trendelenburg position, we meet with two other rather common types of paralysis, secondary to an improper position on the table, namely, those of the brachial plexus and of the musculospiral nerve.

Brachial Paralysis.—If the arms are abducted and extended over the head (Fig. 22), as sometimes occurs in the Trendelenburg position where the arms have been fastened on the breast and break loose from their fastening, or in a breast operation, where it is desirable to have the arms out of the way, a brachial paralysis is prone to follow. This shows itself as an Erbs palsy, the deltoid biceps, brachialis anticus and supinator longus being involved. In such a palsy the arms hang down by the sides and the forearm cannot be flexed.

This type of paralysis is thought to occur from direct overextension of the brachial plexus; in an Erbs paralysis the fifth and the sixth cervical nerves are chiefly involved.

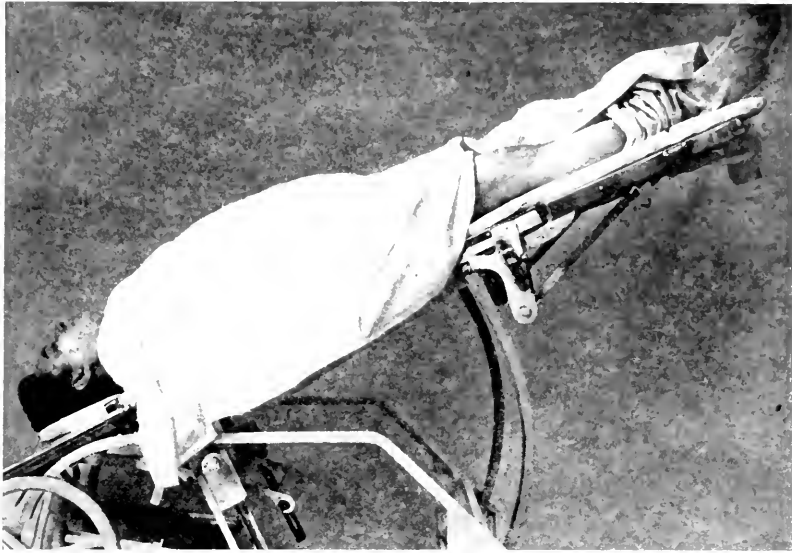

FIG. 20.—Patient in Trendelenburg position—feet straight.



FIG. 21.—The Simms position: patient on left side, left leg extended, right leg flexed, left arm behind and to the side.

If the head be turned to the side during this process of overextension, damage is more pronounced to the plexus on the opposite side, since it is put on a greater stretch.

Musculospiral Paralysis.—If the arm is permitted to hang over the edge of the table (Fig. 23), the musculospiral nerve may be compressed between the table edge and the bone and a paralysis results. This type of paralysis is quite common, but will never occur if the arms are properly cared for.

Recovery from posture paralysis is usually complete but protracted. Symptoms usually disappear first at the periphery, and later at the more central portions involved.

Position for Operation on the Sacrum, Coccyx and Rectum (Figs. 25, 26, 27).—When the field of operation is posterior to the anus, the prone position (Fig. 25), or its modification as seen in Figs. 26 and 27, is best employed. The most useful of these three positions is the so-called sacral position shown in Fig. 27

This position may be described as a sort of a reversed Trendelenburg. The control of the respiration in this position is not nearly as troublesome as might appear. If the head is turned to one side and the shoulder supported by a small sandbag, the respirations are entirely satisfactory. A lighter degree of anæsthesia may be carried in this position than in almost any other.

This position is the best for coccyxectomy, resection of the rectum, spina bifida, etc. Where work is being done on the rectum a good exposure is afforded by the falling back of the abdominal viscera. The low position of the head is also a protection against shock, and mucus, which may collect in the throat, drains off by gravity.

Posture for Kidney and Gall-bladder Operations (Figs.

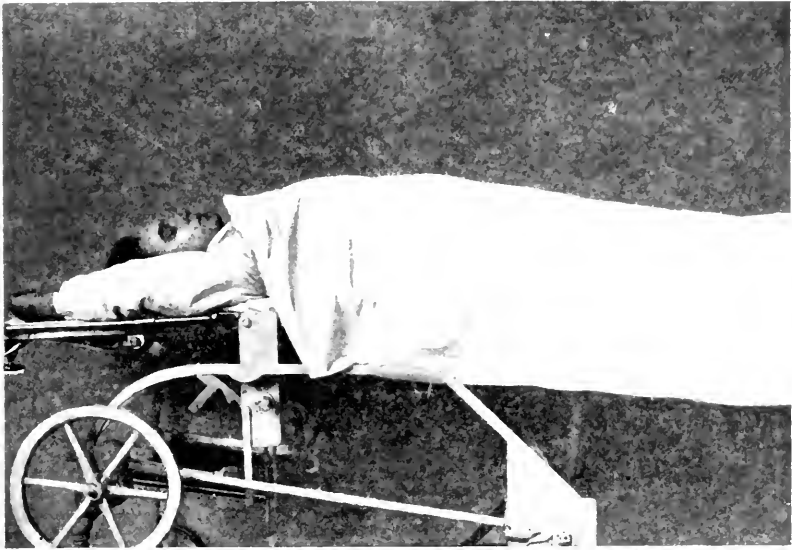

FIG. 22.—Position favoring brachial paralysis.

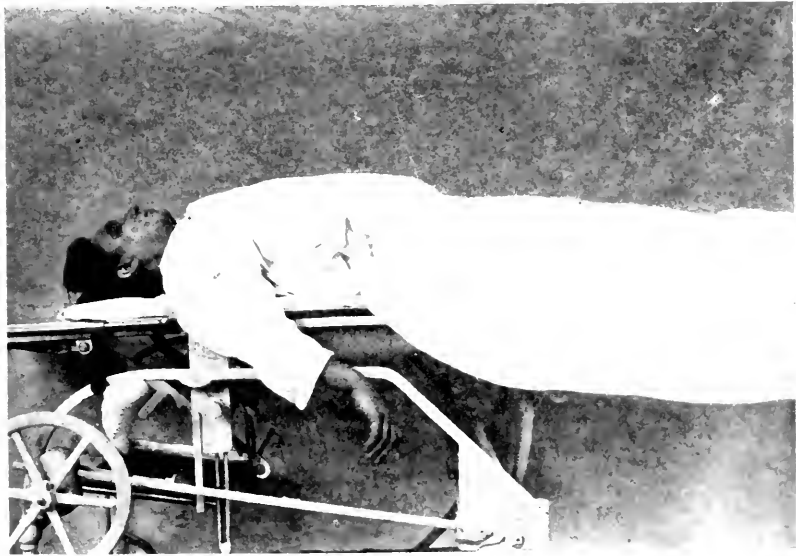

FIG. 23.—Position favoring musculospiral paralysis.



FIG. 24.—Position for exploration of knee-joint.

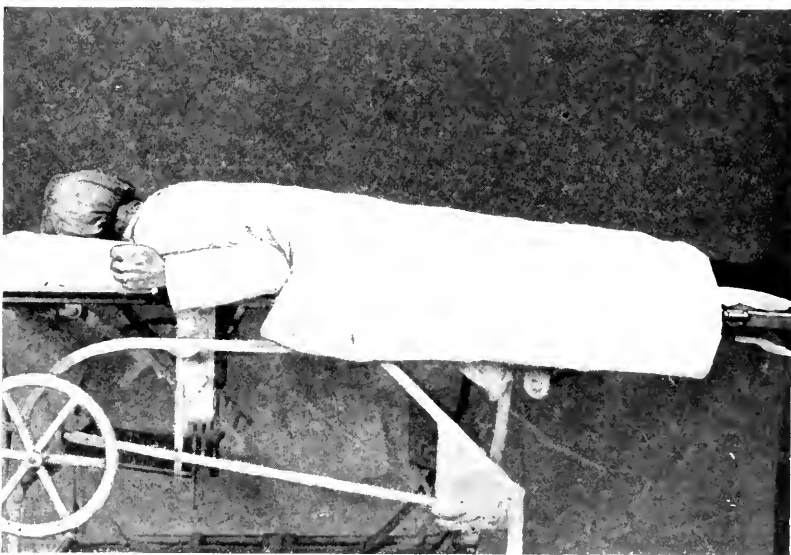

FIG. 25.—Prone position.



FIG. 26.—Prone position for sacral operation



FIG. 27.—Position for operation on sacrum.

28, 29, 30, 31, 32, 33).—While kidney operations are sometimes done with the patient in the prone position, and while operations on the gall-bladder are frequently accomplished with the patient flat on the back, better exposure is had by employing the gall-bladder kidney rack (Fig. 28), or by breaking the table, as shown in Fig. 31.

When the patient is placed upon the table she is made to lie over the rack or the break in the table, as the case may be. Breaking the table seems to be more satisfactory than employing a rack, as the patient does not so frequently complain of postoperative pressure symptoms.

If a kidney exposure is desired, the patient is placed on her side. The under arm is carried behind her and pinned to the table; the upper arm is flexed over the chest.

The position of the legs is important. The upper leg should be extended; the lower leg and thigh should be well flexed. This procedure will cause a slight tilting of the pelvis. The crest of the ileum will then be further away from the ribs on the upper than on the lower side, thereby increasing the field of exposure.

With the arms and legs properly placed, the table is then broken or the rack is raised, as the case may be (Figs. 29 and 32).

If a gall-bladder exposure is desired, the patient is placed in the dorsal position over the rack with the arms to the side or folded over the chest, as in Figs. 30 and 33.

Posture for Operation on the Neck (Figs. 34, 35, 36, 37, 38, 39).—Where an operation is to be performed upon the thyroid gland, the position shown in Fig. 34 is that usually employed. A small sandbag is placed under the shoulders and another under the nape of the neck. The head is held in the middle line. If the operation is to be for glands of

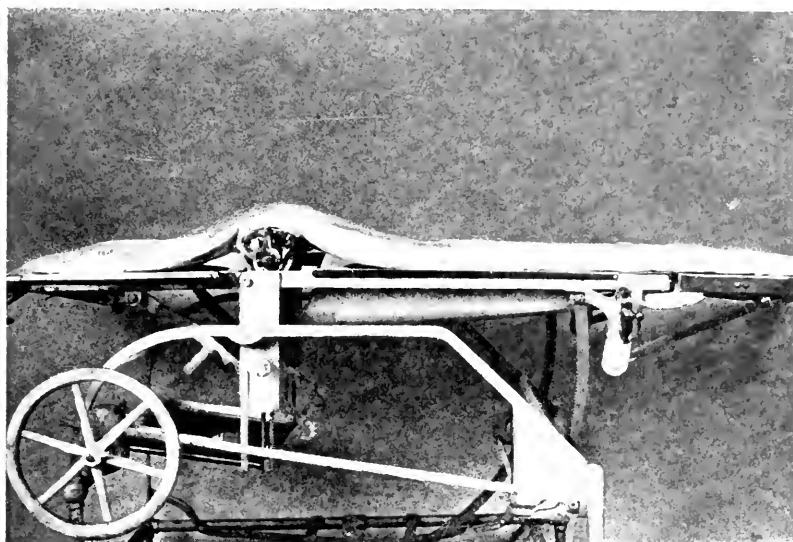

FIG. 28.—Table with gall-bladder kidney rack in position.



FIG. 29.—Patient in kidney position over rack.

the neck, the same technic is followed with the exception that the head is turned to the side instead. (Fig. 35.)

The Elevated Neck Position.—In the elevated neck position the table is arranged as for the Trendelenburg (Fig. 37). In this case the head instead of the knees extends over the foot of the table.

The patient is placed on the horizontal table in such a manner that the head is at the foot of the table. The top of the shoulders are brought opposite the break in the lower leaf. A stout linen bandage is then passed about the feet and tied to the table suspending the patient in a sling (see Fig. 38) when the table has been elevated.

The table is then thrown up and the head dropped, as in Fig. 39. The advantages of this position are as follows: There is less bleeding from the wound because of the elevation; a certain degree of cerebral anæmia obtains which renders only a light anæsthesia necessary; the field of operation is brought near to the operator, who can thus work with greater ease.

The *Rose* position, shown in Fig. 36, is sometimes employed for operation upon the tonsils and adenoids, the object of this position being to keep the blood and mucus out of the respiratory passages.

The Lithotomy Position (Figs. 40 and 41).—The lithotomy position is that ordinarily employed for obstetrical, vaginal, perineal and anal work.

Where this position is employed for anal operations on strong, muscular patients or where only a light anæsthesia is to be administered, it is well to put the shoulder braces in place. This will prevent the patient from pushing herself away from edge of table, should she become rigid.

The buttocks should be extended well over the edge of

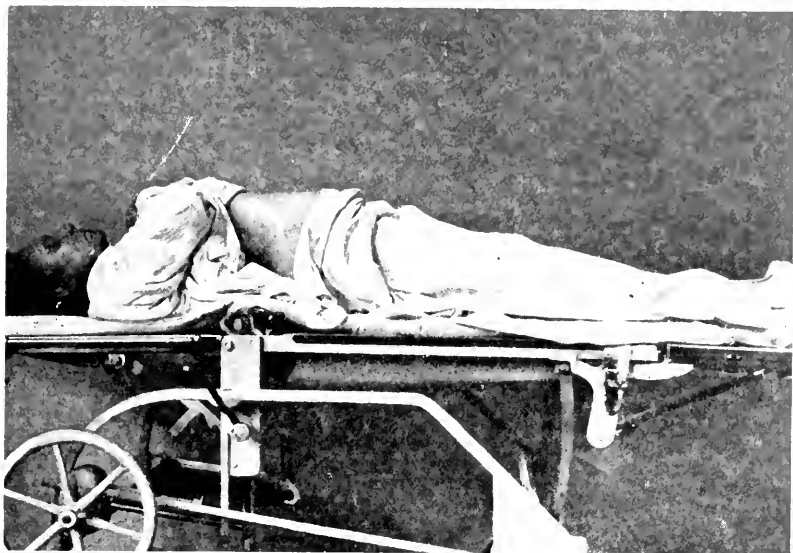

FIG. 30.—Patient in gall-bladder position over rack.

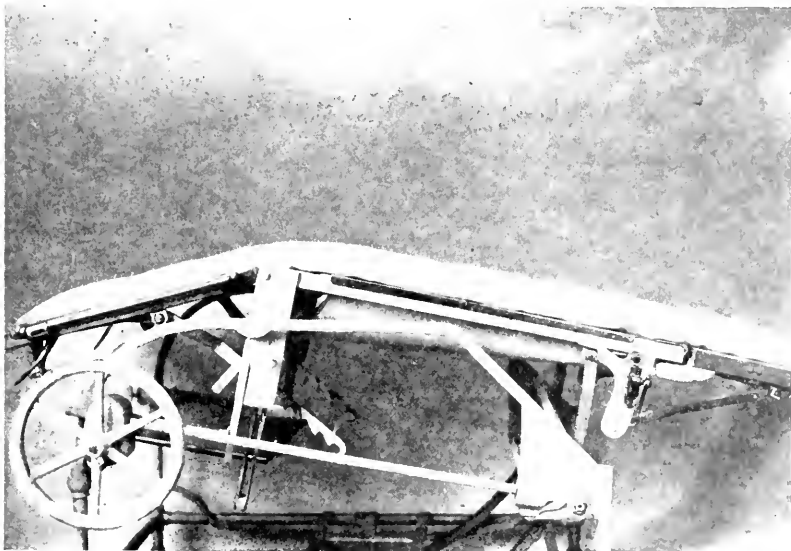

FIG. 31.—Table broken instead of raising rack.



FIG. 32.—Kidney position on broken table.

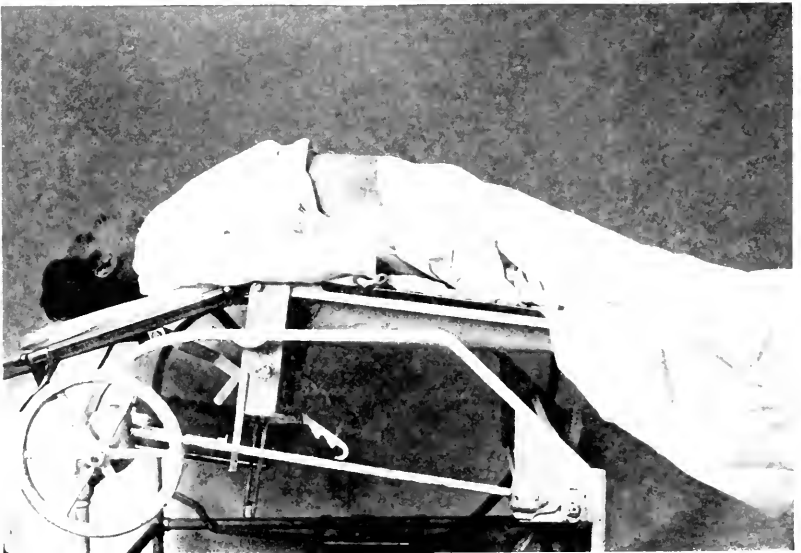

FIG. 33.—Gall-bladder position on broken table.



FIG. 34.—Ordinary neck position for goitre operation.



FIG. 35.—Ordinary neck position for glands of neck.

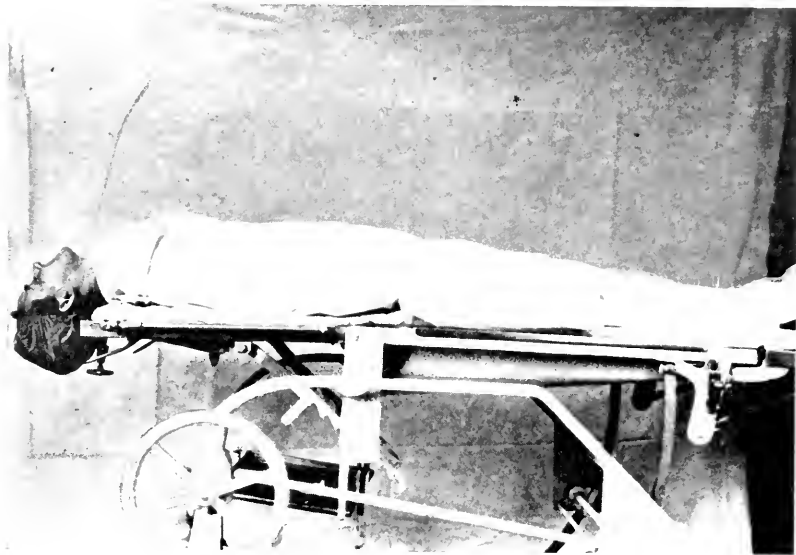

FIG. 36.—The Rose position.

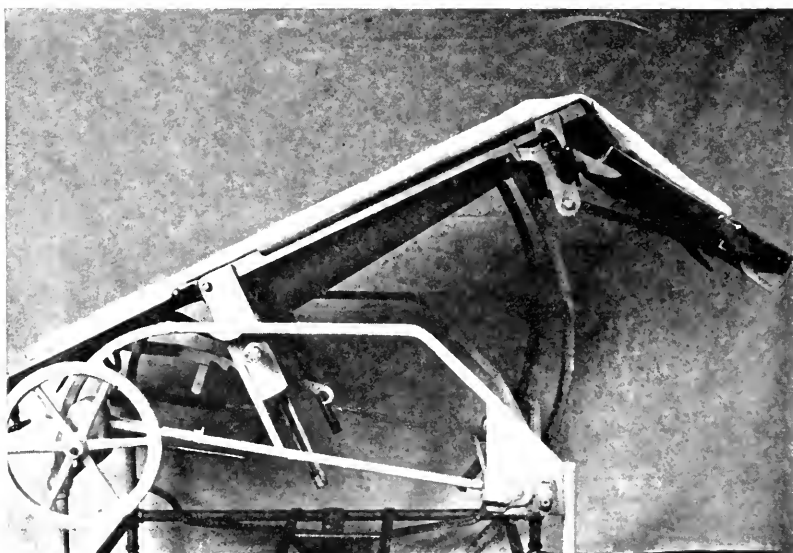

FIG. 37.—The elevated neck position.



FIG. 38.—The table set for elevated neck position.



FIG. 39.—Patient in elevated neck position.

the table so that the weighted, vaginal speculum ordinarily used may hang free.

Anæsthesia may be induced with advantage in the lithotomy position where the operation is to be a curettage or some slight anal operation. By this method one need not wait for relaxation of the large thigh and calf muscles before preparations are begun.

Posture for the Closure of Upper Abdominal Wounds (Figs. 42 and 43).—Complete relaxation for the closure of upper abdominal wounds is often difficult to obtain. If the head and the foot of the table are raised, as is shown in Figs. 42 and 43, relaxation will be materially assisted.

The Walcher Position.—The Walcher or Hanging Position is purely for obstetrical purposes. The object of this position is to increase the diameter of the pelvic inlet by tilting the symphysis pubis, as shown in Fig. 44. This tilting increases the conjugata vera about one centimetre (Fig. 45). The position is obtained by allowing the patient to rest on the edge of the table on the buttocks with her legs hanging free. (Fig. 44.)

7. Rigidity in upper abdominal operations is particularly embarrassing when the wound is closed. At this time great relief is afforded the surgeon by lifting the head of the table, thereby relieving the tension on the recti (refer to Figs. 42 and 43).

8. Rigidity caused by intra-abdominal distention, which has not been relieved by the operation, is best dealt with by using an open mask, at least during the stage of *maintenance*. In this way the maximum oxygenation is obtained and there is practically no residual CO₂ to cause deep and embarrassing respirations. These cases are usually quite sick and succumb easily to the anæsthetic.

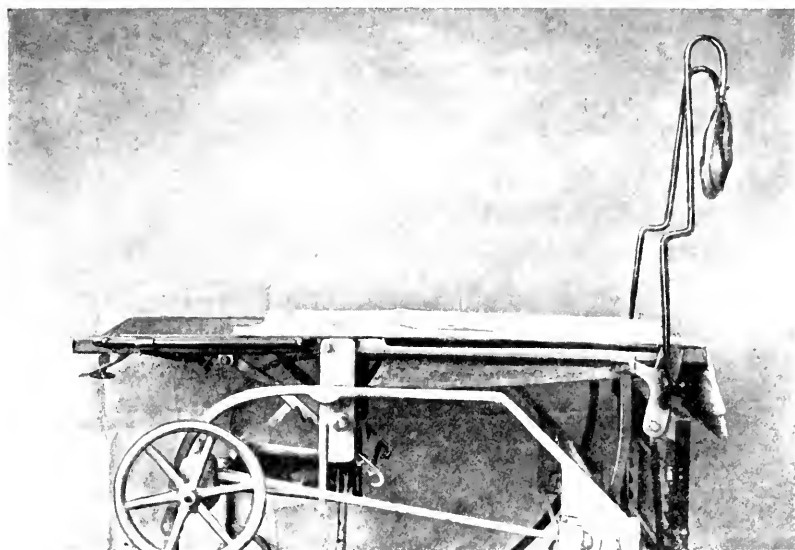

FIG. 40.—Table set for lithotomy.

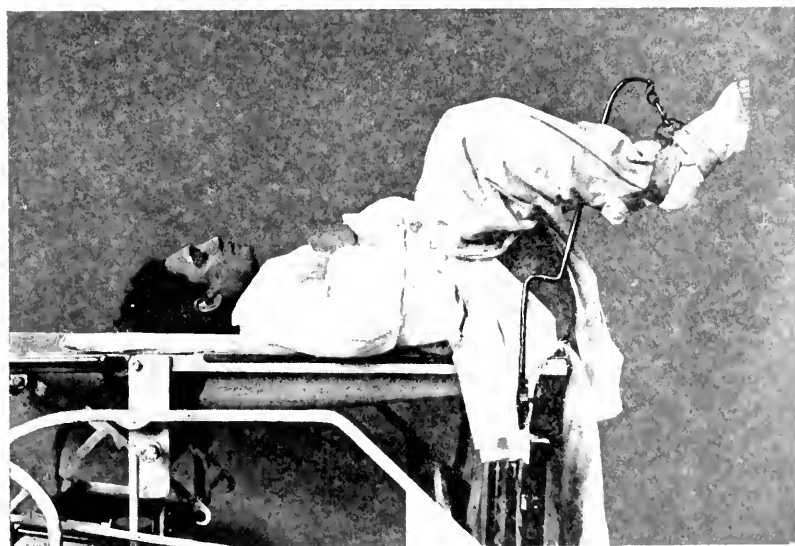

FIG. 41.—Patient in lithotomy.

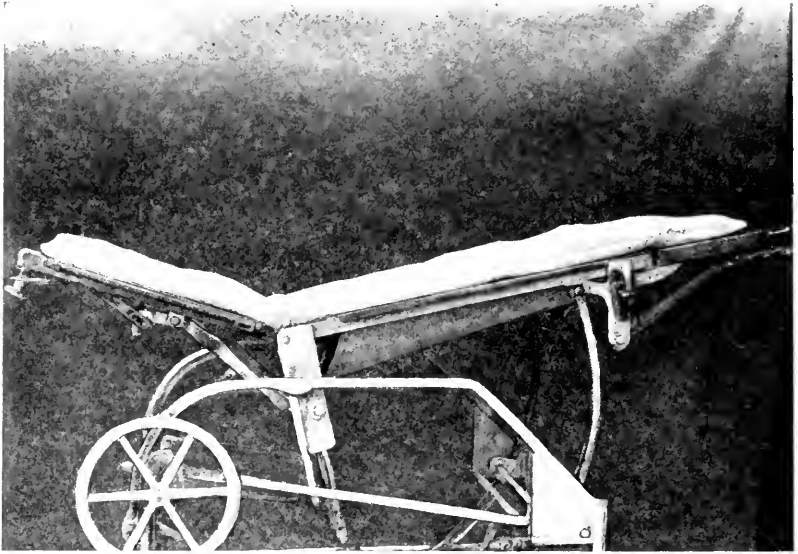

FIG. 42.—Table set for closure of upper abdominal wounds.



FIG. 43.—Patient in position for closure of upper abdominal wounds.

9. Rigidity is caused by the anæsthetic *per se*: Where all rigidity must be abolished, *nitrous oxide* and *oxygen* alone will not give a uniform and satisfactory result in abdominal operations. Preliminary medication and nerve blocking or ether must be used.

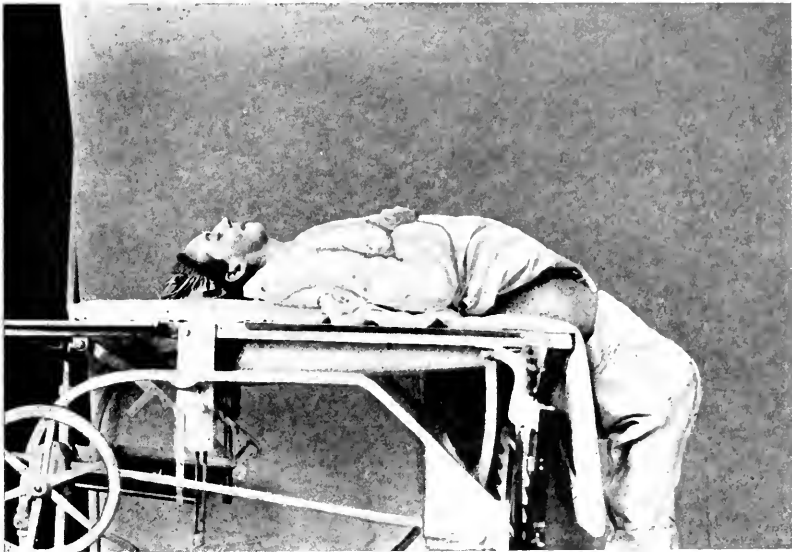

FIG. 44.—The Walcher position.

THE THIRD PERIOD OF INDUCTION: RELAXATION

Relaxation is more than mere absence of rigidity. In the normal muscle, which is not rigid, there is a definite tone which differentiates it from the muscle which is completely cut off from the control of the central nervous system.

A. THE EVIDENCES OF RELAXATION.—At the beginning of the stage of *induction* before excitement has become apparent, one frequently finds a condition of pseudo-relaxation. The arms and legs can be flexed and extended, remaining quietly in place. Upon a casual observation it is

almost impossible to differentiate this condition from that of true relaxation. In the case of children, where it is quite commonly found, it may sometimes be detected by sharply tapping the platysma myoides of the extended side; if the patient is simply sleeping there will be a sympathetic dilation of the pupil of the same side. This condition of pseudo-relaxation may be accounted for in the following manner: During the period in question, the anæsthetic is producing chiefly cerebral effects or no effect at all. The

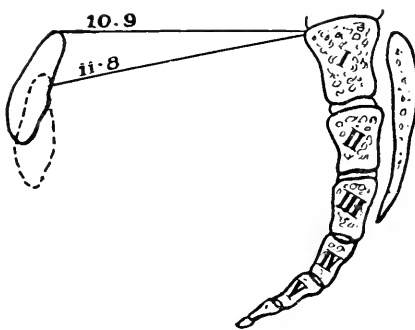

FIG. 45.—Diagram to explain Walcher position, see p. 57. (After Williams' Obstetrics.)

motor nerves have lost none of their irritability. They are simply receiving no stimuli. The condition is much like that of natural sleep. Later the physiological effects of the ether become evident in a discharge of energy, which exhibits itself in general or local rigidity. Relaxation appearing shortly after the anæsthetic has commenced and which has not been preceded by a definite, however brief, stage of excitement should be regarded with suspicion.

Occasionally true relaxation does come on in this manner, but this is unusual.

The preliminary use of morphine may so far do away with the period of excitement that its presence is not noted. In such cases, true relaxation will come on with a quietness and rapidity which will strongly suggest the pseudo-state. One must not depend solely upon the evidences of relaxation. These must be corroborated by the condition of the lid and eye reflexes.

True relaxation may often be distinguished from the spurious by examining the condition of the masseters. It will usually be found that in true relaxation the lower jaw can be made to move freely up and down, while with pseudo-relaxation, the teeth are tightly clenched.

B. THE CAUSES OF TRUE RELAXATION.—Relaxation may be said to occur when the deep muscle stimuli, which are constantly flowing to the normal muscle, have been inhibited by the action of the anæsthetic.

This action, while affecting chiefly the nervous mechanism, may also be due to the direct effect of anæsthetic upon the muscle tissue, rendering it less responsive to stimuli.

Whether or not the efferent motor mechanism is paralyzed to the exclusion of the afferent sensory, as suggested by Crile, is still open for discussion. However this may be, we may account for muscular relaxation by supposing an anæsthetic "block" acting on the motor nerves.

Loss of rigidity does not imply complete relaxation. We must, as already remarked, dispose of the normal tone of the muscle before the desired end can be obtained.

C. THE CONTROL OF THE RELAXATION.—If the pain stimuli are absent or diminished, the rigidity, which occurs as a reflex effect of this irritation will also be controlled. Local anæsthesia applied to the sensory nerve endings, as, for example, the injection of novocaine into the sensitive operative field, before incising, will result in an absence of rigidity on the part of those muscles, which would normally be involved in this reflex. Under a light anæsthesia, such as that secured by nitrous oxide and oxygen there is no doubt as to this action.

The control of the relaxation then is largely the duty of the anæsthetist, who will bring about the best results by

removing and controlling as far as possible the causes of rigidity, *i.e.*, excitement, obstruction to the respiration, too early incisions, position of patient, operations on upper abdomen, gall-bladder and pelvic stimuli, dilatation of sphincter, anæsthetic *per se* and intra-abdominal distention.

II. MAINTENANCE

Having treated the first stage of a complete general anæsthesia, *induction*, we now proceed to the second stage, *maintenance*.

The stage of *maintenance* begins when general relaxation obtains, and when a constant depth of anæsthesia has been reached. It ends when the level, which has been held, is permanently permitted to drop.

Two varieties of *maintenance* may be noted: the *constant maintenance* and the *variable maintenance*.

Constant maintenance (Fig. 46) can only be obtained by means of a special mechanical device made for the purpose of delivering vapor in known percentages.

Variable maintenance is the type which occurs when anæsthesia is otherwise carried on.

Constant maintenance keeps the patient so completely anæsthetized throughout the operation that he will not inconveniently react to deeper stimuli. This type of anæsthesia protects the patient from afferent pain stimuli, and considers the amount of ether used as of little consequence.

The *varying* type, which obtains when the open, semi-open or closed drop method is used, aims to anticipate and hold in abeyance the reflex effects of trauma to the deeper structures, by increasing the anæsthesia according to indications. It aims to lessen the amount of ether used by allowing a lighter level as often as possible.

By a *varying maintenance* is meant one which varies

only under the immediate direction and control of the anæsthetist. The anæsthetist must always be in the "lead," so to speak. He must always know just where the patient is and *anticipate* the call for a lighter or deeper anæsthesia. For this reason he should be familiar with the operative procedure. He should know the technic and the demands of the surgeon with whom he works. Some surgeons appreciate a light anæsthesia, while others will not tolerate it.

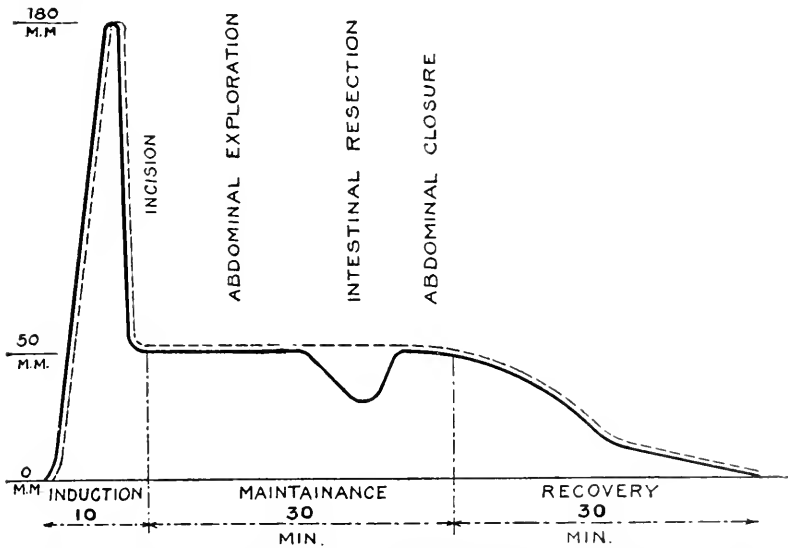

FIG. 46.—Curve showing variable and constant maintenance; constant maintenance shown by dotted line, variable by solid.

The anæsthetist should know something of the relative sensitiveness of the various tissues. He should know that the skin and the peritoneum react much more energetically than the muscle and bone tissues. With this knowledge, he will not be surprised in an operation for inguinal hernia, for example, to find the patient, who is going along peacefully enough through the dissection of the involved muscles, suddenly come out of the anæsthesia when traction is

made upon the hernial sac, whose formation, it will be remembered, is peritoneal.

If we were positive that the *amount* of ether made no difference, from a pathological point of view, and if we were sure that a deep anæsthesia afforded an absolute nerve block, it would be very poor technic to use any method but that which will give a constant level. In view of the present theories touching upon nerve block and shock, however, and our incomplete information regarding the massive effects of ether on the blood and tissues, we are justified in feeling that this varying, or as is sometimes called, empirical method, is really not so unreasonable after all.

The control of the stage of *maintenance*, as has already been stated, depends very largely upon the character of the induction. A stormy and delayed induction will very likely give rise to a stage of *maintenance* which is uneven and difficult to control.

The obstruction of the respiration is one of the most important elements in the control of the stage of *maintenance*. Persistent obstruction, during this stage, usually results in undesirable lightness with consequent rigidity, increased bleeding, and cyanosis. The paralysis of the tongue, which frequently causes this obstruction, can readily be relieved by the use of the throat tube (Fig. 14), whose great value we once more emphasize. Other types of obstruction, such as laryngeal, pulmonary, intra- and extra-abdominal pressure, must be separately and successfully dealt with, if one wishes a smooth *maintenance*.

If the respiration is deep and free, the patient must be carefully watched for signs of recovery; for it will be readily appreciated that such a respiration will soon dispose of the ether which may be in the patient's circulation.

Such patients call for an increased amount of ether on the open mask or the continuous use of the closed method.

On the other hand, the patient whose respirations are shallow is conserving most of the ether in his system and requires but a small amount to maintain the level in which we find him. This is quite typical of the patient who has received preliminary morphine medication.

Occasionally one sees a patient in the stage of *maintenance* forgotten for the time being by the anæsthetist, because of his lack of knowledge of the signs playing before his eyes, and because custom has, so to say, decreed that his work of "carrying the patient to the brink of the grave and leading him safely back again" is not quite so important as holding the retractors and looking into the patient's belly. Such a neglected patient may do one of two things: If the anæsthetist wishes to make sure of not being disturbed during his observations, and as a safeguard against this annoyance, pours on ether without watching the patient, the latter may die, as has occurred not infrequently under precisely such conditions. In this case the anæsthetist is not discharged from the hospital for criminal negligence, but the cause of death is registered as cardiac failure or status lymphaticus, which, however, does not clear the anæsthetist of serious guilt, due to his negligence. Or should the anæsthetist, bearing in mind these fatalities, in the course of his bird's-eye view of the field of operations, stop giving ether for safety's sake, then the patient does the other of the two things—he vomits. This invariably directs the condemning glances of the staff directly to the anæsthetist. As a result, anxious to cover up matters as quickly as possible, he does just the wrong thing. He immediately pushes the ether to the utmost.

The onset of vomiting implies the return of the pharyngeal reflexes. The reaction to ether is now much as it was in the early periods of *induction*; concentrated ether gives rise to spasm, rigidity, and delayed induction. The anæsthetist, in his anxiety to bring the patient back to the stage of *maintenance*, defeats his own ends. The anæsthetic should be given *slowly* until a tolerance is established. It may then be pushed to the desired level without ill effects.

While the stage of maintenance, therefore, may on the surface appear quite simple, it is fraught with danger to the patient and inconvenience to the surgeon, unless intelligently carried out.

From the surgeon's point of view the stage of maintenance should have no varying levels. It should be absolutely smooth. When indicated, relaxation should be complete and respiration of such depth that it will not interfere with intra-abdominal manipulations. With the *variable* type of maintenance this ideal is approached and will become perfect according to the skill of the anæsthetist.

With *constant* or unvarying maintenance, devised by Dr. Connell, it is the exception to fall short of this ideal.

Constant maintenance implies the use of definite percentages of ether. Technically such a percentage is spoken of as vapor tension.

THE PERCENTAGE OR VAPOR TENSION OF ETHER.—A short explanation must be given of the physical laws which govern the transfer of ether from the liquid state in the ether can to the state of solution in the blood and nervous system of the patient.

“The air around us exists under a pressure of one atmosphere and this pressure is expressed usually in terms of the height of a column of mercury that it will support—

namely a column of 760 mm. Hg which is known as the normal barometric pressure at sea level. Air is a mixture of gases and according to the mechanical theory of gas pressure each constituent exerts a pressure corresponding to the proportion of that gas present. In atmospheric air, therefore, the oxygen being present to the extent of 20 per cent. exerts a pressure of $1/5$ of an atmosphere or $1/5$ of 760—162 mm. of Hg. (A saturated atmosphere of ether vapor under like conditions exerts a vapor pressure of 68 mm. Hg at -20° C., 182 mm. Hg at 0° C., and about 460 mm. at ordinary room temperature.)

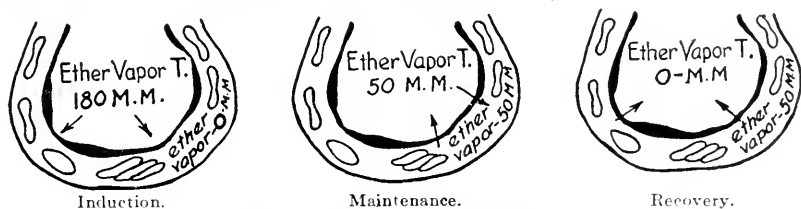

Induction.

Maintenance.

Recovery.

FIG. 47.—Diagram showing vapor tension of ether in alveolar air during the three stages of a complete anæsthesia.

“ When a gas is brought into contact with a liquid with which it does not react chemically, a certain number of the moving gaseous molecules penetrate the liquid and become dissolved. As many molecules will penetrate the liquid in a given time as escape from it, and the liquid will hold a definite number of the gas molecules in solution, it will be saturated for that pressure of the gas. If the pressure of the gas is increased, however, an equilibrium will be established at a higher level and more molecules of the gas will be dissolved in the liquid. Experiments have shown, in accordance with this mechanical conception, that the amount of a given gas dissolved by a given liquid varies, the temperature remaining the same, directly with the pressure, that is, it increases and decreases proportionally with

the rise and fall of the gas pressure. This is the law of Henry. On the other hand the amount of gas dissolved by a liquid varies inversely with the temperature. It follows also from the same mechanical views that in a mixture of gases each gas is dissolved in proportion to the pressure which it exerts, and not in proportion to the pressure of the mixture.

“ Air consists in round numbers of four parts of nitrogen and one part of oxygen. Consequently when a volume of water is exposed to the air, the oxygen is dissolved according to its ‘ partial pressure,’ that is, under a pressure of $1/5$ of an atmosphere (152 mm. of Hg). The water will contain only $1/5$ as much oxygen as it would if exposed to a full atmosphere of oxygen, that is, pure oxygen. And on the other hand if water has been saturated with oxygen at one atmosphere 760 mm. of pressure and is then exposed to the air, $4/5$ of the dissolved oxygen will be given off, since the pressure of the surrounding oxygen has been diminished this much.

“ When a gas is held in solution the equilibrium is destroyed if the pressure of this gas in the surrounding medium or atmosphere is changed. If this pressure is increased the liquid takes up more of the gas, as an equilibrium is established at a higher level. If the pressure is decreased the liquid gives off some of the gas. That pressure of the gas in the surrounding atmosphere at which equilibrium is established measures the tension of the gas in the liquid at the time. Thus when a bowl of water is exposed to the air the tension of the oxygen in the solution is 152 mm. Hg; that of the nitrogen 608 mm. Hg. If the same water is exposed to pure oxygen the tension of the oxygen in solution is equal to 760 mm. Hg, while that of

the nitrogen sinks to zero if the gas that is given off from the water is removed. With compounds such as oxyhæmoglobin the tension under which the oxygen is held is measured by the pressure of the gas in the surrounding atmosphere at which the compound neither takes up nor gives off oxygen. If, therefore, it is necessary to determine the tension of any gas held in solution or in dissociable combination it is sufficient to determine the percentage of that gas in the surrounding atmosphere and thus ascertain the partial pressure which it exerts. If the atmosphere contains 5 per cent. of a given gas the partial pressure exerted by it is equal to 38 mm. Hg (760 times .05) and this figure expresses the tension under which the gas is held in solution or combination in a liquid exposed to such an atmosphere. (If the atmosphere contains 6.58 per cent. of ether vapor the partial pressure exerted by it is 50 mm. Hg.)

“It is important not to confuse the tension at which a gas is held in a liquid with the volume of the gas. Thus blood exposed to the air contains its oxygen under a tension of 152 mm. Hg but the amount of oxygen is equal to twenty volumes per cent. Water exposed to the air contains its oxygen under the same tension but the amount of gas in solution is less than one volume per cent. Tensions of gases in liquids are expressed either in percentages of an atmosphere or in millimetres of mercury. Thus the tension of oxygen in arterial blood is found to be equal to about 10 per cent. of an atmosphere of 76 mm. Hg.” (The tension of ether vapor necessary to maintain anæsthesia is about 50 mm. Hg.)”—Howell; matter in parentheses ours.

Were it of advantage that a *saturated* atmosphere of ether at room temperature be breathed by a patient, so much ether could be dissolved in the blood that the vapor

tension of the ether dissolved would finally equal that of the vapor in the lung, or 460 millimetres. Yet it is found clinically that a sufficient depth of anæsthesia has been achieved when the amount dissolved in the blood has a vapor tension of 50 millimetres. To insure this amount being dissolved into the blood within a reasonable time,—six to eight minutes being usually employed in induction—it

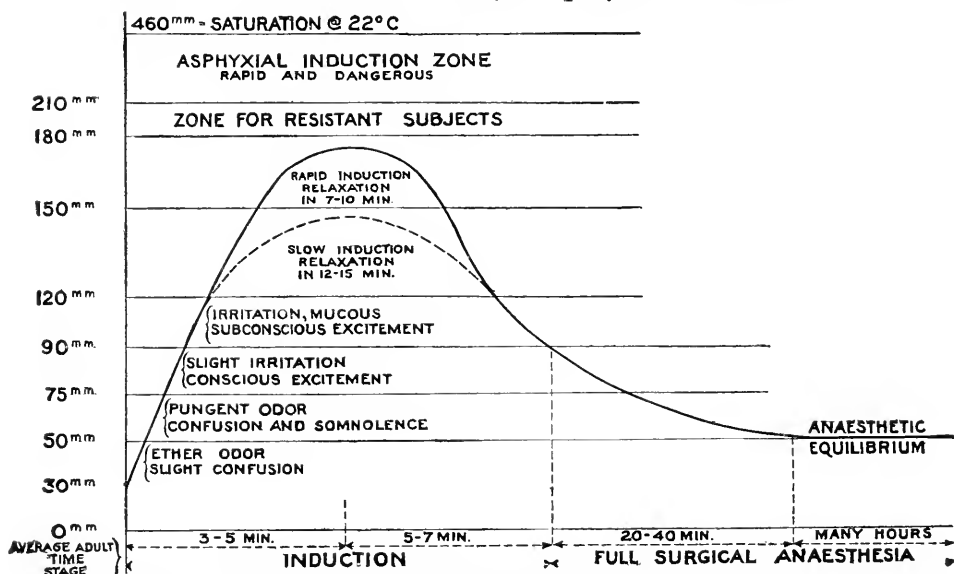

FIG. 48.—Vapor pressure of ether in tidal air for induction and maintenance of full anaesthesia. Partial pressure of vapor in millimetres of mercury (Courtesy of Dr. K. Connell, Johnson's Surgery, Appleton.)

is required that a much stronger ether vapor be breathed during induction than is needed merely to maintain anaesthesia. (Figs. 48 and 49).

To induce anaesthesia rapidly, the vapor must be so abundant as to exert a vapor tension of at least 180 millimetres (Figs. 48 and 49). This gradually crowds the required amount of ether into the blood and nervous system. When the blood approaches the proper saturation, as indicated by the signs of anaesthesia, the amount

of ether present in the air breathed is gradually lowered until finally, in ideal anæsthesia, the pressure of ether vapor in the lung balances the tension of ether dissolved in the blood and the patient sleeps in quiet, uniform anæsthesia of the desired depth. This is finally achieved at a level of 50 millimetres of ether tension; or by *volumetric* percentage

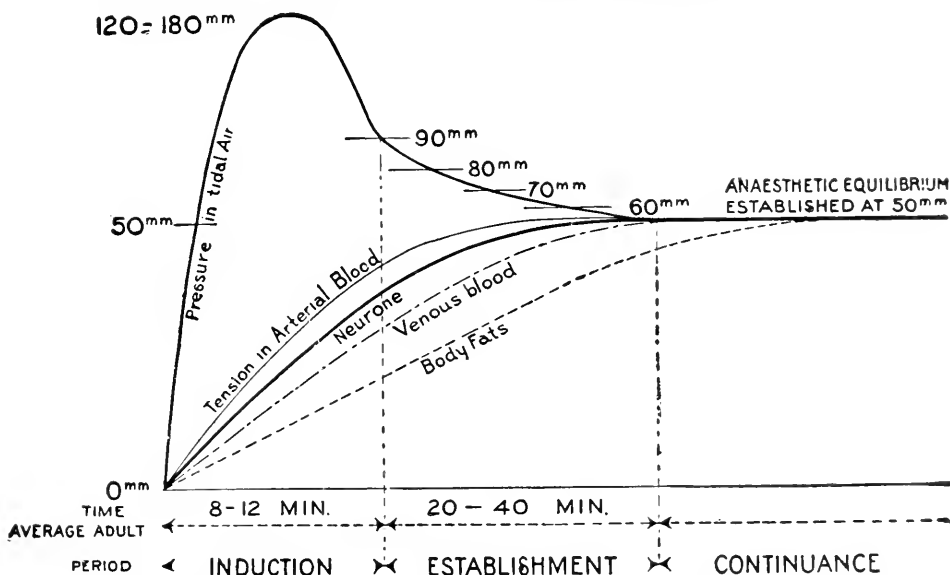

FIG. 49.—Plot of ether vapor pressure in pulmonary tidal air and ether tension in body in first hour of ideal anæsthesia. (Courtesy of Dr. K. Connell, Johnson's Surgery, Appleton.)

6.58 per cent. of the air breathed should be ether vapor (Figs. 48, 49 and 50). At this level, both the small child and robust alcoholic sleep in anæsthesia of proper depth.

The foregoing facts throw light on the following:

The value of warming liquid ether to promote evaporation (not the value of warming ether vapor, which is nil).

Safety of the open drop mask with its hoar frost evaporating surface (much reduced evaporating temperature).

The efficiency of the closed system of anæsthetization (because of the heat from rebreathing).

The greater efficiency of using a warmed apparatus (warm metal) for induction.

If one sets an ether vapor bottle in water 100° F., the ether vapor which issues approaches 100 per cent. instead of being 60 per cent. (460 mm. of 760 mm.) or less (see p.148).

If with the semi-open method the patient rebreathes a little, this increased heat serves to give us better control of the patient.

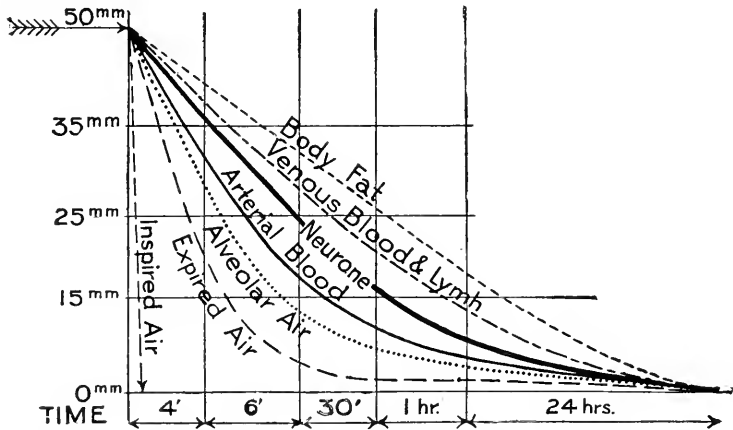

FIG. 50.—Plot of ether tension in body. Recovery stage after full ether anæsthesia. (Courtesy of Dr. K. Connell, Johnson's Surgery.)

THE VOLUME EMPLOYED.—Following the question of vapor tension or the strength of the ether vapor, the bulk of the vapor administered is our next consideration. In order that the respiration may be tranquil, a sufficient *volume* must be administered. The amount necessary varies according to the individual from 10 to 18 litres a minute.

The indicator on the anæsthetometer shows the volume which is being delivered, and we are provided with the means to regulate automatically the amount of ether added to each litre and the consequent percentage of ether vapor.

THE PRESSURE AT WHICH THE VAPOR IS DELIVERED.—This vapor, which is now being delivered in sufficient volume to fill all the requirements for tidal volume and at a percentage which is constantly under our control, must be administered to the patient at a pressure sufficient to carry it deep into the pharynx and to exclude atmospheric air.

The necessary volume of 10 to 18 litres a minute should be delivered at a pressure of from 15 to 30 mm., according to the individual in question. The volume is intended to be in excess to the respiratory needs and this delivery, under the pressure mentioned above, practically provides the patient with *an atmosphere* of a known and constant percentage.

We have now considered and explained vapor pressure or tension; seen the need of a vapor pressure of 180 mm. or more for the stage of induction, and have established a vapor pressure of 50 mm. as a safe and satisfactory pressure for maintenance. For apparatus see Fig. 78.

CONTROL OF MAINTENANCE.—The control of maintenance resolves itself into: First, the undivided and interested attention of the anæsthetist. Anything which has a tendency to interfere with this should be eliminated, as trouble is certain to follow sooner or later. Second, the patient must be the final index governing the quality and the amount of the anæsthetic. The patient must never be forced against all his protesting signs to accept what is theoretically correct. The art of anæsthesia does not permit us to court the patient's death in this fashion. If, for example, the surgeon complains of rigidity during the course of *maintenance*, remarking, "Won't you please get him under," or "he is like a board," or simply stops his procedure and looks at you in unutterable disgust, do not

soak the patient with ether in the presence of a dilated pupil, absent corneal reflex, and cyanosis. Be absolutely certain that you know the cause of the rigidity. Be sure that the respirations are free and that the position on the table is good; that the patient is really light before you go ahead, and to protect yourself from abuse, give him the last push which sends him "over the brink." You are the pilot on the ship *Patient*. It is your duty to look out for the shoals and the breakers which threaten her course. Who ever heard of a trustworthy pilot leaving the wheel to lose himself in some diversion going on aboard? Do not let your first warning be a scraping of the keel as she rides over shallows, that is to say, when the patient begins to retch; or the sudden startling sound of breakers, as the respirations become sighing and cease, and cyanosis becomes deeper and deeper, the eyelids widely separated and the pupils, with the iris almost gone, staring through a lustreless cornea. Unless one is a careful and observant pilot *all the time*, he will find himself drifting from the course and endangering the life of this human being so wholly under his control.

We must realize that this business is a most serious one; that its frequent execution by the youngest and most inexperienced interne is a most unjust thing. That in this matter the house officers, who incidentally rank above you and who have given a few hundred anæsthetics are not so expert that from their position at the retractors they can give you precise long-distance information as to the immediate needs of the patient. The color, the respirations, the pulse and the eye signs are our masters. Learn well how to obey these and all will go smoothly. If the surgeon and the senior house officers would force the anæsthetist to study the symptoms carefully and to be personally responsible for

VOLUME EQUIVALENT IN AIR AT 760 mm ³ BAROMETER	VAPOR TENSION	ZONE	LEVEL OF NERVE CENTRE DISASSOCIATION	DEPTH OF ANÆSTHESIA	UTILITY
60.4%	460 mm	RAPIDLY LETHAL		ASPHYXIAL AND LETHAL	
27.6%	210 mm	SLOWLY LETHAL	<input checked="" type="checkbox"/> CARDIAC CENTER <input checked="" type="checkbox"/> RESPIRATORY CENTER <input checked="" type="checkbox"/> DEPRESSION OF THE VASO-MOTOR CENTER <input checked="" type="checkbox"/> CEREBELLUM <input checked="" type="checkbox"/> MESENCEPHALIC REFLEX <input type="checkbox"/> DEPRESSION OF RESPIRATORY CENTER	LETHAL	
11.84%	90 mm	PROFOUND	<input checked="" type="checkbox"/> CEREBELLUM <input checked="" type="checkbox"/> MESENCEPHALIC REFLEX <input checked="" type="checkbox"/> DEPRESSION OF RESPIRATORY CENTER	PROFOUND	FOR TRACTION ON THE MESENTERY AND BILE TRACTS
9.2%	70 mm	DEEP	<input checked="" type="checkbox"/> PERITONEAL REFLEX <input checked="" type="checkbox"/> PUPIL REFLEX <input checked="" type="checkbox"/> ANAL REFLEX	DEEP	ABDOMINAL THORACIC AND CRANIAL SURGERY
7.24%	55 mm	FULL SURGICAL	<input checked="" type="checkbox"/> CORNEAL REFLEX <input checked="" type="checkbox"/> SPINAL REFLEXES <input checked="" type="checkbox"/> LARYNGEAL REFLEX <input checked="" type="checkbox"/> PHARYNGEAL REFLEXES	FULL	HERNIA AMPUTATION OF BREAST ETC.
6.3%	48 mm	LIGHT SURGICAL	<input checked="" type="checkbox"/> KIDNEY REFLEX <input checked="" type="checkbox"/> LARYNGEAL REFLEX <input checked="" type="checkbox"/> PHARYNGEAL REFLEXES	LIGHT	
4.6%	35 mm	SUB CONSCIOUS	<input checked="" type="checkbox"/> KIDNEY REFLEX <input checked="" type="checkbox"/> LARYNGEAL & VAGUS REFLEX <input checked="" type="checkbox"/> MOVEMENT OF THE EYEBALL <input checked="" type="checkbox"/> VOMITING CENTER <input checked="" type="checkbox"/> SUBCONSCIOUS MOVEMENT <input checked="" type="checkbox"/> VOLUNTARY MOVEMENT <input checked="" type="checkbox"/> CONSCIOUSNESS <input checked="" type="checkbox"/> CO-ORDINATE THOUGHT <input checked="" type="checkbox"/> HIGHLY CO-ORDINATE THOUGHT	SUBCONSCIOUS ANÆSTHESIA	PLASTIC AND OTHER SUPERFICIAL OPERATIONS INCISION OF VENTRALS
3.28%	25 mm	LIGHT SUBCONSCIOUS	<input checked="" type="checkbox"/> SUBCONSCIOUS MOVEMENT <input checked="" type="checkbox"/> VOLUNTARY MOVEMENT <input checked="" type="checkbox"/> CONSCIOUSNESS <input checked="" type="checkbox"/> CO-ORDINATE THOUGHT <input checked="" type="checkbox"/> HIGHLY CO-ORDINATE THOUGHT	SUBCONSCIOUS ANÆSTHESIA	INCISION OF ARTERIES REDUCTION OF FRACTURE SUPPLEMENT OF LOCAL ANÆSTHETIC AND NITROUS OXIDE
1.98%	15 mm	CONFUSION		CONSCIOUS ANÆSTHESIA	SUPPLEMENT OF LOCAL ANÆSTHETIC
0.0%	0 mm				

Fig. 51.—Zones of ether anaesthesia.
 (Courtesy of Dr. K. Connell, Johnson's Surgery, Appleton.)

everything incidental to the anæsthetic, accepting freely, in case of doubt, the opinion of their pilot, a smoother and a safer anæsthesia would result.

We have considered the onset of the stage of *maintenance*, the *constant* and *variable* types available for our use and the responsibility of the anæsthetist towards the patient. Let us now take up the question: When does the stage of *maintenance* properly cease and the stage of *recovery* begin?

Maintenance ceases when we leave the *constant* or *variable* level, which we have held and reduce or stop the anæsthetic *with a view of bringing the patient back to consciousness*. While carrying on a *variable maintenance*, we may reduce and even stop the anæsthetic; but we do not do this with a view of bringing about the complete recovery of the patient. The motive which leads us to finally stop the anæsthetic is that which really constitutes the dividing line between the stages of *maintenance* and *recovery*.

III. THE STAGE OF RECOVERY

This stage begins with the permanent reduction of the anæsthetic and ends with the return of consciousness.

Because the inception of *recovery* is largely automatic, this stage of anæsthesia is likely to suffer from dangerous neglect. The anæsthetist is very apt to feel that when he ceases to give ether his responsibility is at an end, whereas his release does not come until consciousness returns.

We may conveniently consider the *evidences*, *types* and *control* of the stage of *recovery*.

A. THE EVIDENCES OF THE STAGE OF RECOVERY.—The stage of *recovery* becomes evident: (*a*) in the gradual and complete return of the reflexes; (*b*) in the return of consciousness.

(a) One of the first signs to appear, upon allowing the patient to recover, is a slowing down of the respirations. These will drop from 40 to 25 or 20 a minute. The pupil, which has been moderately dilated during the stage of *maintenance*, will contract. That which has been smaller than normal will become pin-point or widely dilated from sympathetic stimuli. There will be rolling of the eyeballs, also active lid and corneal reflexes. One may also expect the pulse to increase in rapidity. Rigidity will show itself in the masseters and in increased intra-abdominal tension. The patient will swallow, and, shortly after this, retch. Vomiting usually marks complete return of reflexes.

(b) Following the vomiting, which occurs upon the return of the reflexes, there may be a period of quiet, during which time the patient is slowly recovering consciousness. If this period of quiet does not follow upon several attacks of vomiting, the patient may develop either protracted cyanosis and vomiting, or on the other hand, may become pallid with barely perceptible pulse and shallow breathing.

B. THE TYPES OF RECOVERY.—The chief cause of recovery is, of course, the withdrawal of the anæsthetic.

We recognize two types of recovery (see Figs. 52 and 53). (a) recovery by crisis; (b) recovery by lysis.

(a) *Recovery by crisis* (Fig. 52) is that type of recovery in which the interval extending from the end of the stage of maintenance to the return of consciousness is very brief. This type of recovery is of course most desirable. Instead of coming about in the course of hours it takes place in minutes or seconds. The best example of recovery by crisis is found in *gas oxygen* anæsthesia. With this anæsthetic a patient, who has been held in the stage of *maintenance* for two or three hours, will recover consciousness in as many minutes.

(b) *Recovery by lysis* (Fig. 53) is a common occurrence in hospital anæsthesia where the anæsthetist uses a high level of maintenance to the end of the operation. Patients who experience this type of recovery may not regain consciousness for four or five hours after the end of the stage of maintenance. The most marked cases of this type of recovery are found in diabetic patients. Occasionally these patients never recover consciousness.

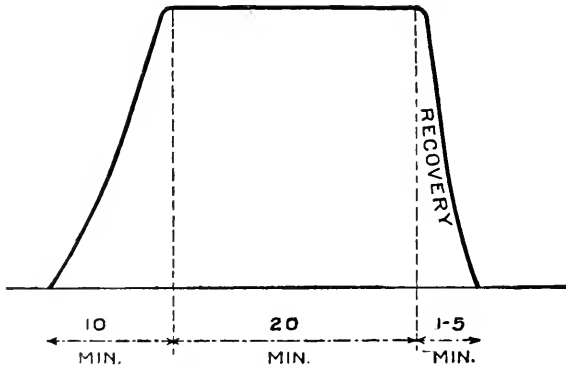

FIG. 52.—Recovery by crisis.

The following factors tend to induce *recovery by crisis*: nitrous oxide oxygen anæsthesia; deep, free, rapid respirations; alcoholism; a short stage of *maintenance*; the use of closed method with good oxygenation and employment of rebreathing; the surgeon who permits early *recovery*.

The following factors tend to produce *recovery by lysis*: ether anæsthesia; a long stage of *maintenance*; preliminary morphine medication; acidosis; shallow or obstructed respirations; the use of the closed method with persistent high *maintenance* and cyanosis.

C. THE CONTROL OF THE STAGE OF RECOVERY.—The control of the stage of recovery divides itself naturally into: (a) that portion dating from the onset of the stage to the

time when the reflexes have completely returned; (b) that portion dating from the complete return of the reflexes to the return of consciousness.

We recognize these two periods of *recovery* because this division naturally comes about in the treatment of the patient. Before the reflexes have returned the patient is under the immediate supervision of the anæsthetist. After the complete return of the reflexes he usually passes into the hands of the nurse.

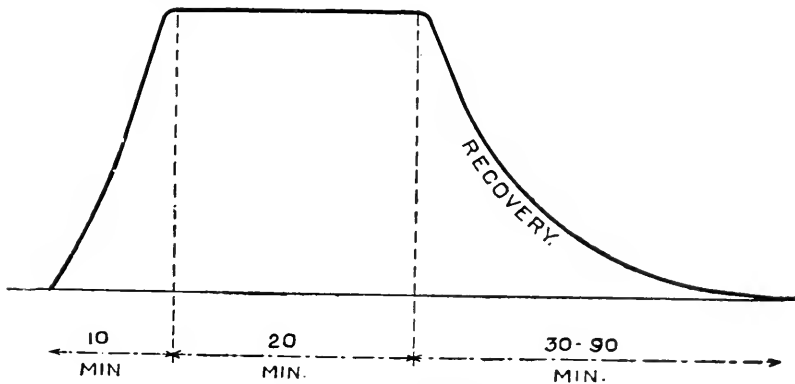

FIG. 53.—Recovery by lysis.

(a) The first period of the stage of *recovery* should take place in the operating room on the operating table. The vomiting, which accompanies the return of the reflexes, should be over by the time the patient leaves the operating room.

Some patients do not vomit upon the return of the reflexes, but the large proportion who do not at least retch once or twice. It will be understood that at this time, consciousness having not yet returned, such retching and vomiting are not distressing to the patient.

Our chief problem in controlling the stage of *recovery* is to determine when to begin. The exact time at which

the anæsthetic may be stopped is governed largely by experience. This is one of the features which go to make up the *Art of Anæsthesia*. Broadly speaking, in the case of abdominal operations, a moderate level of *maintenance* having been carried, the anæsthetic may be permanently reduced as soon as the fascia is closed. When the surgeon begins to sew up the skin the face piece may be removed. In operations other than intra-abdominal, the anæsthetic may be reduced at an earlier period, the index in these cases being the comfort and freedom of the surgeon from objectionable signs, as rigidity, vomiting, movement, etc.

If the throat tube has been in use during the course of the operation, it should be left in place until retching begins. By maintaining a free airway, an early recovery is thus obtained. If the Trendelenburg position has been used, when the head of the table has been raised, a lessened cerebral circulation will result. If this position be exaggerated as in the case of upper abdominal operations, the pulse should be carefully observed for shock. The anæsthetic may also be reduced and withdrawn at an earlier period. If the *induction* has been stormy, and the *maintenance* controlled with difficulty, the anæsthetist should pay particular attention to the patient during the stage of *recovery*, for there are likely to be attacks of vomiting accompanied by masseteric spasm and distressing cyanosis. If this trouble is anticipated, the mouth tube should be held in place until the reflexes have returned to such a degree that the active laryngeal reflexes will not permit of the inspiration of vomited material.

(b) It will readily be appreciated that the second period of recovery (after the reflexes have returned) will be influenced by the fact that the operation has been done in the

home instead of in the hospital. In this case, unless specially trained nurses be available, the patient must be watched carefully until consciousness has returned. The return of consciousness need not consist of a complete orientation, a clear-cut appreciation of all that has taken place. It is sufficient that the patient answers questions intelligently. It is sufficient that she "has found herself," so to speak. As the patient approaches the anæsthetic somewhat confused by the action of the preliminary morphine, so it is not only permissible but advantageous to leave her in some confusion regarding her condition and somewhat irresponsive to the pain which would otherwise torment her.

Ninety-nine cases out of one hundred would probably make an uneventful recovery, if abandoned to themselves after the reflexes have returned. The remaining one might die. Is it not worth the possible saving of one life in a hundred cases to watch carefully the recovery of each? If that life was ours there would be but one answer.

The recovery may worry us either because the patient develops continual spasm, cyanosis and vomiting, or, on the other hand, because of pallor, almost imperceptible pulse, and a slow and very shallow respiration.

The first trouble is usually noticeable at once. In this case the wooden mouth gag may be introduced, the teeth separated, and tip of tongue pulled forward for a moment by grasping it with gauze or with an ordinary sponge forceps. If it is impossible to separate the teeth, or if there is not room enough behind the last molar and the ascending ramus of the jaw to pass in the finger and depress the tongue, then a large catheter, moistened with the patient's saliva, should be passed through one of the nostrils by the

seat of obstruction into the laryngopharynx. Air is what patient needs and when it is admitted the spasm will pass.

As the olfactory sense returns, the patient, upon smelling her expirations laden with ether, will often vomit reflexly. This type of vomiting frequently responds to treatment designed to obscure the odor or reduce the receptive powers of the olfactory mucous membrane. A piece of gauze moistened with vinegar, essence of orange



FIG. 54.—Gauze on upper lip moistened with essence of orange.

or some aromatic oil, placed on the upper lip, will often produce the desired result (Fig. 54).

The author recalls a recent case in which this particular form of reflex vomiting was relieved by inhalations of essence of orange. The patient, a rather high-strung young woman, had previously been twice anesthetized by ether. Her recovery and post-anæsthetic period were characterized by persistent and distressing vomiting. Following a subsequent and rather prolonged ether anæsthesia with a

high level of maintenance, the patient gave signs of *recovery by crisis*. The reflexes returned rapidly and she retched and threatened to vomit. As she began to retch, essence of orange on a gauze wipe was placed over her nose and mouth. The retching stopped at once and did not return; the subsequent recovery was entirely tranquil with a single brief attack of retching after an interval of hours.

The second class of patients, those who suddenly develop imperceptible pulse and very shallow respirations after the return of the reflexes, act in response to complications which are obscure and difficult to meet.

This change usually comes suddenly, following in the course of a normal *induction* and *maintenance* and early *recovery*. It may be seen in the robust as well as in the delicate. An unusually profound reaction to morphine, loss of CO₂, or a condition resembling ordinary syncope, may bring about this condition. Such patients, however, usually pass on to an uneventful recovery.

When the nurse is placed in charge of the patient in the second stage of recovery, she should be instructed to keep the patient well blanketed, to watch closely the color, the respirations, and the vomiting. She should note carefully the position of the hot water bags, which have been applied to the patient. Continuous cyanosis, shallow, slow respirations (10 or less per minute) should be reported at once. When vomiting occurs, the patient should be placed on her side and the head extended. If there be pallor, with rapid running pulse, indicating possibly internal hemorrhage, the physician should be summoned promptly.

The sooner consciousness returns, the better the patient is able to cope with his condition. Generally speaking, we may say that *recovery by crisis* argues well for the final and uncomplicated surgical recovery.

CHAPTER III

THE SIGNS OF ANÆSTHESIA

THE signs of anæsthesia may be considered under five headings: the *respiratory*; the *color*; the *muscular*; the *eye*; and the *pulse*.

During the periods of excitement and rigidity, we are concerned chiefly with the first two, the respiration and the color. As anæsthesia progresses, the muscular signs become of value, later the eye sign and lastly the pulse. During the early periods of *induction*, the respiration and the color must be under satisfactory control. The phenomena exhibited by the other groups at this time are but incidental and of negative value. That is, they but serve to show us that the patient is not under the influence of the anæsthetic. As anæsthesia progresses, however, these signs become of positive value by assuring us that the patient is under the influence of the anæsthetic and in our control.

I. THE RESPIRATORY SIGNS

Perhaps the most important single sign of this group is the respiration. We should watch the respiration closely from the beginning of *induction* to the end of *recovery*. We should be intimately acquainted with the normal respiration and be able to detect any deviation from the normal limits by the sound alone. Experience lends one a sense of safety which becomes so acute that abnormalities grate upon the hearer and spur him to relieve that

which he might otherwise suffer to persist. On the other hand this experience will also breed confidence and deliberate action in circumstances which might otherwise terrify and lead to manipulations, dangerous and injurious to the patient. For example, a moderate but persistent degree of obstruction might be unnoticed by the beginner, while the experienced man, by making use of the throat tube, will relieve this obstruction and secure a much desired relaxation. On the other hand, during the stage of *induction*, the beginner may become terrified by a duski-ness, which is not really dangerous, and break a tooth in an effort to relieve a spasm, which would otherwise have passed off spontaneously without active interference.

We may consider the normal respiratory phenomena by noting the rate rhythm and amplitude, during the stages of *induction*, *maintenance* and *recovery*, as exhibited when the open and closed methods are respectively used.

THE NORMAL RESPIRATION UNDER ETHER WHEN THE OPEN METHOD IS USED.—When anaesthesia is induced by the drop method, the respirations are at first of normal rate, rhythm and amplitude. As the patient passes into the period of excitement, the rate increases and the rhythm remains constant, and the breathing becomes deeper. As anaesthesia progresses, the rate increases, the rhythm becomes slightly irregular while swallowing and some hesitation is prone to occur. The amplitude will vary from a scarcely noticeable respiration to a deep, free breathing. As the stage of *maintenance* is reached, the rate will increase to 35 or 40 respirations a minute; the rhythm will be resumed, and the breathing will be deep with a stertor of varying intensity. The first incision will produce no noticeable effect. As maintenance progresses the rate will

continue constantly between 40 and 50 a minute. The rhythm will be occasionally interrupted by gall-bladder work, when there will be an *expiratory grunt*, and by pelvic work, when there will be an *inspiratory sighing*. When work is being done on the stomach and intestines, the rhythm will usually remain undisturbed. The amplitude will have a tendency to become less as the stage of maintenance progresses. The degree of this shallowness will depend upon the extent to which rebreathing is permitted and upon the integrity of the diaphragm. As anæsthesia progresses the respirations are likely to become more and more shallow, but remain regular in rhythm. The stage of *recovery* having developed, the rate of respirations will decrease, the rhythm will become halting, and the breathing will become quite shallow.

THE NORMAL RESPIRATION UNDER ETHER WHEN THE CLOSED METHOD IS USED AND N₂O IS EMPLOYED.—Almost immediately following the application of the face piece, the respirations will become rapid, regular, and much deeper than normal. This is due to the specific effect of the N₂O, creating what is known as the “*besoin de respire*,” or the necessity to breathe. If ether is now given cautiously, but with constantly increasing strength, the patient will shortly lapse into a stertor. As air is permitted, the rate will fall somewhat, but the rhythm will continue and the depth will be somewhat less. Under these conditions we pass into the stage of *maintenance*. Here we will experience differences due to rebreathing and dependent upon the regularity with which our apparatus permits us to deliver ether. If we pour in a large amount at long intervals, the respirations will be slow, spasmodic and shallow immediately upon receiving the dose, smoothing out as the toler-

ance is established. Small doses often repeated tend to produce undisturbed respirations.

Briefly, during the stage of *induction*, when the *closed method* is used, the respirations are more rapid and deeper. During *maintenance*, less rhythmical and deeper; during *recovery*, more rapid, regular and deeper.

It will be seen that these variations from the open method are advantageous, since deep respirations give us better control of the patient.

RESPIRATORY ABNORMALITIES WHICH ARE LIKELY TO OCCUR WHEN BOTH THE OPEN AND CLOSED METHODS ARE USED.—We may take up separately the abnormalities occurring in induction, maintenance and recovery.

Abnormalities which may Occur During the Stage of Induction: Rate.—The patient may scarcely breathe, except in a very shallow, superficial sort of way, or, on the other hand, the respirations may be very rapid. The former conditions will sometimes occur in women who have had morphine; the latter will be frequently seen in children. With a view of securing a speedy *induction*, rapid breathing will of course be advantageous. Slow breathing will delay the completion of anæsthesia, and frequently be accompanied by vomiting. The use of a closed ether apparatus with a gas ether sequence usually overcomes the embarrassment incident to this type of respiration.

Rhythm.—Unless care is exercised to avoid all occasions of excitement, especially over concentration of ether at the outset, spasm of the respiration is almost sure to occur. This implies a respiration which is jerky in character, with a varying degree of obstruction. Such unsatisfactory rhythm will automatically adjust itself when the obstruction is overcome and the anæsthesia deepens. Broadly

speaking, true relaxation and satisfactory *maintenance* do not co-exist with a spasmodic, obstructed respiration.

Amplitude.—A reduction in the necessary volume of the respired air will result in delayed *induction*. One of the most frequent causes of the patient not “going under” is the lack of deep respirations. The tension or the percentage of ether in the blood depends entirely upon the amount which is offered to the circulation at the walls of the pulmonary alveoli. If the breathing is superficial, the ether enters only the trachea and larger bronchi, and must depend entirely upon diffusion to reach the finer alveoli. This type of *induction* frequently occurs when the open method is used, and also where the face piece of the closed apparatus is not in contact with the face at the bridge of the nose and under the cheek. Such cases seem to be going along favorably, the breathing is quiet and the color is good, sometimes a slight stertor is heard. As preparations are made to scrub up, however, the patient will suddenly make a smothered remark and begin an active period of excitement.

During the stage of induction the patient must breathe rapidly, rhythmically and deeply, if the best results are to be obtained.

Abnormalities which may Occur During the Stage of Maintenance.—*Rate.*—When the stage of *maintenance* has been entered into, the *rate of the respiration* may suddenly increase or drop as the skin is incised or the peritoneum is opened. If this increase is co-existent with abdominal rigidity, the level of the anæsthesia must of course be raised, otherwise a change in rate may be ignored. This sign is often a valuable index to the true depth of the anæsthesia. If the patient does not react to these manipula-

tions, he is to be considered under satisfactory anæsthesia, even though the other signs of lightness may be present. Excessively rapid breathing occasionally develops. When the respiration increases to 50 a minute, the anæsthetic should be stopped, even though some signs of lightness may exist. One will usually find this rapid respiration co-existing with an absent corneal reflex, dilated pupil, and muscular relaxation. As a rule, withdrawal of the anæsthetic is quickly followed by a reduction in rate. Very sick patients, those who are septic or who have suffered from hemorrhage, will often react in this manner in the face of a light anæsthesia. If the relaxation be satisfactory, one should always keep these patients upon the lightest possible anæsthesia. Unusually slow respiration in the presence of signs of deep anæsthesia may be due to the effect of morphine or too much rebreathing. This sign is particularly distressing because it is so difficult to treat. If occurring where the open method is employed, morphine having been used, the closed method should be resorted to, in the hope that the accumulated CO_2 will serve to stimulate the respiration. If following in the course of excessive rebreathing, the condition may be due to a depression of the respiratory centre by the use of too much CO_2 or to lack of oxygen. Patients who do not react to rebreathing should be given a hypodermic of 1/100 gr. of atropine.

Rhythm.—The rhythm of the respiration during the stage of *maintenance* is either a source of comfort or the occasion of much anxiety. Disturbances of rhythm occurring upon gall-bladder or pelvic manipulation are usually reassuring, as they indicate a moderate lightness of anæsthesia. Respirations which lack rhythm from unknown

causes frequently indicate deep-lying trouble. Cerebral hemorrhage into the base, pulmonary embolus or overdosing with ether will often show itself by such a form of disturbance. Occasionally one meets with Cheyne-Stokes respiration. The author recalls such a case, in which Cheyne-Stokes respiration immediately preceded a fatal issue.

Disturbances of rhythm often occur where the level of the anæsthetic has been permitted to drop, the ether having been partially or completely withdrawn. In such a case, upon the reapplication of the mask into which ether has been poured, the respiration will become spasmodic. If the level has been very low, complete stoppage may result, followed by spasmodic breathing until the patient is once again anæsthetized. If the level is higher, the effect will be a temporary slowing, followed by an increase in rapidity.

Amplitude.—The amplitude of the respiration in the stage of *maintenance* appears to depend upon the action of the diaphragm and the presence or absence of CO_2 .

If a closed method is used, the breathing will be deeper throughout. If open, the reverse is true. If the level of the maintenance is moderate, 50 mm., the action of the diaphragm is vigorous and the respirations are deep; if the level is high, 80 mm., the action of the diaphragm is progressively affected and the respiration is shallow.

During upper abdominal operations, we must try to lessen the respiratory effort so that abdominal movement will be reduced as much as possible. First of all the respirations must be unobstructed. The consequent limitation of oxygen and the accumulation of CO_2 in these cases cause embarrassing movements of the diaphragm. If the respirations are as free as possible, and the abdominal respira-

tion is still annoying, we must partially paralyze the action of the diaphragm by raising the level of the maintenance. In this connection we may speak of the danger of trying to secure such relaxation where *nitrous oxide and oxygen* is the anæsthetic. In this case ether *must* be used. The securing of a higher level of maintenance in such cases should proceed with caution and in compliance with the signs of deep anæsthesia, as exhibited by the other signs of anæsthesia which we have at our command. The free use of oxygen often leads to decreased respiratory efforts and the desired result is thus obtained. This treatment should always be followed, and when successful is always preferable to raising the level of the anæsthetic. Occasionally when absolute freedom of the respiration obtains and no rebreathing is permitted, the patient will cease to breathe. This apnoea may continue for a minute or two. When enough CO₂ has accumulated to stimulate a respiration, the patient will breathe spontaneously. If cessation of the respiration occurs in the presence of good color, pulse and eye signs, which show a moderate degree of anæsthesia, one need not worry, for there must be other signs of depression before the patient is really in danger.

The Trendelenburg position often affects the amplitude of the respiration. This is particularly true of large, fat subjects. A low level of maintenance in these cases will cause embarrassing abdominal respirations. A high level will be prone to result in respirations which are alarmingly shallow.

Abnormalities in the Respiration which may Occur During the Stage of Recovery.—In the first half of recovery:

The rate of the respiration during the first half of the

stage of recovery, that is, to the complete return of the reflexes, is subject to the amount of manipulation which the patient experiences at this period. In the beginning of the stage there is little change; but as the reflexes return, the respiration may be increased or diminished. As the patient suddenly loses the stimulating effect of CO_2 , the respirations will drop in frequency, but as the pain of the stitches is felt, the respirations will again increase. Disturbances in the rhythm and amplitude are subject to attacks of retching and vomiting.

In the second half of recovery: In the second half of the stage of recovery, between the complete return of the reflexes and the return of consciousness, the rate may drop to six or eight respirations a minute. The rhythm may be regular or may resemble Cheyne-Stokes. The amplitude may be either small or large. Such cases may be ascribed to a profound reaction, to morphine or to a reaction which follows in the course of excessive rebreathing. One should differentiate these two types of cases, as the treatment for one would be the worst thing possible for the other. The depression of the respiration from the use of morphine will usually be associated with a pin-point pupil and will have a tendency to persist. Where a reaction to rebreathing is the cause, the pupil will be normal or enlarged and the condition will tend to pass off. When the patient will not breathe spontaneously, *artificial respiration* must be induced as follows:

Artificial Respiration.—Artificial respiration is for the purpose of intermittently replacing the air in the mouth, trachea and bronchi. The nature of this replacement must approach the ideal offered by spontaneous respiration. The rate, the volume, and the pressure under which fresh

air finds its way into the lungs are the standards which govern artificial respiration.

Respiration consists of two phases, inspiration and expiration. We are chiefly concerned with inspiration. Expiration comes about spontaneously through the natural resiliency of the structures involved.

There are two methods of artificial respiration: (1) negative ventilation; (2) positive ventilation.

Normal respiration brings about *negative ventilation*. The ribs being raised and the diaphragm contracted, the cavities containing the lungs are enlarged. Atmospheric pressure within the latter quickly fills the partial vacuum thus formed. With such normal respiration negative ventilation is most efficient.

Where spontaneous respiration has failed, however, artificial respiration by negative ventilation can bring about only a partial inspiration because the diaphragm has ceased to act. The ribs may be raised but the diaphragm cannot be lowered as in normal respiration.

Negative ventilation is exemplified by the well-known method of Sylvester, the technic of which is as follows:

1. The tongue is grasped by sponge or artery forceps and pulled well forward. This first manœuvre is absolutely essential to insure freedom of the airway. Complete extension of the head over the edge of the table should be practised, as shown in Figs. 55 and 56.

2. With the patient lying flat on his back, the head well extended, the operator stands at the head, grasps the arms just above the elbows and presses them firmly and steadily against the sides of the chest (Fig. 55). After a couple of seconds the arms are extended and brought over the patient's head. This act by lifting the ribs causes in-

spiration by negative ventilation (Fig. 56). These two movements should be repeated sixteen to eighteen times a minute.

Artificial Respiration by Positive Ventilation.—By positive ventilation we endeavor to intermittently distend the lungs by air delivered directly into the trachea or into the pharynx. At the time of distention (inspiration) the chest incidentally expands. We say incidentally because the movements of the chest are passive; they are only an index of the degree of lung expansion.

At the time of distention the paralyzed diaphragm sinks, being forced downward by the increased intrapulmonary pressure. Expiration occurs through the return of the diaphragm and the falling of the ribs.

The most important single factor in positive ventilation is the pressure at which the air is thrown into the lungs. This pressure should not exceed 25 to 30 mm. of mercury. If greater pressure is employed rupture of the delicate air vesicles may result. Positive ventilation may be brought about by intratracheal insufflation. The technic of this procedure is identical with that described on page 163 for intratracheal anæsthesia, the only difference being that air alone is delivered intermittently instead of constantly. This is the most reliable method of positive ventilation and may be done by an improvised catheter or small tube, to which is attached an ordinary foot bellows, and simple pressure gauge.

A pressure gauge may be improvised by putting one and one-half inches of mercury in the wash bottle attached to the oxygen tank. The short tube is left free, the long tube projects 25 mm. (one inch) below the surface of the mercury and is connected to the tube which delivers the

air from the bellows to the patient (see Fig. 57). Any pressure in this tube greater than 25 mm. or one inch of mercury will escape out of the bottle. If mercury is not available, a pitcher or jar of water 15 inches deep will do. A tube projecting into this water for a depth of $13\frac{1}{2}$ inches will give the same result since the specific gravity of mercury is 13.59.



FIG. 55.—Sylvester method of artificial respiration, first position

Positive ventilation by intrapharyngeal insufflation is not quite so efficient. Air delivered into the pharynx escapes in four directions: into the mouth, into the nose, into the œsophagus and stomach, and into the trachea. Every exit but the tracheal must be shut off. The mouth may be closed by a strip of adhesive plaster fastened at one end under the chin and at the other to the forehead. Escape through the nose is controlled by the presence of the nasal

tubes (Figs. 83 and 86) through which the air is being delivered. Accumulation of air in the stomach is prevented by placing a heavy weight (twenty pounds) on the abdomen and strapping this in position. The operator may sit on the abdomen if a weight is not available. If artificial respiration must be carried on during a laparotomy, a stomach tube should be passed and left *in situ*. This will

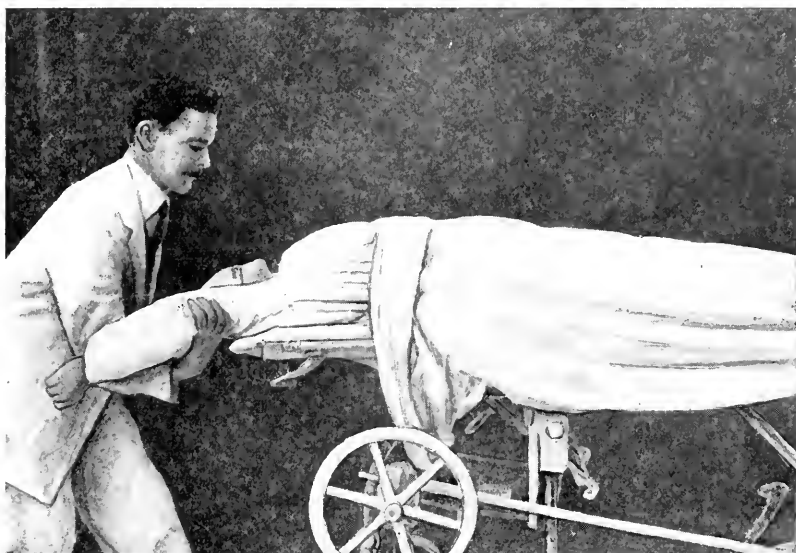

FIG. 56.—Sylvester method of artificial respiration, second position.

dispose of air which may accumulate in the stomach. The abdomen being open the operator may make manual pressure on the stomach, thus preventing its distention.

Pressure on the abdomen *per se* tends to overcome the circulatory shock which is present.

In addition to both negative and positive ventilation, inversion is frequently beneficial. The patient, even though full grown, is hung with the head down and swung

to and fro for some moments. Such treatment by increasing the cerebral circulation is often of decided benefit.

The "Lewis Pendulum Swing" (Fig. 58) is carried out as follows: The patient should be suspended by the fully flexed knees and swung forcibly from side to side for a period of from one to two minutes. Except with children, it is necessary for the operator to stand upon a box or other elevation sufficiently high to allow of a free swing. The

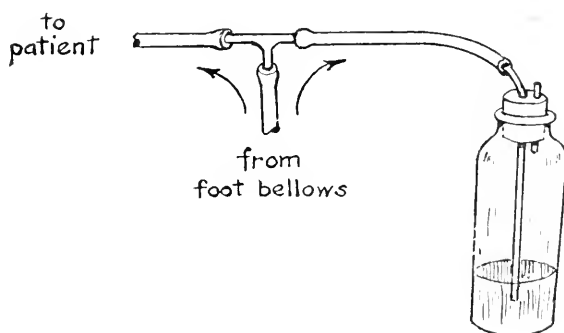

FIG. 57.—Simple form of Mercury Manometer.

suffusion of the neck and face, which is brought on by this swinging, is the index by which one may judge the effect of the centrifugation.

RECAPITULATION.—Broadly speaking, we may say that our chief respiratory difficulties *in the stage of induction* are disturbed rhythm and shallowness. Stoppage of the respiration in this stage is due to obstructed respiration or acapnia.

In maintenance, disturbances of rhythm and increased rate. Stoppage of the respiration in this stage is due to too much ether or acapnia.

In recovery, disturbances of rhythm and reduced rate.



FIG. 5S.—Lewis pendulum swing.

Stoppage of the respiration in this stage is due to obstruction of the respiration or to the untoward effect of morphine.

When the *open* drop method is employed, our chief

difficulty will be decreased amplitude. This will retard *induction*, diminish our control of *maintenance* and delay the *recovery*.

When the *closed* method is used, we will be annoyed by excessive respiratory efforts and, unless provision is made for constant small dosage as in the case of the closed drop method, we will find a frequent and embarrassing change in rhythm. It will also be found that the closed method will obscure respiratory sounds, which would be distinctly audible with an open mask.

In order to better appreciate the significance of abnormalities in respiration, it has been suggested that the anæsthetist occasionally try upon himself the rate of rhythm and amplitude which the patient exhibits.

II. THE COLOR SIGNS.

In company with the respiration, the color is one of the signs which becomes immediately available when anæsthesia is induced. While the color necessarily depends on the pulse, yet in many instances it is of more value, and certainly at all times deserves separate consideration. The color sign is especially useful during the stage of *induction* when, generally speaking, the pulse may be entirely ignored. During the stage of *maintenance* we are able to check up a doubtful duskiness by observing the color of the blood at the site of the wound. Dark blood will call for increased oxygenation in spite of an apparently good color of the lips and ears. It will be observed that in ether anæsthesia even those who have little or no color will, after *induction*, show a very definite ever-changing tint. This color will necessarily be more in evidence in the florid, full-blooded individual than in the septic or anæmic. It will

vary from a bright red through duskiness, blueness, grayness and pallor. What color shall we endeavor to maintain? The best color is the normal color of the patient, plus the flush which is the physiological effect of the ether. The cheeks and ears should be pink and the lips red. The blood issuing from the wound should be bright. The faces, necks and chests of the full-blooded, dark-complexioned individuals are very likely to be bright scarlet, fading as anæsthesia progresses. Occasionally an erythema appears, which persists for a short time. The ears and lips of the septic and anæmic should be pink; this will often be accompanied by a hectic flush of the cheeks. If the respiration is normal and sufficient oxygen is admitted, the color will be normal. All those factors which influence the respiration, as obstruction, posture, etc., will invariably react on the color.

We may consider three extremes of color—*bright red*, *cyanosis* and *pallor*.

Carbon dioxide, the respiratory stimulant, may be considered present in redness and cyanosis, where a condition of excessive respiration or hypercapnia exists. Pallor, however, implies a state of acapnia concomitant with an absent or greatly diminished respiration. Incidentally it will be well to remember that the absence or presence of carbon dioxide has nothing to do with the cyanosis. CO_2 is present in the serum as a complex acid and does not enter into union with the hæmoglobin. It is true that a cyanotic patient may suffer from an excess of CO_2 , but he may likewise suffer from a lack of it and yet remain blue. Cyanosis has so frequently been associated with conditions which tend to accumulate CO_2 , that the inference has frequently been made that the two are identical. The practical appli-

cation of these facts may be brought out by considering, for example, a patient who is rebreathing oxygen from a bag. As he continues to rebreathe he will become saturated with CO_2 , but his color will remain unchanged. On the other hand, a patient who is made to breathe to and fro into a bag containing atmospheric air (the respirations in their course being made to pass through lime water which will remove the CO_2), will soon dispose of the CO_2 in his system. He will become cyanotic then, not from the CO_2 which has been removed, but from the lack of oxygen.

WHEN THE OPEN METHOD IS USED.—The color is usually entirely satisfactory during *induction*. As *maintenance* progresses, however, the patient is prone to develop acapnia from loss of CO_2 . More or less pallor then appears and persists through the stage of *recovery*. One often finds associated with this loss of color a cold, perspiring skin.

WHEN THE CLOSED METHOD IS USED.—During the stage of *induction*, with a closed method, using a gas-ether sequence, the patient while breathing the nitrous oxide is prone to assume a dusky appearance, which rapidly passes to a marked cyanosis, if the air is excluded.

Limitation of oxygen during the period of excitement is thought to increase the potency of the ether and to hasten the onset of *maintenance*. The patient should never be permitted to be more than slightly dusky. A limited exclusion of air is recommended only because its use in sufficient quantity, to insure complete oxygenation, leads to a marked dilution of the strength of the ether vapor. Where oxygen may be had, this difficulty is overcome, and we may have perfect oxygenation during this stage. Marked cyanosis will be followed not only by delayed *induction* but

by an increase in blood-pressure, which is very likely to be harmful. When stertor has come on, and while the stage of rigidity still persists, air should be freely admitted and rebreathing encouraged. Even though the respirations seem satisfactory, one should not rest until the color is absolutely satisfactory. It will be recalled that obstruction may occur in the mouth and nose, in the pharynx, in the larynx, in the pulmonary absorbing surfaces and by external pressure on all these parts. Persistent cyanosis in the presence of free breathing, with no obstruction in the upper airway, would suggest an asthmatic or pneumonic process or possible cardiac insufficiency with an accumulation of blood in the right heart. In such a case oxygen may be given directly and efficiently by means of a closed apparatus.

During *maintenance*, a bright-red color is commonly associated with a warm skin and a profuse perspiration. Such patients should be carefully guarded against draughts which, by evaporating the surface moisture, will reduce the patient's temperature. When there is marked hemorrhage it is particularly important that a good color of the mucous membranes be maintained. Cyanosis at this time means more to a patient than it does when there is a large amount of circulating blood. In this condition the cheeks and ears become waxy in appearance. Free oxygen must be used in these patients to insure a good color.

In the stage of *maintenance*, when the closed method is used, the control of the color is either not so good or better than where the open method is employed. This will depend upon the ease with which atmospheric air or oxygen may be admitted to the apparatus. If the rebreathing is hampered by gauze in too large quantities or wrongly

placed, it will be found difficult to hold a good color. If the rebreathing is entirely free the stimulation from the CO_2 , by inducing a deeper respiration, will also afford a means of more easily oxygenating the patient.

The surgeon will sometimes remind us of the color index by remarking that the blood is very dark at the site of operation. This sign may also be quite marked even when the color of the lips and ears seems satisfactory.

In the Stage of Recovery when the Closed Method is Used.—During this stage we may find a tendency to pallor. This, however, will not be so marked as when the open method has been used. The presence or absence of color, and by color we mean pinkness, depends upon the depth of the respiration. A strong man breathing deeply may be bright red, while the same man scarcely breathing will sometimes appear waxy.

JAUNDICE.—We often meet patients who are intensely jaundiced. It is quite difficult to maintain a satisfactory color here. The mucous membranes must be depended upon to show the proper amount of oxygenation. A slight degree of cyanosis will often pass by unnoticed. This cyanosis, being a sign of deeper trouble, will often interfere with the smoothness of the anæsthetic. The color of the blood at the site of the wound will often be our best guide as to the proper oxygenation.

NEGROES.—This race of people shows a very unsatisfactory color index. Here again we must depend upon the color of the lips and the hue of the blood at the site of the wound. Pallor is sometimes evident as a clayish appearance of the skin, which may feel chilled and be bathed in cold perspiration. N_2O and O should not be used upon colored patients unless positive indications exist, since this

type of anæsthesia depends more upon the color sign than upon any other.

Briefly reviewing we find that the color and the respiration go hand in hand. The color may be taken as an index of the efficiency of the respiration; and will serve to indicate the necessity or inadvisability of interference. A good color is a guarantee of the safety of the patient at the particular moment under consideration. The color, while dependent upon the condition of the pulse, will nevertheless warn the anæsthetist of danger before a perceptible change can be felt in the rate or quality of the latter.

High color or duskiness is often associated with profuse perspiration and a warm skin. Hemorrhage and shock become evident in pallor, and a cold perspiration, which breaks out on the forehead. Cyanosis must never be looked upon with complacency. Pallor concentrates the attention upon the pulse, which now becomes our best guide as to the condition of the patient, and our most reliable index as to his need of stimulation.

III. THE MUSCULAR SIGNS

We have considered normal muscular tone, rigidity and relaxation. We have tried to emphasize the causes and the control of each. The signs exhibited by the muscular system depend for their value upon a variable degree of relaxation. Three signs may be easily observed: The *masseteric*, the *lid* and the *diaphragmatic*.

The **MASSETERIC SIGN** consists of a relaxation of the muscles, which control the lower jaw, permitting the mouth to be opened and closed without resistance. When one is in doubt as to the general relaxation which obtains the presence of relaxation of the lower jaw will almost

always settle the question. Occasionally, however, even when complete relaxation is present elsewhere, respiratory disturbances will cause incomplete freedom of the lower jaw, when one attempts to elicit this sign. During the period of excitement, rigidity and early relaxation, this sign is of course negative. If a "low" level of *maintenance* is held, this sign may not show itself in its fulness throughout the course of the anæsthesia. During a stage of *maintenance* suitable for abdominal relaxation, however, it is almost invariably present. As recovery proceeds one will note the relaxation pass off, the normal tone and rigidity of the masseters taking its place. This disappearance of the relaxation during the stage of *maintenance* is one of the early indications that the patient is recovering and must be either carefully watched or carried along at a higher level.

Where short operations are done for intra-oral work and an incomplete anæsthesia is all that is required, the anæsthetist should begin his *induction* with a mouth prop or cork between the patient's teeth, for with such a type of anæsthesia, rigidity of the masseters is the rule.

RELAXATION OF THE UPPER EYELID.—During normal sleep the eyelids, owing to the tone of the orbicularis palpebrarum, remain closed. In the late part of excitement and through the period of rigidity, one will find that if the eyelid is lifted and then released, it will fall back into place with more or less snap. Later it will remain open.

The lid sign is *present* when the eyelids on being separated remain separated. This sign should be taken on each side and the most inactive lid taken as the standard. In the later periods of *induction*, when stertor has come on and one is anxious to determine the exact condition of the pa-

tient, this sign with the *masseteric* sign will be found very valuable. The lid reflex is usually described as an eye sign. We feel, however, that it relates more directly to the muscular system. Furthermore the signs of true muscular relaxation during the stage of *induction* are none too many and may well be augmented by this addition.

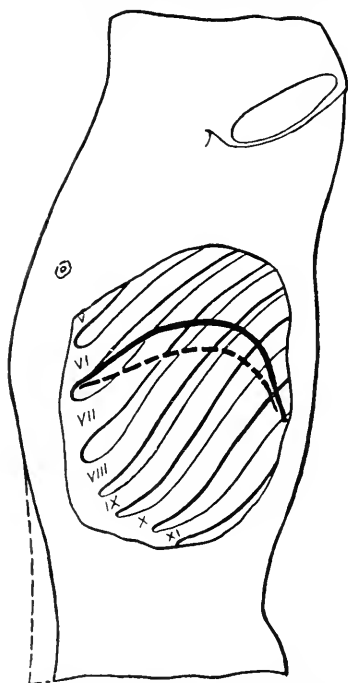

FIG. 59.—Diagram showing normal movement of diaphragm and abdominal wall during inspiration.

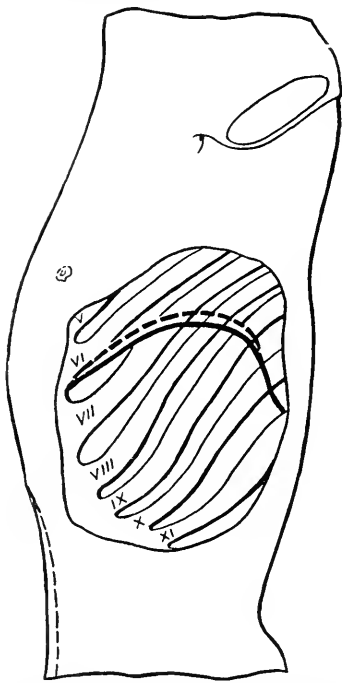

FIG. 60.—Diagram showing movements of diaphragm and the abdominal wall during inspiration, just before a fatal issue.

THE DIAPHRAGMATIC SIGN.—This sign deals with the tonus of the diaphragm. It is of value when one is obliged to carry a high level of *maintenance*, as is sometimes the case in upper abdominal operations. We base our determinations of the relaxation of the diaphragm upon the character of the abdominal respirations. Normally, when

inspiration takes place, the diaphragm moves downward upon the abdominal viscera and causes a distention of the abdomen, which raises the abdominal wall (Fig. 59). The amount of the abdominal movement is greatest during the period of excitement when the movements of the diaphragm are excessive. As anæsthesia progresses, these movements become less, but the abdomen still swells upon inspiration. If the level of the anæsthesia be excessively raised, however, the diaphragm relaxes, and the abdomen, instead of being distended, will sink during inspiration (Fig. 60). This sinking in of the abdomen during inspiration is one of the gravest danger signs and indicates that anæsthesia has been pushed beyond its legitimate limit. Preceding this paralysis the breathing will become almost entirely thoracic. These are the cases who have absolute relaxation, absent corneal reflex and a dilated pupil, and whose breathing is rapid and shallow. Occasionally we are obliged to "go the limit," but we should at least understand what constitutes "the limit."

Our first concern then is to secure relaxation of the eyelid and lower jaw. When we have passed into the stage of *maintenance* and we know that the patient is deeply anæsthetized, we should narrowly observe the movements of the abdomen during inspiration until the stage of recovery has begun.

IV. THE EYE SIGNS

The eye signs consist of three groups, the *lid* signs the *globe* signs and the *pupillary* signs.

THE LID REFLEXES consist of reflex responses to irritation of the sensitive conjunctiva and cornea. These signs

are as follows: *The Conjunctivo-Palpebral Reflex*, the *Corneal Reflex* and *Parsons's Sign*.

The *Conjunctivo-Palpebral Reflex* is the reflex which causes the eyelid to close when the tip of the finger, in separating the lids, gently brushes over the margin of the upper lid. This reflex must be differentiated from the lid reflex, which has been described under the muscular signs, and is due to the tone or the elasticity of the muscle which moves the lid.

The Corneal Reflex.—This reflex is without doubt the most valuable eye sign which we have. It is elicited as follows: Standing behind and above the patient, the operator gently bathes the orbital conjunctiva by moving the upper lid over it several times. He then separates the lids with his index finger. When the lids have been slightly separated, the index finger is removed and the pulp of the middle finger, moistened with vaseline, is very gently caused to brush over the centre of the cornea. The degree of activity, with which the eyelid then closes, constitutes one of the most unvarying signs of the depth of the anæsthesia. The operation is concluded by again washing over the orbit by the upper lid. This particular sign and its elicitation have been the subject of much adverse criticism. It has appeared to many a somewhat barbarous practice. The author once held this view. Needless to say it is not a sign to be used thoughtlessly or roughly. It is a sign which one uses to corroborate other signs. We have yet to see any trouble arising from its use. Compare this very mild form of irritation to that too often produced by a piece of gauze placed over the eyes, to protect them during the course of the anæsthesia. The lid reflex having been lost, the bare gauze rubs constantly and harshly against

the sensitive cornea. The result is a varying degree of conjunctivitis or worse. We cannot hide our heads like the ostrich and say that there is no harm because it is not visible.

Some advise that the eye signs, or at least the corneal reflex be disregarded. This may be done if one is not particular as to the exact condition of the patient at any given time. Such a course would appear analogous to one objecting to the taking of a blood count because of the possible danger of tetanus from infection, caused by the pin prick. The corneal reflex is without doubt the best corroborative sign which we have and, properly taken, is free from danger or annoyance to the patient.

During the period of excitement and rigidity, the corneal reflex is snappy; as relaxation comes on the sharpness of the reflex gradually decreases. When *maintenance* has been entered into, the reflex has either become quite sluggish or is absent. The reappearance of the corneal reflex and its variable activity during the stage of *maintenance* will give one a most satisfactory idea as to the exact depth of the anæsthesia. When the stage of *maintenance* is carried at such a high level that the corneal reflex has disappeared, its prompt return in the first stage of *recovery* will always prove a great comfort. Generally speaking we may say that a dangerous level of *maintenance* and an active corneal reflex do not coexist. One should not take this sign repeatedly on the same eye, as the sensitiveness will rapidly diminish. The most active of the two eyes should be taken as the standard. The use of morphine will frequently dull this reflex. When N_2O and O are used without ether, one will usually find a snappy reflex during an entirely tranquil stage of *maintenance*. Unexpected variations in this

reflex will be found in little children and very sick patients. Again we would urge that the individual patient be caused to form his own index of activity, and while this sign is most valuable *per se*, yet it should be supported and sustained by other signs.

Parsons's Sign.—This consists of a retraction of the lower lid towards the internal canthus, when the cartilaginous rim of the upper lid is pressed against the cornea immediately over the pupil. The degree to which the retraction of the lower lid takes place indicates the depth of the anæsthesia.

The Orbital Signs.—The presence or absence of movements of the eyeball during anæsthesia will often be found of value. As a sign purposeful movements will usually be recognized by the peculiar look of animation and expression. When these intelligent, calculating eyes look at us, we are likely to feel apologetic and to cover them over with gauze or a towel. When consciousness is lost, however, and the period of excitement or rigidity is well developed, we find that the eyeballs are fixed or that there is a slow movement from side to side. Movements of the eyeball from side to side are almost always a sign of light anæsthesia. We will be very likely to find such movements in the period of *excitement*, *rigidity* and early *relaxation*. During ordinary *maintenance* movement is absent, but it may occur when a very low level is carried. During the stage of *recovery* this sign will usually be found strongly in evidence and a precursor of approaching consciousness. During the stage of *maintenance*, when N_2O and O are the anæsthetic, the eyes will often be found looking fixedly downward. When ether is used, they are usually fixed centrally.

Generally speaking, we may say that when the eyes are stationary, looking either downward or straight forward, loss of consciousness is certain, and usually *induction* is nearing conclusion, or *maintenance* has been entered upon.

The Pupillary Signs.—Let us first consider briefly the physiology of the pupillary changes which may appear. We must explain *three reactions*: Dilation of the pupil; contraction of the pupil, and the reaction to light.

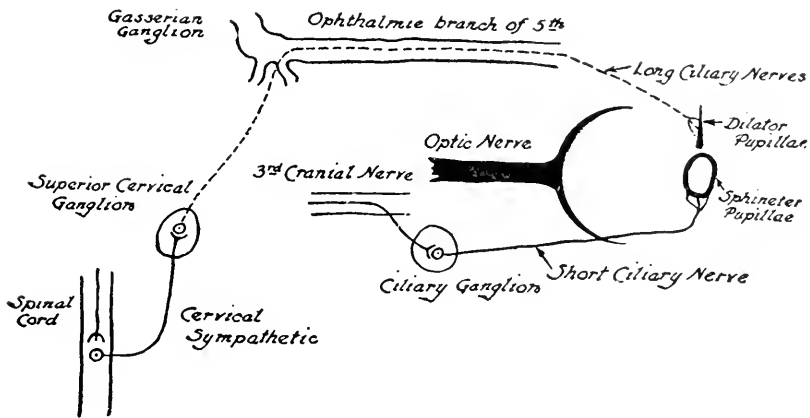

FIG. 61.—Diagram showing innervation of the dilator and sphincter pupillæ. Modified from Howell's physiology.

Fig. 61 will show clearly the mechanism with which we have to deal.

Two sets of muscles.—The dilator pupillæ and the sphincter pupillæ.

Two nervous systems.—The *sympathetic*, which supplies the *long ciliary* nerves to the dilators, and the *central*, which supplies the *short ciliary* nerves to the sphincter muscles.

Two general conditions, which effect this mechanism.—Stimulation and paralysis.

Stimulation.—The pupil dilates when the sympathetic system is stimulated. The pupil contracts when the central system is stimulated by light (afferent impulses travel by retinae and optic nerve; efferent by third cranial and short ciliary).

Paralysis.—When the sympathetic system is paralyzed, the pupil contracts by virtue of the tone of the sphincters, aided by the engorgement of the ciliary blood-vessels. When the central system is paralyzed, the pupil dilates by virtue of the elasticity of the elastic fibres of the pupil and by the emptying of the ciliary blood-vessels, which permit the lens to bulge forward.

The understanding of these simple mechanics will enable one to anticipate the signs which may be expected in the various stages of anæsthesia.

THE PUPILLARY SIGNS IN INDUCTION, MAINTENANCE AND RECOVERY

Induction.—During the periods of excitement and rigidity, the sympathetic system is everywhere stimulated, consequently the pupils at this time are usually dilated. The amount of this dilatation will depend upon the excitability of the sympathetic system at the time under consideration. If there is a greatly reduced irritability, as where morphine has been given before operation, this dilatation may be very brief and occasionally absent altogether. As the period of relaxation comes on, the sympathetic system will become paralyzed and the pupil will contract. The central system being intact, however, the reflex to light will remain.

Maintenance.—The exact condition of the pupil in the stage of *maintenance* will vary according to the degree to

which the sympathetic system is anæsthetized. If only partly, there will be moderate transient dilatation upon pain stimuli. If deeply, the pupil will be smaller than normal and show little or no reaction to sympathetic stimuli. Movements of the margin of the pupil, more or less rhythmical in character, may show themselves when pelvic or gall-bladder stimuli are applied. When the pupil is contracted, the reflex to light will vary with the irritability of the central nervous system or the level of *maintenance*. If the anæsthesia is now pushed, the pupil will dilate by virtue of the paralysis of the central nervous system. Since the light reflex depends upon the integrity of the same, this reflex will likewise be lost. The corneal reflex will have disappeared and other signs of complete anæsthesia will manifest themselves. However clear this condition may appear upon theoretical consideration, it is often rather puzzling, especially to the beginner, to determine whether a dilated pupil is a sympathetic dilatation of light anæsthesia or a paralysis of profound anæsthesia. The following test should always be made where doubt exists:

Stop the anæsthetic completely and give air. If, after a few moments, the pupil contracts (from shallowness of the anæsthesia), then the dilatation was that of profound anæsthesia or dilatation of paralysis. The eye in this case is usually dry and lusterless from an inhibited lacrimation.

If, on the other hand, the pupil remains unchanged in the face of shallower anæsthesia, the dilatation was caused by sympathetic stimulation and took place because the anæsthesia was incomplete. The eye in this case is usually moist, the lacrimation being abundant.

Occasionally one finds a patient who is morphinized, or who, for some unknown reason, loses his corneal reflex

early, having a persistently dilated pupil, which cannot be reconciled with other signs. In such a case it is always wiser to give the patient the benefit of the doubt and to permit him to drop to a lower level of *maintenance* or to "come out."

If moderate dilatation is present with an active light reflex, we may conclude that this dilatation is not the dilatation of paralysis, but that the patient is safe. The most satisfactory condition of the pupil during the stage of *maintenance* is when it is moderately contracted and responds to light.

Recovery.—During the stage of *recovery*, the condition of the pupil will again vary, depending upon the respective action of the various stimuli applied to the central or sympathetic system. As a rule the action of the latter is more pronounced, and consequently the pupil usually dilates. This is particularly true when the patient is about to vomit. Where morphine has been used and the recovery is entirely tranquil, the pupil may become pinpoint. The light reflex is present and becomes more and more active as the patient recovers.

In recapitulating we find that the eye signs are divided into the lid, the orbital and the pupillary signs. The presence of the conjunctivo-palpebral reflexes means a shallow anæsthesia, its absence a moderate height. The presence of the corneal reflex depends upon its activity. Its absence almost invariably indicates a complete anæsthesia. When the eyeballs move the patient is light. When they are fixed, either looking forward or downward, the patient has certainly lost consciousness, and is probably well anæsthetized. A dilated pupil with moist eyeball, which does not contract when the anæsthesia is withdrawn, with an

active corneal and light reflex, means shallow anæsthesia. A dilated pupil with a lusterless eyeball, with an absent light reflex and corneal reflex, which contracts when the anæsthetic is withdrawn, means profound anæsthesia, or a high level of *maintenance*. A contracted pupil with an active light reflex is a safe sign.

A contracted pupil without light reflex indicates morphinism and may suddenly be followed by a marked paralytic dilatation. The total absence of the light reflex independent of the size of the pupil implies interference with the central nervous system, usually a profound anæsthesia. By this we mean the reaction to a strong light, not the ordinary daylight.

From the foregoing it is therefore clear that one examines the orbit for motion, the pupil for size and for light, and lastly the cornea for lid activity.

V. THE PULSE SIGNS

The pulse is an index of the operative condition of the patient. One should note its rate, its rhythm and, most important, its volume. During the period of excitement and rigidity the pulse will be of little value as a sign. As relaxation becomes complete, however, and the stage of *maintenance* is begun, we should observe it carefully. When the radial artery is not accessible, as it seldom is, then we should locate the temporal on the side most convenient, palpating it with the pulp of the middle finger. If we palpate the *same* artery in the *same* location with the *same* finger throughout the anæsthesia, we will form concepts of small variations in quality, which would otherwise be passed over.

RHYTHM is normally constant. The skipping of beats,

when occurring frequently, is a danger signal and should be reported to the surgeon. This is more particularly true when the pulse has been regular during the early stages of the operation.

The *rate and volume* must be considered together. The pulse rate will often soar from pain stimuli or some deep reflex. Certain types of cases such as, for example, exophthalmic goitre, will have an exceedingly rapid pulse. If the volume is maintained there is not much ground for anxiety; if, however, the volume falls through hemorrhage or shock, the operator must be informed. Generally speaking, the surgeon should be notified when the patient consistently runs a pulse of 140 or over. If, in addition to an increase in rate, the pulse becomes small and rather difficult to palpate, preparation should be made for the administration of saline solution. This is the first and best treatment for such conditions. One of the easiest ways to give saline is to pour it directly into the abdominal cavity. The most direct and effective method, however, is to give an intravenous injection into the median basilic vein of either forearm (Fig. 62 and 63); the technic of this is as follows:

(a) Tie a tourniquet (bandage) about the arm above the elbow; (b) paint the bend of the elbow with iodine; (c) find the vein if possible. If it cannot be found, cut down to where it should be. When it is found, dissect it free for about an inch.

Tie a ligature below (distal) and place an untied ligature above (proximal); nick the vein with a scissors. See that the saline runs freely through the cannula and that the latter is free from bubbles. With the saline *flowing*, insert the cannula into the proximal end of the vein; tie in place with one knot. With the saline elevated about four

feet above the vein and the tourniquet about the arm *removed*, let the solution flow slowly. The amount given should vary with the needs of the patient: from 500 to 1500

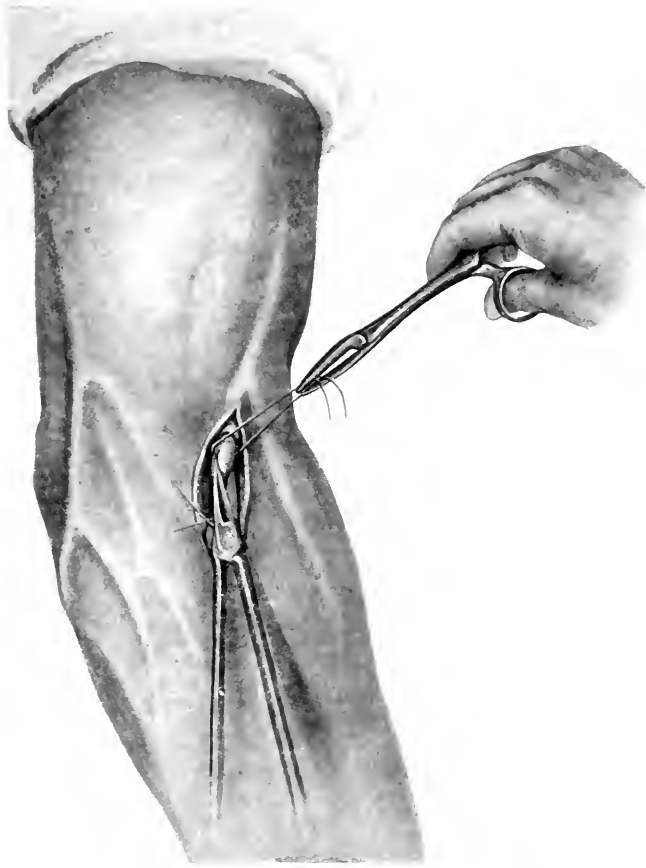

FIG. 62.—Intravenous administration of saline; nicking vein. (Annals of Surgery.)

cc. will usually be found sufficient. If too much fluid is admitted there will be increased pressure upon the right heart, which may suddenly dilate. The volume of the pulse should be watched, and when its character has improved



FIG. 63.—Intravenous administration of saline; cannula tied in proximal end of vein. (Annals of Surgery.)

sufficiently, the flow should be stopped. The cannula is withdrawn and the vein securely tied. The skin is then sewed with silk or linen and a sterile bandage applied. Needless to say this operation should be completed with despatch. If the pulse has become very small, rapid, or imperceptible before the saline is given, it is well to give immediately strychnine gr. $1/30$ or camphor in oil gr. 2.

While this treatment is taking place, the patient should be as lightly anæsthetized as possible. The indications here are to give enough anæsthetic, and only enough, to keep him quiet. Oxygen may be resorted to with advantage and rebreathing is beneficial. Cases which receive rebreathing with oxygen will be much better off than those who are held by the open drop method. The author has frequently carried pulseless patients for more than an hour rebreathing oxygen and just enough N_2O to control undesirable movement. The full retarded pulse following a saline is often misleading, as it is artificial and will soon lose its quality. It behooves one to get the patient to bed as soon as possible. If the operative procedure is such that the patient cannot be moved, and if the pulse loses its quality and once more becomes rapid, the saline may be repeated in the other arm. The condition of such a patient is desperate and his response to strychnine and camphor will be unsatisfactory.

Where it is inadvisable or impossible to give an intravenous injection, the fluid may be given by hypodermoclysis, under the loose tissues of the breast (Fig. 64), which method is very satisfactory. The Trendelenburg position will improve the pulse; the opposite will weaken it.

Sudden stoppage of the heart is fortunately rare with ether; such a condition not responding to artificial respiration may be handled by the method described by Abrams.

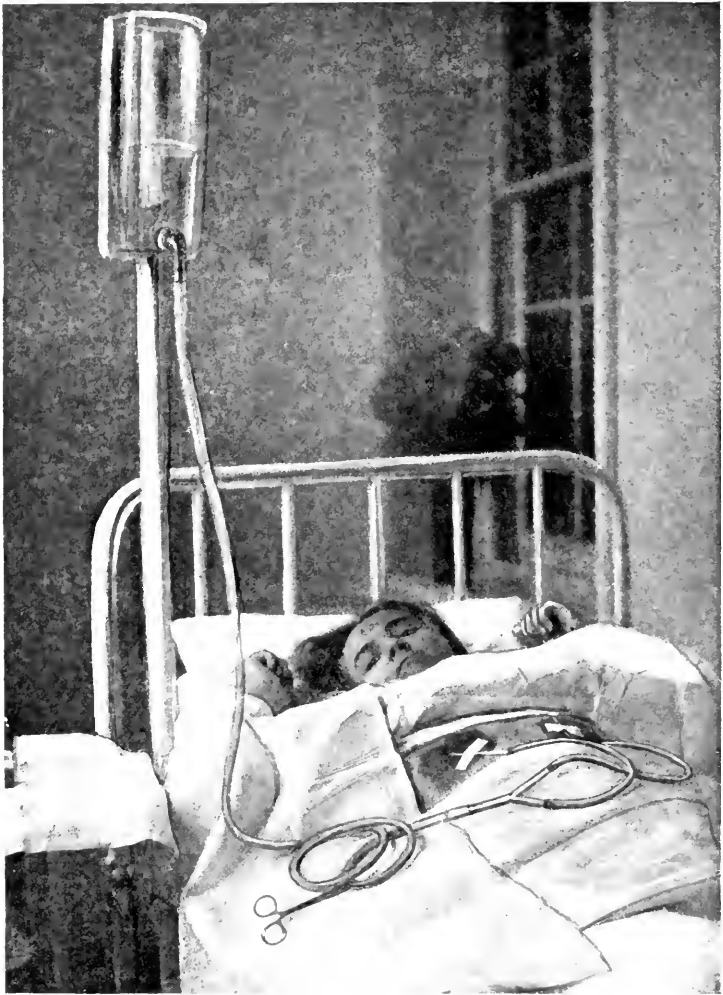

FIG. 64. -Hypodermoclysis.

This is called **Kuatzu** or the Japanese method of restoring life, and is a definite method of resuscitation used by jiu-jitsu adepts. The patient is placed in the prone position with arms extended sideways; the operator with his wrist lands severely on the seventh cervical vertebra with the regularity of a carpenter wielding a hammer. This stimulation is thought to act by overcoming the vagus inhibition responsible for the cessation of the heart's action.

The hypodermic injection of 1 100 gr. of atropine directly in the heart has been suggested and found valuable in some cases. Direct massage of the heart, when the abdomen is open, will also prove beneficial at times.

CHAPTER IV

ETHER ANÆSTHESIA

GENERAL CONSIDERATIONS

ETHER, sulphuric ether, ethyl oxide or vinous ether is a very volatile fluid possessed of a suffocating odor and a bitter taste. It is colorless, about two and one half times as heavy as air and boils at body temperature. Ether is very inflammable and should be cautiously employed in the presence of an open flame, red-hot cautery and the like. Ether vapor, when allowed to escape from a container, falls until it comes in contact with the floor, operating table or body of the patient. It then travels in a thin layer close to the surface with which it is in contact until it is dissipated in the air. A flame or hot cautery which is brought within two inches of such a surface will cause the ether to burst into flame. This may happen in the cauterization of hemorrhoids for example. The smoother the surface along which the ether travels the more likely it is to retain its concentration and ignite. Water has practically no effect on burning ether. If carelessly applied it may scatter the fire thereby increasing the danger. Ether-soaked gauze or free ether which has caught fire should be carefully and systematically smothered by the use of blankets, towels, etc., beginning at the patient's face.

Ether is commonly prepared as follows: Ethyl alcohol reacts with sulphuric acid to form ethyl sulphuric acid and water. In the presence of an excess of alcohol, ether is formed and sulphuric acid is reformed as a residue. This is known as the continuous etherification process. Ether,

which has been exposed to air and light, should not be used for anæsthesia, as the irritation of products formed by oxidation may prove injurious to the patient. Ether for anæsthesia is ordinarily sold in one-quarter pound and one-half pound sealed cans. The smaller-size cans are preferable because there is less likelihood of stale ether being carried over to the next case.

A brief consideration of the discovery of ether will be found in the Introduction. The various methods of administering ether have been taken up in Chapter IV. The signs of ether anæsthesia are discussed in Chapter III. A classification of the stages of ether anæsthesia has been suggested in Chapters I and II. The post-operative treatment of a case anæsthetized by ether will be found in Chapter XV, page 285.

I. ADMINISTRATION OF ETHER BY ORAL INSUFFLATION

By oral insufflation we mean the substitution of ether vapor for the atmosphere which the patient ordinarily breathes. (See page 9).

This ether vapor may be presented to the patient in a great variety of ways. Anything from a gauze handkerchief to an expensive nickel-plated apparatus will accomplish the desired result. While we may in an emergency get along with a handkerchief, we do not do so from choice, but from necessity, as such a method is least efficient and most wasteful.

We recognize two methods of administering ether by the method of *oral insufflation*:

1. The *liquid* method.
2. The *vapor* method.

By the *liquid* method we mean that method in which we present *liquid* ether to the patient upon a medium suitable for its speedy evaporation by the respiration. In this method we depend largely upon the patient to vaporize the ether.

By the *vapor* method we mean that method in which the ether is presented to the patient already vaporized. In this method the patient's respiration has nothing to do with the rate or the amount of the evaporation.

The *liquid* method is best exemplified by the well-known drop method. There are three distinct types of *drop method*: *Open*, *Semi-open* and *Closed*.

THE OPEN DROP METHOD

APPARATUS.—The essential elements of the apparatus are as follows:

(a) A wire skeleton face piece of substantial construction, having a smooth surface for contact with the patient's face; (b) covering for the face piece, consisting of stockinet bandage or gauze; (c) provision for the supply of ether in large, clean drops.

The Face Piece.—One of the most widely used and satisfactory drop masks is that of the Yankauer pattern (Fig. 65).

This fits the face well, presents a smooth surface in contact with the skin and is substantially built.

The Covering.—One of the best materials for an open drop evaporation surface is that afforded by stockinet bandage. The spring ring, which holds the covering, is slipped into a six-inch section of the bandage and forced down over the wire frame. Stockinet bandage, being more closely woven than gauze, gives a more satisfactory evap-

orating surface. When gauze is used, between ten and twelve thicknesses should be employed.

The Drop Bottle.—To obtain the best results one should have a device which will give large drops, the rapidity of which may be varied at will.

We speak of clean drops in contradistinction to the drizzle which one will obtain from a frayed bit of gauze. The anaesthesia resulting from such a drizzle or spray

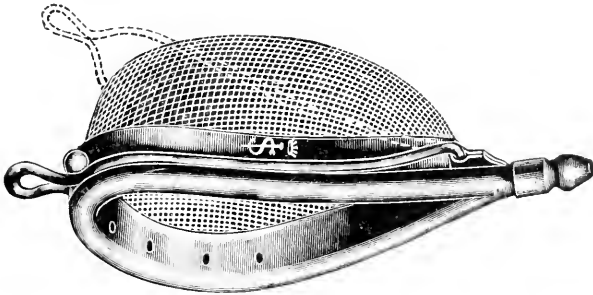

FIG. 65.—Yankauer-Gwathmey Drop and Vapor Mask.

method is not nearly as smooth as that obtainable by a clean drop. The best drop bottle is prepared as follows (Fig. 66):

Cut the lead cap neatly out of the ether can. Take the ether can cork and cut two deep grooves in the sides. In one of the grooves place a little wick of cotton (not gauze); leave the other groove free for the admission of air. Place the cork with the cotton wick in the can; allow the wick to become soaked with ether, which will drizzle off the frayed end. With a pair of scissors, cut the wet wick so that the end is square instead of frayed. A large, clean drop, whose rapidity is easily controlled, is then obtained. An emergency drop bottle may be provided by making a single pinhole in the centre of the lead cap in a can of ether, which

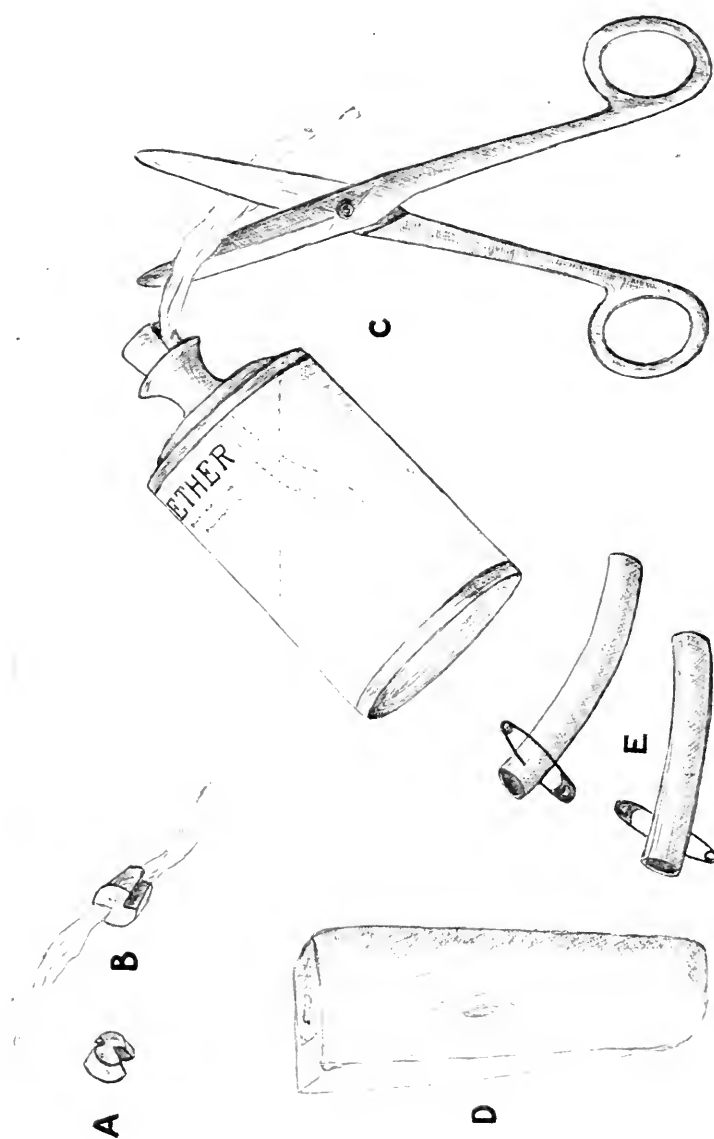

FIG. 66.—Making the ether bottle: A, cork with groove; B, cotton wick lying in the larger groove; C, cork with wick replaced in can, snuffing of fuzzy end to obtain a clean drop; D, boxwood wedge; E, rubber tubes for inspiratory obstruction.

has not been opened. If the can is now grasped in the palm of the hand, the rise in temperature resulting will cause the ether to spray out when the can is inverted. A drop may then be secured by controlling the spray with the finger tip.

THE ADMINISTRATION.—When the *open drop method* is employed, ether, as a rule, is the sole anæsthetic employed. One may sometimes render the induction more pleasant for the patient by dropping upon the mask a little essence of orange, wintergreen or some pungent essential oil, before the ether is given. This occasionally serves to mask the disagreeable odor. The trick of a smooth induction, however, consists in two things: First, in causing the patient to breathe somewhat more frequently and deeply than normal. Secondly, in the control of the drop so that there will be no spasm of the respiration. One of the best methods of controlling the respiration is to ask the patient to count slowly and loudly. This requires a certain attention and decidedly increases the tidal volume. In addition to this, the patient will give evidences of disturbed cerebration, which will indicate the progress of the induction. Most patients cannot count *slowly* and *loudly* for more than one hundred. We increase the drop as rapidly as we can and “let up” if the patient catches his breath. If this method is pursued, the patient will rapidly develop a tolerance, and by the time he has ceased to count he will be accepting without spasm an amount of ether which almost or entirely saturates the mask. When such an induction is brought about, the rule is—no excitement occurs, rigidity is slight and transient, and relaxation comes on slowly but completely. The respirations become stertorous, the lid reflex disappears, the jaw relaxes, the eye-

balls become fixed, the pupils contract and the corneal reflex becomes sluggish, indicating the onset of the stage of maintenance.

Maintenance is best controlled by a constant drop, which may be increased or diminished according to a demand for a high or low level of anæsthesia. If the anæsthetist becomes weary or loses interest during this stage, he will very likely change the drop into a spray or pour method. This will surely result in an uneven anæsthesia. The best results can only be had by employing a constant drop. As maintenance progresses, the color will fade, the patient will lose surface temperature and the respirations will become quite shallow from excessive ventilation. Since little ether is lost, little will be needed to hold a constant level of maintenance. In some cases relaxation will be difficult to secure; but in cases where it has become complete, it will have a tendency to persist. The eye signs will respond to an increase or decrease of the rapidity of the drop, but they are usually quite constant, fixed balls, contracted pupils, absent lid reflexes and sluggish corneal reflexes being the rule.

Since the anæsthesia is under nice control, the stage of recovery may be begun earlier. The patient is usually brought to the point of vomiting before leaving the table. The shallow respirations, however, tend to retard the return of the reflexes and the return of consciousness.

The advantages of the *open drop* method are as follows:

1. The simplest apparatus is required.
2. Perfect oxygenation is obtained.
3. It is fool proof.
4. Even anæsthesia, easily controlled in suitable cases.
5. The best method for inducing anæsthesia when ether alone is used.

6. The best method for maintaining anæsthesia in young children, when the vapor method is not available.

The disadvantages of the *open drop* method are as follows:

1. Certain subjects, as vigorous young people and alcoholics, cannot be controlled by this method.

2. It is extremely wasteful of ether.

3. The anæsthetist becomes literally soaked by the ether forced into the atmosphere by the exhalations.

4. The method is frequently attended by acapnia and shock, through the excessive loss of CO_2 . (See page 299.)

5. The patient easily loses bodily heat.

6. Induction is always prolonged and never as pleasant as when N_2O is used.

7. It is unsuitable where morphine has been used as a preliminary medication.

THE SEMI-OPEN DROP METHOD

The semi-open drop method is nothing more than the open method so modified that the communication with the outside air is restricted and a certain amount of rebreathing thereby induced.

When this method is employed, the drop method, strictly speaking, is not used as consistently as in the open method. The necessity for concentrated ether which this method usually implies calls for a spray or pour method. The open drop method can easily be modified into the semi-open method by the use of towels or a rubber dam.

By the open drop method and the semi-open drop method, one is in a position to handle every case suitable for oral insufflation. Any patient from a baby to a two-hundred-pound alcoholic may be controlled by the use of

these two methods. This does not mean that one can thus obtain the best results, but that in an emergency we can anæsthetize any patient who will respond to ether anæsthesia, if we are given time enough and sufficient ether.

APPARATUS.—1. The open drop mask covered with at least twelve layers of gauze.

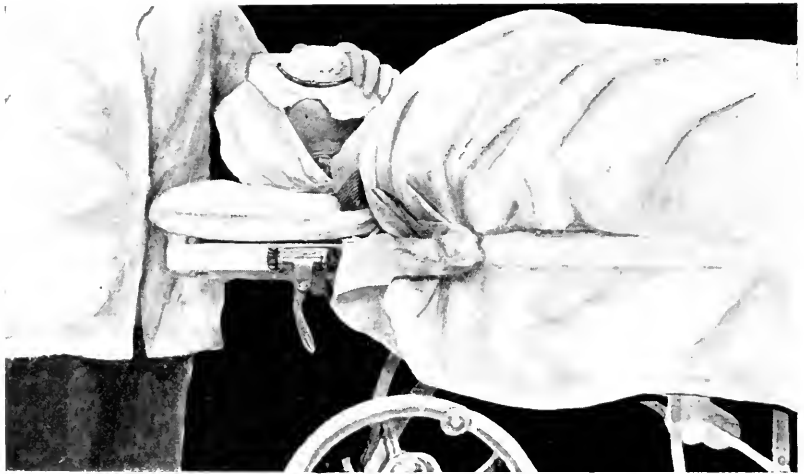

FIG. 67.—Ether by the semi-open drop method. First position. First towel in place over the eyes.

2. Three small towels or a piece of rubber dam 6 inches by 12 inches with a 1-inch hole in the centre.

3. A bottle which will permit of a spray or a small stream of ether.

THE ANÆSTHESIA.—A folded towel is placed over the eyes (Fig. 67). Anæsthesia is induced precisely as with the open drop method. When the patient has lost consciousness, as will be shown by his inability to count intelligently, the second towel folded lengthwise is placed over the upper third of the mask (Fig. 68), the ends being



FIG. 68.—Ether by the semi-open drop method. Second position. Second towel in place covering upper third of mask.



FIG. 69.—Ether by the semi-open drop method. Third position. Third towel in place covering lower third of mask.

tucked neatly under the occiput. The drop is now increased in frequency and held just below the point of spasm of the respiration. The third towel folded lengthwise is now stretched over the lower third of mask, one end is tucked under the head, the other is left free (Fig. 69).

We now have two-thirds of the mask covered by toweling, the middle third is exposed and receives the ether dropped upon the mask. With this semi-open method



FIG. 70.—Ether by the semi-open drop method. Fourth position. The free end of the third towel is being laid over the exposed third of the mask.

almost every case can be subdued. When a particularly obstreperous case refuses to become relaxed the mask is covered with ether and the free end of the third towel is thrown over the exposed portion of the mask. In this manner outside air is practically excluded and the most refractory patient will become anæsthetized (Fig. 70).

This towel method will be found very convenient and effective, as the mask is thereby held in place, leaving both hands of the anæsthetist free.

A somewhat more simple procedure, but one requiring an additional accessory, consists of covering the open drop mask with a sheet of rubber dam, having a hole in the centre through which ether is dropped. This method effectively restricts the admission of air, but is somewhat more cumbersome in manipulation (Fig. 71).

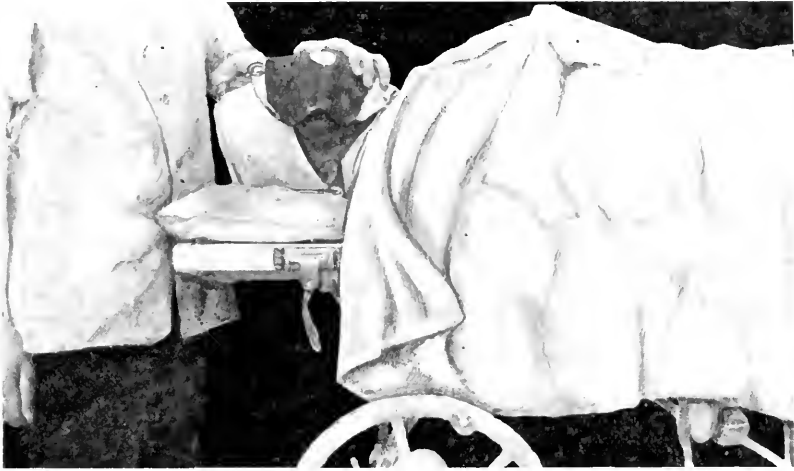

FIG. 71.—Ether by the semi-open drop method. A piece of rubber dam with a one-inch hole being used in place of towels.

The advantages of the semi-open method over the open method in the late stages of induction and in maintenance are:

1. Vigorous subjects may be anæsthetized.
2. Less waste of ether.
3. Less ether in the air of the operating room.
4. Less likelihood of acapnia.
5. Less loss of body heat.
6. Induction is more expeditious.
7. Because of rebreathing, this method may be used with more safety where preliminary morphine and atropine have been given.

The disadvantages, as compared with the open method, are as follows:

1. Oxygenation not so good.
2. Control not so delicate.
3. Not entirely fool proof.
4. Not so good for early induction.
5. Not suitable for little children who are to be carried in maintenance for some time.

THE CLOSED DROP METHOD

For all patients with the exception of very young children, seven years or under, the closed drop method is by far the best (all round) method of oral insufflation. When this method is employed with nitrous oxide followed by ether, it is not only most efficient from the anæsthetist's point of view, but it is also by far the pleasantest mode of anæsthesia for the patient.

This method is separate and distinct from both the open and semi-open method. A suitable apparatus must be employed, if one wishes to secure the best results. The apparatus which may be had for the closed method of etherization is varied. Our task is to suggest features of value which should govern our selection.

1. It must be possible, at the will of the operator, to absolutely exclude atmospheric air; otherwise nitrous oxide cannot be satisfactorily used for induction.

2. It should be light in weight and rest comfortably on the face.

3. It must be possible to clean and sterilize the apparatus. Small inaccessible parts, and therefore difficult to clean, are to be discouraged.

4. The rebreathing must be unobstructed.

5. There should be some device whereby ether may be automatically given in small, frequent doses, in such a manner as to simulate the drop method.

6. It should be possible to easily and frequently change the gauze or crinoline, placed in the apparatus for the purpose of assisting in the evaporation of the ether.

7. It is a great convenience to have some arrangement, whereby atmospheric air may be freely given the patient without removing the inhaler from the face.

8. It will be found that a transparent face piece, such as is offered by celluloid, will be exceedingly valuable in watching the vomiting, position of the throat tube and the color of the lips.

When one wishes to employ N_2O and O for induction and the latter part of maintenance and recovery, the inlet for these gases should be situated at some point in the apparatus between the bag and the face piece, not, as is the usual custom, by means of a stopcock at the base of the bag. By the admission of N_2O and O in this way, we may have immediate results; we need not wait for the bag to be emptied. There should also be provided a valve, which will allow the escape of expirations, but which will prevent the admission of air during inspiration.

The author has succeeded in embodying most of the foregoing principles in a device, shown in Fig. 72. Any contrivance which exhibits the same principles will give equally good results. The above-mentioned apparatus is a modification of a standard face piece, the detailed construction of which is unimportant since other face pieces might be substituted with equally good results.

The following features of this apparatus are worthy of notice:

1. A device for giving ether by the closed drop method.

This consists of an ordinary oil cup with a sight feed. The cup is filled with ether as required, and the drop is regulated by a screw at the top. This cup forms a part of a section which may be easily slipped on and off the face piece section.

2. A tube for the admission of the gases N_2O and O , located between the bag and the face piece. This is also part of the above-mentioned section.

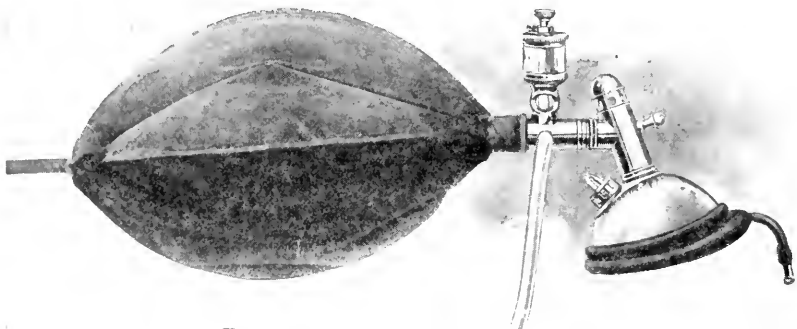

FIG. 72.—The author's apparatus for the administration of ether by the Closed Drop Method and for Gas Oxygen Ether Anæsthesia.

3. An expiratory valve for use when N_2O and O are used.

4. The entire apparatus weighs only two-thirds as much as the well-known Bennett.

5. The face piece is comfortable and transparent.

6. Atmospheric air may be readily and freely admitted through the air valve without removing the face piece.

7. The use of a roll of fine wire gauze, 100 to the inch, for an evaporating surface (Fig. 73).

The last feature named is of the utmost importance,

as will be seen in the following consideration: The wire gauze in strips 2 inches by 15 inches is rolled up like a jelly roll. This roll is placed in the ether cup section so that the ether, which drops into the apparatus, will become entangled in its meshes. There is practically no obstruction to the respiration, which passes freely through this wire tube. The evaporating surface is large, and the material does not collapse when wet with ether.

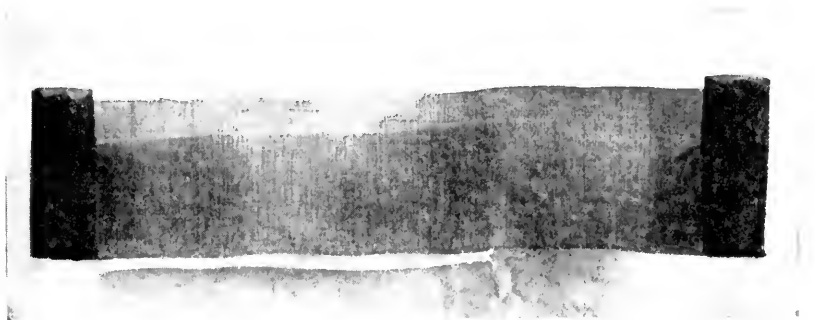

FIG. 73.—Wire gauze roll; size, 100 to the inch.

ADMINISTRATION.—When the closed drop method is employed.

Induction.—With the air vent open, the wire gauze in place, and the ether in the cup, the bag is filled with gas. The face piece is then adjusted and the patient is permitted to breathe the air. After a few moments, the air vent is closed and the patient breathes nitrous oxide to and fro. At the end of about forty seconds, or when the respirations become involuntary, as is shown by their increased depth and rapidity, ether is very cautiously added drop by drop. The frequency of the drop is increased as rapidly as possible without causing spasm of the respiration. The rubber tube which admitted the N_2O may now be detached. The air

which may enter through this tube will not be found objectionable. By opening the air vent during inspiration and closing it during expiration, we may oxygenate the patient and dilute the percentage of the ether in the bag. Stertor usually appears when we have vaporized about half an ounce of ether.

Consciousness is lost easily and pleasantly. The period of excitement is reduced to a minimum. Spasm of the respiration sometimes occurs, but muscular movements are rare. The respiration, unobstructed by tightly packed gauze, is usually full and deep; the color responds quickly to oxygenation by the atmospheric air. When it does not so respond, oxygen may rapidly be admitted through the tube designed for this purpose. The color of the lips may readily be seen through the transparent face piece.

The lid reflex disappears and the masseters become relaxed. The eyeballs soon become fixed and the pupils somewhat contracted. The light reflex, however, remains active and the corneal reflex sluggish. In this condition the patient enters the stage of maintenance.

Before describing the stage of maintenance, we may say that the induction of anæsthesia by the closed drop method will give as good results, and occasionally better results, than the pour methods usually employed with other apparatus. It is in the stage of maintenance, however, that this method becomes most useful.

Maintenance.—If the breathing is not perfectly satisfactory, we will do well to introduce a throat tube. (Fig. 14.) This will guard against oral obstruction during the subsequent anæsthetization. The operative procedure having been commenced without disturbing the patient, we may set the drop at a rate which seems most fit, in view of the

character of the induction. If the latter has been stormy and delayed, we will be obliged to exercise more control over the early stages of maintenance. At frequent intervals, depending upon the patient's color and the depth of the respiration, we fill the bag partially or completely with fresh air. If the inlet tube for the gas be open all the while, permitting the gradual escape of the contents of the bag, it will be found unnecessary to completely empty the bag, except when the respirations become unusually deep or the patient perspires freely. The simple adding of atmospheric air through the air valve will be all that is required to keep an even and tranquil anæsthesia. If the patient requires much ether, it is advisable to add air more frequently in addition to increasing the speed of the drop. This closed drop method approaches the ideal which is offered by the percentage method. With a free respiration, as is provided by the throat tube, a non-obstructing but efficient evaporating surface and a visible automatic drop, we have the patient under a delicate and even control. As one becomes familiar with the signs of anæsthesia, he can carry a low level, changing rapidly to a higher, as required by special manipulations. From a rather extensive and recent personal experience with this method, in experienced as well as in inexperienced hands, the author is satisfied that it is the *best* method where a variable but absolutely controllable level of maintenance is desired.

Recovery.—We know of no method of anæsthetization which will permit the anæsthetist to begin the stage of recovery as soon as will the closed drop method. The anæsthesia being under perfect control, one may, for example, in an abdominal section, stop the drop as soon as the peritoneum is closed. While the patient rebreathes his own

expirations to and fro in the bag, he tends to lower the tension or percentage of ether present in his circulation. We may easily further decrease the strength of this ether by reducing the rebreathing and adding atmospheric air. Confidence born of control will allow one to attempt lightness, which, under other circumstances, would court failure. If the anæsthetist is watchful, he can always recover the reflexes before the patient leaves the table.

As the rebreathing induces respirations of large tidal volume, the ether in the circulation is rapidly thrown off and the second period of recovery or the return of consciousness is soon completed.

The medical profession and the general public owe a debt of gratitude to Dr. Thomas Bennett of New York City for introducing gas ether anæsthesia in this country. We believe that the success of his apparatus lay in the fact that it was one of the earliest in which the gas ether sequence was used, and furthermore that the method employed was a closed one. The device became known by its constant use by Dr. Bennett and later gave its author wide publicity. As this device is found in a large number of hospitals, it deserves more than a passing glance. While cumbersome and costly, it will yet give splendid results in experienced hands. (Figs. 74, 75.) It is arranged for a nitrous oxide ether sequence. The ether is given by pouring it upon the gauze, packed in the ether chamber through small holes in the sides of the same. Before starting, the ether chamber should be closely packed with gauze (it must be remembered that the patient does not breathe through this gauze, but *around* it) in the space between the cage and the air-tight wall of the ether chamber. The gauze in the ether chamber is then well moistened with ether, about

half an ounce being poured in. The indicator is turned to "air." The gas bag is filled and the face piece is applied. The patient is made to rebreathe N_2O . When the respirations become deep and more rapid than normal, the ether is cautiously turned on. If there is no respiratory spasm, it is gradually increased. When full ether is reached, the gas bag is replaced by the rebreathing bag. A small amount of ether is poured into the ether chamber, through each of the three holes. Relaxation comes on quickly and



FIGS. 74.—Bennett apparatus, with gas attachment and bag for induction.

FIG. 75.—Bennett apparatus with ether rebreathing bag for maintenance.

the stage of maintenance is soon reached. When properly managed, the stage of induction is all that can be desired.

During the stage of maintenance, however, we are likely to feel that improper provision has been made for:

(a) The changing of the gauze, which has become water soaked by the condensed respiratory moisture; (b) the giving of small, constant doses of ether; (c) unobstructed rebreathing.

Furthermore, we cannot see the patient's mouth

through the opaque, metal mask and, after an hour or more, the weight of the apparatus becomes troublesome.

Unless one is very expert, the patient will not be under proper control. The wet gauze will not hold the ether poured upon it, allowing the latter to run down into the face piece. With care and good judgment these disadvantages are not so marked. They will be found especially noticeable, however, with the beginner, who has not developed the skill necessary for their proper avoidance.

The stage of recovery cannot be started as early as one would wish for the reason that the control is not sufficiently delicate. The return of consciousness is delayed, since it has been necessary to carry a high level of maintenance; a low level being dangerous, as spasm supervenes where ether is added too freely.

We have taken the liberty of selecting the Bennett apparatus as a popular and widely used exemplification of a type, which does not offer the most satisfactory means of inducing and maintaining anaesthesia, especially from the point of view of the beginner. Long usage, mixed with interest and intelligence, as has been before mentioned, often overcomes these shortcomings.

The device which the author employs is also one showing forth a type, the detailed construction of which is incidental and which may easily be improved upon.

THE DISADVANTAGES OF THE CLOSED DROP METHOD AS COMPARED WITH THE OPEN AND SEMI-OPEN DROP METHOD

1. The apparatus is more cumbersome and expensive.
2. It cannot be used when the tidal volume is unusually small, as in babies and very young children.
3. It is not fool-proof.

THE ADVANTAGES OF THE CLOSED DROP METHOD AS COMPARED WITH THE OPEN AND SEMI-OPEN DROP METHOD

1. It may be used with more efficiency in a larger range of cases.

2. The ability to use N_2O gives a *speedier and pleasanter* induction.

3. It is most economical in the use of ether.

4. The body heat is preserved.

5. The rebreathing prevents acapnia.

6. Preliminary morphine medication may be used with greater safety.

7. The control of the patient is more delicate and effective.

8. The stage of recovery may be begun earlier.

9. During the stage of induction and maintenance, oxygen may be given in the most effective manner, namely, mixed with CO_2 .

10. During the stage of recovery N_2O and O may be used and much of the ether may thus be thrown off.

11. The operating room is almost free from the odor of ether.

12. The anæsthetist may give ether all day and at the close have absorbed little or no ether himself.

OBSERVATIONS ON THE USE OF THE OPEN AND SEMI-OPEN DROP METHODS IN LARGE CLINICS, WITH SPECIAL REFERENCE TO THE MEANS EMPLOYED TO OVERCOME THE OBJECTIONABLE FEATURES OF THESE METHODS

In observing the anæsthesia at various clinics, we are forced to the conclusion that differences of opinion exist in regard to the definition of "A good anæsthesia." We are under the impression that a good anæsthesia implies: A rapid and pleasant loss of consciousness, a short period

of excitement, a relaxation, which comes on quickly and which is well under way before the operation is commenced, a stage of maintenance under the complete and ready control of the anæsthetist and a knowledge, on the part of the anæsthetist, of the exact depth of the anæsthesia at any given time. To our surprise, we often find a satisfactory anæsthesia summarized in: A delayed and distressing loss of consciousness; a period of excitement often prolonged and followed by rigidity extending well into the course of the operation, which is habitually begun so early that there is almost invariably a reflex rigidity as a consequence; an uneven stage of maintenance, not under good control and *leading* rather than *being led* by the anæsthetist. The keynote of a good anæsthesia appearing to be, to give as little ether as possible regardless of the convenience of the surgeon, who must adapt himself to this essential.

There is no doubt that such a method of anæsthesia is seldom exposed to the danger of overdosage, or of vagus inhibition, because fortunately the anæsthetic is not chloroform but ether. Ether may be given in this fashion with comparative safety by a lay person, who need pay little attention to the signs of anæsthesia, the essential indication being to increase the amount of ether administered when the patient coughs or moves, and to reduce the amount or stop the ether if the patient is quiet.

The *delay* in the induction of anæsthesia by this method of open and semi-open drop ether is overshadowed by one or all of five reasons:

1. The fact that operations are going on in more than one operating room at the same time, and visitors are not obliged to wait for the next patient but may be otherwise entertained.

2. The patient is anesthetized *on the operating table in the operating room*, and the delay incidental to transportation after anesthesia is induced is obviated.

3. If the operative position is a difficult one to obtain, *i.e.*, for kidney work, the patient is placed in this position before the anesthesia is induced.

4. The preparation of the field of operation takes place as soon as the patient is on the table, usually before consciousness is lost.

5. Lastly, and of great practical importance, the patient is thoroughly restrained by strapping. This obviates the danger of his lifting his hand in a subconscious effort to protect himself when the first incision is made, as would certainly occur in many of these cases where the operation is begun during the early periods of induction.

This control makes possible a method which otherwise could not be tolerated.

The *rigidity* incidental to incomplete anesthesia is largely overcome by the employment of large incisions and the use of self-retaining retractors.

In discussing this method of anesthesia, we try to separate it from the fame which it sometimes borrows from its environment and to consider it *per se*, as it would actually appear if shorn of its surgical support and transplanted to a locality where it would be obliged to stand upon its own merits; for this is the condition obtaining with those who adopt this method. Possibly under some conditions no better method can be found.

The Administration.—Patients who are able to walk are sometimes assembled in a small waiting room a short distance from the operating rooms. When the operating room is dressed, they walk in, disrobe and lie upon the

table. A strap is then thrown over the knees and bands of webbing, sometimes two, sometimes four, hold the arms to side.

The nurse speaks a few words to the patient and, after covering the eyes with gauze, begins the administration of ether by the drop method. The mask, at first some distance from the face, is gradually lowered as anæsthesia progresses. Consciousness persists for from three to four minutes. Since the respirations are shallow, the induction is delayed so that at the end of ten minutes marked rigidity is often still present and reflexes to pain persist. The open drop mask is sometimes converted into a semi-open mask by winding a strip of gauze about it, something after the fashion of a bandanna handkerchief. The preparation of the field of operation begins before consciousness is lost and is usually concluded before the induction is well under way. When the preparation is complete, the incision is frequently made, often with little respect for the signs of anæsthesia. If the patient resists, the operator is constrained to wait. If the resistance is slight it is usually overlooked. Since the patient is well restrained the danger of his hand finding its way to the wound is slight. The pain of the first incision usually stimulates the respiration so that a certain amount of ether is eventually absorbed.

During the stage of maintenance, the chief symptoms observed are presence or absence of straining or movement, coughing or retching. Little effort is made to anticipate these signs and their occasional appearance is usually overlooked.

The incomplete relaxation which obtains, prevents obstruction of the airway by the falling back of the tongue,

but on the other hand permits masseteric spasm by reflex irritation.

The stage of recovery is what might be expected from the use of this method, the advantages and disadvantages of which have been taken up in a preceding section, page 127.

It may not be unfair to assume then that the open or semi-open drop method is the routine method of choice in some clinics:

1. Because it is so safe as to permit its administration by lay people.

2. Because it is the belief of the authorities that the use of small amounts of ether is more important than the obtaining of complete relaxation.

3. Because such a method involves apparatus of the simplest possible type.

4. Because provision may be made for the delayed induction incidental to drop ether by placing the patient in the operative position on the operating table, in which position he is restrained and the anæsthetic started. The field of operation being prepared at once and little heed being paid by the audience, who are entertained in neighboring rooms.

5. Because provision may be made for imperfect relaxation by employing large incisions and self-retaining retractors.

THE VAPOR METHOD OF ORAL INSUFFLATION

In the *vapor method of oral insufflation*, we offer ether to the patient in vapor form. The respiration has nothing to do with the production of this vapor, which is brought about by mechanical means.

It is not our object to catalogue the various apparatus

at our disposal but to reduce the method to its simplest terms. We will attempt to describe the most simple form of vapor anæsthesia, a method which has given continued satisfaction in the hands of many operators.

APPARATUS.—

1. Cautery bellows or tank of oxygen.
2. A suitable bottle for vaporizing the ether.
3. A suitable mask, through which the patient receives the vapor delivered.

1. The bellows and the oxygen tank need no explanation.

2. The wash bottle attached to the operating room oxygen tank will make a perfectly satisfactory vaporizing bottle. This is usually an eight-ounce bottle with a large neck, into which fits a rubber cork perforated with two holes. Through one of these holes passes a tube long enough to pass below the surface of the ether. Through the other a small tube, which reaches just below the cork. The cautery bellows or tubing from the oxygen tank is attached *to the long tube*, so that when air or oxygen is introduced, it will bubble through the ether. The short tube, for the exit of the vapor, is connected with tubing which leads to the face piece (Fig. 76).

3. The ordinary semi-open drop mask may be employed by passing the tube, which delivers the vapor, beneath this. When purchasing a drop mask, however, the best plan is to buy one designed for use with vapor, as shown in Figs. 65 and 77. This mask will therefore serve the double purpose of drop and vapor mask.

The *vapor method of oral insufflation is especially* adapted to babies and very young children. We know of no method which is subject to as delicate a control. The

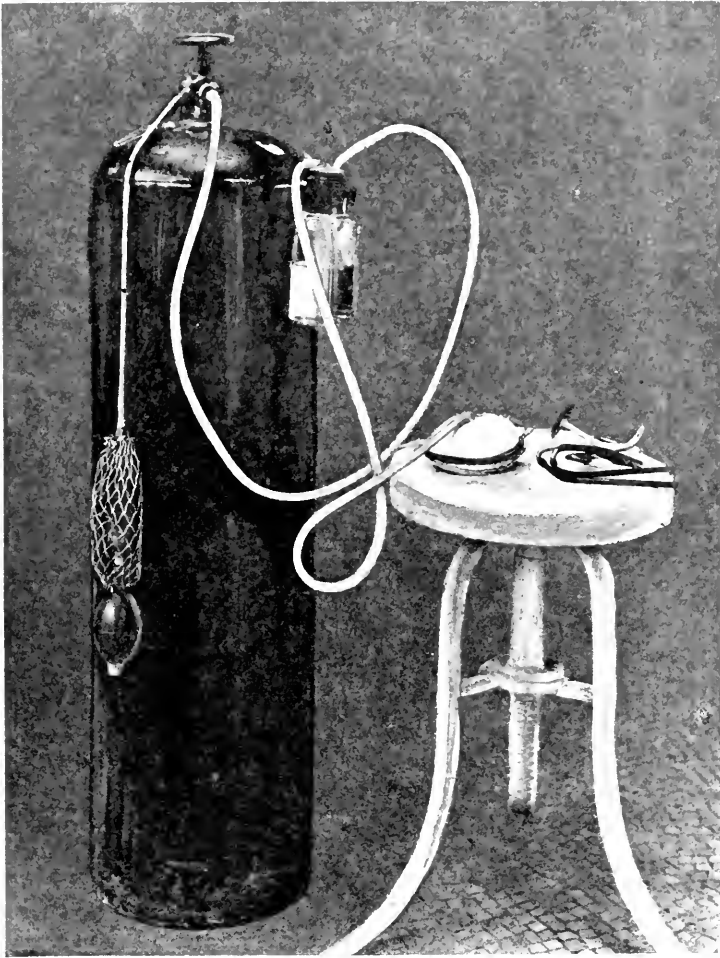

FIG. 76.—Apparatus for the vapor method of oral insufflation and for intrapharyngeal insufflation where concentrated vapor of small volume is employed. Showing oxygen tank, cautory bellows, wash bottle in which ether is placed, Lumbard vapor mask, throat tube and nasal tubes.

tidal volume of a baby's respiration is often so small that it will not properly vaporize ether dropped upon the mask. No argument is necessary to emphasize the value of the vapor method in these cases. A device for heating the

ether container is unnecessary, as the evaporation is comparatively slow. In those unusual cases where heat is desired, the most simple method of applying this is to set the ether bottle in a dish of hot water; any dish will do. We are never without hot water where an operation is to be performed, while electrical conveniences are frequently absent. The addition of heat increases the concentration of the ether vapor from 60 per cent. or less to almost 100 per cent. See page 70.

It will be found that the use of oxygen, instead of atmospheric air by the bellows, is not only more efficient

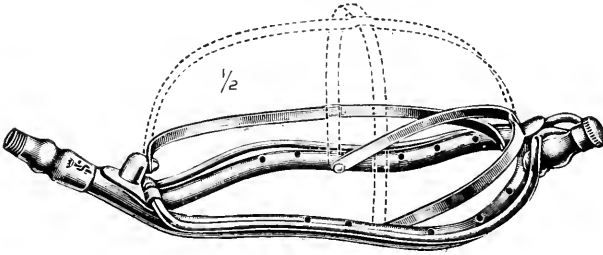

FIG. 77.—Vapor mask.

because it provides thorough oxygenation, but, being automatic, it is much easier of administration and can readily be controlled. The expense is of small consequence, as the ether necessary to control an adult in this manner will be vaporized by less than twenty gallons of O per hour, representing an expense of less than one dollar. An infant requires much less.

THE ADMINISTRATION.—The administration is exceedingly simple, our chief care being to give the vapor gradually and to watch carefully for signs of deep anæsthesia, as exhibited by a rapid respiration and a fixed, dilated pupil. In very young children, our chief care should be

to keep the small patient quiet with as little anæsthesia as possible.

For any type of operation in babies and small children, where the oral method of insufflation will suffice, we believe that this vapor method will give the best results.

II. INTRAPHARYNGEAL INSUFFLATION

In *intraparyngeal insufflation*, instead of presenting ether to the patient in the external atmosphere, which he breathes, we go a step further and place the ether vapor in the posterior pharynx. It is unnecessary to state that the ether must be previously vaporized. It cannot be given, as with oral insufflation, in both the liquid and the vapor form.

There are *two* distinct methods of giving ether by the intrapharyngeal insufflation:

(a) In the first, we supply to the patient a mixture of ether and air of sufficient volume to meet all his respiratory needs. This volume ranges from twelve to eighteen liters a minute. We not only do not depend upon the addition of atmospheric air, but we exclude it by giving the vapor under a pressure ranging from 20 to 40 mm. of mercury.

(b) In the second case, we give the patient a *small* volume of very concentrated ether and depend upon the mixture of atmospheric air to both dilute this and supply the total volume necessary.

The *first method* is of course the ideal, since it enables us to completely control the percentage of the ether inhaled. Knowing the limits of depth and lightness in terms of vapor tension to be about 180 mm. to 50 mm. (see page 64 *et seq.*) our control of the patient well-nigh approaches perfection.

This type of intrapharyngeal insufflation is best exemplified by the apparatus known as the anæsthetometer, designed by Dr. K. Connell (Fig. 78).

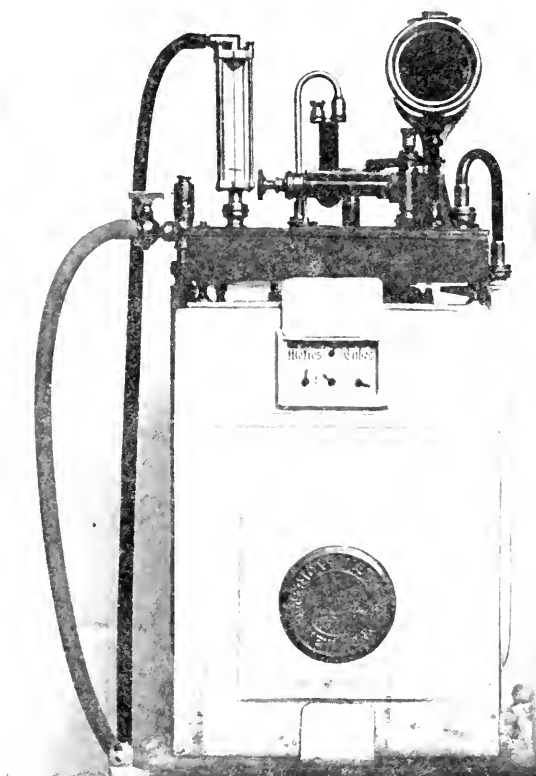

FIG. 78.—Anæsthetometer. Designed by Dr. K. Connell.

APPARATUS FOR INTRAPHARYNGEAL INSUFFLATION.—

There are three divisions:

1. The air supply.
 2. The mixing chamber.
 3. The section for delivery to the patient.
1. The air supply may be procured by foot power,

steam or electricity. There may or may not be a reservoir for the air before entrance to the mixing chamber

Foot power will be found satisfactory where the bellows, shown in Fig. 79, is employed. Steam power is the type used at Roosevelt Hospital, New York City. The plant is somewhat costly and cumbersome for any but a large

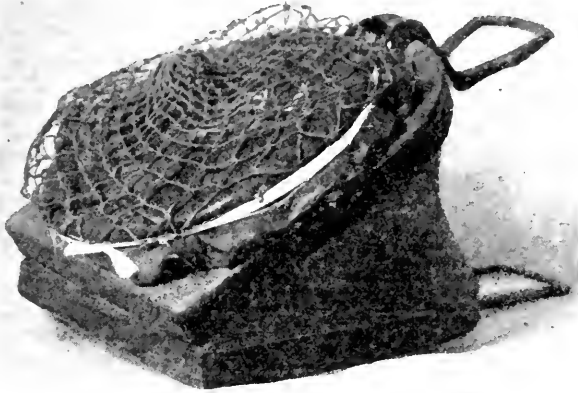

FIG. 79.—Foot bellows.

institution (Figs. 80 and 81). Electrical power (Fig. 82) is quite satisfactory.

2. The mixing chamber. The Anæsthetometer.

3. The section to the patient consists of a rubber tubing to which is attached a so-called nasal tube. (Figs. 83 and 84.)

The nasal tube is constructed of nickel-plated brass of a shape corresponding to the patient's face. It ends in two nipple-like projections which are bent so as to enter the nostrils and prevent angulation of the catheters which are attached thereto. The catheters usually employed are No. 18 French, velvet-eyed. Special catheters have been designed having open ends resembling a small rectal tube in

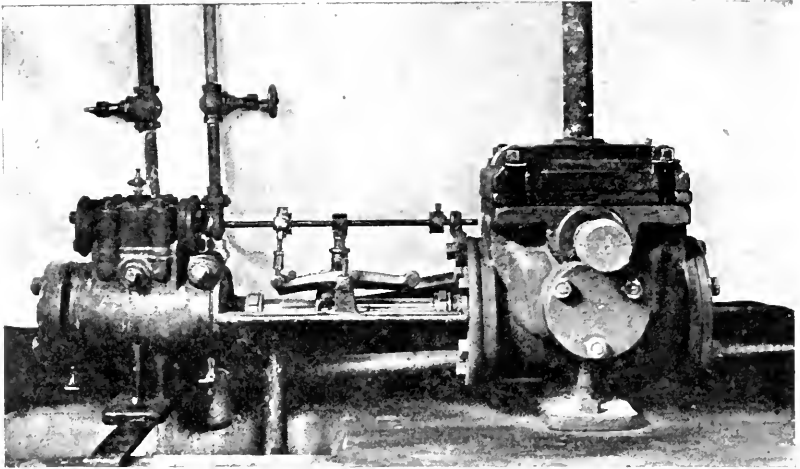

FIG. 80.—Steam pump for air supply at Roosevelt Hospital. (Courtesy Dr. K. Connell.)

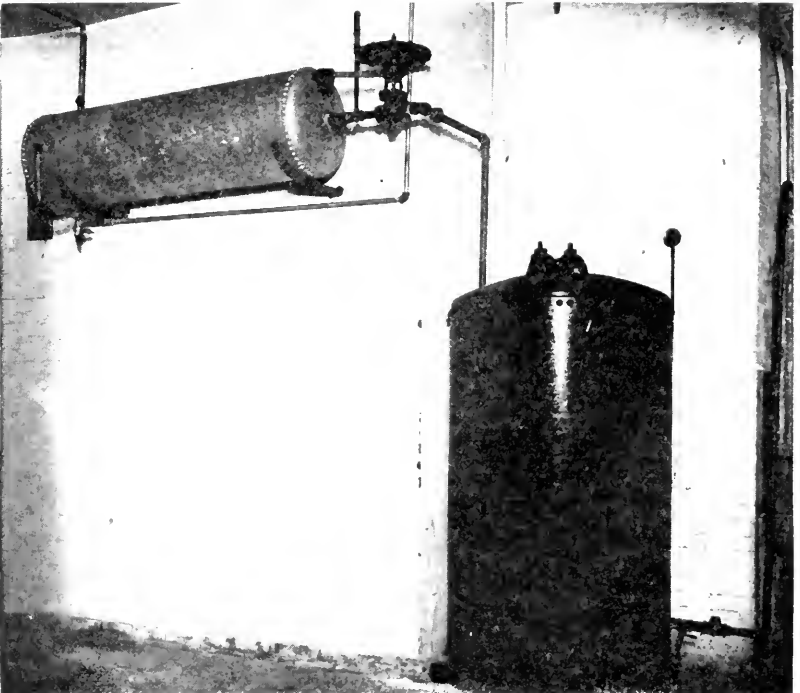

FIG. 81.—Large reservoir tank and wash tank into which air from steam pump is delivered before being piped to the operating rooms. (Courtesy Dr. K. Connell.)

construction. These, while efficient, are not entirely necessary. The length of the catheter to be used is equal to the distance between the alæ of the nose and the auditory meatus. This distance carries the tube well into the pos-

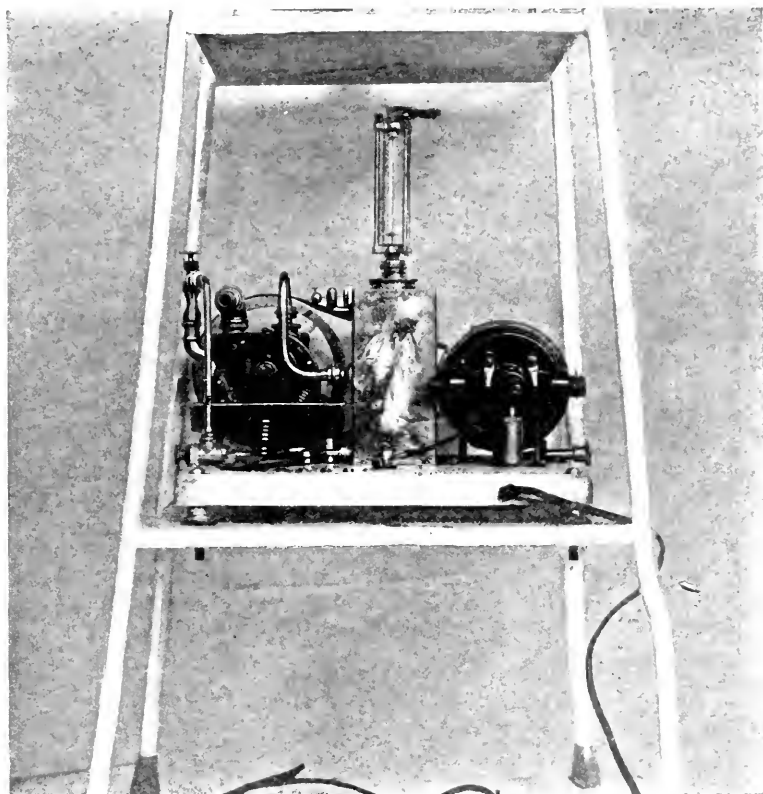

FIG. 82.—Electrical unit (Connell).

terior pharynx. If the tube is made *too long* it will enter the œsophagus and dilate the stomach. It must be *properly lubricated* or a nose bleed will result.

THE ADMINISTRATION.—The induction is usually

brought about by the employment of a semi-open or closed drop method. When the patient has entered the stage of maintenance, the vapor apparatus is started, the indicator being placed at 60 or 70 mm. The catheters, *well moistened with the patient's saliva*, are slipped gently into each of the nostrils. If one is occluded, both catheters may be

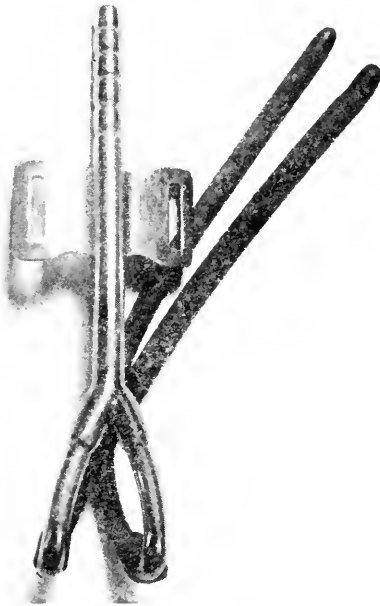

FIG. 83.—Nasal tubes.

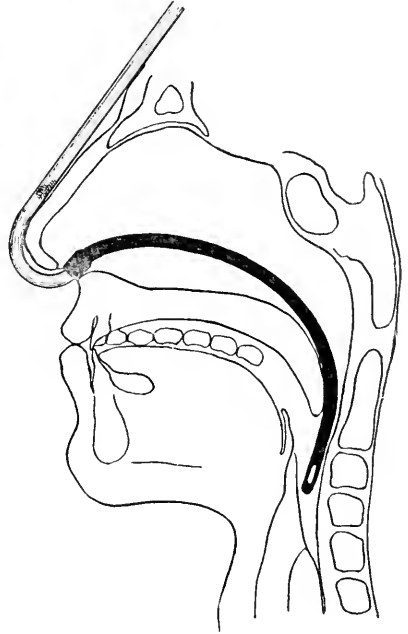

FIG. 84.—Nasal tube in place.

placed in one nostril. In accomplishing this, one should elevate the tip of the nose and keep the catheters close to the floor of the nares. The operation is completed by placing an adhesive strip over the nasal tube. Fig. 85 shows insertion of the catheters.

Fig. 86 shows catheters in position.

The anæsthesia may now be continued with the head



FIG. 85.—Intrapharyngeal anaesthesia, showing the insertion of the nasal tubes. The catheters are moistened with the patient's saliva. The nose is tilted backward and the tubes are passed along the floor of the nose downward and backward.



FIG. 86.—Intrapharyngeal anaesthesia. Nasal tubes in place and strapped to the patient's forehead by adhesive plaster.

covered by towels and the anæsthetist at some distance from the patient. One gradually reduces the percentages beginning at the end of half an hour, until 40 or 50 mm. is reached, at which point the patient may be carried for hours.

As has been before stated this type of anæsthesia is constant and does not attempt to vary its level according to the manipulations of the surgeon.

The anæsthetist must be continually alive to the patient and the apparatus, however, for trouble may arise in either or both. This trouble will be more difficult to detect and must be met more promptly than where a more simple method is employed.

The *second method*, in which a small volume of very concentrated ether is given, *depending upon the patient* to dilute this with atmospheric air, is offered for that very large class of patients, particularly in private work, where the percentage method is not available. This method at its best but approaches the ideal offered by the former. It will be found very serviceable and efficient, however, if properly managed and will enable one to meet those many requirements for nasal anæsthesia encountered outside the hospital.

THE APPARATUS.—The apparatus is identical with that suggested for the vapor method of oral insufflation with the difference that we substitute the nasal tubes for the vapor mask. A throat tube is also necessary.

When intrapharyngeal insufflation is administered in this fashion, *it is very important to use the throat tube*. This will insure the proper tidal volume and sufficient air to dilute the concentrated ether delivered into the pharynx. In order to keep the patient sufficiently anæsthetized, how-

ever, one will find it necessary to induce a certain amount of rebreathing. This is most easily accomplished by the towels which are placed over the patient's head for the asepsis of the field of operation. These towels may, with advantage, be placed in position at the early convenience of the operator.

When in position they should not lie directly upon the rebreathing tube but at some distance from it.

THE ADMINISTRATION.—Anæsthesia is induced by the open, semi-open or closed drop method. When the stage of maintenance has been entered upon, the catheters are slipped gently into place. Ether vapor is then slowly bubbled through these (preferably by oxygen) into the posterior pharynx. The throat tube should now be introduced. If the ether vapor causes cough or spasm, stop the vapor but do not remove the tubes. Give ether orally by the drop method. Tolerance will soon be established for the vapor, and when spasm no longer occurs the vapor will be freely admitted and the drop method discontinued. The mask, however, is held over the mouth until complete control of the patient is established. The freedom of both hands which the oxygen method affords at this stage will be found a great convenience. When the sterile towels are placed over all, the anæsthetist should make sure that they do not block the pharyngeal tube. In this type of maintenance we must watch the patient somewhat more closely than in the percentage method. For our maintenance is here of the *variable* type and depends upon the signs immediately expressed by the patient for an elevation or depression of the level which is carried. It is always safer to carry the patient too low than too high, for many of the signs are masked. As we depend chiefly

upon the muscular signs and the respiration, it is safer to allow the patient to "come out" now and then to the point of a slight spasm of the respiration than to keep him "deep" all the while.

THE INDICATIONS FOR INTRAPHARYNGEAL INSUFFLATION

1. Operations on the head and neck excluding intranasal operations; glands of the neck, tonsils and adenoids; tumors of the face; intraoral operations. In operations for hare lip and cleft palate, the vapor may be delivered by one catheter through the intact nostril.

2. Whenever the immediate proximity of the anæsthetist endangers the asepsis of the field of operation, as in upper abdominal operations; breast operations; operations on the shoulder or chest.

CONTRAINDICATIONS

When the *percentage* method of intrapharyngeal insufflation is employed, the method may be used in any type of case with the possible exception of the very young and those patients who have double nasal obstruction, or who are to suffer nasal manipulations.

When the *variable* method by air bulb or oxygen is used, the method is contraindicated in all cases which do not specifically demand the method. This is because this variable type depends much more on the signs exhibited by the patient for even progress of the anæsthesia than does the constant or percentage type. In these cases, since we are unable to constantly follow the eye signs and the color, we are working at a disadvantage which, when avoidable, should not be incurred.

III. INTRATRACHEAL INSUFFLATION

In intratracheal insufflation we deliver ether vapor directly into the trachea of the patient, usually at a short distance from its bifurcation. We do not intend by this method to supplant the normal respiratory efforts by an artificial respiration, but to deliver the ether in a position most available for use by the patient. Instead of having two tubes delivering vapor into the pharynx, as is the case in the pharyngeal method, we have one long tube delivering vapor into the trachea, past the site of the vocal cords and upper air passages, where obstruction to the respiration is prone to occur.

We provide neither the inspiratory nor the expiratory effort. By placing our vapor directly into the rigid respiratory tree, beyond all obstruction, under a positive pressure of from 20 to 30 mm. of mercury, we naturally make inspiration easy for the patient. This is evident in the shallow respirations which he experiences. By using a tube of a much smaller diameter than the glottis, we provide for the free escape of the expirations and any excess vapor admitted. We do not here, as in intrapharyngeal insufflation, use concentrated ether vapor, diluting this with the atmospheric air, but we give a volume sufficient for all the respiratory needs of the patient. This volume, under sufficient pressure, is such that even during the inspiration with the glottis, but partially obstructed by the tube, no atmospheric air will enter; there will be no inward flow at any time into the trachea along the sides of the tube. On the contrary, there should be a constant flow to the outside. This flow will naturally be less at the time of inspiration but it will never altogether cease except when the delivery is cut off.

If this idea of a constant flow out of the lungs is understood, then the great value of this method will be seen in cases suffering from hemorrhage or vomitus in the upper respiratory tract. We might imagine such an anesthetized patient entirely immersed in water and yet receiving none in his respiratory tree. Sufficient pressure (20–30 mm. Hg), is necessary, not only for the exclusion of atmospheric air but in order to prevent the lungs from collapsing when the intrathoracic pressure is withdrawn during operations in the thorax.

The lungs are normally distended by virtue of the negative pressure in the thoracic cavity. This appears to be due to the fact that these structures remain smaller than the thorax in the course of development. The negative pressure may also be represented by the natural elasticity of the lungs. If the pleural cavity is opened and this elasticity allowed to act, the lungs will collapse. The pressure varies from 4.5 mm. at expiration to 7.5 at inspiration.

Obviously then, if we are delivering vapor into the trachea at a pressure of 20 mm. when the chest is opened, the lungs will have a tendency to expand rather than to collapse. This is what actually occurs:

Since the lungs do contract at regular intervals during normal respiration, we should simulate this action by frequently releasing the positive pressure. We do this in practice.

Since the interchange of the gases in the lungs results chiefly from diffusion rather than from actual replacement, a constantly changing stream of oxygenated vapor in the trachea and large bronchi will serve the vital purposes of respiration. We may then, with the greatest benefit, employ this method in artificial respiration (see page 29) where free diffusion is present in the lung tissue, that is in those

cases where fluid is absent, drowning cases, etc., excluded. In the normal case, however, it is unsafe to continue the administration in the face of suspended respiration.

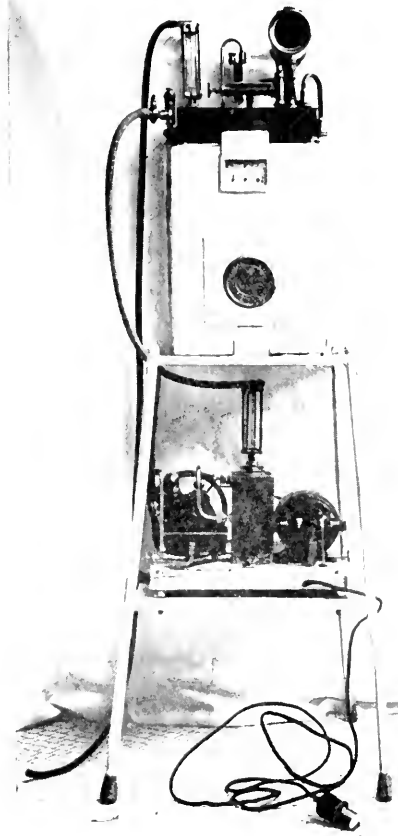

FIG. 87.—Portable anæsthetometer. (Connell.)

APPARATUS.—

1. Connell's anæsthetometer.
 2. Intratracheal catheter.
 3. Laryngoscope and mouth prop.
1. The anæsthetometer (Fig. 87) has already been men-

tioned on page 62 and in connection with intrapharyngeal insufflation on page 150 *et seq.*

2. The intratracheal catheter (Fig. 88). The best tube is the ordinary *silk-woven urethral catheter* (*size 24 French*) *with a side opening near its end*. The diameter of the catheter should be less than one-half the diameter of the glottis. A mark should be made 26 cm. from the tip.

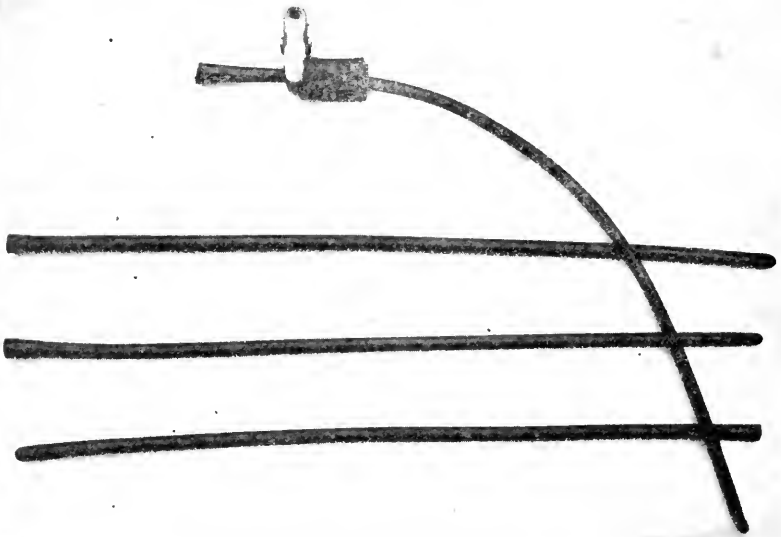

FIG. 88.—Intratracheal catheter.

This mark indicates the limit to which the catheter may be introduced. This mark should not be permitted to pass the incisor teeth. In the normal patient such a catheter introduced this distance will be about 5 cm. above the bifurcation of the trachea. As a rule it will be found that the tube must be pushed once again the distance between the incisor teeth and the glottis.

3. The Jackson laryngoscope has proven entirely efficient (Fig. 89). This instrument affords a direct, electrically illuminated view of the glottis. By this inspection we are enabled to estimate the size of the catheter necessary and to introduce it with full knowledge that it is in the trachea and not in the œsophagus. The laryngoscope,

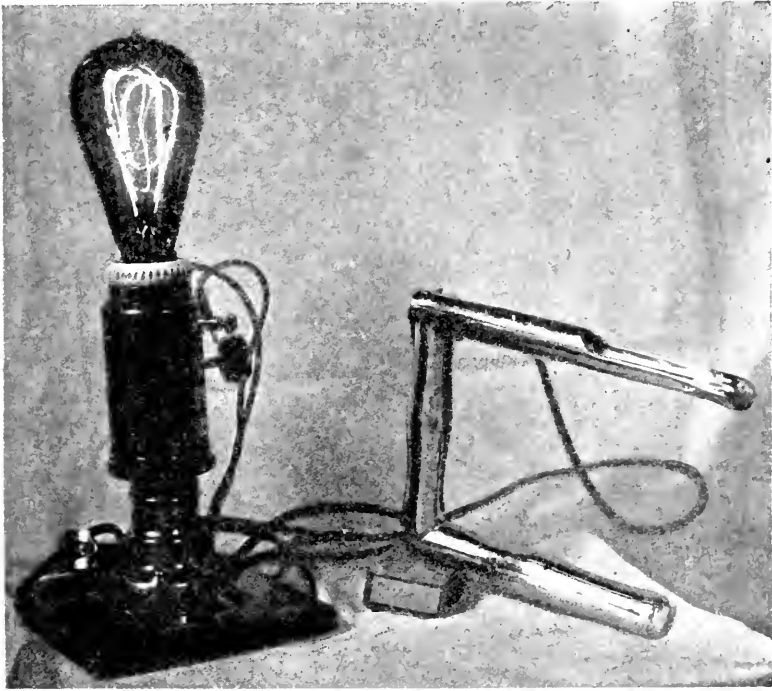

FIG. 89.—Jackson laryngoscope and rheostat.

which contains a small dry battery in the handle, is the most convenient pattern.

The mouth prop (Fig. 88) is for the purpose of protecting the catheter from accidental injury as it lies between the upper and lower incisor teeth.

THE ADMINISTRATION.—*Preliminary preparation:*

(a) Place half a dozen silk-wound urethral catheters, each marked 26 cm. (10-1/2 inches from the tip) in a pan of ice-water.

(b) Start the anæsthetometer so that it is delivering 50 mm. vapor tension. See that the emergency gauge which releases all pressure over 20 mm. Hg is in good working order. Regulate the pressure between 18 and 20 mm. of Hg.

(c) Have a foot bellows at hand for an emergency (Fig. 79).

(d) See that the electric lamp in the laryngoscope is in good condition.

In order to successfully administer an anæsthetic by the method of intratracheal insufflation it is essential that anæsthesia be completely induced by the oral method. The semi-open or close drop method may be employed. If intubation be attempted before the larynx has become anæsthetized, spasm will supervene, which will prevent satisfactory maintenance by this method.

The technic of intubation is as follows: The patient, having been well anæsthetized (lid reflex gone, jaw relaxed, eyeballs fixed, pupils contracted or slightly dilated, corneal reflex gone in both eyes, and the light reflex sluggish in the presence of a good color and stertorous respirations), and lying on his back *flat* on the table, the head is grasped by the right hand and forcibly extended so that the chin is almost on a straight line with the sternum and neck (Fig. 90). The laryngoscope is grasped in the left hand, as shown in the illustration. It is then slipped over the now dependent upper aspect of the tongue until the epiglottis is brought into view. The lip of the instrument is then slipped over this and the base of the tongue thus

elevated. The glottis, well illuminated by the small electric lamp at the distal end of the instrument, is now in full view (Fig. 91). With the laryngoscope still grasped in the hand, we select a catheter of the proper size with our right and slip this through the laryngoscope into the glottis, up to the 26 cm. mark. A hissing of air through this will now follow. The patient often coughs more or less violently depending upon the completeness of his induction.

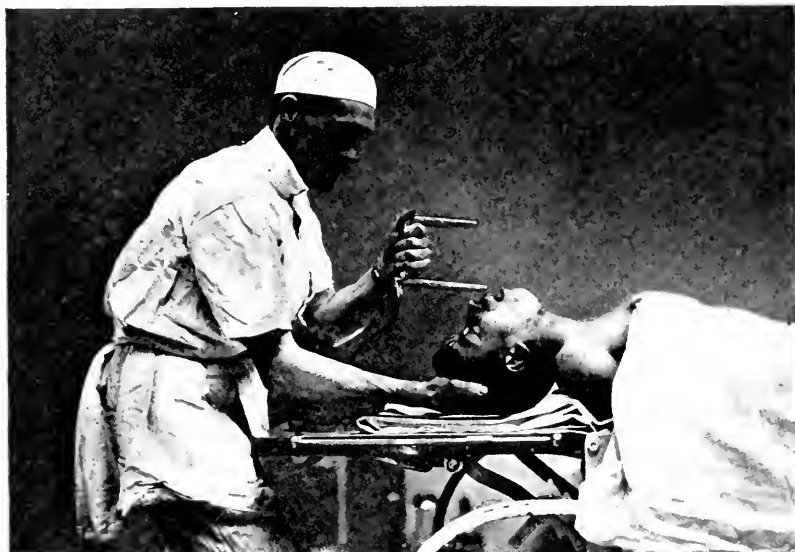

FIG. 90.—Intratracheal Anæsthesia. The patient is in the dorsal position and the operator is forcibly extending the head preliminary to exposure of the larynx by the Jackson laryngoscope which he holds in his left hand. Jackson technic. Roosevelt Hospital Report, 1915. (Courtesy of Dr. L. Booth.)

This quickly passes off, however, and regular breathing is quietly resumed. As the catheter passes into the trachea, a hissing of air through it will be heard. This is a guarantee that the catheter is properly placed. When this sound is not heard, one should suspect that the tube has slipped into the œsophagus. The mouth prop is now placed in position, the catheter running through it and the delivery

tube from the machine attached to this. The situation now resembles the intrapharyngeal, after the delivery through the nasal tubes has begun. Our duties are also the same with the exception that we must interrupt the flow two or four times a minute by pinching the tube. We also watch the pressure very carefully and observe with particular

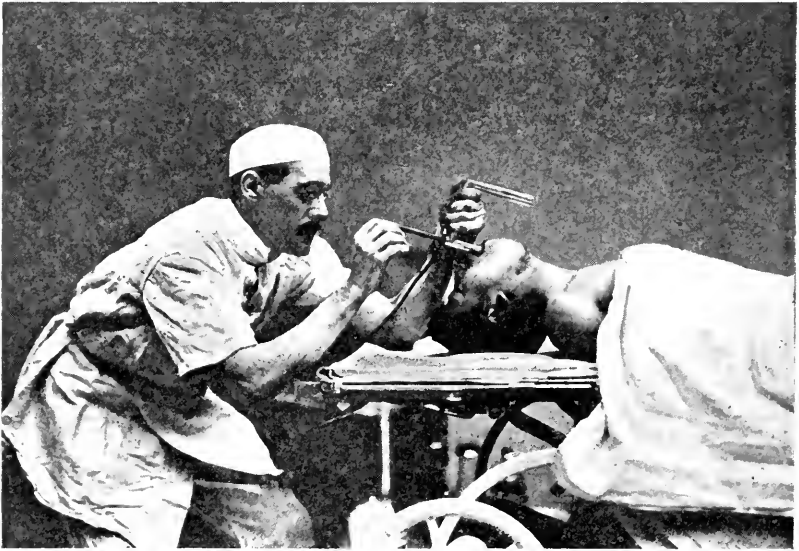

FIG. 91.—Intratracheal anæsthesia. The larynx is exposed to view by inserting the laryngoscope under the tongue and epiglottis and forcibly lifting these structures. When the larynx is in plain view, the catheter is introduced as is shown in the photograph. Jackson technic. Roosevelt Hospital Report. (Courtesy of Dr. L. Booth.)

care the respiratory movements of the patient. With this form of anæsthesia properly administered the maintenance is ideal.

We anticipate obstruction to the respiration. We deliver a constant vapor of sufficient concentration in a volume equal to all the respiratory needs of the patient.

The stage of recovery must be delayed, since the completion of the first half of this stage, namely the complete

return of the reflexes, cannot be permitted while the tube is in the trachea. Following the withdrawal of the tube a certain degree of acapnia results from the excessive ventilation which has been carried on, thus inducing a diminished CO_2 content in the blood.

After-sickness is the exception. There is seldom, if ever, any evidence of irritation to the vocal cords due to friction by the catheters, even though the latter have been in contact with these structures for two hours or more.

TROUBLE.—1. The chief difficulty will be found to be the *introduction of the tube*. Three factors are necessary to obviate this trouble:

1. Deep anæsthesia before intubation is attempted.
2. Complete extension of the head.
3. Direct vision of the glottis.

2. A catheter too large in diameter thereby obstructing the return flow or introduced too far, *i.e.*, into the bronchus, which it may partly or completely occlude, will subject the lung to destructive pressure. If there is doubt as to the proper position of the catheter this may be partially withdrawn, then introduced until it strikes an obstruction, *i.e.*, the bifurcation of the trachea, when it is again withdrawn an inch.

3. The tube may have entered the œsophagus; in this case the respirations do not whistle through it.

4. The pressure should not only be regulated by a blow-off but should be constantly readable on a Hg. manometer.

5. The anæsthetometer may of course get out of order and the pump may stop, which difficulties must be anticipated and properly met.

The method is neither dangerous nor difficult when one understands the object to be achieved and when one is familiar with the apparatus which he is to use.

The reader will doubtless conclude that, however ideal this method may be, it is debarred from the possibility of ever becoming a routine method for all types of cases, because of the technic and the complicated apparatus involved.

Broadly speaking we may say that for hospital work, where the anæsthetometer has been installed, the question of apparatus may be ignored. One becomes familiar with this modified *gas-meter* and ceases to be surprised at its accuracy and constancy. Real trouble is quite exceptional and when it does occur one feels as when one's watch stops. The only thing to do is to have it fixed. We have nothing else which will give us results which are so unvarying.

The crux of the whole question is the intubation and its advisability or inadvisability. The theory and the practice of this procedure will certainly form obstacles to the frequent and widespread use of this method.

THE ADVANTAGES OF INSUFFLATION BY THE INTRA-TRACHEAL METHOD

1. Specifically indicated in intratracheal operations, in order to prevent the collapse of the lung.
2. In intraoral operations, excision of the tongue, removal of the lower jaw, cleft palate, etc.
3. In operations on the trachea and the larynx.
4. For operations about the head and neck in general.
5. When vomitus may collect in the upper air passages, as in emergency operations for intestinal obstruction.

THE DISADVANTAGES

1. A special knowledge of technic is necessary.
2. Complicated and costly apparatus are needed.
3. Deep anæsthesia must be induced before the tube may be introduced.

IV. THE ADMINISTRATION OF THE ANÆSTHETIC PER RECTUM

We have considered the most commonly used and the most practical forms of administering the anæsthetic by the indirect method, namely oral, pharyngeal and intratracheal insufflation.

The chief reason for the effectiveness and safety of this route lies in the enormous capillary surface exposed to the action of the anæsthetic vapor. This surface has been estimated as being equal to an area of 90 square meters or equal to the surface presented by a balloon twenty feet in diameter.

It is possible, however, to induce and maintain anæsthesia by the injection of a suitable solution into the rectum.

This method while apparently simple is yet so fraught with danger that its use should be restricted to the expert anæsthetist. It should be employed only in the face of special and urgent indications, such as bronchoscopy or where it is impossible to secure a proper intratracheal apparatus.

Ether may be given per rectum when olive oil or oxygen is used as a vehicle.

Oxygen ether vapor per rectum has been used intermittently for the last ten or fifteen years. With this method it is not practical, however, to induce anæsthesia. Its chief value is for the maintenance of anæsthesia otherwise induced. Since we have other and better methods of maintaining anæsthesia, it will be of little value to enter more fully into a discussion of this rather obsolete method.

Anæsthesia by the injection of olive oil and ether, however, will require a somewhat more lengthy consideration.

This method, introduced during the last two years, while certainly attractive from several points of view, is pernicious because of its apparent simplicity. To give an enema of a mixture of ether and olive oil, which will result in satisfactory surgical anaesthesia, appears so simple upon superficial consideration that thoughtless anaesthetists have naturally been attracted and without counting the cost have not only endangered but killed their patient.

A technic of such apparent simplicity, as is described for the proper administration of this method, should have no intricacies into which the unwary may blunder. A method demanding experience and great care should be safeguarded by the immediate report of fatalities directly or remotely due to the method.

The small surface which the gut offers for the absorption of the ether vapor implies the need of a concentrated solution placed *in situ* and necessarily absorbed slowly. This solution when once introduced into the rectum passes more or less completely out of our control.

The rate at which this vapor is thrown off by the lungs in the human being will differ from that in the small, hairy animals, whose respiratory mechanism is intended to dispose of a proportionally much larger amount of heat and moisture than does the human.

Observations made upon cats and rabbits involving the element of respiration will not form a reliable basis upon which to judge human beings.

As long as we are obliged to depend upon the reliability of colon irrigation to remove an overdose, and upon the dilution of the circulation by an intravenous solution when the former has proven ineffective, we should approach this

method with the utmost caution. Until we may consider statistics from the *unreported deaths* due to this method, our policy in the absence of urgent indications and expert control should be one of “*watchful waiting*.”

While we are aware of excellent results which have followed the use of this method, we feel that it is not adapted for routine use: certainly not for the tyro and the occasional anæsthetist.

APPARATUS.—

1. Eight-ounce measuring glass.
2. Olive oil and ether.
3. Catheter and rubber tubing.
4. Funnel.

We take the liberty of following here the directions given by Dr. Gwathmey, the originator of the oil method.

Preliminary treatment: Castor oil the night before, followed in the morning by warm water enemas, one hour apart until the return is clear. The patient may then be allowed to rest for two or three hours.

One hour before operation 5 to 20 grs. of chloretone in suppository form are given; for the chlorotone we may substitute 2 to 4 drachms of paraldehyde in an equal amount of olive oil.

Twenty minutes before operation a hypodermic of $1/12$ to $1/4$ grs. of morphine and $1/200$ to $1/100$ gr. of atropine may be given.

The Solution.—Adults are given a mixture consisting of ether Oz. 6, olive oil Oz. 2 (a 75 per cent. mixture). The size of the dose is reckoned upon a basis of Oz. 1 of the mixture to every 20 lbs. of body weight: *i.e.*, man weighing 140 lbs. would need Oz. 7.

Children are given a mixture consisting of ether Oz. 3,

olive oil Oz. 3 (a 50 per cent. mixture). The size of the dose is reckoned as with adults.

THE ADMINISTRATION.—With the patient in the Simms' position (see Fig. 21), in his own bed, the catheter (24 F.) is introduced about four inches into the rectum. The oil ether mixture is then allowed to flow in, allowing at least one minute for each ounce.

The patient quickly becomes drowsy. Ether appears on the breath in from five to ten minutes. Excitement may be moderate or entirely absent. After a time, ten to thirty minutes according to the absorptive power of the colonic mucous membrane of the patient in question, he may be placed on the stretcher and conveyed to the operating room.

The stage of maintenance is controlled by increasing or decreasing the freedom of the respiration, *i.e.*, a towel over the face will cause the patient to sink into deeper narcosis by virtue of the rebreathing of the expired ether. On the other hand, a throat tube (see Fig. 14), will, by increasing the freedom of the respiration and consequently the amount of the ether thrown off, lower the level of the maintenance.

Occasionally one is obliged to supplant the rectal administration by the drop method. If the respiration should show signs of shallowness or failure, the ether and oil injected should be immediately withdrawn by reintroducing the catheter and allowing the retained solution to run off. In the event of failure of the respiration, rebreathing of CO_2 may be beneficial. If ineffective it is recommended that a vein be opened and from 1000 to 2000 cc. of normal saline injected with a hope of reducing the ether tension in the anesthetized tissue. When the operation is well under way it has been found advisable to withdraw

as much of the injection as may be reached with the catheter. At the completion of the operation a cold soapsuds enema is introduced high into the colon. This is then drawn off and two to four ounces of olive oil are introduced, with a view of neutralizing any ether which may remain unexcreted.

THE ADVANTAGES OF THE METHOD

When efficient, the nature of the induction in the patient's bed is certainly a great boon.

The apparatus is most simple and economical (this for many is the "raison d'être").

The control when effective is most simple, *i.e.*, increasing the freedom of the respiration by a tube to lighten the anaesthesia, decreasing it by a towel over the face to deepen it.

When the intratracheal method is not available this method may be used with satisfaction for operations on the oral passages, the nasal passages and the neck.

THE DISADVANTAGES OF THE METHOD

1. It is certainly dangerous.
2. The preliminary preparation is frequently inefficient and often distresses the patient.
3. The method is unreliable, even in the hands of the experienced and must often be supplemented by oral insufflation.
4. The addition of an anaesthetic by mouth in addition to that *in situ* in the rectum is more than ordinarily dangerous, as we do not know what part of the latter will be suddenly absorbed.
5. Distention of the rectum is prone to occur.
6. It is undesirable in cases where the Trendelenburg

position is used (Fig. 18), as the injection has a tendency to force its way up the gut by gravity.

7. Injections which are producing untoward effects frequently cannot be recovered. We doubt the possibility of completely irrigating the colon at will.

8. Ulcerations of the colon and operations about the lower gut positively contraindicate the use of this method.

9. The respiration may form a vicious circle, *i.e.*, the more ether absorbed the more shallow the respirations are likely to become; the more shallow the respirations the more ether accumulates in the circulation.

10. Since the ether which is not broken up by the body tissues must be excreted by the lungs, we doubt the efficiency of this method in pulmonary tuberculosis.

11. Ninety per cent. of the injections into the rectum find their way to the cæcum by virtue of reverse peristalsis. Can we recover such injections at will?

12. Cases which present respiratory obstruction, obese individuals, goitre cases, etc., would appear to contraindicate this method, as such obstruction interferes with our chief safety valve, the freedom of the respiration.

13. Emergency cases necessarily lacking the proper preliminary preparation are unsuited to this method.

14. The untoward effects of morphine in cases having received a rectal injection of a solution of ether are more difficult to combat.

V. THE DIRECT METHOD OF ANÆSTHETIZATION BY INTRAVENOUS ANÆSTHESIA

Intravenous anæsthesia is that type of anæsthesia in which we introduce into the circulation of the patient, by way of a convenient vein, a solution which contains ether.

The strength of this solution varies from 5 to 7 per cent. The amount of the solution administered depends upon the duration of the anæsthesia. This amount is from 500 to 3500 cc., 1000 cc. an hour being the average. The solution is given continuously, no accumulative action being permitted. We do not, as is the case with rectal anæsthesia, give a dose and trust to the patient to absorb it or excrete it according to our expectations, depending upon enemas to undo mischief after it has occurred. When one ceases to administer the intravenous solution, the patient "comes out" at once. The control is delicate and free from many of the complications which one is prone to meet in insufflation methods.

We speak of intravenous anæsthesia as the direct method of anæsthesia because by this method we do not require the assistance of an intermediary system, such as the respiratory or the gastro-intestinal to assist us in our anæsthetization. We place our anæsthetizing agent directly into the blood stream, through which medium it presumably acts upon the central nervous system. From the point of view of the anæsthetic, then, the method is direct.

From the point of view of the anæsthetist, however, the matter is not so simple. The proper introduction of the solution implies: (1) satisfactory local anæsthesia for the isolation of the vein of introduction; (2) a surgical operation (the introduction of the cannula).

The speedy, skillful and painless administration of an intravenous injection implies familiarity with surgical technic. Such a procedure requires perfect asepsis and dexterity bred of experience. While the average anæsthetist might succeed in finding a vein in most cases and in success-

fully introducing a cannula in a smaller number, the chances of his doing so rapidly and painlessly would be less.

This type of anæsthesia may be classed as an anæsthetic feat and, while most attractive in many of its aspects, will never achieve a broad practicability. It will be of interest, however, to consider the method and to become familiar with the essentials of the technic.

APPARATUS.—1. Accessories for local anæsthesia (see page 257).

2. Instruments for isolating vein.

3. Apparatus by means of which the solution is delivered to the patient.

4. The solution administered.

5. Apparatus for maintaining free respiration.

1. The accessories for the production of local anæsthesia consist of a proper syringe, needles and solution. A detailed description of these various elements will be found under the consideration of local anæsthesia, page 257.

2. The instruments necessary for the isolation of the vein consist of a scalpel, two hæmostats, blunt pointed scissors, ordinary forceps and a pair of small artery forceps.

3. Apparatus for the intravenous solution proper consists of:

(a) A reservoir, preferably glass, having a capacity of 2000 cc. with an outlet in the bottom.

(b) Tubing whose proximal end is attached to the reservoir and whose distal end terminates in a small cannula, which is to be introduced into the vein.

(c) An arrangement whereby one can readily and constantly estimate the amount and rate of flow of the solution into the vein is essential. In the apparatus shown in Fig. 92, this is done by means of a specially constructed glass

globe through which the solution is made to flow on its way from the reservoir to the cannula. This globe, known as a dropper, is an indispensable feature of the apparatus, for the rate of flow of the solution, about 16 cc. per minute, must be constantly indicated. The action of the dropper is as follows: When the solution is flowing, it enters the upper part of the globe in the form of a spray or drop through a small, nipple-like projection. This is allowed to collect in the lower half of the globe, the control being established by a clip attached to the distal tubing. The constancy with which this level is kept in the presence of a continuous flow through the nipple indicates the flow to the patient.

4. The solution, a 5 to 7.5 per cent. solution of ether in sterile Ringlers solution (a solution containing sodium, potassium and calcium chloride), or in ordinary normal saline, at a temperature of 85° F.

5. A pharyngeal tube.

THE ADMINISTRATION.—It is quite essential that the usual preliminary treatment, as indicated in the section covering the control of the period of excitement, page 24, be carried out. The preliminary visit is especially valuable for the beneficial effect of suggestive therapeutics. The patient must be brought into the operating room and placed on the

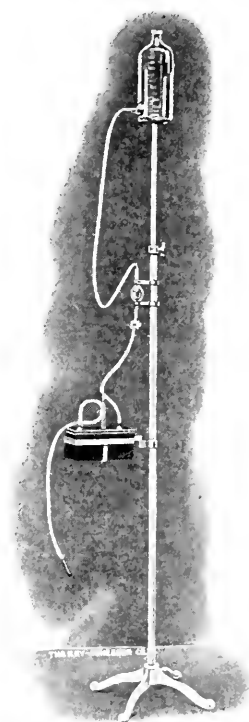

FIG. 92.—Intravenous apparatus.

table half an hour before the time set for the operation. Incidentally this means that the operating room must be set and the anæsthetist on hand some three-quarters of an hour to an hour before the time set for operation.

When the patient has been placed on the table, a hypodermic of morphine grs. $\frac{1}{2}$ and atropine $\frac{1}{100}$ and scopolamine $\frac{1}{1000}$ is administered. The arm to receive the solution is strapped to the support upon which it rests. The veins of the forearm are made to stand out prominently by digital pressure above the elbow. A space as big as a dime is injected with novocaine .5 per cent. The skin is incised and the vein exposed and dissected out. While this procedure is being accomplished, the reservoir is filled with the solution and placed on the stand 8 feet above the floor. The vein having been isolated, a ligature tied distally and an united ligature placed proximally to the opening made therein, the cannula with the solution flowing is gently introduced and secured by the loose ligature, which is now tied with one knot. A large gauze pack is now placed over the field and strapped to the arm with adhesive plaster.

We may then devote our attention to the indicator and the patient.

The solution is allowed to flow slowly into the vein. The patient soon passes into a quiet sleep with little or no excitement. The transition from consciousness to the stage of maintenance is indeed so quiet that one would be led to suspect that anæsthesia was not present were it not for the loss of the lid and eye reflexes. The airway must be patent at all times. This is best accomplished by the introduction of the Connell tube as soon as the pharyngeal reflexes have disappeared. Anæsthesia is increased (the level of main-

tenance raised) by increasing the flow of the solution, the patient is allowed to "come out" (the level of maintenance is lowered) by stopping the flow. It is more satisfactory to keep up a continuous flow than to give the solution intermittently, since the patient recovers promptly upon the cessation of the flow. The amount of the solution usually consumed in an hour is 1000 cc.

POST-OPERATIVE TREATMENT.—The wound in the arm should be closed with a straight needle. It may then be wiped with iodine solution or carbon tetrachloride in thymol (50 per cent. solution), and the dressing applied.

The patient should be placed in the semi-Fowler position (Fig. 122), and he should be turned every hour to overcome the tendency to pulmonary œdema and the formation of spots resembling bruises in the loose, fatty tissue of the back and buttocks.

THE ADVANTAGES OF THE METHOD

Ideal control of the administration.

Not dependent upon the rate or the depth of the respiration.

The minimum amount of the anæsthetic is employed.

There is little or no cumulative action.

The technic is sufficiently complicated to exclude thoughtless experimentation.

THE DISADVANTAGES

The general anæsthetic must be preceded by an operation under local anæsthesia.

The preliminaries to the administration of the anæsthetic *per se* involve a loss of much time and, from this

point of view, the method is impractical as a routine in the large hospital.

The proper administration implies familiarity with the surgical technic required.

The blood pressure is raised.

The bleeding is increased and the fluid has a tendency to collect in the abdomen.

It is an open question as to the harm done by the injection of a normal saline solution in the blood stream of a healthy individual.

The possibility of septic thrombosis must be considered.

There is a tendency to pulmonary œdema and spots, resembling bruises, frequently appear on the back and buttocks.

CHAPTER V

ETHYL CHLORIDE

ETHYL chloride, or sweet spirits of salt, was discovered by Florens in 1847. It is a colorless liquid, very volatile and has a pungent, ethereal odor. It boils at 12.5 C.

Ethyl chloride is used for general anæsthesia as well as for local anæsthesia. (See page 249.)

While ethyl chloride has been frequently employed as a general anæsthetic throughout the stages of *induction, maintenance and recovery*, its use as the sole anæsthetic in such a *complete anæsthesia* should be discouraged. This is because of the narrow margin of safety between a stage of satisfactory maintenance (complete muscular relaxation) and the lethal dose or the dose which may kill. Collapse is more liable to follow ethyl chloride than any other anæsthetic.

From a practical point of view then the administration of this anæsthetic is limited to: (1) the induction of anæsthesia (as a preliminary to ether anæsthesia); (2) *incomplete anæsthesia* (that type of anæsthesia without the stage of maintenance).

The administration of ethyl chloride as a preliminary to ether, and its use alone for short operations, is but a matter of degree. With the former our object is to destroy consciousness; with the latter we go a step further and approach the period of relaxation.

Ethyl chloride is frequently used as a substitute for N_2O . Portability and cheapness are offered as reasons for this. In view of the unquestionably greater safety of N_2O , however, such a procedure is entirely unjustifiable. The situation is well put by Thomas D. Luke, who says "The

idea has got about among a large number of both the medical and dental profession that ethyl chloride is a sort of a glorified N_2O , which one may carry about in one's waist-coat pocket and administer to all and sundry, without any special precaution or skill on the part of the administrator . . . Nothing further from the facts could be imagined

FIG. 93.

FIG. 94.



FIG. 93.—Chloroform container.

FIG. 94.—Ethyl chloride container, spray type.

. . . Its highly toxic character and the danger due to the great rapidity of its action should be fully recognized as well as its admirable properties as an adjuvant to chloroform and ether." Dr. Luke follows his remarks with a report of twenty-three deaths from ethyl chloride in the short span of five years.

The administration of ethyl chloride is often followed by headache, nausea and vomiting. These symptoms may appear immediately after recovery or be delayed for five or six hours.

When ethyl chloride is administered, the consciousness is rapidly lost as with N_2O . Its effects are best seen with a closed apparatus, as with ether. In overdose it kills quickly, as does chloroform.

A cork or some other mouth prop must be placed between the teeth before the administration is begun, for masseteric spasm is prone to occur.

When a closed apparatus is used the dose should not exceed 1.5 cc. for children and 3 to 4 cc. for adults. This dose should be given slowly and cautiously.

When open or semi-open methods are used, the dose may be increased.

Ethyl chloride, owing to its very great tendency to evaporate, is marketed in special glass containers. (See Fig. 94.) The delivery from some containers is controlled by a spring lever applied to the vent, in others by a gas-tight screw cap.

THE ADMINISTRATION OF ETHYL CHLORIDE AS A PRELIMINARY TO ETHER ANÆSTHESIA OR ALONE FOR THE PURPOSE OF SECURING INCOMPLETE ANÆSTHESIA

APPARATUS.—The semi-open drop mask, as described on page 128, or a closed apparatus such as described on page 134.

When the semi-open method is employed a much larger quantity of the drug will be required.

Before starting the anæsthetic a mouth prop is placed between the teeth of the patient; the mask is then arranged as in Fig. 69 or Fig. 71, and the patient is instructed to

count out loud. Ethyl chloride is carefully sprayed upon the mask. The administration is continued until consciousness is lost, when ether in the form of a drop or spray is resorted to.

The effects obtainable by this method are not nearly as satisfactory as those which may be secured by the employment of a closed method. Where the latter is employed, the rebreathing bag is filled with the patient's expirations. He is then instructed to breathe naturally to and fro. As he does so, ethyl chloride is sprayed into the apparatus through some convenient vent; either into the bag proper, or into the evaporating mediums, gauze, wire screen, or whatever it may be. The drug is added slowly, not more than 4 cc. in all being used.

Free air should be administered upon the first evidence of stertor.

When ethyl chloride is given *per se* to produce incomplete anæsthesia, it should not be pushed to a loss of the corneal reflex and a dilated pupil. An absent lid reflex, page 103, deep, involuntary respirations and absence of muscular excitement being all that is desired.

When employed as a preliminary to ether, we have attained our object when consciousness is lost and the pharyngeal reflex has been rendered somewhat less sensitive to the odor of ether.

The loss of consciousness when ethyl chloride is used for induction is not so rapid or so pleasant as when N_2O is used. It is, however, more speedy and more grateful to the patient than is ether alone.

The dangers of this anæsthetic are twofold: From overdose; from asphyxia, secondary to spasm occurring in the respiratory tract.

The proper anticipation of these difficulties will forestall untoward results.

CHAPTER VI

CHLOROFORM

CHLOROFORM was first used as an anæsthetic by Sir James Simpson in 1847, some months after the announcement of the discovery of ethyl chloride by Florens.

Chloroform is a colorless liquid with a sweet but burning taste, and possessed of an ethereal odor. The boiling point is 61.2 C.

GENERAL CONSIDERATIONS

Since its discovery chloroform has been the favorite anæsthetic of continental Europe. Ether, however, has found greater favor in this country, more particularly in the large cities. In country practices and small towns in the United States, chloroform is still extensively employed.

With chloroform the stage of induction is usually free from excitement; the stage of maintenance is quiet and characterized by tranquil breathing and complete relaxation. The stage of recovery is comparatively brief and the after-effects of the anæsthetic are usually conspicuous by their absence.

Chloroform, however, unlike ether, is a distinct *protoplasmic poison*. *Chloroform kills* quickly in overdose (in a concentration of 5 per cent. or more). Chloroform is most dangerous during the stage of induction, at which time it is most commonly used.

As a protoplasmic poison, the evil effects of chloroform frequently do not become evident until some time after the administration. Such late effects are known as "delayed chloroform poisoning." This condition of de-

layed chloroform poisoning is now well recognized. The degenerative effects which take place closely resemble those found in the liver and kidneys of eclamptic cases. Numerous investigators have pointed out these lesions. We quote the following from a paper by Drs. E. B. Cragin and E. T. Hull of the Sloane Maternity Hospital:

“Recent studies of the pathologic changes produced by eclampsia, delayed chloroform poisoning and chloroform anæsthesia have shown a striking similarity in the findings in all three conditions.”

The pathologic picture in each is that of congestion, hemorrhage, degeneration and necrosis. Our knowledge of the pathology of eclampsia is of comparatively recent date, but thanks to the work of Jurgens, Schmorl, Williams, Ewing, Welch and others, the lesions are now well recognized and generally accepted.

Delayed chloroform poisoning as such has been frequently recognized and carefully studied, both clinically and pathologically, for the last twenty years. Many writers have reported series of fatal cases, all showing symptoms and lesions which are now recognized as typical of the condition. A number of these deaths occurred after only twenty or thirty minutes of anæsthesia, untoward symptoms developing a few hours to a few days after the administration. The symptoms include progressive weakness, pallor or cyanosis, restlessness, vomiting, delirium, convulsions, stupor, coma and death. The organs principally affected are the liver and kidneys. The former is yellow and fatty, with hemorrhages often under the capsule and throughout its substance. The typical picture is that of a central necrosis. The cells about the central vein disappear, leaving only a mass of granular material which shows neither nuclei

nor cell outline. Nearer the periphery of the lobule is a zone of swollen cells, which have undergone hyaline and fatty degeneration. A few normal liver cells may remain at the periphery. The kidneys are swollen, markedly congested, with occasional hemorrhages under the capsule, about the tubules, and in the pelvis. The cortex is thickened, the markings indistinct. Microscopically the cells of the tubules are greatly swollen, granular, and loaded with fat. The lumen is filled with granular material, fat globules and coagulated serum. The heart muscle often shows some fatty degeneration. The changes are generally considered to be more profound in the liver, though some observers have found the kidney degeneration even more marked.

The reports of these cases of delayed chloroform poisoning with their pathologic findings led naturally to a study of the lesions produced by chloroform anæsthesia. Many animals were used in these experiments, most often dogs, rabbits and guinea-pigs. These studies were exhaustive and include the work of Lengemann, Ostertag, Stiles and McDonald, Stassman and others, together with the more recent work of Howland and Whipple. The most striking result of these studies was the extent of the degeneration and necrosis found in the liver and kidney after chloroform anæsthesia of a short duration.

It has been found that characteristic lesions are regularly produced, varying in degree with the duration and depth of anæsthesia, and also with idiosyncrasy. Thus after thirty minutes to one hour anæsthesia with chloroform, the centres of the lobules of the liver show congestion with granular and fatty degeneration, the innermost cells being necrotic, their nuclei not taking the stain and the

protoplasm being deeply stained pink with eosin. With more prolonged action the changes approach those found in delayed chloroform poisoning in man. The liver appears yellow and fatty with scattered hemorrhages. The cells about the centres of the lobules are entirely necrotic, a granular mass remaining. Outside of this is an area of cells which have undergone hyaline and fatty degeneration, with normal cells at the periphery. In some cases the liver cells have almost entirely disappeared with only a few scattered living cells in the portal spaces. In the kidney, chloroform anæsthesia causes a marked congestion with a cloudy swelling and occasionally hemorrhages into the parenchyma. The cells of the tubules are swollen and granular, occluding most of the lumen; in other places they have disappeared entirely. Fatty degeneration is present and in many cases pronounced. The heart muscle may be pale and show fat droplets in its fibres. Hemorrhages occur throughout the body, particularly in the serous membranes, and in the intestinal and stomach mucosa.

Howland and others were able, almost at will, by continuing the anæsthesia to produce delayed chloroform poisoning in dogs, with symptoms and lesions corresponding in detail with those of delayed chloroform poisoning in man. Thus we find in these three conditions, eclampsia, delayed chloroform poisoning in man and chloroform anæsthesia in animals, many similarities. Pathologically there is central necrosis, parenchymatous and fatty degeneration in the liver; congestion, parenchymatous and fatty degeneration in the tubules of the kidney and a tendency to hemorrhages throughout the body. Clinically in delayed chloroform poisoning and in eclampsia there are vomiting, jaundice, delirium, convulsions and coma.

Does ether produce lesions in the liver and kidneys similar to chloroform? Some work has already been done along this line, notably by Bandler, Lengemann and Leppmann, and it was partly to confirm scattered observations on this subject that a further study of ether anaesthesia was undertaken.

In our experience six mongrel dogs of medium size were given ether by inhalation from an open cone. They were killed with ether forty-eight hours after the last anaesthesia and autopsied at once. Sufficient ether was given to produce complete muscular relaxation with loss of corneal reflex.

In none of these animals could any necrosis in any of the parenchyma be found. In the lungs occasional small areas of a deeper red than the surrounding substance, containing an increase in the amount of blood on section, showed congestion. The heart muscle in each dog was found to be of normal color, striations distinct, no apparent increase in fat.

There were no hemorrhages in the mucosa of the stomach and intestines.

The livers were of a good color throughout, the vessels in a few places standing out a brighter red than the surrounding structure. The yellow appearance was entirely lacking, the cells throughout preserved their outlines with contents intact. There was no suggestion of necrosis at any point. The protoplasm was somewhat granular and small droplets of fat were found in the cells about the central veins and in the portal spaces. This fat was only slightly in excess of that in the controls.

The kidneys were of normal size, capsule not adherent, cortex not thickened, markings distinct. Microscopically

the cells of the tubules were well preserved throughout; their outlines were distinct, the nuclei staining sharply, the protoplasm granular, the tubules containing in some places some granular material. Fat globules were present in a few of the straight tubules and in the lining cells. This condition seemed no more than is normally found, and no more marked than in the controls taken.

No pathologic changes could be found in any of the sections of pancreas and spleen. These facts seem to demonstrate that in animals, at least, ether produces practically little effect on the liver and kidneys as compared with the very marked changes in these organs produced by chloroform, and, while it may be argued that this comparison has been demonstrated only in animals, the similarity between the lesions of delayed chloroform poisoning in man and chloroform anæsthesia in animals makes it appear more than probable that reasoning as to the effect of ether on the liver and kidney of man, from the lesions produced by ether in animals, is entirely justified.

The foregoing facts lead to the conclusions arrived at by the Committee on Anæsthesia of the American Medical Association, June 15th, 1912:

“ 1. The use of chloroform as the anæsthetic for major operations is no longer justifiable. Scientific investigation and clinical experience agree in demonstrating that necrosis of the liver (‘delayed chloroform poisoning’) follows in a by no means inconsiderable percentage of cases. The mode of causation of this sequel is unknown. There are therefore no precautions that can be intelligently taken against it. Accordingly the surgeon whose patient dies in this manner a day or two after operation must face the responsibility of having knowingly taken an unnecessary

chance—and lost. We see no reason to believe that in respect to toxicity there is more than a slight quantitative difference between chloroform alone and such chloroform mixtures as A. C. E., anesthol, etc.

“ 2. For minor operations also the use of chloroform should cease. In general it may advantageously be replaced by nitrous oxide, or nitrous oxide-oxygen. It is a mistake to think that a fatality under anæsthesia is necessarily due to an unusually large administration of the anæsthetic. A previous condition of suffering or anxiety, or a prolongation of the stage of anæsthesia excitement renders a subject who would otherwise be able to resist a large dosage, liable to collapse even under a small dosage. The practical importance of avoiding so far as possible all anxiety and pain has been demonstrated on the clinical side by Crile, and experimentally by Henderson. It is noteworthy that Levy (with Cushny) has recently demonstrated that in cats a sudden heart failure (fibrillation) is induced by a period of light chloroform anæsthesia, while this form of death is not inducible by deep anæsthesia. Risks of this sort are far greater with chloroform than with ether, and greater with ether than with nitrous oxide. As they cannot be foreseen, they cannot be avoided, except by replacing a dangerous anæsthetic by a safe one.

“ 3. Chloroform is sometimes found convenient for initiating anæsthesia in alcoholics or other difficult subjects. As a means of avoiding the ill effects of a prolonged period of ether excitement the temporary employment of chloroform for this purpose is perhaps sometimes the lesser of two evils. It is justifiable only when nitrous oxide is not available. If chloroform is to be so used, it should be given as soon as it is evident that the patient will not go

under ether readily. Unless the change to chloroform is made early it should not be made at all. We wish especially to emphasize the point that chloroform should never under any circumstances be administered after a prolonged period (10 or 15 minutes or more) of ether excitement. Even a small administration of chloroform is then peculiarly liable to induce respiratory or cardiac death. As soon as full anæsthesia is attained ether should be substituted."

It has been argued that the evil effects of chloroform are largely due to impurities found in the drug; these impurities depending upon faulty preparation or exposure to light and air. If such toxic impurities are so constantly present as to result in the common findings of a large number of investigators, it would seem that the end result is the same as though the evil lay in the drug itself. We can scarcely hope to convince all users of chloroform of the danger of their position and urge upon them a favorite preparation of our own. If chloroform is shown to be consistently poisonous we had best forego the pleasure of its free usage and confine ourselves to an anæsthetic which is safer, though somewhat more difficult of manipulation.

We who have become accustomed to chloroform will be prone to yield ourselves to its charms and to feel that because clinical distress seldom appears, pathological damage has not occurred. We will recall particularly our rather extensive experience in obstetrical cases, the delightful and efficient anæsthesia which we have so often obtained, the freedom from excitement in induction and the absence of symptoms upon recovery. We will recall the many instances in which we have anæsthetized children large and small. We are prone to smile when the pathol-

ogist condemns our most valuable agent "chloroform." We will not abandon chloroform but we will use it less frequently and with more respect.

Those of us who are now receiving our obstetrical training will find little difficulty in getting along without this valuable but dangerous agent. The present generation brought up upon a constant diet of pathological findings learn to look with increasing confidence to this authority. We accept its dictates as our own and confidently walk in the light of its decisions. If we accept the conclusions of pathology, chloroform *per se* cannot be the anæsthetic of choice in the routine case.

The indications which present themselves for the use of chloroform must be sufficiently urgent to overcome our aversion to its use. The chief indication is that presented by acute pulmonary disease where N_2O and O is not available, and in the control of individuals who cannot be well handled by ether.

One of the most marked characteristics of chloroform is its tendency to bring about circulatory depression. In glancing over the works of Hewitt, Luke and other English authors, one is struck with the frequent reference to circulatory shock. We scarcely ever see a case of this nature where ether is the anæsthetic. The use of ether with chloroform appears to reduce the likelihood of this type of shock. This explains in part the popularity of the well known A. C. E. mixture (alcohol 1, chloroform 2, ether 3). The alcohol of this mixture is usually omitted, the result being a C. E. mixture.

The C. E. mixture is so much safer than the chloroform *per se* that it has largely supplanted the employment of the latter.

CONTAINERS.—Since chloroform deteriorates upon exposure to air it is safer not to use a sample which has been opened (Fig. 93). With this fact in mind manufactories are now putting out ampules and bottles sufficient for one administration. Bottles containing one ounce are inexpensive and satisfactory. If the solution is not all used the residue should be sent to the pharmacy for the preparation of chloroform liniment.

THE ADMINISTRATION.—Since the addition of ether to the chloroform reduces the likelihood of circulatory depression and improves the quality of the respiration we have practically abandoned the use of chloroform *per se*.

Ether may be given mixed with chloroform in the proportion of ether-parts 3, chloroform-parts 2, or the drugs may be given alternately by the drop method. A few drops of chloroform being followed by a somewhat larger amount of ether. Where one is desirous of obtaining the effects of chloroform, more particularly for the stage of induction, the contents of an ounce bottle of chloroform freshly opened is mixed with one and one-half bottles of ether (the empty chloroform bottle being the measure).

As the stage of maintenance is approached, ether is added to the container, one ounce at a time. By the time the stage of maintenance has been entered upon the amount of chloroform present in the mixture will be so small as to be practically negligible.

Apparatus.—When the C. E. mixture is employed it may be administered to the patient by: (a) the drop method; (b) the vapor method.

(a) When chloroform alone is used there should be no air restriction whatever. For this reason the use of the semi-open method and the closed method should not be

tolerated. The open drop mask, as described on page 122, may be employed. If chloroform alone is used the mask should not be permitted to rest against the face. Where the C. E. mixture is the anæsthetic, however, the mask may be used, as in the case of the open drop method of ether administration. One should always remember that one is administering chloroform and that it is dangerous to soak the mask as may be safely done in the case of ether *per se*. The mixture should be added cautiously drop by drop, the signs of anæsthesia being our index as to whether we should push or decrease the administration.

(b) The vapor method is a very convenient and effective method of administering the C. E. mixture. Oxygen is preferable to air as a means of producing the vapor. The same care should be exercised as in the case of the drop method. As anæsthesia progresses ether may be added to the reservoir, thereby reducing the risk of chloroform complications. Chloroform should never be given near a naked flame. A product known as phosgen gas is formed which may seriously effect not only the patient but the operator and assistants as well.

THE CAUSES OF DEATH IN CHLOROFORM ANÆSTHESIA

In the stage of induction chloroform deaths occur as follows:

(a) Spasm of the respiration occurs. The anæsthetist continues to drop the chloroform upon the mask. A large amount of chloroform thus accumulates. Following the relief of the spasm, spontaneous or artificial, the patient breathes deeply. A lethal dose of chloroform is carried to the heart muscle, which, weakened by the previous res-

piratory spasm, suddenly and permanently dilates. This is the usual cause of death of the large, alcoholic and athletic individual.

(b) Vagus inhibition, causing paralysis of the heart muscle, sometimes occurs in high strung, neurotic individuals.

In the stage of maintenance chloroform deaths may occur as follows:

(a) By the elevation of the head and shoulders syncope may result, which in turn may develop into definite circulatory shock and cessation of the respiration.

(b) By simple overdose.

In the stage of recovery death may result from:

(a) Progressive acidosis secondary to an acute septicæmia or from unrecognized diabetes.

Post-operative death occurs as a result of extensive protoplasmic poisoning effecting chiefly the liver and the kidneys.

Chloroform fatalities are not likely to occur if the following suggestions are adhered to:

If it is excluded in cases of acute septicæmia, acidosis and eclampsia. If it is invariably used with ether and not alone.

If the prone position is always adhered to. (Even the position advised for upper abdominal closure, page 43, should be avoided).

If fresh, newly opened specimens of chloroform are used.

If the mask is taken off the face during masseteric spasm.

If the corneal reflex is always retained, and a lustreless, dilated, fixed pupil never permitted.

If the rhythm of the respiration is maintained, and the

administration changed to straight ether upon the first sign of inexplicable shallowness or irregularity.

When the heart stops in chloroform it usually does so as a permanently damaged organ. Its dilation is toxic rather than mechanical, hence the difficulty of resuscitation. The blood in the coronary arteries must be squeezed out manually to relieve the condition. Massage of the heart through the diaphragm even though it calls for a special laparotomy should be done; for death under these circumstances is a most dreadful thing. Who would refuse a laparotomy upon himself in such an extremity? Transpleural pericardiotomy for massage of the heart may also be practised. There is some hope of success even though the heart has ceased to beat for ten minutes.

Lieb has suggested that the radial artery be immediately exposed. A cannula delivering the saline ordinarily employed for intravenous injections, at a height of four feet above the artery is introduced and when the flow into the artery actually begins, inject directly through the rubber tubing next to the cannula ten minims of adrenalin. This dose may be repeated four or five times.

Artificial respiration by negative and by positive ventilation should always be done (page 91).

THE SIGNS OF ANÆSTHESIA WHEN THE C. E. MIXTURE IS THE ANÆSTHETIC

When chloroform is used alone a condition of pseudo-relaxation or natural sleep is likely to follow especially in children. When the C. E. mixture is employed this does not occur.

The patient must invariably be anæsthetized in the prone position.

INDUCTION.—*Excitement* much less than when ether is used alone.

Rigidity of shorter duration.

Relaxation more easily accomplished.

Respiration regular, moderately deep, increased in rapidity, becoming stertorous. More shallow than with ether alone.

Eyes.—Globes rolling vertically or horizontally (as in ether). Pupils: A pin-point pupil is suggestive of light anæsthesia, otherwise pupils are like ether pupils. Corneal reflex: Active as in ether. Light reflex: Active as in ether.

Color.—Pallor characteristics of chloroform *per se*. With the C. E. mixture the color approaches that of ether. Pallor is suggestive of circulatory shock.

Relaxation.—Lid relaxation somewhat sooner than with ether. Masseteric relaxation somewhat sooner than with ether. If spasm occurs the anæsthetic should be discontinued at once and not resumed until the breathing is free.

Pulse.—The quality of the pulse must be carefully observed. Circulatory depression will give a small pulse of poor tension accompanied by pallor of the face.

MAINTENANCE.—*Respiration*.—Moderate stertor. More shallow and not so rapid as with ether alone. Regular rhythm *must* be preserved. The regularity of the respiration is the most important sign of chloroform anæsthesia, as failure of the respiration invariably precedes cardiac failure.

Color.—Pale. Cyanosis must not be tolerated. If the percentage of ether used be increased a better color will result.

Eyes.—Globes fixed, lustrous. Pupils about normal or slightly enlarged. Light reflex present, sluggish. Corneal reflex sluggish; should not be obliterated.

Relaxation.—Lid reflex absent. Masseteric relaxation present. General muscular relaxation characteristic.

Pulse.—A valuable guide. Its tension, size and rapidity should be constantly observed. As a symptom of the anæsthesia *per se* it is more important than in ether anæsthesia.

RECOVERY.—The rapidity of the return of the reflexes and later the return of consciousness will depend upon the level at which the stage of maintenance was carried and upon the length of the anæsthesia.

Respiration.—More shallow than with ether.

Color.—Pallor normal.

Eyes.—As with ether.

Muscles.—Generally relaxed.

Pulse.—Everything else being equal, not so good as in ether anæsthesia. Because of its action as protoplasmic poison, chloroform frequently gives rise to serious after-sickness, especially if the administration has been protracted. Where the administration is brief and the dose small, the after-effects are usually conspicuous by their absence.

Broadly speaking we may say that chloroform alone and chloroform given with ether is contraindicated in all cases, except:

(a) Acute pulmonary disease, pneumonia, etc., where N_2O cannot be had.

(b) Acute obstruction of the respiratory tract, Ludwig's angina, etc.

(c) As a preliminary to ether anæsthesia, when N_2O is not available.

TO REITERATE

Chloroform while ideal in efficiency is a dangerous poison. In the light of present day pathology, chloroform should cease to be used as an anæsthetic in obstetrics.

Combined with ether, chloroform is quite as efficient and less dangerous.

Chloroform kills if pushed in the face of masseteric spasm.

Delayed chloroform poisoning is a fact and argues for the complete replacement of the drug by safer anæsthetic agents.

Chloroform, if used at all, should be taken from a freshly opened receptacle.

The administration should invariably be performed in the prone position.

The mortality of chloroform is variably estimated as 1-1000, 1-3000.

CHAPTER VII

NITROUS OXIDE

NITROUS OXIDE, laughing-gas or nitrogen monoxide, is prepared by heating ammonium nitrate NH_4NO_3 , the result being N_2O and $2\text{H}_2\text{O}$.

Nitrous oxide is non-irritating to the respiratory tract, is possessed of a sweet taste and an odor like that of burnt sugar. The boiling-point of liquid N_2O is -90°C .

CONTAINERS.—Nitrous oxide is marketed as a liquid. It is stored in specially made vanadium steel cylinders, (steel which will not shatter but will simply split) whose capacity varies from 25 gallons to 3200 gallons. Fig. 95 shows various sizes of N_2O cylinders.

The pressure of the liquid gas enclosed in the cylinder is about 1000 lbs. to the square inch, at room temperature. If the cylinders be allowed to remain against a hot radiator for some time there is great danger of explosion from the increased pressure. The gas is drawn from the cylinders by means of a key which opens a complex valve in the cylinder head. These valves must be operated cautiously or the gas will escape with a roar which will badly frighten a waiting patient. When the operator has only one hand free to manipulate the valve the cylinder should be prevented from rotating on its base by some such device as is shown on page 209, Fig. 99. If the gas does not escape gradually when the valve is opened, it is best to work the valve back and forth before further opening. Occasionally the valve becomes frozen and will not permit of an even escape of the gas. If such a valve is widely opened

the pressure of the gas will suddenly blow away the obstruction with a loud explosion. The freezing of valves in the manner just mentioned is most likely to occur where a constant flow from the cylinders is sought, or when the cylinders are in the horizontal instead of the vertical position. Specially designed reducing valves, see Fig. 96, pre-

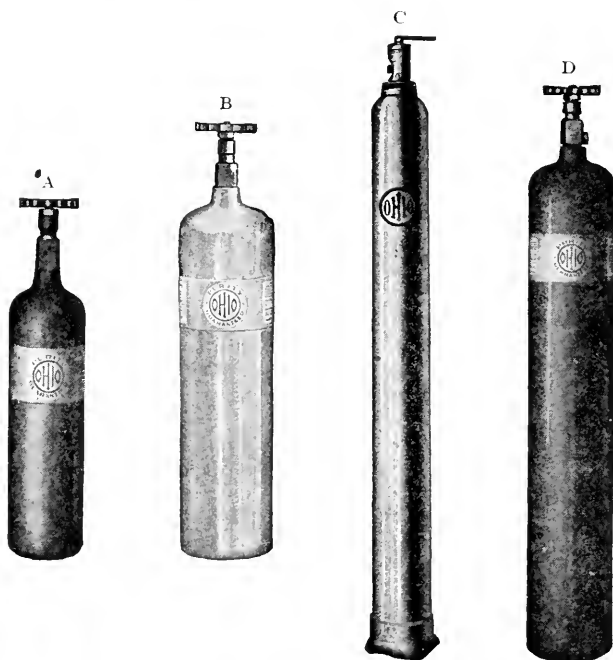

FIG. 95.—Various sizes N₂O tanks, 100–3200 gallons.

vent the possibility of the valves freezing and give a constant, even flow of gas at any desired rate.

ESTIMATING THE AMOUNT OF GAS IN A CYLINDER.—There is one way, and only one way, of estimating the amount of gas in a cylinder at any given time, and that is by weighing the cylinder. One will always find a label

pasted on the side of the cylinder (Fig. 97), on which is written:

The weight of the cylinder full of gas.

The weight of the cylinder empty.

The difference in these two weights represents the weight of the liquid N_2O in the cylinder. One ounce of N_2O is equal to four gallons of the gas at room temperature and pressure. The weight of the liquid N_2O in a full 100-gallon cylinder is therefore 25 ounces, or one pound nine ounces.

The 25-gallon cylinder is intended more particularly for private work where the gas is desired for induction only, the weight of the cylinder and contents being 2 pounds.

The 100-gallon cylinder is the size ordinarily used. This type of cylinder is somewhat more cumbersome, but more dependable than is the smaller size. The weight of the 100-gallon cylinder with contents is between eight and nine pounds.

The 250-gallon cylinders are intended for hospital use where the gas is freely employed not only for inducing anaesthesia but for maintaining it as well.

Some hospitals have become so enthusiastic over gas oxygen anaesthesia that they have installed small plants for the manufacture of the gas. At the Lakeside Hospital, Cleveland, a plant is in operation which supplies all the nitrous oxide used in the institution. Fig. 98 is a schematic drawing of this plant. Briefly the details of the manufacture are as follows:

Ammonium nitrate in quantities of forty pounds at a

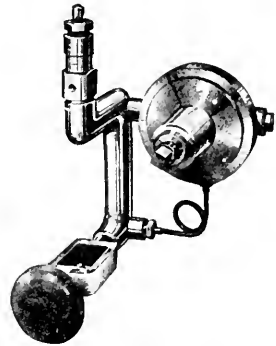

FIG. 96.—Reducing valve.

time is put into each of two aluminum retorts (a double system is used so that the plant will not be completely disabled in case of accident). This is heated to 400 degrees. The ammonium nitrate then breaks down into N_2O and H_2O , which mixture is cooled by a condensing coil and lead into wash bottles containing potassium permanganate.

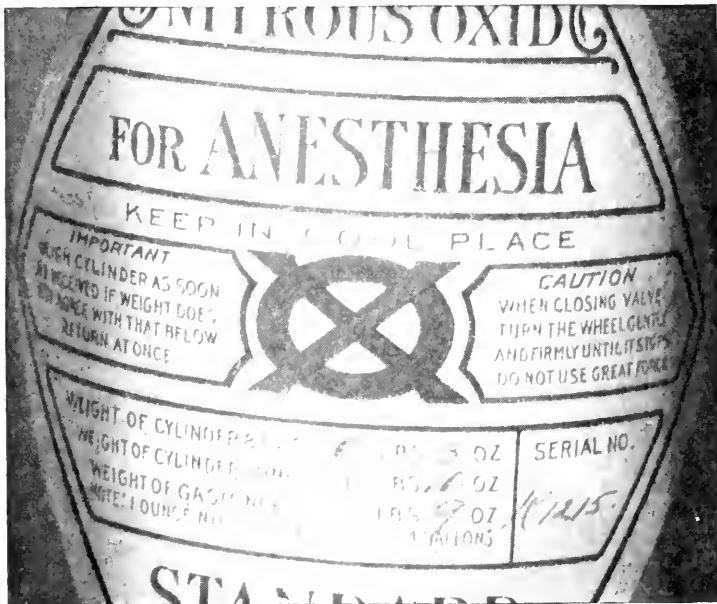

FIG. 97.—Label on N_2O cylinder.

This treatment removes the oxides. The gas is then fed into the bottom of so-called towers filled with coke. From the roof of these towers sodium hydrate is constantly sprayed. This treatment removes any HNO_3 which may be present. From the top of the tower the gas is conveyed once more to wash bottles containing sulphuric acid. This treatment removes any free alkali. The gas is then washed

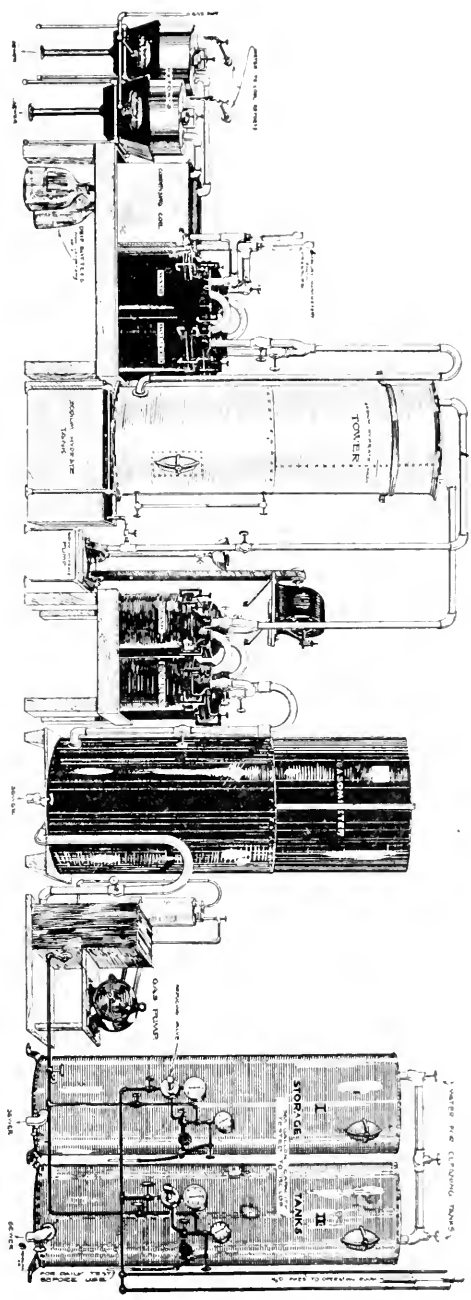

FIG. 98.—Plan of apparatus installed in Lakeside Hospital for the manufacture of nitrous oxide.
 (Courtesy Modern Hospital Magazine.)

by passing through fresh water and finally led to an ordinary gasometer. When a sufficient bulk of gas has here collected it is compressed by a pump either to liquefaction (for storage in small cylinders at a pressure of 1500 lbs. to the square inch), or for storage in large tanks at a comparatively low pressure, about 100 lbs., which is again reduced to about five pounds when it is piped to the operating room to be used as desired. When the gas reaches the operating room it passes through a gas meter which checks the amount consumed. From the meter it is conveyed through heavy rubber tubing to the apparatus which regulates the immediate flow to the face piece.

The cost of the N_2O is about two cents a gallon. When supplied in the 25-gallon cylinders it costs a little more; when in 250-gallon cylinders or larger the cost is somewhat less. The actual cost of manufacturing the gas is small once a satisfactory plant is established.

When buying the gas in small quantities, most manufacturers require a deposit covering the value of the cylinder, this deposit being returnable upon the receipt of the empty cylinder. The deposit required on the 100-gallon cylinder is about \$5.00 for each cylinder. Cylinders containing N_2O are usually painted black or blue while those containing oxygen are red or bronzed.

General Considerations.—With nitrous oxide alone one can obtain only an incomplete anaesthesia. The length of the administration is definitely limited by the physiological reaction of the organism to the drug. This reaction is as follows:

When N_2O is breathed to the total exclusion of air the patient experiences a sense of exhilaration. The extremities tingle and quickly grow numb. A necessity to breathe

or "besoin de respire" makes itself felt and the respiration automatically becomes full and deep. Consciousness is completely lost in less than half a minute in the ordinary case. This may be preceded, accompanied or immediately followed by flashes of light or loud sounds. Many patients experience no sensations whatever. If the administration is continued, air and oxygen being excluded, the patient rapidly becomes pallid, then blue or gray. The muscles of the face and limbs are thrown into convulsions known as *jactitation*, the respiratory movements become irregular and finally cease.

Immediately upon the admission of air the patient resumes normal respirations and color. Consciousness returns in less than two minutes.

Nitrous oxide has been administered hundreds of thousands of times to a degree of partial asphyxia. The procedure is indeed so common among dentists and occasionally among house officers that many men have come to look upon N_2O anaesthesia as implying lividity. It is true that in order to obtain the longest "available anaesthesia," it is necessary to push gas to an asphyxial degree where oxygen is not employed. Such a procedure is bad taste to say the least, and should not be practised. One should manage to get along with a shorter anaesthesia, reapply the mask or add oxygen to the mixture.

APPARATUS.—In order to obtain satisfactory results an absolutely air tight apparatus must be employed. The author's apparatus, Fig. 72, offers a type which is satisfactory.

ADMINISTRATION.—*When N_2O is Used to Induce Ether Anaesthesia.*—This administration is a routine procedure in most large hospitals. By rapidly and safely

destroying consciousness the patient is spared a most distressing experience. When we use N_2O for induction we accomplish two results:

1. We destroy consciousness and render the mucous membranes less sensitive to ether vapor.

2. We induce deep breathing which permits us to rapidly reach the desired concentration of ether in the patient's blood.

Since hearing is one of the last senses to disappear it is unwise to ask the patient whether or not he is asleep. A semi-conscious response may result.

The bag of the inhaler, usually of two gallon capacity, is filled with N_2O . The apparatus is applied and the patient is instructed to breathe out naturally through the mouth. The first three breaths may be spilled into the air by the expiratory valve, or rebreathing may be practised from the start. Where the latter method is employed results are entirely satisfactory and a single bag of gas is usually sufficient. As soon as the respirations have become full and deep, and evidently involuntary, ether is very cautiously added. If the rhythm of the breathing is affected it should be withheld for a few moments and then a second attempt made. If no hesitation occurs the ether may be rapidly increased. As soon as the patient has received a few breaths of ether, air is added a breath at a time. By this technic we have no blue or even dusky patients at our gas induction.

When Nitrous Oxide is Used Alone.—This type of administration is the method usually employed in dental work. When a tooth is to be extracted a mouth prop of cork or other material, made especially for the purpose, must be placed in position before the administration is

begun. The patient furthermore is ordinarily in a sitting position. The head must not be extended but should be on a straight line with the body. The administration is carried out precisely as in the case of N_2O induction for ether except that (oxygen not being used) we carry on the administration until slight jactitation of the arms or legs takes place.

If anæsthesia be then discontinued, a period of available anæsthesia amounting to about fifty seconds will result.

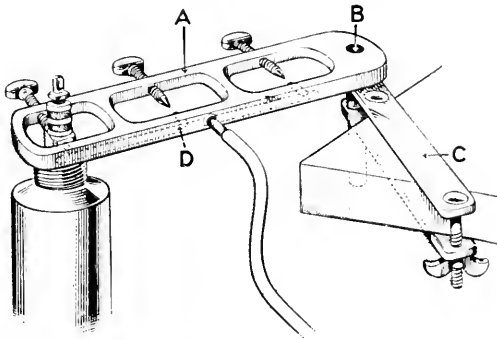

FIG. 99.—The author's cylinder holder. *A*, brass plate clamp for three one-hundred gallon cylinders; *B*, pin screwing into plate and fitting in socket of table clamp; *C*, table clamp; *D*, showing by dotted line the buried channel into which the gas of each cylinder empties, all leaving for face piece (not here shown) by a single rubber tubing.

During this period any painful procedure may be carried out, such as the extraction of teeth, opening of abscesses, etc. When a longer anæsthesia is desired with this method the face piece may be reapplied before complete consciousness returns. If the operation be elsewhere than in the mouth one breath of air should be administered after every four or five breaths of rebreathed N_2O . This will give a longer period of available anæsthesia, but does not result in anything like the smooth anæsthesia offered by the addition of oxygen gas to the mixture.

The author's clamp and cylinder holder consist of

two parts; the cylinder holder and a clamp for use when horizontal support may be had *i.e.*, table, etc.

The cylinder holder consists of two parts; a nickle-plated brass plate about two inches by ten inches and a threaded steel pin, which may be screwed into the plate and removed at will. The plate is drilled so as to receive three cylinders. Each hole has a nipple which receives the

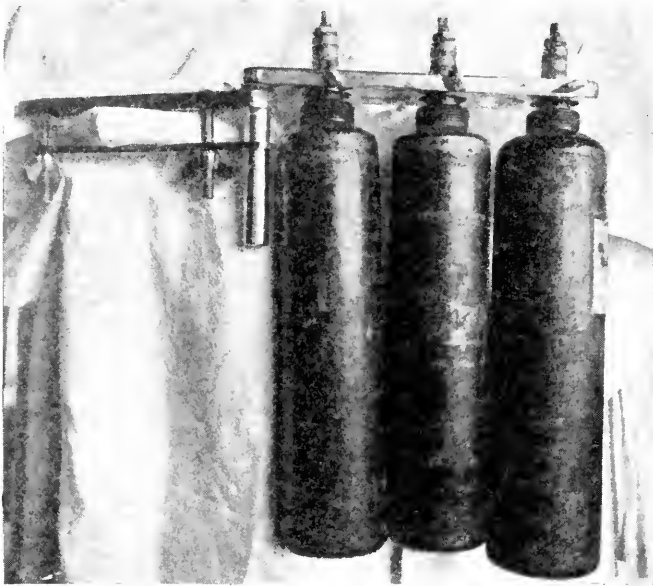

FIG. 100.—The author's cylinder holder clamped to the edge of a table.

cylinder and a thumb screw which holds the cylinder in place. This arrangement gives us the equivalent of three yolks sufficiently separated and rigidly united.

The nipple which receives each cylinder is pierced by a hole which opens into a common tunnel made in the plate. The exit from this tunnel is from a single vent, to which the rubber tubing leading to the face piece is attached. (Fig. 99.)

The plate, therefore, is the essential part of the apparatus and may be used alone. When the plate is used without the clamp (Fig. 101), three cylinders are fitted into the yolks and, thus united, are placed on their sides and used



FIG. 101.—Cylinders lying on a chair supported by the author's holder. Covered by a blanket these may be sat upon.

in this position. They may be placed on the anaesthetist's chair (Fig. 101), and when covered by a blanket form a comfortable seat.

The clamp consists of two flat plates of steel, drilled

with three holes each. Two of these holes receive bolts with their nuts, the third receives the pin which is screwed into the plate holding the cylinders. This clamp fits over the corner of a table. The weight of the cylinders does not injure the table if the clamp is evenly applied. Tables with

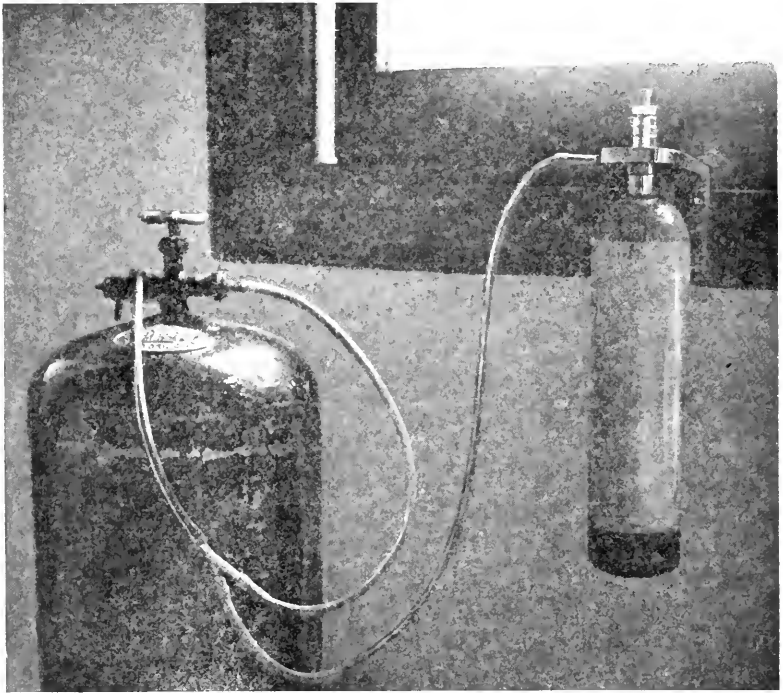

FIG. 102.—Cylinder clamp fastened to a window-sill.

glass tops are not affected, as the clamp covers a comparatively broad area. The author has used this clamp on the lightest weight, portable operating table (Fig. 100).

When the patient is to be moved from the stretcher to the operating table, the clamp is first fixed to the operating table. The anæsthetic is then started, either in the anæsthe-

tizing room or in the patient's bed, with the cylinders on their sides on a table or on a chair. When the operating room is reached, the pin of the cylinder holder is conveniently dropped into the holes of the horizontal plate. This transfer is done easily and quietly. Thus supported the cylinders are completely out of the way. They do not clutter up the floor space; are within easy reach of the anæsthetist and move with the movements of the operating table.

The custom of using nothing but a yolk, the cylinder standing on the floor, is not only dangerous because of the liability of the cylinders falling, but is wasteful of gas because the valves are often incompletely shut off.

CHAPTER VIII

NITROUS OXIDE OXYGEN ANÆSTHESIA

THIS mixture was first employed by Dr. E. Andrews of Chicago in 1868.

The containers for nitrous oxide are described on page 201. Oxygen is put out in cylinders containing 10 to 100 gallons. This gas may be compressed to the necessary small bulk without being liquified. Consequently there is little or no trouble with the valves of the oxygen tanks. These containers are usually painted red or bronzed to prevent the possibility of confusing them with N_2O cylinders, which are blue or black.

Both N_2O and oxygen tanks should be held rigidly by some sort of clamp or stand, in order that the administrator may manipulate the valves with one hand. The most simple clamp for this purpose is that shown on page 209. This clamp has proven of the greatest convenience to the author.

Two one-hundred gallon N_2O and one O cylinder may be carried loose in any handbag or dress suit case. At least two cylinders of nitrous oxide and one cylinder of oxygen should always be on hand. A simple and inexpensive stand and clamp for hospital use is shown in Fig. 103. This may be easily made by the hospital carpenter.

GENERAL CONSIDERATIONS

Perhaps no other type of anæsthesia at the present day has received as much attention as has the combination of gases popularly spoken of as gas oxygen.

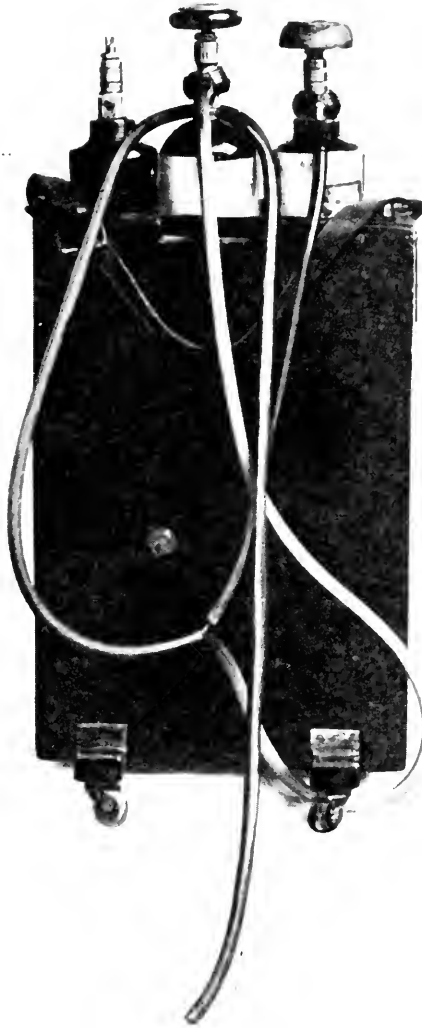

FIG. 103.—A simple wooden stand for three cylinders, suitable for hospital use.

In order to produce complete anæsthetic effects, N_2O must be delivered in a concentration of about 90 per cent. (The limits being 75 to 95 per cent.) If the additional

10 per cent. be replaced by air the patient will suffer from oxygen starvation (only $1/5$ of air being oxygen). If, however, the additional 10 per cent. be supplied by pure oxygen no such asphyxial result will follow. This condition holds in practice and explains the great difference seen in N_2O anaesthesia with air, and with oxygen. The difficulty then which confronts us in gas oxygen anaesthesia is the necessity of giving N_2O of sufficient concentration to produce anaesthesia, and at the same time supply adequate oxygenation.

The permissible variations take place within narrow limits. The anaesthesia is induced quickly and recovery takes place with astonishing rapidity.

The exceedingly evanescent effects of the anaesthetic make it by far the most difficult to administer. The anaesthetist must not only be constantly alert to the ordinary signs of anaesthesia, but he must have learned to distinguish shades of lightness and depth, which are of little consequence in anaesthesia by other agents, *i.e.*, ether, chloroform, etc. In the administration of gas oxygen the personal equation is without doubt the most important element.

Anaesthesia by nitrous oxide and oxygen is characterized by muscular rigidity of varying intensity. This rigidity is sometimes present in a complete and otherwise entirely satisfactory anaesthesia.

Some patients become very easily relaxed, others remain rigid no matter how much the anaesthetic is pushed. In this connection one should always remember that relaxation will never occur in the presence of cyanosis. If the desired result cannot be obtained without the presence of asphyxia then ether should be employed.

When nitrous oxide and oxygen is the anæsthetic employed the administrator must have the co-operation of the surgeon. The surgeon must unbend and the anæsthetist must rise to the occasion. Gas oxygen anæsthesia given by the sub-junior for the chief is very likely to be a failure.

With gas oxygen anæsthesia, more than with any other agent, we wish to go on record as insisting *that the patient be the criterion of the mixture delivered*. An anæsthetist, who will not give additional oxygen because his apparatus indicates a certain theoretical percentage, even though the patient be dying of asphyxia, certainly has no business to use this method. The author has seen a patient positively gray, crying out for oxygen by every possible sign, ignored by the anæsthetist, who was sure that all was safe because his apparatus showed such and such a percentage mixture in process of delivery. If preconceived and pre-arranged mixtures do not fit the needs of the patient, these must be thrown to the winds and suitable percentages employed.

The administration of gas and oxygen is gradually beginning to find its place. It has thrown off many of its early excrescences, such as positive pressure, heated vapors, and the like. Numberless apparatus of beautiful design and workmanship have died of complexity. Unskilful enthusiasts have fortunately lost interest, and are no longer forcing the method where it is counterindicated. Unfortunately, however, their blunders live on in the minds of the surgeons whom they chanced to assist. These experiences naturally give rise to prejudice against a method which is invaluable in its place. The administration of gas oxygen anæsthesia is intimately bound up with the present

day theories regarding the physiology of CO_2 gas. Since this consideration is deserving of more space than can be devoted in this section, the reader is referred to the chapter on "Carbon Dioxide and Rebreathing," page 296.

As the symptoms and signs of gas oxygen anæsthesia change with great rapidity, we must make use of an apparatus which will be sufficiently elastic to meet these changes of state as they appear. We must be able to produce N_2O effects or oxygen effects without delay. This result may be obtained by introducing both the gas and the oxygen proximal to the rebreathing bag, not at the bottom or distal end of the bag as is the usual custom. This principle may be applied to any apparatus. Fig. 72 shows its application in the apparatus used by the author. If this method be employed, should the patient show signs of 'coming out,' he can be given pure nitrous oxide at once. It is not necessary to wait for the contents of the rebreathing bag to discharge itself before the effects of the N_2O are felt. The same condition applies to the use of oxygen, immediate effects being secured upon turning on the gas.

The preliminary use of morphine and atropine is absolutely necessary for smooth gas oxygen anæsthesia.

THE SIGNS OF NITROUS OXIDE OXYGEN ANÆSTHESIA

COLOR.—The most important sign which we have in gas oxygen anæsthesia is the color. As with ether, duskiness is more liable to occur in the full-blooded, muscular individual. With ether, however, duskiness or cyanosis is usually directly dependent upon obstruction to the respiration, while with gas oxygen the condition frequently

depends upon the mixture of the gases offered to the patient. As has been pointed out under general considerations, complete anæsthesia and a normal color are obtained only when oxygen is employed. Those who are unfamiliar with gas oxygen anæsthesia, but who have had some experience with N_2O alone are very likely to purposely avoid a pink color fearing that the patient will "come out." A good color is especially desirable where the best relaxation is required. By pushing the N_2O to a degree of asphyxia, we not only do not overcome the rigidity but we superimpose the rigidity which accompanies imperfect oxygenation.

For the above reasons gas oxygen anæsthesia *per se* cannot be satisfactorily administered in the dark, *i.e.*, for nose and throat and for cystoscopic examinations. To employ this method under these conditions is to court failure and to risk the life of the patient.

The difficulty of properly judging the color in negroes excludes them from this method unless special indications are present.

The color of the patient is the only reliable index of the amount of oxygen which should be delivered. Any apparatus which does not accept the color of the patient as the criterion for the increase or the diminution of the oxygen supply is pernicious. Where such apparatus is employed as will deliver definite mixtures of N_2O and oxygen there must be some provision made for the immediate and copious admission of oxygen, should such treatment be found necessary. The margin of safety in gas oxygen anæsthesia is narrow, much more narrow than with ether and we cannot force our methods as we may occasionally do with the latter.

RESPIRATION.—Next to the color sign the respiration is the most important symptom of gas oxygen anæsthesia. During the early part of induction the respirations are very likely to be more rapid and deeper than normal. In some athletic patients this may amount to a hypercapnia, which will seriously disturb our induction. If the color is held under good control by sufficient oxygen, however, the breathing soon becomes less rapid and more shallow. *A soft snore is one of the first signs of good anæsthesia.* If this continues, and the respirations remain regular and somewhat deeper than normal, the preparation of the field of operation may be begun. A patient whose respirations are shallow and slow is not anæsthetized. Air has probably leaked in under the face piece and manipulations begun at this time will result in trouble. One has to “feel out” each patient and determine the approximate amount of oxygen which is required. The reaction of the respiration to vigorous “scrubbing up” is valuable. If the rhythm is not affected the incision may safely be made. During the *maintenance* of the anæsthetic the rhythm and the depth of the respirations, in conjunction with the color, form our chief guide as to the condition of the patient. The most important factor in the control of the respiration is the extent to which rebreathing is permitted. The stimulating effect of the CO₂ thus obtained is more active than where ether is the anæsthetic (see page 303).

RELAXATION.—With gas oxygen anæsthesia there is no true relaxation (see page 57). We expect and usually find more or less rigidity. The muscle tone is prone to persist. The impossibility of obtaining true muscular relaxation when gas oxygen is the anæsthetic is being borne in upon us by repeated failures where these gases

used alone are employed for abdominal work. The proper understanding of this rigidity by the surgeon and the anæsthetist will produce far more satisfactory results. The surgeon must realize the conditions under which he is obliged to work. The anæsthetist must realize the effects which he can produce, know when he has reached the limit and not persist in attempting the impossible at the expense of the patient and the surgeon.

If absolute relaxation is not essential, however, for the work in hand, gas oxygen anaesthesia is the ideal anaesthetic.

When induction has been completely brought about the lid reflex will be sluggish. Slight muscular movements of the limbs occasionally occur but as a rule the patient is absolutely quiet. Masseteric relaxation is never complete where the gases are employed without ether.

THE PULSE.—A slow pulse, fifty or less, under gas oxygen anaesthesia is a danger sign. Rebreathing should be diminished and the general condition of the patient carefully watched.

THE EYE SIGNS.—When anaesthesia is fully induced the globes are fixed, looking forward, downward or upward. (This sign is a guarantee that consciousness is lost.)

During the stage of maintenance the light reflex is active; the pupils are contracted; the conjunctivo palpebral reflex is active; the corneal reflex is always snappy.

THE POINT OF VIEW OF THE SURGEON, ANÆSTHETIST AND PATIENT IN REGARD TO GAS OXYGEN ANÆSTHESIA

The inconvenience of the surgeon adapting himself to an anaesthesia which does not yield complete muscular relaxation is certainly a serious objection. A man who has

been accustomed for years to the freedom of manipulation which ether affords when properly administered often finds it not only difficult but impractical to work with this anæsthetic. His attitude will be largely governed by his estimation of the value of gas oxygen in the recovery and convalescence of the patient.

THE ANÆSTHETIST.—Gas oxygen anæsthesia is by far the most difficult of all anæsthetics to administer. From the aspect of mere labor the method is unpopular for those who simply give “dope;” but for the man who can catch the spirit of the work, for the man who is interested in the *Art of Anæsthesia* the method is fascinating. The *recovery* in a case of gas oxygen anæsthesia properly administered is a triumph in itself.

THE PATIENT.—From the point of view of the patient the method is the most satisfactory yet devised. After-symptoms are conspicuous by their absence. The patient is scarcely ever sick although retching before consciousness returns is frequently seen. The disadvantage of a rapid return of consciousness is so far outbalanced by the benefits as to be of little consequence. To see a patient pass in two minutes from a stage of deep anæsthesia, in which he has been maintained for an hour or more, to complete consciousness is the marvel of present-day anæsthesia. And by consciousness we mean complete orientation: a consciousness which is capable of calmly surveying immediate past experiences and which fully understands existing conditions.

CHAPTER IX

NITROUS OXIDE OXYGEN ETHER ANÆSTHESIA

OWING to the objectionable muscular tone and rigidity which exist when gas oxygen is given *per se*, even though preceded by morphine and atropine, ether has been added to a greater or less degree.

The addition of small amounts of ether greatly increases the efficiency of the control. Owing to the deep and rapid respirations which obtain in gas oxygen anaesthesia it is quite easy to quickly introduce ether into the circulation. For the same reason ether once introduced and then stopped may be rapidly expelled by rebreathing gas and oxygen.

When ether is used in sufficient quantity at the proper time, we believe that the resulting anaesthesia is the best all-round method thus far devised. Where relaxation is necessary for the surgeon, we believe that ether should be freely used.

The author's method of choice in all adults where the operation does not involve the respiratory tract is as follows:

A preliminary hypodermic of morphine 1/6 and atropine 1/150 is given half an hour before the time set for operation. Anaesthesia is induced with gas alone or with gas oxygen. If the operation be intra-abdominal, a complete ether anaesthesia by the closed method is then obtained. The best relaxation is thus secured for exploration. If intestinal work is now to be done (the visceral peritoneum being insensitive) the ether is stopped and gas oxygen is used. If the gall-bladder be manipulated and

reflex rigidity ensue, ether may again be resorted to. At the beginning of the stage of recovery (see page 74), or when the peritoneum is closed, the ether is completely shut off and gas oxygen alone is used with very little rebreathing. By the time the operation is concluded (15–20 minutes) so much of the ether has been thrown off that there is scarcely any ether on the patient's breath. The return of consciousness is somewhat more delayed than with gas oxygen *per se*. The after-symptoms are conspicuous by their absence; persistent nausea and vomiting being very uncommon. (This method has frequently been employed by W. B. Gatch and others.)

Such a type of anæsthesia is ideal for the surgeon, more satisfactory for the anæsthetist and from the point of view of the patient approaches the ideal obtained by the use of gas oxygen alone.

Where ether is freely used it is not so essential to precede the administration by morphine and atropine. The effects are generally better when this treatment is followed, however, as the pain of the wound is minimized after the recovery of the patient, who often falls into a light sleep shortly after returning to bed.

By the employment of this method we believe that we obtain the best all-round results: rapid induction, complete relaxation, ready control, minimum after-effects, all with the greatest pathological safety to the patient.

THE ADMINISTRATION OF GAS OXYGEN ETHER ANÆSTHESIA

Two methods of administration are recognized:

1. The method of *intermittent flow* with rebreathing.
2. The method of *constant flow* (a) with rebreathing; (b) without rebreathing.

THE ADMINISTRATION OF GAS OXYGEN ETHER ANÆSTHESIA BY THE METHOD OF INTERMITTENT FLOW WITH REBREATHING

This method is the simpler of the two, consumes about half the amount of gases but is thought by some to give a somewhat more uneven level of maintenance. This method is the one introduced by W. Gatch, of Johns Hopkins Hospital, Baltimore. It requires the closest attention to detail as does, in fact, any method of gas oxygen anæsthesia. The author has enjoyed such success with this method that he is reluctant to replace it by others.

For apparatus used see Fig. 72.

The administration is conducted as follows:

The use of a preliminary hypodermic of morphine gr. $\frac{1}{4}$ and atropine gr. $\frac{1}{150}$, where not distinctly contraindicated, administered half an hour before anæsthesia, is absolutely essential to the success of nitrous oxide oxygen anæsthesia.

Hyoscine gr. $\frac{1}{100}$ and morphine gr. $\frac{1}{4}$ one hour before anæsthesia are an ideal medication in large muscular people. The disadvantages of hyoscine are largely counteracted by the employment of rebreathing.

It is difficult to overestimate the value of suggestion. A few words of sympathetic reassurance will do much towards improving the anæsthesia.

Experience only will give familiarity with the apparatus and the best results. If the nitrous oxide and oxygen cannot be made to work in a particular case, ether and oxygen may be given by the closed method.

Before starting the anæsthesia, take a piece of brass wire gauze 2 inches by 15 inches of a size known as 100 to the inch. Make a roll of this and place it under the ether

cup. Assemble the apparatus and by a little twist open the dome top. This cuts out the gas and ether chamber. Fill the bag slowly, by little spurts, with nitrous oxide. (Rapid filling causes frozen valves, cold gas and noise.) See that the needle valve is closed. Fill the ether cup. Place an ether can cork, with a string tied to it, on its side between the right front molars. Apply face piece, being particularly careful of the coaptation over the bridge of the nose and under cheek. Turn the head to the right side and instruct the patient to breathe naturally through the mouth. He is now getting only air. Push down air shut-off, and fasten by twist. The patient is now re-breathing nitrous oxide.

Open the expiratory valve and the patient will begin to empty the bag. Allow the bag to empty about two-thirds, release the expiratory valve and slowly run in more nitrous oxide and a little oxygen. The amount of oxygen can only be learned by experience. (Freedom from cyanosis with a light pink color.) The breathing will become deep and full. Presently a snoring will be heard. This is a sign of sufficient anæsthesia to start scrubbing up. In shallow breathers this may be delayed for some time. If the snore is absent after four or five minutes, cautiously drop in a little ether. If the respirations continue unchanged, there are good evidences that the patient is well anæsthetized. The conjunctivo-corneal reflexes are so active that in the early stages particularly they are of little assistance.

It is always well to test out the patient's reaction to ether, as later, particularly in abdominal operations, ether becomes an absolute necessity for the relaxation of the abdominal muscles.

The reaction of the respiration and any slight movement during the scrubbing up will give one a good idea of the depth of the anæsthesia. Just before the incision is made, particularly in abdominal cases, increase the percentage of nitrous oxide by half emptying the bag and refilling with pure nitrous oxide. At the same time have the patient under ether control. That is, have him where he will accept ether without spasm. If the respiration is not affected by the incision, if there is no slight movement of the extremities, and the surgeon does not complain of abdominal rigidity, stop the ether and carry the patient along on a faint pink color.

The respiration must be kept free. The use of the ether can cork now becomes apparent. In the case of obstruction, the teeth are sufficiently separated to admit of the easy introduction of the mouth gag in the upper or left side of the mouth. The throat tube may then be inserted without difficulty. This will be found of greatest assistance where indicated.

Should necessity arise, particularly in the early stages for considerable ether, one need not be alarmed, for this ether can be disposed of by stopping its administration early, using only gas and oxygen, and frequently emptying the bag. During the course of an even anæsthesia, when adding nitrous oxide and oxygen, it has been found more satisfactory not to empty the bag completely, but about half the bag at the time, this being repeated every two or three minutes. This does not make such a radical change in the mixture and never leaves the bag without carbon dioxide, the respiratory stimulant.

TROUBLE.—If one is in trouble and cannot determine just where the patient is, always give him the benefit of the

doubt, and stop the anæsthetic by opening the air vent. The contents of the bag are saved and ready for immediate reapplication. A few breaths of fresh air will change the picture completely and assure safety.

Respiration very deep and slow—usually too much rebreathing—empty the bag completely and refill.

Spasm of the respiration—stop ether completely, empty bag and give either air or oxygen, with a small percentage of nitrous oxide.

The mouth tube, if introduced under nitrous oxide and oxygen anæsthesia alone, is likely to cause irritation leading to respiratory spasm and possibly vomiting. Precede introduction by a little ether.

Shallow breathing under hyoscine—increase carbon dioxide by rebreathing.

Respirations deep and slow, growing shallower and remaining slow (5–10) a minute—suspect Cheyne Stokes respiration, stop the anæsthetic and look for trouble.

Rapid respiration, corneal reflex gone—probably too much ether.

Abdominal rigidity in the presence of deep ether—respiration obstructed or faulty position on the table.

Movement—profound gas anæsthesia, jactitation, or **anæsthesia incomplete.**

Pulse slower than normal—too much rebreathing, danger signal.

Blue—too large percentage of gas, respiratory obstruction, or both.

Bright-red—too much oxygen, valves in oxygen cylinder leaking, not shut off, or air leaking in about the face piece.

Don't expect a bright color in sallow people.

Don't give gas and oxygen to negroes.

Sweating: forehead warm—too much rebreathing.

Sweating: forehead cold—shock.

Increased hemorrhage of dark blood—respiratory obstruction alone or combined with too much rebreathing and nitrous oxide.

Swallowing—an indication of shallow anæsthesia, immediately precedes vomiting. Increase anæsthesia by gas or ether.

Vomiting—stop anæsthesia, allow reflexes to return and thereby provide against the aspiration of vomitus.

Immediately following an attack of vomiting the patient will return quickly and smoothly to the anæsthetic state.

Retching—increase gas and ether.

Sphincter dilation and gall-bladder work may show itself reflexly even in the presence of a sufficiently deep anæsthesia.

Vomiting may be purely morphine in origin.

Vomiting during recovery seems to depend upon the use of morphine, the preparation of the patient, the nature of the operation, the amount of ether used, and the degree to which rebreathing is carried.

Hysteria—use suggestion, and morphine combined with hyoscine.

Hiccough—rare in nitrous oxide oxygen anæsthesia; increase gas and rebreathing.

Headache during recovery—uneven anæsthesia with too much rebreathing.

Corneal reflex gone—usually deep anæsthesia.

Nystagmus and active corneal-lid reflex—shallow anæsthesia.

Hearing is acute during the early stages of nitrous oxide oxygen anæsthesia—be quiet.

THE ADMINISTRATION OF GAS OXYGEN ETHER ANÆSTHESIA BY THE METHOD OF CONSTANT FLOW WITH REBREATHING

A constant flow of gases with limited rebreathing is employed by A. H. Miller, of Providence, whose apparatus (Fig. 105), represents a popular type.

This apparatus is very ingenious, and simple in the work which it is expected to perform. The control is somewhat more ready and its employment does not require

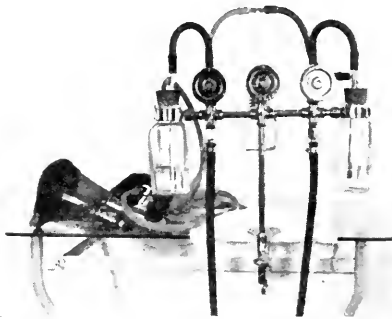

FIG. 104.—Face-piece and controlling valves.

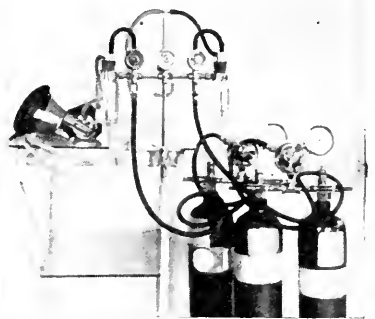

FIG. 105.—Face-piece, controlling valves, reducing valves and gas cylinders. (Courtesy Dr. Miller.)

so much mechanical sense on the part of the operator, as does the use of the intermittent flow.

The Nitrous Oxide Oxygen Apparatus devised by Dr. Albert H. Miller provides for a definite flow of nitrous oxide and of oxygen, each measured in litres per minute, to which may be added a definite flow of vaporized ether, measured in c.c. per minute.

Two reducing valves, one for nitrous oxide, and one for oxygen, are provided (Fig. 105).

Each reducing valve is mounted on a double yoke. Two cylinders of each gas, clamped into their yokes, set on the floor, not requiring any other support. The reducing valves provide a supply of nitrous oxide and of oxygen

at a constant pressure of 10 pounds to the square inch. The reducing valves are connected with the controlling valves by rubber tubing.

A frame, which supports the controlling valves and indicators, is provided with a clamp which serves to attach this part of the apparatus to a table or chair, doing away with the need for a stand (Fig. 104). On the frame are mounted three needle valves, two wash bottles, and a vaporizer of special construction. Oxygen passes through the valve and wash bottle on the left, and nitrous oxide through the valve and bottle on the right. The wash bottles serve as indicators of the flow of nitrous oxide and

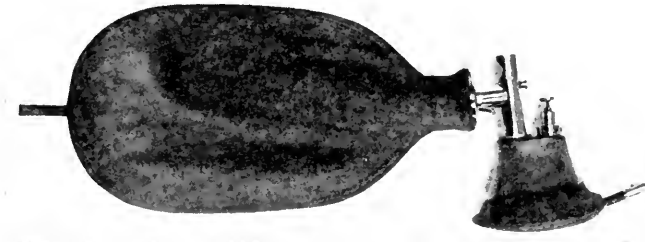

FIG. 106.—Face-piece, Miller apparatus. (Courtesy Dr. Miller.)

oxygen and also moisten the gases. Dials attached to the stems of the needle valves are calibrated in litres per minute of flow of nitrous oxide and of oxygen. The middle valve transmits a stream of nitrous oxide to a vaporizer which provides a constant percentage of ether vapor, varied by changing the rate of flow of the gas. One litre of gas vaporizes in this way five c.c. of ether per minute. This unit of the apparatus is connected with the inhaler by rubber tubing. The mixture of gases takes place close to the face piece.

The inhaler has a face piece of celluloid, with an inflatable rubber cushion or a cuff (Fig. 106). The air

valve on the inhaler is open when the gas is shut off, and vice versa. Consequently the face piece may be adjusted to the face, so that the patient becomes accustomed to breathing through it before the anæsthetic is introduced.



FIG. 107.—Miller apparatus. (Courtesy Dr. Miller.)

The expiratory valve is mounted on the inhaler in plain sight and is controlled by a spring of adjustable tension. The supply bag, which serves also as the rebreathing bag, is mounted on the face piece. The inhaler can be quickly separated into parts which may be sterilized in boiling water, dried inside and out, and readily reassembled. The wide mouth of the supply bag allows it to be turned inside out and dried. There are no concealed valves.

The first part of each expiration passes into the supply

bag and is rebreathed. The latter part escapes through the expiratory valve. The proportion of rebreathing varies inversely as the rate of flow of the mixture. This proportion can be closely estimated by noting the point in expiration at which the expiratory valve opens. Only enough tension on the expiratory valve is maintained to insure the filling of the supply bag before the valve opens.

This apparatus may be packed in a 24-inch suit case for transportation. It may be permanently attached to a table for hospital use (Fig. 107).

ADMINISTRATION OF GAS OXYGEN ANÆSTHESIA BY THE METHOD OF CONSTANT FLOW WITHOUT REBREATHING

This method is quite different from those methods which employ rebreathing. By this method an attempt has been made to administer N_2O and O on a basis of vapor tension reducing the matter to terms of ether by the percentage method (see page 64). Dr. K. Connell has arranged the chart shown in Fig. 108, in which the effect of different percentages of N_2O and O vapor are shown. Theoretically the method is ideal. Its limited employment thus far, however, compels us to reserve our opinion as to its practicability. In a general way we feel the necessity of being very near the patient when we administer gas and oxygen. Any method which tends to release us from this responsibility is likely to result in sudden disturbance, either of lightness or depth. Fig. 109 shows the regulator employed by Dr. Connell.

From a point of view of expense of administration the method of intermittent use is the least expensive, and the percentage method with the constant flow the most expensive.

PERCENTAGE IN TIDAL GASES	ZONE	DEPTH OF ANAESTHESIA	DEGREE OF ASPHYXIA	DEGREE OF RELAXATION	COLOR	UTILITY
NITROUS OXIDE						
100%	0%	COMPLETE	GREAT TO FATAL	TONIC & CLONIC SPASM	BLUE BLACK	EXTRACTION OF TEETH INCISION OF ABSCESS (USE CONDEMNED)
97%	3%	COMPLETE	CONSIDERABLE (DANGEROUS)	ASPHYXIAL RIGIDITY	DEEP CYANOSIS	
95%	5%	COMPLETE	PARTIAL (DANGEROUS)	PARTIAL	MODERATE CYANOSIS	
94%	6%	COMPLETE	PARTIAL	PARTIAL	SLIGHT CYANOSIS	INDUCTION
92%	8%	PARTIAL	SLIGHT	SLIGHT	FAINT CYANOSIS	ABDOMINAL SURGERY
89%	11%	PARTIAL	0	0	NORMAL "ROSE COLOR"	SURFACE SURGERY (OR ABDOMINAL SURGERY WITH SUPPLEMENTAL NARCOSIS)
86%	14%	PARTIAL COMPLETE ANALGESIA	0	0	NORMAL PINK	
84%	16%	ANALGESIA		0	PINK	
80%	20%	CONSCIOUS ANALGESIA				
50%	50%	CONSCIOUS ANALGESIA				
		EQUAL PARTS OF AIR ALLOWED			NORMAL	DENTISTRY

FIG. 108.—Zones of Nitrous Oxide Oxygen Anesthesia in normal man without supplemental narcosis.
(Courtesy Appleton Co., Johnson's Surgery.)

The intermittent flow is exemplified by the Gatch apparatus. In the appended chart showing the detailed administration of one hundred cases this apparatus was

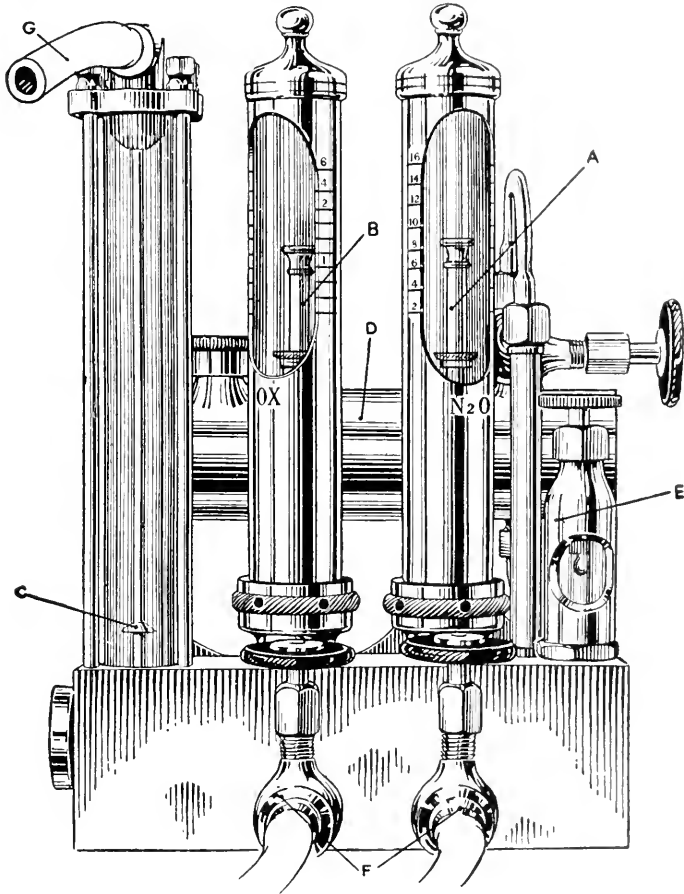

FIG. 109.—Connell nitrous oxide, oxygen, ether flow control. A, nitrous oxide instantaneous gas-flow gauge (piston type); B, oxygen gauge (piston type); C, parachute gauge, combined gases; D, ether tank; E, ether dropper; F, gas-control cocks; G, outlet. (Courtesy Dr. K. Connell, Appleton Co., Johnson's Surgery.)

employed. The scope of the method, the time of administration, and the amount of gas and O used are here clearly shown.

KEY TO CHART.

Age and Sex.—Explain themselves.

M&A.—Morphine and atropine.

Anæs.—Depth of anesthesia secured. Light (1), moderate (2), complete (3).

Excit.—Degree of excitement present. Absent (0), slight (1), moderate (2), marked (3).

Rel.—Degree of relaxation present. Little (1), moderate (2), complete (3).

Resp.—Character of the respiration. Irregular (Ir), deep (D), obstructed (Ob), shallow (S).

Col.—Color. Normal (N), flushed (F), cyanosis

predominating (C), alternatingly flushed and cyanotic (C&F).

T.—Time of administration.

Gas—Nitrous Oxide used in gallons.

O.—Oxygen used in gallons.

E.—Ether, dram (Dr.), ounces (Oz.).

Vom.—Vomiting.

Operation.—Is self-explanatory.

Results.—Failures are recorded as such.

Satisfactory Cases.—Surgeon's standpoint.

Successful Cases.—Anæsthetist's standpoint.

Complete Success.—The ideal cases.

Average cost per case without hospital discount, \$1.08 per hour and per case.

With discount, \$0.70 per hour and per case. No ether given in 19 per cent. of the 100 cases.

	Age	Sex	M&A	Anæs.	Excit.	Rel.	Resp.	Col.	T.	Gas	O.	E.	Vom.
1	60	Fe	0	1	3	1	Ir&D	F	20	0	4
2	21	M	0	3	0	3	R&D	N	20	Dr. 1	2
3	32	Fe	0	1	3	1	Ir&D	F	15	105	10	Dr. 1	2
4	26	M	0	1	3	1	Ir&D	F	15	Dr. 1	0
5	13	Fe	0	2	2	2	Ir&D	N	20	Dr. 1	4
6	33	Fe	0	2	2	2	R&D	N	15	0	0
7	26	M	0	2	1	2	R&D	N	20	Dr. 2	0
8	35	Fe	0	3	1	3	R&D	N	30	Dr. 2	0
9	35	Fe	1/6&1/150	1	1	1	Ir&D	C&F	15	95	11	Dr. 2	5
10	64	Fe	0	1	3	1	Ir&D	C	15	Dr. 3	0
11	49	Fe	1/6&1/150	3	1	2	R&D	N	1.30	0	0

12	23	Fe	1/6&1/150	2	1	1	Ir&Ob	N	1.00	32	8	Oz. 2	2
13	15	M	0	2	1	1	Ir&Ob	C	.50	Oz. 1	0
14	13	Fe	0	2	2	2	R&D	N	30	Dr. 1	5
15	17	Fe	1/8&1/300	2	2	2	IR&D	C	30	Dr. 1	5
16	42	Fe	1/8&1/300	3	3	3	R&D	N	1.55	70	16	Dr. 2	0
17	46	M	1/8&1/300	3	2	3	R&D	C	1.10	38	14	Dr. 2	0
18	18	Fe	0	2	3	2	Ir&D	N	.25	20	3	Dr. 2	2
19	3	Fe	0	2	2	1	R&D	N	15	28	1	Dr. 1	0
20	37	Fe	1/8&1/300	3	0	3	R&D	N	.50	27	11	Dr. 1	0
21	25	M	0	1	3	1	Ir&D	F	15	40	3	0	0
22	3	Fe	0	2	2	2	R&D	N	1.05	58	16	Dr. 1	2
23	56	Fe	1/4&1/150	3	0	3	R&D	N	1.17	18	11	Dr. 2	0
24	40	Fe	1/8&1/300	3	0	3	Ir&Ob	C	2.30	58	11	Dr. 2	0
25	29	M	1/4&1/150	3	1	2	R&Ob	C	1.45	50	9	Dr. 2	0
26	25	Fe	0	2	2	2	Ir&Ob	N	.20	16	3	Dr. 2	3
27	25	M	1/4&1/150	2	2	1	Ir&Ob	C	1.40	Oz. 2	0
28	45	M	1/4&1/150	3	1	3	R&D	N	1.15	68	9	Oz. 1	0
29	26	Fe	1/4&1/150	3	1	3	R&D	N	1.33	38	9	Dr. 2	0
30	35	Fe	1/4&1/150	3	0	3	Ir&Ob	C&F	3.42	54	45	Oz. 2	1
31	27	Fe	1/4&1/150	3	1	3	R&D	N	2.00	74	9	Oz. 1	0
32	36	Fe	1/4&1/150	3	1	3	R&D	N	1.20	34	9	Dr. 1	0
33	23	Fe	0	2	2	2	Ir&D	N	.30	24	9	Dr. 1	0
34	50	Fe	0	2	1	2	Ir&D	N	.50	24	9	Dr. 2	2
35	27	Fe	1/8&1/150	3	0	3	R&D	N	1.15	50	19	Oz. 2	0
36	63	Fe	0	3	1	3	R&D	N	1.15	40	14	Dr. 3	0
37	49	Fe	1/4&1/150	3	1	3	R&D	N	2.00	143	40	Dr. 3	0
38	23	M	1/4&1/150	2	3	1	Ir&Ob	C	1.00	Oz. 2	0
39	24	Fe	1/4&1/150	3	0	3	R&D	N	2.30	Dr. 2	0
40	35	Fe	1/4&1/150	3	0	3	R&D	N	.20	26	3	Dr. 2	0
41	30	Fe	1/4&1/150	2	2	2	Ir&D	N	.30	Oz. 1	2

Age	Sex	M&A	Anes. Excit. Rel.	Resp.	Col.	T.	Gas	O.	E.	Vom.	
42	Fe	0	3	0	3	R&D	N	15	8	1	0
43	Fe	1/4&1/150	3	0	3	R&D	N	1.40	36	11	Oz. 1
44	M	0	2	3	2	R&D	C&F	15	36	9	Dr. 2
45	Fe	1/4&1/150	3	0	3	R&D	C&F	1.32	66	22	Dr. 2
46	Fe	0	2	0	2	R&D	C	1.30	70	11	Dr. 4
47	Fe	1/4&1/150	3	2	2	R&D	C	2.00	70	11	Oz. 1
48	Fe	1/4&1/150	2	3	2	Ir&Ob	C	30	60	14	Dr. 2
49	Fe	1/4&1/150	2	3	2	Ir&D	N	20	60	14	Dr. 1
50	Fe	0	2	0	2	R&D	N	15	0	0	0
51	Fe	0	3	0	3	R&D	N	1.20	52	3	0
52	M	1/4&1/150	2	0	3	R&D	N	55	44	11	Dr. 2
53	Fe	1/4&1/150	3	0	3	R&D	N	1.25	50	6	Dr. 4
54	Fe	1/4&1/150	3	1	3	R&D	N	55	30	5	Dr. 2
55	Fe	1/4&1/150	3	1	2	Ir&Ob	C	1.20	104	28	Dr. 6
56	M	1/4&1/150	2	3	2	Ir&Ob	N	1.15	0	0	Oz. 1
57	M	1/4&1/150	2	2	2	R&Ob	C&F	38	38	8	Oz. 3
58	M	1/4&1/150	3	2	3	R&D	C&F	3.23	96	35	Oz. 4
59	Fe	1/4&1/150	2	0	1	Ir&Ob	C	1.10	94	17	Oz. 2
60	M	1/4&1/150	3	2	3	Ir&D	C	1.20	0	0	Dr. 4
61	Fe	0	3	0	3	R&D	N	20	14	1	0
62	M	1/4&1/150	2	2	2	Ir&Ob	N	1.35	80	17	Oz. 2
63	Fe	1/4&1/150	3	0	3	R&D	N	1.00	38	5	Dr. 4
64	Fe	1/4&1/150	2	3	2	Ir&Ob	C	2.18	70	35	Oz. 6
65	Fe	1/4&1/150	2	0	2	R&D	F	1.11	54	8	Oz. 2
66	Fe	1/4&1/150	3	1	3	Ir&D	N	1.35	66	11	Oz. 1
67	Fe	1/4&1/150	3	1	3	Ir&Ob	C	1.55	72	8	Oz. 2
68	Fe	1/4&1/150	3	0	3	R&D	N	25	22	2	Dr. 1
69	M	0	2	3	1	Ir&D	N	15	14	1	0
70	Fe	1/4&1/150	3	3	2	R&D	N	1.00	48	6	Dr. 10

71	31	M	1/4&1/150	1	3	1	Ir&Ob	C&F	10	7	3	0	0
72	49	Fe	1/4&1/150	3	1	3	R&D	N	2.05	55	16	Dr. 2	0
73	45	Fe	1/4&1/150	3	1	3	Ir&Ob	N	2.15	65	11	Dr. 2	0
74	28	Fe	0	3	0	3	R&D	N	30	26	4	0	0
75	30	M	1/4&1/150	3	2	3	R&Ob	C	50	50	22	Oz. 2	0
76	15	M	1/8&1/300	3	0	2	R&D	N	1.00	24	5	0	0
77	21	Fe	1/8&1/300	3	0	2	Ir&Ob	C&F	1.17	50	14	Dr. 1	0
78	28	Fe	1/4&1/150	3	0	3	R&D	N	1.08	46	6	Dr. 4	0
79	35	Fe	0	1	3	2	Ir&Ob	C&F	40	32	5	Dr. 5	0
80	24	Fe	1/4&1/150	2	2	2	Ir&Ob	N	1.15	42	11	Oz. 1	0
81	50	M	1/4&1/150	3	0	2	Ir&Ob	N	2.15	72	40	Oz. 4	0
82	24	M	1/4&1/150	3	0	2	R&D	N	40	48	2	0	0
83	12	Fe	1/8&1/300	3	0	2	R&D	N	20	10	2	Oz. 3	0
84	9	M	0	2	1	2	R&D	N	30	20	3	0	0
85	50	M	1/4&1/150	2	1	3	R&D	N	42	38	5	Dr. 3	0
86	52	M	0	2	1	2	R&D	N	20	20	2	0	0
87	26	Fe	1/4&1/150	2	2	1	Ir&D	N
88	30	Fe	0	2	2	2	Ir&D	N	1.00	38	10	Oz. 1	1
89	25	M	1/4&1/150	2	1	2	R&D	N	1.55	94	11	Oz. 2	0
90	43	Fe	0	2	3	1	Ir&D	N	40	28	3	Oz. 2	0
91	45	Fe	1/4&1/150	3	1	3	Ir&S	N	2.50	104	47	Oz. 2	0
92	55	Fe	0	3	1	3	R&D	N	1.10	46	11	Dr. 1	0
93	25	M	1/4&1/150	3	2	3	R&D	N	2.15	58	10	Oz. 1	0
94	28	M	1/4&1/150	2	2	2	Ir&D	C&F
95	70	Fe	0	3	0	3	R&D	N	25	42	5	0	0
96	36	Fe	0	3	0	3	R&D	N	50	44	11	0	0
97	47	M	0	3	0	3	R&S	N	1.00	46	44	0	0
98	6	Fe	0	3	1	3	R&D	N	1.00	32	8	0	0
99	18	Fe	1/4&1/150	3	1	2	Ir&D	N	50	34	8	Oz. 2	0
100	47	Fe	1/4&1/150	3	1	2	R&D	N	50	30	8	Dr. 4	1

SUMMARY OF CHART.

Youngest 3, oldest 70; 76 per cent. females.

Morphine and atropine in 63 per cent.

Total time of administration 103 hours.

Nitrous oxide used, 3470 gals.; O used 768 gals.

<i>Operation.</i>	<i>Results.</i>
1 Joint examination	Failure.
2 Joint examination.	Complete success.
3 Laparotomy.	Failure.
4 Hernia	Failure.
5 Suturing lacerated lip.	Satisfactory.
6 Appendectomy.	Failure.
7 Incision, T.B. abscess of thigh.	Success.
8 Secondary appendectomy.	Complete success.
9 Hysterectomy.	Failure.
10 Femoral hernia.	Failure.
11 Cauterization of cancerous cervix.	Complete success.
12 Appendectomy.	Satisfactory.
13 Appendectomy.	Success.
14 Sebaceous cyst of neck.	Satisfactory.
15 Glands of neck.	Satisfactory.
16 Left nephropexy, salpingo ovariectomy.	Success.
17 Appendectomy.	Satisfactory.
18 Needle in hand.	Satisfactory.
19 Foreign body in ear.	Satisfactory.
20 Pus appendix.	Complete success.
21 Fracture of humerus.	Failure.
22 Glands of neck.	Success.
23 Int. obstruction, pyo salpinx.	Complete success.
24 Hysterectomy.	Satisfactory.
25 Trephine of fractured skull.	Satisfactory.
26 Needle in thumb.	Satisfactory.
27 Exploratory laparotomy.	Satisfactory.
28 Fracture of tibia, set.	Complete success.
29 Curettage, trachelorrhaphy laparotomy.	Complete success.
30 Hysterectomy.	Complete success.
31 Curettage, trachelorrhaphy, perineum appen- dectomy and ant. suspension.	Complete success.
32 Removal of cyst of broad ligament.	Complete success.
33 Removal of axillary glands.	Complete success.
34 Needle in foot.	Complete success.
35 High forceps.	Complete success.

<i>Operation.</i>	<i>Results.</i>
36 Modified Gilliam operation.	Complete success.
37 Laparotomy.	Complete success.
38 Appendicitis.	Failure.
39 Appendectomy, double salpingo ovariectomy and curettage.	Complete success.
40 Curettage.	Complete success.
41 Curettage.	Satisfactory.
42 Injured joint.	Complete success.
43 Exploratory laparotomy.	Success.
44 Cellulitis of the face.	Satisfactory.
45 Cholecystostomy.	Complete success.
46 Glands of the neck.	Satisfactory.
47 Salpingo ovariectomy, appendectomy.	Satisfactory.
48 Curettage.	Satisfactory.
49 Posterior colpotomy.	Satisfactory.
50 Dressing.	Complete success.
51 Lacerated perineum.	Complete success.
52 Resection of stump.	Complete success.
53 Inguinal hernia.	Complete success.
54 Curettage and trachelorrhaphy.	Complete success.
55 Perineum and ant. suspension.	Success.
56 Pus appendix.	Satisfactory.
57 Pus appendix.	Satisfactory.
58 Inguinal hernia.	Complete success.
59 Appendectomy.	Failure.
60 Hernia.	Success.
61 Curettage.	Complete success.
62 Hernia.	Satisfactory.
63 Removal of ovarian cyst.	Complete success.
64 Ventral suspension.	Satisfactory.
65 Appendectomy.	Satisfactory.
66 Secondary cholecystostomy.	Success.
67 Irreducible umbilical hernia.	Complete success.
68 Rectal fissure.	Complete success.
69 Tonsils and adenoids.	Satisfactory.
70 Appendectomy.	Satisfactory.
71 Laparotomy.	Failure.
72 Hysterectomy.	Complete success.
73 Pyo salpinx and appendicitis.	Complete success.
74 Curettage.	Complete success.
75 Hemorrhoids.	Success.
76 Pus appendix.	Complete success.
77 Curettage and exploratory laparotomy	Died.

<i>Operation.</i>	<i>Results.</i>
78 Laparotomy.	Complete success.
79 Curettage.	Satisfactory.
80 Curettage.	Satisfactory.
81 Intestinal obstruction.	Success.
82 Glands of neck.	Complete success.
83 Tonsils and adenoids.	Complete success.
84 Secondary for mastoid.	Complete success.
85 Radical op. for hydrocele.	Complete success.
86 Sebaceous cyst of forehead.	Complete success.
87 Appendectomy.	Failure.
88 Curettage.	Success.
89 Wiring fractured humerus.	Complete success.
90 Cauterization of the vulva, condyloma.	Satisfactory.
91 Hysterectomy, vaginal and abdominal.	Complete success.
92 Amputation of the breast.	Complete success.
93 Laparotomy.	Success.
94 Urethral dilatation.	Failure.
95 Opening sinus in arm.	Complete success.
96 Posterior colpotomy and abdominal section.	Complete success.
97 Intestinal obstruction.	Complete success.
98 Appendectomy.	Success.
99 Appendectomy.	Success.
100 Exploratory laparotomy.	Success.*

In a paper read before the Westchester County Medical Society, January 16, 1912, and published in the *NEW YORK STATE JOURNAL OF MEDICINE* for April, a series of one hundred cases of nitrous oxide oxygen anæsthesia were reported. Case No. 77 is reported to have died. Space did not permit of a detailed report of this case, but as deaths on the table while using nitrous oxide oxygen as an anæsthetic are of importance and interest at the present time, this report perhaps deserves more than a passing notice.

It is an open question as to whether or not this death occurred as the result of the use of nitrous oxide oxygen ether as an anæsthetic. The reader may judge for himself from the following facts:

Patient, a large, fleshy colored woman, aged 25. She had been bleeding almost continuously for a period of four or five months. Two years ago her right tube and ovary were removed. Before the operation a tentative diagnosis of uterine fibroid was made. The enlargement upon the body of the uterus which gave rise to this diagnosis proved later to be occasioned by adhesions about the proximal end of the tube, which had been tied off by a heavy silk ligature. No fibroid of the uterus or appendages could be found.

The patient was reported to have had an attack of syncope shortly before the operation. About twenty minutes before being anæsthetized she received

* Reprinted from *New York State Medical Journal*.

$\frac{1}{4}$ gr. morphine and $\frac{1}{150}$ gr. atropine hypodermically. When she entered the operating room she was in a very nervous frame of mind. The examination of her heart had been negative. The apex beat, however, was heaving and forceful. Anæsthesia was induced at 4 P.M. The patient went under quietly. As there was evidence of shallowness in her anæsthetic state ether was given to the extent of about one dram. Shortly after this the respirations were obstructed by masseteric spasm. The cervix was dilated and the uterus curetted. The respirations were then irregular and obstructed. The operator made the remark that the blood looked dark (the black skin made it difficult to properly judge the normal color). The ether and gas were stopped and a large proportion of oxygen was given. The patient was replaced in the dorsal position and the breathing immediately improved. When the abdominal incision was made the tissues looked extremely anæmic. Moderate muscular relaxation was present. The pulse was of good quality but variable, rapidity about 120. The corneal reflex was active and the pupils were contracted. During the course of the operation (which occupied 1.17 from the induction to the cessation of the respiration), the breathing was irregular, slowing to from three to four a minute and then increasing in rapidity. While the abdominal work was being done it was thought that this condition was due to pulling upon the viscera, there being an absence of signs of deep anæsthesia. Toward the end of the operation the cheeks and forehead became cold, as though the patient was suffering from shock. This condition was not warranted by the nature of the operation or the loss of blood. The mask was removed several times from the face and the patient rapidly came out. When the mask was replaced a large proportion of oxygen was given. Several times the corneal reflex was lost, to reappear again almost immediately. The breathing improved as the operation was concluded. When the patient was raised from the Trendelenburg it improved markedly. At this time the operator said: "She is pretty rigid." As the patient had been behaving badly no ether was given her, but oxygen instead, in the hope that the rigidity was of an asphyxial nature. While the old scar in the skin was being cut out the patient showed the effects of peripheral stimulation by breathing more deeply and more rapidly. The corneal reflex was active and the pupils were contracted. Suddenly irregular breathing, simulating that which had frequently occurred during the operation, again made its appearance. The patient made a low crowing sound as though about to come out. This was followed by slow, deep respirations. The respirations ceased. As this had occurred several times before, it was not in itself particularly disturbing. The pulse could no longer be felt, however, the pupils dilated suddenly and the corneal reflex completely disappeared. In the presence of these signs artificial respiration was immediately begun, accompanied by every possible form of stimulation. The attempted resuscitation was entirely unsuccessful.

The following facts were noted:

The slow pulse of asphyxial rebreathing did not occur.

Patient was in a light anæsthetic state when she died.

She showed evidence of shock some twenty minutes before.

The color was difficult to make out, but seemed satisfactory.

There was masseteric spasm with ether. This did not appear to seriously hamper the respirations, but it showed a tendency to persist even when air and oxygen was given in abundance.

The rigidity appeared to be due to shallow anæsthesia, not to asphyxia.

Death is thought to have been due to cardiac failure, the remote cause being previous protracted hemorrhages, the immediate cause being the strain thrown upon the vasomotor system by respiratory obstruction incident to a badly accepted anæsthetic.

ANÆSTHESIA BY ANOCI ASSOCIATION OR THE COMBINED USE OF LOCAL ANÆSTHESIA AND GAS OXYGEN ETHER ANÆSTHESIA

A visitor at a clinic where complete anoci association is used cannot fail to catch the remarkable spirit of co-operation which pervades the operating personnel. All things are made to bend to the welfare of the patient. Suggestive therapeutics so valuable as a preliminary treatment to the anæsthetic are here employed to the fullest extent.

The harmonious blending of suggestion and preliminary medication before the induction of the anæsthetic; gentleness in voice and touch combined with an absolutely essential and skilful local anæsthesia of the skin during the stage of induction; the continued use of complete nerve blocking and care in the manipulation of the tissues during the stage of maintenance, work together for a stage of recovery which is ideal. It is the remarkable ensemble which produces the result seen with so much pleasure.

There is nothing very unusual about the administration of the gas oxygen *per se*. It is but complementary to more important elements. Briefly such an administration may be described as *a skilful and complete local anæsthesia, well fortified by preliminary medication, upon*

which is superimposed gas oxygen anæsthesia, the essential purpose of which is to destroy consciousness.

Place the gas oxygen anæsthesia *first*, making the local anæsthesia and preliminary medication of *secondary* importance and the result is certain failure.

The nitrous oxide and oxygen (we can scarcely say the anæsthetic) is often administered by nurses especially trained to this particular type of work. Since the anæsthesia does not proceed to relaxation and consequent respiratory obstruction by the falling back of the tongue, little difficulty is experienced in the anæsthetization. The chief requirement being to control the color. This is easily accomplished by simple and convenient valves in the machine used.

An hour before operation the patient receives morphine grs. $\frac{1}{6}$ and scopolamine grs. $\frac{1}{200}$. If he or she be an epileptic the dose of morphine is increased to $\frac{1}{4}$ grs., the amount of scopolamine remaining unchanged.

Cases of exophthalmic goitre are anæsthetized in their beds and carefully transported to the operating room. All other cases are anæsthetized *on the operating table in the operating room*. Before anæsthesia is commenced the anæsthetist speaks a few words to the patient in order to quell any anxiety which may be present. Most of the cases, however, are well under the influence of their preliminary medication by this time. Nitrous oxide is then made to flow through the face piece and down over the face of the patient before the mask is actually applied. Cotton is placed over the bridge of the nose, and on the cheeks corresponding to the point of contact of the mask when applied. A little cotton is also placed about the respiratory valve to protect the anæsthetist from the ex-

pirations of the patient. An ordinary hand towel is placed under the nape of the neck, the ends lying free. The time of induction varies from ten to fifteen minutes. The period of excitement is seldom seen. Before consciousness is lost no restraint is applied, but four attendants, an assistant anæsthetist, an orderly and two nurses stand by until anæsthesia is well under way. When consciousness is lost the arms are fastened to the table by wristlets and a strap is thrown over the knees. These restraining measures are most valuable in case of lightness during maintenance. The free ends of the towel lying under the neck are now brought forward together over the face piece and clamped in such a way as to include the latter and hold it firmly against the patient. Cotton is stuffed into the space between the face and the towel. By this arrangement both hands of the anæsthetist are free. (While such a fixation of the face piece would be unwise with ordinary ether anæsthesia, because of the pharyngeal relaxation obtaining, in this very light form of maintenance, the retained tonicity of the pharyngeal structures prevents the obstruction which would otherwise occur.) If the operation is to be on the neck, a covering, half sheet, half gauze, is fastened to the patient's chin, the gauze portion being thrown over the head of the anæsthetist. Such a covering is welcomed by the anæsthetist since it permits of much needed ventilation.

The respiration being tranquil and the color good, the skin to be incised is carefully and completely infiltrated with a solution of novocaine 1/400. This infiltration, or nerve blocking is conscientiously done with every tissue encountered, particular care being exercised to inject the peritoneum and the pedicels of the pelvic organs, gall-

bladder, etc. A failure to completely block the field of operation shows itself in changes in the patient's respiration, moaning, or slight movements, followed by rigidity. Retractors are seldom employed and the utmost gentleness is exercised in handling the tissues.

The administration of the gas and oxygen is of secondary importance; we find that the chief guide to be followed is the color. *The patient is the index as to the mixture which he receives*: he is not forced to accept a theoretical mixture. The nitrous oxide and oxygen are usually made to flow continuously, partial rebreathing only being permitted. The limitation of the rebreathing causes the respirations to be much more shallow than when rebreathing is freely employed. When a constant flow is used N_2O is delivered at a rate of about one hundred gallons an hour, the oxygen varying from five to twenty-five an hour.

The anæsthetist is constantly attended and assisted by a pupil nurse who is well instructed as to her duties.

There being no confusion in the status of the anæsthetist, as is frequently the case when the junior interne occupies this position, the anæsthesia proceeds without annoying instructions from the senior house officers. The surgeon, appreciating the fact that the anæsthesia is primarily a local and secondarily a general anæsthesia, interprets undesirable rigidity as due to incomplete nerve block rather than to the faulty administration of the gas and oxygen. In cases of exophthalmic goitre the administration of the gas and oxygen is continued until the patient has been returned to bed and is propped up with pillows. Abundant assistance is furnished for the transportation. (As many as five persons assist in the transportation of goitre cases from the place of operation to the room.)

The addition of ether in the early periods of induction simplifies the administration to a considerable degree. Ether in small quantities is not infrequently used in this fashion. Since it is seldom employed during recovery, however, it is soon rinsed out by the pure gas oxygen anæsthesia which follows and no ether effects are apparent. The free use of ether would complicate rather than assist the anæsthesia, for undesirable relaxation of the tongue and pharyngeal structures would follow, possibly requiring the removal of the face piece for relief.

The recovery from the anæsthesia is rapid and complete. Most patients retch once or twice before consciousness returns.

B. LOCAL ANÆSTHESIA

LOCAL anæsthesia is that type of anæsthesia which involves only the peripheral nervous system. It may be brought about by:

(a) Freezing.

(b) Pressure on the nerve trunks or by pressure producing ischæmia of the part.

(c) By regional intravenous injections of novocaine.

(d) By the injection of novocaine or some other drug into the skin or deeper tissues.

CHAPTER X

UNUSUAL METHODS

I. LOCAL ANÆSTHESIA BY FREEZING

THE effect of extreme cold applied locally is to produce a loss of sensation of the part. This is a very common experience following exposure to very low temperatures. One's ears, for example, when first exposed to zero weather at first tingle, then become painful. As the effect of the cold increases, the pain disappears and the sensation is lost. The parts are then more or less anæsthetic. They can be rubbed or pinched or cut without pain. As thawing is gradually accomplished, the pain returns with greatly increased severity. Even after complete recovery there may be occasional intervals of transient pain familiarly known as chilblains.

Freezing may be artificially brought about by the use of the *ethyl chloride spray*. The rate of evaporation of this liquid is so rapid that the surface temperature is brought below the freezing point and becomes actually

frozen. The freezing process appears to act as a terminal anæsthetic and is complete in a few seconds. The best results are obtained by holding the nozzle of the spray about ten inches from the skin and by blowing gently upon the surface to assist the evaporation. Freezing is indicated by the blanching of the part exposed to the action of the spray. When cut with a knife the tissues will be found to be hard and somewhat brittle. The degree of anæsthesia produced by this method is variable. It depends largely upon the degree to which the skin is frozen. As is the case with the ordinary freezing, due to exposure, the recovery is painful, and if the freezing has been protracted extensive sloughing is apt to follow.

II. LOCAL ANÆSTHESIA BY PRESSURE

Pressure on nerve trunks produces a loss of sensation in the tissue supplied by the compressed nerve. This condition often occurs accidentally when pressure is allowed to act upon a superficial nerve. Muculospiral paralysis, occurring when an anæsthetized patient's arm is allowed to hang over edge of the table (Fig. 23), produces this effect.

Local anæsthesia may be brought about by pressure interfering with the circulation. Who has not awakened after a long sleep and been shocked to find a strange, cold, motionless hand in the bed beside him, and who will forget the sense of relief when this strange hand proves to be his own?

Artificially these effects have been produced by pressure on the nerves supplying parts to be operated upon. The practice is very ancient in its usage but the pain directly occasioned by the pressure is so annoying that the method is of little practical value.

A certain degree of anæsthesia may be brought about artificially by the employment of an Esmarch bandage, (Fig. 110). This consists of a long, rubber band some three inches wide and six feet long, which by being tightly wound about the limb beginning at the distal end produces a bloodless or ischæmic condition. One may profitably bear

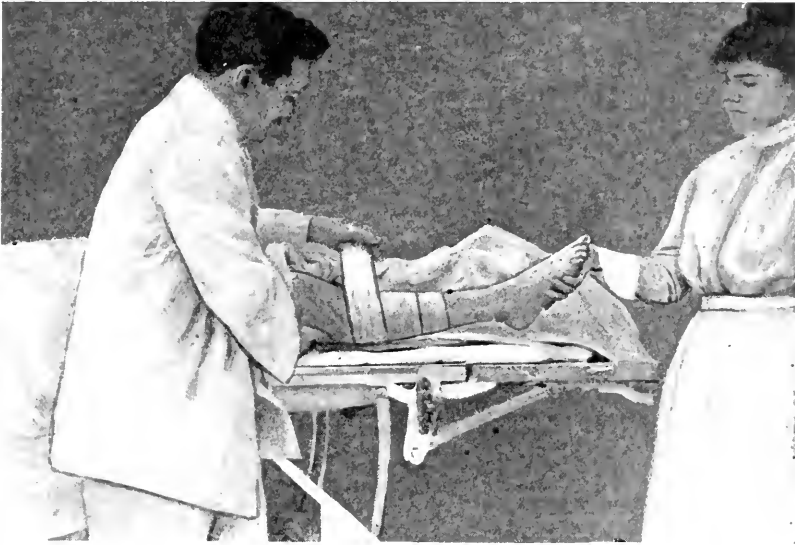

FIG. 110.—Esmarch bandage.

in mind this fact when a general anæsthetic is being given for an amputation of a limb, which has been previously rendered ischæmic by the use of an Esmarch bandage.

III. LOCAL ANÆSTHESIA BY REGIONAL INTRA- VENOUS INJECTIONS OF NOVOCAINE

This method is applicable to all operations upon the extremities. The most important factor in the technic is to produce a completely ischæmic condition of the limb.

Our object in this method is first to empty the veins by the proper use of rubber bandages; secondly to fill these emptied veins with a solution of 5 per cent. novocaine. By this procedure we bring not only the superficial but also the deep structures under the influence of the anæsthetizing solution.

The cephalic or basilic vein in the arm, or the internal saphenous in the leg, should be marked out.

With the limb raised an Esmarch bandage is tightly applied from the fingers or toes to a point above the site of the operation. Where this bandage ends, a second, broad Esmarch is applied. This is known as the proximal bandage (being nearest the body of patient).

The first bandage, that which was used to produce ischæmia, is slowly unwound: the unwinding naturally beginning where it ceased, *i.e.*, next to the proximal bandage and *not* at the fingers or toes. If some part, say the middle third of the forearm, is to be operated upon, the bandage is unwound to just below this point. A second, broad bandage, the *distal bandage*, being here applied. The space included between the two bandages (which should be not less than 10 cm. ($2\frac{1}{2}$ inches) or more than 25 cm. (10 inches)) is now cut off from the venous circulation above and below (Fig. 111).

If the part to be operated upon be the finger or toe, the proximal bandage is applied at the middle of the forearm and no distal bandage is employed (Fig. 112).

The vein, which we previously marked out, is now located and, under local anæsthesia produced by novocaine, it is dissected out as near to the proximal bandage as possible. A ligature is then tied here. Using this ligature as a retractor, the vein is lifted from its bed and a small slit

made in its lumen by a pair of scissors. A syringe capable of holding 60 c.c., capped with an ordinary intravenous cannula, is introduced into the vein and tied into place. Forty to 50 c.c. of the solution is then slowly injected. Anæsthesia of the segment of the arm between the proximal and the distal ligature is rapid and complete. The

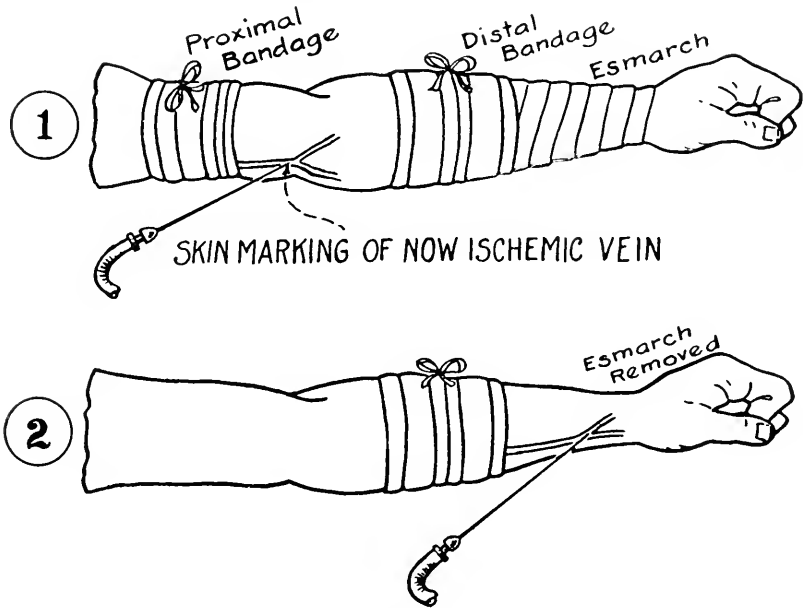

FIGS. 111 and 112.—Bandage for regional intravenous.

solution may be quite easily forced against the obstruction offered by the valves of the veins. The veins at first swollen by the solution, soon collapse indicating the penetration of the fluid into the deep tissues. The anæsthesia of the part continues until the proximal bandage is removed. The reestablishment of the circulation is rapidly followed by a return of the sensation.

The method may prove serviceable for emergency amputations in situations where a general anæsthetic is for one or more reasons contraindicated.

The method appears more thorough and reliable than that offered by surface anæsthesia, for the solution injected into the vein reaches and anæsthetizes the deepest structures at a single injection.

This method has been used more than 500 times by different operators who report success in about 90 per cent. of their cases.

CHAPTER XI

USUAL METHODS

LOCAL ANÆSTHESIA BY INJECTIONS OF NOVOCAINE AND OTHER DRUGS INTO THE SKIN AND DEEPER TISSUES

LOCAL anæsthesia is usually brought about by: (*a*) surface application; (*b*) by infiltration into the tissues (terminal anæsthesia); (*c*) by injections into or around nerve trunks (conductive or regional anæsthesia).

1. *The surface method* is that usually used for work which involves mucous membranes, *i.e.*, nose and throat and genito-urinary operations. Solutions of cocaine .5 to 1 per cent. with adrenalin are the strengths ordinarily employed.

2. *Infiltration anæsthesia (or terminal anæsthesia)* aims to anæsthetize the terminal end organs by bringing them into contact with the solution. This is the method usually employed for superficial operations.

3. *Conductive anæsthesia or regional anæsthesia* aims to destroy or directly block the conductivity of the nerves which supply the part to be operated upon. This is performed by endoneurial injections (direct injections into the nerves) or perineurial injections (bathing the nerve trunks with the solution). This method is often combined with *terminal anæsthesia*.

INFILTRATION OR TERMINAL ANÆSTHESIA

Water injected under the skin causes a transient anæsthesia. This is painful of accomplishment and unsatisfactory. Solutions of the same specific gravity as the

tissues will not produce anæsthesia *per se*; such solutions, normal saline for example, must contain an anæsthetic drug to be effective. If the injected fluid which we employ is rapidly absorbed its effect will be unsatisfactory. To limit this rapid absorption adrenalin is habitually added to the solution. The solution should also be capable of repeated sterilization.

THE SOLUTIONS USED.—*Cocaine*.—Strength commonly used 1 per cent. to 1/10 of 1 per cent. The solution may be made up from standard tablets or from Bodines' tubes. The latter are composed of cocaine and sodium chloride in such proportion that when mixed with sterile water a solution ready for immediate use is formed.

Novocaine.—Strength commonly used .5 per cent. It is the most widely used of all drugs for local anæsthesia and ten times safer than cocaine. Its solution may be repeatedly boiled. It may be conveniently had in tablet form marketed as novocaine suprarenin tablets. These tablets are supposed to be sterile but it is safer to boil the solution in which they are dissolved.

Quinine and Urea.—Strength commonly used .5 to 1 per cent. This solution is said to be absolutely non-toxic. The anæsthetic effects which it produces are more lasting than those of cocaine or novocaine. Because of this prolonged effect it is often used with a view of controlling post-operative pain. Some have claimed that it helps to control hemorrhage after operation by causing a deposit of fibrin over the exposed vessels; others have contended that its employment interfered with the healing of the tissues. If one wishes a prolonged action it is well to wait fifteen to twenty minutes before incising the tissues injected.

THE SYRINGE.—The ordinary hypodermic syringe of all glass or metal is entirely satisfactory (Fig. 113). Syringes should be boiled in plain water and after using dried carefully and a drop of castor oil run in. This prevents the sticking of the piston in the all glass syringe and the drying out of the packing in the metal syringe.

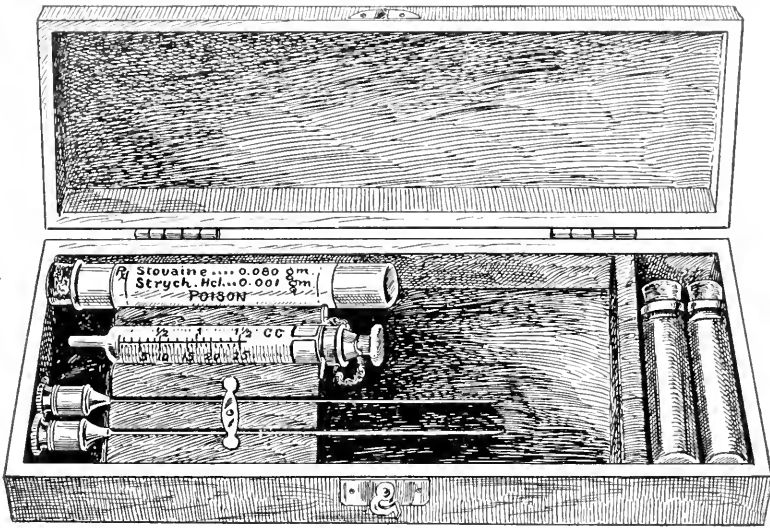

FIG. 113.—Case containing outfit for intraspinal and local anesthesia. (Steel, International Clinics.)

NEEDLES.—Steel needles are satisfactory. A variety of sizes should be on hand. These should range from the ordinary short hypodermic needles to those 10 cm. in length. Nickel and platinum needles may be had, and by their longer life are worth the difference in the purchase price.

THE PRELIMINARY TREATMENT OF THE PATIENT WHO IS TO RECEIVE THE INFILTRATION (TERMINAL) OR THE CONDUCTIVE (REGIONAL) ANÆSTHESIA.—An hour before

operation a dose of morphine gr. $\frac{1}{2}$ and scopolamine gr. $\frac{1}{200}$ should be given.

The operation, no matter how trivial, should be invariably done with the patient lying down.

The patient should have a cup of soup or milk. It is best not to operate on an empty stomach.

It will be readily understood that the proper employment of suggestion is most important. This applies not only to the immediate treatment of the individual but especially to the provision of a proper environment, quiet, courtesy and the banishment of disagreeable sights.

Every effort should be made to distract the attention of the patient. If one is acquainted with his habits and sphere of life, conversation proceeds more freely. A sip of water or vichy may be permitted now and then. Some operators allow their patient to smoke.

Operations done under local anæsthesia need not be hastened. Great care and gentleness should be exercised in the use of retractors and in sponging.

THE ADMINISTRATION OF INFILTRATION (TERMINAL) ANÆSTHESIA.—A syringe is filled with the desired solution, and the needle is introduced just beneath the skin and nearly parallel to it. The solution is forced into the tissue and should form a small, blanched elevation or weal. The needle is withdrawn and reintroduced into the *border* of this weal, *not into* a portion of the uninjected skin. If one follows the practice of reintroducing the needle each time into the weal, the only pain which the patient will experience will be the initial introduction. It is suggested that novocaine solutions be *dye'd* so that the limit of its penetration into the tissue may be easily seen. When the desired area has been injected, the skin will be found

to be anaesthetized. *Great care should be exercised to see that the incision does not extend beyond the anaesthetized area.* The anaesthesia thus produced will last for two or three hours. Tissues, whose sensitiveness we know to be acute, should be carefully injected before they are touched with the knife or sponged (Fig. 114).

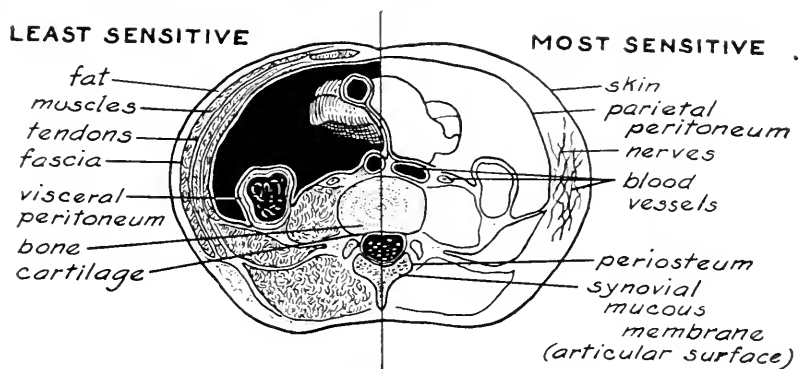

FIG. 114.—Relative sensitiveness of tissues. (Modified from Cunningham's Anatomy.)

The *skin* is everywhere sensitive.

The *fat*, *muscles*, *tendons* and *fascia* where *nerve trunks* and *blood vessels* are not included, are *insensitive*.

The *parietal peritoneum* is very sensitive, but the *visceral peritoneum* is insensitive.

Periosteum and *synovial membranes* are very sensitive.

Bone and *cartilage* are not sensitive.

THE ADMINISTRATION OF CONDUCTIVE OR REGIONAL ANÆSTHESIA.—Conductive anaesthesia implies a precise knowledge of the distribution of the nerves supplying the part to be operated on. *Perineurial injections* are quite easily made. The time required for anaesthesia and the strength of the solution depend upon the size of the nerve

to be blocked. Strong solutions .5 to 1 per cent. cocaine are used about large trunks. By the employment of *conductive* anæsthesia, boils or ulcers may be blocked at a distance and the incision or the excision of the same rendered painless. In endoneural injections the nerve should be dissected out and the needle pointing *centrally* thrust into it. The solution is then injected until the nerve swells. If the needle points peripherally, pain from traction is likely to occur. Pain is not marked upon injection and the conductivity is immediately and completely blocked.

HEALING IN BOTH CONDUCTIVE AND TERMINAL METHODS.—The accidental use of saturated saline solution instead of normal saline has occasioned sloughing of the tissues. Some operators have reported delayed union where quinine and urea have been employed. As a rule, however, the healing is rapid and entirely satisfactory.

The combined Local and General Anæsthesia Technic of Anoci Association as advocated by Dr. Crile of Cleveland has been discussed on page 244.

C. MIXED ANÆSTHESIA

CHAPTER XII

GENERAL CONSIDERATION

MIXED anæsthesia is that type of anæsthesia in which both the central nervous system (the spinal cord) and the peripheral nervous system are brought under the influence of the anæsthetic.

This type of anæsthesia is popularly known as *spinal anæsthesia* or *analgesia*.

Mixed anæsthesia is brought about by injecting the anæsthetizing solution directly into the subarachnoid space. Here it mixes with the cerebrospinal fluid. The cerebrospinal fluid, containing the dissolved anæsthetic, may then be said to act as does conductive or regional anæsthesia, where perineurial injections are employed (see page 259).

The situation in this case is quite different, however, from that of ordinary local anæsthesia for the following reasons:

1. The entire dose must be given at once.
2. The injection is made into a diffusible medium, *i.e.*, into the cerebrospinal fluid.
3. The effects sought for and ordinarily produced are limited to a loss of the sense of pain. The appreciation of heat and cold and of pressure and traction are often retained.
4. Nerve cells, as well as fibres, are exposed to the action of the anæsthetic.

The puncture of the spinal cord and the injection of the analgesic solution imply a knowledge of the anatomy of the part. While the dose may be repeated, if the first dose proves inefficient, it cannot be repeated *ad libitum*. On the other hand, it is impossible to withdraw an overdose.

A solution of a lower specific gravity than the cerebrospinal fluid is known as a diffusible solution. These solutions are usually made up of the anæsthetic drug, water and alcohol. Such diffusible solutions are employed for analgesia required above the point of injection, *i.e.*, for neck and head operations. We mention this type of solution only to condemn it.

When the operation is to be in the lower limbs a solution containing glucose is sometimes used. The addition of glucose is for the purpose of increasing the specific gravity of the injected solution. Such a solution is known as a non-diffusible solution.

The cerebrospinal fluid is a secretion of the choroid plexus and the ependymal membrane (membrane lining the central canal of the cord). The amount of the fluid varies from 50 to 150 c.c. The specific gravity is variously estimated at 1.004 to 1.007, increasing with the age of the patient. The cerebrospinal fluid is constantly in motion and under a pressure varying from 50 to 150 mm. of water.

The diffusion of the injected fluid depends upon the concentration and the pressure with which the injection is made. The diffusion occurs very rapidly where marked pressure is made.

The head down position also increases diffusion, particularly in the case of a solution heavier than the cerebrospinal fluid.

Unless one is prepared for *analgesia*, loss of pain sense rather than *anæsthesia*, loss of all sensation, the active responses to traction and preparation of the patient with hot water are likely to prove disturbing. It is unwise, however, to ask the patient whether or not he still feels pain, as pressure may be so interpreted by a nervous individual.

The fact that the nerve *cells*, not only in the cord but in the base of the brain as well, are exposed to the action of the anæsthetic solution, introduces a complicating factor and one which increases the danger of the general employment of the method. Degenerative effects have shown themselves in the form of permanent paralysis and in paresis.

By means of *mixed* or *spinal analgesia* it has been possible to render the entire body insensitive to pain. Operations upon the head and neck as well as upon the extremities have been done painlessly. High analgesia, above the diaphragm, occurs where a concentrated solution has been given under pressure. Because of the danger of paralysis of the respiration, analgesic effects above the umbilicus should not be tolerated.

The method has been used, and with satisfaction, in children.

APPARATUS

1. Suitable syringe and two cannulæ.
 2. Solution for injection.
 3. Ethyl chloride spray or local anæsthesia accessories for novocaine injection of the skin.
 4. Hypodermic of strychnine 1/30 and camphor in oil.
 5. Sterile adhesive or collodion for sealing puncture.
1. Complete set of suitable syringes and needles may easily be had (Fig. 113).

2. Since cocaine and stovaine solutions have given way to the less toxic novocaine and tropacocaine, it will hardly be to our advantage to consider the former. Vials of novocaine, 5 per cent. solution, containing 3 c.c. each, will be found satisfactory.

The novocaine tablet C., also for sale, is very convenient. The minimum dose is 2 c.c., average dose 2.5 c.c., maximum dose 3 c.c.

Vials of tropacocaine 5 per cent. solution, containing 1 c.c. each, are on the market and will be found satisfactory. The minimum dose, one vial 1 c.c., maximum dose, two vials 2 c.c.

Both of the above solutions contain adrenalin.

When the syringe and needles are boiled one should be careful to have no soda in the water, as an alkaline solution destroys the solutions of both the above drugs.

CHAPTER XIII

THE ADMINISTRATION

IT is perfectly feasible to carry out the administration without any preliminary preparation whatever.

When possible, however, psychic treatment should be employed, every means being used to gain the confidence of the patient. It is advisable to give a dose of morphine gr. $\frac{1}{8}$ and hyoscine $\frac{1}{200}$ an hour before operation. Strychnine gr. $\frac{1}{60}$ and nitroglycerine gr. $\frac{1}{100}$ may be used to advantage. It is not necessary that the patient fast.

The most satisfactory site of injection is between the third and the fourth lumbar vertebræ directly in the middle line (Fig. 117). The object of this site of injection is to immediately engage the ligamentum muscle. This facilitates the direct entrance into the canal.

This point may be found as follows: With the patient sitting up in a slouching posture, draw a line connecting both iliac crests. This line will cross the spinous process of the fourth lumbar vertebra (Fig. 116). The point of injection is then just above this line. The site of injection having been located, the area is then painted with iodine and a slit sheet placed over all. The patient with the arms folded across the abdomen is instructed to lean forward bending the neck on the chest. This attitude serves to increase the spaces between the spines. The skin is now sprayed with ethyl chloride and a small nick made with a scalpel. The cannula with the mandril or stylet

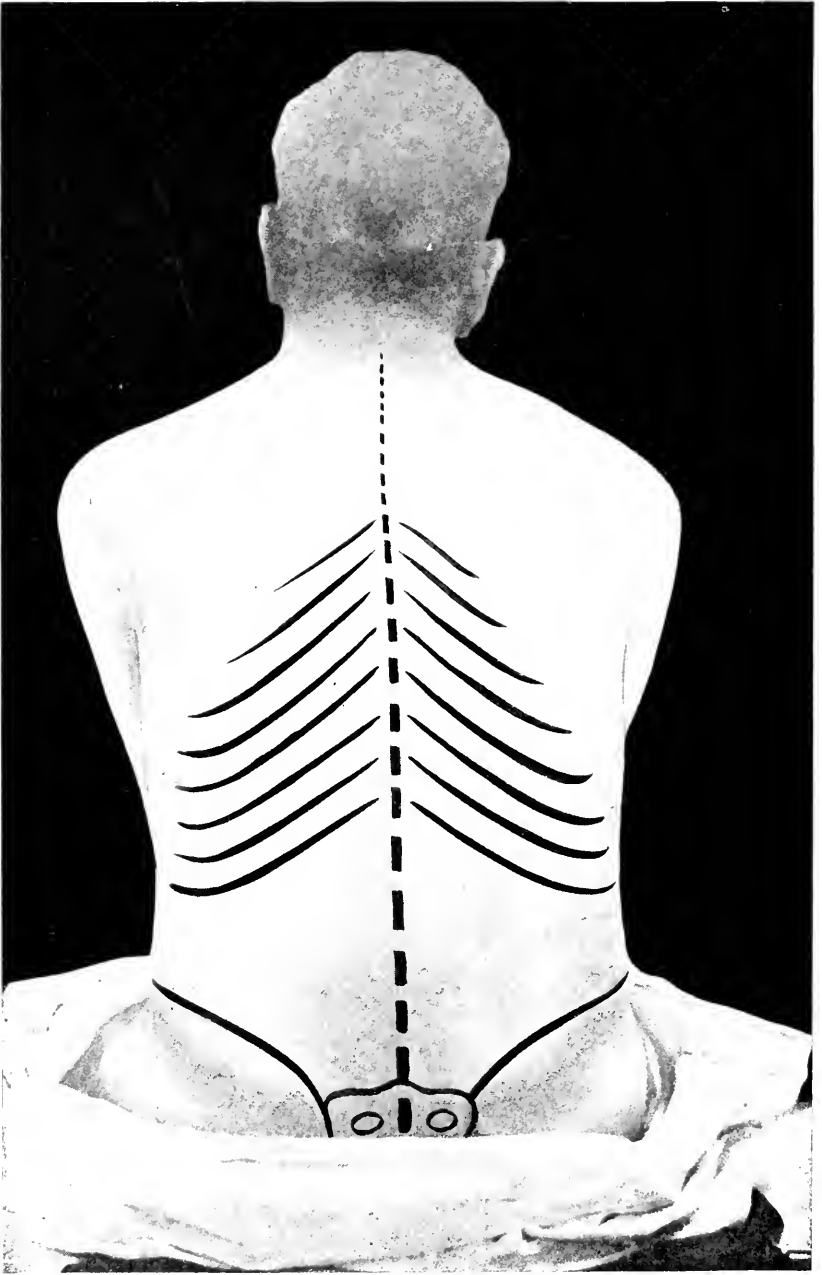

FIG. 115.—The relations of the lumbar and dorsal interspaces to the crests of the ilia and lower ribs. (Steel, International Clinics.)

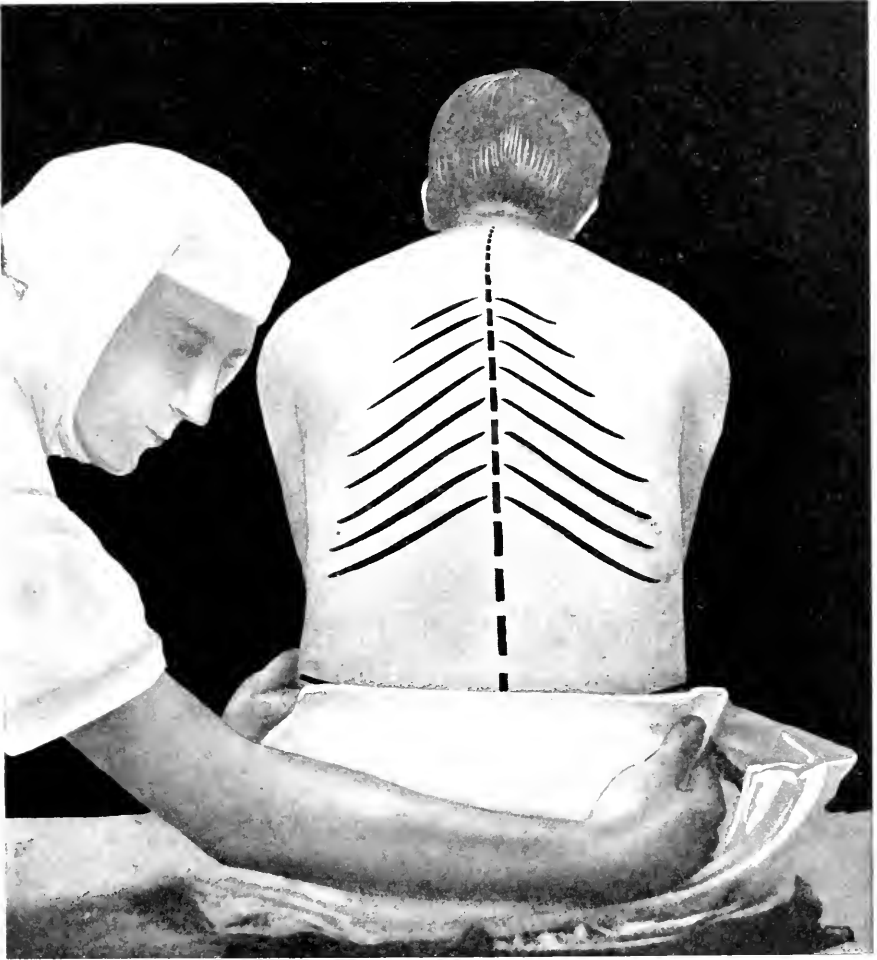

FIG. 116.—Localization of the spinal interspaces. With the patient bent forward, a towel stretched between the iliac crests passes through the spine of the fourth lumbar vertebra. The first lumbar interspace is opposite the tip of the last rib. (Steel, International Clinics.)

in place is then inserted. The needle is directed forward and inward. One feels a sense of resistance followed by a sudden pop as the needle enters the canal. The mandril should then be withdrawn. If the needle is in the canal fluid will escape. If no fluid escapes one should replace the mandril again, insert and withdraw until, upon the partial withdrawal of the mandril, fluid escapes. Ten or fifteen drops of cerebrospinal fluid may be permitted to escape out of the end of the cannula. The syringe, loaded with the solution, novocaine or tropacocaine, is then attached and a little of the cerebrospinal fluid is withdrawn (Fig. 119). The syringe with the mixture is then detached *to see that the needle is still in the canal*. If spinal fluid flows out the syringe may be reattached and the injection made under moderate pressure. The greater the pressure the higher will be the anæsthesia. The patient should then be placed in the semi-sitting position. The procedure is completed by sealing the wound by adhesive or collodion.

Shortly after the injection the following symptoms may be expected: Tingling of the feet, a sense of general malaise, nausea and vomiting. These symptoms may be marked or of no consequence. Following the tingling in the feet, analgesia and loss of motor power will make their appearance beginning below and extending upward. Pallor and perspiration are occasionally seen. At the first appearance of any symptom, however slight, the patient should receive immediately a hypodermic injection of strychnine gr. 1/30.

An overdose may be treated by inhalations of ether carried to the period of excitement.



FIG. 117.—The point of skin puncture is anesthetized by freezing; this is not necessary if a fine needle is used. (Steel, International Clinics.)

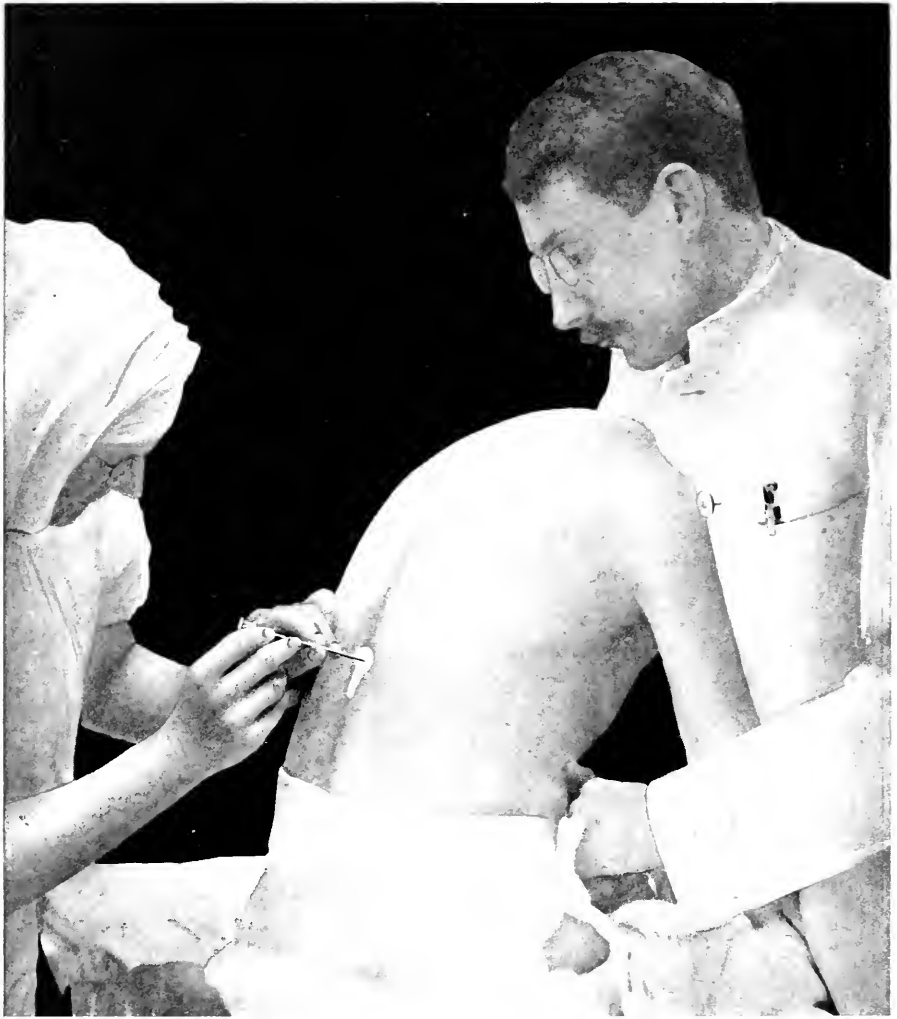

FIG. 128.—The needle is introduced *in the middle line forward and inward.* (Steel, International Clinics.)



FIG. 119.—As the dura is pierced, the cerebrospinal fluid escapes and may be collected in test-tube for further study. (Steel, International Clinics.)

THE ADVANTAGES OF THE METHOD

1. When acting satisfactorily it insures a quiet field of operation.
2. Reduces the amount of after-sickness.
3. The necessary apparatus is comparatively simple.
4. May prove of value where there is an absolute con-



FIG. 120.—The syringe containing the proper dose of stovaine is attached to the needle and slowly injected. (Steel, International Clinics.)

traindication to an anæsthetic, or where one is confronted with an inexperienced anæsthetist and a bad subject for general anæsthesia.

THE DISADVANTAGES OF THE METHOD

1. An overdose cannot be withdrawn.
2. The duration and the degree of the analgesia or the anæsthesia cannot be depended upon.
3. The amount of the drug necessary to produce the desired result is not absolutely known.
4. There is at times incomplete muscular relaxation.
5. There is danger in the injection of a heterogeneous fluid into the spinal canal.
6. Its expert use requires experience which must be gained by trials upon patients who present no special indications for the method.
7. There is danger of subsequent paresis and local or general paralysis.
8. The induction is frequently unpleasant for the patient and the persistence of consciousness may prove undesirable.

PART II

**BEARING UPON FACTORS INCIDENTAL TO THE
ACTUAL ADMINISTRATION OF THE ANÆSTHETIC**

CHAPTER XIV

PRELIMINARY MEDICATION IN ANÆSTHESIA

By preliminary medication we mean that medication which is given before the anæsthetic has been induced. Drugs so administered are usually given hypodermically, for by this method they act more speedily and with greater constancy.

DRUGS, DOSES AND TIME OF ADMINISTRATION

The most common preliminary medication is by morphine and atropine. The ordinary dose of morphine is grs. $\frac{1}{4}$, of atropine grs. $\frac{1}{150}$. If indications call for a smaller dose, the above standard tablet is dissolved in a hypodermic syringe, and one-half or two-thirds of the entire solution is given. The usual time of administration is twenty minutes before operation. Some prefer a two hour interval.

The next most common preliminary medication is that by *morphine and scopolamine* (hyoscine). Scopolamine and hyoscine are thought to be identical. The maximum dose of morphine is $\frac{1}{4}$ grs., of hyoscine $\frac{1}{100}$ grs. The dose ordinarily administered is two-thirds of the maximum dose. The time of administration is one hour before operation.

Preliminary medication is sometimes given by mouth in the form of triple bromides; ten grains every four hours for three doses before operation may be given, where the patient is unusually nervous and apprehensive. Veronal, the evening before the operation, in doses of 7 grs. dissolved in hot milk will be found of value, where insomnia is to be expected.

GENERAL CONSIDERATIONS

The entire question of preliminary hypodermic medication appears to depend upon whether the administration of the anæsthetic is to be the open or closed method. In other words, the situation is dependent upon the amount of rebreathing which the patient experiences. Those who have written for and against the use of preliminary hypodermic medication do not sufficiently emphasize the method which they customarily employ in the administration of the anæsthetic. Anæsthetists, who use the open or semi-open drop method to the exclusion of the closed method, naturally see the maximum ill effects. On the other hand, those who habitually make use of strictly closed methods, see untoward phenomena so infrequently that they are liable to discount their occurrence. If the influence of rebreathing or CO₂ stimulation upon narcotized subjects be more fully appreciated, this confusion of judgment will not so frequently occur.

Experiments upon dogs and other small, hairy animals, by virtue of the more extensive functions of the lungs in throwing off moisture, heat, etc., render experiments directed to respiratory phenomena in human beings of less value than was formerly supposed. In glancing over the *materia medica*, we find the action of morphine, atropine and scopolamine to be most complex. Almost every system and every organ is affected. To attempt to catalogue these effects, or to attempt to neutralize supposed effects by other supposed effects is likely to result in confusion. Where the action of these drugs may be calmly studied in the normal subject, complicated only by age, idiosyncrasy, dosage and purity of the drugs used, our task is sufficiently difficult. Where, however, we superimpose upon these

complications an anæsthetic, incidental respiratory obstruction, the absence or presence of rebreathing, operative trauma, posture of the patient and the difficulty of calm observation, our problem becomes very complex indeed. To depend solely upon the pharmacological action of a drug, or upon a combination of drugs, to determine our attitude toward preliminary hypodermic medication in anæsthesia is misleading.

Above the mass of information which lends itself for observation in such cases, there appear certain facts which are quite constant and which respond to certain forms of treatment.

Where preliminary medication is used:

(a) The respiration is depressed. This depression often tends to delay the period of induction. If the open or semi-open drop method is used, this depression continues and becomes more pronounced as anæsthesia progresses. If the closed method is used, and rebreathing freely permitted, the respiration is seldom depressed, the quality depending upon the amount of rebreathing permitted.

(b) If atropine is included in the preliminary medication, the secretions are checked. The saliva and mucus in the throat are markedly diminished or absent, even in the face of a stormy induction.

(c) The excitement, incidental to the stage of induction, is diminished. This is particularly true of athletes and alcoholics. The psychic fear of operation is also largely dispelled.

(d) The amount and concentration of the anæsthetic used may be reduced.

(e) It is said that if morphine is given *before* operation, the acidosis consequent to the operation is diminished. If given *after* operation, no such beneficial effect follows.

(f) After the return of the reflexes, the patient often sinks into a deep sleep which delays the return of consciousness. This effect is not altogether undesirable. Where an open or semi-open administration has been carried on, the rate of the respirations at this stage is likely to drop alarmingly. Where rebreathing has been permitted this is not so likely to take place.

(g) Susceptible patients may vomit more or less frequently from the use of morphine *per se*.

Some surgeons give morphine and atropine just before the conclusion of the operation, with the view of sparing the patient post-operative pain. Such treatment can do no harm where the open method is employed. When the closed method is in use, however, such medication is not used to the best advantage. A much more satisfactory, all-round result is attained when given twenty minutes before operation. If, during the course of an open method administration, the respirations become slow and shallow, the condition becomes a difficult one to meet. Some method of rebreathing must be resorted to. Should the same condition occur in the course of a closed administration, a ready improvement will be noted upon increasing the rebreathing, and using *oxygen* with the gases rebreathed. We not uncommonly meet the following conditions:

A large, full-blooded patient is given preliminary medication. The stage of induction proceeds slowly, for the respirations are shallow. The shallow respirations furthermore induce a variable amount of duskiess. Free rebreathing into the closed apparatus cannot be carried on because, the more the patient rebreathes, the more dusky he becomes. He cannot be carried satisfactorily upon an open method because the respirations are so shallow that he

does not get sufficient ether. If oxygen be admitted to the rebreathing bag, the difficulty will be entirely obviated for then rebreathing may be freely employed. The respirations become deep and the color immediately clears. This treatment is not mere theory but constant practice.

THE DETAILED EFFECT OF PRELIMINARY MORPHINE AND ATROPINE UPON THE SIGNS OF ANÆSTHESIA, WHEN ETHER BY THE CLOSED METHOD IS USED

INDUCTION.—The period of excitement is short and mild in character.

The period of rigidity may be shortened or protracted, depending entirely upon the character of the respiration.

The period of relaxation. The duration of this stage is also dependent upon the character of the respiration. In a general way it may be said that the stage of induction is smoother but not always shorter.

Respiration.—Usually more shallow and slower. Does not respond as readily to the stimulating effect of ether.

Color.—Largely dependent upon the character of the respiration.

Relaxation.—Rigidity may be persistent. Ordinarily muscular relaxation is rapid and complete. Relaxation of the upper lid and masseteric relaxation appear early.

Eyes.—Eyeballs become fixed soon after consciousness is lost. The light reflex is unaffected. The conjunctivo-palpebral and corneal reflexes soon disappear and are characteristically sluggish. The pupils are less likely to respond to sympathetic stimulation and widely dilate, as is occasionally the case where morphine is not used. They are frequently pin point from the start.

Pulse.—Of no special significance unless unusually slow.

MAINTENANCE.—*Respiration.*—If rebreathing is properly employed there may be little difference noted during this stage. The respirations do not respond as readily to an increase or decrease of ether where morphine is employed. The rhythm may be more or less affected, even in the presence of normal rate and amplitude.

Color.—There may be a persistent tendency to duski-ness. This can only be properly relieved by the use of rebreathing and oxygen. It should be recalled that duski-ness does not necessarily mean an excess of carbon dioxide (see page 298).

Relaxation.—If the relaxation is once complete it has a tendency to remain so. Masseteric relaxation is usually maintained with ease.

Eyes.—Eyeballs remain fixed. Rolling eyes need not cause as much concern as where morphine is not used, for a lighter anæsthesia may be carried with less risk of the patient “coming out.” The light reflex may be sluggish or lost. The corneal reflex often fails to act in the usual satisfactory manner, and is sluggish or absent out of proportion to the depth of the anæsthesia. The pupils are almost always contracted, sometimes pin point. *Dilated pupils, where morphine has been used, almost always mean a profound degree of anæsthesia.*

Pulse.—The pulse is ordinarily little affected by the operative trauma, even in a comparatively light anæsthesia.

RECOVERY.—*Respirations.*—Characteristically shallow and occasionally irregular. Between the return of the reflexes and return of consciousness the *rate* may drop to six or eight a minute.

Color.—Very likely to be unsatisfactory, especially if the respiration has been depressed throughout.

Relaxation.—Complete and persistent.

Eyes.—Motion of eyeballs begins early. The light reflex and the corneal reflex continue sluggish for some time. The pupil has a tendency to remain pin point.

Pulse.—Not characteristic.

When the *open method* is employed with morphine and atropine as preliminary medication, the untoward signs and symptoms, which are observed with the closed method, are aggravated. The respiration in particular is likely to fail. Induction is prolonged, maintenance is often a source of anxiety and recovery is ordinarily delayed.

Where scopolamine is added to the morphine, the depressing effect of the latter is augmented. It is a dangerous practice to employ preliminary medication by morphine and scopolamine where the open or semi-open method is to be used. Where the closed method is employed, with such preliminary medication, we are exposing the patient to more than ordinary risk.

PRELIMINARY MEDICATION WHERE NITROUS OXIDE AND OXYGEN IS THE ANÆSTHETIC

The use of preliminary medication by morphine and atropine and occasionally by morphine and scopolamine is positively necessary where nitrous oxide and oxygen are used alone, and where a smooth and prolonged anæsthesia is desired. When ether is employed in conjunction with these gases, the need of preliminary medication is not quite so imperative but is of distinct benefit. There is of course no choice between the open and closed method where these gases are employed. The closed method must be used. Where a continuous flow and little, if any, rebreathing is used, the open method may be simulated. With such a method it seems unwise to employ scopolamine as a routine.

If morphine and scopolamine are used, the return to

consciousness is delayed. Where indicated, however, it is very satisfactory.

Since the signs of anæsthesia, when morphine and atropine or morphine and scopolamine are used with nitrous oxide oxygen anæsthesia, are nothing more or less than the typical gas oxygen anæsthesia described on page 218, no special analysis is necessary.

Where chloroform or ethyl chloride are used to induce or maintain anæsthesia, preliminary medication should not be used.

Preliminary morphine and atropine or morphine and scopolamine are contraindicated:

Where the open method is used.

In the extremes of age.

Where idiosyncrasy to the drugs exists.

Where oxygen cannot be conveniently had.

When the anæsthetist is inexperienced.

Where the after nursing promises to be inefficient.

Preliminary medication is indicated.—In nitrous oxide oxygen, and nitrous ether anæsthesia.

In athletic and alcoholic individuals.

For neck and throat cases in adults where intratracheal anæsthesia is not available. Goitre cases and tonsils and adenoids.

Whenever one wishes to reduce the amount of the anæsthetic used, *i.e.*, acidosis, diabetes, etc.

Where the patient is neurotic or hysterical, for psychic reasons.

When the post-operative pain promises to be extreme; burns, rectal cases.

In all local anæsthesia.

In morphine habitués.

CHAPTER XV

THE POST-OPERATIVE TREATMENT OF THE PATIENT

THE DUTIES OF THE NURSE BEFORE, DURING AND AFTER ANÆSTHESIA

WE can scarcely overestimate the influence for good which the nurse may exercise upon the patient awaiting operation. A woman, especially, leans very heavily upon those about her for sympathy in this, her time of need. A nurse, who cannot enter somewhat into the patient's point of view, will entirely fail in the good which she may do. A patient, who is rated in the nurse's mind as simply a kidney case, a neck case or some other kind of a case, will not fail to feel the situation keenly. As a result, she will feel the necessity of protecting herself against evils, vague reports of which have reached her before she entered the hospital. This spirit of distrust or apprehension, even though having no foundation, will be very real to the patient. Her confidence must be secured, she must freely and willingly relinquish herself into the hands of those who offer her relief. We all like to hear that we have engaged the best surgeon, or the kindest and most careful anæsthetist in the city, and while we may be glad to hear that our case is unusual, it is even better news to learn that it is well within the skill of the surgeon, whom we have engaged.

The nurse should never permit the suspicion of failure, or the shadow of death, which may lurk in a neighboring room, to enter the mind of her patient; and by her patient, we do not limit ourselves to the private case, but we wish to emphasize more particularly the needs of the case in

the ward. For those who wish to enter into the point of view of the patient, we have prepared a chapter which appears at the end of this volume.

The nurse should inquire into the history of the patient, more particularly in regard to her previous anæsthesias and



FIG. 121.—Nurse grasping patient's wrists.

her reaction to morphine and other drugs. The condition of the teeth should always be inquired into, and false teeth should be removed. She should become perfectly familiar with the various *table positions* necessary for the best operative exposure; *i.e.*, Trendelenburg, Simms, lithotomy, etc. (see page 37). If the operation is to be in the

patient's home, the patient lying in her own bed, the nurse should realize the importance of the anæsthetist's control of the head (see page 23). Once the anæsthetist has taken charge of the patient, it is best that the nurse confine her conversation with the patient to as few words as possible.

During the course of the anæsthesia, it is always best for the nurse to refrain from all remarks as soon as the induction has begun. Desultory conversation heard by the patient is likely to make her feel that she is not receiving the proper attention. At this time hearing is particularly acute. (It is bad taste for the nurse to assume the responsibility of the patient's welfare until the latter has lost the sense of hearing.)

If the patient begins to struggle, throwing the arms above the head, the nurse should grasp the *wrists*, *never the hands* (Fig. 121). If she clasps the hands, as is frequently done, the patient is very likely to crush her fingers in a vicelike grip, or to dig the finger nails into her palms. Struggling movements, unless they interfere with the anæsthetist, should be guided rather than repressed. By such treatment they will subside much more quickly.

The nurse should be constantly awake to the needs of the anæsthetist and remain in sight as much as possible. The anæsthetist often dislikes to call for ether, towels, etc., as this has a tendency to upset the surgeon, who thinks something serious has gone wrong.

THE DUTIES OF THE NURSE AFTER ANÆSTHESIA

Strictly speaking, the nurse takes part in the anæsthesia inasmuch as she usually has charge of the patient before the stage of recovery has finished. She should be

very familiar with the duties incumbent upon her during this interval between the return of the reflexes and the return of consciousness. At this time she is likely to meet with the following difficulties: *Vomiting, cyanosis, respiratory failure, hemorrhage, circulatory shock, hysteria and protracted unconsciousness.*

VOMITING.—Without doubt the most common difficulty which the nurse will meet is vomiting. There are at least three kinds of vomiting, which may be recognized: Vomiting, caused by ether, reflex vomiting from the intra-abdominal manipulations, which have taken place, and vomiting due to morphine.

The vomiting which is due to ether usually begins before consciousness has fully returned, and lasts for hours and even days. This form of vomiting is usually accompanied by nausea. Patients, who complain of the odor of the ether, and who frequently vomit after operation, often do so because of the odor of the ether in their own expirations. This type of case will often experience marked relief, if permitted to smell of some strong perfume, essence of orange, or vinegar applied by means of a gauze sponge laid over the upper lip (p. 80). This treatment is so simple that it should be applied, as a routine, to every case recovering from anæsthesia. Those cases, which suffer from persistent vomiting, are often relieved by having the stomach washed out with a warm, alkaline solution. They are usually intolerant of fluids by mouth, but they will often retain champagne or ginger ale.

Vomiting caused by reflexed pain is quite common, especially where ovarian work has been done. Any manipulation, however, involving the parietal peritoneum is likely to be followed by this form of disturbance. The use

of novocaine, quinine and urea as a nerve block during the course of the operation will do much to control this type of vomiting. Pre-anæsthetic narcotics are also valuable in that they reduce the sensitiveness to pain. When vomiting takes place as a result of reflex irritation, the patient does not complain of the odor of the ether, as is usually the case in the former type.

Vomiting, which occurs as the result of the administration of morphine, is quite frequent, particularly where the anæsthetic is gas oxygen. This type of vomiting is usually unaccompanied by nausea. It resembles somewhat that which is seen in cerebral irritation, or that which may be induced by apomorphine. This form of vomiting is the least annoying to the patient. The author recalls a case in which the patient, in the midst of such an attack, remarked that "she did not mind this," that it was nothing like the vomiting that she had experienced after ether.

In order to ascertain the best position in which to place a patient who is vomiting, the nurse should recall the posture of conscious patients, who are at liberty to place themselves to the best advantage. Such patients, it will be recalled, look directly forward, not to the side, and extend the head on the neck. Hence, when a patient, who is not yet conscious, begins to vomit, he should be placed *on his side*. If the head is turned to the right, *the left shoulder be raised*. The head may be slightly extended by supporting the brow with one hand. Patients recovering from operations on the nose and throat, particularly children who have had their tonsils and adenoids removed, should be placed in the Simms or the prone position (see page 44, Fig. 25).

CYANOSIS.—Cyanosis is almost always due to some

form of respiratory obstruction. It is ordinarily brought about by one of two causes; *masseteric spasm* or *vomiting*.

Masseteric spasm often occurs in alcoholic and full-blooded individuals. In these cases the tongue becomes clenched between the teeth and efficiently blocks respiration through the mouth. If to this condition there is superimposed a partial or complete nasal obstruction, the condition becomes serious. A communication must be established between the pharynx and the outside air. If the teeth cannot be readily separated by the handle of a spoon or by the wedge (Fig. 13) (one of which should be the property of every nurse), then a catheter should be slipped into each of the nostrils for a distance of about six inches. A small size rectal tube may also be used. These tubes before introduction should be lubricated by the saliva, which is running out of the patient's mouth. Needless to say the responsibility of such a complication should be shared with the surgeon, *if the latter is within ready call*. Experience alone will provide the confidence necessary in dealing with such cases.

Cyanosis due to obstruction incidental to vomiting usually occurs in the first period of recovery. When the reflexes have fully returned there is much less likelihood of this difficulty. Cases of intestinal obstruction, tonsils and adenoids, or gastro-enterotomies are most likely to suffer from this complication. The treatment consists of extending the head and wiping the vomitus from the mouth and pharynx.

During the stage of recovery the patient lies flat in bed, no pillows being employed. When consciousness returns, and vomiting has ceased, elevation of the head by one or more pillows is grateful to the patient.

Cyanosis occurring with dyspnoea would suggest a

cardiac lesion, or possibly a pulmonary embolus. In view of such a complication the surgeon should immediately be called.

RESPIRATORY FAILURE.—Where morphine is used as a preliminary to anaesthesia, particularly when the open drop method with ether is employed, the patient may suffer from respiratory depression. In this case the respirations become shallow and very slow. A nurse who sees this phenomenon for the first time may become very much frightened, as the respirations drop from 18 down to 6 or 8 per minute. If the patient is conscious he should be roused by conversation. Instead of making every effort to increase the air he breathes, he should be made to breathe for short periods into a towel, or a rubber bathing cap. Such rebreathing will stimulate the respiration by virtue of the accumulated carbon dioxide (see page 300). The rebreathing should not be carried to a degree of dusiness or cyanosis. If oxygen is convenient much more satisfactory results may be had, as the rebreathing may then be protracted. The oxygen may be conveniently bubbled under the *oiled silk cap* into which the patient is made to rebreathe. Such cases often improve when given a hypodermic of atropine grs. 1/150.

HEMORRHAGE.—Hemorrhage becomes evident in a small, rapid, running, thready pulse. Pallor is usually present and the forehead is covered with a cold perspiration. When this condition has begun in the operating room instructions are usually received *to raise the foot of the bed* (Shock position, see Fig. 123), as soon as the patient is returned to her room. This position improves the cerebral circulation. A Murphy drip or hypodermoclysis (fluid under the breasts) is often employed. If the condition is very pronounced *air hunger* will manifest

itself, the respiration becoming irregular, deep and sighing. Such a case is usually in desperate straits.

CIRCULATORY SHOCK.—Circulatory shock is primarily a nervous phenomenon. It may be likened to syncope or fainting, carried to an extreme degree. The treatment consists in keeping the head low (Fig. 123), applying heat to the trunk and extremities, and in giving strychnine

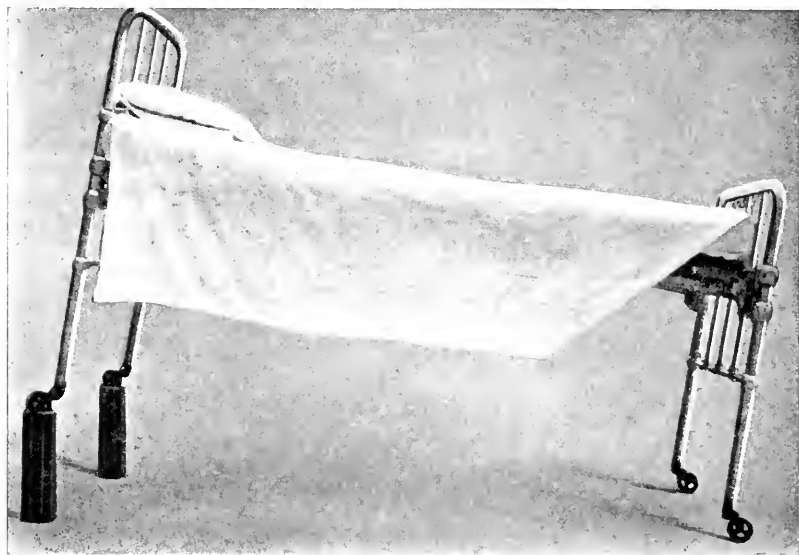

FIG. 122.—The Fowler position. The head of the bed elevated.

hypodermically. Enemas of hot coffee or coffee and brandy (2 Oz.) are efficient.

HYSTERIA.—Where, by virtue of improper preliminary treatment, the induction has been stormy, it is not unusual to find an equally stormy recovery. Neurotic, hysterical women, particularly if addicted to alcohol or drugs, may give a great deal of trouble. Every case must be individualized. Such patients often bear large doses of morphine

well and can be quieted only by this means. Of greater importance, however, than the mere annoyance caused by such a condition are the suicidal tendencies which may suddenly appear in such patients. How many of such have escaped the vigilance of the nurse and flung themselves from the nearest window to the courtyard below! While such extremes are uncommon, the possibility of a calamity of this nature should always be borne in mind.

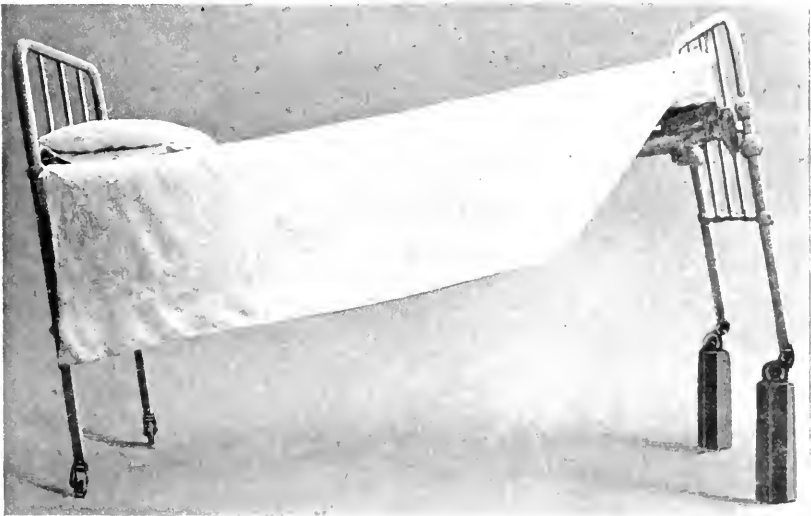

FIG. 123.—The Shock position. The foot of the bed elevated.

PROTRACTED UNCONSCIOUSNESS.—We may presume that a patient who comes from the operating room without having vomited since the conclusion of the operation, whose eyelids are separated, eyeballs fixed, and whose lower jaw offers no resistance when we open and close it, will not recover consciousness for some time. If the administration of the anæsthetic has been such as to permit of an accumulation of the drug employed, *i.e.*, by the rectal

method; the recovery will be much retarded. The use of morphine and scopolamine, or of morphine alone, often causes the patient to fall into a deep sleep after the reflexes have returned. If left alone they may sleep for four or five hours. This sleep can scarcely be ascribed to an unconsciousness from the anæsthetic. The return of consciousness should date from the moment the patient is capable of answering questions rationally. Unless roused, a patient, though fully conscious, will often close his eyes.

If the respiration, color and pulse be satisfactory, it is of little advantage to awaken the patient. If conscious motion or speech do not return after two or three hours, however, effort should be made to rouse him. A patient who is a diabetic may never recover consciousness.

The relative rate of recovery by different methods of anæsthetization is shown below:

Gas oxygen. Most rapid recovery.

Gas oxygen ether.

Gas oxygen ether and morphine and scopolamine.

Incomplete anæsthesia by ether or chloroform.

Complete anæsthesia with ether by the closed method.

Complete anæsthesia with ether by the open method.

Complete anæsthesia with ether by the closed method with morphine.

Complete anæsthesia with ether by the open method with morphine.

Complete anæsthesia with ether by the open method with morphine and scopolamine.

Rectal anæsthesia—slowest recovery.

While this table is subject to many influences, it may be used as a working basis to determine the time at which we may expect consciousness to return.

It is scarcely necessary to speak of the necessity of guarding against burns by hot water bags. As this mishap continues to occur, however, the warning can hardly be overemphasized.

As soon as convenient, after the patient is placed in bed, the room should be darkened and all unnecessary noise incidental to arranging furniture and utensils should cease.

Great care should be taken to see that the patient is not exposed to a draught. Exposure at this time may be followed by pneumonia or pleurisy.

Stout, elderly people, who have suffered gall-bladder operations, are prone to develop congestion of the base of the right lung because of the restricted respiratory movements due to pain in this region.

Goitre cases, in fact any neck case, should have the head elevated as soon as possible. This reduces the congestion of the part and allows greater freedom of the respiration.

The diet is ordinarily ordered by the surgeon in charge. The rapidity of the return of consciousness and the freedom from nausea and vomiting usually indicate the tolerance for liquids and food. Ordinarily the first fluid given is champagne, ginger ale, albumen water or small quantities of ice-water. Cracked ice will sometimes be retained when all else is rejected. Thin soups, egg-nogs and small quantities of toast may follow in the course of twenty-four hours. At the end of another day a soft diet may be given. In a general way we may say that the sooner food is tolerated, the more rapid will be the convalescence.

Patients, who are anæsthetized by nitrous oxide and oxygen in the morning, are so little affected that they often eat their regular meal in the evening.

CHAPTER XVI

CARBON DIOXIDE AND REBREATHING

It is now quite generally accepted that the air which we exhale is not poisonous, that the organic matter which it contains amounts to practically nothing, and that the disagreeable sensations experienced in ill ventilated rooms are primarily due to increased temperature, moisture and by-products of perspiration. Exhaled carbon dioxide, accumulating under such circumstances, produces no unpleasant effects until it has become sufficiently concentrated to stimulate the respiration to greater frequency than normal. This stimulating effect takes place when the concentration has reached 4 per cent. If the amount be further increased to 10 per cent. distress and dyspnœa is experienced.

These findings become of great practical interest when applied to the individual who rebreathes his expirations from a bag. The effect of such rebreathing is practically limited to the accumulated CO_2 inhaled by the patient.

To some the very idea of rebreathing one's own expirations is repellent. Such æsthetic objections may be met by the fact that ordinary respirations into the atmosphere are largely made up of gases rebreathed. With the ordinary, quiet inspiration only about 500 c.c. out of the total lung (vital) capacity of 3700 c.c. is fresh air. As a matter of fact then we rebreathe more than six-sevenths of the air which we use for respiratory purposes during quiet, unobstructed breathing. The matter of rebreathing into

a bag becomes one of relative, rather than absolute difference.

The untoward effects of CO_2 depend very largely upon the presence or absence of oxygen. Many of the evil effects ascribed to CO_2 *per se* may be traced to a deficiency of oxygen. While high percentages of CO_2 , 8 to 10 per cent. probably cause bad effects, even in the presence of sufficient oxygen, such effects by smaller amounts under similar conditions are open to question. The physiology of carbon dioxide has assumed such proportions that we can scarcely do more than indicate a few of the recent findings which apply to anæsthesia.

CHEMISTRY OF CARBON DIOXIDE.—Carbon dioxide or carbonic acid gas is a colorless, suffocating gas, very soluble in water. It neither burns nor does it support combustion. When heated at high temperatures it breaks down into CO and O. Ordinarily it is a very staple compound. The atmospheric CO_2 is derived from the respiration of animals, combustion, fermentation, volcanic sources, manufacturing processes (cement works, etc.) and from mines after explosions of fire damp.

The origin of carbon dioxide and the condition in which it occurs in the blood.—One of the chief sources of carbon dioxide is muscular action; the general body metabolism furnishes the remainder.

Carbon dioxide is distributed uniformly throughout the mass of blood. Part is in simple solution, part is in chemical combination with the plasma, part is in chemical combination with the corpuscles.

The carbon dioxide forms compounds with the alkaline bases in the blood, Na, K., etc. One of the most common compounds is that formed with sodium. When the tension

of the carbon dioxide is increased, as in the active tissues, the equilibrium is disturbed and alkali is taken from the proteids and combines with the excess of CO_2 to form sodium bicarbonate. When the carbon dioxide pressure is reduced, as in the lungs, sodium bicarbonate dissociates in part, giving off CO_2 .

Oxygen gas and carbon dioxide gas are as independent of one another as are carbon dioxide and nitrogen. They coexist in the same blood corpuscle without reaction of any kind. Hæmoglobin nearly saturated with oxygen will take up carbon dioxide as though it held no oxygen in combination. It is thought that the oxygen unites with the pigment portion, and carbon dioxide with the proteid portion of the hæmoglobin. While the amount of oxygen, which the hæmoglobin contains, does not influence its absorption of CO_2 , yet *the presence of carbon dioxide loosens, as it were, the combination between the oxygen and the hæmoglobin, allowing the latter to flow to the tissues more readily.* This tendency of the carbon dioxide to facilitate the liberation of oxygen may serve to throw light on the hitherto inexplicable fact that rebreathing is often of distinct clinical benefit to the anæsthetized patient.

CYANOSIS AND CARBON DIOXIDE.—The presence or absence of cyanosis has nothing to do with the amount of carbon dioxide present in the blood. As has been stated above, carbon dioxide exists in the blood in the simple solution and in chemical combination with alkalies present. The blood depends upon the corpuscles for its color and these, as is well known, depend upon the amount of hæmoglobin which is contained in the individual cell. The hæmoglobin then is the element which controls the color in

the blood. When the hæmoglobin is exposed to oxygen, oxyhæmoglobin is formed. It is this compound that gives the blood its characteristic crimson hue. The color of the blood then depends entirely upon the amount of oxyhæmoglobin present. In the patient a reduction of this compound results in duskiess, a greater reduction in blueness or lividity.

Clinically one may cause a patient to rebreathe into a bag of oxygen until the carbon dioxide is so much increased as to cause severe dyspnœa; cyanosis, however, will not supervene.

THE EFFECT ON THE RESPIRATION OF REDUCING CARBON DIOXIDE AND OF INCREASING CARBON DIOXIDE IN THE CONSCIOUS SUBJECT.—*Definition of Terms.*—*Apnœa:* A condition of no breathing. *Acapnia:* A condition of diminished CO_2 in the blood, the cause of true apnœa. *Dyspnœa:* A condition of increased breathing. *Hypercapnia:* A condition of increased CO_2 in the blood, often the cause of dyspnœa.

THE EFFECT OF REDUCING THE AMOUNT OF CO_2 IN THE BLOOD.—Rapid, deep breathing in the conscious individual is often followed by a sense of lightness in the head. This gives rise to a condition of acapnia, which, if continued, results in apnœa of varying degrees. In everyday life this experience is familiar to those who, upon going out of doors upon a clear, exhilarating, winter's day, breathe deeply ten or fifteen times and find their heads swimming at the end of this exercise. After having run some distance to catch a train, one often experiences the necessity of voluntary respirations for some moments following the exertion. In this latter case, oxygen in abundance has been supplied by the increased rate and depth

of the respiration, but the usual amount of CO_2 present has been reduced and one unconsciously feels that if the rate and depth of the respirations can be somewhat lessened, that the distress following upon the exertion will more quickly pass away.

THE EFFECT OF INCREASING THE CARBON DIOXIDE IN THE BLOOD.—The effect of increasing the amount of carbon dioxide in the blood is seen in the simple experiment of holding one's breath. If at some indefinite time, in the course of a normal respiration, the breath is held, the necessity to breathe will appear at the end of half a minute or less; if, however, the carbon dioxide be well rinsed out of the lungs by several deep respirations, the necessity to breathe may be postponed for double this time. The absence of oxygen and the collapse of the lung *per se* stimulate the act of respiration, but these elements may be eliminated in the following experiment: If one fills a small (one gallon) bag with pure oxygen gas and, after rebreathing several times into this, holds the breath at the end of an inspiration (lung distended, surplus of oxygen present), and takes the length of time during which it is possible to hold the breath, he will find that this time will be considerably less than the period of apnœa possible if he inhales pure oxygen and exhales into the atmosphere holding his breath at the end of a series of forced inspirations. In the second case, the conditions are identical except that the amount of carbon dioxide in the circulation is reduced. By carrying out this technic, disposing of all possible CO_2 and filling the lungs with oxygen, the longest possible period of apnœa may be obtained, the record being (see page 307) 10 minutes, 10 seconds.

It is possible, therefore, by the simplest experiments to

show the effect of the reduction and the increase of carbon dioxide in the blood of the conscious subject.

Where observations may be made upon unconscious subjects, the effects are more striking as there is no interference by the will.

The anaesthetized subject offers exceptional opportunities to study the phenomena incidental to an increase or diminution of carbon dioxide in the respired air. Such observations may be made not only by the use of the closed method in which case the results are positive, but by the open method as well, in which case the effects of the absence of the necessary CO_2 become apparent.

Where the Open Method is Used.—One of the most common results of the use of the open method is acapnia. If acapnia becomes marked, as is sometimes the case, during an induction where there is much excitement, the patient shouting, crying out or breathing rapidly and deeply, a definite period of apnoea may develop. The beginner, who sees his patient stop breathing shortly after a period of excitement in ether anaesthesia, becomes much upset and immediately starts artificial respiration. If this artificial respiration is ineffectual, as is frequently the case, it may not interfere with the normal return of the respiration. If, however, it be effective, it may, by increasing the acapnia, materially delay the return of the normal respiration. If the patient stops breathing following a period of dyspnoea from excitement, in the presence of normal color, pulse and eye symptoms showing a light anaesthesia, ether being the anaesthetic and morphine having been omitted, it is best to leave the patient alone. He will soon breathe of his own accord even though he be apnoeic for a full

minute or more. This phenomenon is very common in children.

Acapnia during the stage of maintenance, the open method being used, is of quite common occurrence. Apnoea at this time however, is more serious, and is often associated with cold perspiration and circulatory depression.

Acapnia during the stage of recovery is not seen as frequently as during induction and maintenance.

When the open drop method is used the prevailing tendency is apnoea from acapnia. When the semi-open drop method is employed this tendency is reduced in proportion to the amount of rebreathing permitted.

Where the Closed Method is Used.—Where a strictly closed method is employed, such as is described on page 132, one does not see the apnoea of induction which is common to the open method, because there is no acapnia. On the contrary there is very likely to be dyspnoea from hypercapnia. Where a gas induction is employed, the gas *per se* induces a dyspnoea which is superimposed upon that due to hypercapnia. The result is rapid, deep breathing. Rapid, deep breathing at this particular time enables one to quickly saturate the patient's blood with ether, in other words induction is quickly accomplished. Morphine by depressing the respiration usually diminishes this dyspnoea and frequently retards the induction.

During the stage of maintenance, however, the dyspnoea caused by the hypercapnia must be controlled. Unless this is done the excessive breathing is likely to prove a menace to satisfactory abdominal manipulations. If one understands the cause of the excessive breathing, which the patient experiences, he can easily adjust this difficulty. The control of the respirations by reducing or increasing

the CO₂ by means of rebreathing is exceedingly interesting. A patient who is breathing deeply and rapidly may, in the face of an upper abdominal operation, be immediately quieted by entirely emptying the rebreathing bag and filling it with oxygen and air; abdominal rigidity and excessive movement of the diaphragm being at the same time reduced to the minimum by the free use of ether.

During the stage of recovery, after the removal of the face piece and rebreathing bag, the respirations will usually drop in rate and depth from the absence of the artificial CO₂ stimulation. Shallow breathing may follow for a few moments. This effect however, is not due to acapnia but from a reaction to over stimulation by the CO₂.

When the closed method is used, the prevailing tendency is dyspnoea from hypercapnia. If this is properly controlled it is beneficial in as much as it allows of more rapid introduction and withdrawal of the ether employed. In other words the condition of the patient is more pliable than where there is a tendency to apnoea from acapnia.

The tendency to dyspnoea where the closed method is used increases the safety of preliminary medication, the chief characteristic of which is depression.

Where Nitrous Oxide and Oxygen is the Anæsthetic.—Where oxygen is added to nitrous oxide in a quantity sufficient to control asphyxia, the dyspnoea ordinarily seen when nitrous oxide is used alone is not apparent. The effect of rebreathing in such cases is much the same as with the closed method of ether administration. Gas oxygen being a less depressing type of anæsthesia, however, the effects of rebreathing are even more marked.

Where a constant flow of gas oxygen is employed

without rebreathing (see page 233), we may expect to see the apnoea characteristic of the open drop method. Gas oxygen anæsthesia with excessive rebreathing becomes annoying by virtue of the very deep respirations experienced. The addition of a preliminary dose of morphine reduces the sensitiveness of the respiratory centre to stimulation (CO_2) and, with this type of preliminary medication, more extensive rebreathing may be permitted.

The type of case with which we have to deal determines very largely the extent to which rebreathing may be permitted. A full-blooded individual, who has not received preliminary medication, will tolerate little rebreathing throughout anæsthesia. On the other hand an anæmic individual, who has been permitted to rebreathe an atmosphere of oxygen and ether, will appear to be stimulated rather than depressed by the experience. The author is convinced that the sicker, the more septic a patient is, the more are closed methods of administration indicated. In such cases rebreathing with oxygen almost always appears to improve the general condition. The normal, vigorous individual at the end of an anæsthetic by the closed method is almost always in a better general condition than if he had suffered anæsthesia by the open method. The color is invariably better, the pulse shows less depression and the body heat is retained. *The beneficial effect of rebreathing may be accounted for by the fact that the presence of carbon dioxide in the blood corpuscles increases the freedom with which the hæmoglobin parts with its oxygen, thus promoting oxygenation of the vital tissues.*

The beneficial effect of rebreathing carbon dioxide and oxygen when depression of the respiratory centre exists, has become so generally accepted that makers of oxygen

gas supply a mixture of oxygen and carbon dioxide (5 per cent.) for therapeutic purposes.

We regret that space permits of but a brief introduction into this most fascinating subject and refer the interested reader to the appended bibliography.

In conclusion we would emphasize the fact that re-breathing is not dangerous to health as was formerly supposed, that in ordinary respiration we rebreath six-sevenths of our vital respiratory capacity, and that rebreathing into a bag is a matter of relative importance rather than of absolute difference. We would recall to mind the fact that carbon dioxide is distributed uniformly throughout the mass of blood and that carbon dioxide and oxygen exist in the blood independently of one another. We would impress the fact that carbon dioxide is not the cause of cyanosis, that it is only occasionally incidental to it, and that the color of the blood is entirely due to the amount of oxygen present. We would recall to mind the fact that a reduction of CO_2 gives rise to a condition known as acapnia, which may, if extreme, lead to apnœa. On the other hand an increase of CO_2 known as hypercapnia frequently results in more or less dyspnœa. The open method is characterized by acapnia and apnœa; the closed method by hypercapnia and dyspnœa. Hypercapnia may be more easily controlled than acapnia, is of distinct advantage in the control of the anæsthesia, and may often prove beneficial to the patient. We would draw attention to the fact that rebreathing is of distinct advantage where there exists respiratory depression from the use of morphine, and we feel that the closed method is the method of choice whenever the patient is critically ill. The advantage of the closed method, and the rebreathing which it implies, may

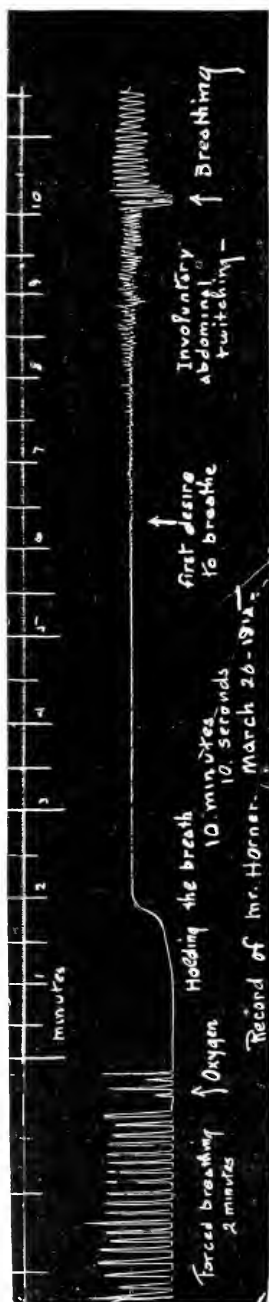

Fig. 124.—Tracing of experiment in respiration. (Courtesy of Journal of the American Medical Association.)

be explained by the fact that oxyhæmoglobin dissociates more readily in the presence of abundant carbon dioxide.

EXPERIMENT IN RESPIRATION.—In the course of some experiments in respiration bringing out the theories advanced by Yandell Henderson, an undergraduate student in the University of California Medical School held his breath ten minutes.

This was accomplished by having the student lie on a table, with a pneumographic belt attached about his thorax and communicating with a kymograph.

Slow, deep inspirations were taken for two minutes: this eliminated a good portion of the carbon dioxide from the blood. A breath of oxygen was then taken and the time marker started. The tracing is here shown. A slight relaxation of the respiratory muscles is indicated at two minutes. No desire to breathe was experienced until six minutes had elapsed. The belt having been placed over the diaphragm, the pulse rhythm was shown throughout. From this

time on, the conscious effort to hold the breath increased until an involuntary twitching of the abdominal muscles was quite apparent; but no respiration took place. All the time the pulse was full and strong, the color good. No oxygen want appeared.

At the expiration of ten minutes some vertigo occurred, and the impulse to breathe having become imperative, the first inspiration was taken—ten minutes and ten seconds having elapsed. No great hyperpnœa, no weakness, no heart changes appeared. The student rose from the table and went about his class work (Fig. 124).

CHAPTER XVII

EMERGENCY ANÆSTHESIA

For the best results in the administration of an anæsthetic suitable apparatus should be employed. Occasionally, however, we find ourselves without our familiar tools and are obliged to improvise others. If the signs of anæsthesia are thoroughly understood, we may often successfully surmount the difficulty confronting us. Improvised apparatus, however, instead of offering the easiest means of administration, usually, by virtue of their inefficiency, make the administration more difficult. In the long run the efficient method is the easiest and the most dependable.

The hints which follow are intended to apply only when the exigencies of the occasion preclude the use of the proper apparatus. Their successful application will depend to a very large degree upon the mechanical cleverness of the administrator.

We will imagine ourselves stranded in an out-of-the-way place without our usual paraphernalia.

WHEN NO ANÆSTHETIC AGENTS ARE AT HAND.—When the usual anæsthetic agents are not at hand, the employment of morphine and scopolamine hypodermically, in repeated doses will be found very valuable. Hyoscine and scopolamine being considered identical, we will use these terms interchangeably. The dose of these drugs for an adult is morphine gr. $\frac{1}{4}$, hyoscine gr. $\frac{1}{100}$. At the end of an hour the dose may be repeated. The effect secured by two injections is often sufficient to enable one to

operate painlessly. Where after two doses the anaesthesia is not yet satisfactory, the dose may be repeated. The reflex pain which results from the surgical manipulation appears to neutralize to a large degree the depressing effects of these drugs. Atropine, hypodermically, in doses of 1/100 gr. and rebreathing applied by means of towels, will help to control respiratory depression. The method is one of necessity not of choice.

Freezing the part (page 249), pressure on nerve trunks (page 250), and pressure producing ischæmia of the part (page 251), may be employed in an emergency.

Where novocaine and cocaine are to be had, the results will be limited only by the skill of the operator. Cocaine is more plentiful than novocaine and it is only because of this reason that its use is suggested. It is about seven times more dangerous and should never be used in a maximum dosage of more than one grain.

WHERE ETHER, CHLOROFORM AND ETHYL CHLORIDE ARE AVAILABLE.—Any unopened container with ether, chloroform or ethyl chloride marked for *anaesthesia* may be considered safe.

Ether which has been exposed to the air for some time and which may be suspected of being unsafe should be tested as follows, before being administered.

1. Upon evaporation it should leave no residue.
2. Allowed to evaporate spontaneously there should be no perceptible, foreign odor present when the last traces have disappeared.
3. There should be no change in color on the addition of KOH (color indicating the presence of an aldehyde).
4. Ether should not affect blue litmus paper even after twenty-four hours' contact. (Indicating absence of acetic acid.)

5. There should not be an undue amount of water or alcohol present. (If 20 c.c. of ether and 20 c.c. of water, previously saturated with ether, be shaken together the ether layer on separation should not measure less than 19.5 c.c.).

Chloroform which has been exposed to air and light should be tested as follows, before being administered:

1. It should possess a specific gravity of not more than 1.495 and not less than 1.490. (Lower specific gravity indicates an excess of alcohol.)

2. It should be perfectly transparent and colorless.

3. It should be absolutely neutral to test paper.

4. It should possess an agreeable bland and non-irritating odor.

5. When allowed to evaporate spontaneously it should leave no residue either of water or any substance possessing a strong smell.

6. When shaken with concentrated sulphuric acid no brownish coloration should result. It should form no precipitate with a solution of silver nitrate.

7. It should not acquire a brown color when heated to the boiling point with caustic potash.

Ethyl chloride is not likely to suffer from exposure to air because of its extremely low boiling point (its very great tendency to vaporize). It should be neutral in reaction and leave no residue when vaporized.

THE ADMINISTRATION OF ETHER BY AN IMPROVED OPEN METHOD.—An ordinary, small, hand towel is folded around the nose and mouth, leaving the latter free. Cheese-cloth in eight or ten thicknesses, or one thickness of a bath towel, is then laid over the top of this. The drop bottle is immediately improvised by puncturing the centre of the ether can cap with a single pin hole. The rate of flow of

the ether from this hole is regulated by the tip of the index finger.

If the head and the face are covered during the course of an operation on the face, ether may be sprayed directly on that part of the sterile sheet over the mouth without disturbing the asepsis of the field of operation. A patient suffering an operation under local anæsthesia recently was thus anæsthetized by the author.

When ether is given in this improvised fashion, we must bear in mind the possibility and danger of liquid ether being allowed to find its way into the mouth of the patient.

THE ADMINISTRATION OF ETHER BY AN IMPROVED SEMI-OPEN METHOD.—The use of the towel cone is quite common where the need of a semi-open or closed method is felt but undeveloped. We cannot speak of this method as a closed one because the space devoted to rebreathing is so small as to necessitate the entrance of atmospheric air about the edges of the mask. Such a mask as we are about to describe acts quite efficiently as an open and semi-open method.

The material necessary for its construction consists of a towel, a newspaper, gauze, cheesecloth or a few strips of soft, woolen rags.

The mask is made as follows: Five sheets of ordinary newspaper are opened wide and laid on a table or on the floor. These five sheets are then folded lengthwise twice. There is now a strip of newspaper twenty sheets thick about six inches wide, and as long as the newspaper is when opened wide. This strip is now laid on an ordinary hand towel (1 yd. x $\frac{1}{2}$ yd.) lengthwise, so that the paper comes in contact with the long, free edge of the towel. If the strip of paper projects beyond the towel, it may be

torn off. The paper may be an inch or two short without effecting the result. A towel three feet long and one and one-half feet wide will now be covered by paper on one-third of its area. The paper and towel are now grasped at one end and a fold of about seven inches is made (Fig. 125 *a* and *b*). The towel is outside and the paper inside. The folding is continued until the entire length of the towel and the paper is included. The result is a tube of paper and towel (Fig. 125 *c*). The hand is now thrust through the tube thus formed (Fig. 125 *d*), and grasps the free end of the towel pulling it through, so as to form a lining for the tube (Fig. 125 *e*). The roll (Fig. 125 *f*) is now held between the knees and the free end is drawn snug. The surplus is then turned down over the top of the roll like a collar (Fig. 125 *g*). It will fit snugly, needs no sewing and a single pin will serve to hold down the one loose corner.

Sewed cones are a nuisance to make, and because of this, one is sometimes tempted to use them twice—a most unpardonable practice.

A strip of gauze is now poked gently into the top of the cone, care being taken that it does not come in contact with the face. (When in doubt the cone should be inspected by turning it upside down.) Ether may now be dropped or sprayed upon the gauze or cheesecloth. When it is desirable to increase the concentration of the vapor, the flat of the hand may be laid partly or wholly over the vent. At frequent intervals the gauze should be taken out and shaken, as it soon becomes saturated with moisture from the expirations. This inhaler is simple, reliable and as efficient as any semi-open method known to us.

Incidentally we would mention the towel cone sealed

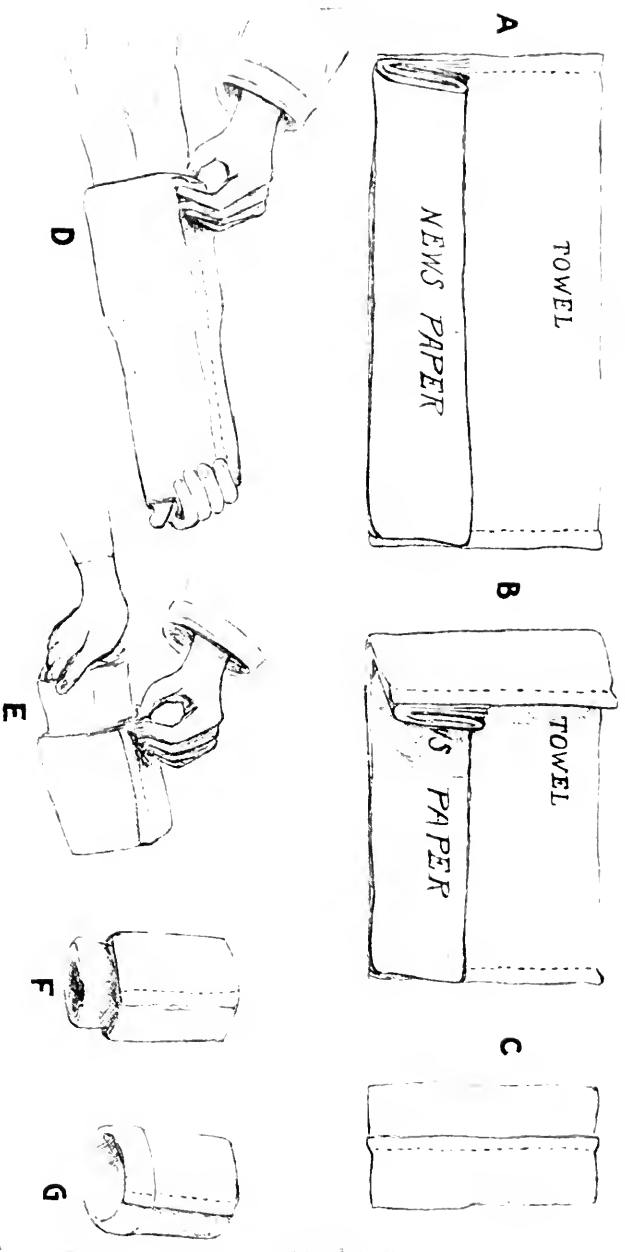

FIG. 125.—Making the cone. A, newspaper spread on towel; B, making the first seven-inch fold; C, folding completed; D, grasping free end of towel; E, pulling it through snuff; F, ready to turn surplus over bottom of cone; G, cuff turned up, completing cone.

at one end, only to condemn it as asphyxial and inefficient.

THE USE OF CHLOROFORM IN EMERGENCY ANÆSTHESIA.—The use of chloroform in emergency anæsthesia should be strictly limited to the C. E. mixture (see page 194). It should never be employed where there is a limitation of air. It should not be used where there is a gas light or other flame. Unless a proper mask is available, the face should be anointed with vaseline to prevent burning of the skin. The use of chloroform in emergency anæsthesia should be limited to the period of induction. The physiology of chloroform anæsthesia (page 185) should be understood, and the causes of death (page 195) should be thoughtfully anticipated.

Small quantities of chloroform on a gauze sponge, held before the patient by means of a sterile sponge holder, are sometimes used for operations about the face.

THE USE OF ETHYL CHLORIDE IN EMERGENCY ANÆSTHESIA.—The use of ethyl chloride as an emergency anæsthetic is suggested chiefly as a substitute for nitrous oxide. We would emphasize the necessity of great care in its use and recall to the reader's mind the tendency of the patient to collapse, following its use. It has its place, nevertheless, and if cautiously used, will be found quite serviceable.

INTRAPHARYNGEAL ANÆSTHESIA BY IMPROVISED METHODS.—The patient is anæsthetized by the improvised towel cone. When anæsthesia has been well induced, a catheter or small rectal tube is slipped into one of the nostrils. (If two catheters are available, having a "Y" tube connection, so much the better.) The end of the catheter is now fitted over the bottom of a glass funnel; the funnel is filled with gauze; ether or the C. E. mixture is then cautiously dropped upon this gauze. The vapor

thus formed is inspired by the patient. *Great care must be taken to prevent liquid ether from finding its way into the catheter.* This may be prevented by holding the funnel on its side, so that liquid ether will run out. Fig. 126 shows the funnel packed with gauze.

With this method we depend upon the amount of suc-

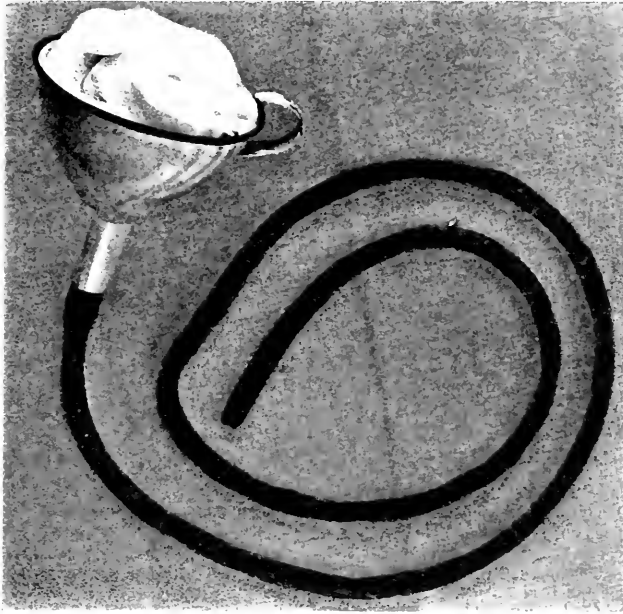

FIG. 126.—Funnel with tube for intrapharyngeal anæsthesia.

tion through the tube brought about by the respirations of the patient. This being comparatively small, the method by ether alone is quite inefficient. When the C. E. mixture is used, better results may be expected.

INTRATRACHEAL ANÆSTHESIA BY IMPROVED APPARATUS.—Intratracheal anæsthesia may be satisfactorily administered by employing a technic similar to that described

for the emergency intrapharyngeal method. When this method is employed, we introduce a tube directly into the trachea, attaching the distal end to a tube which connects it to a funnel as described above. This method is much

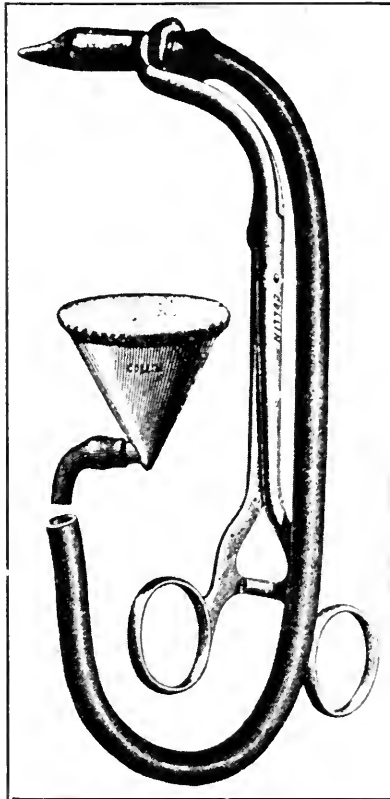

FIG. 127.—Funnel with tube for intratracheal anæsthesia. (Courtesy American Journal of Surgery.)

more efficient than the intrapharyngeal method, because a much larger volume of air passes through the tube. An apparatus similar to the one shown in Fig. 127 has been repeatedly used with much success.

The danger of such a method in inexperienced hands is

much greater than that described on page 159, but its usefulness where indicated, in the absence of the usual apparatus, can hardly be denied. By such a method it is impossible to obtain positive intrapulmonary pressure.

ACCESSORIES TO EMERGENCY ANÆSTHESIA.—A mouth wedge, necessary when masseteric spasm and cyanosis occur, may easily be improvised by whittling a piece of hard wood in the form shown in Fig. 13.

A breathing tube, acting in the capacity of the Connell throat tube, Fig. 14, may readily be made from a five-inch piece of rectal tube or other stout tubing having a diameter of at least half an inch. A safety pin should always be fastened across the outer end.

If, in the course of an abdominal operation, the pulse becomes small and rapid, indicating hemorrhage and the need of a saline injection, the quickest and most convenient way of administering this is to pour hot saline directly into the abdominal cavity. While this is being done, an ordinary fountain syringe should be filled with warm saline, and a hypodermoclysis needle attached to the tubing leading therefrom should be thrust deep into the loose tissue under one of the breasts. The height of the rubber bag determines the rate of the flow. It may be started at three feet above the patient and raised if the flow is not sufficiently rapid. Hypodermoclysis is an exceedingly satisfactory means of introducing saline solution into the general circulation. The effects are not so rapid and it may safely be started at an earlier time than can an intravenous injection. The greatest advantage, however, lies in the fact that it does not delay the course of the operation by requiring the attention of the surgeon or his assistant. All the necessary details may be cared for by the nurse, working under the direction of the anæsthetist.

CHAPTER XVIII

THE ANÆSTHETIST'S RECORDS

THOSE who administer anæsthetics sooner or later find it essential to preserve a fairly comprehensive record of each case. This becomes necessary not alone from a scientific point of view, but also for self-protection.

It is frequently inconvenient to gather personal data at the time of the operation. To avoid this embarrassment a record card and a self-addressed, stamped envelope may be

NAME		DATE OF OPERATIONS		NO
AGE	SEX	ADDRESS		
NAME AND ADDRESS OF NURSE				
OPERATIONS				
SURGEON		ASSISTANTS		
UNCONSCIOUSNESS AFTER OPERATION	10 min		PREVIOUSLY ANAESTHETIZED / N_2O	
CONDITION OF EYES AFTER OPERATION	OK		CHAR OF INDUCTION <i>Excit Moderate</i>	
F TEETH <i>124</i> CRYSTALS, RIGIDITY JACHTATION MYCOTIS VOMITING BEFORE, DURING, AFTER				
ANÆS. SUCCESS	S	OK	P	A OK
REMARKS				
CHARGES	BILL SENT:		PAID:	

FIG. 128.—Front of anæsthesia record card.

left with the nurse, who is usually glad to secure the desired information. The accompanying figures illustrate such a card.

The front of the card (Fig. 128) requires but little comment.

Char. of Induction.—Excitement absent, moderate, marked.

Anæs. Success.—S., Point of view of the surgeon; P., of patient; A., of Anæsthetist.

Heads for data which are absent should be crossed out.
 On the reverse of the card (Fig. 129) attention may be directed to the following points:

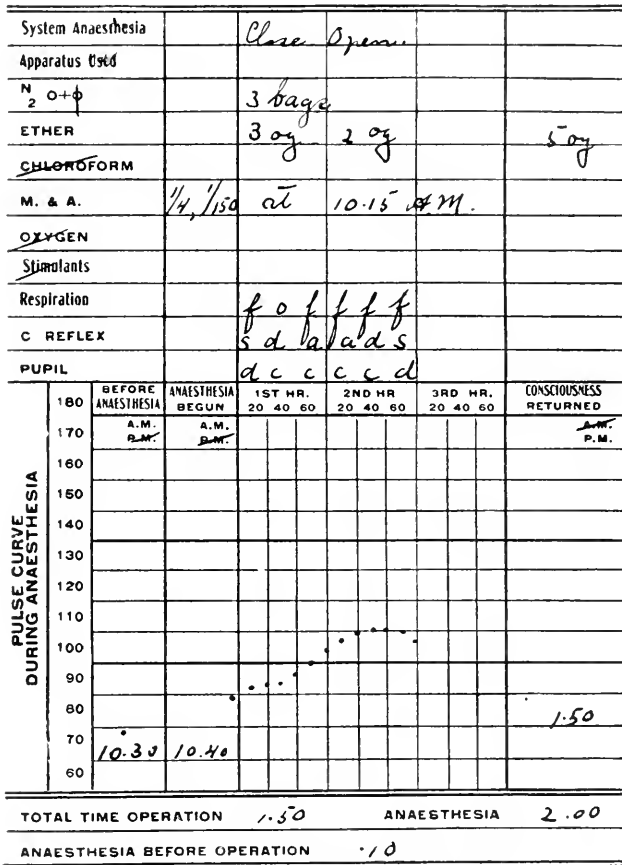

FIG. 129.—Reverse of anaesthesia record card.

System of Anaesthesia.—Open, closed, pharyngeal, intratracheal, intravenous, rectal, etc.

M. & A.—Morphine and atropine.

Respiration.—Free, obstructed.

C. Reflex.—Sharp, dull, absent.

Pupil.—Normal, contracted, dilated.

Most records are squared off for five-minute pulse-readings. To save space twenty-minute divisions are here used. Five-minute readings may be shown by a dot one-fourth way across the space.*

* Reprinted modified from Journal of the American Medical Association.

CHAPTER XIX

ASPIRATORS

THE use of aspirators particularly for nose and throat work, is of interest to the anæsthetist, as their employment aids materially in controlling the freedom of the respiration.

Four types of aspirators may be recognized:

1. Where the suction is produced by a foot pump.
2. Where the suction is produced by water power.
3. Where the suction is produced by electricity.
4. Where the suction is produced by steam power.

The foot pump method is the most simple but the least efficient of the four methods. A foot pump sucker suitable for throat and abdominal work is shown in Fig. 130.

Aspiration by water power is quite popular. The suction which results is constant and quite efficient. When in use the apparatus is attached to any convenient water faucet. The amount of suction produced depends upon the head of water at command. If the faucet is located at the top of the building some difficulty may be experienced in securing sufficient water power to produce the desired result. The essential features of the apparatus are shown in Fig. 131.

Aspiration by electricity is often used where ether vapor is being delivered for throat work. In this case the suction produced by the blower which provides air to form the ether vapor is employed. The disadvantage of this particular arrangement lies in the fact that the air used to vaporize the ether is taken (by suction) from the de-

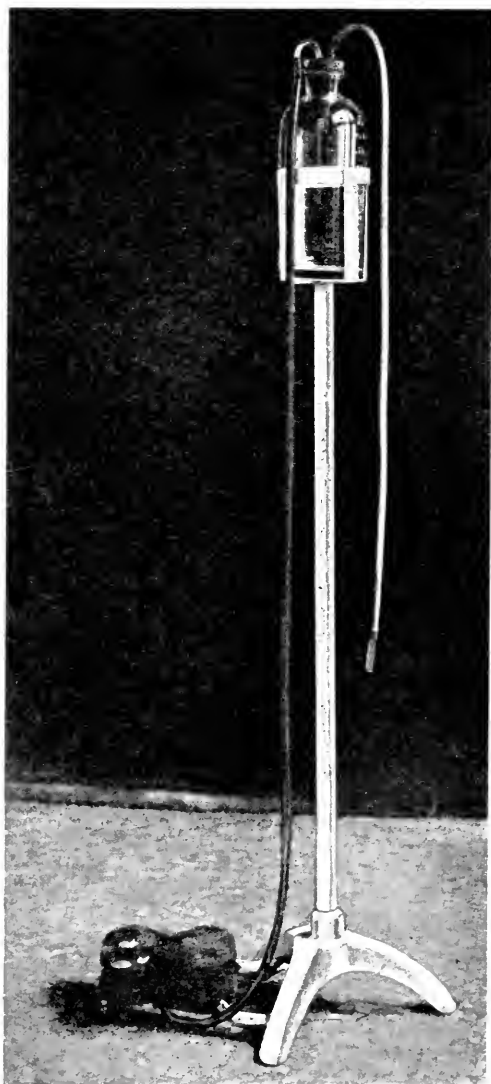

FIG. 130.—Foot aspirator, Roosevelt Hospital.

oxygenated and contaminated field of operation. The noise of the motor is often very annoying and a satisfac-

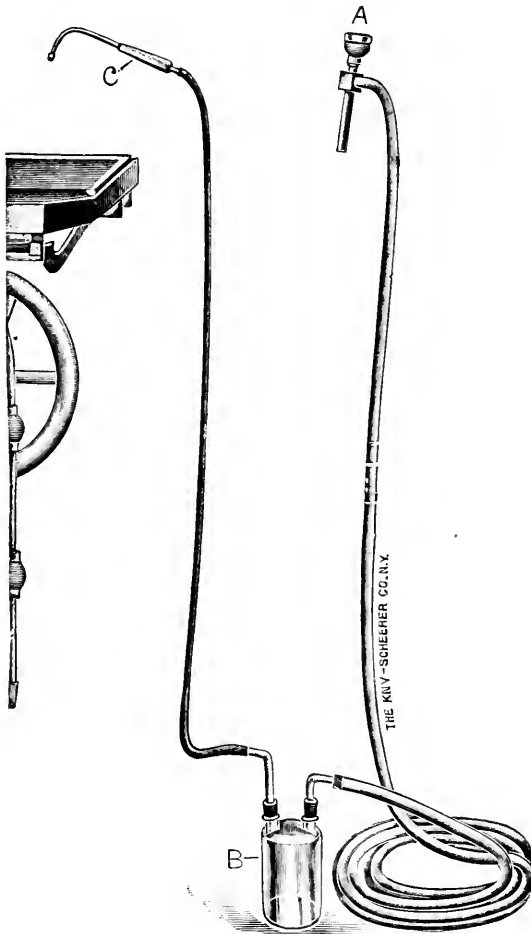

FIG. 131.—Water aspirator.

tory electrical supply must be near at hand. It has the advantage, however, of being very convenient. An example of such an apparatus is shown in Fig. 132.

Aspiration by steam. This type of aspiration is not only of value in nose and throat work, but plays even a larger part in removing fluid from the abdomen and else-

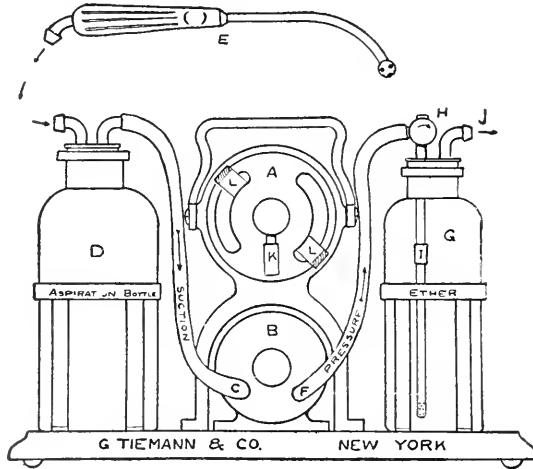

FIG. 132.—Electrical aspirator.

where. The utilizing of steam for suction purposes is brought about by the employment of what is known as an ejector. This ejector, a cross section of which is shown

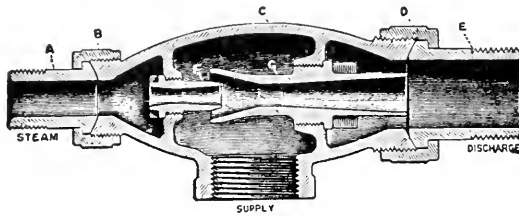

FIG. 133.—Ejector for steam aspirator.

in Fig. 133, may be purchased at any steam fitting establishment.

The steam in passing from *A* through *F* into *G* and finally into the discharge pipe *E* produces a partial vacuum

in the chamber enclosing *F* and *G*, which, being connected to the suction tubing marked "supply," performs the intended work.

The steam supply pipe *A* may be one which is tapped at any convenient place in the sterilizing room or else-

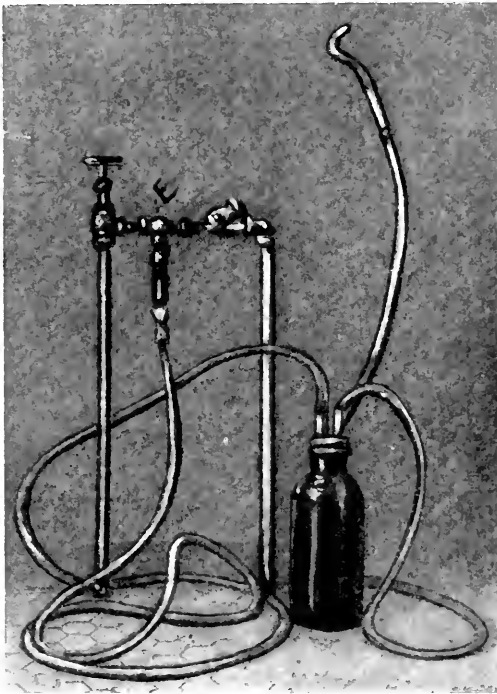

FIG. 134.—The steam pump aspirator complete with aspirating tongue depressor, Fordham Hospital.

where. The discharge pipe *E* may be led into a pail of water or be discharged at some point in the basement or out of doors.

Fig. 134 is a view of the entire apparatus in question—ejector, tubing, receiving bottle (for aspirated material) and aspirating tongue depressor.

The bottle which receives the discharge should have a capacity of about 2000 c.c. The tubing between the ejector and the bottle may be of pressure hose or, better still, flexible steel gas tubing, as shown in the illustration. This

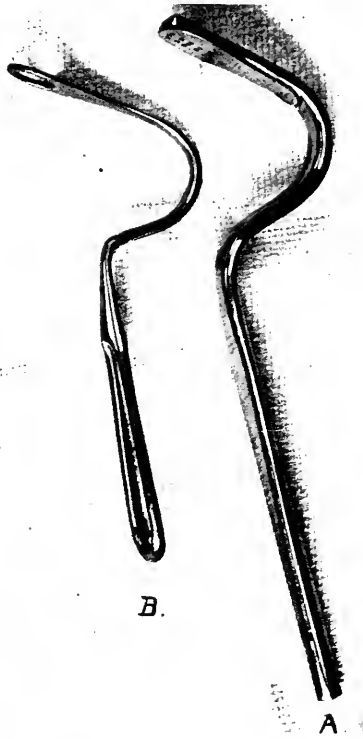

FIG. 135.—A, Aspirating tongue depressor; B, tongue depressor.

tubing should be at least fourteen to eighteen feet long. If a greater length is required it is more satisfactory to replace part of this by permanent piping from the ejector. The distal end of this tube is soldered to a length of brass tube perforating the cork in the bottle. This cork must

be considerably larger than the mouth of the bottle, else it will be sucked in by the powerful negative pressure.

The tubing from the bottle to the aspirating tongue depressor is of heavy non-collapsible rubber, capable of repeated sterilization.

Whatever may be the source of the suction produced, foot power, water, electrical or steam, the actual removal of the fluid is accomplished by variously shaped, perforated, metal tubes. A common type is shown accompanying the electrical aspirator. A tongue depressor which aspirates, however, is the ideal. Fig. 135*A* is the aspirator employed by the author. It is made to correspond as nearly as possible to the shape and size of a popular tongue depressor, shown in Fig. 135*B*, and when in use it does away with the necessity of employing an additional instrument, as it acts in the capacity of an efficient tongue depressor and aspirator at the same time.

CHAPTER XX

THE POINT OF VIEW OF THE PATIENT

MEDICINE for many of us is the centre about which the world revolves. We see life in its embryonic dawn. We follow it most closely in its morbidity through adolescence, maturity and decline, until at last the spontaneous metabolism is at an end. Lead on by experimental curiosity into the nature of things, we do not leave man here but dissect him with scalpel and microscope to the limit of present day instruments. By electrical and chemical stimuli we effect a parody on life; we make dead muscle move again, and look therein for the secret of life.

From within the circle drawn by medicine we limit our speculations as to the great truths. We build our theology out of coarse stuff and wonder why the edifice is so unsatisfactory. We ignore the more delicate tools of logic and philosophy, which are equally as truthful and more penetrating.

The medical man has a tendency to relegate the intellectual life to the obscure environment of psychiatry. The intellectual life to him, broadly speaking, is but the reaction to environment and of comparatively small account at best. The distinction which he draws in his own mind between a man and a monkey is not very acute. While not always openly acknowledged, many present day medical men serve the cult of materialism. With such a more or less well defined materialism they approach their patients. Their patients are the world.

The average layman has little or none of the physi-

cian's detailed knowledge and interest in histology and pathology. He has occupied his life in listening to the call of the "ego," that intangible, intellectual entity which is self. Such patients view medicine, and in viewing medicine, judge us from a point of view, which it would be well for many of us to appreciate. As a science cannot be broadly judged from its own plane but must needs be seen from without, so can we best serve our patients by viewing our profession from without.

The wealthy, by their influence, social and financial, obtain through the very atmosphere with which they surround themselves, a certain consideration, irrespective of our habitual personal mannerisms. The deference paid these by the materialistic man, by him who cannot understand the spiritual element, is a deference to the peculiar qualities which the former possess, their keen mentality, their natural refinement and their wealth, rather than to their deeper humanity. His sympathy finds its reward in immediate common interests. On this ground the materialist is fairly well remunerated, but what stimulus has he for a charity for which he can see no reward?

It is the poor who send up this cry; the poor in the great hospitals and dispensaries. Those from whom we feel that we tolerate much and who are perpetually in need of help. They cannot reward us by money, they cannot, and by nature often will not, reward us by sparkling wit or by dull thanks. If we would be compensated we must see an image of the Almighty in their presence. We must feel the unspoken thanks which illiteracy cannot utter. We must look beyond the colorless environment of the hospital ward and see the situation from their point of view.

Let us pass from the narrow confines of their station in life and go with them to the great hospital with its subtle wonders, a universe in itself. Here the house surgeon wields a monarch's sway. By his orders we fast or eat, we are allowed to go about or we are obliged to stay abed all the day. He controls the nurses, who have power enough, goodness knows, when he is absent.

As for the visiting surgeon, he is a sort of a deity. He rules even the house surgeon. His will is law and his every remark is treasured up to be produced at intervals for the benefit of a coterie of friends. Imagine that celestial body, as he moves about in his orbit stopping before one of these people. Imagine the pain inflicted by a curt remark, by a rough manipulation or by a misapplied pun, forgotten in the saying perhaps by him, but treasured through the long, uneventful day by the patient; imagine the unsatisfied thirst for just a little information when the sudden declaration is made: "We will operate to-morrow at three."

To-morrow dawns at last, but it is a long wait before afternoon. During the wait one has nothing to eat and is nervous with apprehension. Three o'clock finally arrives but the minutes pass by in suspense until it is perhaps nearly four; then quite accidentally a nurse may think to inform the patient that the doctor called a few hours ago to say that he had decided to postpone the operation until the following day. The operating staff had been informed of course, but no one had remembered to tell the patient. Then follows the sudden relapse when the tension is released. The suspense is only prolonged, however, for the next day is to come. But now the possibility of a second delay enters in and nothing is sure until

the stretcher is brought and the patient is conveyed to the operating room.

The anæsthetist is unconcerned. From his point of view the patient entered into his presence from apparent oblivion and will leave him in real oblivion. Perhaps it is a little woman, who trembles now and then; whose teeth chatter and whose eyes persist in filling up in spite of herself. If the anæsthetist would only see her point of view, he could not refuse to comfort her; but instead of this, in an impersonal, colorless voice he sharply remarks "Here, stop that nonsense. We can't have any of this fuss." If he only knew how impossible it was for the patient to control herself and how gladly she would stop "that nonsense," if she could. In an equally impersonal manner she is told that no one is going to hurt her, or, what is worse, the anæsthetist may calmly putter for an interminable time in his preparations and when about to start is told to wait, as the case under operation is not far enough advanced to start the next one. Then follows another delay of perhaps half an hour in the close etherizing room with every minute threatening a climax. Finally the order is given to start the anæsthetic. Speed is essential, hence concentrated ether, hence cough, suffocation, strangling and a sense of sinking into utter nothingness. An effort to free one's self, and one's hands are pinned down on one's breast, which pressure adds to the distress. Long before consciousness is lost someone cries out "Soak it to her, soak it to her." These last words echoing and re-echoing down the long vista leading out of consciousness.

This is not intentional cruelty, it is the result of high pressure, of system gone mad and most of all of the lack of appreciation of the patient's point of view.

But the reduction of the ego to a greater or less amount of Nissel's granules does not elevate one's views, it but concentrates them. The motive is analogous to that of pure conservation of energy in a machine. It does not attract all. It appeals mostly to the pathologist, to the histologist or to the biologist and its consideration proceeds not from a warm sympathy but from good policy.

There are possibilities in men outside the limits of ions and their uncounted subdivisions. There are qualities inherent in that hidden power, which is born in the union of sperm and ovum, predominating and directing cell division, assigning each to its delicate community task. It is this intelligence which permits the organism to adopt itself to its peculiar circumstances with the marvelous aptitude which we know so well. It controls a system of repair and defense so complex that we can but theorize as to the mode of its action. As we direct our attention to the physiology and the organic chemistry of the cell, we lose sight of the larger, more amazing community life of the countless groups of differentiated cells, each working along independent lines for the common good. These groups, if not guided in their ensemble by a central authority, could never adapt themselves to the vicissitudes of environment.

One need not follow the isms of the faddists to be up to date. Truth is not a matter of time or place, it is unchangeable. The acknowledgment of the existence of the supernatural in the soul of man is not an evidence of reversion in type. It is but the result of the acceptance and of the intelligent correlation of a host of facts which we see about us.

Admitting the presence of a soul, and as the logical

sequence the attributes and adornments of the soul, may we not awaken and develop the loveliest of these, charity, seeing in man, however poor and illiterate, the seal of divinity. Courtesy is honored when found in such company.

A man who can see the divine, has an incentive which is impossible in the case of the mere microscopist. He can understand that charity is its own reward and as a consequence he offers it whenever possible.

We can therefore, in adopting the patient's point of view, eliminate much pain and distress. The acceptance of such a course involves no expense. A moment of thoughtfulness is all that is required. A word, a smile or a sympathetic glance will do much to lighten anxiety and pain. Morning operations when possible; avoidance of postponements; a morphine precedence; unflinching courtesy and consideration—all these may seem trifles, but in reality are marks of human kindness.

In such a measure as a man spends his efforts in doing good to others, in just such measures will he find peace and contentment within himself.

BIBLIOGRAPHY

CARBON DIOXIDE AND REBREATHING

GATCH, W.: Nitrous Oxide Oxygen Anæsthesia by the Method of Rebreathing, *Journal A. M. A.*, March 5, 1910, p. 775.

The Use of Rebreathing in the Administration of Anæsthetics, Nov. 11, 1911, p. 1593.

ROVING: Abdominal Surgery, Clinical Lectures for Students and Physicians. Translation by Pilcher, Philadelphia, 1914.

HENDERSON-YANDELL: 1. *Am. Jour. Physiology*, 1909, 24; 66.

2. Acapnia and Shock (seven papers), *Am. Jour. Physiology*, 1908-1913.

3. Respiratory Experiments on Man. *The Jour. A. M. A.*, April 11, 1914, p. 1133.

4. *Tr. Am. Gynec. Soc.*, 1914.

5. *Surg., Gynec. and Obstetrics*, 1914, p. 386.

6. Shock After Laparotomy; Its Prevention, Production and Relief. *Am. J. Physiol.*, 1909, 21, 60.

7. Fatal Apnœa and the Shock Problem. *Johns Hopkins Hospital Bulletin*, Aug. 1910, 21, No. 233.

BARCROFT: *Respiratory Function of the Blood*. Cambridge, 1914.

BRYANT and HENDERSON: Closed Ether and a Color Sign. *Jour. A. M. A.*, July 3, 1915, p. 1.

LEVI ETTORE: Studies on the Patho-Physiologic Action of CO₂ and on the Therapeutic Applications in Surgery and Medicine of Mixture of (O) and CO₂. *Estr. d. rev. di. clin. med.*, 1910, 11, 30, 31.

- HILL and FLACK: The Effect of Excess of Carbon Dioxide and a Want of Oxygen on the Respiration and the Circulation. *Jour. Physiol.*, June 30, 1908.
- CROWDER, T. R.: A Study of the Ventilation of Sleeping Cars. *Arch. Int. Med.*, Jan. 15, 1911, 85.
- HALDANE and SMITH: The Physiologic Effects of Air Vitiated by Respiration. *J. Path. and Bact.*, 1892 and 1893, 1, 168, 318.
- ERCLENTS FLUGGE: Report of Experiments at the Institute of Hygiene at Breslau. *Z. f. Hyg.*, 1905, 363, 388, 405, 433.
- HILL and WALKER: The Relative Influence of the Heat and Chemical Impurity of Close Air. *J. Physiol.*, Nov. 9, 1910.

INDEX

- Abdominal distention, 29
Abnormal amplitude during maintenance, 88
Abnormal rate during maintenance, 86
Abnormal respiration due to Trendelenburg position, 89
Abnormal rhythm during maintenance, 87
Abnormalities of respiration in recovery, 89-90
Acapnia, 299
Adenoids, obstruction from, 26
Alcohol chloroform ether mixture, 191-193
Amplitude of respiration, 86-88
Anaesthetist's records, 318-320
Anaesthesia by anoci association, 244-248
Anaesthesia, place of, 18
 preliminary medication in, 277-284
 signs of, 82
Anaesthetic and asthma, 35
 and pneumonia, 35
 for goitre cases, 35
 history, 16
 period, 4-6
Anoci association, 244-248
Apparatus, Bennett, 139
 Connell, 153
 Flagg, 133-138
 Miller, 230
Artificial respiration, 90-97
Aspirating tongue depressor, 327
Aspirators, 321-327
Asthma with anaesthesia, 35
Atropine and morphine preliminary to anaesthesia, 277-284
Bennett apparatus, 139
 method, 138-140
Brachial paralysis, 41-42
Breathing tube, 33-34, 317
Bromides preliminary to anaesthesia, 277
Carbon dioxide and cyanosis, 298-299
 and rebreathing, 296-307
 chemistry of, 297-298
 effect of increasing amount in blood, 300-301
 effect of reducing amount in blood, 299
 in the blood, 297-298
 origin of, 297-298
 percentage to cause dyspnoea, 296
 percentage to stimulate respiration, 296
Cardiac massage, 119
Cerebral hemorrhage, 88
Cheyne-Stokes respiration, 88-90
Chloroform, 185-200
 administration of, 194
 containers for, 194
 delayed poisoning with, 186-192
 testing quality of, 310
Chloroform anaesthesia, apparatus for, 194-195
 causes of death in, 195-197
 general considerations of, 200
 mortality in, 200
 position for, 197-200
 present status of, 190-192
 signs of, 197-199
Chloroform ether anaesthesia, 193
Chloroform poisoning, pathology of, 186-192
Circulatory shock, 292
Close drop method, 132
 as compared with open drop, 140
 as compared with semi-open drop, 141
 requirements for, 132
Coaxing the reflexing, 20
Cocaine solution for local anaesthesia, 256
Coccygeal operations, position for, 43
Combined general and local anaesthesia, 244-248
Complete anaesthesia, curve of, 12
 stages of, 11
Conductive anaesthesia, administration, 259
Constant maintenance, control of, 71
 pressure of vapor delivered, 70
 volume employed in, 70
Containers for nitrous oxide, 201-202
Control of vomiting, 79
Color signs, 97-102
 with closed method, 99-101
 with jaundice, 101
 with negroes, 101
 with open method, 99
Conjunctivo-palpebral reflex, 106
Corneal reflex, 106-107
Cyanosis and carbon dioxide, 298-299
Cyanosis, post-operative, 289
Degeneration of liver with chloroform, 186-192
Deviated septum, obstruction from, 26
Diaphragmatic sign, 104

- Diet, post-operative, 7, 295
 preliminary, 17
- Diffusible solution, 262
- Dilatation of sphincters, 28
- Distention, abdominal, 29
- Driving the reflexes, 20
- Drop bottle, 123
- Duties of Nurse after anaesthesia, 287
 before anaesthesia, 285-287
 during anaesthesia, 287
- Emergency anaesthesia, 308-318
 accessories to, 317
 chloroform in, 314
 ethyl chloride in, 314
- Endoneural injection, 260
- Erb's palsy, 41
- Esmarch's bandage, anaesthesia with, 251
- Estimating amount of nitrous oxide in cylinder, 202
- Ether, absorption of, 66
 administration of by oral insufflation, 121
 anaesthesia, zones of, 72
 conc, 311-313
 effect on viscera, 189, 190
 frolics, 4
 intravenous administration of, 174-180
 per rectum, 169
 preparation for rectal administration, 169
 properties of, 120
 rectal administration of, 172
 saturation, 26
 solution for intravenous administration, 311-313
 tension in body, 69
 testing quality of, 309
 vapor tension of, 64
- Ethyl chloride, 181-184
 administration of, 183, 184
 apparatus for, 183
 dangers of, 184
 freezing with, 249, 250
 properties of, 181
- Ethyl chloride, anaesthesia, sequelæ of, 183
- Excitement in induction, 19
- Eyelid signs, 103
- Eye sign, 105
- Facepiece for open drop method, 122
- Flagg apparatus, 133-138
 anaesthesia with, 135
 features of, 134
 induction with, 135
 maintenance with, 136
 recovery with, 138
 vaporization in, 134
- Flagg method, 135-138
- First surgical anaesthesia, 4
- Freezing with ethyl chloride, 249, 250
- Gall bladder position, 43
- General anaesthesia, classes of, 11
 definition of, 9
 degrees of, 11
 production of, 9
- Glottis, œdema of, 26-34
- Goitre cases with anaesthesia, 35
- Gwathmey method of rectal anaesthesia, 171-173
- Hemorrhage, 291
 cerebral, 88
- Henry's law, 65
- History of anaesthesia, 1-6
- Hypercapnia, 299
- Hypodermoclysis, technic of, 117
- Hysteria, 292, 293
- Induction, time of, 12
- Improvised breathing cone, 311-313
- Improvised breathing tube, 317
- Incomplete anaesthesia, 13
 curve of, 13
- Induction, 15
- Induction, periods of, 15
- Infiltration anaesthesia, administration of, 258
- Infusion, technic of, 114
- Intra-abdominal administration of saline, 317
- Intrapharyngeal insufflation, 149-158
 administration, 153-157
 apparatus for, 150-156
 contra-indication, 158
 difficulties of, 167
 improvised, 314-315
 indications for, 158
- Intratracheal insufflation, 159-169
 administration, 163-167
 advantages of, 168
 apparatus for, 161-163
 difficulties of, 167
 disadvantages of, 168
 improvised, 315, 316
- Intravenous anaesthesia, 174-180
 administration of, 177-179
 advantages of, 179
 apparatus for, 176
 disadvantages of, 179, 180
 ether solution for, 175
 post-operative treatment in, 179
- Intubation, technic of, 164, 165
- Jackson laryngoscope, 163
- Jaundice in anaesthesia, 101

- Kidney position, 43**
Kuatzu method of resuscitation, 1181, 19
- Laryngoscope, Jackson's, 163**
Lewis' pendulum swing, 95
Lid reflex, 103, 105, 106
Liquid method of oral insufflation, 122
Lithotomy position, 53
Liver, fatty degeneration with chloroform, 186-192
- Local anaesthesia, 249-260**
 by freezing, 249
 by pressure, 250-251
 definition, 9
 needles for, 257
 preliminary treatment for, 257-258
 production of, 9-10
 solution of cocaine for, 256
 novocaine for, 256
 quinine and urea for, 256
 syringe for, 257
 unusual methods of, 249-254
 usual methods of, 255-260
- Maintenance, 59-67**
 constant, 60
 control of, 61-63
 curve of, 60-64
 vapor tension necessary for, 67
 variable, 60-61
- Masseteric sign, 102**
 spasm, 290
- Methods of anaesthesia, Bennett, 138-140**
 Flagg, 135-138
 Gwathmey, 171-173
 Miller, 230
- Mixed anaesthesia, 9, 10, 261, 273**
 definition of, 9
 administration, 265-273
 advantages of, 271
 apparatus for, 263
 disadvantages of, 273
 general considerations of, 261-265
 production of, 10
 treatment of overdose, 268
- Morphine and atropine preliminary to anaesthesia, 277**
 contra-indicated, 284
 indicated, 284
 scopolamin preliminary to anaesthesia, 277-281-284
- Mortality in chloroform anaesthesia, 200**
Mouth wedge, 33
Mucous, removal of, 34
Muscular signs, 102
Musculospiral paralysis, 41, 42
- Neck operations, position for, 47**
Needles for local anaesthesia, 257
Negative ventilation, 91
Nitrous oxide, administration, 207, 208
 apparatus, 133-138
 containers for, 201, 202
 preparation of, 203-206
- Nitrous oxide oxygen anaesthesia, 214-222**
 administration of, 218
 characteristics of, 216
 color in, 218
 eye signs in, 221
 physical signs in, 218-221
 preliminary medication in, 223
 pulse in, 221
 relaxation in, 220
 zones of, 234
- Nitrous oxide oxygen ether anaesthesia, 223-248**
 administration, 224-235
 administered by constant flow, 230-233
 intermittent flow, 225, 229
 difficulties in, 227, 229
 resume of 100 cases, 236-244
- Nondiffusible solution, 262**
Normal respiration with ether and nitrous oxide, 84
 with open method, 83
- Novocaine solution for local anaesthesia, 256**
Novocaine, intravenous injection of, 251, 252
- Obstructed respiration, causes of, 26**
 control of, 32
- Edema of the glottis, 26, 34**
Olfactory vomiting, control of, 79
Open drop method, 122, 127
 administration of, 125
 advantages of, 126
 apparatus for, 122
 disadvantages of, 127
 drop bottle for, 122
 facepiece for, 122
 in large clinics, 141-145
- Oral insufflation, methods of, 121, 122**
 vapor method, 145
- Orbital signs, 108**
- Paralysis, brachial, 41, 42**
 Erb's, 41
 musculospiral, 41, 42
 peroneal, 36
- Parson's sign, 108**

- Patient, point of view of, 328-333
- Period of excitement, 15
control of, 19
- Periods of induction, 1
- Period of relaxation, 57
- Peroneal paralysis, 36
- Pneumonia and anaesthesia, 35
- Pneumonia, post-operative, 295
- Polypi, obstruction from, 26
- Positive ventilation, 92
- Post-operative cyanosis, 289, 290
diet, 295
hysteria, 292, 293
pneumonia, 295
treatment of goitre cases, 295
vomiting, 288, 289
- Position for closure of abdominal wound, 53
coccygeal operations, 43
local operations, 43
neck operations, 47
rectal operations, 43
Trendelenburg, 36, 39
Walcher, 53
- Pre-anaesthetic period, 1-4
- Preliminary diet, 17
medication in anaesthesia, 17, 277-284
nitrous oxide anaesthesia, 283
visits, 16
use of morphine, 58
- Protracted unconsciousness, 293, 294
- Pressure gauge, 92-95
- Pseudo relaxation, 57
- Pseudo rigidity, 25-29
- Pupillary signs, 109-113
in induction, 110
in maintenance, 110-112
in recovery, 112-113
- Pulmonary embolus, 88
- Pulse in nitrous oxide anaesthesia, 221
signs, 113-119
rate, 114
rhythm, 113
volume, 114
- Quinine and urea for local anaesthesia, 256
- Rapid induction, conditions necessary for, 68
- Rate of recovery, 294
respiration, 86
- Rebreathing, 296-307
- Records, 318-320
- Recovery, 74-81
by crisis, 75
by lysis, 75
control of, 76-81
evidences of, 74
in diabetes, 75
- Recovery, stage of, 74
types of, 75
- Recovery room, 295
- Rectal administration of ether, 169-174
advantages of, 173, 174
apparatus for, 171
preliminary treatment for, 171
solutions used in, 171
- Regional anaesthesia, administration of, 259
- Regional intravenous injection of novocaine, 251, 252
- Relaxation, causes of, 58
control of, 59
evidences of, 57
in nitrous oxide oxygen anaesthesia, 220
of upper eyelid, 103
- Removal of throat tube, 77
- Respiratory abnormalities, 85-88
during induction, 85
maintenance, 86
in amplitude, 86, 88
in rhythm, 85, 87
failure, 291
symptoms, 82
- Restraint during induction, 22
- Resuscitation, Kutz method of, 118, 119
- Rigidity, 24-35
causes of, 25
control of, 32
Crile's theory of, 30
evidences of, 24
from dilatation of sphincters, 35
from intra-abdominal distention, 56
in gall bladder cases, 28, 35
in induction, 24
in pelvic operations, 28, 35
- Rose position, 53
- Saliva, removal of, 34
- Saturation with ether, 26
- Scopolamin and morphine preliminary to anaesthesia, 277-281-284
- Semi-open drop method, 127-132
advantages of, 131
apparatus for, 128
disadvantages of, 132
- Shock, 292
- Shoulder braces, 36
- Signs of anaesthesia, 82
color, 97, 102
diaphragmatic, 104
eye, 105
eyelid, 103
masseteric, 102
muscular, 102
orbital, 108
pupillary, 109, 113

- Signs of anaesthesia, Parson's, 108
 pulse, 113-119
- Simms' position, 40
- Spasm of vocal cords, 34
- Special senses during induction, 22
- Sphincters, dilatation of, 28
- Spinal anaesthesia, 261-273
 administration of, 265-268
 advantages, 271
 apparatus for, 263
 disadvantages of, 273
 general considerations of, 261-265
 treatment of overdose, 268
- Spinal puncture, treatment of, 265-268
- Stages of anaesthesia, 11
- Stage of induction, 11
 maintenance, 12
 recovery, 12, 74
- Stopping anaesthesia, 77
- Sylvester method of artificial respiration, 91,
 92, 94
- Syringe for local anaesthesia, 257
- Tension of ether in body during anaesthesia,
 69
- Terminal anaesthesia, administration of, 258
- Throat tubes, 33, 34
 removal of, 77
- Tongue depressor and aspirator, 327
- Tonsils, obstruction from, 26
- Trendelenburg position, 36-39
 contraindications, 39
 dangers of, 39
 effect on respiration, 39
 indications for, 39
 pulse in, 77
- Turbinates, obstruction from, 26
- Types of anaesthesia, 9
- Urea and quinine in local anaesthesia, 256
- Unconsciousness protracted, 293, 294
- Vaporization, 64
 physics of, 64, 65
- Vapor method, 145-148
 apparatus for, 146-148
 ether administered by, 148
 oral insufflation with, 122
- Vapor tension of ether, 64
- Ventilation, negative, 92
 positive, 92
- Visit, preliminary, 16
- Vocal cords, spasm of, 34
- Vomiting, control of, 79
 post-operative, 288, 289
 olfactory, 79
- Vomitus, removal of, 34
- Walcher position, 53
- Zones of ether anaesthesia, 72
- Zones of nitrous oxide oxygen anaesthesia, 234

UNIVERSITY OF CALIFORNIA LIBRARY
Los Angeles

This book is DUE on the last date stamped below.

JAN 29 1960

LIBRARY OF THE
UNIVERSITY OF CALIFORNIA

UNIVERSITY OF CALIFORNIA RESEARCH LIBRARY

AUG 15 2000

NOT RENEWABLE

3101 E. 8th St. Los Angeles, CA 90058

Form L9-42m-8,'49 (B5573)444

THE LIBRARY
UNIVERSITY OF CALIFORNIA
LOS ANGELES

110
200
F597a
1916



3 1158 00343 4049

UC SOUTHERN REGIONAL LIBRARY FACILITY



A 000 372 870 6

University of California
SOUTHERN REGIONAL LIBRARY FACILITY
405 Hilgard Avenue, Los Angeles, CA 90024-1388
Return this material to the library
from which it was borrowed.

