









# THE METALLURGY OF THE COMMON METALS

Gold, Silver, Iron (and Steel),  
Copper, Lead and Zinc

BY

LEONARD S. AUSTIN

*Formerly Professor of Metallurgy and Ore Dressing,  
Michigan College of Mines*

FIFTH EDITION

REVISED AND ENLARGED

NEW YORK  
JOHN WILEY & SONS, INC.

LONDON: CHAPMAN & HALL, LIMITED

1921

TN 665  
A 2  
1921

COPYRIGHT

First	Edition,	Mining & Scientific Press,	1907
Second	"	"	1909
Third	"	"	1911
Fourth	"	"	1913
Fifth	"	LEONARD S. AUSTIN	1921



C. E. P.

## PREFACE TO THE FIFTH EDITION

---

SINCE 1913, the date of the last edition, such radical changes and improvements have been made in the metallurgy of the common metals, that this edition of 1921 has been largely rewritten to bring it in accord with present practice, as will be seen by examination of the following pages. Great pains have been taken to clearly set forth underlying principles and at the same time to give the details of methods and of metallurgical equipment, and their cost. It is realized that, due to the rapid advance in prices, the costs of operation have lately been subject to serious modification. A chapter has been devoted to questions of the economic situation of the business of metallurgy. Little attempt has been made to describe methods not now in use.

L. S. AUSTIN.

LOS ANGELES, May 1, 1921.

## PREFACE TO THE FIRST EDITION

---

THIS outline of the metallurgy of the common metals, namely, gold, silver, iron, copper, lead, and zinc, is devoted to the description of processes for winning these metals from their ores and then refining them. The metallurgy of iron is treated only to the point where pig-iron is obtained.

Following the description of ores, as well as of the fuels used in smelting them, and the materials of which the furnaces are constructed, we come to the sampling, for the determination of the exact value of the ore before treatment.

A chapter has been devoted to the subject of thermo-chemistry as applied to igneous methods of extraction. The winning or reduction of the various metals is then taken up in order, and is followed by a description of the methods of refining them. Attention is then given to commercial considerations, since the processes must be conducted in a profitable way.

The author is indebted to Mr. F. L. Bosqui, who has not only read the manuscript, but has modified the portion devoted to the cyaniding of gold and silver ores, as his special knowledge has justified. For the subject matter relating to the smelting of silver-lead and copper ores, the

author has drawn on his own experience, gained during a quarter of a century of practical work.

L. S. AUSTIN.

HOUGHTON, May 1, 1907.

## PREFACE TO THE SECOND EDITION

---

THE experience gained in using the first edition has suggested many changes, and the book has accordingly been re-written, adding new matter, describing other processes, and keeping step with modern practice.

In Part I the subject of thermo-chemistry has been expanded, and a table of heats of formation given. The description of the cyanide process has been amplified and brought up to date, for milling methods are being rapidly improved, and cyanidation is having increased application, especially in the treatment of silver-bearing ores. The metallurgy of zinc has been treated more fully, and particular attention given to the principles underlying the smelting of zinc ores.

In the part devoted to refining there has been added the making of wrought-iron and steel, the refining of zinc, and the electrolytic refining of lead.

Plant and equipment is placed in a separate chapter, while the division describing the economics of metallurgy has been thrown into a more systematic form. The author is indebted to Mr. E. A. Hersam, who read the manuscript of the second edition and made numerous suggestions and corrections.

The author is indebted to the following companies for the use of certain of the illustrations in this book: Allis-Chalmers Co., Milwaukee, Wis.; Power & Mining Machinery Co., Cudahy, Wis.; Chisholm, Matthew & Co., Colorado Springs, Colo.; F. M. Davis Iron Works Co., Denver, Colo.; Stearns-Roger Mfg. Co., Denver, Colo.; Pacific Tank Co., San Francisco, Cal.; Redwood Manufacturers Co., San Francisco, Cal.; Galigher Machinery Co., Salt Lake City, Utah; Traylor Engineering Co., Allentown, Pa.; Blaisdell Co., Los Angeles, Cal.; Denver Engineering Works Co., Denver, Colo.; Trent Engineering & Machinery Co., Salt Lake City, Utah; Risdon Iron Works, San Francisco, Cal.; Colorado Iron Works Co., Denver, Colo.; Cyanide Plant Supply Co., Ltd., London; The Jeffrey Mfg. Co., Columbus, Ohio.

L. S. AUSTIN.

HOUGHTON, August 1, 1909.

PREFACE TO THE THIRD EDITION

---

THE present edition has been more systematically arranged, and errors have been eliminated. Important and recent changes in smelting practice and in the cyanidation of gold and silver ores have justified the insertion of additional matter, much of which has come under the direct observation and inquiries of the author.

L. S. AUSTIN.

SALT LAKE CITY, UTAH, March 1, 1911.

PREFACE TO THE FOURTH EDITION

---

IN this edition, that part of Chapters X and XIV which discusses the cyaniding of gold and silver ores respectively, has been written by M. W. von Bernewitz, formerly of the Associated Northern and Associated Mines, Kalgoorlie, Western Australia, and now on the staff of the *Mining and Scientific Press*. The chapter on the metallurgy of zinc has been re-written by Mr. R. G. Hall, long manager for the United Zinc & Chemical Co., and later in general consulting practice. These gentlemen are specially qualified for the subjects they have undertaken and have incorporated the recent practice in the art.

L. S. AUSTIN.

SALT LAKE CITY, UTAH, August 15, 1913.

for our Simmons and  
 6) Magnetic separator  
 for our Simmons.

	ch I	- 3	
	1 ch II - V	32 p	
	5 ch III	7 p	
	7 ch IV	9	
	2 ch V	3	
		<hr/>	54
			3
	3 ch VI	48	
	4 ch VII		
		<hr/>	10



# CONTENTS

## PART I—GENERAL METALLURGY

### CHAPTER I

#### ORES AND METALS:

	PAGE
Definition and Classification of Ores.....	3
Methods of Treatment.....	4
Classification of Metallurgical Operations.....	5
Principles Relating to the Refining of Metals.....	5
Physical Constants (Metals and Gases).....	6
Moulding and Casting Metals.....	7

### CHAPTER II

#### FUELS:

Fuels.....	11
The Natural Solid Fuels.....	12
Producer Gas.....	23
Pulverized Coal.....	29

### CHAPTER III

#### REFRACTORIES:

Refractory Materials and Their Properties.....	31
Acid Refractories.....	32
Neutral and Basic Refractories.....	37

### CHAPTER IV

#### THE PREPARATION OF ORES:

Principles of Sampling.....	39
Receiving, sampling, crushing, bedding and storing ores.....	40
Sampling Metals.....	48

### CHAPTER V

#### CRUSHING, GRINDING, SCREENING AND CLASSIFYING:

Principles of Crushing.....	50
Coarse or Primary Crushing.....	51
Intermediate or Fine Crushing or Coarse Grinding.....	55
Fine Grinding.....	64
Screening.....	66
Classifying.....	68

## CHAPTER VI

## METALLURGICAL FURNACES:

	PAGE
Shaft Furnace.....	72
Reverberatory Furnace.....	73

## CHAPTER VII

## COMBUSTION:

Principles of Combustion.....	75
Temperatures of Combustion.....	79

## CHAPTER VIII

## METALLURGICAL THERMO-CHEMISTRY:

Methods of Determining Thermic Values.....	84
Heats of Formation of Chemical Elements.....	86

## CHAPTER IX

## ROASTING:

Kinds of Roasting.....	88
Chemistry of Roasting.....	89
Roasting Ores in Lump Form; Heap-roasting.....	92
Roasting of Ores in Pulverized Condition.....	94
The Long-hearth Reverberatory Roaster.....	95
Mechanically-operated Roasting Furnaces.....	97
Roasting of Matte.....	108
Losses in Roasting.....	108
Capacity of Furnaces and Cost of Roasting.....	109
Blast or Pot-roasting.....	110
Sinter Roasting.....	110
Triple Roasting.....	113

## CHAPTER X

## CONCENTRATION OF ORES AS A SUBSIDIARY OPERATION IN METALLURGY:

Concentration.....	114
Flotation.....	116

## PART II—GOLD

## CHAPTER XI

## GOLD ORES AND CLASSIFICATION FOR MILLING:

Occurrence.....	121
Valuation of Gold and Silver.....	122
Classification for Milling.....	122

## CHAPTER XII

## AMALGAMATION:

Stamp Milling with Plate Amalgamation.....	124
General Arrangement of a Gold Stamp-mill.....	130
Concentration in Stamp-milling.....	131

## CHAPTER XIII

## HYDROMETALLURGY OF GOLD ORES:

	PAGE
Milling Ores in Aqueous Solution.....	133

## CHAPTER XIV

## CHLORINATION OF GOLD ORES:

Ores Suited to Chlorination.....	135
The Goldfield Chlorine Mill Co., Goldfield, Nev.....	136
Barrel Chlorination.....	137

## CHAPTER XV

## CYANIDING OF GOLD ORES:

Outline of the Process of Cyaniding.....	143
Ores for Cyanidation.....	145
Chemistry of the Cyanide Process for Gold Ores.....	146
The Standard Systems of Cyaniding.....	150
Sand Leaching.....	151
Double Treatment.....	153
Filter-Slime Treatment.....	157
Slime-Agitation.....	157
Pneumatic Agitators.....	158
Mechanical Agitators.....	159
Combined Mechanical and Pneumatic Agitators.....	160
Agitation Treatment.....	161
Continuous Counter-current Decantation.....	165
Filtration or Separation of Metal-bearing Solution from Slime.....	166
Vacuum Filtration.....	168
Pressure Filtration.....	171
General Remarks on Filters.....	175
The Crowe Vacuum Process.....	177
The Précipitation of Gold from Cyanide Solutions.....	177
The Merrill Précipitation Process.....	178
The Zinc or Extractor Box.....	181
The Clean-up.....	182
Drying and Refining the Gold Précipitate.....	184
Refining with Bichromate.....	184
Capital Costs of Slime Plants.....	186
Costs of Dissolution by Slime Agitation.....	186

## CHAPTER XVI

## TYPICAL GOLD-MILL PRACTICE:

Cyaniding Free-milling Porous Ores.....	189
The Wasp No. 2 Mill, South Dakota.....	189
Ores of Clayey Nature by Cyaniding.....	189
The Victorious Mill, Western Australia.....	190
The Kolar Field.....	191
The City-deep Mill.....	191
The Mill of the Consolidated Langlaaghte Co., Rand, South Africa.....	193
The Homestake Mill, Lead, South Dakota.....	195
The Liberty Bell Mill, Telluride, Colo.....	199

	PAGE
Treatment of Telluride Ores.....	199
The Golden Cycle Mill.....	201
The Victor Plant of the Portland Gold Mining Co.....	202
The Kalgoorlie District, Western Australia.....	203
The Oroya-Brownhill Mill, Kalgoorlie District.....	204
The Hollinger Mill, Porcupine District, Ontario.....	205
The Tom Reed Mill, Oatman, Ariz.....	207
The United Eastern Mill, Oatman, Ariz.....	209

## CHAPTER XVII

## TREATMENT OF GOLD-MILL CONCENTRATES:

Classification.....	213
The Alaska-Treadwell Concentrate Treatment Plant.....	215
Concentrate Treatment at the Goldfield Consolidated, Goldfield, Nev.....	218

## CHAPTER XVIII

## VARIOUS TREATMENTS AND CALCULATIONS:

Flotation and Cyaniding.....	223
Drying and Cyaniding.....	223
Treatment of Tailings from Acid or Ammonia Leaching.....	223
Calculation of Tonnages in Mills.....	223

## CHAPTER XIX

## SMELTING GOLD ORES:

Blast-furnace-smelting <i>vs.</i> Cyaniding of Gold Ores.....	226
The Price of Gold Ores. Also the Cost of Producing and Selling. The Price of Gold.....	227

## PART III—SILVER

## CHAPTER XX

## SILVER, ITS ORES AND THEIR TREATMENT:

Characteristics of Silver Ores.....	231
Extraction of Silver from Ores.....	232
Treatment of Silver Ores.....	232

## CHAPTER XXI

## AMALGAMATION OF SILVER ORES:

Wet Silver Milling with Tank-settling.....	235
The Boss Process of Silver Milling.....	243
The High-grade Nipissing Mill, Cobalt, Ontario.....	243
Plate and Pan-Amalgamation and Concentration of Silver Ores.....	244
The Chloridizing Roasting of Silver Ores.....	246
Dry Silver Milling (Reese River Process).....	249
The Patio Process.....	249



## CHAPTER XXII

## SILVER MILLING BY HYDROMETALLURGICAL PROCESSES:

	PAGE
The Principles of the Hydrometallurgy of Silver.....	250
The Augustin Process.....	250
The Ziervogel Process.....	251
The Hyposulphite Lixiviation Process for Silver Ores.....	254
The Russell Process.....	254

## CHAPTER XXIII

## CYANIDATION OF SILVER ORES:

Principles of Cyanidation.....	256
The Precipitation of Silver from Cyanide Solution.....	257
The Santa Gertrudis Precipitating and Refining Plant.....	259
Precipitation by Aluminum Dust.....	261
Drying and Refining Silver Precipitate.....	261
Chemistry of the Process for Silver Ores.....	264
Typical Silver Mills.....	265
Belmont Milling Co.'s Mill, Tonopah, Nev.....	265
Cyanidation of Mixed Silver Ores at the San Francisco Mill, Pachuca, Mex.....	268
The Waihi Grand Junction Mill, Waihi, N. Z.....	270
Milling Practice at Cobalt, Ontario.....	274
The Nippissing Co.'s "Low-grade" Mill, Cabalt, Ontario.....	274

## CHAPTER XXIV

## PARTING GOLD-SILVER BULLION, PRICES AND COSTS:

Parting Gold-silver Ingots or Bars with Acids.....	278
Electrolytic Parting of Gold from Silver.....	279
Prices and Costs.....	280

## PART IV—IRON AND STEEL

## CHAPTER XXV

## IRON ORES AND THEIR SMELTING:

Classification and Occurrence of Iron Ores.....	283
Roasting Iron Ores.....	285
The Agglomeration of Fine Ores.....	286
Smelting for Pig Iron.....	287
Iron Blast-furnace and Plant.....	287
Gas Cleaning.....	287
Hot-blast Stoves.....	295
Blast-furnaces and Accessories.....	298
Operation of the Blast-furnace.....	300
Irregularities of Furnace Operation.....	302
Disposal of Slag or Cinder.....	303
Disposal of Pig Iron.....	304
Dry-air Blast.....	305
Chemical Reactions of the Blast-furnace.....	306
The Heat Balance of the Blast-furnace.....	309

	PAGE
Burdening the Blast-furnace.....	310
General Arrangement of the Blast-furnace Plant.....	312
Pig Iron.....	314
Classification of Pig Iron.....	314
Influence of the Contained Elements on the Character of the Pig Iron.....	316

## CHAPTER XXVI

## WROUGHT IRON AND STEEL:

The Manufacture of Wrought Iron by the Puddling Process.....	318
Steel Making.....	320
Steel Making by the Acid Bessemer Process.....	321
The Basic Bessemer Process.....	326
Steel Making in the Open-hearth Furnace.....	326
The Open-hearth Reverberatory Furnace.....	327
The Acid Open-hearth Process.....	333
Basic Open-hearth Process.....	334
Calculation of Charge.....	335
The Open-hearth Building.....	339
The Duplex Process of Steel Making.....	340
Duplex and Electric Furnace Plant.....	341
Electric Steel-making.....	343
Varieties of Steel.....	345
Iron Ore and Pig Iron Prices.....	347

## PART V—COPPER

## CHAPTER XXVII

## COPPER ORES AND THEIR TREATMENT:

Characteristics of Copper Ores.....	351
Extraction of Copper from Its Ores.....	353

## CHAPTER XXVIII

## COPPER BLAST-FURNACE SMELTING OF OXIDIZED ORES:

Blast-furnace Smelting of Oxidized Ores.....	355
Lake Superior Copper Country Smelting of Copper Reverberatory Slag....	357
Smelting to Black Copper by the Union Miniere du Haut Katanga.....	359

## CHAPTER XXIX

## BLAST-FURNACE SMELTING OF SULPHIDE ORES:

Matte Smelting.....	360
The Messiter System of Bedding.....	362
The Copper-matting Blast-furnace.....	364
Accessories of the Blast-furnace.....	367
Blast-furnace Conditions.....	369
Large Copper-smelting Blast-furnaces.....	369
Regular Operation of the Copper Blast-furnace.....	371
Copper Matte.....	373

	PAGE
Copper-furnace Slags.....	374
Calculation of Charge for Matte Smelting.....	375
Pyrite Matte Smelting.....	377
Reactions in Pyrite Matte Smelting.....	378
Calculation of Charge in Pyrite Smelting.....	381
Disposal of the Slag.....	384
Blast-furnace <i>vs.</i> Reverberatory Smelting.....	385

## CHAPTER XXX

## REVERBERATORY SMELTING:

The Welsh Process of Reverberatory Smelting.....	387
Smelting Operations by the Welsh Process.....	388
The Direct Process of Reverberatory Smelting.....	390
Large-scale Reverberatory Matte Smelting.....	390
The Direct Coal-fired Furnace.....	391
Furnaces Fired by Pulverized Coal.....	392
The Oil-fired Furnaces.....	395
Operation of a Large Reverberatory Furnace.....	397
Reactions and Calculation of the Charge.....	397

## CHAPTER XXXI

## CONVERTING COPPER-MATTE:

The Copper Converter.....	400
The Converter Lining.....	402
Operation of the Basic Converter.....	403
Chemical Reactions of the Converter.....	404
Blast-furnace Smelting and Converting Plant.....	406
Electrostatic Recovery of Copper Blast-furnace and Converter Dust.....	410
Works of the International Smelting Co.....	410
Costs of a Proposed Plant and Operation.....	414

## CHAPTER XXXII

## THE HYDROMETALLURGY OF COPPER:

Principles of the Hydrometallurgy of Copper.....	417
Extraction of Copper by Natural or Weathering Methods.....	418
The Rio Tinto Process.....	418
The Shannon Copper Company Process.....	421
Extraction of Copper as a Chloride.....	422
The Henderson Process.....	423
The Laist Process.....	426
Sulphuric Acid Leaching.....	429
The Butte-Duluth Process.....	430
The Ajo Process.....	432
Ammonia Leaching.....	438
Ammonia Leaching at Kennicott.....	439

## CHAPTER, XXXIII

## REFINING OF BLISTER-COPPER:

	PAGE
Copper Refining.....	442
Melting and Refining Lake Copper.....	444
The Making of Anodes and of Commercial Cathode Copper.....	446

## CHAPTER XXXIV

## ELECTROLYTIC COPPER REFINING:

Electrolytic Copper-refining Plant.....	449
Capital Requirements.....	455
Cost of Refinery and Operating Costs.....	456
Schedule of Copper Ore Prices.....	457

## PART VI—LEAD

## CHAPTER XXXV

## PROPERTIES OF LEAD AND ITS ORES:

Characteristics of Lead Ores.....	461
The Smelting of Lead-bearing Ores.....	463
Smelting on the Ore-hearth.....	463

## CHAPTER XXXVI

## SILVER-LEAD SMELTING:

Silver-lead Blast-furnace Smelting.....	467
Receiving, Sampling and Bedding of Lead Ores.....	467
General Arrangement of a Smelting Works.....	468
Bedding Ores at a Custom Works.....	469
The Silver-lead Blast-furnace.....	471
Open and Closed-top Blast-furnaces.....	475
Operating the Blast-furnace.....	476
Chemical Reactions and Physical Changes of the Blast-furnace.....	479
Slags in Silver-lead Smelting.....	480
Action of Various Bases in Slags.....	481
Fuel in Silver-lead Smelting.....	483
Calculation of a Blast-furnace Charge.....	484

## CHAPTER XXXVII

## PRODUCTS OF THE BLAST-BURNACE:

Flue-dust.....	487
The Bag-house.....	488
Briquetting Flue-dust.....	489
Lead-copper Matte.....	491
Comparison of Matte-treatment Methods.....	491
Converting of Leady Matte.....	492
Selling Price of Matte.....	493

## CHAPTER XXXVIII

## PRODUCTION OF LEAD ORES AND PRICES:

	PAGE
Costs of Lead Ores.....	494
Ore Prices; Mississippi Valley Smelting Works.....	495
Colorado and Utah Silver-lead Smelteries.....	495
Variation in Costs Due to Output, etc.....	497

## CHAPTER XXXIX

## REFINING OF LEAD AND BASE BULLION:

Refining Base-bullion.....	498
✓ The Refinery.....	499
Softening Base-bullion.....	500
The Parkes Process.....	503
Treatment of the Rich Lead.....	507
The Pattinson Process.....	510
Cost of Refining Base-bullion.....	511
Selling Price of Base-bullion.....	511
The Betts Process for the Electrolytic Refining of Lead.....	511
Smeltery and Refinery for Silver-lead Ores.....	513

## PART VII—ZINC

## CHAPTER XL

## ZINC AND ITS ORES:

Properties of Zinc.....	517
Zinc Ores.....	517

## CHAPTER XLI

## ROASTING ZINC ORES:

Reduction of Ores of Zinc.....	519
Roasting Blende.....	519
Chemistry of Roasting Zinc Ores.....	519
Roasting Furnaces.....	520
The Wedge Mechanical Blende-Roasting Furnace.....	521
The Hegeler Furnace.....	521
Various Furnaces.....	525
The Merton Furnace.....	525
The Ridge Furnace.....	525
Sulphuric Acid.....	527

## CHAPTER XLII

## SMELTING OF ZINC ORES:

Smelting or Distillation of Roasted Zinc Ores.....	528
Operating the Furnace.....	534
Manufacture of Retorts and Condensers.....	536
Loss in the Process.....	537
Cost of Smelting.....	538
Price of Zinc Ores and Spelter in 1919.....	539

## CHAPTER XLIII

## ZINC REFINING:

	PAGE
Grades of Spelter.....	540
The De Saulles Redistillation Method.....	542
Refining Spelter without Redistillation.....	542
Electrolytic Zinc.....	542

## PART VIII—PLANT AND EQUIPMENT AND THEIR COSTS

## CHAPTER XLIV

## LOCATION, EQUIPMENT AND ERECTION:

Location of Works.....	547
Nature of the Site to be Chosen.....	548
Construction of Plant.....	550

## CHAPTER XLV

## ACCESSORY EQUIPMENT OF PLANT:

Intermittent Handling of Materials.....	551
Industrial Locomotives.....	551
Industrial Cars and Hoists.....	553
Grabs and Excavators.....	555
Continuous Handling of Materials.....	557

## CHAPTER XLVI

## ORE STORAGE AND SUPPLY:

Provision for Supply.....	563
Feeders.....	563
Pumps and Elevators.....	566

## CHAPTER XLVII

## COST OF PLANTS:

Cost of Plant.....	569
Cost of Metallurgical Plants.....	571
Unit Construction Costs in 1914.....	572
Composite Costs.....	575

## PART IX—THE BUSINESS OF METALLURGY

## CHAPTER XLVIII

## THE GENERAL ECONOMIC SITUATION:

Distribution of Wealth.....	579
Economics of Engineering.....	579
The Labor Situation.....	580
Financial Crises in the U. S.....	583
Association of Employers.....	583

## CHAPTER XLIX

## ORGANIZATION AND OPERATING:

	PAGE
Organization of a Metallurgical Company.....	584
The Administrative Department.....	584
The Operating Department.....	585
Rules of Works.....	587
Plant Operation.....	587
Morale of Inside-men.....	588
Modes of Payment.....	589
Capital Requirements.....	591
The Accounting Department.....	592
Administration and General Charges.....	594
Typical Operating Department.....	594
The Purchasing and Selling Departments.....	595

## CHAPTER L

## PROFITS AND COSTS:

Profits.....	597
Custom Smelteries.....	598





## ERRATA

- page 8—Figure reference 14, 3d line from top, should read Figure 4.
- page 77—Figure reference 7, 7th line from top, should read Figure 14.
- page 78—Figure reference 122, 5th line from bottom, should read Figure 212.
- page 84—Figure reference 181A, 7th line from top, should read Figure 278.
- page 93—Figure reference 31, 11th line from bottom, should read Figure 70.
- page 130—Figure references 29 and 30, last line should read Figures 60 and 61.
- page 135—Figure reference 70, 7th line from bottom, should read Figure 71.
- page 260—Figure reference 117, 1st line, should read Figure 116A.
- page 322—Figure reference 104, 12th line from top, should read Figure 169.
- page 388—Figure reference 29, 15th line from top, should read Figure 63.
- page 405—Figure 131, should read Figure 221.
- page 421—Figure 221, should read Figure 230.
- page 446—Figure reference 147, 1st line, should read Figure 242.
- page 465—Figure 251, omitted.
- page 478—Figure reference 155, 14th line from bottom, should read Figure 263.
- page 523—Figure 283, should read Figure 282.
- page 525—Figure reference 384, 9th line from top, should read Figure 284.
- page 563—Figure references 15A, 40, 45, 98, 7th line from bottom, should read Figures 28, 76, 83 and 134.

# ERRATA

The following are the errors which have been discovered in the proof sheets of this work, and which have been corrected in the present edition. The errors are given in the order in which they occur in the text.

Page 1. Line 12. "The" should be "The".

Page 2. Line 15. "The" should be "The".

Page 3. Line 18. "The" should be "The".

Page 4. Line 21. "The" should be "The".

Page 5. Line 24. "The" should be "The".

Page 6. Line 27. "The" should be "The".

Page 7. Line 30. "The" should be "The".

Page 8. Line 33. "The" should be "The".

Page 9. Line 36. "The" should be "The".

Page 10. Line 39. "The" should be "The".

Page 11. Line 42. "The" should be "The".

Page 12. Line 45. "The" should be "The".

Page 13. Line 48. "The" should be "The".

Page 14. Line 51. "The" should be "The".

Page 15. Line 54. "The" should be "The".

Page 16. Line 57. "The" should be "The".

Page 17. Line 60. "The" should be "The".

Page 18. Line 63. "The" should be "The".

Page 19. Line 66. "The" should be "The".

Page 20. Line 69. "The" should be "The".

Page 21. Line 72. "The" should be "The".

Page 22. Line 75. "The" should be "The".

Page 23. Line 78. "The" should be "The".

Page 24. Line 81. "The" should be "The".

Page 25. Line 84. "The" should be "The".

Page 26. Line 87. "The" should be "The".

Page 27. Line 90. "The" should be "The".

Page 28. Line 93. "The" should be "The".

Page 29. Line 96. "The" should be "The".

Page 30. Line 99. "The" should be "The".

Page 31. Line 102. "The" should be "The".

Page 32. Line 105. "The" should be "The".

Page 33. Line 108. "The" should be "The".

Page 34. Line 111. "The" should be "The".

Page 35. Line 114. "The" should be "The".

Page 36. Line 117. "The" should be "The".

Page 37. Line 120. "The" should be "The".

Page 38. Line 123. "The" should be "The".

Page 39. Line 126. "The" should be "The".

Page 40. Line 129. "The" should be "The".

Page 41. Line 132. "The" should be "The".

Page 42. Line 135. "The" should be "The".

Page 43. Line 138. "The" should be "The".

Page 44. Line 141. "The" should be "The".

Page 45. Line 144. "The" should be "The".

Page 46. Line 147. "The" should be "The".

Page 47. Line 150. "The" should be "The".

Page 48. Line 153. "The" should be "The".

Page 49. Line 156. "The" should be "The".

Page 50. Line 159. "The" should be "The".

Page 51. Line 162. "The" should be "The".

Page 52. Line 165. "The" should be "The".

Page 53. Line 168. "The" should be "The".

Page 54. Line 171. "The" should be "The".

Page 55. Line 174. "The" should be "The".

Page 56. Line 177. "The" should be "The".

Page 57. Line 180. "The" should be "The".

Page 58. Line 183. "The" should be "The".

Page 59. Line 186. "The" should be "The".

Page 60. Line 189. "The" should be "The".

Page 61. Line 192. "The" should be "The".

Page 62. Line 195. "The" should be "The".

Page 63. Line 198. "The" should be "The".

Page 64. Line 201. "The" should be "The".

Page 65. Line 204. "The" should be "The".

Page 66. Line 207. "The" should be "The".

Page 67. Line 210. "The" should be "The".

Page 68. Line 213. "The" should be "The".

Page 69. Line 216. "The" should be "The".

Page 70. Line 219. "The" should be "The".

Page 71. Line 222. "The" should be "The".

Page 72. Line 225. "The" should be "The".

Page 73. Line 228. "The" should be "The".

Page 74. Line 231. "The" should be "The".

Page 75. Line 234. "The" should be "The".

Page 76. Line 237. "The" should be "The".

Page 77. Line 240. "The" should be "The".

Page 78. Line 243. "The" should be "The".

Page 79. Line 246. "The" should be "The".

Page 80. Line 249. "The" should be "The".

Page 81. Line 252. "The" should be "The".

Page 82. Line 255. "The" should be "The".

Page 83. Line 258. "The" should be "The".

Page 84. Line 261. "The" should be "The".

Page 85. Line 264. "The" should be "The".

Page 86. Line 267. "The" should be "The".

Page 87. Line 270. "The" should be "The".

Page 88. Line 273. "The" should be "The".

Page 89. Line 276. "The" should be "The".

Page 90. Line 279. "The" should be "The".

Page 91. Line 282. "The" should be "The".

Page 92. Line 285. "The" should be "The".

Page 93. Line 288. "The" should be "The".

Page 94. Line 291. "The" should be "The".

Page 95. Line 294. "The" should be "The".

Page 96. Line 297. "The" should be "The".

Page 97. Line 300. "The" should be "The".

Page 98. Line 303. "The" should be "The".

Page 99. Line 306. "The" should be "The".

Page 100. Line 309. "The" should be "The".

**PART I**  
**GENERAL METALLURGY**



## CHAPTER I

### ORES AND METALS

#### DEFINITION AND CLASSIFICATION OF ORES

**Definition.**—An ore from the standpoint of the metallurgist may be defined as a mineral aggregate containing metal, or metals, in sufficient quantity to make their extraction commercially profitable. Minerals or rocks containing 15 to 30 per cent iron would not be called iron ore, nor would we call a rock containing 2 to 3 oz. silver per ton a silver ore. On the other hand, the rock of the Treadwell mine, on Douglas Island, Alaska, carrying \$2.50 to \$3 in gold, is called a gold ore because it can be worked at a profit. In general, ores are named from their dominant metal (as lead, copper, or silver), though they may contain other metals. Thus a lead ore may contain silver and gold; a copper ore, besides copper, may contain silver, gold, and even lead. The appearance of an ore may indicate whether it carries lead, copper, iron, or zinc, but gold and silver minerals are not always visible, and the proper way to determine their presence is by assay.

**Straight or simple ores** contain in the main but one kind of metal, such as gold, silver, copper, or lead. Straight silver, or free-milling silver ores, are free from lead and copper, and may be treated by amalgamation. Straight gold ores, also free-milling, are those containing the gold in metallic form and amenable to amalgamation. Straight or plain lead, zinc, or copper ores do not contain gold or silver in quantity sufficient to pay to separate the precious metals from the base metal. As an example, a lead ore containing 4 oz. silver per ton would not ordinarily meet the cost of extracting the silver. Blister copper may contain as much as 12 oz. silver per ton and yet not pay the charge for electrolytic refining for its recovery. An ore containing little lead, say less than 5 per cent, is designated a dry ore. Such ore is often silicious, but possesses commercial value because it contains gold and silver. Ores carrying more than 5 to 10 per cent lead may be profitably treated for their lead alone. Copper ores also frequently contain gold and silver.

Mixed ores, or those containing two or more kinds of metal, are common, such as silver-gold, silver-gold-lead, or lead-zinc-copper-silver. When such ores contain both copper and lead it is puzzling at times to

know how to designate them. In doubtful cases smelting companies have purchased them either on the basis of their lead or copper content under the plea that, in extracting one of these metals, the other is lost or wasted. Lead-silver or lead-silver-gold ores are those which carry lead in such quantity that when the lead is recovered from them by smelting, the precious metals taken up by it can be later easily removed from the lead. Copper-silver, copper-silver-gold, or copper-gold ores, when smelted, yield their copper, and this, like lead, takes up the precious metals.

**Base-metal Ores.**—Lead and copper ores often contain zinc, antimony, arsenic, tellurium, or bismuth as impurities. These, in the process of reduction, alloy with the principal metal to its commercial detriment, and require expensive after-treatment to remove them. While a free-milling ore permits the extraction of most of its gold or silver by simple processes of grinding and amalgamation, a refractory or rebellious ore requires preliminary treatment by roasting before it can be amalgamated; otherwise it must be smelted. Even smelting ores may present difficulties of treatment that would cause them to be called rebellious. A docile ore, on the contrary, is one that may be easily treated. Gold and silver ores containing arsenic or antimony may be cited as examples of refractory ores.

#### METHODS OF TREATMENT

These may be divided broadly into milling or smelting plants. Mills treat gold and silver ores, according to their character, by concentration (including flotation), amalgamation, chlorination, cyaniding, or by combinations of these methods. Thus, the North Star Mine, Grass Valley, Cal., treats a gold and silver quartz ore (carrying sulphides) by amalgamation, concentration and cyaniding of the concentrates and tailings. The Tonopah-Belmont, a medium hard quartz silver ore carrying sulphides, uses concentration and cyaniding. Another mill, the Liberty Bell, Telluride, Colo., having a soft quartz silver ore, subjects it to amalgamation, concentration, and cyaniding of the tailings. Smelting ores may be basic, silicious, dry, coppery, or leady; while milling ores may be talcose, quartzose, raw, roasting, earthy, argillaceous, light, heavy, or base, all of which characteristics modify the mode of treatment. Among the iron ores we may have Bessemer ores or those containing not more than 0.045 per cent phosphorus, and non-Bessemer ores, or those so high in phosphorus that the pig iron made from them needs subsequent treatment in the basic open-hearth furnace to remove it.

An ore consists not only of the species of metallic compound from which it is named, but also of gangue or waste matter. This may often be its principal constituent, and may be earthy, silicious, argillaceous,

talcose, or limy, and the ore may be composed largely of the lighter gangue with comparatively small quantities of the valuable metals scattered or disseminated through it. When, as is often the case, the metal is the heavy part of the ore, and the lighter part is the gangue, the ore may be concentrated or dressed with a view to removing this gangue. An ore capable of being thus treated is called a concentrating ore, and the valuable heavy part obtained from it is called a "concentrate."

We may also divide ores into sulphide and oxidized. As a matter of fact, these merge into one another, and it is often difficult to decide to which class to assign a given ore. Carbonates are placed among the oxidized ores, since, in smelting, the carbon dioxide is readily driven off, leaving the oxide of the metal.

**Grading Ore.**—Miners often find it profitable to sort their ore into different grades, such as shipping or smelting, and into milling or concentrating ore, according to the after-treatment they purpose to give it. This matter is often an important one for the metallurgist to consider in deciding upon the treatment of ore, as, for example, in the case of a mixed silver ore.

#### CLASSIFICATION OF METALLURGICAL OPERATIONS

These may be roughly divided into two, viz., milling and smelting. Gold and silver ores are commonly treated in mills, though they may also be smelted.

Iron, lead, zinc, and copper ores are commonly smelted, though the last three can be treated by hydrometallurgical methods in which the metal is brought into solution and later precipitated from the solution. We speak then of smelting being a pyrometallurgical process, while hydrometallurgy relates to the extraction of the metal by aqueous solutions. In smelting, the ore is roasted if necessary, smelted in a smelting furnace, and the product, the metal still containing impurities, refined to put it in marketable form. Gold and silver have been successfully recovered from free milling ores by crushing and amalgamation. However, most ores cannot be so easily treated. The steps of milling practice then are (1) crushing and grinding, (2) solution, (3) filtration, (4) precipitation, (5) refining, as given in later chapters of this book.

#### PRINCIPLES RELATING TO THE REFINING OF METALS

It is found by analysis that the separation of a metal from other metals or from contained impurities is seldom complete. It is difficult and commercially impracticable to obtain metals entirely pure, so that those that come on the market still contain small amounts of impurity. Metals thus prepared are graded according to quality, and command prices

TABLE I.—PHYSICAL CONSTANTS (METALS AND GASES)

Metal.	Sym- bol.	Atomic Weight.	Specific Gravity, Water = 1.00	SPECIFIC HEAT, WATER = 1.00.		Melting Point ° C.	Latent Heat of Fusion, Calories.	Tensile Strength Lbs. per Sq. In.
				30° C.	Melting Point.			
Aluminium....	Al	27	2.56	0.167	0.308	659	100	12,590 cast 19,290 rolled
Antimony.....	Sb	120	6.71	0.048	0.054	630	40	
Arsenic.....	As	75	5.67	0.076	.....	850		
Bismuth.....	Bi	137	9.8	0.031	.....	271	12	3,000
Cadmium.....	Cd	208	8.6	0.054	0.062	321	13	
Calcium.....	Ca	40	1.57	0.170	.....	810		
Carbon.....	C	12	.....	.....	.....	3650		
Chromium.....	Cr	52	6.8	0.104	.....	1510		
Cobalt.....	Co	59	8.5	0.106	0.204	1490	68	75,000
Copper.....	Cu	63	8.8	0.086	0.118	1083	43	34,000 bolts 60,000 wire
Gold.....	Au	196	19.3	0.032	.....	1063	16	20,000 cast 37,000 wire
Iridium.....	Ir	192	22.4	0.030	0.04	2300		
Iron.....	Fe	56	7.86	0.116	0.162	1520	69	55,000 rolled 48,000 cast
Lead.....	Pb	206	11.4	0.030	0.034	328	4	2,650 cast 1,650 pipe
Magnesium....	Mg	24	1.74	0.246	.....	651		
Manganese....	Mn	55	8.00	0.122	.....	1225		
Mercury.....	Hg	200	13.6	0.033	0.032	-39	3	
Nickel.....	Ni	59	6.7	0.109	0.161	1452	68	54,000
Osmium.....	Os	195	22.5	0.031	.....	2700		
Palladium....	Pd	106	11.5	0.059	.....	1549	36	50,000
Phosphorus....	P	31	21.5					
Platinum.....	Pt	194	21.5	0.032	0.046	1755	27	45,000 cast 56,000 wire
Potassium....	K	39	0.87	0.166	.....	62		
Silver.....	Ag	108	10.5	0.055	0.076	960	24	41,000
Sodium.....	Na	23	0.97	0.293	.....	98		
Tin.....	Sn	117	7.3	0.055	0.059	232	14	4,600 cast 5,800 drawn
Tungsten.....	W	184	19.1	0.034	.....	3000		
Zinc.....	Zn	65	7.1	0.093	0.112	419	23	5,000

## GASES

Chlorine.....	Cl	35						
Fluorine.....	Fl	19						
Hydrogen.....	H	1	0.00009					
Nitrogen.....	N	14	0.0125					
Oxygen.....	O	16	0.0143					



according to the grade. Thus Lake copper commands the highest price of any copper because of its purity and toughness, while electrolytic copper sells at one-half cent less per pound.

In silver-lead smelting practice the slag, no matter how thoroughly settled and separated from the matte, still contains 0.2 to 0.3 oz. silver per ton and 0.3 to 0.4 per cent lead. In copper refining, in the reverberatory furnace, arsenic, antimony, and bismuth, occurring in the crude or blister copper, are retained as traces after refining, and where the blister copper is impure, no high-grade product can be expected. In the separation and deposition of copper by electrolysis at low current-density, the copper is of high grade even though impurities are in solution in the electrolyte; nevertheless, traces of impurity find their way into the cathode copper, though to less extent than by any other system of refining.

In the refining of pig iron to make steel, in order to obtain satisfactory quality, impurities must be removed until less than 0.10 per cent phosphorus and 0.05 per cent sulphur are present, otherwise the steel lacks toughness and tenacity.

### MOLDING AND CASTING METALS

Metals undergoing treatment are finally brought to the metallic state, and are commonly cast into ingots or bars for sale. Sometimes metals may be finally granulated, as zinc for cyaniding or lead for test-lead in assaying. Or again, the molten metal may be poured into water, producing coarse flattened granulations where it is desired to quickly dissolve the metal, as in the parting of precious metals.

But generally metals are cast into bars, ingots or commercial shapes as desired by the customer, who wishes to subject such bars to further treatment. These shapes vary according to the metal and are cast in molds either by hand or by casting machines as follows:

**Gold.**—This is cast of all sizes according to the quantity treated, or to the desire of the customer, from the size of the finger upward, to be rolled into sheets, to be drawn into wire or to be sold to the mint. Gold for the mint is then remelted in plumbago crucibles of suitable size, assayed and paid for, then granulated for parting.

**Silver** is commonly cast in bars of 1000 oz. (about 80 lb.), a convenient size for handling, and hard to steal. When ready to tap from the test of a cupelling furnace it is run into ingot molds standing on a carriage beneath, then pushed along as the ingots fill. In similar quantity the metal may be remelted in a plumbago crucible, then lifted out with basket tongs and poured directly into the molds, as in silver-mill practice. Where the quantity of metal is large, as in the treatment of precipitate, the melt may be poured into a crucible and thence into molds, as shown

in Fig. 2. The tilting furnace is oil-fired and is shown in skimming and pouring position.

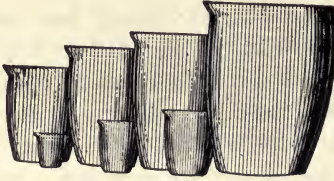

FIG. 1.—Plumbago Crucibles.



FIG. 2.—Conical Mold.

Fig. 14 is a mold such as is used for silver bars 11 in. long by  $4\frac{1}{2}$  in. by  $4\frac{1}{2}$  in., to hold 1000 oz. or 70 lb. of the metal.



FIG. 3.—Tilting Furnace.

**Iron and Steel.**—Pig iron from the blast-furnace was formerly cast upon the sand floor of the cast-house. The furnace was placed centrally at one end of the house, and the floor sloped away at even grade from the metal tap-hole. There was a central channel or runway made in the sand to the end of the house. Branching either way at right angles from this channels were made in the sand, and by means of wood molds, cavities for the pigs. Thus the branches were fancifully called the sows, the cavities the pigs. When iron

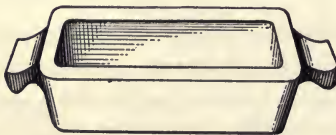

FIG. 4.—Cast-iron Mold.

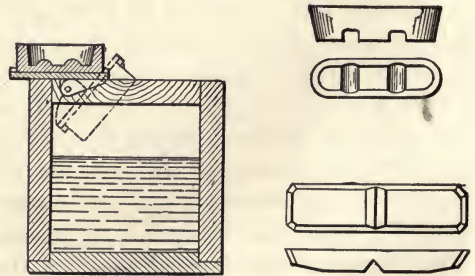

FIG. 5.—Bosh and Molds.

was tapped the flow was down the main channel. To divert the flow, gates (flat cast-iron plates) were so set across the channel as to change

it to any branch, filling the cavities forming the pigs. When they were filled the gate was set at the next branch the main run was opened, and the filled side branch cut off, all by means of the gates. After cooling the pigs were broken off by prying them up with a bar, and removed to the cars standing upon tracks alongside the cast-house.

The pigs had some sand sticking to them, and this was one reason that mechanical casting was adopted, as in the Heyl and Pattison machine, Fig. 162.

Pig iron, as we know, upon remelting in a cupola furnace, makes the most intricate castings. The same is true of steel castings, now successfully melted in the converter or in the electric furnace, treated by the addition of ferro-alloys to make a quiet melt, and producing strong castings for special purposes.

**Copper.**—This metal after refining is cast into special forms for the market, in small furnaces by hand. The skimmed metal is dipped from the furnace, using a dipping ladle having a bowl 9 in. diameter and holding 25 lb. In casting, a water-bosh is used, see Fig. 5. On the edge of this is hinged a number of molds which are successively filled by three or four men who dip from the furnace and fill them. As soon as these get solid, the mold is turned over, the ingot falling into the water. From the water it is picked out by means of tongs and is ready for market. The usual shapes are ingots, ingot bars, wire bars, and cakes, which weigh respectively 17 lb., 35 lb., 85 to 250 lb., and rectangular cakes 14 in. square or 14 by 17 in., to roll into plates.

In place of the hand ladles, often "bull ladles" are used. These, having long handles, suspended near the center of balance by chain to an overhead trolley rail, will dip up 100 lb. at a time. They greatly expedite the work of dipping. This, with an ordinary refining furnace, will take four or five hours.

In place of hand dipping, one of the mechanical casting machines, such as the endless mold machine, Fig. 242, or the Walker casting machine, Fig. 245, is employed. Indeed, for one of the large furnaces, hand dipping would be too slow. As seen in Fig. 245 the machines are supplied by a ladle from the converter, and blister copper in ingots of 250 to 400 lb. are cast.

In place of a casting machine a series of molds are often employed, enough of them to take care of a ladle full of blister copper. When a works desires to produce a finished cathode, this is done by collecting the converted product in a tilting furnace, resembling the tilting open-hearth furnace of steel practice. It is here poled, making a smooth ingot, or even an anode suitable for use in the electrolytic vat.

**Lead.**—The older way of casting base-bullion was to let the molten metal run into a cooler, a basin that would hold 1000 lb. The dross was

skimmed from this, and the base-bullion dipped by ladle into molds holding 85 to 100 lb., then shipped to a refinery. The present practice is to receive the molten metal into a two-wheeled pot. It is then taken to the drossing kettle, where the dross is removed as described under lead refining. The metal, now free from dross, is shipped away to the refinery. The dross is returned to the blast furnace. It is a coppery dross still containing lead.

Under head of Refining we give the method used for molding market lead. The lead when solid is removed from the molds by hand. In some cases an endless mold machine is used.

**Zinc.**—This is tapped from a horizontal row of condensers into a ladle suspended by chain blocks to a trolley rail. The collected metal is skimmed from dross and poured into molds. In remelting spelter, a charcoal cover should be used, since hot molten zinc easily drosses. It is for this reason that in brass making the copper is first melted and the zinc added at the last moment before casting.

## CHAPTER II

### FUELS

A fuel may be defined as a solid, liquid, or gaseous substance that can be burned for the production of heat for economic purposes. Fuels can be divided into two classes: natural and artificial. Coal is a natural fuel; coke an artificial one. The natural fuels include "solid fuel" like wood or coal, the mineral oils and natural gas. The **solid natural fuels** are believed to be of vegetable origin. They are substances in some measure altered from their original condition by heat and pressure, and range from wood through peat, lignite, bituminous or soft coal, anthracite or hard coal to graphite at the extreme. **Artificial fuels** may be divided into the "solid prepared fuels" and "fuel gas." The solid fuels are coke and charcoal.

The relation of the natural carbonaceous substances is shown in Fig. 7. Here in a general way is illustrated the chemical and physical changes that occur in the formation of coal from its organic constituents in plant-tissue. These changes result, finally, under the action of pressure and high temperature, in graphitic carbon, and begin by action upon wood, leaves, and root-fibers (turf or peat), passing through lignites or freshly formed coal, often brown in color, thence

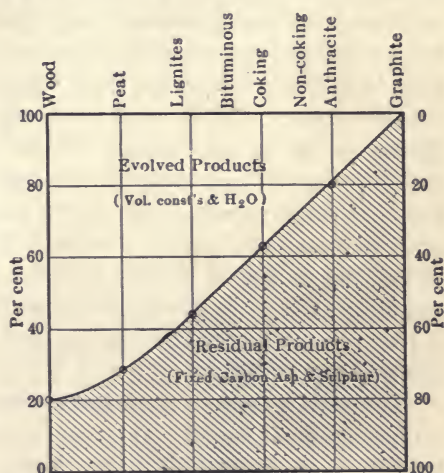

FIG. 7.—Table Showing Genesis of Natural Fuels.

to bituminous coal formed during recorded geological time, retaining the volatile constituents, to anthracite where the volatile constituents are mostly eliminated by the heat and immense pressure and finally result in graphite where distillation completes the work.

## THE NATURAL SOLID FUELS

**Classification.**—A convenient division of the standard types of such fuels may be made into first, those of compact texture, and second, those of woody, fibrous, or earthy texture.

A more exact and convenient classification, beginning with the most compact, the highest in "rank," is thus given:

(a) Graphite, native coke, and anthracites, these burning with a non-luminous flame.

(b) Bituminous coal or bitumen, burning with a luminous flame.

(c) Lignites, peat, and wood, fuels having a woody, fibrous, or earthy structure, burning with a luminous flame.

The impurities of coal are ash, sulphur, and to a lesser extent nitrogen. Of a given type the standard may be given at 6 per cent ash, and 1 per cent sulphur. In nitrogen 0.75 per cent for anthracite; 1.5 per cent in the intermediate types, decreasing to 0.75 per cent in the lignites. These impurities cause a variation in "grade."

The rank of a coal, in changing from peat to graphite (see Table II), shows a progressive elimination of moisture and volatile matter and a corresponding increase in the proportion of fixed carbon and ash. Thus, a typical fresh peat would contain 91 per cent moisture, 6 per cent volatile matter, 2 per cent fixed carbon, and 0.3 per cent ash. A typical lignite, assumed to have been derived from the peat, contains 43 per cent moisture, 26 per cent volatile matter, 27 per cent fixed carbon, and 25 per cent ash. If from lignite we go on up through the list, we find that while the amount of moisture in the coal steadily decreases the percentage of volatile matter keeps about even with that of the fixed carbon in all the lower-rank coal until the moisture reaches a stable minimum beyond which the percentage of volatile matter is rapidly reduced. Thus we find the ratio of volatile matter plus  $H_2O$  to the fixed carbon is one-to-one in the lower-rank coals; it has risen to one-to-four in the best bituminous, and to one in seven or more in the anthracite.

**The Anthracites.**—These have a fuel ratio of one to seven and burn with a non-luminous flame. They are conveniently grouped into the "hard," having a conchoidal fracture, high specific gravity and sub-metallic luster; and the soft with a semi-cubic fracture and low specific gravity.

**The Bitumites.**—These include the bituminous coals of the carboniferous age and the sub-bituminous coals, or those of the post-carboniferous, both having a fuel ratio less than one to seven and burning with a luminous flame. This flame indicates the presence of hydrocarbons in the volatile constituents, and so that the coal is bituminous.

The coals of the carboniferous age are divided into (1) the so-called smokeless Virginia coals, which includes those having a short and those having a medium flame; (2) the coking or steam coals, having a long flame;

TABLE II.—COALS IN THE UNITED STATES

Kind of Coal.	Characteristics.	Locality.	FUEL RATIO.		HEAT VALUES CALCULATED.	PROXIMATE ANALYSIS PER CENT.			ULTIMATE ANALYSIS PER CENT.				
			Fixed Carbon to Vol. Comb. + H <sub>2</sub> O.	Average.		Average Moisture.	Vol. Const.	Fixed Carbon.	Ash.	Sulphur.	Hydrogen.	Carbon.	Nitrogen.
					Average.								
Anthracite..	Conchoidal fracture..	Wyoming Valley, Pa....	10.0	8050	3.0	13.0	78.0	6.0	1.0	4.0	83.0	1.0	5.0
No-coking..	Flameless.....	Brushy Mts, Va.....	7.0-5.0	8190	3.0	17.0	74.0	6.0	1.0	4.5	82.0	1.2	5.2
Coking....	Flame, short.....	Pocahontas, Va.....	5.0-3.5	7900	3.0	22.0	69.0	6.0	1.0	4.7	81.0	1.5	5.7
Coking....	Flame, medium....	Connellsville, Pa....	2.5-1.8	7775	3.0	33.0	58.0	6.0	1.0	5.2	78.0	1.5	8.3
Steam.....	Flame, long.....	Hoeking Valley, O....	<1.4	6665	10.0	38.0	46.0	6.0	1.0	5.4	69.0	1.5	17.0
Steam.....	Flame, long.....	St. Clair Co., Ill.....	<1.4	6250	14.0	37.0	43.0	6.0	1.0	5.5	66.0	1.5	20.0
Indiana....	Splintites.....	Brazil, Ind.....	<1.4	6110	17.5	35.0	41.5	6.0	1.0	6.0	60.0	1.0	26.0
Household..	Canneloid.....	Canfield, O.....	1.4-1.0	7500	3.0	53.0	38.0	6.0	1.0	7.0	76.0	1.0	9.0
Montana....	Weather-resisting....	Sand Coulee, Mont....	<2.0	6400	10.0	35.0	49.0	6.0	1.0	5.5	65.0	1.0	21.0
New Mexico.	Non-weather-resisting	Gallup, N. H.....	<1.4	7500	3.0	53.0	38.0	6.0	1.0	5.8	61.0	1.0	22.2
Wyoming....	Non-weather-resisting	Sheridan, Wyo.....	<1.4	5220	22.0	34.0	37.5	6.0	1.0	6.2	53.0	1.0	33.0
Lignite.....	Xyloid (woody)....	Hoyt, Tex.....	<1.4	4160	35.0	29.0	30.0	6.0	1.0	6.7	43.0	0.7	43.0
Peat.....	Fibrous, earthy....	Orlando, Fla.....	.....	4440	20.0	52.0	22.0	6.0	1.0	6.5	50.0	0.5	36.0
Wood.....	Woody.....	.....	.....	3610	25.0	55.0	19.0	0.7	...	7.5	37.0	0.1	55.0

(3) the non-coking or "household" coals, having a woody texture and cubic fracture; household coals also having the same texture, but a conchoidal fracture.

The coals of the post-carboniferous age are divided into (1) the weather-resisting or Montana coals, which may be stocked or shipped long distances, and (2) the non-weather-resisting or semi-bituminous, which exposed to alternate wetting and drying, break down and lose their shape in a month's time. In this latter group is found New Mexico coal, having a fuel-value of more than 7750 calories, and the Wyoming coal with less than that.

The lignites are high in moisture, the black lignites or sub-bituminous coals containing much less than 30 per cent, the brown coals more than 30 per cent moisture. They have a woody structure and a luminous flame.

In the following table of coals of the United States, we give the ratio obtained by dividing the fixed carbon, as found in the proximate analyses, by the combined percentages of volatile combustible and moisture. The calorific value of the coal and its analysis, both proximate and ultimate, are also given. Of the two, the former is the one generally thought of. A coal of standard type is that used.

**Wood.**—When, freshly cut, wood contains 40 per cent moisture, and in this condition is difficult to burn alone; but where this can be done, it develops 2300 pound-calories per pound. Split into cord-wood, piled, and dried for several months, wood contains 20 per cent moisture and 40 per cent carbon. Its calorific value thereby increases to 3600 calories. Such wood is classed as hard when its specific gravity is more than 0.55; below this it is called soft. While the calorific intensity of dry wood is low, its combustibility is great, and it is well suited for use in reverberatory roasting-furnaces, since the volatile constituents, rapidly escaping, burn gradually, and make an extended flame along the hearth of the furnace, heating it more uniformly than could a flameless fuel like anthracite or coke. In the outlying districts of the western United States, where the metallurgist is dependent on wood for generating steam, or roasting ore, the accumulation of a sufficient supply of dry wood should be one of his first cares. In this his forethought is well rewarded. He should purchase wood delivered and corded near the works; and in measuring, make equitable allowance for short dimensions or open piling. Cordwood should "cord up" to 70 per cent solid wood.

**Coal for Roasting.**—Both lignites and the regular bituminous coal may be used. It should have a good proportion of "volatile matter," so that the flame may be long, and thus distribute itself over a greater area of the roasting hearth. A short flame would be intense near the fire-box, but would fail farther away. To make the flame long the quantity of air is so regulated that it mingles slowly with the escaping volatile gases, and thus it is carried to the end of the hearth.



Coals of very different properties may appear alike if represented only by proximate analysis. The comparative calorific value may be judged of by Berthier's method. This consists practically in the operations of a lead assay, using an excess of litharge, with a gram of the fuel, and noting the size of lead button reduced. One can also judge a good deal about the character of the coal by coking it in a covered crucible and weighing the coke produced, judging the character by the appearance of the product. The proximate analyses (Table II), showing the different kinds of coal, determine to which class any given kind belongs.

**Graphite.**—This is of interest, not as a fuel, but as a refractory material, particularly when combined with clay.

**Petroleum or Fuel Oil.**—This is the most concentrated of fuels, and, when the cost justifies, can be used not only for generating steam, but for roasting and melting. It will be found, in burning fuel-oil from various localities, that the calorific power is much the same for the different kinds. Beaumont (Texas) oil has a calorific power of 10,820 calories, and a specific gravity of 0.88 ( $7\frac{1}{2}$  lb. per gallon.) Oil can be burned in such a way as to give, not only a high and uniform temperature, but also the oxidizing (roasting) or reducing action that may be desired. The air for combustion is best preheated as well as the oil, and it will be found advantageous to inject the oils under a high steam pressure. A mixture of light and heavy oils should not be used. In Russia, where it has been employed in open-hearth steel-furnaces of 10 to 15 tons capacity, oil to the extent of 15 to 20 per cent of the weight of the charge has been used. As regards comparative costs at the Selby Smelting & Lead Works, Vallejo Junction, California, it was found that the saving was 40 to 60 per cent with oil at \$1.71 per bbl. (42 gal.) and coal at \$6 per ton. A suitable control of the grade of the matte was possible by the regulation of the flame.

**Natural Gas.**—In Ohio, Indiana, and Kansas, particularly, there are districts where natural gas has been obtained by boring for it as for oil. It is the most efficient of natural fuels, having a calorific power of 611 cal. per cubic ft. or 27,862 Cal. per pound. The following analysis will give an idea of the composition of Pennsylvania natural gas. It shows that it is composed chiefly of marsh-gas and hydrogen, viz:

	Per Cent, by Volume.
Carbon dioxide (CO <sub>2</sub> ).....	0.8
Carbon monoxide (CO).....	1.0
Oxygen (O <sub>2</sub> ).....	1.1
Ethylene (C <sub>2</sub> H <sub>4</sub> ).....	1.0
Ethane (C <sub>2</sub> H <sub>6</sub> ).....	3.6
Methane (marsh-gas) (CH <sub>4</sub> ).....	72.2
Hydrogen (H <sub>2</sub> ).....	20.7
	<hr/> 100.4

## THE ARTIFICIAL FUELS

These include charcoal, coke and producer gas, all made from natural fuels.

**Charcoal.**—Wood, packed in a kiln, and permitted to partly burn, changes into charcoal by distillation of the volatile portion by the heat produced from the portion burned. The charcoal retains the form of the wood from which it was made, but has a specific gravity of only 0.2. It is of a dull-black color, soils the fingers but slightly if of good quality, but much if poor. It should ring when struck, and should show the annual rings of the wood distinctly. The density of charcoal varies with that of the wood from which it was made, dense woods giving a dense charcoal. A heaped bushel (1.5555 cu. ft.) weighs 14 to 16 lb. When apparently

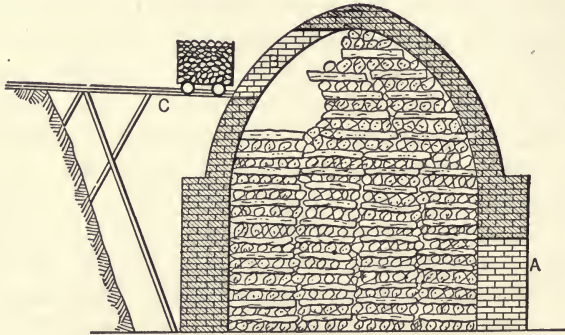

FIG. 8.—Section of Charcoal Kiln.

quite dry, charcoal still contains 10 per cent or more of moisture. Dry charcoal contains 95 per cent carbon, 1.5 ash, and has a calorific power of 7610 pound-calories per pound. Charcoal is used in iron blast-furnaces, particularly in localities where wood is abundant; and it produces a pure, strong iron, free from sulphur, called "charcoal-iron." Charcoal has been used also for silver-lead and copper smelting in districts difficult of access. In these cases it has done especially well when coke could be secured to use in conjunction with it. It is, however, a friable fuel, making fine dust sometimes to the extent of 10 per cent; and this "fine" is apt to make trouble in the blast-furnace. If under-burned, it is heavier and more dense, and has a brown color. Portions of the wood found imperfectly burned are called "brands" and are returned for the next burning.

Charcoal is generally made in a kiln. One of these in section in Fig. 8, shows the method of filling. The kiln is set at the foot of a steep bank, so that it can be charged conveniently from above. It has two charge-doors *A* and *B*. The first of the wood is conveyed through the lower door,

and placed. The remainder is brought along the runway *C*, and introduced through the upper door *B*. There are three rows of openings, 3 by 4 in. in size, spaced 2 ft. apart, around the bottom of the kiln. The kiln is lighted at the lower door, and when fairly started, both openings *A* and *B* are closed with sheet-iron doors. These are tightly luted with clay, and the air is thus caused to enter by the small holes. When combustion has progressed sufficiently, these openings are tightly closed, and the kiln is permitted to cool slowly. The period of charring or burning is eight days and the cooling four days additional. Such a kiln holds 25 cords of wood and produces 1125 bu. of charcoal weighing 16 lb. per bushel, or about 20 per cent of the weight of wood charged.

**By-product Charcoal.**—An example of the modern method of making by-product charcoal for iron blast-furnace use is one at the Pioneer Iron furnace, Marquette, Mich. Here there are 86 kilns each holding 8 cords. The daily requirement is 20 carloads, of 16 cords each, amounting to 320 cords. The kiln is packed full of wood, the sheet-iron doors put on and closed, and fire is started at a manhole in the apex of the dome. As soon as combustion gains sufficient headway, this opening is closed, and smoke escapes by way of a flue leading from the base of the kiln to the chimney, continuing thus until most of the aqueous vapor has escaped. At this stage the chimney is closed, and the vapors pass by a smoke-main to the condensers, the current being aided by an electrically driven fan. The cold surface of the copper tubes of this condenser precipitates the condensible portion of the gas, while the gas itself goes on to the boilers, where it is burned for steam-making. The condensible portion, amounting to 41 per cent of the weight of the wood, is called green liquor or pyroligneous acid, and consists mostly of water, but contains also alcohol, tar, ammonia compounds, acetone, and acetic acid. The tar is separated in settling tanks, and the liquor passes to the primary still-house. Copper stills here remove the vapors of alcohol, acetic acid, and much water from the liquor. The neutralizing tank receives the product, and into this is mechanically stirred milk-of-lime to neutralize the acid by the formation of acetate of lime. The neutralized liquor is allowed to settle, and the supernatant solution is drawn off and conveyed to the refining-still house. By fractional distillation a crude wood alcohol is obtained here, and a solution of acetate of lime is left behind, and recovered by evaporating the solution. The crude alcohol is then purified by further distillation until a clear 95 per cent wood alcohol is obtained. A cord of wood (4500 lb.), yields 880 lb., or 19.5 bush. of charcoal of 20 lb. per bushel, 208 gal. of pyroligneous acid, 8 gal. of wood-tar, 64 lb. gray acetate of lime, and 4 gal. wood alcohol. By the sale of the wood alcohol, acetate of lime and formaldehyde, and by the superior quality and consequently higher price of charcoal-iron, it has been possible to build up

this industry, where the supply of wood is abundant, in spite of the serious competition of iron smelted in blast-furnaces using coke.

**Coke.**—This is made from coal in kilns, in a way similar to that of making charcoal. Bituminous coal which cokes or fuses at the high temperature of the kiln or oven is used for this purpose.

The raw screenings, in the example below, contained much fine passing a 1½-in. bar-screen. From this, the residue left after removing the lumps of merchantable coal, coke was made. By "washing," the fixed carbon was increased and the ash in the coke reduced to 14.24 per cent. A part of the sulphur also was removed thereby. The refuse was high in ash, and low in fixed carbon, as was to be expected; but the yield of washed coal was 85 per cent of the raw screenings, and the coke 70 per cent of the washed coal. When the coal contains slate, "bone," or pyrite, it is improved by this process of washing, or separating the waste-matter by concentrating. An example of a semi-bituminous southwestern coal is shown below:

	Moisture.	Volatile Combustible Matter.	Fixed Carbon.	Ash.	Sulphur.
Raw screenings.....	1.40	19.79	60.25	17.33	0.85
Washed coal.....	0.79	19.10	69.35	10.24	0.52
Coke.....	0.43	1.39	83.47	14.24	0.82
Refuse or waste.....	2.22	15.76	30.96	50.12	0.93

**Composition of Coke.**—The ash in coke varies from 10 per cent to 22 per cent and the fixed carbon from 77 per cent to 89 per cent. In coke, high in ash, not only has the ash to be smelted, but the fixed carbon is correspondingly low, so that such coke is less efficient. A great difficulty with high-ash coke is that it is often friable, making accretions or scaffolds in the shaft of the blast-furnace. Analyses of two typical samples of bee-hive coke give the following:

Connellsville Coke: fixed carbon, 87.5 per cent; ash, 11.3 per cent; sulphur, 0.7 per cent. El Moro coke: fixed carbon, 77 per cent; ash, 22 per cent (when the coke, as in this case, is made from unwashed coal); sulphur, 0.9 per cent.

**The Coke Ash.**—In computing a furnace charge, this is taken into account. Ash of Connellsville coke contains SiO<sub>2</sub>, 44.6 per cent; Fe, 15.9 per cent; CaO, 7 per cent; MgO, 1.9 per cent. Ash of El Moro coke has SiO<sub>2</sub>, 84.5 per cent and Fe 5 per cent. It will be seen that this latter ash has a large excess of silica to be fluxed, and is accordingly less desirable. On the basis of 11.3 per cent ash in the Connellsville coke we would have SiO<sub>2</sub>, 5.0 per cent; Fe, 1.8 per cent; CaO and MgO, 1 per cent of its total weight.

**Beehive Coke.**—A beehive-oven (see Fig. 9 at B), is charged through a hole in the roof. Each oven holds 5 to 6 short tons of coal. In Pennsylvania an oven yields per week two charges of 48-hour coke and one of 72-hour. The charge in making 72-hour coke is dropped in the morning into the hot oven from a coal larry or car above, and is leveled through the side door, filling the oven to the depth of 26 in. The door is then walled up with dry brick and plastered over, but an opening is left near the top, as shown in section, for the admission of air. Combustion from the red-hot brickwork soon begins, and a dark smoke escapes at the top opening. After four hours this becomes dense and white, and the gases ignite or strike, and flames issue from the top. For twelve hours the oven burns with a dull, smoky flame above the surface of the charge. The flame be-

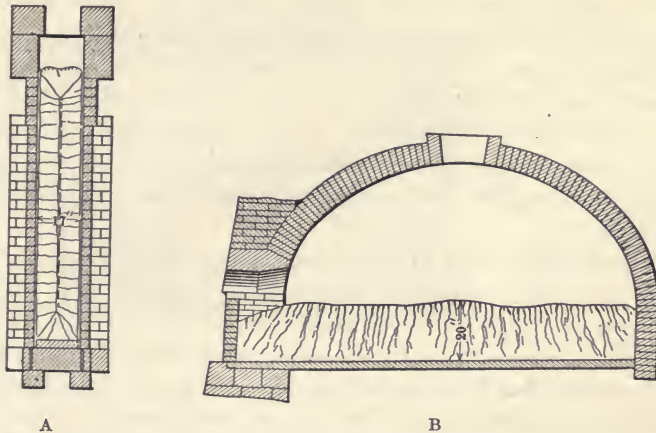

FIG. 9.—Sections of By-product (A) and Bee-hive Coke Ovens.

comes bright by the second day and then the air-supply is partly cut off. On the third day still less air is admitted, and at the end of this day no more flames appear and the whole interior of the oven is red-hot. The air-openings are now luted, and the charge is left in this condition until the morning of the fourth day when the coke is drawn. The actual coking is complete in fifty-five hours, and the whole operation, from one charging to the next, in seventy-two hours. To draw the coke the temporary brick wall of the door is taken down, and water from a hose played into the oven. After being thus cooled on the surface, the coke is pulled out with a long-handled coke-drag or hook, and further cooled with water while being withdrawn.

The process of fusing and coking begins at the top, and extends downward through the mass of coal to the bottom of the oven, and the coke, when well burned, takes the form of prismatic masses, see Fig. 9, with

hard side-surfaces of a silvery steel-gray color, and top ends soft and nearly black. The silvery appearance is due to deposited carbon, which has the desirable quality of protecting the coke against the action of the furnace-gases. The black ends, on the contrary, are readily attacked. A good coke has a well-developed cell structure which permits the penetration of the hot ascending gases in the blast-furnace. This so raises the temperature of the coke that the air, at the bottom of a furnace striking it, produces vigorous and rapid combustion. Other qualities are purity, uniform quality, and sufficient coherence for handling. Purity depends upon a low ash, 10 per cent being good, and 6 or 8 exceptionally pure. Coke intended for iron blast-furnace work should not contain more than 1 per cent sulphur and commonly less than 0.5 to 0.8 per cent of this element. For lead or copper blast-furnaces high sulphur does not greatly matter. "Uniform quality" means but a small amount of "black ends." These as stated, burn in the upper part of the iron blast-furnace by the action of carbon-monoxide gas. "Coherence in handling" as is evident, is important where coke must be transported far, and rehandled at the smelting works. Fines tend to "slow down" a blast-furnace, but can be rejected by the use of a coke-fork. The calorific value of Pittsburg coke, containing 89 per cent fixed-carbon, 10 per cent ash, and 1 per cent sulphur, is 7272 lb.-cal. per pound.

**The By-product Coke Oven.**—This is coming increasingly into use, due to the fact that in it, the products, aside from the coke, can be saved and sold to advantage, and not wasted as is done in making beehive coke. Moreover, due to the constant high and quick heat produced, it can coke a coal that contains but little fusible matter or is nearly non-coking.

A beehive oven will yield 2000 lb. of coke from 3200 lb. of coal, a by-product oven from the same amount of coal will yield 2300 lb. coke; 19 gal. tar; 42 lb. ammonium sulphate; 4.5 gal. benzol (motor fuel) and 10,000 cu. ft. of fuel gas.

The types of ovens of this kind extensively in use are the Otto-Hoffman, the Semet-Solvay, and the Koppers. The longitudinal section of a Semet-Solvay oven is shown in Fig. 10. The cross-section through the ovens themselves is given in Fig. 9.

Coal is brought in over two tracks, and discharged into feed-hoppers. It is drawn from these as required, and conveyed to two sets of rolls, one for coarse, the other for fine crushing, and reduced to a size of 4 to 10 mesh. The crushed coal is raised by an inclined elevator, and discharged into the main storage coal-bin. This bin has a hopper-shaped bottom with several discharge spouts, delivering to an 8-ton larry which runs along on top of the ovens or retorts, of which there may be 20 to 60, placed side by side, in one block of masonry. Each retort or coking chamber is 17 in. wide, 43 ft. 6 in. long, and 6 ft. 6 in. high, and is closed at each end by an air-tight

cast-iron door. In Fig. 9 is shown a transverse section of such a chamber with the interesting lines of fractures and columnar structure of the coke indicated.

At Fig. 10, the charge-car is seen above the retorts. It is worked by an electric motor and consists of 4 hoppers supported by a frame upon a traveling carriage. The doors of the chamber being closed, and the chamber itself hot from previous operation, a charge of 8 tons of coal is dropped in, and leveled by means of the top bar of the charging machine, Fig. 12, inserted through an opening near the top of the door. Distillation

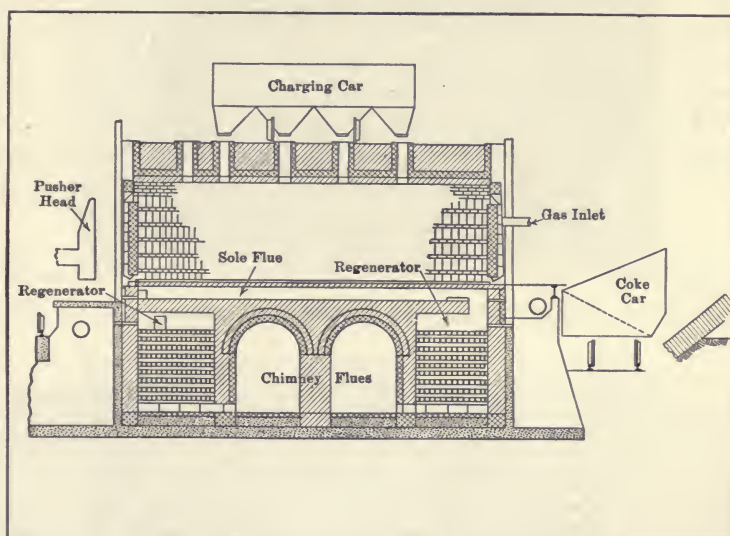

FIG. 10.—Semet-Solvay By-product Oven.

at once begins, and the gases are conducted to condensing-chambers to free them from certain by-products, such as tar, ammonia, and benzol. The first portion of the gas is highest in illuminating power, say 24 candle-power, but later drops to 16 candle-power. The first is, therefore, sent to the city-mains for use as illuminating gas, the latter reserved to heat the chambers by combustion in flues which encircle them. These flues are beneath the chambers, and the side-walls are constructed to provide them for heating the oven, and maintaining the activity of the distillation. The products of combustion, before entering the stack, go through a regenerating chamber containing a checker-work of tile, while air is preheated for combustion in a similar chamber at the other side. Thus the gas is burned with highly heated air, and produces an intense heat in the walls of the coking-chambers. The reversing valves are now changed, and the currents of air and gas caused to move in the opposite direction. The

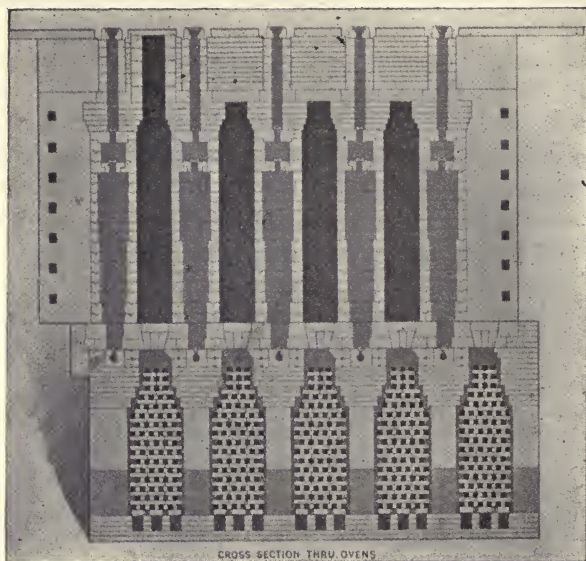

FIG. 11.—Koppers By-product Coke-oven.



FIG. 12.—Perspective View, Ovens, Coke-pusher and Leveler.



direction is thus repeatedly alternated, as is customary in open-hearth work. At the end of twenty-four hours, when coking is complete, the end doors are opened and the coke is pushed out by means of a coke pusher, Fig. 12. The pusher-head is shown at the left in Fig. 10. The coke is received in coke car, shown at the right of the oven, and is here cooled with water. The total yield of coke is 72 per cent, or 6 per cent more, for the same coal, than that of a beehive oven. The coke is hard, dense, and as reliable as beehive coke made from the same coal, but has not the silvery gloss of the latter.

**Costs.**—The actual cost of making coke may be stated as 50 cents per ton in the beehive process and 37 cents in by-product ovens. To this must be added the cost of the  $1\frac{1}{2}$  tons of coal required. A beehive plant operated six days per week and of 400-ton daily capacity would cost \$60,000. A by-product plant of the same capacity would cost \$300,000. Allowing for interest and depreciation, the cost is found to be much the same for either process.

#### PRODUCER-GAS

Of the various kinds of producers used for making artificial fuel-gas we shall consider two, "the simple producer" and the "mixed-gas producer."

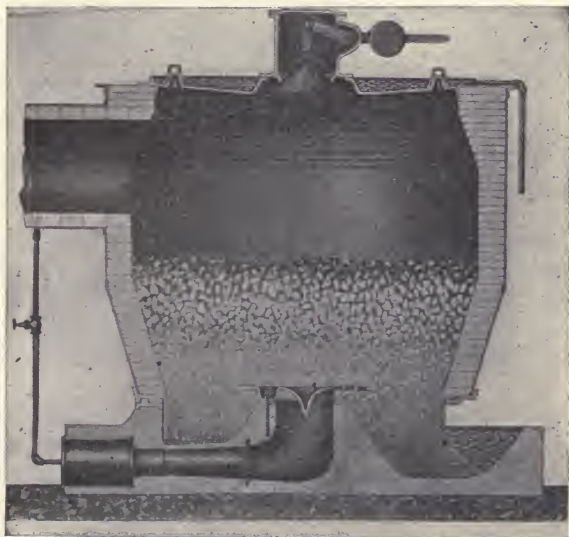

FIG. 13.—Section View of Gas-producer (hand poked).

**The Simple Producer.**—These use ordinary or inferior fuels, such as wood, wood-refuse, bark, sawdust, or peat, but generally soft or hard coal. We have shown in Figs. 176 and 177, in the sections of furnaces

containing fuel, how gas is produced where air rises through a deep coke fire and where fuel is thus in excess.

Fig. 13 is a simple producer, the necessary air being supplied by a natural draft or by a fan. The fuel, descending in the producer, first is dried by the hot, rising gases, then further heated until the volatile matter is distilled, and finally, as it reaches the lowest zone, is oxidized or burned by the entering air. The residue is the ash of the fuel, which is withdrawn at the bottom. The escaping gases issue at a temperature of 300° to 1000° C.

In the operation of a hand-poked producer, the coal, when charged, if left to itself would soon burn, leaving holes in the fuel-bed, through which would come up unconsumed air. To avoid this a long bar is run down through one of the poke-holes shown in the producer top to break up the hung-up coal and again make the bed continuous.

An analysis of producer-gas made from soft coal gave the following results by volume:

	Per Cent.
Carbon dioxide (CO <sub>2</sub> ).....	5.0
Carbon monoxide (CO).....	23.0
Oxygen (O <sub>2</sub> ).....	0.5
Ethylene (C <sub>2</sub> H <sub>4</sub> ).....	0.5
Methane (CH <sub>4</sub> ).....	3.0
Hydrogen (H <sub>2</sub> ).....	10.0
Nitrogen (N <sub>2</sub> ).....	58.0
	100.0

Each pound of coal will give 60 cu. ft. of such gas, having a heating value of 82 Cal. per cubic foot.

**The Mixed-gas Producer.**—This is the producer commonly used. In it some steam or water vapor is blown with the air into the burning fuel, and there reacts upon the carbon as follows:

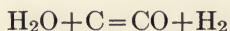

$$58,000 \quad 29,000 = -29,000$$

One volume of steam makes one volume of carbon monoxide and one of hydrogen. The steam may be obtained from the water-soaked ashes by evaporation in the lower part of the producer, or as in Fig. 13 may be injected under pressure into the fire. Steam also disintegrates the clinker and facilitates its removal. The carbon dioxide formed means the production of heat later absorbed in the formation of water-gas and hence is in a way useful, since the formation of water-gas can be carried farther.

**The Hughes Mechanically Poked Continuous Gas-producer.**—Fig. 14 is a sectional elevation of a plant containing a row of Hughes producers

which give a mixed gas to supply open-hearth furnaces used in making steel.

The special feature of this type of producer is the mechanical poker *F*, which is a water-cooled steel casting suspended and secured to a shaft *S*. The poker is actuated by a mechanism which moves the poker back and forth, agitating and breaking up the mass of fuel, in the slowly rotating shell, evenly distributing the coal, and helping to work the ashes down-

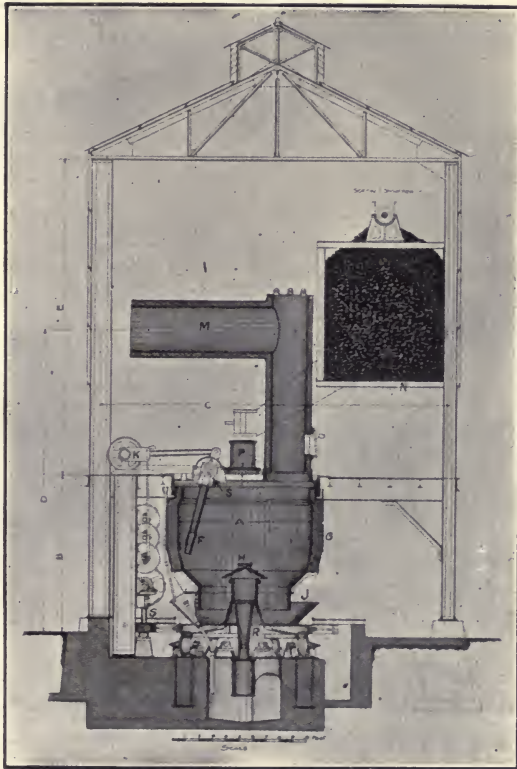

FIG. 14.—Hughes Mechanically Poked Continuous Gas-producer Plant.

ward. Thus the labor of hand-poking is eliminated and the fuel is regularly stirred. This uniform treatment has proved of great advantage, giving uniform results in quality, quantity, and supply of gas, with a reduction of operating costs.

The brick-lined producer shell *G*, or body, is of steel having a cast-iron base-ring and a cast-iron water-sealed ash-pan *J* and a turn-table *R*, all bolted together in one. The turn-table *R* has at its outer circumference a cast-iron rack into which meshes a spur pinion keyed to the vertical

shaft *S* and connected to the horizontal main shaft by a train of gearing. Thus the turn-table is rotated and with it the ash-pan, base-ring, and body *G*. The bottom of the turn-table is fitted with a steel tread resting on six conical chilled-iron carrying-wheels. As the producer slowly revolves, the

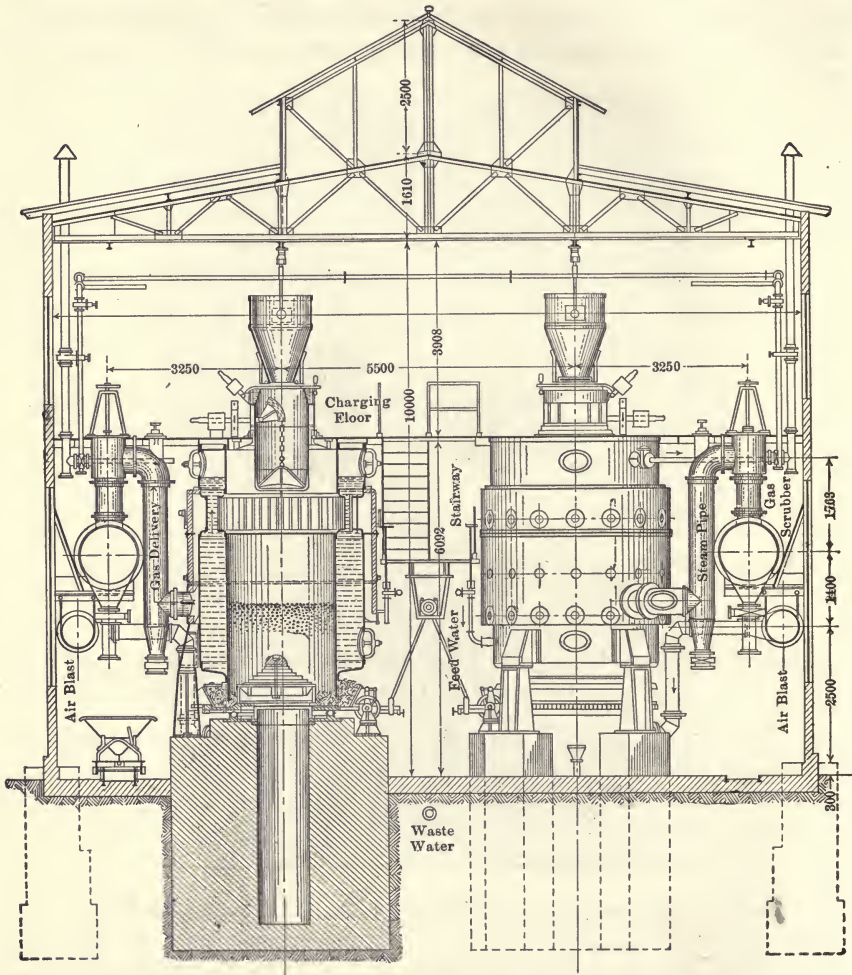

FIG. 15.—Cross-section of Revolving Eccentric Gas-producer.

ashes work down into the water-sealed ash-pan from which they are shoveled directly into a car in order to remove them. The steel producer top is secured rigidly to the floor structure and a water seal is formed by a flange at the outer circumference of the producer cover. It carries the poker mechanism, two charge-hoppers *P*, and the gas outlet or off-take, *T*.

The latter leads to a gas main or flue connected to the whole row of producers. The base of the producer has a blast inlet-pipe *H* with a cast-iron deflecting plate for covering the air opening. Air is delivered to this pipe by means of a blower. The producer is generally driven by an electric motor requiring three electric horse-power.

A hand-poked producer has a capacity of 10 lb. of coal per square foot of grate area per hour, while the mechanically poked producer can burn on an average 25 lb. This figures out approximately one ton of coal per hour for the Hughes producer of 10 ft. internal diameter. An average quality of gas can be maintained of a composition as follows:

CO <sub>2</sub>	CO	Hydrocarbons	H	N
4 per cent	25 per cent	3 to 4 per cent	13 per cent	53 per cent

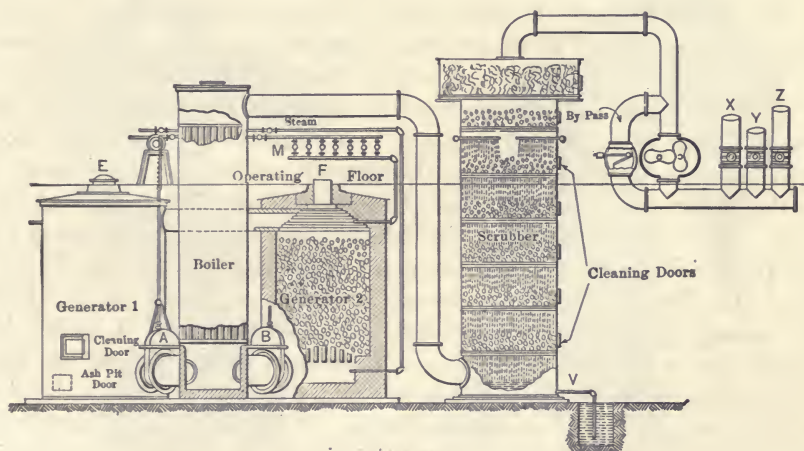

FIG. 16.—Loomis-Pettibone Gas-making Plant.

**Revolving Eccentric Gas Producer.**—Fig. 15 illustrates a plant containing a double row of gas producers having grates eccentrically set so that as they revolve they carry the fuel reciprocally to and from the interior walls of the producer shell. The hoppers are filled, and the charge dropped as in the bell of an iron blast-furnace. By the revolution of the grate the ashes work to and under the peripheral edge of the producer shell. Formerly needing 1.75 tons of coal to give gas enough to smelt 1 ton of charge in the open-hearth, the producer can now do the same work with a consumption of but 0.7 to 0.9 ton.

**The Loomis-Pettibone Gas Apparatus.**—Fig. 16 shows a complete plant of the Loomis-Pettibone system, with a positive gas exhauster. It is intended both for producer- and water-gas. Its operation is as follows: Hot fires are burning in both producers or generators, and the gas exhauster

is in operation. Air is now drawn upward through *generator 1*, burning the fuel and making producer-gas. This generator may have just received fresh coal at *E*, and the coal-smoke, tarry matter, and producer-gas from it, are together drawn down through the hot fire in *generator 2*, being completely burned and fixed in so doing. The gas now goes through valve *B* to the boiler (valve *A* being closed), and the heat is there absorbed. It then passes from the top of the boiler through the pipe shown to the bottom of the "scrubber," a cylindrical tower of sheet-steel, in which it is caused to pass upward through pieces of coke resting upon perforated trays. The coke here is kept wet by means of a water-spray, and the gas is thereby cooled and cleaned. The water drains off by the water-sealed pipe *V*. Rising to the top and to the wider part of the tower, the gas passes through a layer of fine shavings or "excelsior," to remove any remaining dust. It is then drawn through the Root positive-blast exhauster *W*, and finally is driven through pipe *Z* to the gasometer for producer-gas, where it is stored for use. The fire in *generator 1* having become clear and hot, *generator 2* is charged afresh, and the ash-pit door opened. The gas current is then changed from *generator 2* to *generator 1*, through valve *A* (valve *B* having been shut) to the boiler, thence through the scrubber and exhauster *W* to the gasometer. The direction of the current is thus changed at intervals. For making water-gas, the ash-pit door is closed and steam from the boiler is injected beneath the grate of the generator while the fire is hot. The formation of the water-gas is completed, or the gas is "fixed" by causing it to pass down through the other generator, it having been found that a part of the hydrogen reverts to steam without so doing. The making of water-gas cools the fire and after a few minutes the steam must be shut off and air again substituted. While water-gas is being made it may go to the gasometer through the pipe *Z*, or, if desired, to permit it to go to the water-gas holder, *Z* may be closed and *Y* opened. When kept separate, water-gas is reserved for certain heating operations for which producer-gas, of lower calorific power, would be unsuited. The purge pipe *X* is opened when starting, and by this means air in the system is expelled before gas is turned into the gasometer. Steam may also be admitted above the fire, and thus caused to pass down through the generator and form water-gas. In fact, both air and steam may be introduced, either below or above the fires, to suit the best conditions of operating.

Comparing the two systems, the hand-poked producer costs 70 cents while the Hughes producer can be operated for 50 cents per ton of coal burned. At the same time a Hughes mechanically poked producer installation is estimated to cost \$38,960 as against \$45,200 for a hand-operated one.

## PULVERIZED COAL

This is prepared from run-of-mine or from slack coal. It is delivered by car into storage bins, whence it is drawn off upon a conveying belt to the feed hopper of a dryer, Fig. 72. The head pulley at the delivery end of the belt is magnetized, so that stray pieces of iron and steel are removed. In this way trouble is avoided in the grinding machines later on.

Dried down to 1 per cent moisture the dryer discharge feeds to a slightly corrugated roll set to reduce it to pea size. As fast as crushed this product is raised by a belt elevator to a stock-bin to be drawn off as desired to the Raymond roller mill, where it is to be pulverized.

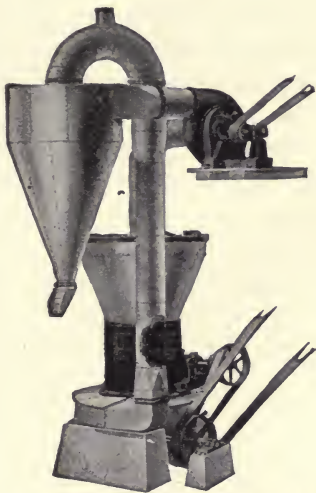

FIG. 17.—Raymond Roller Mill  
(belt driven).

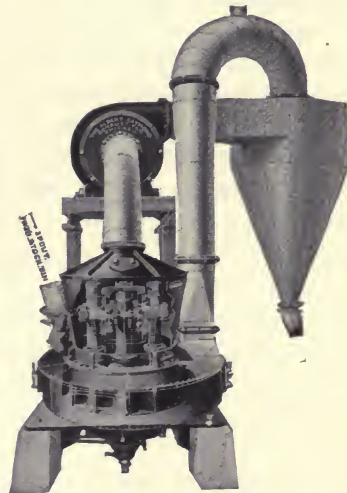

FIG. 18.—Raymond Roller Mill.

Fig. 17 is a view of the roller mill, where at the left is the spout from the stock-bin, having at its foot a deeply corrugated feed roller called "star feed." This, as it revolves, gives a regulated supply within the truncated casing, where the grinding is performed. As in the Huntington mill, there is a "bull ring," between which and the three suspended rolls the grinding is performed. A head on the central vertical shaft has three suspended shafts carrying the rolls, so that in rapid rotation they are strongly pressed against the inside of the bull ring, quickly pulverizing the coal. The suction pan above draws up the pulverized material, delivering it tangentially to the large collecting cone at the right, where it is whirled in cyclone fashion to the periphery to settle to the point of the cone. The air, thus freed from the bulk of its contained dust, is returned by the pipe rising from the top of the cone to the lower large exterior casing, and passes

upward inside the bull ring. The coarse particles, that have escaped grinding, and fallen to the bottom are lifted by plows that throw them up, and with the aid of the upward wind current, again lift them to the grinding zone.

The pulverized coal from the roller mill is taken by a screw conveyer to a pulverized coal-bin of 25 tons capacity. Thence it goes by other conveyors to the respective roasters. The coal must be so finely powdered that 85 per cent of it is of minus 200 mesh, since the finer it is ground, the greater its efficiency.

The method of feeding powdered coal to a reverberatory furnace is described under head of "pulverized coal-firing."

**The Holback Powdered Coal Distributing System.**—This comprises an air-supply pipe into which, under fan pressure powdered coal is fed by feed-screws from coal-storage bins branching to supply all the furnaces. A return pipe takes the excess of air, together with the unused coal back to the storage bins. As more air is used so the coal supply is automatically increased at the feed screws in direct proportion. A control valve is provided at each branch as also a burner for the coal and air to each furnace.



## CHAPTER III

### REFRACTORIES

#### REFRACTORY MATERIALS AND THEIR PROPERTIES

**General.**—The foundations of a furnace may be of concrete or of stone laid in lime-mortar, the moderately heated exterior of common building brick also laid in lime-mortar, but for the interior lining it is necessary to use refractory material to withstand the high temperature and to resist the scouring and corroding action of the molten contents of the furnace. At a temperature below a red heat the combined moisture of lime-mortar would be expelled, and the mortar in consequence would crumble. At a dull red heat many stones crack and flake off at the surface of irregular expansion. Sandstone, however, is resistant to fire, and has been used for furnace lining. Red bricks, laid in clay mortar, withstand a moderate red heat, but, at a temperature much above this, begin to soften or melt.

**Refractories.**—These substances are infusible at the high temperatures for which they are intended. Thus firebrick only begins to soften at 1500° to 1600° C., and silica brick at 1600° to 1700° C. Refractories may be divided into the three following classes:

**Acid (Silica-brick, Sand and Ganister).**—These are used to resist the scouring or corrosive action of acid slags. Being highly refractory they are more generally used for roofs or arches exposed to the highest temperatures. In such positions out of contact with the molten contents of furnaces they are not required to resist a serious fluxing action.

(2) **Neutral (Graphite, Chrome-iron, Fireclay, Bone-ash, and Carbon-brick).**—These materials well resist the action of neutral slags which are neither basic nor acid. In the case of a basic open-hearth furnace, for example, it is customary to interpose a layer of neutral chrome-iron brick between the roof of silica-brick and the basic-lined hearth slightly above the level of the surface of the molten contents of the furnace where it would be unaffected by it. Were silica-brick used in contact with the basic lining, they would react upon the lining and melt.

(3) **Basic (Dolomite, Magnesite, etc.).**—These are used where the slag or matte is basic, as in the hearth of the basic open-hearth furnace. Basic slags quickly scour or corrode an acid, or even a neutral lining. It will be noticed that all the foregoing refractories not only have special resistant

power but are infusible. This is particularly the case with carbon, either in the form of gas-carbon or charcoal.

#### ACID REFRACTORIES

**Sand.**—This is used in repairing or fettling the interior borders or walls of reverberatory furnaces. It is made to form a steep bank extending above the level of the molten bath, to protect the wall from the corrosive action of the molten slag. Repairs are made after the charge has been withdrawn, when the interior sides of the furnace are exposed. In copper reverberatory work the sand is thrown in by means of shovels, or placed by paddles or spoons provided with 16-ft. handles to allow the sand to be dropped at the exact spot required. Sometimes a little clay is incorporated with the sand that it may be formed into balls. These are skillfully thrown across the furnace through a door to an eroded spot, or inserted by means of the paddle, mentioned above, and pressed into position with the bowl of a long-handled ladle. The bottoms of reverberatory furnaces are frequently made of sand in layers, and each layer fired upon and melted successively, at the highest temperature of the furnace. The sand, fritted together, and hardened into a coherent bed in this way, is built to the thickness of perhaps 2 ft.

**Ganister.**—This is used for furnace- or converter-lining in copper work. It is composed of a mixture of crushed silicious rock or quartz to which has been added about 15 per cent clayey material to make it cohere. For acid-lined copper converters, a silicious ore carrying gold and silver may be used instead of barren quartz rock. The material is rapidly eaten or scoured away by the action of the molten charge, and the precious metal contained enters the charge. This in reality results in a kind of ore-smelting, performed incidentally, and without additional cost.

**Silica Brick.**—When quartz or sandstone, containing 98 per cent silica, is moistened and mixed in a wet pan (Fig. 170) with a little lime paste made from quick-lime, it coheres sufficiently to be molded into brick. These are first dried in a steam-heated drying-room, then carefully placed in kilns in open order, and burned at a temperature gradually increasing to a white heat. Fig. 19 represents a kiln of the down-draft type. It is a dome-shaped oven, 18 to 30 ft. diameter, coal-fired by means of fireplaces set in the exterior wall. The flues within this wall are arranged as shown, so that the entering flame rises to the crown of the arch, and, passing downward through the brick, goes to the adjoining stack through flues in the floor of the kiln. Thus a high even temperature is obtained, and the brick becomes sufficiently sintered to stand handling and transportation, though never as strong as the fireclay brick.

Besides the lime-bond brick, above described, made by the addition of

lime to silica, a clay-bond brick, less refractory, is made by the admixture of four parts of flint with one of clay. This makes a stronger brick than the lime-bond. The composition of each of these kinds of brick is as follows:

	Lime-bond Brick, Per Cent.	Clay-bond Brick, Per Cent.
SiO <sub>2</sub> .....	93.48	86.32
Al <sub>2</sub> O <sub>3</sub> .....	3.82	11.24
Total fluxing bases.....	2.62	2.50
	99.92	100.06

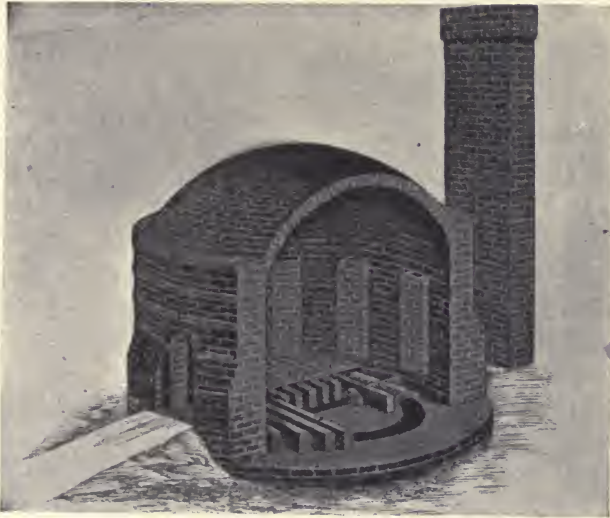

FIG. 19.—Brick Kiln.

The clay-bond brick shows its greater fusibility in its alumina and silica ratio, as will be seen under the constitution of firebrick, and the proportion of alkali is higher than in the lime-bond brick, causing it to be much less refractory. Silica brick withstands the highest temperatures, and expands when heated. To provide for this, expansion joints are arranged in the roof, side walls, and bridge of reverberatory furnaces, which close as the temperature rises. To slack off the tie-rods, also, is another way to accomplish the same purpose. Without this, furnace arches would bulge, and tie-rods would break. The linear expansion of these bricks when elevated in temperature to a white heat is 2.5 per cent.

## NEUTRAL AND BASIC REFRACTORIES

**Graphite or Plumbago.**—Pure carbon in the absence of air is permanent and infusible at the highest temperatures. This is well exemplified in the carbon filament of an incandescent lamp. Even in the arc-light, the carbons, though gradually consumed, do not melt. In blast-furnaces, pulverous carbon accumulates and forms scaffolds, and carbon-brick, made of gas-carbon, has been used with some degree of success for the bosh-lining of iron blast-furnaces. Graphite is essentially carbon, but contains as impurities a little iron and a small quantity of gangue substance. An analysis of Canadian graphite gives 2 per cent volatile matter, 20 per cent ash, and 80 per cent carbon. Such graphite is used for graphite or plumbago crucibles and retorts, when mixed with 45 per cent air-dried clay and 5 per cent sand. Graphite in these mixtures is not only refractory, but prevents shrinking and cracking when the crucible or other object is dried after being formed.

**Chromite or Chrome-iron.**—This is a double oxide of iron and chromium ( $\text{FeOCr}_2\text{O}_3$ ) generally containing a little gangue. Chrome ore is made into bricks by crushing the ore, mixing with lime as in making silica brick, and burning. These bricks should not contain more than 40 per cent  $\text{Cr}_2\text{O}_3$ . Chromite is not attacked by silicious slags, and resists high temperatures.

**Fireclay, Firebrick, and Tile.**—These refractories are the best known and the most used. The term fireclay applies to kinds of clay capable of withstanding a high degree of heat. In good fireclay the total percentage of fluxing impurities, such as ferric oxide, lime, magnesia, and the alkalis, is small (3.5 per cent or less). In all fireclay the water and some of the silica is combined chemically with the alumina. This forms a hydrous aluminum silicate, called kaolinite. Further silica present is in the form of quartz sand. Either kaolinite, or quartz alone, has a high fusion point ( $1850^\circ \text{C}$ .), but in mixture, the fusion point is lower, and this reaches a minimum at  $1670^\circ$  when 10 per cent kaolinite is present. By the continued addition of silica to kaolinite we therefore get a diminution of refractoriness until this exact proportion is reached, and after this, by continued addition of sand, an increase. The fireclay, accordingly, is most refractory that contains the lowest percentage of fluxing base, and the least uncombined sand. A factor further affecting the refractoriness is the coarseness of grain. The New Jersey air-dried clays have the following composition and refractory qualities:

	(IV) Per Cent.	(V) Per Cent.
Kaolinite (clay base).....	57.47	98.95
Free silica.....	40.09	0.24
Total fluxing bases.....	2.53	0.99
	<u>100.09</u>	<u>100.18</u>

	(IV) Per Cent.	(V) Per Cent.
SiO <sub>2</sub> .....	67.26	45.76
Al <sub>2</sub> O <sub>3</sub> .....	23.36	39.05
H <sub>2</sub> O (combined).....	6.94	14.46
Bases (Fe <sub>2</sub> O <sub>3</sub> , CaO, alkalis).....	2.53	0.99
	<hr/> 100.09	<hr/> 100.26
Temperature of fusion.....	1670° C.	1810° C.

The clay base is computed as Al<sub>2</sub>O<sub>3</sub>, 2SiO<sub>2</sub> with combined water. The silica not present in this combined form is regarded as "free." It is seen that the less refractory clay (IV) contains more fluxing base, more silica and less alumina than (V) to account for its fusibility. The first (IV), is harder than (V) because more fusible, and is an acid brick, whereas (V) is neutral. The second (IV), is a type of most of the Western firebrick.

Fireclays are used not only for firebrick and tile, but also for muffles, retorts, and clay vessels of different sorts. The clay varies much in plasticity. Clay alone is unsuited for brick, since in burning it shrinks and cracks. Firebrick manufacturers, therefore, employ a mixture of one or more grades of clay, adding also a certain percentage of coarsely ground firebrick called "chamotte." The addition of this unshrinking material prevents the cracking that otherwise would result. The assayer, who uses clay for luting, mixes with it for the same reason at least half its weight of sand. In the manufacture of firebrick the required mixture is ground in a dry-pan, a machine similar in construction to the Carlin mixing pan (see Fig. 170), but provided with a bottom made of perforated plates to discharge the material when ground sufficiently fine. Scrapers carried in front of the rollers throw material in their path, and the mixture when ground is screened, and further mixed in a horizontal pug-mill, being there tempered by the addition of water to the desired consistence.

The molding of brick is done by hand or by machine. If by hand the mixture is brought to the consistence of mud, and made into balls sufficiently large to fill a mold. (See Fig. 20.) The mold is first sanded to prevent the adhesive mud from sticking, and this is thrown into the mold with force, to fill it completely, the excess is cut off with a stick or wire, and the brick dumped on a

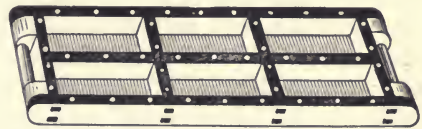

FIG. 20.—Brick-mould.

pallet or board. The pallets are placed upon racks, and air-dried until so stiff as to indent but slightly under pressure of the finger. They are then put through a re-pressing machine (Fig. 21), where they are given their exact form. When re-pressed, they are again placed on pallets and run into a dryer which is divided into chambers and heated by steam, waste

heat or radiated heat, so that the last of the moisture is removed. The bricks, now so coherent that they can be handled with little damage, are piled in open order in the kiln, already described (see Fig. 19), and are burned at a temperature between 1230 and 1390° C., requiring one to three weeks for this.

In machine molding, called the "stiff-mud process," the clay is tempered with less water, and is much stiffer when molded than in hand-molding. The general form of the stiff-mud machine, known as the auger machine, is that of a horizontal cylinder, closed at one end, and tapering to a rectangular outlet, the size of the cross-section of the brick at the other.

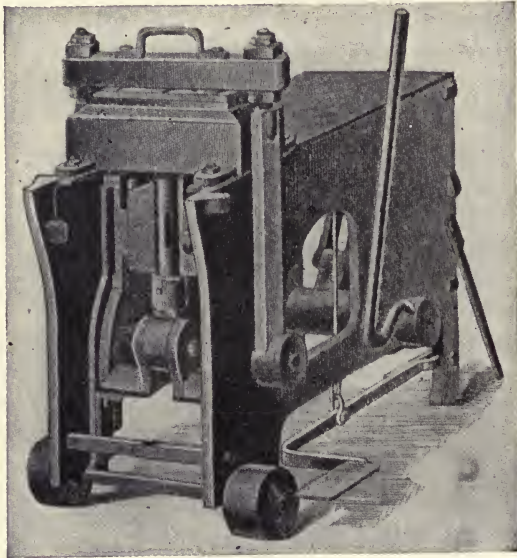

FIG. 21.—Repressing Machine.

Within the cylinder is a shaft carrying blades similar to those in a pug-mill, but at the end nearest the die, or outlet, the blades are replaced by a tapering screw. The tempered clay is fed into the cylinder at the end farthest from the die. It is mixed, and moved forward by the blades until seized by the screw which pushes it through the die. The bar of clay issuing from the machine is received upon a cutting table and cut into bricks by means of a wire frame. The further treatment of these bricks, with the drying, re-pressing, and burning, is like that of hand-molded bricks.

Another method of machine molding is called the dry-press process. In this method the mixture of clay and "grog" or coarsely ground brick is intimately mixed in a wet-pan with 10 per cent of water, molded in a dry

pressing machine, and is then sent direct to the kilns for burning into brick. The expense of drying is thus saved, but the brick is not of so good a quality as when otherwise made.

To resist abrasion, firebricks must be hard; to resist corrosion or slagging, dense; and to resist high temperature and sudden changes of temperature, porous and coarse in texture. We accordingly use the hard bricks for door-openings, dense ones for reverberatory furnace walls, and the porous and coarse ones for the roofs. The refractoriness of a firebrick depends on the quantity of the fluxing bases (especially alkalis) and silica contained, and on the coarseness of the grain. The grain depends again upon the degree to which the "grog" is ground.

**Bone Ash.**—This is made by burning bones, in a kiln with an excess of air, and grinding the white residue to 20-mesh size. Organic matter is thus removed and an impure calcium phosphate obtained. Though a neutral material, this resists the action of litharge, and it is accordingly used, not only in assaying, but in making the "tests" or movable hearths of the English cupelling furnace shown in Fig. 278.

#### BASIC REFRACTORIES

**Dolomite.**—The alkaline-earths, lime and magnesia, are strong bases and are resistant to basic slags, as shown later, but are readily fluxed by the silica of silicious slags. Quick-lime is infusible, but is easily affected by the moisture of the air, and insufficiently coherent to be used for making basic brick. Dolomite is magnesian limestone, and is a cheap refractory material. It is prepared for use by burning, much as is limestone. The proportion of lime to magnesia varies in dolomite, but the more magnesia the better for use as a refractory. The composition of a typical sample is as follows:

	Per Cent.
CaO.....	31.62
MgO.....	20.19
SiO <sub>2</sub> .....	1.70
FeO.....	1.22
CO <sub>2</sub> .....	45.35
	100.08

Dead-burned dolomite, specially prepared, has of late been substituted in part for magnesite as being cheaper.

**Magnesite.**—This is the most valuable of the basic materials. When magnesium carbonate is calcined at a high temperature and dead-burned to 0.5 per cent carbon dioxide, the residue is practically infusible. It is used in grain form for furnace linings, or is manufactured into magnesite brick for the same purpose. Magnesite is usually colored dark-brown by

the presence of about 4 per cent iron oxide. It is the presence of the iron that enables it to bond or set well in furnace bottoms. Its main use is for basic open-hearth furnaces where the slag contains as little as 15 per cent silica. It is used also as a lining for forehearths (where it is in contact with low-grade corrosive matte), also in lead, copper, or other heating or melting furnaces as well as for electric furnaces. The nature of the mineral is shown by the following analysis:

	Per Cent.
CaO.....	1.68
MgO.....	42.43
SiO <sub>2</sub> .....	0.92
Fe <sub>2</sub> O <sub>3</sub> and Al <sub>2</sub> O <sub>3</sub> .....	4.30
CO <sub>2</sub> and H <sub>2</sub> O.....	50.41
	99.74

**Carbon Brick.**—Gas carbon, such as is used for arc lights, is made into brick with a limited amount of gas-tar and burned in a kiln. This brick has been found to be particularly resistant and refractory in a reducing atmosphere, as at the bosh of an iron-furnace.

**Other Refractory Materials.**—A mixture of portland cement 2 parts, clay 1 part, and “chamotte” or coarsely ground firebrick 7 parts, moistened and molded into bricks or blocks, or used for patching furnaces, sets quickly and withstands a white heat without disintegrating. It is easily made and especially useful for rapid repairs. Only as much is mixed as is to be used at once.

While common red bricks are not refractory, the least fusible can be used in that part of the roof of a reverberatory furnace where the temperature is not high or only at a red heat. Such bricks are used for backing firebrick structures. As a general rule each kind of brick should be laid in a material similar to that of which it is composed. We should expect slagging to take place, for example, at joints made of loam-mortar in firebrick. Such loam, while cheap, is inferior to fireclay. An analysis of good loam gives:

	Per Cent.
SiO <sub>2</sub> .....	80.99
Al <sub>2</sub> O <sub>3</sub> .....	9.65
Total impurities.....	4.91
Ignition loss.....	4.43
	99.98

Here we note that the fluxing bases rise to nearly 5 per cent while alumina approaches 10 per cent, the ratio of the most fusible compound of alumina and silica. Where the fluxing bases rise above 5 per cent, there is risk of complete melting at high temperatures.



## CHAPTER IV

### THE PREPARATION OF ORES

We discuss this under the general heads of Sampling, Crushing, and Grinding, Screening and Classifying and Roasting.

We then take up the nature and operation of metallurgical furnaces and the principles of thermo-chemistry as preliminary to the whole question of roasting.

#### PRINCIPLES OF SAMPLING

Sampling consists in obtaining from a large quantity of ore a small portion of a few ounces for assay. This must correctly represent the entire quantity of the ore, whether it be a few hundred pounds or thousands of tons, a wagon-load or a ship-load. Often we have a lot of ore, in which rich pieces mingle with poorer ones, or even with waste. In sampling we must take this variation into account and represent each part, not only according to its value, but also to its quantity. Often ore is bought or sold upon the results of sampling. Thousands of dollars are involved and cash is paid for ore before the purchaser has treated it. In other cases, ores taken by the reduction works are treated separately, the owner receiving whatever is obtained, a charge being made to cover the cost of treatment and the profit to the reduction works. In this latter case sampling could be omitted. Similarly at a mill and mine, operated in one interest, the sampling may be omitted when considered an unnecessary expense. Efficiency of the work is then determined by the assay of the tailing.

If a reduction works is producing lead, copper, or zinc, in a form ready for market, the metals do not necessarily require to be sampled. Whenever the precious metals are also present in such quantity as to pay to separate them, however, the metal is sampled to learn the values contained before selling to the refining works that is to effect the separation. In blast-furnace treatment, ore and all other constituents of the charge are sampled, assayed, and analyzed. From the data thus obtained, the charge can be correctly calculated and proportioned.

Not only is it necessary to ascertain the value of ores and of metals that result from metallurgical operations, but as well the value of the portions rejected. The efficiency of the work of the metallurgist depends

upon thorough extraction from the parts thrown away. To be assured of this, samples of slag or tailing are taken at frequent intervals. In finding the value of a lot of ore, we first weigh the ore, and base the assay value upon the dry weight. To do this we must determine the percentage of moisture contained, as shown by a "moisture sample." We then sample the ore regularly, and finally assay the regular sample. Thus, suppose we have a lot of ore weighing 10,800 lb., containing 7 per cent moisture and by assay 54 per cent lead worth 3 cents per pound. Since the assay is made on the dry weight, we have, after deducting moisture, 10,044 lb. ore containing 5424 lb. lead worth, at 3 cents per pound, \$162.72.

#### RECEIVING, SAMPLING, CRUSHING, BEDDING, AND STORING ORES

The large smelting works in the Rocky Mountain region of the Western United States and Mexico buy their ores outright from mine-owners for treatment. Such works are called custom works. A plant treating principally ore from its own mines is called a mine works. In custom works all the kinds of ores, already enumerated, are sampled and bought upon a schedule of charges, generally established in advance between the works and the mine-owner.

**Receiving and Weighing.**—At reduction works that purchase ores (custom works), the ore arrives either loose or in sacks. Whether received by wagon or by car, the vehicle and ore are weighed together on platform scales, thus finding the "gross weight." When the vehicle is emptied, the weight, called the "tare," is similarly taken. The difference is the "net weight," or the "wet weight," and this is recorded. When ore arrives in sacks, the weight of the sacks also is deducted. Often sacked ore may be removed to scales to be weighed, and only the weight of the sacks deducted, the difference being the net or wet weight. Sacks, if of sufficient value, are dried and returned to the owner. Railroads often return them without extra charge. Sometimes the sacked ore, if pulverulent, rich, or frozen, may be charged, sack and all, into the blast-furnace, the sack serving to retain the fine contents until smelted, thus preventing the loss of flue dust.

**The Moisture Sample.**—In theory the moisture sample should be taken at the instant of weighing, since the ore may dry and become lighter. The sample is taken while the car is being unloaded or immediately afterward. To represent by the sample the ore as contained in the car, holes are dug at average points (setting aside the dry top layer) and small portions are taken of ore that appears to be of average moisture. These portions are put in a covered can, and 50 oz. of the mixture are weighed on a moisture-scale. After cautiously drying on a hot-plate, or preferably over-night on steam-coils, the 50-oz. portion is again weighed, and the

percentage of moisture determined by the loss in weight. The shipper often sends a representative to watch the sampling of his ore. Such a man should pay attention to this detail, otherwise too high a percentage may be deducted for moisture.

Sampling methods may be divided into two classes: hand-sampling and machine- or automatic-sampling. Any method of sampling includes the starting and finishing operations.

**Hand Sampling.**—This includes the methods called “grab sampling” and “trench sampling,” which are imperfect, and the regular methods known as, “coning and quartering,” “fractional selection” and sampling with the “split shovel.”

For determining the contents of fluxes and fuels and certain furnace products, the “grab sample” may serve. It consists in taking at uniform distances over the pile or lot, similar amounts broken from the lumps and taken from the fine. These portions are mixed and sampled by coning and quartering, by fractional selection, or by using the split shovel.

**Coning and Quartering.**—The ore is crushed and put in a circle or ring about 8 ft. diameter on the sampling floor. The workman circles within this ring, shoveling all the ore to the apex of a cone at the center. This completed with the shovel working from the apex radially, the ore is drawn into a flat disk. This is marked by diametral lines into four equal portions, of which two opposite ones are left as I and III, Fig. 22, on the floor and II and IV removed. The reserved sectors are again shoveled into a ring, then made into a cone, now half the size of the first one.

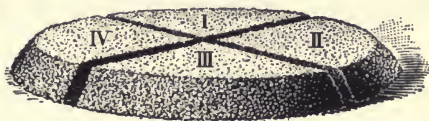

FIG. 22.—Quartering an Ore in Sampling.

This is again flattened into a disk, quartered and the two opposite quarters reserved. The process goes on in this way until the sample has become of small bulk, say of 2 lb. weight, when it should be again ground to pass through an 80-mesh screen. It is thoroughly mixed by “rolling” on a sheet of thin rubber cloth, and the mixed product distributed into one or several 4-oz. bottles or into manila sample-sacks which are marked with the name and particulars of the sampled lot.

**Fractional selection** differs from the quartering method in that every second or fourth shovelful is reserved and coned as above described, for the purpose of mixing. From this cone each second or fourth shovelful is again reserved and coned, and this continues until it is necessary to recrush. After this, reduction in bulk again proceeds using a smaller shovel, according in size with that of the sample.

In sampling by the split-shovel, a good tool is shown in Fig. 23, the Brunton quartering shovel, the central compartment holding the sample. From the already-mixed pile shovelfuls are taken, and by backward movements

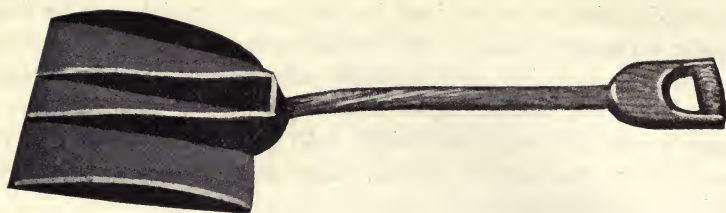

FIG. 23.—Brunton's Quartering Shovel.

three-fourths of it slides from the shovel blade into a heap, the remaining fourth in the central compartment being thrown into a separate pile.

This pile is attacked in the same way, so that successively the amount to be sampled rapidly decreases.

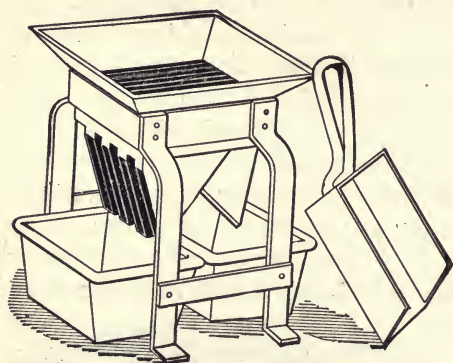

FIG. 24.—Jones Sampler.

the left-hand one. Either half is again cut down in the same manner, and so until but a small bulk remains, truly representative of the original.

#### Machine or Automatic Sampling.

—It will be seen that the methods of sampling by hand as just described, especially for large lots, involve much labor, and it has been sought to overcome this by the use of machinery. A sample from a stream of ore, coming from a crushing machine, and called a "running sample," is taken automatically, this stream being deflected to one chute four-fifths of the time and to another, as a sample, one-fifth of the time, as shown in the Vezin sam-

The ore collected upon the sampling room floor is there cut down by cutting and coning or by means of a Jones sampler, Fig. 24, until it weighs 10 lb.

Fig. 24 is a view of a riffled sampler. The ore, evenly spread in the scoop, is so distributed in the riffles that one-half goes to the right-hand part and half to

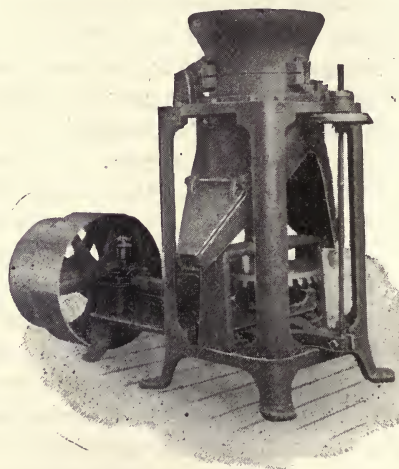

FIG. 25.—A Sample-grinding Mill.

pler, Fig. 27. It consists of a tube carried by a vertical shaft making 30 R.P.M. Attached to the side of the tube and opening into it is a scoop. As the shaft revolves "counter-clockwise" the scoop (occupying one-fifth of the circumference) cuts through the stream of ore from the inclined feed-chute for one-fifth of the time. The ore thus intercepted falls through the tube and becomes the sample, while the four-fifths, the rejected portion, falling into the main hopper, is delivered by the chute to a bin.



FIG. 26.—Braun Disk Grinder.

**Sampling Mill.**—Fig. 28 is a sectional elevation of a sampling mill. An ore dump-car at the right discharges its load into a sloping-bottom ore bin, whence it is drawn off by a sliding bin-gate and fed to a 15 by 9 in. Blake crusher (see Fig. 34). The discharge from the crusher falls into the

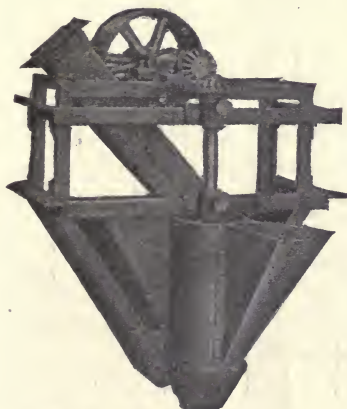

FIG. 27.—Vezin Sampler.

boot of a vertical elevator, which raises it to the top of the building and feeds it to the chute of a Snyder sampler or a Vezin Sampler, Fig. 27, where 20 per cent of the stream is cut out to go to the 7 by 9 in. Blake crusher just below. The crushed product of the crusher is again spouted to a second sampler, where again 20 per cent of the stream is saved, and thence to rolls (see Fig. 43). The roll-product passes on to a third sampler, where again one-fifth or 20 per cent of the flow is caught to be more finely crushed, to, say,  $\frac{1}{2}$  in. in size, in a smaller roll, whose whole product falls upon the floor of the sampling room. The rejected ore from upper sampler, amounting to 80 per cent of the whole, is shot back into an ore dump-car. The rejected portions from No. 2 and No. 3 sampler pass out at the side of the building to fall in a pile upon the ground.

The product is mixed on a mixing cloth, cut down by a smaller Jones riffle to 2 lb., dried in a steam-oven, and finely ground on a bucking-plate or in a disk-grinder, Fig. 26, to 80-mesh or finer.

The Braun Disk-grinder is here shown as opened for cleaning. Fine grinding is done between the two fluted disks when the machine is closed

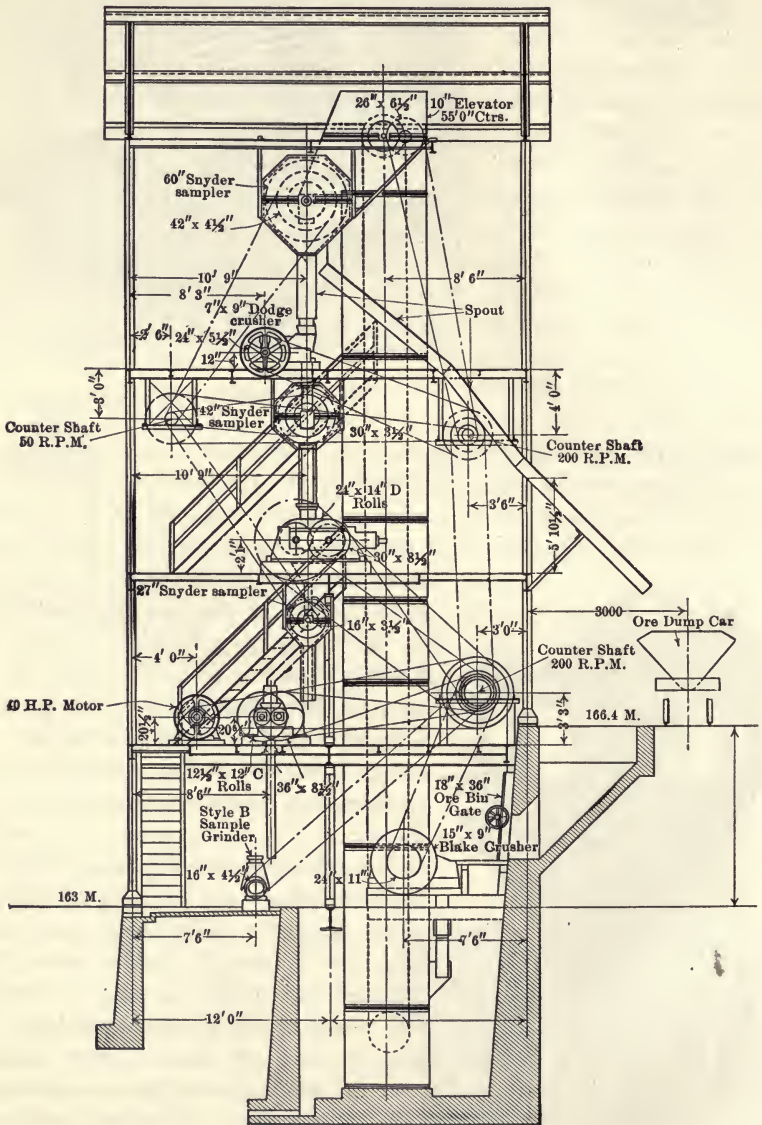

FIG. 28.—A Sampling Mill.

for action. The hinged disk is pressed against the revolving one, the flutes conducting the ore downward between the grinding surfaces to the drawer

below. The ground material is passed through a screen, the oversize being returned to the grinder.

**Finishing the Sample.**—The ground product is now mixed by “rolling” on a rubber mixing cloth and distributed into manila paper sample-sacks that hold 3 or 4 oz. each.

The final operations, from the taking from the sample safe, are called “finishing the sample.”

At a custom works all the ore is stored in a sample safe or can and there is held until the ore-lot has become the property of the works by purchase.

**Sampling of Ores Containing Metallic Substances.**—This is an operation requiring a clear knowledge of the principles of sampling. We come upon these “metallics” sometimes in the operation of sampling. They must be separated, cut smaller, and quartered down separately by a hand-method, and reduced in size, at the same rate as the fine ore. If a fine substance is made by cutting up the metallics it can be united with fine ore. Often metallics are brittle, but with diligent work can be broken, cut and “quartered down” without serious difficulty.

**Cost of Sampling.**—In 1910 the cost of moving the ore cars, unloading into bins, returning the cars to the sampling-mill, and unloading the fractional part, usually one-tenth, retained was taken at 10 cents per ton. The cost of hand-sampling the tenth part was taken at 75 cents per ton. Hence, for unloading and hand-sampling a 100-ton lot, the total cost was 17.5 cents per ton. At the Metallic Extraction Works, Cyanide, Colorado, ore was then unloaded from the car to a feed-chute crushed to  $\frac{3}{4}$ -in. size, automatically sampled and delivered to storage bins, for 11 cents per ton. A charge of \$1 to \$2 per ton has been made for sampling, storing, assaying, and selling ore at custom works or sampling-mills, where the company has acted as selling agent and obtained the best possible price for the shipper. The price for sampling concentrate was 50 cents per ton less.

**Sampling Concentrate, Tailing, and Ore-pulps.**—Concentrate is sampled easily, for it can be thoroughly mixed and sampled by hand. Tailing carries 40 to 50 per cent moisture. It has but little value, and needs no close attention. Ore-pulp flowing in a launder is often automatically sampled.

Fig. 29 shows the machine used for this. The pulp flow, entering by the chute on the left, is carried away by a launder set to receive it. As the wheel revolves, the attached scoops divert part of the flow into a compartment of the receiving box. When not so sampled, a bucketful, taken each hour from the stream, and all these samples united in one portion after decanting the water, may be used to determine the approximate daily average value. When loaded into cars, the sample is sometimes taken by boring to the bottom of the body of ore, using a ship auger, or again by a pipe driven downward. This is a kind of grab-sampling, but

serves in mills where such an approximation is considered sufficiently accurate.

**Sampling Iron Ores.**—These, being uniform in constitution, are more simply sampled. The railroad cars are sampled by taking a grab-sample at six or eight places uniformly over the load. From this an analysis determines the character of the ore, and where it is to be stored for shipment by ore-boat. Later the cargo is sampled at the receiving port. This is done by taking grab-samples upon the exposed surfaces of the ore in the hatches while it is being unloaded the ore being immediately put in closely covered cans so that its moisture shall be conserved.

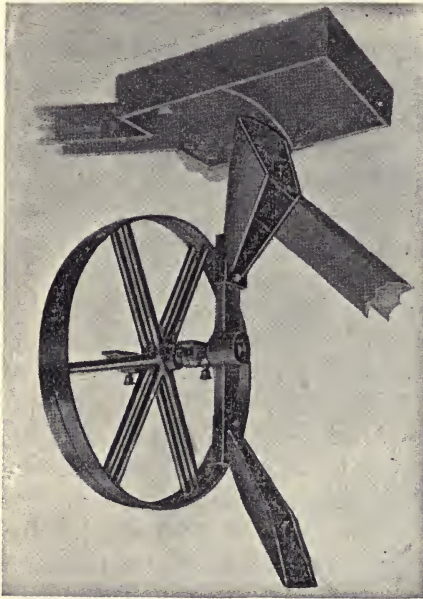

FIG. 29.—Tailings Sampler.

**Mill Samples.**—The value of the ore going to the mill (the mill heads) is estimated as the value of the product plus the tailings loss. As a check a sample is taken of the ball-mill discharge, this being dried, solution and all and assayed.

Knowing the specific gravity of the discharge we can compute its contained solution, whose value is subtracted from that of the solution taken as a drip from the storage solution tank. This checks within 4 per cent of the product-plus-tailings result.

**Dip-samples** are taken hourly of the various agitator and thickener pulps and solutions. To prevent further dissolution by the cyanide, 10 c.c. of a 10 per cent solution of sodium sulphide is added to each dip-solution once per shift. They are filtered, washed and dried for assay, and results promptly reported.

**Principles of Sampling.**—In the progressive crushing above described, it will be observed that the ore is made finer as the sample becomes less. This is to make sure of a constant ratio between the size of a single rich piece and the whole sample, that such rich piece shall not produce an appreciable effect on the assay value, whether it be present or absent. The richer, and at the same time the more "spotty" or varied the ore, the finer it should be crushed before cutting-down or quartering. The table below shows how this is arranged in practice:



## SIZE OF LARGEST PIECES

Weight of Ore.	VALUE IN SILVER OUNCES PER TON.		
	Highest 300, Average 50.	Highest 3000, Average 75	Highest 10,000, Ave. 500.
100 tons to 10 tons.....	Cocanut	Fist	Fist
10 tons to 1 ton.....	Orange	Egg	Walnut
1 ton to 200 lb.....	Walnut	Chestnut	Chestnut
200 lb. to 5 lb.....	Pea	Wheat	Wheat
5 lb. to bottle sample.....	20-mesh	25-mesh	50-mesh
Bottle sample.....	80-mesh	100-mesh	120-mesh

We may conclude that for accurate sampling the requirements are:

(1) The taking uniformly frequent portions to ensure an average of the stream of ore as it is undergoing progressive sampling.

(2) Thorough mixing of the ore to ensure uniform richness.

**The Martin Sampling Machine.**—This machine excavates the slime or mud of flotation concentrates containing 20 per cent moisture from railroad cars transferring it to bins and taking out a sample in so doing.

The bin, long and narrow, has a slit 4 ft. wide in the bottom covered by transverse plank. The furnace charge-car runs beneath the bin, so that the material is drawn off to the car by taking up the planks progressively. Centrally above the bins is the sampling machine which travels freely delivering the slime where desired.

On the nearby parallel track is stationed the train of cars loaded with the slime. The machine is furnished with a grab-bucket, and moves along the track where needed for excavating. The load is delivered upon a slowly moving 8-ft.-wide endless sheet-metal belt discharging thence upon a reel the width of the belt. The reel is made up of several disks 18 in. diameter with wires stretched from end to end over them at 6 in. intervals. The sheet of slime is chopped up by the disks and wires of the reel and falls in lumps upon a hollow cylinder of 15-in. diameter having a slit in it of one-tenth its circumference. As the cylinder revolves the material falls upon it, and when the slit comes under them it falls out of the slit again upon a conveying belt covered with a dry calcareous sand from a nearby deposit. This belt takes this supply from a bin, the head pulley of it being within the traveling sample mill and delivering its load of sand and slime where another divider belt takes out a tenth, so that a 1 per cent sample is obtained.

It will unload 80 tons per hour, where, when unloading by hand, the cost was 20 cents per ton.

**Pulp Sampler.**—As shown in Fig. 30, this consists of a disk with an attached pipe. The disk is counter-weighted, so that when past the axis,

it suddenly falls, the pipe sweeping through the tailings stream. One may note a slot in the pipe where the pulp from the tailings stream enters. As

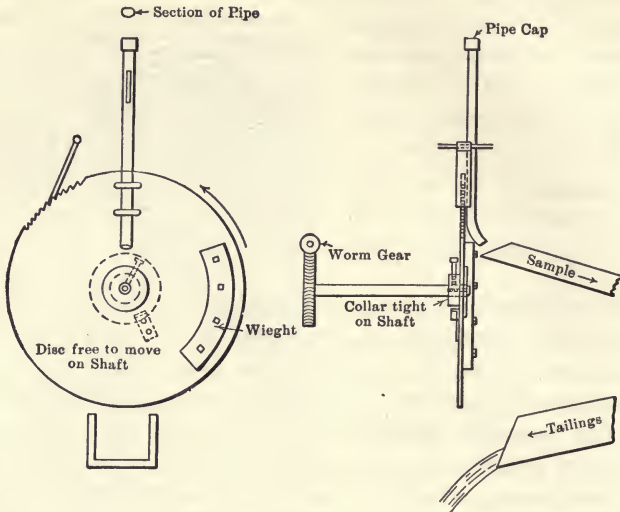

FIG. 30.—Pulp-sampler.

the pipe is lifted with the disk again into its vertical position the pulp flows out of the lower end of the pipe into the sample launder.

### SAMPLING METALS

Metals may be sampled either in the solid or molten state.

**Gold or Silver Bars or Ingots.**—These are sampled for assay either by granulating a small portion of them or by taking chip-samples from them. In the first case, while the metal is in a molten condition, a small ladleful, weighing an ounce or less, is taken from the crucible immediately after stirring it. This is poured into a bucketful of water, thereby granulating the metal and forming particles of a variety of sizes, convenient for weighing and assay. Chip-samples are taken at points diagonally opposite on the edges of the bar, and a cold-chisel, cutting out a small wedge-shaped piece, is used for this purpose. The pieces are annealed and rolled into a ribbon for assay. The average assay-value of the two pieces thus obtained is taken as the true value.

**Base-bullion.**—This is lead that comes from silver-lead blast-furnaces, and it contains commonly 100 to 400 oz. of silver per ton. When poured into molds to be cast in bars, the silver segregates, and the exterior of the bar, that cools first, is richer in silver by several ounces than the central part. This is illustrated in the cross-section of a bar (Fig. 31), in which

the center of the bar assays 10 ounces less than the exterior. Base-bullion is sometimes sampled by taking two "chips" or punchings, one from the top and one from the bottom of each bar. The punch (Fig. 32), resembling a belt punch, is 8 in. long and removes a cylindrical piece of  $1\frac{1}{8}$  in. diameter by about  $1\frac{1}{2}$  in. length.

From a carload lot of 400 bars, 800 of these chips would be obtained. These are melted and the fused metal stirred in a plumbago crucible and cast into bar. This is a sample of a 400-bar lot of base-bullion, equivalent to 20 tons. A better way of sampling, however, is to remelt the metal in a large kettle (see Fig. 276), and to skim and recast into bars for shipment.

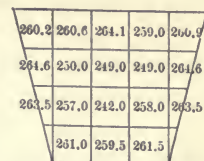

Average 258.2 oz. silver per ton

FIG. 31.—Distribution of Silver in a Bar of Base-bullion.



FIG. 32.—Base-bullion Sampling-punch.

While casting the metal, a sample is taken from the molten bath and poured into a bullet-mold of such a size that each bullet weighs approximately a half assay-ton. This is trimmed to the exact weight for the assay.

**Copper Ingots or Anodes.**—The segregation of gold and silver in copper ingots is even more marked than in bars of base-bullion. This is shown in Fig. 33, which represents the distribution of gold and silver in an ingot of blister-copper 5 in. deep. In this case, however, the interior is higher both in silver and gold. The usual way to sample such bars is to drill into them and retain the borings for a sample. Manifestly a sample like this is uncertain, and depends upon the selection of the place on the ingot for taking it. To obviate this difficulty, in sampling a lot, say of 100 bars, it is customary to drill into each succeeding bar at a different spot to obtain an average by so doing. It is preferable, however, to take the sample at the time the copper is melted and well mixed in the furnace by poling. As in the case of base-bullion, samples of copper are taken while dipping or casting, one at the beginning, one when the charge is half removed, and one toward the end. The average of the three samples is regarded a correct representation.

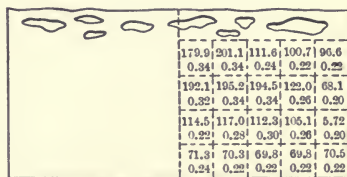

FIG. 33.—Section of Bar of Ingot Copper.

**Pig Iron.**—This is sampled and graded by inspecting its fracture and by chemical analysis. When an analysis is to be made, the sample is taken from the drillings of a small bar, molded while the metal is flowing from the furnace. The percentage of silicon determines the grade, the whole of the sample pieces being dissolved for assay.

## CHAPTER V

### CRUSHING AND GRINDING, SCREENING AND CLASSIFYING

**Size of Run-of-mine Ore.**—This, as it comes from underground, or from open-cut, will vary from pieces several tons in weight to dust which, when wet, is called slime. The larger pieces may be broken to sizes suited to loading by hand sledging or by block-holing, that is, by drilling and shooting them. Since this is more expensive than breaking by rock-breakers, the plan is to have these machines large enough to take such pieces, especially if they are hard to break.

#### PRINCIPLES OF CRUSHING

**Power Needed in Crushing.**—The work done in crushing varies inversely with the size to which the ore particles are crushed, or directly according to the increase of surface.

Thus a ton of quartz ore, composed of 1-in. cubes, if crushed to 0.5-in. cube would need 0.257 horse-power to so reduce it. The diameter of these smaller cubes will then be one-half, while their surface will be double that of the original ones. The surface of a 1-in. cube is 6 sq. in., and that of the resultant eight 0.5-in. cubes will be  $8 \times 6 \times 0.5^2 = 12$  sq. in. Were the 1-in. cubes crushed to 0.25 in., or one-fourth, the surface of them would be 24 sq. in. and the power needed would be 0.514 H.P. This rule is fairly constant with the coarse sizes, but with the finer ones the increase of surface is more rapid than the work needed to produce them.

**Action of Machines in Crushing.**—Crushing may be effected in either of two ways: In the first, the breaking is due to the impact of two approaching surfaces, as in rock-breakers, stamps, or rolls. In the second the surfaces move over one another, the ore being interposed and abraded or sheared, as, for example, in grinding pans, coffee-mill grinders, and the Braun sample-grinder. Often both actions are taking place, as in ball-mills and tube-mills.

**Stage Grinding.**—The operations of reducing an ore to a fineness, such that its mineral particles can be acted on by a solvent, separated by concentration or roasted, is done by crushing in stages. The first stage, or coarse-crushing, is done by rock-breakers reducing the ore, so that its larger piece will be no more than 1.0 to 2.0 in diameter. The second, or

intermediate crushing, aims to reduce the coarse-crushed ore to 30- or 40-mesh size, this being done by stamps, rolls, or ball-mills. The third, or fine grinding, takes this product and grinds it, so that much of it will pass a 200-mesh screen.

A point to be observed in preparing ore for leaching is to avoid making slime in crushing. Any considerable portion of finely ground or slimed material hinders percolation greatly. If grinding is performed by rolls, a more granular product, containing less slime, is produced than by crushing to the same screen-size with stamps. If it is desired to obtain the maximum quantity of sand and the minimum of slime, then gradual reduction, or graded crushing, should be adopted. This consists in first screening out the ore, already sufficiently fine.

**Screen Sizes.**—We specify the size of a piece of ore by saying that it will just pass through a 2-in. or 4-in. ring, for instance, or through a screen having round or square openings of that size. For smaller pieces or particles, the size is designated as being able to pass through a wire-mesh screen, the distance, center to center of the wire, being meant. The opening is less than this distance by the thickness of the wire. Thus a 20-in. mesh screen would be one having 20 wires to the inch, or 0.05 in. center to center, and also 20 openings, whose size would depend on the thickness of the wire. Thus, the diameter of the wire might vary from 0.025 to 0.009 in., and the resultant opening from 0.025 to 0.041 in. Where the thickness of the wire is equal to one-half the mesh, then the percentage of opening is 25 per cent, and the largest particle that can pass the screen is  $\frac{1}{40}$ , or 0.025 in. This proportion is sanctioned when the actual wire size has not been specified.

### COARSE OR PRIMARY CRUSHING

Two kinds of rock-breakers are in general use for coarse crushing—the Blake and the gyratory. Blake crushers, with a feed-aperture of 5 ft. by 6 ft., have been made so that pieces of rock of nearly that size, and weighing four or five tons, can be broken. Such large machines are expensive, and so hand-breaking may be done when the rock favors it. Blake crushers have been made to take a boulder as large as 5 ft. while recently, gyratory crushers have been built having a receiving opening of 5×15 ft., weighing 237 tons, and having a capacity of 2500 tons per hour. For the same width of aperture a gyratory crusher costs nearly two and a half times the Blake. It is convenient to remember that either kind requires about one horse-power to crush one ton per hour.

**The Blake Crusher.**—Fig. 34 is a view of a Blake crusher or breaker. Fig. 35 is a section of one having a receiving opening 20×20 in. This crushes ore as it comes from the mine, containing pieces as large as 12 in. diameter, at the rate of 25 tons per hour. There are, however, clayey

and talcose wet ores containing 25 to 30 per cent moisture that stick to the rock-breaker, and are impossible to crush in the wet state. Such ore may be first dried in a cylindrical dryer. The Blake rock-crusher is shown in perspective in Fig. 34 and in longitudinal section in Fig. 35. It consists of a heavy cast-iron frame, marked *N*, within which is placed the fixed jaw *F* and the swinging jaw *B* and between them the ore is crushed. A shaft *T*, eccentric where it passes through the pitman *K*, causes this to rise and fall, producing a corresponding movement of the adjacent ends of the toggles *J, J*. As these rise, the effect is to push the jaw forward to

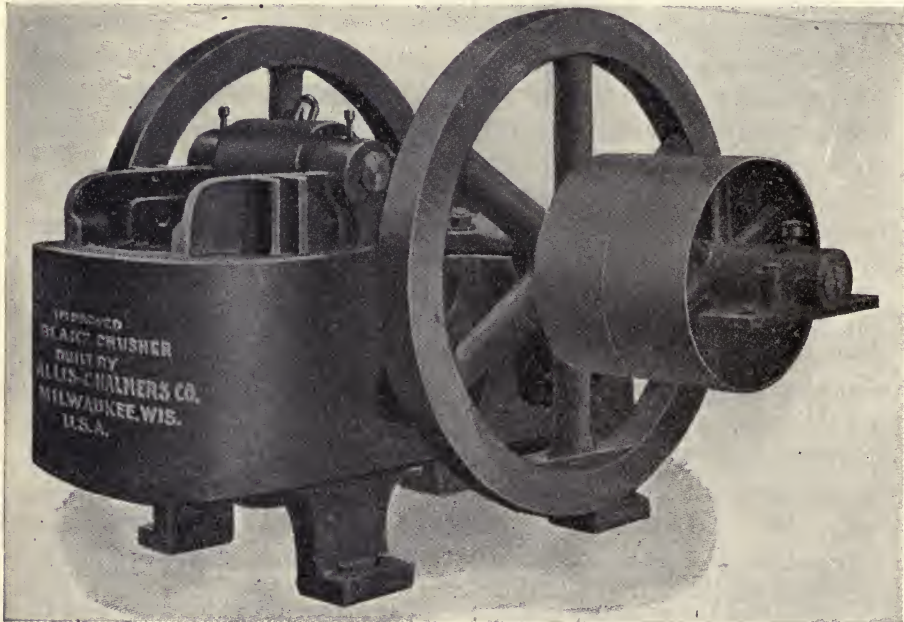

FIG. 34.—The Blake Ore-crusher.

produce the crushing movement. As the pitman and the toggles descend the jaw recedes, and is pulled back by the spring rod *P* and the spring *R*. Flywheels *A* help to steady the movement. The machine is driven by the pulley at 250 revolutions per minute. The movement of the lower end of the jaw is  $\frac{1}{4}$  to  $\frac{3}{8}$  in. For the breaker above specified, the discharge-opening would be 20 by  $1\frac{1}{2}$  in. to crush to  $1\frac{1}{2}$ -in. size. The receiving opening would be 20 by 12 in., and would take pieces as large as 12-in. diameter.

**The Gyratory Crusher.**—Fig. 36 is a perspective view, and Fig. 37 a sectional elevation of this type of crusher. Referring to Fig. 37 (the bottom plate dropped) is a main frame or body 2 and 3, with a three-

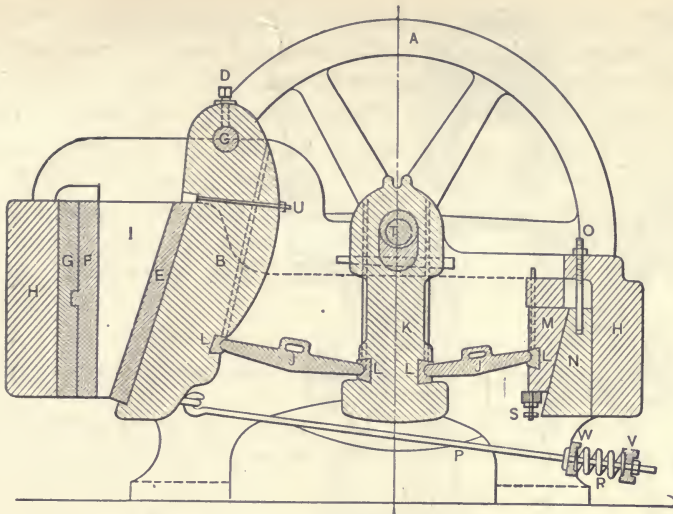

FIG. 35.—Blake Ore-crusher (section).



FIG. 36.—Gyratory Crusher.

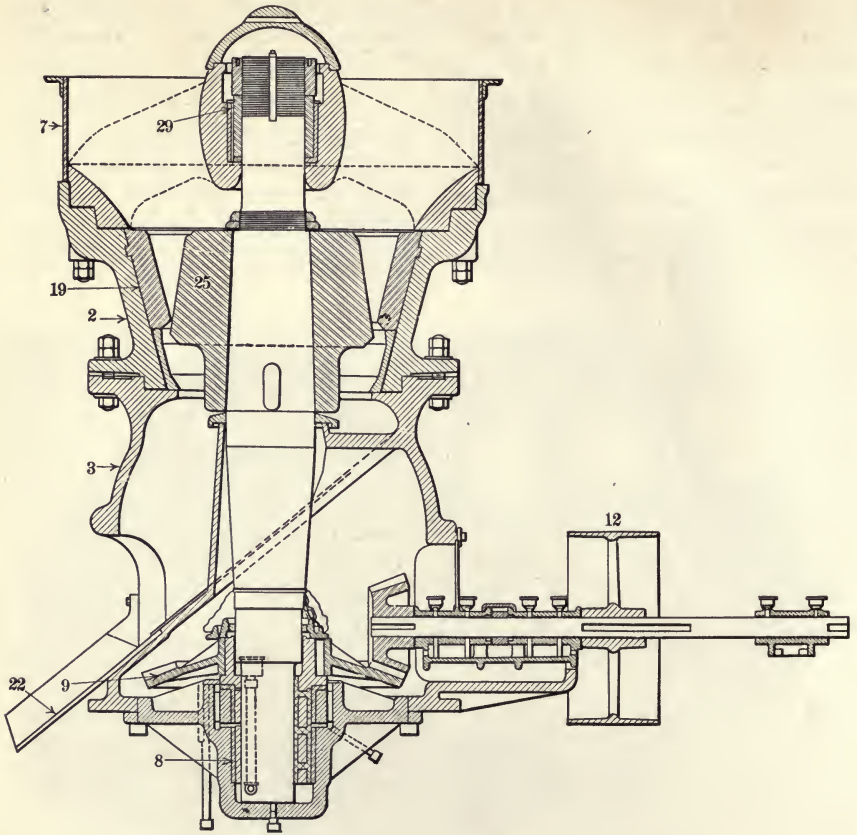

FIG. 37.—Gyratory Crusher (section).

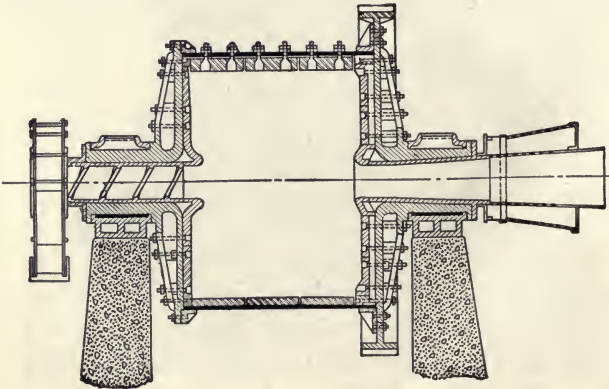

FIG. 38.—Overflow Ball-mill (section).



legged spider to carry the top of the spindle or vertical shaft. This is surmounted by an ore-hopper 7, the ore falling between the legs of the spider to be crushed between the liners, 19 of the body 3, and the cone-shaped head of the spindle 25. The lower end of the spindle is moved in a circle without revolving, by an eccentric sleeve 8, made in one with the bevel gear 9. Thus the opening between the head and the liner is alternately opened and closed, crushing the ore, the product discharging over the chilled wearing-plates 22. The amount of the jaw-opening can be varied by raising the spindle using the lighter-screw 29. At 12 is the belt-driving pulley.

#### INTERMEDIATE OR FINE CRUSHING OR COARSE GRINDING

This is done largely by stamps, by pans, by ball-mills, by rolls, by Chilian mills and by the Symons disk-crusher. Ball-mills and pans are

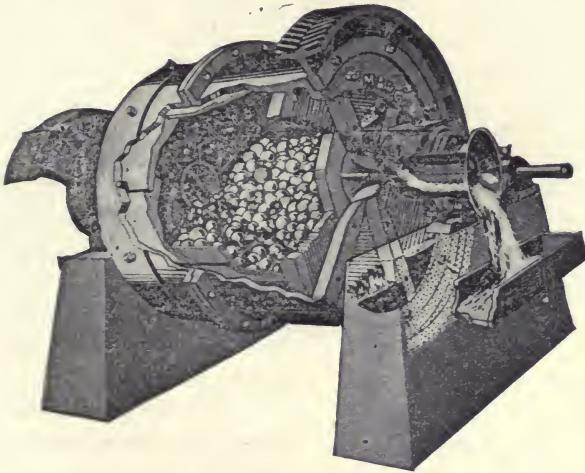

FIG. 39.—Marcy Ball-mill (perspective view).

good intermediate grinders up to 100-mesh, and to this point they are economical. There is a tendency at present to supplant stamps, heretofore so largely used, by ball-mills, except in cases where inside and outside amalgamation is to be used.

**The Stamp-mill.**—This is given under the head of amalgamation as used in gold-mill practice. It will take ore of 1 to  $1\frac{1}{2}$  in. in diameter and will reduce it to pass a battery-screen aperture, economically of not less than 0.15 to 0.4 in. The stamp-mill has reached its greatest development on the Rand in South Africa. It is held that while heavier stamps have been used, those of 1600 lb. falling weight are the practical

limit. The tendency in American practice is to replace the stamps by ball-mills in new construction.

**The Ball-mill.**—Fig. 38 is a view of a ball-mill, showing the spiral scoop that picks up the feed and delivers it into the mill and the

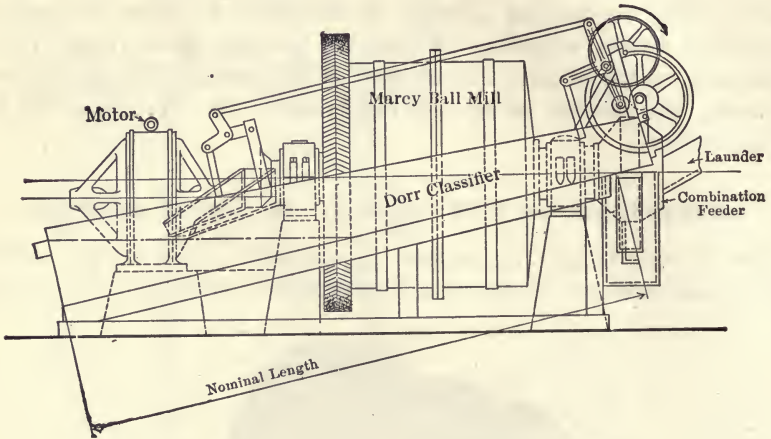

FIG. 40.—Ball-mill in Closed Circuit.

flaring discharge for the exit of the ground pulp. The discharge is screened to remove the finer sand, while the coarser, discharging at the extreme end, is returned for regrinding. The mill has a self-locking lining needing no bolts through the cylindrical shell. The mill is filled about half full of flint-pebbles, such as are employed for tube-mills, generally imported

from Scandinavian countries or from France. In place of pebbles, iron or steel balls are increasingly in use, these often toughened by the addition of manganese or chromium. The discharge of the mill may be protected by a grid or perforated plate, see Fig. 39, as in the Marcy mill, to hold the balls or pebbles back while permitting the escape of the ground material.

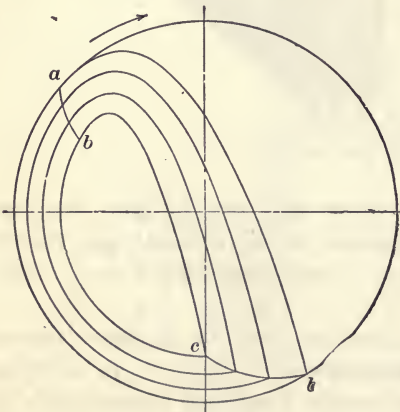

FIG. 41.—Path of Travel of Ore-particles.

**Proportions and Efficiency.**—Fig. 41 shows the paths of travel of particles in a ball-mill 8 ft. diameter by 6 ft. long. It is assumed that the steel balls are from 3 in. to 2 in. diameter, and that when they are much smaller than this they are

removed, as being a hindrance rather than an aid in comminution, being replaced by 3-in. balls. At the correct speed 22 R.P.M. there will be needed 180 H.P.

On a medium-hard porphyry ore, such a mill should grind in twenty-four hours from  $2\frac{1}{2}$  in. size to minus 48-mesh about 45 tons, or of a hard quartz ore half, and of soft porphyry twice this. We distinguish between the circulating load, which is that which makes the cycle through the mill and classifier, and the input load, being the original ore plus the circulating load. The water used will vary from 30 per cent to 50 per cent of the ore for the most efficient grinding. The mill is lined throughout with heavy manganese-steel plates.

**The Hardinge Conical Mill.**—This ball-mill, as shown in Fig. 42, has conical ends with a cylindrical center of 36 in. for a mill 8 ft. diameter

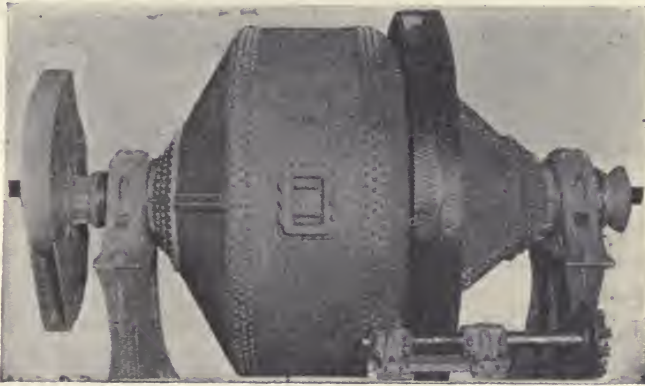

FIG. 42.—Hardinge Conical Mill.

by 22 ft. long. It feeds and delivers as in the Marcy mill. Due to its shape, the larger balls keep to the larger diameter, so that only the finely ground product and the worn particles from the balls discharge. Each day a few new balls are fed into the feed-scoop.

For best performance in a mill of this size the balls would weigh 28,000 lb. and would occupy 0.3 to 0.4 of the volume of the mill, or as much as is shown in the figure. It should yield  $7\frac{1}{2}$  tons per hour on average ore, covering from  $\frac{1}{4}$  in. to 200-mesh size.

Fig. 40 is an elevation of a Marcy ball mill,  $4\frac{1}{2}$  ft. diameter, inclosed circuit with a Dorr classifier. At the right end is a feeder, which scoops up the coarsely crushed ore and the water from the box which receives this feed from a launder. Entering the mill, the ore is crushed by the tough manganese steel balls that are lifted up and fall upon it, due to the revolution of the mill. The mill is driven by herring-bone gearing and electric

motor at 230 R.P.M. The discharge goes to the lower end of the Dorr classifier. Here the unground particles sink and are gradually raked to the upper end to return to the mill-feed box. At the lower end of the

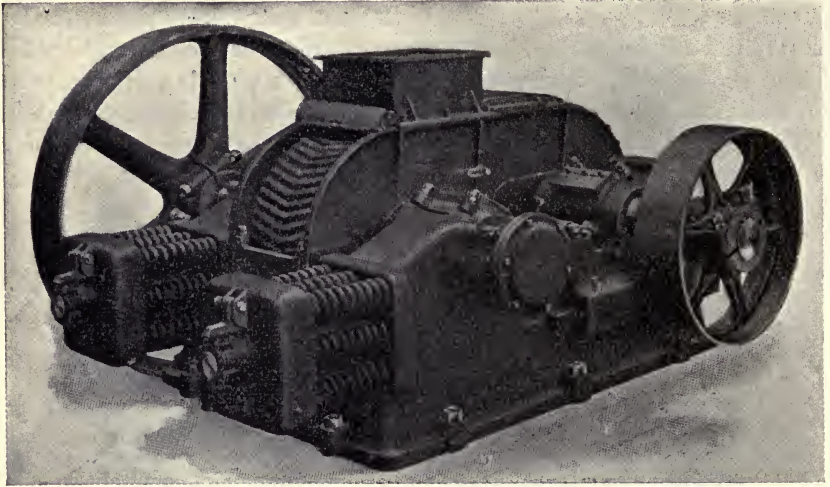

FIG. 43.—Fifty-four Inch Crushing Rolls.

classifier the floating, finely ground product or slime overflows, ready for further treatment.

**Crushing Rolls.** — We show in Fig. 43 a perspective view of rolls having grooved shells or tires; in Fig. 44 plan and elevations of rolls having smooth shells. In the plan and outside elevation in Fig. 45 the fixed roll is at the right, in Fig. 43 at the left, and the movable or spring-roll is carried in sliding boxes.

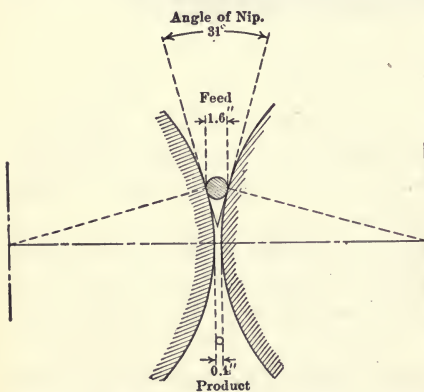

FIG. 44.—Angle of Nip.

The long, heavy tension rods have capstan nuts at both ends for tightening the springs against the sliding boxes. In case a hard object gets into the rolls as they revolve, such as a hammer-head, the springs give back, permitting its passage, so that the rolls do not stall. In Fig. 45

the roll-shell or tire is pinched between the fixed roll head 7, and the movable one 8, due to a slight taper on the heads corresponding to a like one on the shell. Bolts draw those heads tightly together. For heavy work

such rolls have been built up to 72 in. diameter by 24 in. face. They will nip even to 4-in. pieces, and with a "choke feed," that is, with a thick

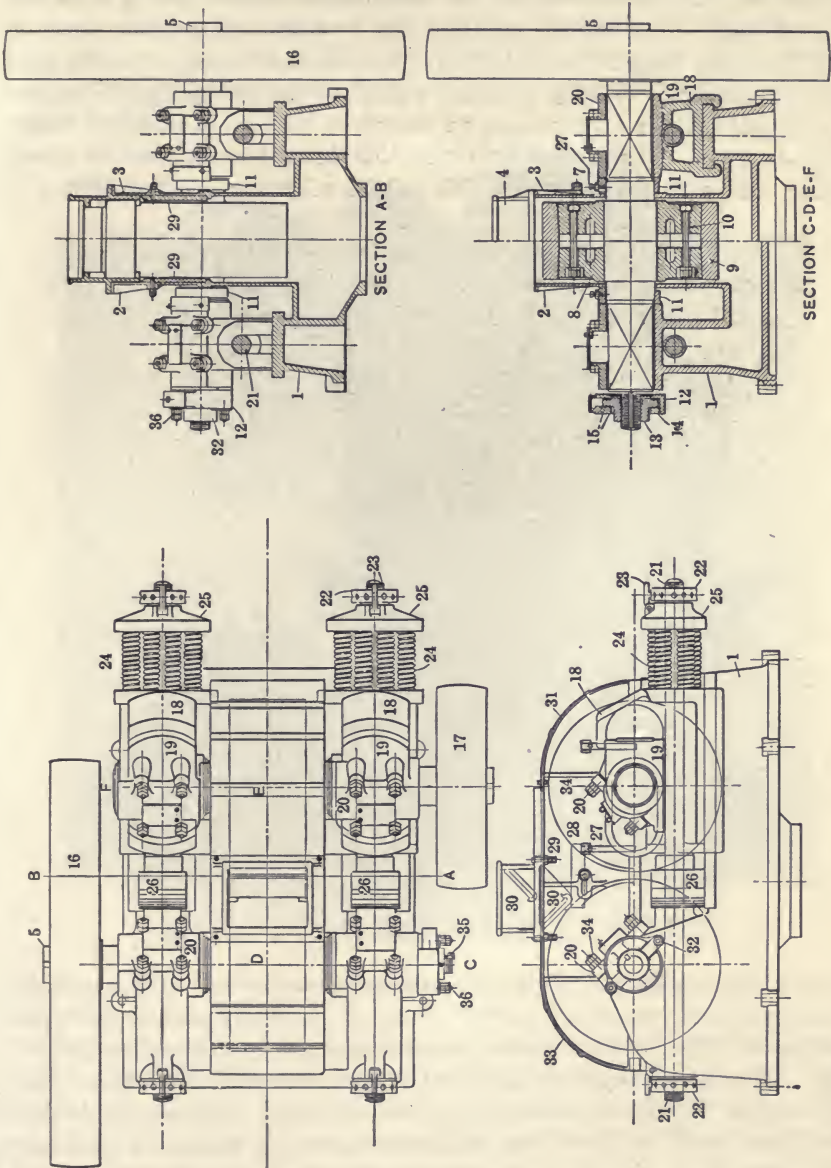

FIG. 45.—Crushing Rolls (Power & Mfg. Mch. Co.).

stream of ore fed on to the rolls while well set up, will run smoothly with a capacity of 2500 tons per day. Due to its grooved shell, the smaller rolls, Fig. 43, will take as large a piece.

Present practice in roll crushing involves a high peripheral speed, not only as increasing capacity, but also to insure smoother running, owing to the fact that the inertia of the rolls carries them safely by a sudden peak-of load. Such speeds are from 300 to 500 ft. peripheral speed or, for 42-in. rolls, from 27 to 45 R.P.M. It is the custom to drive the rigid roll by a large pulley, using a smaller pulley on the spring-roll. The fixed or rigid-roll shaft has a deep groove turned at one end of it, fitted with a thrust-bearing. By means of two bolts this thrust-bearing may be moved axially, and with it the shaft. This results in giving another surface of

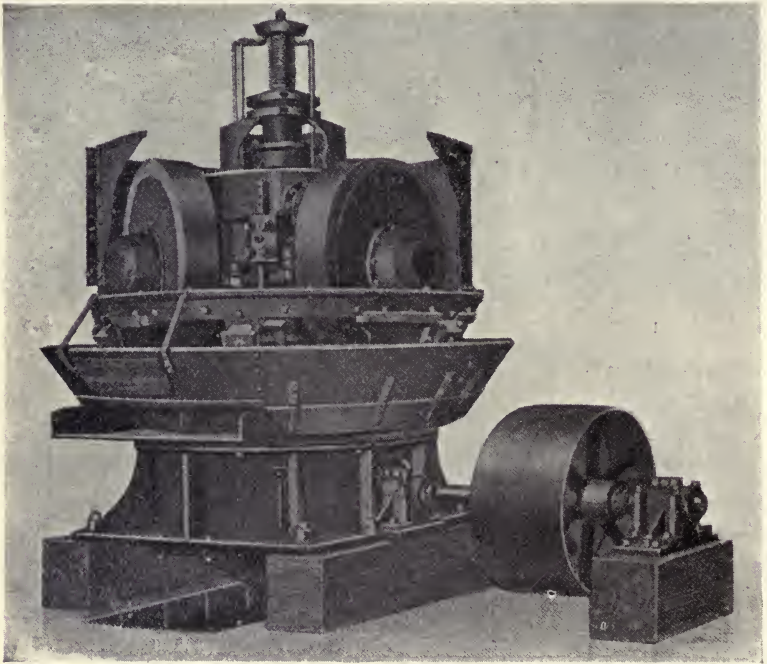

FIG. 46.—Chilian Mill.

contact between the rolls, preventing them from grooving. In some makes of rolls this end movement, called "floating" is slowly and automatically performed. Rolls are also made without springs; they are called "rigid" rolls. They have the advantage that they produce less fines and practically no oversize. They run with little jar or vibration. The size of feed for 42-in. rolls would be  $1\frac{1}{2}$  to 2 in. and the reduction of the size of the feed is preferably four to one, that is 2-in. pieces should be reduced to  $\frac{1}{2}$  in. size.

**The Chilean Mill.**—Fig. 46 is a view of a 5-ft. mill with the shrouding broken away to show two of the three rollers. These have steel tires. They roll upon a die-ring. Ore is fed by launder to a central hopper set

above the roll axles, it flows downward into the pan below and outward so as to be ground between the rollers and the ring. It is splashed outward, and when ground fine enough, escapes through the peripheral screens that form the sides of the pan and into a gutter by which it flows away. A 5-ft. mill, running at 40 R.P.M., will grind 25 to 35 tons of ore in twenty-four hours, requiring 10 H.P. to drive it, and using 400 to 1000 gallons of water per hour.

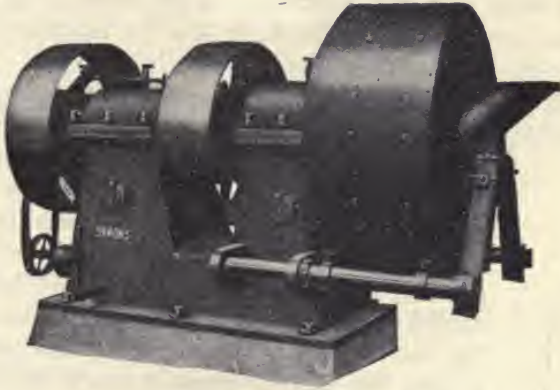

FIG. 47.—Symons Disk-crusher.

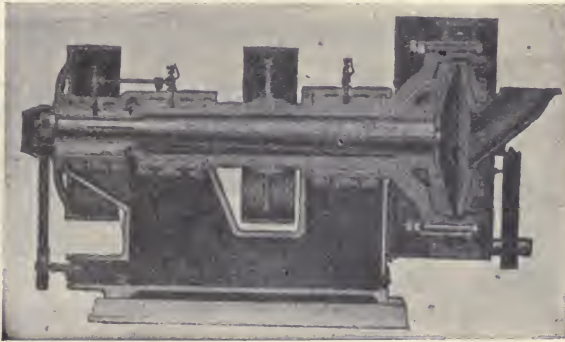

FIG. 48.—Symons Disk-crusher (section).

Besides the fast-running type of Chilian mill above described there is the slower kind, called the Lane, running 12 to 15 R.P.M. and having rollers 7 ft. diameter by 22 in. face, and weighing 7 to 8 tons each. These travel on a die ring 7 ft. diameter and crush through a 30-mesh screen at the rate of 15 tons in twenty-four hours. ✓

**The Symons Vertical Disk Crusher.**—We show in Fig. 47 a perspective view; in Fig. 48 is a longitudinal section of a 48-in. Symons disk grinder. Referring to the section Fig. 48, there are two saucer-

shaped disks carried at the end of a sleeve and with a slit opening revolving at 100 R.P.M. Within the sleeve is a shaft whose tail-end receives a reciprocating motion, due to an eccentric with its pulley, at 250 R.P.M. Where the disks are the widest apart the falling ore from the feed-chute enters and is pinched and shattered as the slit closes, the fines being thrown out into the housing and falling to a discharge-spout beneath. The machine is not suited to grinding sticky ores, which tend to adhere to the disk. Friable ores work well in it. Another defect of this crusher is that "tramp iron" is liable to break, or stall the machine. This is overcome by the use of magnets at the conveyor belt.

**The Degree of Comminution** of the ore is one of the most important factors, particularly in the treatment of silver ores. The purpose of grinding is to free the minerals from the inclosing gangue and to reduce the mineral particles to such a size that they are readily dissolved. Grinding should be carried on in such a manner as to waste as little power as possible in grinding the worthless gangue and still fulfill the above-named conditions to the fullest extent possible, since the less the mineral is protected by the gangue and the greater the surface exposed to the solution, the more rapid the rate of dissolution.

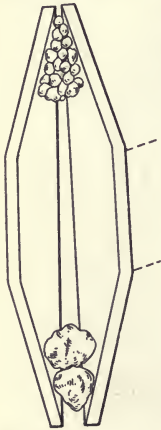

FIG. 49.—Disks of Symons Crusher.

It then follows, for example, in the case of certain silver ores, that while fine grinding may not produce any greater ultimate extraction, yet in general it will materially reduce the time of treatment necessary. But this advantage is not always realized without the disadvantage of greater consumption of cyanide arising, since finer grinding not only causes a greater surface of the minerals containing the precious metals to be exposed

to the solution, but also a greater surface of those minerals, if present, which may act as cyanicides. Careful correlation of the time of treatment with degree of comminution may serve to minimize this difficulty.

Selective grinding whereby the heavy mineral particles are ground finer than the lighter particles of gangue takes place automatically to a greater or less degree in closed circuits where hydraulic or mechanical classifiers are employed so that actually in the majority of plants the heavy mineral particles are ground finer than the gangue. The additional cost of finer grinding, together with the attendant disadvantages which may arise, must in each case be carefully weighed against the additional extraction possible, or the decreased time of treatment necessary to obtain a given extraction.

In grinding a sticky talcose ore, the pebbles may become coated, the noise dies down and grinding ceases. If, however, the feed is cut off for a



few minutes the pebbles free themselves, the noise resumes, and grinding again continues.

**Ball or Tube-mill Drive.**—Fig. 50 is a plan of an excellent drive, because of the use of a flexible coupling. It does away with the trouble

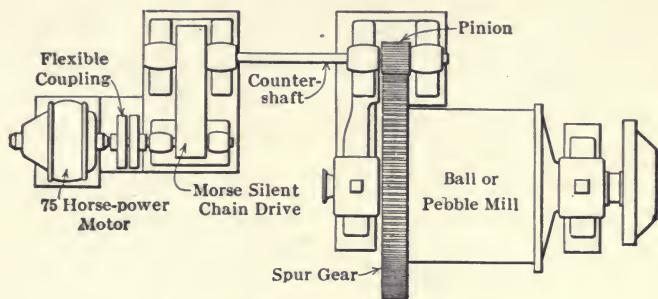

FIG. 50.—Plan of Ball-mill Drive.

due to the strains on the transmission. As arranged it drives a 6-ft. by 4½-ft. ball mill at 24 R.P.M.; a 7 by 12-ft. tube or pebble-mill at 22 R.P.M.

**Tube-mill Linings.**—To withstand the wear of rolls or pebbles on the interior of a ball or tube-mill, special tough steel or iron plates are provided. In Fig. 51, *A* represents the Tonopah lining where longitudinal

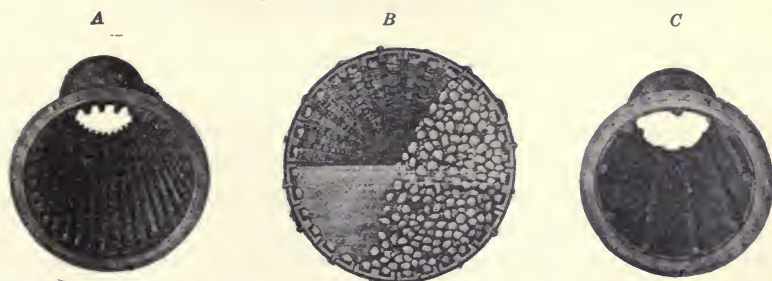

FIG. 51.—Tube-mill Liners.

ribs give spaces to be filled with concrete. *B* is the so-called El Oro liner, shown with its load of pebbles while revolving. The pebbles after a few revolutions wedge themselves into the grooves, affording a resistant surface to the action of the falling pebbles. In *C* we have the Komata liner made with heavy ribs. These, during the revolution of the mill, raise the pebbles quite high before they can fall back.

## FINE GRINDING

**Tube Mills.**—They are the best of the all-sliming machines, and are commonly in use in modern plants, either for combined sand leaching and slime treatment in cyanide practice, or for all-slime treatment. Fig. 52 gives a view of such a mill. They have been largely made 5 ft. diameter by 22 ft. long, but now mills 6 ft. diameter by 14 to 16 ft. long are preferred. The interior is lined throughout by thick steel plates which last from nine to twenty-four months. The method of the feed and discharge is the same as for the ball-mills.

The speed varies from 28 to 34 R.P.M. The cylinder is filled half full of hard flint pebbles. The falling and rolling of the pebbles on each other and upon the lining as the cylinder revolves grinds the material, in part by impact, in part by rubbing abrasion. The pulp, fed to the mill, varies



FIG. 52.—Tube-mill.

in size from  $\frac{1}{4}$  in. diameter to 40-mesh size, and preferably should contain 40 per cent water. In sliming to minus 200-mesh, the machine is worked in closed circuit with a classifier, which allows only the finer pulp to escape, and returns the coarse material to be reground.

**Dry Crushing and Screening.**—Ores are dry-crushed and screened in a closed circuit as a preliminary to roasting. It is done by means of rolls and revolving screens or trommels in series, as shown in the diagram or flow-sheet, Fig. 53.

The ore supply from a dryer such as the White-Howell roaster, Fig. 73, goes to the roughing rolls *a* which reduce it from 0.75 to 0.25 in. The crushed ore is raised by the elevator to a trommel, or separating-screen, having screens of  $\frac{1}{8}$ - and  $\frac{1}{2}$ -in. aperture, respectively. The first two-thirds of the screen takes out all material less than  $\frac{1}{8}$  in., and the final size is all coarser than  $\frac{1}{2}$  in. We thus get three products, an oversize from the coarser screen which goes back to the roughing rolls to be recrushed, a screened product or undersize, which goes to the medium rolls, *b*, set at  $\frac{1}{8}$  in. open, there to be crushed and sent back to the separating screen, and finally

an undersize through  $\frac{1}{8}$ -in. screen, fine enough to go to the finishing rolls. Until crushed so fine that it passes the finest mesh the ore is returned to the trommel. The fine product of the screen is raised by the elevator  $f'$  and the ore stream is equally divided between  $s''$  and  $s'''$ , which are provided with 30-mesh wire cloth. The undersize from these trommels drops into the storage bin  $m$ , while the oversize is conveyed to the finishing rolls, after which it goes by elevator to the finishing screens. Thus, nothing enters the bin except 30-mesh, or finely crushed ore ready for further treatment.

This system of graded crushing is preferable because the final product

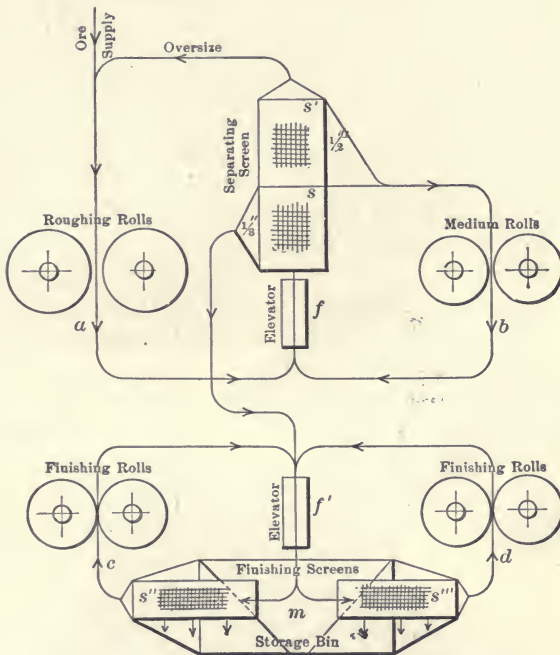

FIG. 53.—Flow-sheet for Dry-crushing or Screening.

contains a minimum of fine or slimed ore and being granular is more easily percolated or leached. As each piece or particle of ore is crushed by a single nip, the fine is separated by the screen and protected from unnecessary breaking with consequent waste of power. The chief costs in this system of dry-crushing are those of labor, power, supplies, and repairs. These vary with the tonnage. The cost of crushing in 1913 to 30-mesh size, in preparation for roasting or leaching is 50 cents per ton, but to this must be added overhead or general expense.

## SCREENING

**Screening.**—A mixture of coarse and fine mineral, shaken through a bar-screen, a plate-screen, or a wire-cloth screen will divide into two products, an oversize or coarse product, which remains upon the screen, and an undersize or minus product which drops through its openings, and which is of the size of the opening down to the finest particles of the ore. The oversize above mentioned may be again crushed and fed upon the screen, and by sufficiently repeating the operation it all eventually will pass through as undersize. Or again, the undersize of a screen may be brought upon a finer one and will then yield an oversize product, which will vary from the minus size of the first screen to the plus oversize of the second. Thus, by using a succession of screens, we obtain a series of products, grades from the coarsest to the finest, and a residual one of all finer than the finest screen.

**Classifying.**—Finely ground ore is called “pulp”—if dry, a “dry pulp,” if wet, a “wet pulp.” It consists of coarse and fine particles called respectively sand and slime. Such materials, when wet and suspended in a liquid, may be separated into sand and slime by means of

hydraulic classifiers, the sand settling and constituting the “underflow” or “spigot” discharge of such an apparatus, while the slime, remaining in suspension, passes away above at the “overflow.” Classifiers may be of large capacity, and are cheaper and more durable than screens.

They may be divided into two kinds, viz., hydraulic classifiers and mechanical classifiers.

**Bar Screen or Grizzly.**—

This is made of bars 6 to 12 ft. long, spaced about  $1\frac{1}{2}$  in. apart, Fig. 54. Set at a steep slope, as in *a*, Fig. 134, it

receives the ore dumped upon it from the mine-car. The finer ore drops through the bars to the bin beneath, the oversize joins it after passing through the crusher.

**The Impact Screen.**—For the dry screening this screen, Fig. 55, is

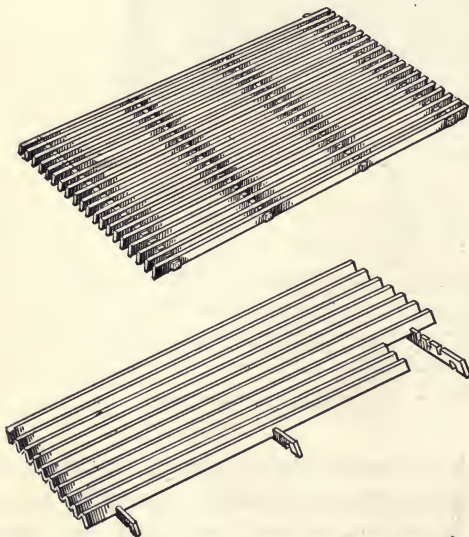

FIG. 54.—Grizzlies.

well suited to fine screening. The screen frame, highly inclined, receives a bouncing or bumping motion, thereby giving large capacity in a small

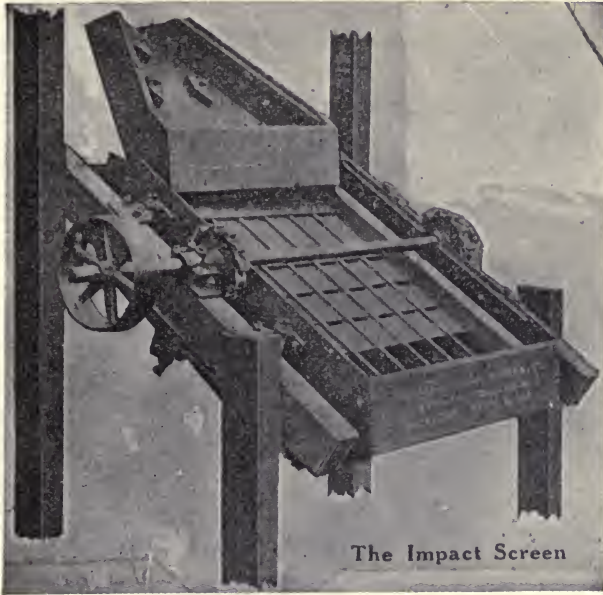

FIG. 55.—The Impact Screen.

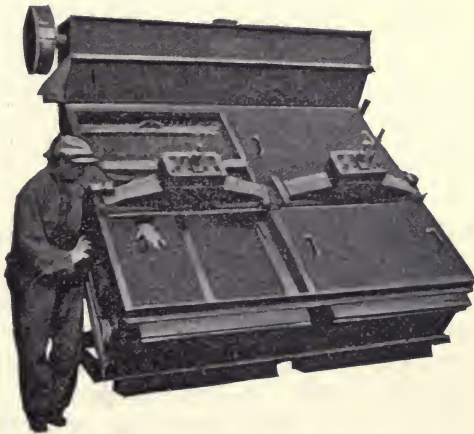

FIG. 56.—The Tension Screen.

space with a minimum wear of cloth. The launder at the head has pointed cleats or guides which distribute the feed evenly over the screen.

**The Revolving Screen or Trommel.**—In Fig. 57 is a trommel, mounted on a shaft inclined commonly  $4^{\circ}$  to  $5^{\circ}$  to the horizontal, and revolving to 20 times per minute. The cylindrical part is covered by a punched plate or by wire cloth. It has at the left a short receiving cone where the ore enters a V-shaped sheet-steel housing or casing receiving the watery undersize, which discharges by the spout *A*. A second spout having a dividing partition to prevent mixing, discharges at *B*. Any portion of the ore may be said to travel through the trommel in a spiral path. The trommel is operated wet (sometimes dry), wash-water being fed on the outside of the up-coming side by a spray pipe. A practical size for a trom-

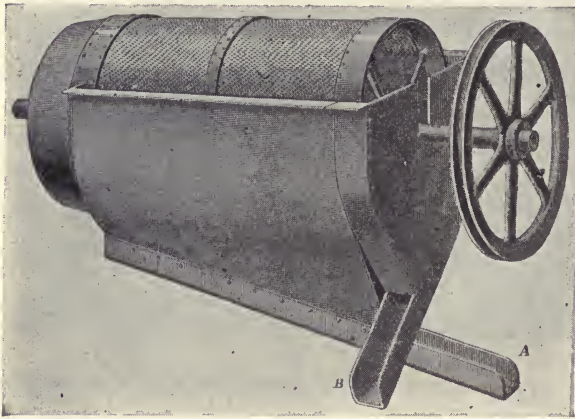

FIG. 57.—Revolving-screen or Trommel.

mel would be 3 ft. diameter by 6 to 8 ft. long with a capacity through  $\frac{1}{2}$ -in holes of 200 tons per day.

### CLASSIFYING

**Classifiers.**—These may be divided into two types, the hydraulic and the mechanical classifiers. In the first we include the Caldecott and the Allen cones; in the second the Dorr and the Akins classifiers. Of the cones, the Caldecott needs much attention, in order at all times to produce a uniform feed to the tube-mills. It returns much fine material and is a continuous source of trouble. The Allen cone, being automatic in its action, is not nearly so open to these objections. The Dorr and Akins classifiers require little attention, and will deliver a feed with 20 to 30 per cent moisture. The chief objection to these machines, when dealing with a heavy sulphide concentrate, is the delivery to the tube-mill of a considerable amount of fine material that does not require finer grinding.

**The Caldecott Diaphragm Cone-classifier.**—This hydraulic classifier, Fig. 58, 6 ft. diameter by 9 ft. high, is popular in South Africa for supplying a feed to tube-mills. Its advantage over the ordinary cone type is that it has a diaphragm which sustains the sands accumulating above it in the tank nearly to the inlet spout as shown in the view of the Allen Cone, Fig. 59, while at the bottom is a cut-off valve, that can be adjusted to regulate the discharge. The pulp feed of the launder passes through a screen to remove clips and floating objects, and falls in the cylindrical inlet spout upon a deflector to gently settle out the sands. The slime overflows over the entire circumference of the cone into the peripheral launder.

**The Allen Cone.**—This classifier, Fig. 59, like the Caldecott, is of the same settling-basin type, not using hydraulic water, the sand settling in the basin while the slime escapes by the extended peripheral launder. The settling solids,

forming a sand-bed, are removed as they accumulate by an automatic float-controlled spigot-valve 29. The feed drops downward through the inlet pipe or spout 1, impinges on its casting, which quiets the flow, and seeks exit through the truncated cone 3. When the sand-bed accumulates to near the mouth of the cone it partly obstructs the outward flow, causing the watery pulp feed to rise in the cone and carry with it the float 5. By means of the lever 13 the link 28 actuates the ball valve 29 and the settled solids, even as large as  $\frac{1}{2}$ -in. pieces, begin to flow out until the level of the solids in the basin drops, and with it the float 5, again permitting free flow. The superiority of this cone over other hydraulic classifiers is in the automatic control of the sand discharge, since, when properly fed and adjusted it needs no attention.

**The Akins Classifier.**—In this machine, Fig. 60, as in the Dorr classifier, which follows, the sand is elevated from an inclined settling tank or trough by mechanical means, in this case by a spiral or screw, which fits closely to the semicircular bottom of the trough, scraping the sands upward to the discharge at the upper end of the trough, while the slime is agitated and overflows a diaphragm at the lower end to the discharge pipe *R*.

**The Dorr Bowl Classifier.**—This is a Dorr classifier to which has been added a bowl or tray, as shown in Fig. 61, which receives the

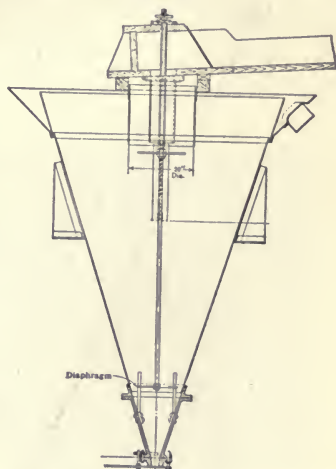

FIG. 58.—The Caldecott Diaphragm-cone.

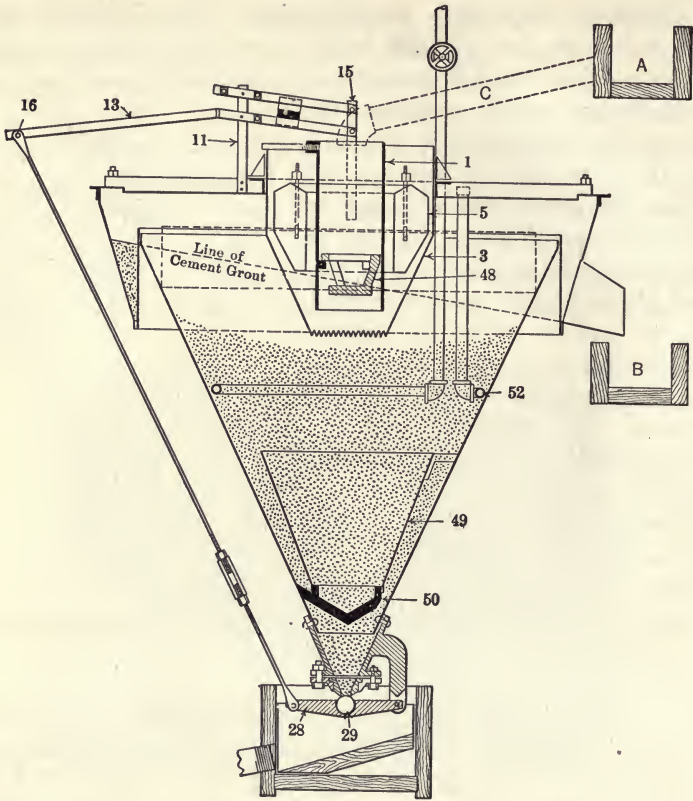

FIG. 59.—The Allen Cone.

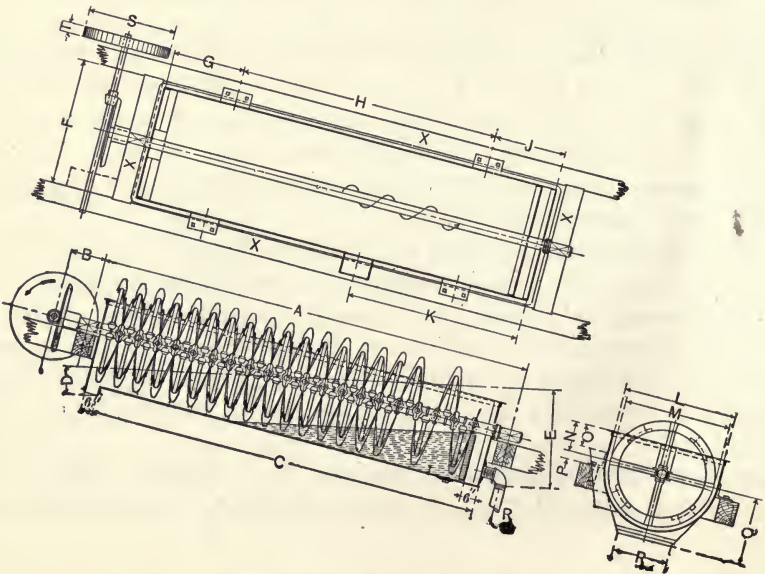

FIG. 60.—The Akins Classifier.)



feed at its center, the slimed pulp overflows the periphery into the overflow launder, while the sand is plowed to the center of the bowl and discharged through a comparatively small opening into the main inclined settling tank. Here it is raked to the upper end of the tank by means of two sets of reciprocating scrapers. The sand settling to the bottom is gradually advanced up it by the forward motion of the scrapers. The mechanism then lifts these scrapers which drop to the bottom, then make

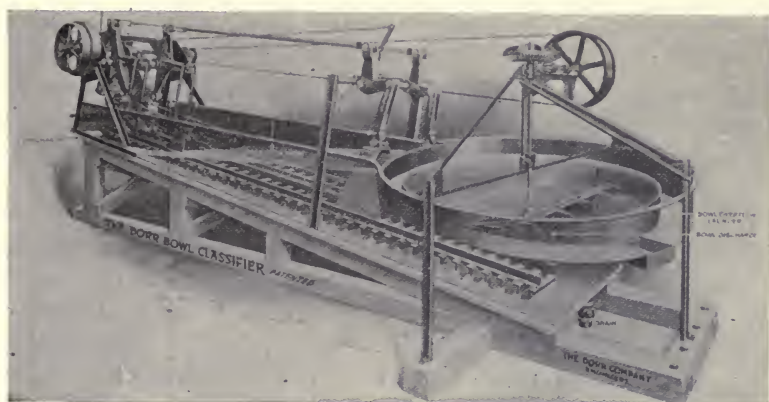

FIG. 61.—The Dorr Bowl-classifier.

the next forward stroke. The coarser material (the sand), emerging from the solution is discharged at the upper end still containing 25 per cent of moisture. Wash water or solution is admitted into the main classifier tank and flows underneath the bowl and up through its central opening, counter-current to the sand. Usually about 1 ton of back-flow wash per ton of sand is sufficient to remove all slime from the sand. The agitation is just enough to prevent settling of the slime which now overflows at the periphery of the bowl.

## CHAPTER VI

### METALLURGICAL FURNACES

**Classification.**—These may be divided into two general types—the *shaft furnace* and the *reverberatory furnace*. The first consists of a vertical shaft or chimney, as in Fig. 62, while in the second the charge is kept separate from the fire.



FIG. 62.—Cupola Blast Furnace.

and the way it is charged with coke and materials of the charge in alternate layers. It is seen that the charge and fuel are in intimate contact with one another so that not only is the charge effectually heated, but is brought within the reducing action of the fuel.

#### THE SHAFT-FURNACE

These are of two kinds, the wind-furnace using natural draft as in Fig. 64 and the blast-furnace Fig. 65.

**The Wind-furnace.**—This is used in the laboratory where it is desired to melt a charge in crucibles. When converted for use as a muffle furnace, the muffle is inserted at the side, and is surrounded by the burning coke, which gives it a temperature high enough for melting and cupelling. As a variation from this, the flame from a soft coal fire, carried below the muffle, will sufficiently heat it. The wind-furnace is used in metallurgical operations for melting down a product in plumbago or clay crucibles of 100 lb. capacity or over, these being embedded in the coke. Indeed crucible steel is still melted in this way.

**The Blast-furnace.**— Fig. 65 shows the elements of a blast-furnace

**The Cupola-furnace.**—Fig. 62 is a cylindrical blast-furnace such as is used in foundries for the melting of pig-iron for castings, and also in small plants for the treatment of copper ores. The cylindrical shaft is water-jacketed of steel plates. At the bottom are seen the two half drop-doors, which, when the furnace is running are swung up in position to close the bottom of the furnace. On them is laid the bottom lining of the firebrick. The crucible *C*, as high as the wind box *E*, is also lined with  $4\frac{1}{2}$  in. of firebrick. The shaft above this point, to as high as the feed floor, is double, with a space of 4 in. between the inner and the outer plates. Since this space is filled with water it is called a "water-jacket." The water here would soon reach the boiling point were it not for its circulation within, the cold water entering both at the top and bottom of the jacket by the supply pipe *e*, and the hot water leaving by the overflow pipe *d*. Thus, while the inner shell is in contact with the highly heated contents of the furnace, it is kept cool and is not melted or attacked by the slag, which indeed coats it. The lower part of the water-jacket is surrounded by the wind box *E*, as shown. There are six tuyere-openings through the water-jackets into the furnace, with openings opposite them in the wind-box as shown, these latter closed by covers having mica-covered peep-openings by which the condition of the tuyeres can be observed. In case of the stoppage of a tuyere, the cover is removed and a punch bar driven in to remove the obstruction. The base-plate rests upon four cast-iron columns, and sustains the entire structure. In the top *T* is the feed-door by which coke and charge are put into the furnace, the feed-floor being at the level of the sill of the feed-door as shown in Fig. 190. This figure also shows how the gases and smoke are carried away by a branching "downtake" to a dust-flue, or when desired let go above the roof of the blast-furnace building.

Other types of blast-furnaces are to be found in Figs. 152 and 155 for iron, in Fig. 195 for copper, and in Figs. 257, 258 and 261 for lead.

#### THE REVERBERATORY FURNACE

This consists essentially of an enclosed fireplace or firebox at the right-hand side of the melting hearth *B*, Fig. 63 or as shown at *a* of Fig. 71. Here the fuel is burned, the products of combustion and the flame being drawn over the hearth to a chimney. The hearth is covered by an arched roof so as to reverberate or throw down the heat upon the charge placed on the hearth or sole of the furnace. This space is sometimes called the "laboratory," that is, the enclosure where the labor or work upon the charge is performed.

In case the furnace is designed for roasting ore, then the hearth is flat and level with the door sills, but when, as in reverberatory smelting, the contents of the furnace are melted, the hearth must be dish-shaped or hollowing and beneath the sill level so that the molten contents are retained.

Fig. 63 gives a general idea of the appearance of a reverberatory roasting and melting furnace, a portion being broken away to show the hearth, side walls, and arched roof. It brings out clearly the way the furnace is "ironed," that is, tied together to resist the thrust of the arch and the expansion of the brick-work, as the furnace is heated. The ironing consists of upright buck-staves of railroad rails, one on each side of each door, tied across at top and bottom (the lower tie-rod beneath the floor level) by  $1\frac{1}{4}$ -in. tie-rods. This is also shown in Fig. 71. Other buck-staves, set at the ends of the furnace and of the melting section or fuse-box *B*, are tied to resist longitudinal expansion. The furnace smoke passes away through an outlet port at the end of the furnace to the flue *F* and thence to the stack common to several furnaces. The fuse-box or hearth at *B* has two counterbalanced lifting side doors, as has also the fire-box, where is also to be seen the ash-pit beneath. The door openings *DD* have

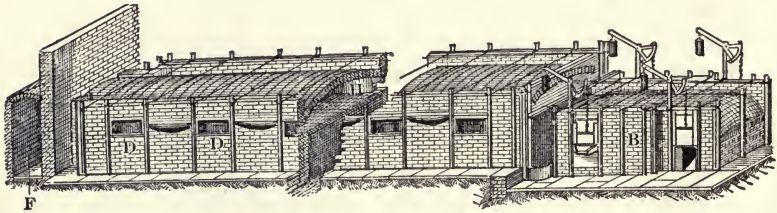

FIG. 63.—Hand-roasting Reverberatory Furnace.

simple sheet-iron covers. Between them is seen a flat plate with an arched back rib to stiffen it. This takes the thrust of the arch between the doors. In Fig. 213 is shown the heavy ironing needed for a large smelting reverberatory furnace, where, due to the high melting heat needed the expansion strains are great. The buck-staves then are 6- and 8-in. I-beams with  $1\frac{1}{2}$ - to 2-in. tie-rods. One must note here that as the furnace heats up the tie-rod nuts are slacked off a little, and in cooling down they are tightened up—all to reduce severe strains. The open-hearth steel furnace, Fig. 176, is similarly tied.

In the furnace, Fig. 63, the main hearth of the furnace is used for roasting. This completed, the charge is pushed down through a broad port into the fuse box *B*, there to be sintered or melted. When melted it is withdrawn by means of rabbles (hoes) at the side doors into wheelbarrows set beneath the door-plate.

The above description refers to a coal-fired furnace. There are three methods of firing as described under head of "Reverberatory matte smelting," i.e., *direct* or coal-fired, *pulverized coal* and *oil firing*. To this we may add *producer-gas firing*, used for open-hearth furnaces in steel-making.

## CHAPTER VII

### COMBUSTION

#### PRINCIPLES OF COMBUSTION

Combustion, as generally understood, may be defined as a vigorous chemical combination, attended with the production of light and heat. To start combustion, the fuel must be (1) **brought to the temperature of ignition**; (2) **it must be maintained at this temperature**; (3) **a sufficient supply of air must be provided**; and (4) **the products of combustion must be removed**.

A jet of gas, burning as it issues from a tube, begins to take fire one or more inches from the tube, and continues to burn as rapidly as the molecules of the gas come in contact with those of the air. In an open-hearth furnace a current of heated gas and one of air mingle gradually, and do not become fully mixed and inflamed until a few feet from the outlet ports. It is the same in a reverberatory furnace especially where there is but little more air than required for perfect combustion. The furnace, even if 100 ft. long, may be filled with flame from end to end, showing that gas at the distant end is still combining with air and burning. If, in the fire-box of such a furnace, we carry a thick coal fire, not less than 18 to 24 in. deep, the air passes through the fire freely. The flame is then shorter, since the hydro-carbon gas is speedily consumed. The long flame is desirable where we wish to extend combustion through the furnace and not to produce so intense a heat near the fire. If fuel-oil be fed into an oil-burner or injector, where it is broken up by a jet of steam or air into a fine spray, and then blown into a red-hot combustion chamber, it will burn like gas with an intense heat. Finely powdered coal projected in the same way, and with a sufficient supply of air (preferably preheated) burns rapidly, resembling gas, and furnishes abundant heat and high temperature.

Thus, to promote rapid combustion, the fuel must be in such form as to afford plenty of contact to the air. A piece of charcoal of large size burns readily, because, being porous, the air readily finds a way to penetrate it; while a lump of anthracite, being dense, burns more slowly. Paper and kindling wood expose a large surface to air, and hence ignite readily and burn rapidly. Paper in books, and fabrics in bales, burn with difficulty. They may pass through fire only singed on the outside. Light lumber and boards burn readily, while heavy beams of wood resist a fire, with super-

ficial charring. A thick layer of sawdust or fine coal, thrown on a fire may extinguish it. Hence, in firing up, such fine materials should be added sparingly, and used with lump coal or pieces of wood, to make passages or cavities, through which the air may pass. Finally, as may be seen, a common error made in fire-building is that while an abundant supply of fuel may be present, insufficient provision is made for the free passage of air through the fuel. A good draft and a sufficiently large exit-flue must be provided to carry away the products of combustion.

Flame is gas undergoing combustion. Soft coal and wood burn with a flame because the heat from burning distills, or drives out, the hydrocarbon gas which is formed. Anthracite, coke, or charcoal burns with little or no flame; while hydrogen burns with a non-luminous, though very hot flame.

The temperature of ignition or of kindling varies according to the volatile constituents of the fuel. Thus bituminous coal, wood, and ordinary charcoal will kindle at toward  $400^{\circ}$  C. Anthracite and coke are hard to start, kindling at  $700^{\circ}$  C., a full cherry heat.

#### COMBUSTION IN THE AIR AND IN THE BLAST-FURNACE

**The Natural-draft Furnace.**—As an illustration of what takes place in a deep fire, let us consider a fire of glowing coke, Fig. 64. Here the air enters through the grate-bars, and, at the first instant, in contact with the glowing fuel, produces carbon dioxide,



with the development of a large amount of heat. Between 2 and 4 in. above the grate (with a clear fire) we may expect to find the highest temperature. This forms the zone 1, Fig. 64, and hence in a crucible furnace the bottom of the crucible should be set 4 in. above the grate to get the full effect of the heat of the fire.

As we go upward, the  $CO_2$  in excess acts on the glowing carbon and dissolves or combines with it as follows:



This reaction is accompanied by the absorption of heat, and thus zone 2, Fig. 64, is cooler than the one below. In the zone 3, no reaction takes place, the fuel being simply heated by the ascending gases. A little air may pass along the walls, and issuing above the surface of the fuel, and mixing with the  $CO$  gas, burn a small portion of it to carbon dioxide with a blue flame thus:



This reaction also is a heat-producing one.

We finally get, with a thick fire, a mixture of gases of a composition much like the following:

N 70 per cent, CO 25 per cent,  $\text{CO}_2$  2.5 per cent, O 0.5 per cent and H 1.0 per cent.

The presence of the hydrogen is due to the decomposition of the moisture in the air. This mixture of gases can be made in a gas-producer (see Fig. 7), and for that reason it is called producer-gas. Because of its content of CO it can be burned according to Equation (3), and used as a fuel for any purpose of heating. To burn the gas completely, and to get

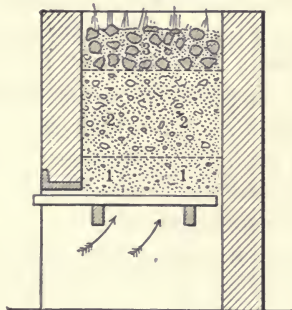

FIG. 64.—Wind Furnace.

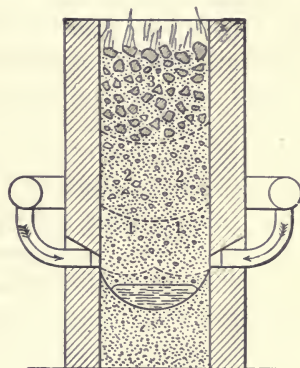

FIG. 65.—Cupola Furnace.

the most heat from it, the thickness of the fire should not be greater than is shown in zone 1, Fig. 64.

**Combustion in the Cupola Furnace.**—Fig. 65 represents a foundry-cupola charged with alternate layers of coke and pieces of pig iron. Here the object is to melt the iron, collecting it in a pool or bath at the bottom in the crucible of the furnace, shown in the illustration. Air is forced into the furnace, and fills all the voids, rising through the charge chiefly in the passages or openings offering the least resistance. In an iron blast-furnace (see Fig. 154) the rate of upward velocity approximates 6 ft. per second. As air meets the burning coke, combustion takes place according to Equation (1), producing a white heat. This action, in a cupola of 36 to 48 in. diameter, extends upward about 3 ft. from the tuyeres, the upper limit of zone 1, Fig. 65. As the gases enter the zone 2, the  $\text{CO}_2$  just formed is decomposed by contact with the hot coke and forms CO, according to reaction (2), the change being nearly complete at the upper limit of zone 2. In the upper zone no change takes place in the gases, and they impart their heat to the cold charge, which is

being supplied as fast as the ore sinks below the required level. In this cupola, where the operation is one only of melting, to attain the greatest economy of fuel, the coke should be dense, the pieces large, and the blast abundant to supply plenty of air. Thus, burning the coke is deferred to the last, less CO is formed, and the combustion, performed largely in zone 1, is more nearly complete, developing the largest possible amount of heat.

From Equation (1) we find, that to burn one pound of carbon to  $\text{CO}_2$ , and thus with the greatest development of heat, there is needed 2.66 lb. oxygen, or 11.6 lb. air, since air contains 23 per cent oxygen by weight. At the sea-level 12.4 cu. ft. air weighs 1 lb. This makes 143.8 cu. ft. or, in round numbers, 150 cu. ft. air per pound of carbon. Ordinary coke contains 85 per cent carbon, thus requiring 122 cu. ft. air per pound of such coke. While in theory 12 lb. air should be sufficient per pound of coal, it has been found that excess is needed for complete combustion. For natural draft, using a thin fire, 18 to 24 lb. air has given the most satisfactory results, and where air is forced into a closed ash-pit, and through the fire-bed (undergrate blast), then 16 lb. air, or even less, is sufficient.

Figuring from Equation (2) in the same way, we find, per pound of carbon 1.33 lb. of oxygen required, or of air 5.79 lb., equal to 71.8 cu. ft. Upon the basis of coke containing 85 per cent combustible matter, 61 cu. ft. air is required per pound of fuel when burned to CO.

**Chimneys or Stacks.**—In a furnace reaction not only is it necessary that the reaction elements be present in mutual contact, but that the products of the reaction be removed as fast as formed. Under conditions other than this the reaction ceases. A draft, therefore, must be provided, to carry away the waste gas, and to expel it into the atmosphere. This draft may be natural or forced. To insure obtaining a sufficient draft in a chimney, the gases must be delivered into the stack while hot. A temperature of  $200^\circ \text{C}$ . is ample for this, but since the work of most furnaces is done at a temperature higher than a red-heat, the excess may be utilized to generate steam by conducting the gases through waste-heat boilers before entering the stack.

In a reverberatory furnace, used for smelting, the quantity and intensity of the heat depend upon the amount of coal burned per hour. This varies between 18 and 40 lb. per square foot of grate area and, to burn it completely, there will be needed 150 cu. ft. air per pound of coal consumed. In these furnaces the gases escape at temperatures between  $300^\circ$  and  $1100^\circ \text{C}$ ., and move with a velocity of 12 to 20 ft. per second. For illustration, take the furnace Fig. 122, with a grate-area of 112 sq. ft., a consumption of 30 lb. of coal per square foot of grate-area per hour, needing 514,000 cu. ft. of free air. Allowing a temperature in this instance of  $1000^\circ \text{C}$ ., and a draft velocity of 20 ft. per second at this high temperature, and knowing that these gases expand  $\frac{1}{273}$  of their volume for each degree



above  $0^{\circ}$  C., we find the volume at  $1000^{\circ}$  C. to be  $\frac{1000+273}{273} = 4.7$  times the volume at  $0^{\circ}$  C. Assuming the temperature of the outside air to be  $0^{\circ}$  C., we shall have as the volume of hot gas per hour 2,368,800 cu. ft. At 20 ft. per second, or 72,000 ft. per hour, this will be an area of stack of  $\frac{2,368,800}{72,000} = 30$  sq. ft. The actual area is 32 sq. ft.

The total pull, or suction, that a chimney can produce, assuming it to be filled with hot gases, is due simply to the ascensive force of the gas measured by the difference between its weight and the weight of an equal volume of the cold air outside. To maintain the velocity of the gas in the stack, it has been found that a suction, or "pull," of 0.4 to 0.8 in. of water, as measured by a water-gauge, is needed. Taking a draft of 0.6 in. in the above instance and adding 0.1 in. for friction in the chimney, we have 0.7 in. water equal to  $\frac{62.5 \times 0.7}{12} = 3.647$  lb. per sq. ft. A cubic foot of air at  $0^{\circ}$  C. weighs 0.0807 lb. (12.4 cu. ft. per lb.). The gas inside the stack has a specific gravity of 1.03 weight of air being unity, thus making the weight when heated  $\frac{0.0807 \times 1.03}{4.7} = 0.0177$  lb. per cu. ft. Hence we have the difference ( $0.0807 - 0.0177 = 0.063$ ) as the ascensive force per foot of height. The stack should therefore be  $\frac{3.647}{0.063} = 58$  ft. or approximately 60 ft. high.

From the above calculation it appears that the draft-pressure varies with the temperature and height of the chimney. The velocity of the gas, or the amount of air passing through the fire per hour at a given temperature, varies as the square root of the height of the stack, in accordance with the equation  $V = \sqrt{2gh}$ ;  $g$  being acceleration due to gravity and  $h$  head in feet. Thus a stack 100 ft. high would increase the velocity only 1.31 times more than our 58-ft. stack calculated above. The volume of gas increases directly with the temperature, while the velocity varies with the square root of this, hence there is a point of maximum discharge, at  $273^{\circ}$  C. At a higher temperature, while the velocity increases, the weight of the gas on the contrary diminishes.

#### TEMPERATURE OF COMBUSTION

By this is meant the temperature of gases resulting from combustion under ordinary atmospheric pressure. We can calculate this when we know the calorific power of the fuel, and the total weight and mean specific heat of the resultant gases. The specific heat between  $0^{\circ}$  C. and the temperature of combustion increases as is shown in the diagram, Fig. 68.

**Flame Temperature.**—As an example of the use of the following table let us find the maximum temperature of combustion obtained in burning one pound of coke of 85 per cent carbon, using the theoretical amount of air or 9.86 lb. (since pure carbon requires 11.6 lb.), neglecting the loss of heat in the adjoining walls of the furnace. Since by weight there is 77

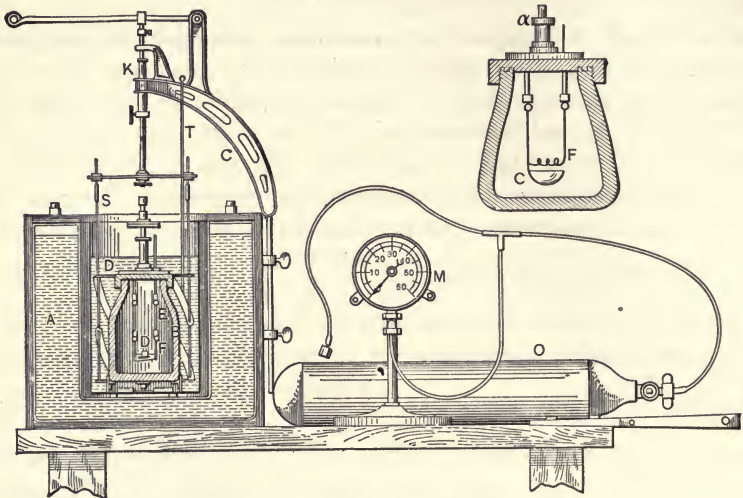

FIG. 67.—Mahler Bomb Calorimeter.

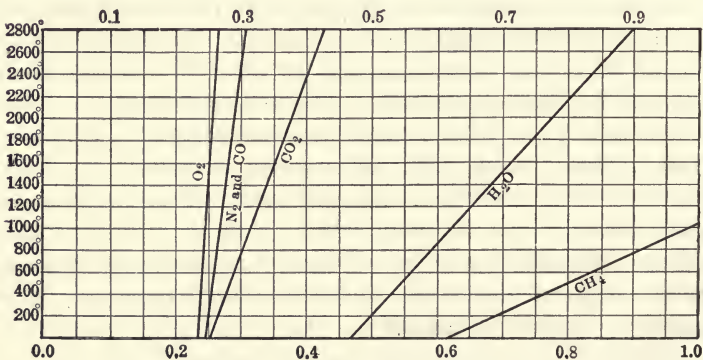

FIG. 68.—Specific Heat of Gases.

per cent nitrogen in air, there will be, in the mixed gas resulting from combustion, 7.6 lb. nitrogen, and 3.11 lb. CO<sub>2</sub> (0.85 lb. carbon, and  $\frac{3}{2} \times 0.85 = 2.26$  lb. oxygen). We assume a temperature of 2000° C., which is as near the desired one as we can judge. From Fig. 68 we find for 2000° the specific heat to be, for N<sub>2</sub>, 0.281 and for CO<sub>2</sub>, 0.364. We then have:

7.6 lb. nitrogen.....	@ 0.281=2.133
3.11 lb. carbon dioxide.....	@ 0.364=1.132
	3.265

The number of calories necessary to raise the entire gaseous product from 1 lb. of coke one degree will then be 3.265. The heat developed by the burning of the coke, being 6800 cal., the temperature of combustion is  $\frac{6800}{3.265} = 2080^\circ \text{C}$ . The specific heat of the gases at this temperature being so nearly the same as at  $2000^\circ \text{C}$ ., we can use it in this calculation. Were the difference great, we should have to use the specific heat at the exact temperature and calculate again upon that basis.

To proceed further, let us find the temperature of combustion, or flame-temperature of carbon monoxide burning to carbon dioxide:

$$\text{CO} + \text{O} = \text{CO}_2 = 68,000 \text{ cal.}$$

$$28 + 16 = 44$$

One pound of CO will produce 2440 cal., and will take 0.572 lb. oxygen or  $\frac{0.572}{0.23} = 2.48$  lb. air containing 1.91 lb. nitrogen. There is also 1.57 lb. CO<sub>2</sub> produced. Taking the specific heats from the table, Fig. 4.

1.91 lb. nitrogen.....	@ 0.287 = 0.548 cal.
1.57 lb. carbon dioxide.....	@ 0.364 = 0.572 "
	1.120 "

for each degree of rise in temperature. Hence  $\frac{2440}{1.12} = 2200^\circ \text{C}$ . = the temperature of combustion. Again, calculating with the increased specific heat of the newly found temperature ( $2200^\circ$ ), we find 2112 to be the exact number of calories, nearly identical with that already found.

**Fuel Combustion.**—In writing equations the molecular weight is understood as in ordinary chemical equations.

$$(1) \quad \text{C} + \text{O}_2 = 97,000$$

may also be written

$$(2) \quad \text{C}, \text{O}_2 = 97,000$$

with a comma to indicate that the different molecules, so separated, unite to form CO<sub>2</sub>.

If oxygen burns in presence of an excess of highly heated carbon, then carbon monoxide is formed, and this may be written

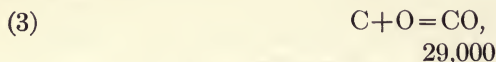

which indicates that by the combination of the solid carbon with the gaseous oxygen 29,000 calories have been formed. Likewise this may be written

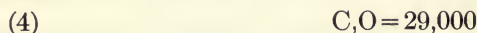

Since the 12-lb. carbon gives 29,000 calories, we have, as the heat evolved by the burning of 1 lb. of carbon, 2440 calories. If we burn the CO thus formed with a sufficient amount of air, we have

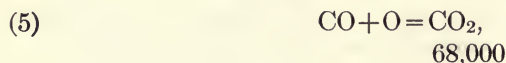

or, as also written,  $CO,O=68,000$  calories. Were this written  $C,O_2$  then we would have 97,000 calories (Equation (2)).

Equation (5) may again be written



This means that before this reaction can take place, the CO must be broken up according to the reaction,

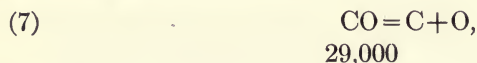

or again

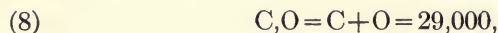

the minus sign meaning that in this reaction as much heat has been absorbed in the breaking up as was earlier evolved in Equation (3), in which these elements united.

In Equation (6) the CO having been decomposed into C and O, they are forced to unite with the O to form  $CO_2$ , evolving 97,000 calories. The net result or the algebraic sum of the two reactions is thus 68,000 calories as given in Equation (6).

**Tempera ures of Combustion.**—The temperature of an incandescent body may be judged by the eye or by an optical pyrometer according to the color scale herewith:

Lowest visible red.....	470° C.
Dull red.....	550 to 625°
Cherry red.....	700°
Light cherry red.....	850°

Orange.....	900° C.
Yellow.....	950 to 1000°
Light yellow.....	1050°
White.....	1150°
Dazzling white.....	1500 to 1600°

These colors apply both to flame and to a heated body.



FIG. 69.—Wall Type Indicating Pyrometer.

**Indicating Pyrometer.**—Fig. 69 is a Le Chatelier pyrometer composed of a thermo-couple of a platinum and a platinum rhodium wire placed at the end of a protective tube of porcelain which is thrust into the fire or against the heated object. The two wires are continued as leads to the terminals of a galvanometer graduated to indicate the temperature.

## CHAPTER VIII

### METALLURGICAL THERMO-CHEMISTRY

#### METHODS OF DETERMINING THERMIC-VALUES

**Definition of Metallurgical Thermo-Chemistry.**—This pertains to questions relating to the heat evolved or absorbed when elementary substances or their compounds combine in metallurgical operations. By having an intimate knowledge of these reactions we can utilize fuel and control roasting, smelting, or converting operations to the best advantage.

Thus when cupelling rich lead in an English cupelling furnace, Fig. 181A, the air passing over the hot molten bath is seen to aid in maintaining its molten condition, energetically uniting with the lead to form litharge, and so evolving heat.

When wood or other fuel is kindled, the properly supplied and regulated draft of air maintains the combustion of the fuel with evolution of much heat.

A mixture of quartz-bearing ore, with fluxes in suitable proportion, the whole brought to a white heat, will melt together; the heat being intensified in so doing.

On the other hand, when steam is passed through a glowing coke fire, it is decomposed, forming hydrogen and carbon monoxide, but absorbing heat and cooling the fire.

**Units of Measurement.**—The amount of heat generated as the result of the combination of elementary substances is given in Table I. In Table II is given the amount of heat evolved as the result of the combination of certain bases (oxides of the metals), as given in Table I with silica.

The unit of measurement used is the heat required to raise a unit weight of water one degree. Thus, one gram of water raised in temperature one degree Centigrade is called a small calorie (cal.) or gram-calorie. One kilogram of water raised  $1^{\circ}$  C. is called a large calorie (Cal.) or kilogram-calorie. One pound of water raised  $1^{\circ}$  Fahrenheit is called a British thermal unit (B.t.u.) and it is but 0.252 of the kilogram-calorie. The gram-calorie is used in small-scale laboratory operations. For ordinary work the large calorie is preferred.

In this book and in the calculations which follow we shall use the pound-calorie, this being the heat required to raise 1 lb. of water  $1^{\circ}$  C. When we use the word "calorie" the pound calorie will be understood. The kilogram-calorie is 2.2 times greater than the pound-calorie.

**General Principles.**—1. The amount of heat needed to decompose a

compound into its constituents is equal to that evolved when that compound is formed from those constituents. When a reaction takes place by which heat is absorbed, as in Equation (8), it is called "endothermic." On the other hand, when heat is evolved in a reaction, as in Equations (1), (3), and (5), it is said to be "exothermic."

2. The heat evolved in a chemical process is the same, whether it takes place directly or in several steps. Thus in Equation (3) the carbon is burned to CO with the evolution of 29,000 calories. The CO thus formed, when burned with additional oxygen, as in Equation (5), gives 68,000 calories, and the sum of these two is 97,000 cal., the same as if the carbon had been burned to CO<sub>2</sub> as per Equation (1)

In comparing reactions (1) and (3), it may be said that in presence of an excess of oxygen, reaction (1) would take place rather than reaction (3). This is in accordance with the law of Berthelot, namely:

3. Every reaction which takes place independently of the addition of energy from without the system, tends to form the combination which is accompanied by the greatest evolution of heat.

**Calorimetry.**—To determine accurately the heats of combustion of fuels, or the heat of formation of compounds, the Mahler bomb-calorimeter, Fig. 67, is much used. It consists of a steel shell or bomb, marked *B*, shown also on an enlarged scale at the right-hand upper corner of the illustration. The bomb, holding about a pint and weighing 9 lb., is shown to be closed by a screw-cap, having a stop-cock threaded connection *x* by which it may be connected by a flexible pipe to a cylinder *O*, which contains compressed oxygen gas. Within the bomb is suspended a capsule *c* in which is placed a gram of the substance to be tested. The cap is then tightly screwed on, and oxygen gas under a pressure of 300 lb. per square inch is allowed to enter. The shell is next placed in the calorimeter *D*, which contains a known weight of water. The thermometer *T* is set in place, and the stirrer or agitator *S* is set in motion to bring the whole apparatus to the same temperature. The calorimeter *D* is placed within a larger vessel *A* covered with a thick layer of felt and provided with a thermometer (not shown). The vessel *A* serves also to support the bracket *G* from which the stirrer is suspended. The temperature of the calorimeter having been noted, the charge is ignited by a coil of the platinum wire *F*. The resultant rise in temperature is noted by the thermometer *T*. The total heat developed, with certain corrections, is calculated from the weight of the calorimeter water, and from the rise in temperature. In those cases where the heats of formation of oxides or of silicates are desired, the net result is accomplished by respectively oxidizing or melting them in the bomb with a known weight of a well-determined fuel. The number of calories evolved is the algebraic sum of those of the desired reaction and that of the fuel.

## HEATS OF FORMATION OF THE ELEMENTS

Following are the molecular weights and the heats of formation of some of the better-known chemical compounds. From these may be estimated the heat developed in various reactions:

TABLE I  
HEAT OF FORMATION OF CHEMICAL ELEMENTS

*Carbon, Hydrogen and Sulphur*

Formula.	Molecular Weights.	Heat of Formation (Calories).	Formula.	Molecular Weights.	Heat of Formation (Calories).
C,O	12 + 16 = 28	29,000	S <sub>2</sub> O <sub>2</sub>	32 + 32 = 64	69,260
C,O <sub>2</sub>	12 + 32 = 44	97,000	S,O <sub>3</sub>	32 + 48 = 80	91,900
H <sub>2</sub> ,O	2 + 16 = 18	58,060			

*Silicon and Phosphorus*

Si,O <sub>2</sub>	28 + 32 = 60	196,000	P <sub>2</sub> O <sub>5</sub>	68 + 80 = 142	365,300
-------------------	--------------	---------	-------------------------------	---------------	---------

*Oxides of the Metals*

MgO	24 + 16 = 40	143,000	Fe <sub>2</sub> O <sub>3</sub>	112 + 48 = 160	195,600
Ba <sub>2</sub> O	137 + 16 = 153	133,400	Fe <sub>3</sub> O <sub>4</sub>	168 + 64 = 232	270,800
Ca <sub>2</sub> O	40 + 16 = 56	131,500	Sb <sub>2</sub> O <sub>3</sub>	240 + 48 = 288	166,900
Al <sub>2</sub> O <sub>3</sub>	54 + 48 = 102	392,600	Sb <sub>2</sub> O <sub>5</sub>	240 + 80 = 320	231,200
Na <sub>2</sub> O	46 + 16 = 62	100,900	As <sub>2</sub> O <sub>3</sub>	150 + 48 = 198	156,400
K <sub>2</sub> O	78 + 16 = 94	98,200	As <sub>2</sub> O <sub>5</sub>	150 + 80 = 230	219,400
Mn <sub>2</sub> O	55 + 16 = 71	90,900	Cu,O	64 + 16 = 80	37,700
Mn <sub>2</sub> O <sub>2</sub>	55 + 32 = 87	125,300	Cu <sub>2</sub> O	128 + 16 = 144	43,800
Zn <sub>2</sub> O	65 + 16 = 81	84,800	Pb,O	207 + 16 = 223	50,800
Fe <sub>2</sub> O	56 + 16 = 72	65,700	Pb <sub>2</sub> O <sub>2</sub>	207 + 32 = 239	63,400

*Sulphides of the Metals*

Ba <sub>2</sub> S	137 + 32 = 169	102,900	Cu <sub>2</sub> S	128 + 32 = 160	20,300
Ca <sub>2</sub> S	40 + 32 = 72	94,300	Cu,S	64 + 32 = 96	10,100
Zn <sub>2</sub> S	65 + 32 = 97	43,000	Pb <sub>2</sub> S	207 + 32 = 239	20,200
Fe <sub>2</sub> S	56 + 32 = 88	24,000	Sb <sub>2</sub> S <sub>3</sub>	240 + 96 = 336	34,400

*Carbonates of the Metals*

Ba <sub>2</sub> C,O <sub>3</sub>	137 + 12 + 48 = 197	286,300	Mg <sub>2</sub> C,O <sub>3</sub>	24 + 12 + 48 = 84	269,900
Ca <sub>2</sub> C,O <sub>3</sub>	40 + 12 + 48 = 100	273,800			

*Sulphates of the Metals in Dilute Solution*

K <sub>2</sub> S <sub>2</sub> O <sub>4</sub>	78 + 32 + 64 = 174	337,700	Zn <sub>2</sub> S <sub>2</sub> O <sub>4</sub>	65 + 32 + 64 = 161	248,000
Na <sub>2</sub> S <sub>2</sub> O <sub>4</sub>	46 + 32 + 64 = 142	328,500	Fe <sub>2</sub> S <sub>2</sub> O <sub>4</sub>	56 + 32 + 64 = 152	234,900
Ca <sub>2</sub> S <sub>2</sub> O <sub>4</sub>	40 + 32 + 64 = 136	321,800	Fe <sub>2</sub> S <sub>3</sub> O <sub>2</sub>	122 + 96 + 192 = 400	650,500
Mg <sub>2</sub> S <sub>2</sub> O <sub>4</sub>	24 + 32 + 64 = 120	321,100	H <sub>2</sub> S <sub>2</sub> O <sub>4</sub>	2 + 32 + 64 = 98	210,200
Al <sub>2</sub> S <sub>3</sub> O <sub>2</sub>	56 + 56 + 192 = 342	879,700	Cu <sub>2</sub> S <sub>2</sub> O <sub>4</sub>	64 + 32 + 64 = 160	197,500
Mn <sub>2</sub> S <sub>2</sub> O <sub>4</sub>	55 + 32 + 64 = 151	263,200			

*Amalgams of Gold and Silver*

XHg <sub>2</sub> Au	Hg in excess 197	2,580	XHg <sub>2</sub> Ag	Hg in excess 108	2,470
---------------------	------------------	-------	---------------------	------------------	-------



TABLE II  
Heats of Formation of the Silicates

Formula.	Molecular Weight.	Formation Heat.	Heat per lb. of Slag.
FeO, SiO <sub>2</sub>	72 + 60 = 132	10,600	80
2FeO, SiO <sub>2</sub>	144 + 60 = 204	22,236	109
MnO, SiO <sub>2</sub>	71 + 60 = 131	5,400	41
BaO, SiO <sub>2</sub>	153 + 60 = 213	14,700	69
CaO, SiO <sub>2</sub>	56 + 60 = 116	17,850	159
2CaO, SiO <sub>2</sub>	112 + 60 = 172	28,300	165
3CaO, SiO <sub>2</sub>	168 + 60 = 228	28,250	125
SrO <sub>2</sub> , SiO <sub>2</sub>	120 + 60 = 180	17,900	110
Al <sub>2</sub> O <sub>3</sub> , 2SiO <sub>2</sub>	102 + 120 = 222	14,900	67
3CaO, Al <sub>2</sub> O <sub>3</sub> , 2SiO <sub>2</sub>	168 + 102 + 120 = 390	33,500	86
2H <sub>2</sub> O, Al <sub>2</sub> O <sub>3</sub> , 2SiO <sub>2</sub>	34 + 102 + 120 = 256	43,800	170
Li <sub>2</sub> O, SiO <sub>2</sub>	30 + 60 = 90	65,100	720
Na <sub>2</sub> O, SiO <sub>2</sub>	62 + 60 = 122	45,200	370
CaO, Al <sub>2</sub> O <sub>3</sub>	56 + 102 = 158	450	3
2CuO, Al <sub>2</sub> O <sub>3</sub>	112 + 102 = 214	3,300	15
3CaO, Al <sub>2</sub> O <sub>3</sub>	68 + 102 = 170	2,950	11
SiO <sub>2</sub> 35.5 + FeO 39.7 + MnO 1.0 + CaO 11.4 + MgO 2.7 + Al <sub>2</sub> O <sub>3</sub> 9.2 + CuO 0.4 + S 0.4% (a compound slag).....	.....	.....	133
FeO 57.6; CaO 12.0; SiO <sub>2</sub> 30.4% .....	.....	.....	140
FeO 40.3; CaO 28.0; SiO <sub>2</sub> 31.7% .....	.....	.....	193

The heat of formation of silicates, if we were to start from the elements, as in Table I, commonly amounts to from 2000 to 4000 calories per pound of the compound thus formed; but, when the metals and silicon have become oxidized, as commonly occurring, most of the heat of formation has developed. If then such oxides and silica are brought to melting temperature they combine with a farther development of heat, as given in Table II, which varies from almost nothing up to 720 calories per pound of the silicate formed, or an average of 145 calories. Thus, in Table I, the heat of formation of FeO is given at 65,700 calories and of silica at 180,000, or together 245,700 calories, being 1100 per pound. But when the slag FeO, SiO<sub>2</sub> is formed only 10,600 calories is developed, equal to 80 calories per pound of the slag.

#### HEAT EVOLVED AS THE RESULT OF ROASTING

In the reaction  $C + O_2 = CO_2$  (see Table I, Carbon, Hydrogen, and Sulphur) one equivalent, or 12 lb. of carbon is completely burned by combining with 32 lb. of oxygen, forming 44 lb. of carbon-dioxide and evolving 97,000 calories. Dividing this by 12 we have 8080 calories as the result of the burning of 1 lb. of carbon.

## CHAPTER IX

### ROASTING

By roasting we mean the preliminary treatment of ores by fire at temperatures below their melting point in order to improve their condition for subsequent reduction or extraction. Because of the expense the operation is avoided where possible.

We may classify these operations into: (1) Calcination or kiln roasting; (2) oxidizing roasting; (3) chloridizing roasting; (4) sulphatizing roasting; (5) sinter roasting.

**Calcination or Kiln-roasting.**—Carbonate ores, as of iron or zinc, are charged in lump form together with some coal or wood into a vertical kiln. The heat expels the contained moisture and carbon dioxide of the ore. In the case of some Mesabi iron ore, containing 12 to 15 per cent of moisture, freight is saved by kiln drying and the ore is made more porous and accessible to the action of reducing gases in the subsequent smelting. The grade of the ore is raised and a better price is obtained for it; if a siderite or iron carbonate, the weight is still further reduced.

**Oxidizing Roasting.**—This is for the purpose of expelling the moisture, of burning off the sulphur, and in the case of certain refractory ores, of removing their contained arsenic or tellurium. Thus, these are freed from impurities which would interfere in subsequent smelting or leaching. The ore is heated to burning temperature with free access of air, and gives a porous product, easily penetrated by reducing gases or by solutions. As a treatment for leaching, roasting destroys colloids, so that the roasted ore is more easily leached. The product of an oxidizing roast is often called calcines, though this is better applied to the product of calcination.

**Chloridizing Roasting.**—It is performed in a reverberatory furnace, common salt being added at a certain stage of the roasting to change the ore to an easily leached chloride. Advantage is taken here of the principle of mass-action, whereby the nascent chlorine reacts on the oxidized metaliferous products.

**Sulphatizing Roasting.**—This is a partial oxidizing roast, some of the sulphur being expelled, and the remainder changed to  $\text{SO}_3$ . Thus a sulphate of the metal is formed, which is soluble and therefore can be extracted by water-leaching.

**Sinter Roasting.**—Sulphide ore spread out on a traveling grate is heated

by a flame to burning temperature. Air is then drawn through it by aid of a suction fan, resulting in a vigorous oxidation, expulsion of the sulphur, and a partial sintering together of the ore particles. Not only is the ore well roasted, but the dust loss in the subsequent blast-furnace smelting is greatly lessened. Iron ore in too fine condition for blast-furnace smelting has been mixed with 6 to 10 per cent of its weight of fine coal to sinter or agglomerate it. In the past much fine ore has not been so treated, but has been fed in the crude state so that the blast-furnace has made a high flue-dust loss.

### CHEMISTRY OF ROASTING

**Chemistry of Oxidizing Roasting.**—To do good roasting, we should have (1) heat sufficient to start the burning; (2) a final heat sufficient to drive off the last portion of the sulphur; (3) preferably 46 lbs. of air per pound of sulphur, (4) an extensive surface exposed to the air; (5) frequent stirring in order to present to the air fresh surfaces for roasting.

Let us take the case of an ore with a silicious gangue, containing the sulphides, pyrite, chalcopyrite, blende, and galena. This is dropped upon the hearth at the hopper end of the furnace, Fig. 63, and then spread out. Here the temperature, 350° C. is sufficient to expel moisture and start the reaction of combustion. In ten to fifteen minutes burning begins, as evinced by a blue flickering sulphur flame that plays over the surface of the charge. The pyrite is thus decomposed.



The first, loosely held equivalent of sulphur is easily expelled and unites with the air, with the evolution of 3220 pound-calories per pound of sulphur burned. The FeS now remaining, together with the other sulphides, begins to oxidize. The FeS and CuS is most easily oxidized, while the ZnS and PbS are the slowest in parting with their sulphur. Beginning then with the FeS we have

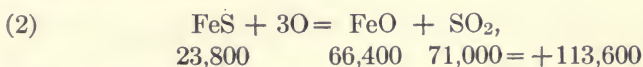

or in words, the iron sulphide becomes oxidized to ferrous oxide with the formation of SO<sub>2</sub>, the reaction being exothermic, and yielding 113,600 ÷ 32 = 3550 pound calories per pound of sulphur burned. Cupric sulphide of the chalcopyrite reacts according to the formula:

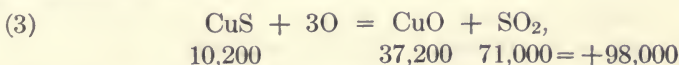

or per pound of sulphur, 98,000 ÷ 32 = 3030 Cal. The blende under the action of air and heat is affected in the same way.

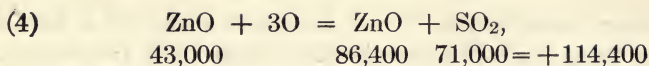

or per pound of sulphur present, 3420 Cal. Galena roasts according to the reaction:

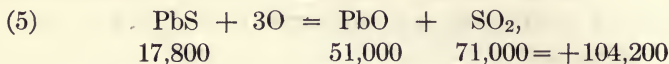

which gives off 3250 Cal. per pound of sulphur.

It will be noticed that the heat evolved per pound of sulphur is much the same in each case, and hence the sulphide highest in sulphur yields the most heat. These reactions, especially of blende and galena, are gradual during the roasting period. The air acts chiefly on the exposed surfaces and hence roasting is hastened by stirring the charge. That FeS which is near the surface has an excess of air, and in presence of silica which acts by catalysis, it becomes oxidized thus:

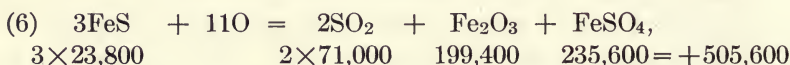

or per pound of sulphur, 5260 Cal., indicating an energetic exothermic reaction. Of the products of the reaction the sulphur dioxide is carried away by the draft. When the two are stirred together, the Fe<sub>2</sub>O<sub>3</sub> is acted on by FeS as follows:

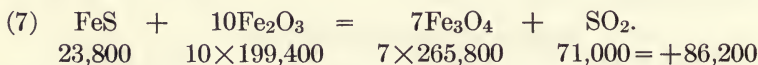

Fe<sub>3</sub>O<sub>4</sub> is of a black color; when the ore is roasted to excess the resultant product is the red Fe<sub>2</sub>O<sub>3</sub>, often an undesirable, red-colored product.

As the charge is moved toward the firebox, the iron sulphate produced as in (6) begins to decompose at a temperature of 590° C. and in presence of cupric oxide reacts as follows:

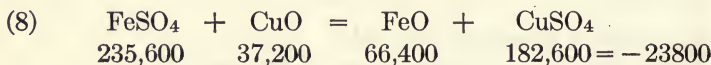

That is, the SO<sub>3</sub> given off by FeSO<sub>4</sub> while in nascent condition is taken by the CuO to form its sulphate, the reaction being an endothermic one. Such of the FeSO<sub>4</sub> as is not decomposed by the cupric oxide is broken up by the heat alone as follows:

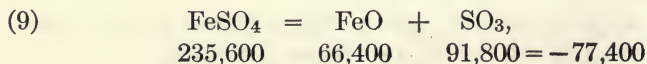

also an endothermic reaction.

At a slightly greater heat (655° C.) the cupric sulphate, formed but a

short time previously, begins to decompose and at a dull red heat the decomposition of cupro-cupric sulphate begins. These reactions are complete at a cherry red heat (850° C.) up to this temperature. These are the reactions of a sulphating roast.

At 850° C. the zinc and lead oxides, reacting on the copper sulphate now decomposing, begin to be changed to sulphates thus:

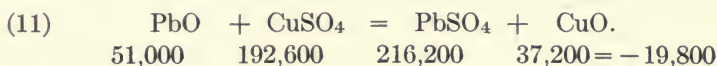
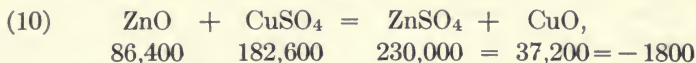

These last four reactions are endothermic and instead of aiding the roasting absorb heat as the result of the reactions. Fortunately they take place in the hotter part of the furnace.

As the charge is moved nearer the fire the above just-formed sulphates decompose, the zinc sulphate more readily than the lead sulphate, and SO<sub>3</sub> escaping.

At 1050° C. (an orange heat) copper oxide is decomposed into cuprous oxide, and ferric oxide, losing some oxygen becomes Fe<sub>3</sub>O<sub>4</sub>.

At this stage the ore begins to fuse if it contains lead, but with little lead it slightly agglomerates, with much it fuses. The charge, now no longer porous, ceases to roast, in fact it is hard to roast such an ore well. On the other hand a zinc ore, free from lead, can and should be brought to a high finishing heat to decompose zinc sulphate and to eliminate sulphur.

To decompose completely a lead-bearing zinciferous ore for further treatment in a blast-furnace, the following procedure is successful. After roasting to the point of fusion, the ore is removed to a reverberatory melting furnace. Here silicious ore is added and the whole melted at a high heat. The silica reacts on the lead and zinc sulphates thus:



That is, the sulphur is eliminated as a sulphuric anhydride, leaving a sulphur-free silicate of both metals. In the blast-furnace the zinc silicate enters the slag as such, while in the presence of fuel, the lead is reduced and recovered.

At 590° C. the iron sulphates, formed at a lower temperature, begin to decompose.

At 655° C. copper sulphates, formed at a lower heat, begin to decompose.

At 705° C. already-formed cupro-cupric sulphate (CuSO<sub>4</sub>) begins to decompose.

At 850° C. copper sulphates are entirely decomposed, and when steam is present the maximum amount of soluble sulphate ( $\text{AgSO}_4$ ) is formed.

At 1050° C. copper oxide ( $\text{CuO}$ ) is decomposed to  $\text{Cu}_2\text{O}$ .

At 1100° C. ferric oxide ( $\text{Fe}_2\text{O}_3$ ) is decomposed to the next lower oxide  $\text{Fe}_3\text{O}_4$ .

In oxidizing roasting it has been found that with 2 per cent  $\text{SO}_2$  by volume, or 4.4 per cent by weight in the escaping gases, roasting is active. This corresponds to 46 lb. (570 cu. ft. at sea level) per pound of sulphur driven off. Calculating this for a 16-ft. MacDougall roaster treating 40 tons of ore in twenty-four hours, and roasting it from 35 per cent S down to 7 per cent sulphur, we have an elimination of approximately 0.25 lb. sulphur per second. This needs 142 cu. ft. of free air, equal to 284 cu. ft. of the temperature of 273° C., that of maximum chimney discharge. For a velocity of 20 ft. per second in the stack as a maximum this would require an area of 14.2 sq., ft. or a diameter in a round stack of 4 ft. 3 in. With an excess of air above that just specified, the hearth tends to cool off; with less, roasting proceeds more slowly, so that at 4.4 per cent  $\text{SO}_2$  in the escaping gases, the roasting goes actively, at 8 per cent very slowly and at 9 per cent it ceases altogether.

The larger the charge and the greater its thickness, the longer is the time needed to complete the roast. A few grams are roasted in a half-hour in the muffle, and in twenty hours in a reverberatory furnace, while it takes weeks to roast ore in the pile.

We may note the temperatures of the reactions that occur in the reverberatory furnace as follows:

At 150° C. the odor, due to the volatilization of some of the loosely held or first equivalent of sulphur, can be detected.

At 350° C. the sulphur of the sulphides (particularly of pyrite) begins to burn with a blue flame.

#### ROASTING ORES IN LUMP FORM—HEAP ROASTING

**Heap Roasting** has the advantage that it can be used at the first installation of a small smelting plant in a new district, where it is aimed to avoid investment in an expensive roasting plant. It requires only the necessary site, the method is a simple one, and the results are satisfactory. On the other hand in a large plant, where from 10,000 to 50,000 tons of ore or matte are in process of treatment, heap-roasting may cause the locking-up of several hundred thousands of dollars in the heaps.

**The Chemistry of Heap Roasting.**—The heat generated in the burning pile volatilizes sulphur from chalcopyrite, and where there is insufficient air some of it escapes from the top of the pile as elemental sulphur. The remainder, uniting itself according to the equation:  $\text{S} + \text{O}_2 = \text{SO}_2$ , leaves

as sulphur dioxide. In contact with heated ore it is further changed to sulphur trioxide,  $\text{SO}_2 + \text{O} = \text{SO}_3$ .

Air has access to the exterior of the lumps, and the reaction on the iron-copper sulphides is as follows:



**Site of Heap.**—For the heaps the leaching sites should be nearly flat, but with drainage to one border, layered or coated with clayey slimes and sprinkled with fuel-oil for tightness. The yard for a large site should have three service railroad tracks, two for the green or unroasted ore, run along outside the piles 170 ft. apart, the roast-ore tract midway between these. This leaves room for two rows of roast heaps each 60 ft. wide, 100 ft. long and 8 ft. high, to hold 2500 tons.

**Heap Building.**—In building a pile or heap the foundation is laid, usually of deadwood, to a depth of 12 to 18 in., the surface of the wood being roughly leveled. At intervals of 10 ft. are left flues which are filled with small wood, to be ignited in order that the fire may penetrate rapidly to the interior of the heap and produce a more uniform combustion. Coarse ore, amounting to about two-thirds of the whole, is then piled on the wood, followed by a layer of medium-sized ore, and lastly by fines which cover the top and sloping sides of the heap. A supply of fines is kept close by, so that, wherever the pile is burning too fast in any given spot, it can be more deeply covered, and where it seems dead, the layer can be opened up to encourage the fire to that spot.

After lighting, the wood burns out in about sixty hours, leaving the ore in vigorous combustion. The pile will burn for three or four months with occasional regulation of the draft as above described.

During the roasting, the outer portions of the piles become reddish in color, due to the oxidation of the iron, and a little sulphur condenses on the surface, but is later driven off. The raw ore may be specified as averaging 23 per cent sulphur, and this is reduced to 10 or 12 per cent. Fig. 31 shows a cross-section of a lump of well-roasted ore containing copper.

The copper sulphide is not so easily decomposed, due to the greater affinity of copper for sulphur as compared with iron. It fuses and accumulates as a layer beneath the oxidized crust.

As this crust gets thicker so also does the layer, until finally we find the lump made up of iron oxide with a center of copper sulphides of a bronze color, and, given time, even this sulphide becomes oxidized. This final condition is shown in Fig. 70.

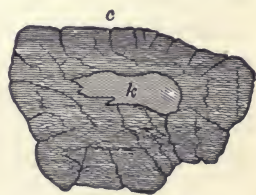

FIG. 70.—Roasted Lump Ore.

A certain amount of sintering or fusion always takes place and parts of

the heaps have to be blasted loose. When the roasting is completed the ore is dug out by steam shovel, loaded upon cars standing on the center track and taken to the blast-furnaces.

Since there is no protection from the weather during roasting, and since soluble sulphates of copper are formed during the operation, a portion of the valuable metal is leached out by rain and snow-water. This loss is estimated at  $1\frac{1}{2}$  to 2 per cent.

The cost of roasting at Ducktown, Tenn., at the first of the century is said to be 42 cents per ton, but at a low wage. Peters gives a cost for fuel, labor, and supplies 48.5 cents per ton with common labor computed at \$1.50 per day. Heap roasting may be done by contract to advantage. At the United Verde, Jerome, Ariz., 75 cents per ton was the contract price. The Canadian Copper Co., in 1916, roasted its ore on a large scale for 50 cents per ton.

**Heap Roasting of Matte.**—Matte can be well roasted in lump form, but unlike ore, it requires two or more burnings. After the first firing, in spite of care, matte shows but little the change it has undergone. At the second burning, using a larger quantity of wood, the result of the first burning begins to show. A large portion of the twice-burned material is found to be light in weight and porous, and to contain no unburned core. In fact the thoroughness of the roast may be judged by feeling of the lumps with the hand. If well-roasted lumps are broken, they no longer show the raw core at the center.

The bed of wood can be prepared for matte as for ore, but the pile is smaller, being only 12 ft. square by 6 ft. deep, with a single chimney at the center. The broken matte, with the raw fines spread over it, is covered with the finer portion of roasted material. The burning of the heap lasts eleven days, and when ended, it is taken down, and the imperfectly roasted part made into a new pile, and the roasted matte sent to the furnace. It is a good plan in constructing the new pile to introduce one or two layers of chips or bark, for a reducing effect upon impurities like arsenic, and for producing a more uniform heat throughout the pile. Finally, after this burning, a large portion suitable for use can be sorted out and the part still incompletely burned can go to the next heap.

#### ROASTING OF ORES IN PULVERIZED CONDITION

This work is done in single or multiple-hearth furnaces. The ore is spread out upon the hearth or floor in about a 4-in. layer, exposed to the action of flame and air.

If not already fine enough, it is crushed so fine that the particles at the end of the time given for roasting show no unburned core or center. An ore, mainly iron pyrite, decrepitates in roasting, hence is fine enough



if of two- or three-mesh size. Many ores and matte need crushing to four- or six-mesh size. An ore of blende or galena is compact and when to be roasted (especially when "dead roasted" so that no sulphur is left) had better be ground to 10-mesh size. Where the ore is finely ground for subsequent leaching this may be done before roasting. It is a good plan, however, to grind to a coarse size for roasting, and to regrind the roasted product as fine as desired for after treatment.

In the various furnaces advantage is taken of the heat developed by the burning of the sulphides, especially in the compact multiple-hearth roasters. If the percentage of sulphur is high, this is often enough to supply the required heat (after combustion has once been started) without the aid of extraneous fuel. Thus in the MacDougall roaster, after the furnace and ore has been sufficiently heated, a content of 25 to 30 per cent sulphur ensures the continuance of roasting.

The various mechanical roasters treat ore cheaply, but for ores containing much lead, which agglomerate or sinter, they do not work well. With a slight accession of heat above the normal, caused by lack of care in firing, the ore is liable to agglomerate, and eventually to stick to the hearth, stopping the movement of the rabblers. When this becomes serious a stout flat bar of iron, attached to one of the rabble arms in place of a rabble blade, may plow up these accretions, and by setting it in different positions on the arm the hearth may be finally cleared. The device has not proved entirely successful. In the hand reverberatory roaster the hearth is accessible, and when the accumulation builds upon the hearth it may be removed by aid of cutter-bars and a hammer. If, however, it is sufficient to rough-roast such an ore, reducing the sulphur content, no more than from 10 to 13 per cent, then such agglomeration need not be feared. Hand roasters work well upon ores that need a high finishing heat suited to breaking up or decomposition of the sulphates, as in the roasting of zinc ores or of galena. The objection to such roasting is that it is costly.

#### THE LONG-HEARTH REVERBERATORY ROASTER

In this furnace the charge is put in and removed at intervals. These furnaces may be distinguished from the reverberatory furnace used for melting by the relatively small grate area and by the fact that the hearth is flat and at the level of the door sills. The hearth may be 10 ft. wide by 36 ft. long, divided as shown on the plan, Fig. 71, into three hearths with a drop of 2 in. between. (Large furnaces are built 70 ft. long with five hearths 14 ft. wide.) The length of a hearth for a reverberatory roaster should accord with the percentage of sulphur that the ore contains, and in consequence the heat developed by it in roasting. Without the aid of the heat developed as the result of the burning of

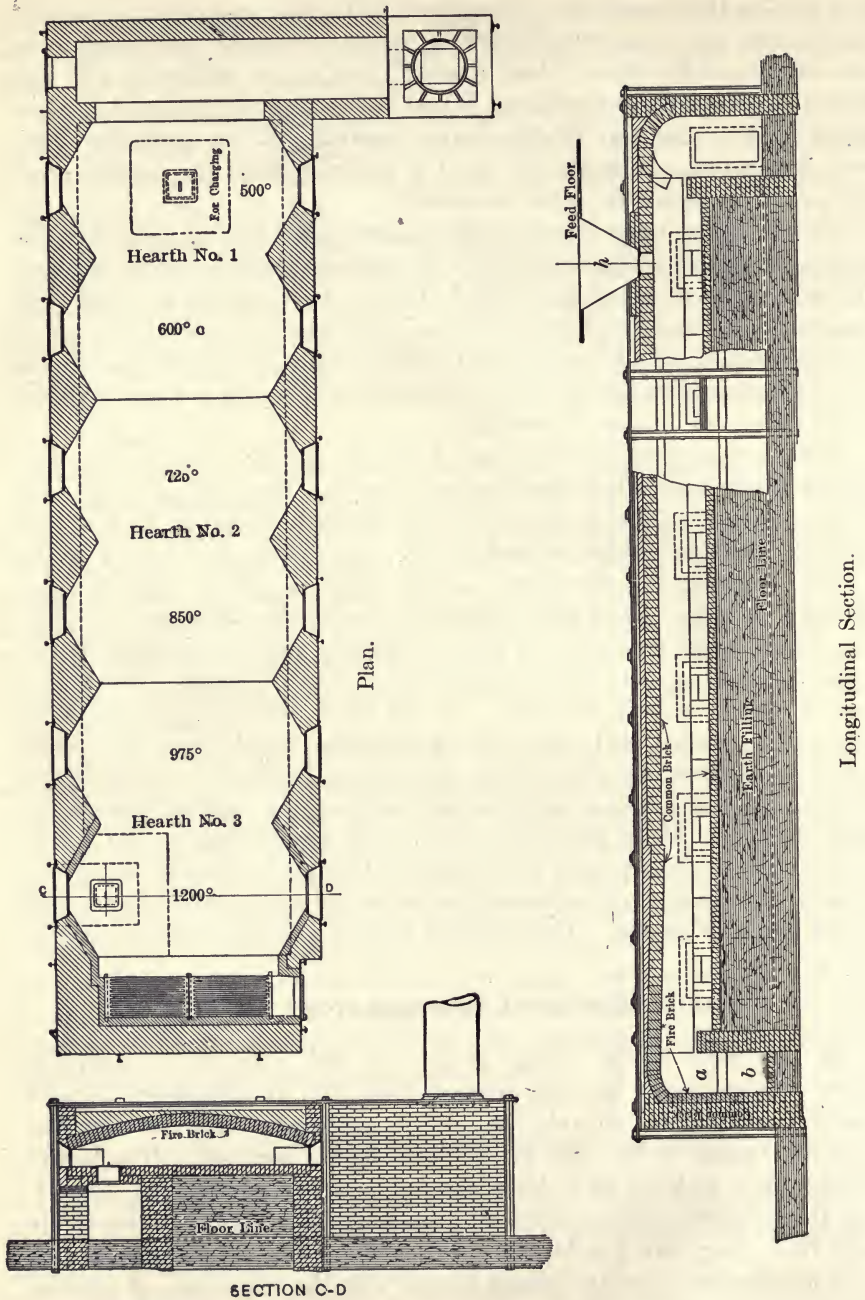

FIG. 71.—Reverberatory Roasting-furnace (sections).

the sulphur, the fire would not maintain sufficient heat to roast ore 25 ft. from the fire-bridge. An ore containing 10 per cent sulphur can be roasted to good advantage in a furnace having a single hearth of 15 ft.; when 15 per cent sulphur is present we may add another hearth, bringing the length to, say, 30 ft.; a 20 per cent ore would work rapidly in a three-hearth furnace; an ore of 29 to 33 per cent would do well on a four- or five-hearth furnace.

To furnish draft for a stack or chimney (see the plan Fig. 71), 28 in. diameter inside by 65 ft. high will be sufficient.

**Operation.**—Into the thoroughly hot furnace (the slide of the charge-hopper being withdrawn) a charge of 2000 lb. pours in a conical heap on the first hearth and is there spread by a man on each side using a paddle. (This has an iron pipe-handle 12 ft. long with a blade 6 in. wide by 18 in. long.) Here the ore remains for four hours being stirred every half-hour with a rabble, a hoe having a blade of 6 by 10 in.

By means of the paddles it is then moved down and spread out on the second hearth, while the first hearth receives a fresh charge from the hopper.

Again at the end of four hours both charges are moved toward the fire, and another charge dropped on hearth No. 1. Thus all the hearths become covered with ore. At the expiration of the four-hour period the first charge now on the last hearth is withdrawn through a square discharge hole seen near the fire-bridge in the figure. It drops into a wheelbarrow set beneath. This ore has thus been under the action of the fire for twelve hours, and for the charge specified we compute an output of 6 tons daily of raw ore or as much as 5 tons of roasted ore or calcine.

#### MECHANICALLY OPERATED ROASTING FURNACES

These may be classified as follows:

(a) **The revolving cylinder furnace** with the axis horizontal or inclined toward the discharge end. An example of such a furnace is the Brückner cylinder roaster, having a horizontal axis, the cylinder 7 ft. diameter by 25 ft. or more long. The ore is roasted in batches or charges. It is charged and discharged through manholes. A charge of 40 tons may take three days to roast. The Oxland, the White-Howell, and the Argall are examples of cylinder furnaces with the axis inclined, causing the ore gradually to travel from the feed end to the lower or discharge end, as the furnace revolves. The Oxland and the White-Howell are single-cylinder furnaces. In the Argall four are united in one.

(b) **The mechanically rabbled reverberatory furnaces** having a continuous feed and discharge. Of these the Brown-O'Harra, the Ropp, the Edwards, the Merton, the Wethey, and the Hegeler have straight hori-

zontal hearths and so are called straight-line furnaces. The first four have single-hearths, the fifth has two superimposed hearths and the Hegeler is a multiple-hearth furnace.

Another variation of horizontal hearth furnace has the hearth curved

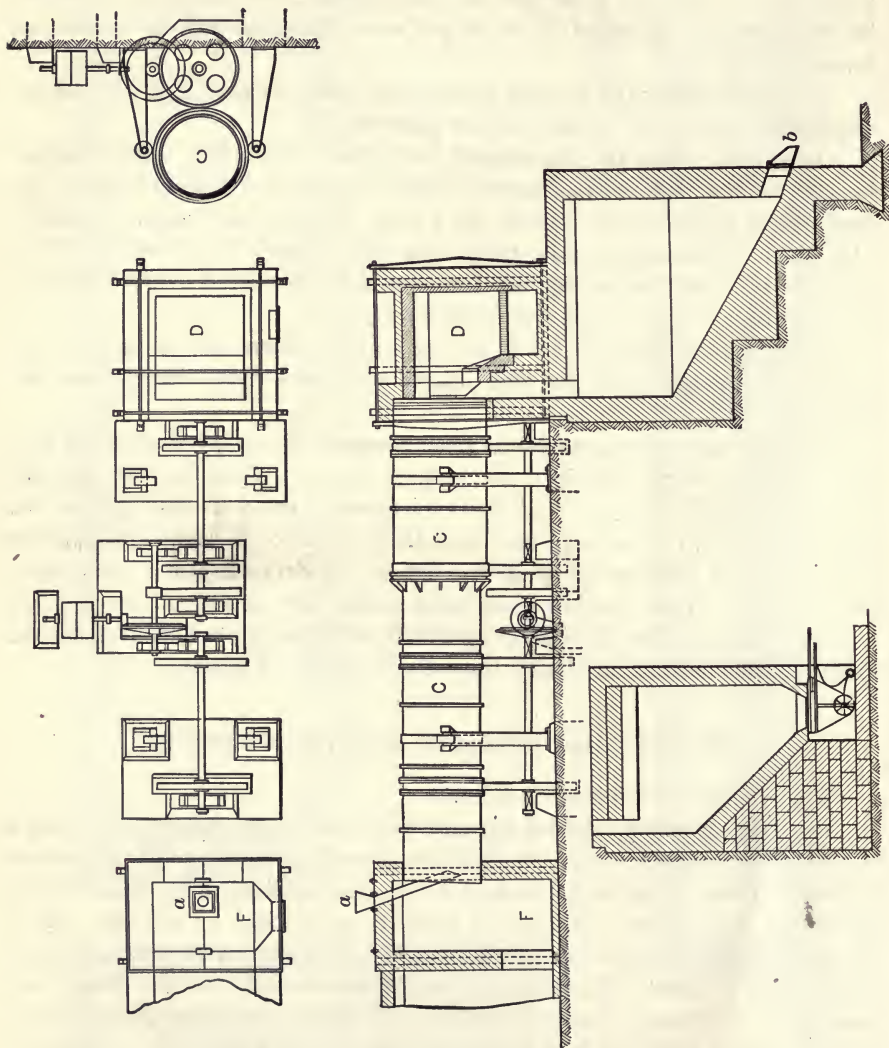

Fig. 72.—Cylinder Roaster (or Dryer):

as in the Brown horseshoe furnace, or circular, as in the Pierce turret furnace. The ore in either case having made the circuit of the hearth is discharged. The rakes or rabblers are but part of the time in the furnace in order that they may have time to cool. The Brown horseshoe has but a single hearth while the Pierce turret may be single or double.

A type of furnace once used in the chloridizing roasting of silver ores was the Stetefeldt where the ground ore was showered down a shaft.

**The White-Howell Cylinder or Furnace.**—Fig. 72 is a longitudinal elevation of this furnace. It consists of a cylinder, 50 in. inside diameter by 34 in. long, set at an inclination of  $2\frac{1}{2}$  per cent supported on friction-rollers carried on the driving shaft. At one end is the firebox, at the other a dust-chamber which connects by a flue to the stack. The hotter end of the cylinder, near the firebox, is of larger diameter, to permit of its being lined with brick, thus leaving the cylinder of uniform interior diameter throughout. Projecting, longitudinal, firebrick ledges, set spirally, raise the ore and shower it back through the flame as the cylinder revolves, so as to roast it more rapidly. The unlined part for the same reason is furnished with longitudinal, cast-iron, projecting shelves. Ore is fed at the flue-end, by means of a screw-feed (see Fig. 267), and when dropped into

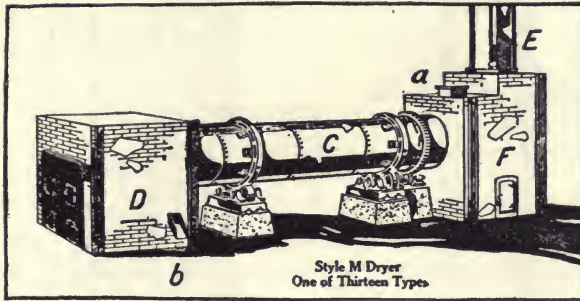

FIG. 73.—Cylinder Dryer.

the revolving cylinder, travels along, discharging at the firebox end. Just before it reaches the firebox it passes out from the cylinder to a brick chamber below, and is withdrawn from that when cool. The furnace makes much flue-dust. It is used chiefly for chloridizing roasting, upon ores containing but little sulphur, and has a capacity of 50 tons per twenty-four hours for low-sulphur ores.

For an ore-drier a furnace quite like this is employed, as shown in Fig. 73.

**The Edwards Roasting Furnace.**—This is a single-hearth reverberatory furnace with hearth dimensions 57 ft. long by 6 ft. wide. Fig. 74, in plan, shows a portion at the firebox end, the feeding mechanism and the cooling floor in section. The elevation shows the side, constructed like a plate-iron beam, the stirring mechanism and the conveyor for transferring the roasted ore to the cooling-pit. Fig. 75 is a transverse section of the hearth showing the details of the stirring mechanism. The slope of the furnace can be changed a little by tilting. This regulates the rate of travel of the

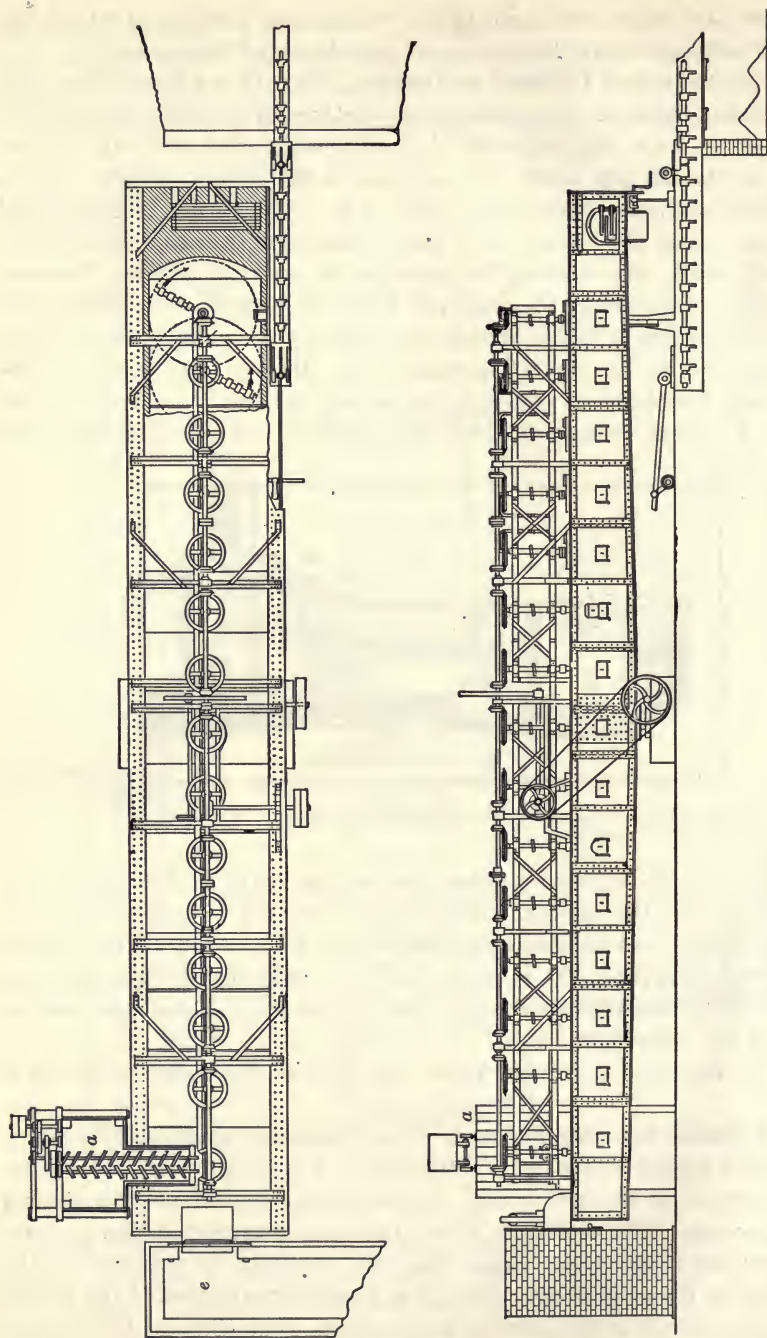

Fig. 74.—Edwards Roasting Furnace (Plan and Elevation).

ore through the furnace; but for a given kind of ore, this slope, once determined, is not again changed. The furnace has a slope of  $\frac{1}{2}$  in. per foot toward the discharge or firebox end. The stirring and propulsion of the charge are effected by means of rabblers fixed to vertical shafts, as shown in the elevation of Fig. 75, and in the plan of Fig. 74. These rabble-shafts make one revolution in sixty to ninety seconds. The rabblers at the firebox end are water-cooled, and this is found especially necessary where a high finishing heat is needed. The blades or plows of the rabblers can be easily replaced through the doors adjacent to them. The figure indicates the hearth as broken away, at the discharge end, to show two of the rabblers in plan. The last rabble sweeps the roasted ore into the discharge shoot, and the push-conveyor then moves the ore to the cooling-pit. The bottom of the conveyor trough is furnished with slides, by

means of which the ore can be dropped at any desired point on the cooling-floor. The ore is fed to the furnace from the feed-hopper, by an endless-screw conveyor which discharges into a feed-opening in the roof of the furnace. The smoke is carried off by a flue. The furnace takes 1 H.P. to operate, and has a daily capacity of 25 tons on sulphide ore of 30 to 35 per cent sulphur. The roasted ore contains 3 to 8 per cent of sulphur. The moving parts are durable, and the furnace has proved efficient in practice. Large installations, of the duplex type with a double instead of a single row of rabblers, and of hearth-dimensions 120 by 12 ft., have been built for a daily capacity of 60 tons. These furnaces do not have the tilting hearth.

Besides these we find circular revolving-hearth roasters, as the Brunton and the Spirlet. The Brunton furnace is used in the roasting of arsenic-bearing flue-dust. The Spirlet is used in blende roasting; the hearth revolves and the rakes or blades are fixed in the roof above.

**The Multiple-hearth Furnace Type.**—A group of mechanical roasters of the circular, multiple-hearth type are to-day most used. These are the MacDougall, the Wedge, and the Herreshoff. Of them we will fully describe the MacDougall and the Wedge roasters.

**The MacDougall Roasting Furnace.**—There are several kinds of furnaces of this type. Among these are the Herreshoff and the Wedge. The MacDougall furnace as manufactured by the Allis-Chalmers Co. is shown

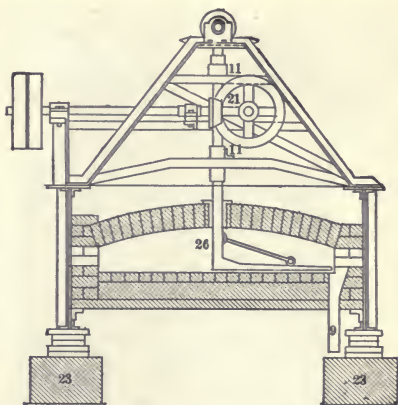

FIG. 75.—Edwards Roasting Furnace (Transverse Section).

in sectional elevation in Fig. 77. It is a vertical, cylindrical furnace, 18 ft. diameter, with six arched hearths, over which travel rabblers which stir and move the ore gradually toward the drop-openings through the floor of each hearth, situated alternately at the center and at the periphery. A central shaft is provided, carrying six radial rabble-arms (three of these are hidden by the shaft in the illustration), provided with rabble-blades set at an angle on the arm.

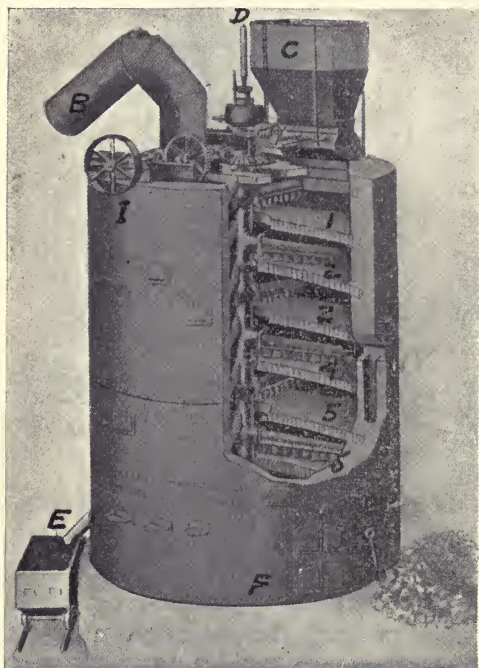

Fig. 76.—Six-hearth MacDougall Roasting Furnace.

The rabble-blades on the even-numbered hearths are so set as to push the ore in a spiral path toward the periphery; the odd-numbered ones toward the center. The ore, fed continuously into the furnace from a cylindrical hopper shown above and at the right, Fig. 76, drops upon the upper hearth near its outer edge. The rabble-blades of that hearth stir and move the ore gradually toward the central drop-opening where it falls to hearth No. 2. The rabblers of this hearth again stir and move it to the outer drop-openings, through which it falls to hearth No. 3. The ore advances by this means

until it reaches the lower hearth, where an opening at the periphery gives it exit to a receiving-hopper, shown beneath the hearth, from which it is drawn into a car as required.

A high-sulphide ore roasts by its own heat when the furnace is in full operation. The ore fills the hearth to the level of the blades, and is spread out evenly by them. On the upper hearth, as the ore moves toward the central opening, it becomes dry and hot, and when dropped upon hearth No. 2, begins roasting. On hearth No. 3, the ore roasts freely, emitting sparks and forming sulphates. On hearth No. 4 no sparks are seen, and the ore has attained its highest temperature. On hearth No. 5 the ore looks less bright; and on No. 6, especially at the discharge, it has become cooler.

The air for oxidation is admitted by side doors, mostly those of the lower



hearths. The gas and dust, passing up through the drop-openings, are drawn through the horizontal main flue. In starting, the furnace is heated to the kindling temperature of the ore which, if rich in sulphur, burns by its own heat, without the aid of fuel. If the sulphur content is low, additional heat is supplied by one or more external fireplaces, near the bottom of the furnace.

To protect the rabble-arms from the intense heat they, and likewise the central shaft, are water-cooled. The cooling-water is forced down the 9-in. hollow, central shaft in a 3-in. pipe to a point near the bottom, and out to the ends of the arms in 1-in. pipes. It then returns up the annular space between the 3-in. pipe and the hollow shaft, and discharges at the top through two spouts into a launder. The furnace is  $18\frac{1}{4}$  ft. high by 18 ft. diameter, and has a total hearth-area of 1600 sq. ft. The structure is supported on columns to give room below for the hopper and the car into which the roasted ore is discharged. The shell, made of  $\frac{3}{8}$ -in. plate-steel is lined with 9 in. of brick-work. The rabble-arms consume  $1\frac{1}{2}$  to 2 H.P. and make one revolution in  $1\frac{1}{4}$  minutes.

A furnace treats, in twenty-four hours, 65 tons of sulphide ore of 35 per cent sulphur, reducing it to 7 per cent. About 4 per cent flue-dust is made; and the ore itself contains more ferric oxide, and is lighter and more porous than if treated in a hand-reverberatory roaster. The cost of roasting such ore is approximately 35 cents per ton, which is the lowest figure thus far known for any furnace. The compact form of the furnace reduces radiation to a minimum and permits roasting with little or no fuel. Taking capacity into consideration, the furnace is one of moderate price, and one that costs little to keep in repair.

Of the two revolving-hearth furnaces, the Holthoff and the Raymond, the latter has some popularity for the preliminary roasting of ores for blast or pot-roasting, the powdered ore being showered down a vertical shaft or tower and coming in contact with an upward flame from a firebox. An objection to its use is that much flue-dust is made.

Fig. 76 is a perspective view of the enclosed type of MacDougall roasting furnace, where, in order to permit a firebox below the lowest hearth the driving mechanism has been transferred above the furnace. The firebox enables the hearths, and especially the lower one, to be heated. By its use the ore may be roasted to a lower percentage in sulphur.

In Fig. 77 we give a plan and sectional elevation of a MacDougall roaster. At the center drop holes, a plate on the rabble arms hold up the ore close to the opening so that the gases do not pass upward there. The outer drop-holes are similarly sealed. Thus the gases must pass upward by the gas passageways, and are thus free from flue dust.

**The Wedge Roasting Furnace.**—Fig. 78 is a sectional elevation of a seven-hearth furnace as constructed for oxidizing roasting. If the ore

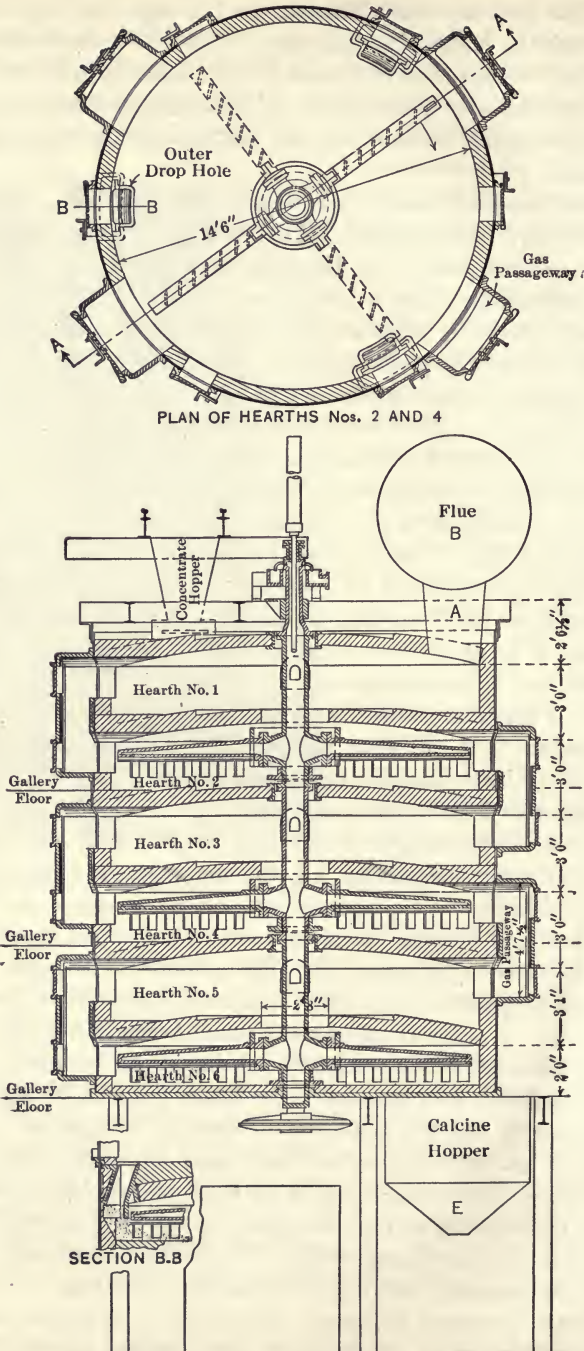

FIG. 77.—MacDougal Roasting Furnaces (sections).

contains moisture, this is dried out upon the top, called the drier-hearth. The central hollow shaft *A* is covered outside with tiles to protect it from the furnace heat. It carries at each hearth two opposite rabble-arms which are water-cooled by small feed and discharge pipes leading down from above. Individual pipes from the water pan *E* pass down the shaft to the

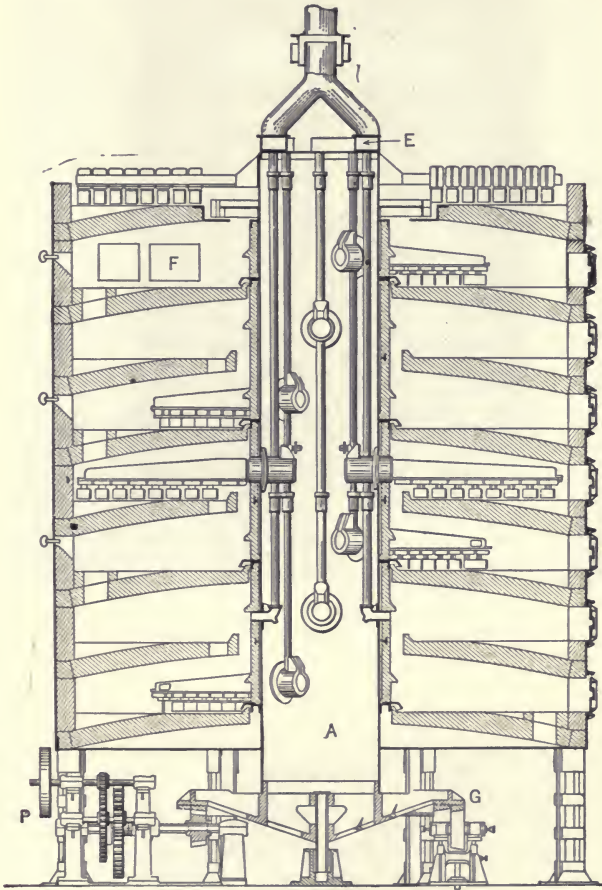

FIG. 78.—Sectional Elevation of Wedge Roaster.

rabble arms. The hearths are enclosed in a steel shell  $22\frac{1}{2}$  ft. diameter. The outlet for the sulphur-bearing gases is at *F*.

The driving pulley *P* through a train of spur gears communicates motion to a bevel pinion on the end of a horizontal shaft, and this meshes into the master gear *G*, at the foot of the hollow shaft *A*. This same gear has a turned raceway at its edge supported by rollers that carry the whole weight of the shaft and the sixteen rabble arms.

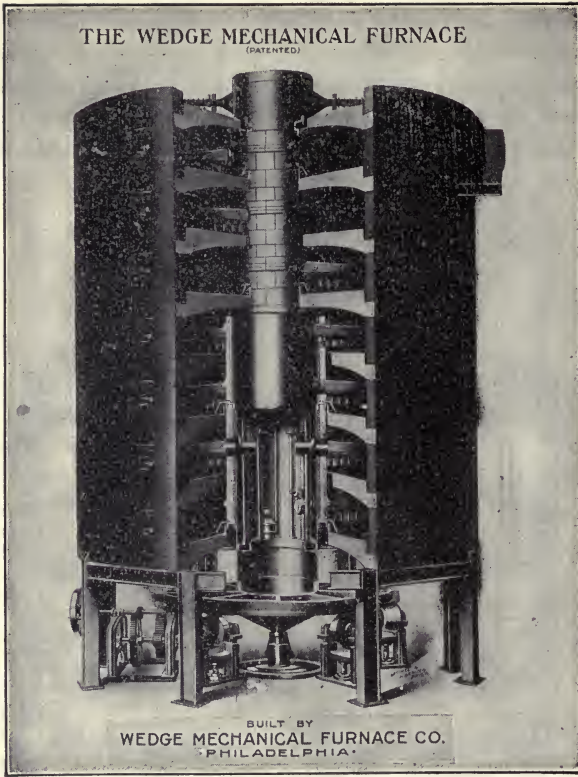

FIG. 79.—Elevation of Wedge Roaster.

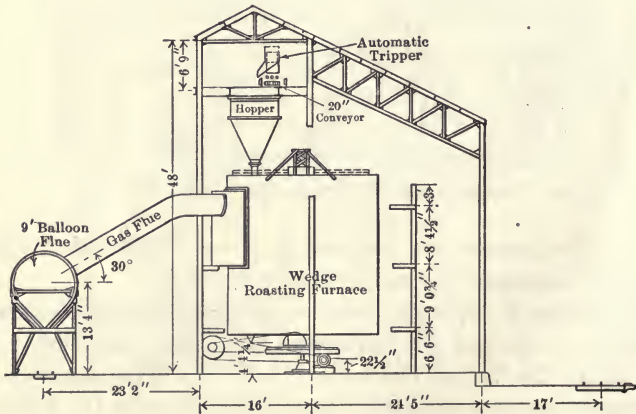

FIG. 80.—Section of Roaster Plant.

The ore, fed at the outer edge of the top or drier hearth, works down under the central plate upon hearth No. 1. It passes across the hearth to

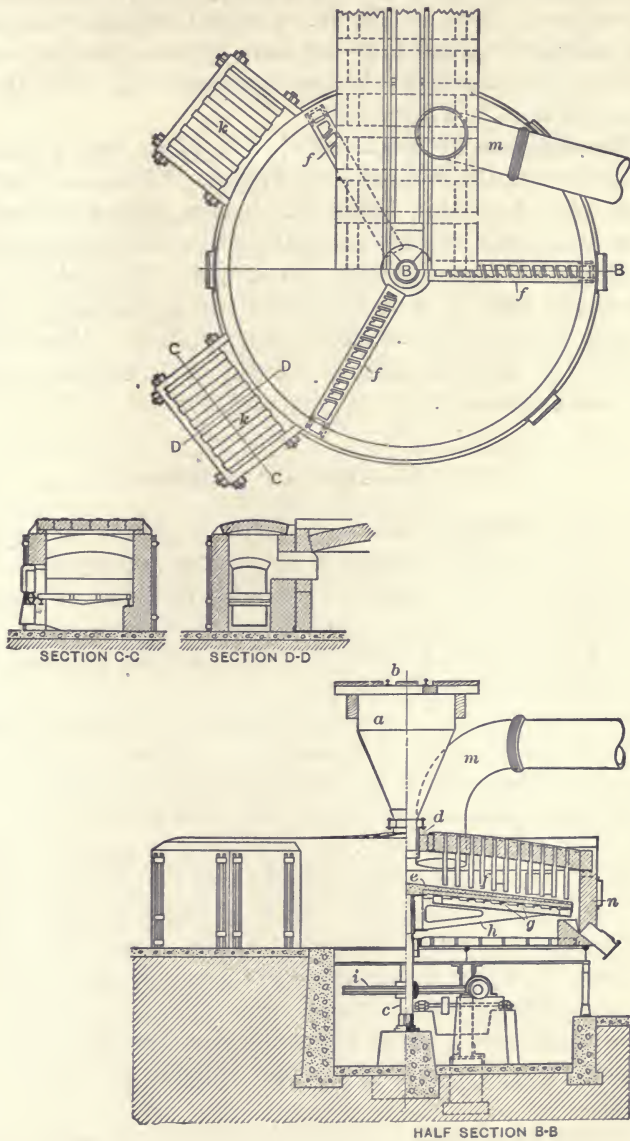

FIG. 81.—Brunton Roasting Furnace.

the outer drop-holes of hearth No. 2. On hearth No. 3 the ore has drop-holes other than the central opening where the gases rise so there is less

flue dust made and so on. The lower hearth has a peripheral drop-hole for the discharge of the calcine. Fig. 78.

The method of installation of a roaster building containing multiple-hearth roasters is shown in Fig. 80. Crushed ore from the sampling and grinding building is carried to its top story by an incline belt conveyor and is delivered to the roaster feed-hopper by means of an automatic tripper on the horizontal 20-in. conveyor belt.

**The Brunton Roasting Furnace.**—In Fig. 81 we show a plan and elevation of this furnace, also sections of the firebox. This has a revolving hearth and three sets of rabblers, being iron blades passing through the roof. These, set at an angle, stir and move the ore, which is fed through the roof at the center to the discharge chute at the right. The hearth is carried on a cast-iron frame fixed to a vertical shaft and is driven by a large worm-wheel and a worm on the horizontal driving shaft. There are two coal-fireboxes *kk*, the flames entering at the side of the hearth and the mingled fire gases and arsenical fumes escaping at flue *m*.

#### ROASTING OF MATTE

The term "roasting" is applied also to a method of treating copper matte in a reverberatory furnace in large pieces, upon which an oxidizing flame is allowed to play. Such masses slowly melt and are acted on by the air, whereby a part of the material becomes oxidized or roasted sufficiently for the next operation. As compared with ordinary roasting this is slow, and the method is one but little used.

Copper-bearing matte to be subjected to an ordinary oxidizing roast must be crushed at least to 4-mesh size. Matte from the silver-lead smelting to be roasted in a reverberatory furnace of the kind shown in Fig. 63, needs a different treatment from that given to ore. This kind of matte contains but 20 per cent sulphur, and does not take fire like pyrite ore, but must have a high finishing heat to expel the sulphur. Such matte is considered well roasted when it contains 4 per cent sulphur. Ores low in lead can easily be roasted to 2 to 3 per cent sulphur, while galena, when roasted, still contains 5 to 6 per cent when drawn from the furnace. Like matte, galena starts burning slowly, and must be roasted slowly, for rapid heating causes it to sinter and thus stops further roasting. Typical leady matte contains metals and sulphur as shown in the sub-joined table.

The roasted low-grade matte contains 23 per cent oxygen. This explains why it does not lose weight in roasting. Pyrite ores of 20 to 30 per cent sulphur, on the contrary, easily lose 15 per cent in weight.

**Losses in Roasting.**—Such loss depends upon the extreme to which the roasting is carried as well as upon the nature of the ore. When ore is so

	Raw, Low Grade. Per Cent.	Roasted, Low Grade. Per Cent.	Raw, Shipping. Per Cent.
Cu.....	4.62	4.12	42.30
Fe.....	53.11	52.41	20.00
S.....	26.87	6.13	17.89
Pb.....	10.66	10.49	9.06
	95.26	73.15	89.25

roasted that it is not sintered at the final high temperature, the lead lost averages 2.5 per cent, but no loss of silver occurs. When the temperature is carried higher, and the ore is agglomerated, the loss is slightly higher. When fused it may reach 15 to 20 per cent of the lead and 2 to 5 per cent of the silver. Of the gold little is lost in oxidizing roasting.

#### CAPACITY OF FURNACES AND COST OF ROASTING

These depend upon the surface exposed to the oxidizing influences and upon the quantity of sulphur contained in the ore in hand reverberatory roasting. Silicious ore, containing  $\frac{1}{2}$  to  $3\frac{1}{2}$  per cent sulphur, requires 13 to 15 sq. ft. of hearth-area per ton of ore roasted per twenty-four hours. Matte containing 20 to 25 per cent sulphur, when it is necessary to reduce the sulphur content to 4 per cent, needs 45 sq. ft. hearth-area; copper sulphide ore, roasted to 7 per cent in preparation for smelting, requires 33 to 35 sq. ft. For roasting iron-sulphide concentrate, which carries 35 to 45 per cent sulphur, down to 3 to 10 per cent sulphur, 55 to 60 sq. ft. hearth-area is needed.

**Roasting Costs.**—In 1910 to 1913 ore-roasting in heaps, at Jerome, Arizona, cost 80 cents per ton, including general expense. Ore-roasting in stalls cost 50 cents per ton. For reverberatory roasting, in long, hand-rabbed furnaces the lowest price attainable on copper ores was \$1.50, with an average of \$1.81 per ton. For roasting lead-bearing ores, \$1.75 is a moderate cost, and from this the cost, when all items are included, may rise to \$2.25 per ton. The Allen-O'Harra automatic furnace, having two straight hearths each 94 by 9 ft., and resembling the Wethey furnace, roasts 45 to 50 tons daily at a cost of 78 cents per ton. The Wethey furnace, of the type having four hearths, each 65 by 10 ft., the roasting proceeding on all the hearths, roasts 90 tons daily to 5 to 6 per cent sulphur, at a cost of 98 cents per ton. The 16-ft. MacDougall furnace (Herreshoff type), having five hearths,  $14\frac{1}{2}$  ft. diameter, and a total area of 830 sq. ft., roasts 33 to 35 tons daily to 7 per cent sulphur at a cost of 50 cents per ton. The Brückner roasting cylinder,  $8\frac{1}{2}$  ft. diameter by 22 ft. long, takes a charge of 20 tons (10 tons daily), and in forty-eight hours roasts it to 4 per cent sulphur at a cost of 80 cents per ton.

It will be noticed that the low cost of roasting in some of these furnaces is due to their needing no fuel after coming into full operation. To obtain this effect such furnaces have several hearths, and are compact. On account of this compactness they lose but little heat by radiation.

The above roasting costs were for the period 1910 to 1913, but these figures must be doubled for present conditions.

### BLAST- OR POT-ROASTING OF ORES

Both lead and copper ores are treated by blast- or pot-roasting, though the method was at first intended for lead-bearing ores, especially for galena. I have already mentioned the difficulty of roasting galena by the old method, in the reverberatory furnace; but by pot-roasting, it can be so treated as to remove most of its sulphur, with less loss by volatilization.

**Treatment of Galena.**—By the Huntington-Heberlein process, called also the “H and H process,” the galena-bearing ore is given an incomplete, rather rapid roast, to reduce the amount of sulphur to 12 to 14 per cent. The product from the roaster is mixed with a certain proportion of limestone and silicious ore, wet down, and charged into a hemispherical cast-iron pot  $8\frac{1}{2}$  ft. diameter by 4 ft. deep, having a capacity of 8 to 10 tons as shown in Fig. 82. Within the pot, and forming a false-bottom, is placed a circular arched plate perforated with  $\frac{3}{8}$ -in. holes to admit air to the charge under pressure. Upon the false-bottom is scattered a wheelbarrow-load of ashes, then a carload (one ton) of hot ore from the roaster. On this is dumped 8 tons of charge wet to about 6 per cent moisture. Air, under the pressure of a few ounces, is admitted beneath the false-bottom, and coming up through the hot ore, it produces a burning-temperature and starts the combustion of the charge. The heat gradually ascending to the top, the charge becomes red-hot, and  $\text{SO}_2$  and  $\text{SO}_3$  escape. At the end of the roasting, which lasts sometimes sixteen hours, there remains only 3 to 5 per cent sulphur if the charge is properly burned. The pot is now inverted to discharge the contents, and this falls out in an agglomerated, red-hot mass. It is broken to a size suited to subsequent treatment in the blast-furnace.

**The Dwight-Lloyd Machine.**—Blast-roasting in pots has several disadvantages: the ore is exposed for a long time to the hot gases and this leads to a loss of metal; the process is intermittent; the charge needs constant attention either in charging, discharging or blowing; the amount of fine is apt to be considerable and this must be re-treated; the ore is not evenly sintered; finally, it is expensive to break up the sintered mass, whether by hand or by power. These disadvantages appear to be overcome by the Dwight-Lloyd sintering process, especially by the use of their endless-chain machine, 28 ft. total length, illustrated in Fig. 83. As



compared with pot-roasting, and particularly with roasting furnaces, this machine occupies but little room.

The endless-chain carries a train of pallets. Each pallet is in fact a perforated grate having two edges upturned  $4\frac{1}{2}$  in. The joints between the

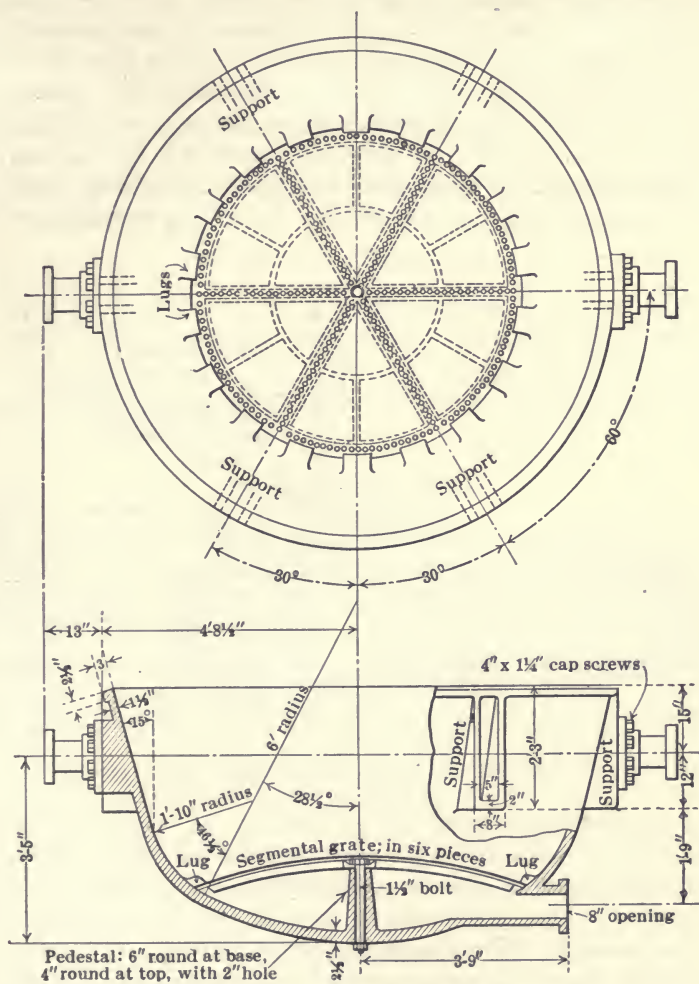

FIG. 82.—Details of Construction of Blast-roasting Pot.

pallets and between the pallets and the suction-box are close and fit snugly by planed edges. At the ends of the suction-box a planed dead-plate, over which the pallets glide, serves to make the joint tight there. After the pallets leave the suction-box their four wheels transfer their weight to the rails. At the delivery-end, where a car is stationed, the pallets are slightly

raised, fracturing the sintered coke, then drop one by one, striking the pallet next below on the circuit, while the sintered ore is jarred off into a car. The ore is fed to the machine through a pug-mill where it is wet to 4 per cent moisture by a spray, and falls to a feed-hopper set 4 in. above the pallets, thus ensuring a layer of ore of that depth. It moves along at the rate of 12 to 20 in. per minute. As it reaches the ignition-box it is set afire by an ignition-furnace burning coal, or otherwise gasoline is burned, using a series of Bunsen burners supplied by air under pressure. The suction-box 12 ft. 6 in. long by 30 in. wide is connected to an exhaust-fan at a vacuum of 6 oz. As the ore passes the burner it is ignited, and the air, sucked down through the layer of ore, continues the burning, which is completed by the time the ore reaches the end of the suction-box. There

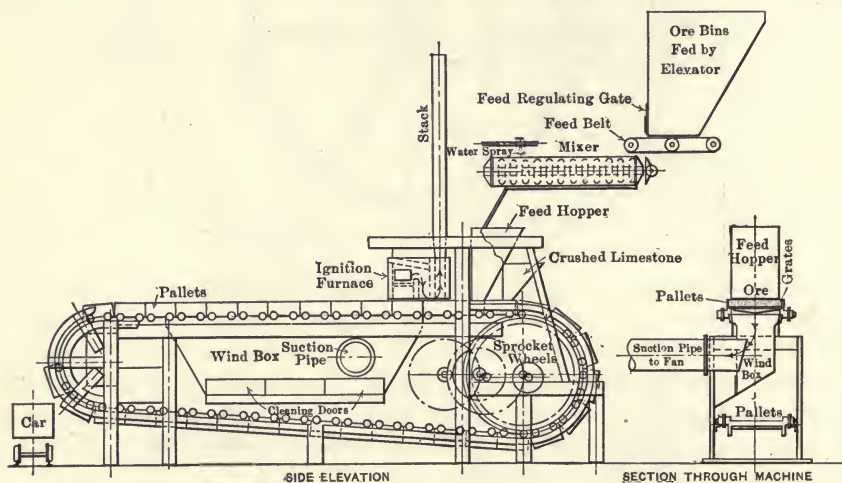

FIG. 83.—Straight-line Dwight-Lloyd Blast-roasting Furnace.

results a product which retains 3 to 5 per cent of sulphur only. By the time the ore layer has reached the discharge-end it is solid. The mouth of the feed hopper is set to give the required depth of material, and the layer of ore is smoothed by a stiff brush 30 in. wide, then by a roller, all tending to level and compact the ore to ensure even sintering and roasting. Care must be taken that the layer of ore is of uniform density and that there is no segregating of it in the feed-hopper; otherwise the coarser part of the layer burns rapidly while the denser part does not get enough air.

The mixture or charge may consist of lead concentrate, fine oxidized and silicious ores, together with flue dust. Its composition may be quite variable. A satisfactory mixture will carry 35 per cent  $\text{SiO}_2$ , 18 per cent S, and 20 per cent Pb; another one, 16 per cent  $\text{SiO}_2$ , 18 per cent Fe, 15 per cent S, and 30 per cent Pb.

The machine will treat 40 tons in twenty-four hours at a cost of 75 cents per ton. One to two horse-power is needed to drive it.

**Reactions in Sinter-roasting of Copper-bearing Sulphides.**—When a mixture of iron and copper sulphide is sinter-roasted, desulphurization proceeds rapidly if the ore be wet and silica be added; otherwise it proceeds slowly. For these reactions we have:

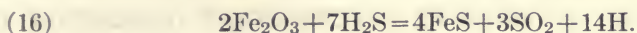
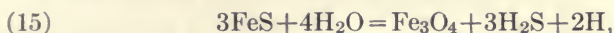

When air is drawn through the charge both hydrogen and  $\text{H}_2\text{S}$  burn, but  $\text{Fe}_3\text{O}_4$  reacting on  $\text{FeS}$  gives  $\text{FeO}$  as follows:

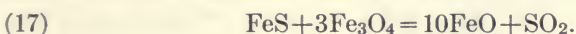

This reaction is exothermic and at a high temperature with silica would form ferrous silicate, again producing heat. Indeed, in action the formation of this, with the consequent sintering, can be seen spreading as the burning proceeds. The cost of blast-roasting in pots has been given at \$1.44 to \$1.80 per ton.

#### TRIPLE ROASTING

While blast- or pot-roasting is less used than formerly, in one case, viz., at East Helena, Mont., zincky Cœur d'Alene concentrates high in lead are roasted in three stages. A Godfrey revolving-hearth roaster brings it down 13 per cent sulphur. Again crushed, it passes to a Dwight-Lloyd sinter machine which reduces the sulphur to 8 per cent. This product, if smelted, would produce too much matte, therefore, after again crushing, it is blast-roasted in Huntington-Heberlein pots, and yields a final material that carries but 2 per cent of sulphur—so low is this element in fact that there is no production of matte in smelting it.

## CHAPTER X

### CONCENTRATION OF ORES AS A SUBSIDIARY OPERATION IN METALLURGY

In mills treating ore containing a heavier part, such as sulphides, gold or amalgam from the plates, it is customary to catch such heavy products:

#### CONCENTRATION

1. By gravity concentration in which the heavy particles of the pulp are caught on blanketed or canvas-covered surfaces;
2. By concentrating tables;
3. By oil flotation.

1. **The Blanket or Canvas Table.**—This consists of a floor, sloping like an amalgamating plate,  $1\frac{1}{2}$  in. to 3 in. per foot. It is smoothly covered

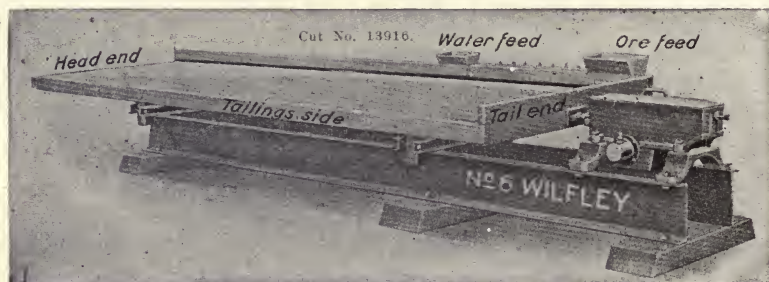

FIG. 84.—Wilfley Concentrating Table.

with blankets or canvas, and along its upper edge the mill-pulp is flowed in an even, thin layer from a head launder to distribute over the table. The lighter particles flow down the slope, the heavy portion sinking into the interstices of the fabric. After a while the mill-flow is switched to another table or floor. Fresh water or solution is then run on the loaded table which sweeps away the settled pulp, leaving the heavy particles in the interstices of the blanket or canvas.

2. **The Concentrating Table.**—There are different varieties of these, such as the Frue Vanner or the Wilfley table. The mill-flow is received in a continuous stream at the head launder of the machine and delivers two products, a head product or concentrate, and a tail product freed from the heavy portion.

**The Wilfley Table.**—This may be taken as a type of table, which like the Overstrom, the Deister, or the Burchart is much in use in mills. Fig. 84 is a front view of a No. 6 Wilfley table having a deck, a surface partly riffled, partly smooth, so transversely inclined that a sheet or film of water,

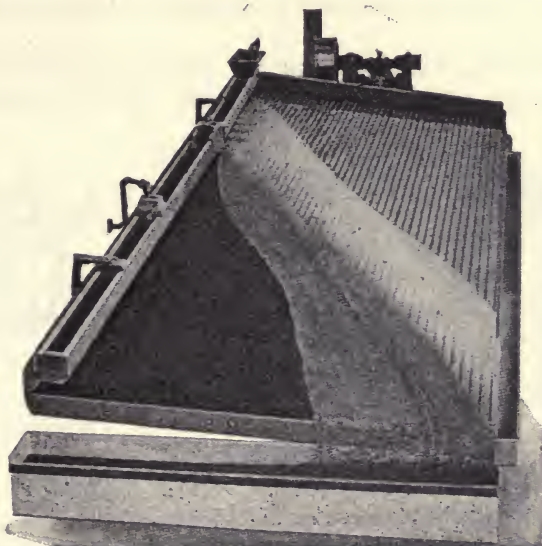

FIG. 85.—Wilfley Table in Action.

composed of feed-water conveying ore-pulp and the washing or dressing water may be caused to flow across it. This deck, mounted on bearings, has an endwise reciprocating motion of  $\frac{1}{2}$  to  $\frac{3}{4}$  in., imparted by a mechanical device called the "head motion." This head motion causes a separation of the heavy and light grains into layers by its agitation and jerking action, throwing them toward the head end, the lightest-grained being washed down the slope and dropping over the edge at the tailings side. This separation is well shown in Fig. 85. The heavy grains travel along in the riffles and are forced more toward the head, escaping there and at the head-end-corner. Each kind is caught in its own launder.

## OIL FLOTATION

Flotation is a method of concentrating whereby a finely ground water pulp, containing sulphides, as of lead, copper, zinc, or magnetite, together with a gangue of quartz or other equivalent mineral, is treated by addition of oil (or other chemicals), and violently agitated. The oil or other chemicals act to produce a film upon the sulphide particles, causing them to float as a froth upon the surface of the water, while the gangue sinks to the bottom. The froth is removed, settled, and filtered, yielding a product containing the valuable sulphides. This method possesses the advantage that it is effective upon slimes hard or impossible to concentrate by gravity methods.

Most plants use a mixture of various oils and the kind and quantity should be worked out for each particular case. Pine oil is quite commonly

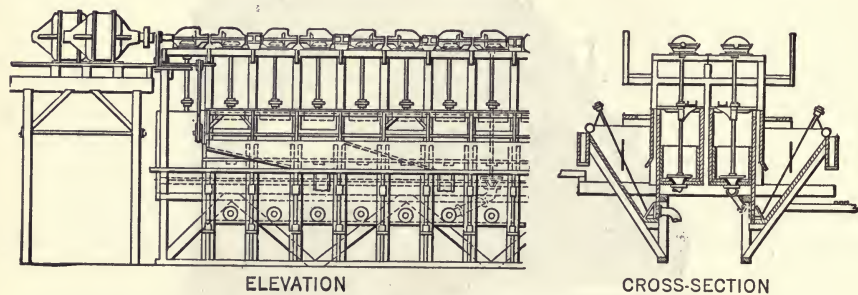

Fig. 86.—The Minerals Separation Machine.

used, also wood and coal-tar creosote. Creosol or cresylic acid is used in small proportions with coal-tar. Other substances are fuel-oil, oleic acid, and eucalyptus oil.

**Minerals Separation Flotation Machine.**—Referring to the two views of a double machine, Fig. 86, the feed enters the first agitation box at the motor end of the machine, thence it passes to a second box, through an opening in the partition wall, as shown in the transverse section.

From the second box it descends to the first spitzkasten where the froth, which rises to the surface, flows over the front edge into a narrow deep launder. The remaining pulp passes through a pipe (the inlet controlled by a valve) to the third agitating box. From this box the pulp passes to the second spitzkasten, and so on through the machine until it reaches the fourteenth. The discharge from the fourteenth spitzkasten leaves the machine as tailings. The catch-launder is so divided that the first four to seven spitzkastens make frothed concentrates, the remainder make middlings that are returned to the system. Some of the pulp is overflowed from the last three together with the froth. For affecting the agi-

tation, each of the sixteen vertical shafts running at 250 R.P.M. carries a four-bladed impeller. At Anaconda 6 to 8 lb. of 60 per cent sulphuric acid, 2 to 3 lb. of kerosene sludge acid, and  $\frac{1}{2}$  to 1 lb. of wood creosote is used per ton of flotation feed. Part of the creosote is added ahead of the tube-mill, where the pulp is ground, the remainder with the acids at the first agitation box. The pulp is heated to 70° F. by blowing live steam into it at the head of the machine. A machine will treat 175 tons daily of slimed pulp. Other flotation machines much used are the Callow and the Janney.





PART II

GOLD

1870

100

## CHAPTER XI

### GOLD ORES AND CLASSIFICATION FOR MILLING

#### OCCURRENCE

Gold occurs in nature, both in the native state and combined with tellurium.

**Native gold** occurs in vein-matter disseminated in grains or particles of various sizes, and it is found not only in quartz veins, but in veins or lodes containing hematite, iron-pyrite, arsenical-pyrite, blende, and galena. In pyrite it occurs not only in the substance of the crystals, but as films on the surface of these crystals. It is frequently accompanied by silver. When gold-bearing veins have become disintegrated and swept away into alluvial deposits, the particles of gold, where released, are found in the sand and gravel of the beds, the pebbles and boulders themselves (which have come from the country rock), being in general barren of gold. Gold occurring in this way is called alluvial gold, and is recovered by methods of hydraulic mining or dredging, which belong to mining engineering rather than to metallurgy. We shall consider, therefore, the treatment of gold ore.

**Gold Tellurides.**—In South Dakota, at Cripple Creek, Colo., in Western Australia and elsewhere is to be found gold combined with tellurium as calaverite,  $\text{AuTe}_2$  (containing 41.4 per cent Au and 57.3 per cent Te); also gold and silver combined with tellurium as sylvanite  $(\text{AuAg})\text{Te}_2$ , and as petzite  $(\text{Ag}_2\text{Te}, \text{Au}_2\text{Te})$ .

**Physical Properties of Gold.**—This, the only yellow metal, has a specific gravity of 19.3 and is the most malleable and ductile of all metals so that an ounce of it will cover 160 sq. ft. It is softer than silver, harder than tin, and has a tenacity of 14,000 lb. per square inch, with a 30.8 per cent elongation. It melts at  $1063^\circ \text{C}$ . and begins to volatilize at  $1100^\circ \text{C}$ ., so that by the time it reaches  $1250^\circ \text{C}$ . it volatilizes four times as fast.

These metals are commonly found together in ores, and a metallurgical method suited for the extraction of one is often as well suited to the recovery of the other. The recovered metals, alloyed with one another, and forming a gold-silver bar, are shipped to the mint or to the refiner in that form for final parting into their constituent metals. Both gold and silver are won from their ores by milling or by smelting methods, the former being the commoner way.

**Valuation of Gold and Silver.**—The amount of gold and silver in ores is expressed in ounces, in pennyweights, in grams or in kilograms per ton. When in the form of bars or ingots the value is given in the percentage or in the fineness of the respective metals. In English-speaking America silver and gold in ores and by-products are designated in ounces per ton or in dollars. Thus 0.05 oz. equals \$1 per ton, valuing gold at \$20 per ounce. Its exact mint value is, however, \$20.67 per ounce. In the British Empire, except Canada, notably in South Africa and Australia, the pennyweight is preferred, a convenient designation, since it gives the value very close to \$1 or four shillings English money. In Latin America gold is expressed in grams, silver in kilograms per metric ton. The contents of a gold-silver bar is given in fineness, i.e., in parts per thousand. Thus such a bar, upon assay, may be 750 fine in gold, 150 fine in silver, the remaining 100 parts being mainly copper. United States gold and silver coins are 900 fine in gold and silver respectively, the 100 parts remaining being copper. Sterling gold or silver is 925 fine.

#### CLASSIFICATION FOR MILLING

Referring to the milling of gold ores, that is, to ores in which gold is the dominant metal, these may be treated directly, or as supplemented by concentration as follows:

- Amalgamation;
- Chlorination;
- Cyaniding;
- Amalgamation and cyaniding;
- Amalgamation, concentration, and cyaniding the tailings;
- Concentration and cyaniding the tailings.

Where concentrates are made these are further treated by smelting, or at the mill by cyaniding them. They may be produced either by gravity concentration or by flotation.

## CHAPTER XII

### AMALGAMATION

**Plate Amalgamation.**—This is the time-honored method for the recovery of gold from “free-milling” ores and as an important preliminary process with gold ores, which though not free-milling, contain a considerable proportion of readily amalgamable gold. By free-milling ores we mean those in which the gold occurs native and can be caught by amalgamation. However, the cyanide process is used after amalgamation where a portion of the gold is not recoverable by amalgamation.

**Ores Needing Amalgamation.**—Free-milling oxidized gold ores in which the gold is shown upon panning, and where many of the particles are too coarse for solution by cyaniding, are the ones for this method. At the Manhattan Big Four mill, where the ore is a soft calcareous schist with laminations containing calcite and quartz, but no sulphides, the fine gold, occurring in the laminations, is stamp- and tube-milled as just above outlined. It is thus seen that when the ore has been stamped coarse, the pulp is not run over the amalgamating plates until finely ground, so in this mill we find the plates not in their customary place below the mortar, but in a separate building, where they receive special attention, and are safe from pilfering.

Whether inside amalgamation is the most suitable is often discussed; but for certain ores it is the correct method.

Gold sometimes occurs in certain ores with a metallic appearance, but is mostly brown and lusterless. In this supposedly allotropic form it fails to attach itself to the amalgamated plate.

There is a considerable difference of opinion among metallurgists regarding the extent to which amalgamation should be used in a goldmill. Some think with very fine grinding to bring all the gold (and any silver) to the degree of subdivision necessary for rapid solution, that amalgamation may be dispensed with, and that by “all-sliming” the gold can be extracted by cyaniding.

The two extremes in the plate area provided for amalgamation prior to cyanidation are represented by the Rand and the Homestake. Figures from thirteen Rand plants, for the year 1913, show the recovery by amalgamation on mill feed, approximating \$6, to be 61.4 per cent the plate area ranging from 0.25 to 2.0 sq. ft. per ton milled per day, and the mercury

consumption about 0.1 oz. per ton milled. The tendency on the Rand has been to eliminate amalgamation directly after the stamps in favor of amalgamation after tube-milling, and at the same time, reduce the plate area to less than a half. In no case has the reduced plate area caused serious decrease in recovery by amalgamation, some instances showing no decrease, while, naturally, there is a decided saving in mercury-loss, attendance, and capital cost. On the other hand, amalgamation at Homestake is carried on both inside and outside of the stamp mortars and after regrinding. Of the total plate area of approximately 11 sq. ft. per ton milled, only 1.60 per cent is used after regrinding. In 1914, on \$4.11 mill feed, the Homestake recovery by amalgamation at the stamps was 69.0 per cent, and after regrinding, 0.8 per cent; the total of 69.8 per cent being effected with a loss of mercury of 0.13 oz., and at a total cost of 2.45 cents per ton milled.

Amalgamation, as practiced at the average plant, costs between 5 and 10 cents, the plate area approximating 2 sq. ft. per ton milled. The recent trend has been to relegate to this step the recovery of such coarse gold as may greatly retard, or entirely escape subsequent cyanide treatment. With amalgamation, crushing is nearly always done in water, although a few plants have been able to maintain their plates in fair condition when crushing in cyanide solution. The extremely low cost of recovering gold by amalgamation demands that this step be given weighty consideration. An unusual method of amalgamation at the Nipissing high-grade mill is to be noted. A charge of 3 tons of 2500-oz. silver ore (containing 39 per cent arsenic, 9 per cent cobalt, 6 per cent nickel), 4 tons of mercury and 1.5 tons of KCN solution is tube-milled, with compressed air fed into the tube-mill for some ten hours, at the end of which period amalgamation has recovered some 97 per cent of the silver, the residues, freed from amalgam and mercury, then going to the cyanide plant. The mercury consumption is 20 lb. per ton of ore.

#### STAMP-MILLING WITH PLATE AMALGAMATION

The ore is crushed to a size of 20-mesh or finer, using 6 to 8 tons of water per ton of ore, and running the ore pulp over plates of at least  $4\frac{1}{2}$  ft. wide by 6 ft. long per battery or often much longer. The heavier gold soon touches the plate where it becomes incorporated with the amalgamated surface. About every shift the battery is stopped for a few minutes and the gold-bearing amalgam is scraped from the plates, and treated to obtain the gold. Amalgamated plates may also be placed inside the mortar; particles of gold adhere to these plates when driven against them by the splash of the pulp. Gold particles also fall to the bottom of the mortar to be caught by mercury there. The gold caught inside the mortar is recovered in the monthly clean-up. From time to time about 1.5 oz. mercury per ounce of gold in the ore is added in the mortar as the crushing proceeds.

Plate amalgamation is used for gold ores only.

The tailing, if barren, is run to waste. If it contains gold-bearing pyrite this may be caught on concentrating tables, see Fig. 84, to be sent away for smelting or to be specially treated on the spot by cyaniding. The tailing, generally gold-bearing, would be cyanided.

**The Stamp-battery.**—Fig. 87 is a view of a ten-stamp battery of wood

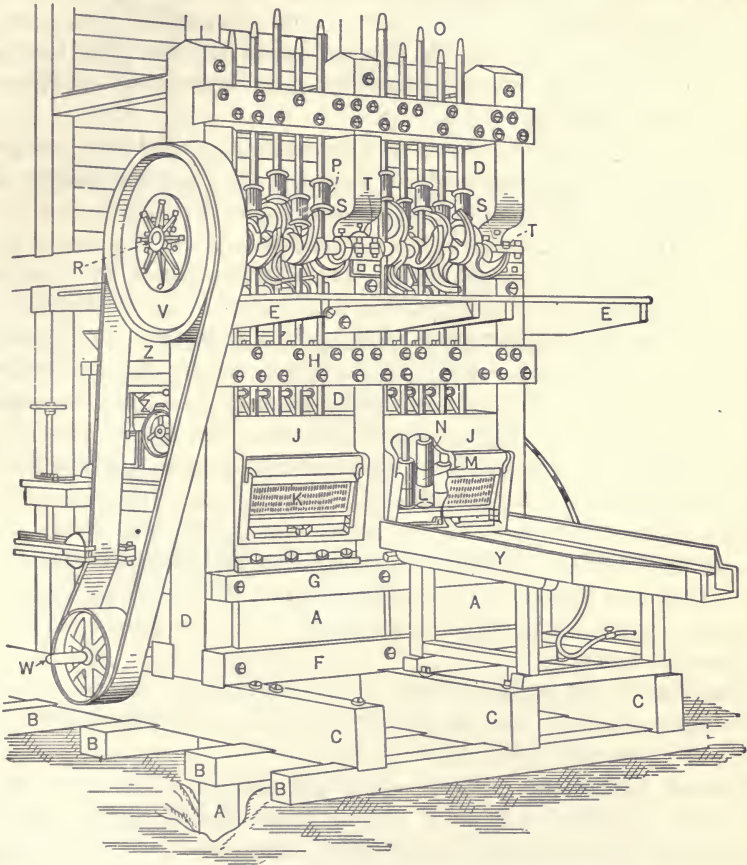

FIG. 87.—Perspective View of Ten-stamp Battery.

construction. The parts are thus designated. At *A*, the mortar block or foundation; *B*, the mud sills, *C*, the cross sills; *D*, the side posts; *F* and *G*, the buck-staves; *H* and *I*, the lower and upper guide-timbers respectively. The foregoing parts constitute the battery frame. *J, J* are the cast-iron mortars as shown in section in Fig. 88. At *K* is a wire cloth, or, as here shown, a slotted screen. At *L* is the die, resting on the sole of the mortar. The stamp consists of a stem having on it tappet *P*, by which it is lifted and

at its lower end a boss *N*, carrying its shoe *M*, these four parts being the total weight. In Fig. 88 this weight is 1250 lb. *R* is the cam shaft carrying ten cams *U* (better shown in Fig. 88), with its driving pulley *V* at one end. At *Y* is seen one of the amalgamated plates, already referred to, the other being omitted to show the screen and chuck-block belonging to the first five stamps.

In Fig. 87 the mortar blocks are heavy posts, set on end, and extending down to the solid rock or concrete foundation. Instead of these, concrete blocks, Fig. 88, are preferred, the mortars being held down by long foundation bolts with  $\frac{1}{4}$ -in. sheet rubber and  $\frac{1}{8}$  in. sheet-lead interposed to give an even bearing.

Fig. 88 is a sectional elevation of a ten-stamp battery unit, grouped as shown in Fig. 87, into two sets of five stamps. Ore from the feed bin is fed to the stamps by a suspended Challenge ore-feeder, which can be run out of the way when making repairs to the stamps. At *S* is shown a horizontal lever depressed at each stroke by a collar on one of the stamps and by a vertical link and lever working a ratchet feed. As the circular feed-plate slowly revolves against a fixed scraper, the ore is scraped off to fall into the mortar. As the ore accumulates under the stamps, the stroke shortens and with it the feed, while as the mortar empties the stroke is increased and with it the feed. The ore from the lip of the feeder falls into the mortar, there to be stamped, and when sufficiently fine, the resultant ore pulp is driven through the screen at the front by the splash caused by the dropping stamps, to flow over the apron plates (not here shown). The guide timbers carry the lower and upper cast-iron guides for each stamp stem. At *X* is a finger-bar, one to each stamp, by which the stamps are "hung up," when, for any reason, a battery is to be stopped without stopping the other battery.

**Operation of the Stamp-battery.**—The feed is regulated so as to cause the stamps to strike with a sharp, hard blow, but with little of the rebound that would occur with a thin layer of ore.

**Mercury Fed to the Battery.**—This will average 1.5 oz. per ounce of gold caught. Added, a little at a time inside the mortar, it works out in part upon the apron plates. For the amount to be used the mill-man is guided by the appearance of the plates. If they are hard it means too little mercury or "quick"; if the mercury shows on them in streaks or patches then too much is being fed. Mercury should be free from base metals that would cause it to "sicken" into coated globules, which would be swept away with the pulp. It is better that it contain a little gold.\*

\* The loss of mercury may aggregate 0.5 oz. per ton of ore treated. It may be lost by flouing, indicated by a white appearance, and due to excessive agitation in the air, which breaks it into particles so fine that they unite no more. Mercury may be lost by "sickening," shown by a black appearance and due to the presence of base metals as already explained.



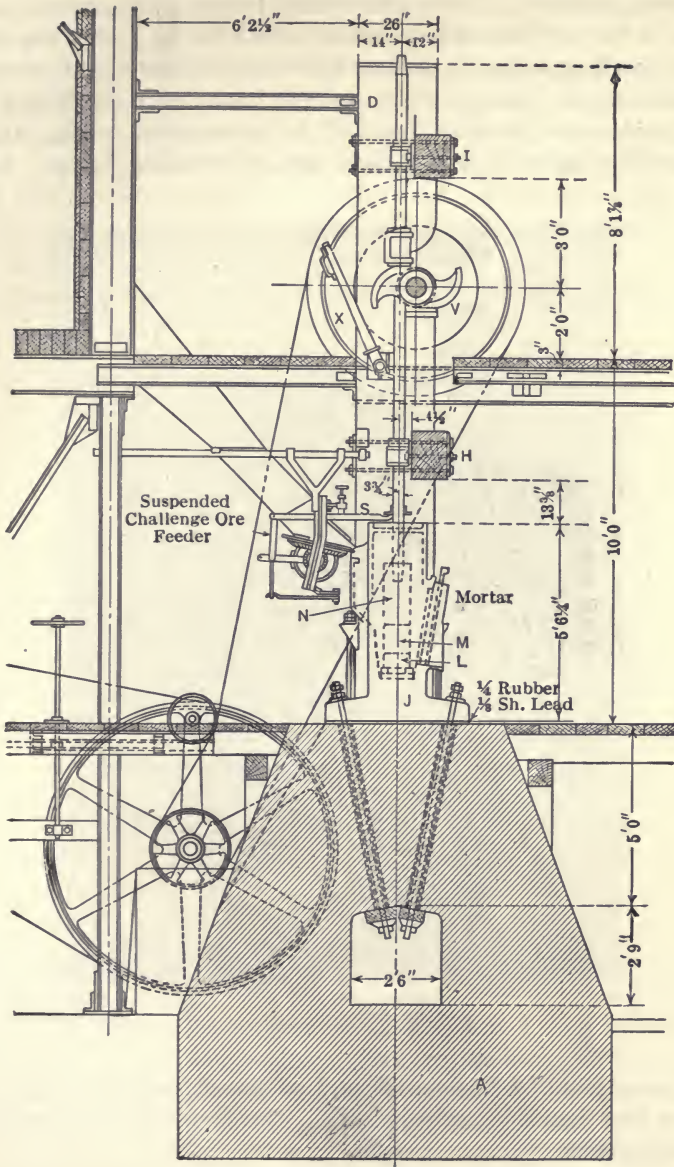

FIG. 88.—Sectional Elevation of Ten-stamp Battery.

**Dressing the Plates.**—This is done three or four times daily, and takes about fifteen minutes. To do this feeding is stopped so that the ore may work out of the mortar, and the stamps are hung up. The amalgam on the plates, perhaps a cupful, is removed with a rubber-edged scraper. If the surface of the plate is hard a little mercury is sprinkled on it. Where the plate has become tarnished by a verdigris coating this may be removed by salammoniac applied with a scrubbing brush. In a few

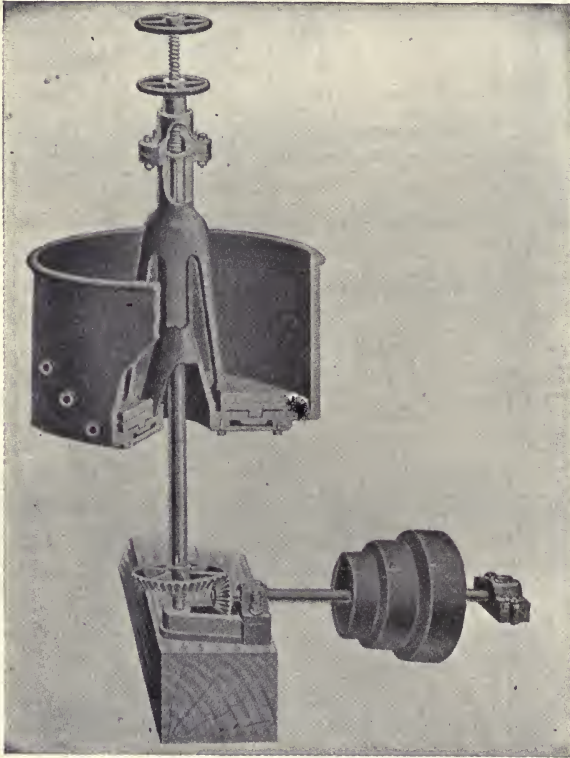

FIG. 89.—Clean-up Pan.

minutes this should be washed off, and potassium cyanide, then mercury rubbed on, and the plate washed clean. The stamps are now started, and feeding is resumed.

Apron-plates are set at a grade of  $\frac{1}{2}$  to  $1\frac{3}{4}$  in. per foot, the steepest grade where sulphides occur in the pulp. When properly flowing over the plate, the pulp travels down in a series of ripples, thus bringing the gold in contact with it.

A mercury-trap receives the flowing pulp at the foot of the plate.

Any non-adherent particles of amalgam are here caught. The amalgam is occasionally removed by the plug-hole on the bottom of the trap. Its overflow passes generally to the concentrating tables.

**The Clean-up.**—This occurs once or twice a month. Let us take the case of a 40-stamp mill. Two batteries are hung up. The screens, inside plates, and dies are taken out. The ore in the mortars, two or three bucketsful, are taken and fed to the next batteries. The inside plates are scraped and dressed, and all is replaced, and the batteries again started. The next two are treated in the same way as well as the last ones, whose mortar contains an accumulation from them all.

**The Clean-up Pan,** Fig. 89, 3 ft. diameter and making 12 to 15 R.P.M.,

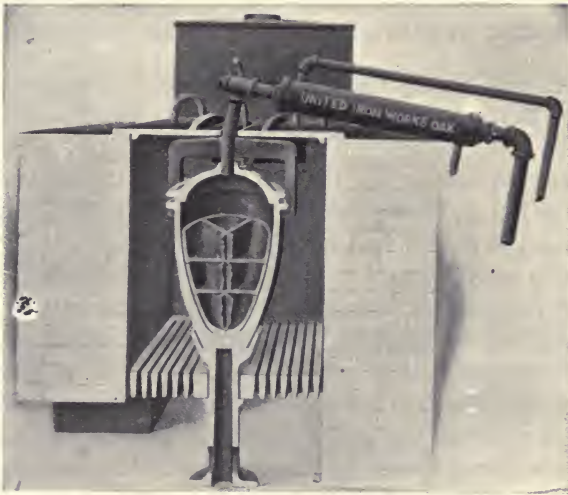

FIG. 90.—Vertical Retort.

is used for grinding the sand, pyrite, fragments of iron, etc., the accumulation of the last batteries. The charge, perhaps 300 lb., is wet-ground to a fine mud with the addition of 50 lb. of mercury during the shift. The pulp is diluted with water and the muddy portion is run off by a side plug. The residual mercury and amalgam with some mud is withdrawn through the lowest plug-hole, panned in a gold-pan by hand, treated with nitric acid, and well washed until clean. The residual amalgam is strained through canvas to remove the excess mercury. Gold amalgam thus treated contains 35 to 45 per cent gold; the filtered mercury still retains 0.5 per cent gold.

**Retorting.**—In the smaller gold mills the amalgam is retorted as shown in Fig. 90. The retort, filled two-thirds full of amalgam and the cover luted

and clamped, is placed in a wind-furnace, there supported on a cast-iron rest. A water-cooled pipe leads out from the cover, its lower end dipping in a tub of water. The retort is gradually heated, the mercury vapor comes over, and is condensed in drops in the water-cooled pipe and collects in the tub below. The retort is kept at a distilling temperature for one or two hours, then heated to redness to expel the last of the mercury. This mercury is used again.

The residue, taken from the retort, is porous and is from 500 to 900 fine in gold. It is melted in a wind-furnace, see Fig. 64, with soda and borax, and when it contains base metal, with an addition of a little niter, which serves to toughen it. The melt is poured into an ingot-mold and, after cooling, cleaned from adhering slag and shipped to the mint.

#### GENERAL ARRANGEMENT OF A GOLD STAMP-MILL

Fig. 91 indicates clearly the course of the ore through the mill, while Fig. 139, taken to the end of the concentrating tables, gives a general idea of such a mill.

Run-of-mine ore enters the mill at the highest level and is dumped into the storage bin *A*, thence it is withdrawn through a Blake ore-breaker *b*, which discharges to the feed-bin *C*. The feed-bin is filled during the day-shift, and is large enough to hold a twenty-four-hour supply. From the bin the ore is drawn off through a regulated sliding gate by chute to the suspended Challenge ore-feeder, and thus is in constant supply to the stamp battery, where it is crushed with an addition of mercury and of water. The pulp, splashing through the battery screens, flows over amalgamated plates *e*, where the gold is caught. The tailing from the plates unites in a launder and finally falls into a distributing box that commands four concentrating tables. A distribution is made here and one-fourth the flow is supplied by a launder to each table. The tailing from the tables is wasted. The concentrate is collected and shipped for smelting. The method of driving the machines is indicated in Fig. 88. Above the battery runs an overhead track carrying a trolley and a heavy chain tackle by means of which parts can be removed readily or replaced.

In practice stamps vary from as light as 850 lb. to as high as 2000 lb. as on the Rand, South Africa. Many stamps in American practice are of 1000 lb. though there are mills having them of 1250 lb. and 1500 lb. The tendency at present is toward superseding them by rolls or by ball-mills, or supplementing them by tube-mills. In such cases coarser screens are put in at the stamps, their duty is increased, and added work is put upon the tube-mills, which then grind in closed circuit with Dorr or Akins classifiers (see Figs. 29 and 30).

## CONCENTRATION IN STAMP-MILLING

*Methods.*—Three general methods of concentration are practiced: (a) removal of high-grade concentrates for shipment to smelters; (b) removal of lower-grade concentrates for local treatment by cyanidation, or

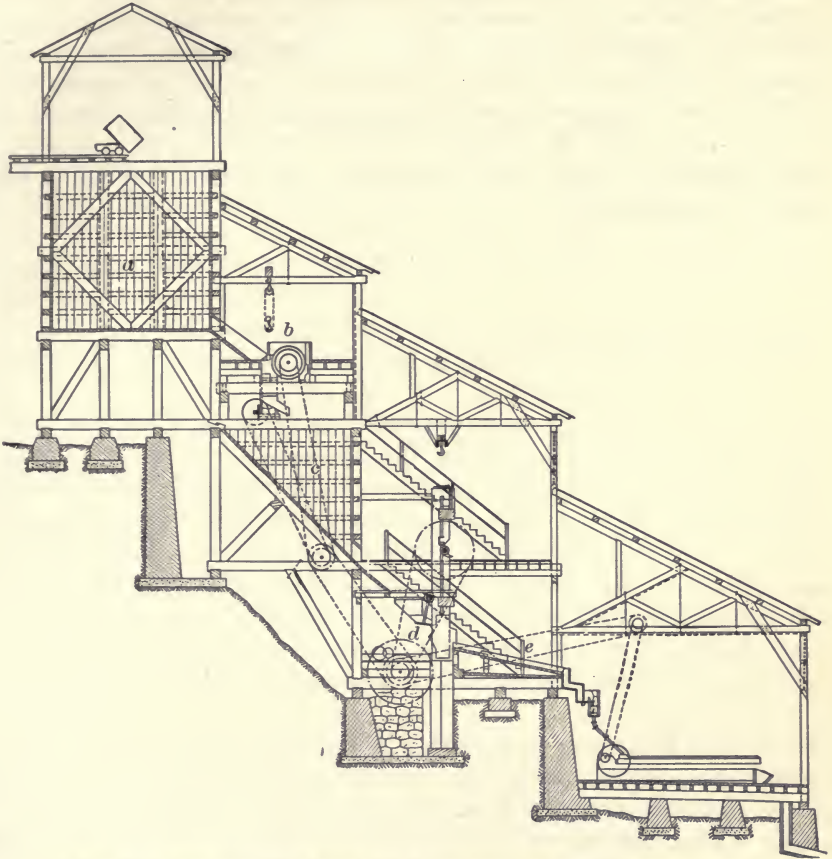

FIG. 91.—Stamp-mill followed by Amalgamation and Concentration.

roasting followed by cyanidation; (c) removal of concentrates for finer grinding and returning to the regular pulp.

*Systems.*—A very complete concentration system, on a complex ore, is carried out by the Goldfield Consolidated, where approximately 6 per cent by weight and 67 per cent by value of the feed is removed at a cost for concentration of 6 cents per ton of ore concentrated, the concentrates then receiving a very successful local treatment. On the 26-oz. silver ore of the San Rafael (Pachuca),  $1\frac{1}{2}$  per cent by weight and 22 per

cent by value is taken out as concentrate, to be shipped to smelter. On the high-grade Esperanza (El Oro) sulphide ores, concentration removed 1.2 per cent by weight, with 35 per cent of the gold and 16 per cent of the silver. Tonopah concentration removes approximately 15 per cent of the silver; Stratton's Independence removes approximately 44 per cent of the gold; Liberty Bell, 8 per cent of the gold and 20 per cent of the silver.

*Costs.*—The cost of concentration, per ton of ore concentrated, ranges from 5 to 15 cents—averaging perhaps 10 cents per ton. The apparent saving in the removal of refractory value and cyanides by concentration, is reflected by decreased cyanide consumption and solution contact, and by lower assay value of final plant residue. This must be carefully balanced against the higher cost of realization and mechanical loss in shipment of concentrates.

## CHAPTER XIII

### THE HYDROMETALLURGY OF GOLD ORES

#### MILLING ORES IN AQUEOUS SOLUTIONS

At the present time there are two methods by which gold is dissolved from its ore by chemical solvents. In either process the first step is to obtain the gold in aqueous solution, then to precipitate it from the clear filtrate, and finally to get it in the form of a bar or ingot.

The two processes are:

(1) *The chlorination or Plattner process*, by which the gold is obtained in solution as a chloride by the action of an aqueous solution of chlorine gas.

(2) *The Cyanide or MacArthur-Forrest process*, in which the solution of the gold is effected by a weak cyanide solution, the dissolved gold then being present as potassium auro-cyanide. With certain refractory ores, the activity of the solution is greatly increased by the use of bromine or bromo-cyanogen in addition to the potassium cyanide.

Extraction of gold by means of a solvent in aqueous solution is also practiced where gold cannot be completely extracted by amalgamation. This often is the case with pyrite ores; and extraction can be practiced to advantage, not only where amalgamation is unsuitable, but where smelting is expensive.

Gold in ore occurs in particles of various sizes, both as grains readily seen, and in particles of microscopic size. When the particles are visible, or when the ore shows "colors" upon panning, the gold is called coarse, and such particles generally can be recovered by amalgamation. Gold often occurs in finely disseminated, microscopic particles, not visible to the eye, and in films on the surface of pyrite crystals. If the ore can be ground so fine as to unlock the crystals, or if it is permeable to solutions, gold can be dissolved in aqueous solvents, such as chlorine or potassium cyanide. Advantage is taken of the solubility of the released gold particles, and leaching or percolation methods, in tanks or vats, are practiced with this in view. The solution soaks through the ore, comes in contact with gold particles, and dissolves them, or by another process, the finely ground ore or slime is agitated with the solution, and the pulp is filtered and washed in filter-presses. The clear filtrate, in any case, is treated by a

suitable precipitant to obtain the gold in small bulk, and the precipitated gold is melted and cast in the form of a bar or ingot for sale.

There are three stages in any method of extracting gold by aqueous solvents: (1) The ore is finely ground and when refractory, roasted, to convert the gold into a soluble form, and render it accessible to the solution. (2) The gold is extracted from the ore by means of a dilute solvent, using a tank with a filter-bottom, or agitating the ore, pulverized to a thin pulp, using a filter-press for the separation of the solution. (3) The gold in the solution is precipitated (*a*), in chlorination by hydrogen sulphide or other precipitating agent or (*b*), in cyanidation by the use of zinc-shaving or zinc-dust. The precipitate is collected, dried, and melted into an ingot.

Cyanidation has proved to be a remarkably cheap and efficient method of extraction, but it has limitations, not only in respect to the solubility of the gold, but because of the interference of compounds that sometimes are present, notably those of copper, that interfere with extraction in various ways. The process has the advantage over the chlorination method in that silver, as well as gold, can be extracted. Under favorable conditions the extraction is high, and modern methods have reduced the cost of treatment to a low figure.

Pyrite ore, exposed to the weather, becomes acid in reaction, and if treated by cyanide, decomposes and destroys the potassium cyanide. To correct this, the ore is first treated by a wash of dilute caustic soda or of acid mixed with caustic lime in sufficient quantity to overcome acidity, or to create "protective alkalinity."

When ore is refractory and requires preliminary roasting, this adds much to the cost of treatment. In chlorination, roasting is always necessary, and in any case it improves the condition of the ore and makes it porous and permeable when leached or filter-pressed.



## CHAPTER XIV

### (1) CHLORINATION OF GOLD ORES

This consists in attacking the gold in the roasted ore with chlorine to form the soluble gold chloride, and dissolving out the gold chloride in water.

#### ORES SUITED TO CHLORINATION

An ideal ore for chlorination is one in which the gold is present in a fine state of division, in which bases are absent that would be attacked by chlorine, and silver if present in such a condition as not to coat the particles of gold with insoluble silver chloride. While the cyanide process is better for the treatment of low-grade ores, many refractory high-grade ores have given better results by chlorination.

Ores in which the gangue consists of hydrated iron-oxide are extremely difficult to amalgamate. Not only is the gold finely divided, but the ore is slimy and forms a coating on the amalgamating-plates. Such ores give satisfactory results by barrel chlorination. Silver is not recovered by chlorination, since it becomes an insoluble silver chloride. If, however, sufficient silver be present to pay the increased cost, salt may be used in roasting and the silver extracted by means of sodium hyposulphite or better by cyaniding.

Ore containing sulphur, arsenic, and antimony is crushed to 10- to 30-mesh size, and is roasted to expel these elements, to oxidize the bases, to leave the gold in such form as to be attacked by chlorine, and to make the ore porous, accessible to chlorine, and more easily leached.

**Chlorination of Concentrate.**—This is used on concentrate from gold-milling, containing much sulphide, and typical of California ore. The coarse gold has been removed, by milling and amalgamation, and the concentrate, generally 1.5 to 2 per cent of the weight of the ore milled, contains gold in fine particles. It is roasted, generally in a long-bedded reverberatory furnace, see Fig. 70, 60 ft. long, and of 3 tons capacity in twenty-four hours. It contains copper, lead, lime, and magnesia, all of which consume chlorine, and form chlorides. To prevent this, it has been customary to add salt, to the extent of 0.75 to 1.5 per cent of the charge, at or near the completion of the roast. If roasting has been thorough up to this time, copper is present as  $\text{CuO}$ , lead as  $\text{PbSO}_4$ , lime as  $\text{CaO}$ , and magnesia as  $\text{MgO}$ . Were the copper present at the end as  $\text{CuSO}_4$  it would

react with the salt, forming a chloride of copper. The common salt also reacts upon the gold and forms gold chlorides. Both these chlorides are volatile, and the  $\text{CuCl}$ , in volatilizing, promotes the detrimental volatilization of the gold.

As long as sulphur is present it protects the gold from attack, but when sulphates have been formed, and are causing the abundant evolution of chlorine by reaction with the salt, the escaping gas carries gold chloride, the gold being unprotected by sulphur at the time of chlorination. Lead sulphate similarly reacts with salt, forming lead chloride, which does not consume chlorine. When much lead is present, however, it may be removed by leaching with hot water before treating with chlorine. Lime and magnesia are converted by the salt into chlorides, and in this form consume no chlorine. The process of roasting is therefore conducted as follows:

The ore is thoroughly roasted at a low-red heat. The temperature is a bright red ( $850^{\circ}\text{C.}$ ), to decompose copper sulphate. The salt is added and thoroughly incorporated, and the temperature reduced to prevent volatilization of the gold. The quantity of salt to be added, the time needed for roasting, and the temperature compatible with the minimum loss of the gold, should be determined experimentally for each kind of ore.

#### THE GOLDFIELD CHLORINE MILL CO., GOLDFIELD, NEV.

At this, the latest development of vat-chlorination, the ore of the 100-ton plant, crushed to 14-mesh, receives an oxidizing roast in a muffle type rabble-roaster, is cooled and moistened, and is then delivered to a storage bin. From the bin it is charged into any one of the seven wooden leaching vats, 22 ft. diameter by 8 ft. deep, by means of a 3-ton grab-bucket operated by a traveling crane. When full, a wooden cover is put upon the vat, and the leaching is done with a strong solution of 8 lb. of chlorine per ton of water. The filtrate from the vat is pumped to a solution-storage tank and is thence drawn to precipitating boxes (resembling the zinc boxes of a cyanide plant), where the gold is precipitated electrolytically. In these boxes are suspended anode plates of graphitized carbon and cathode plates of lead, the lead having been alloyed with 1 per cent of zinc, the zinc hastening the corrosive action. The resultant slime of the electrolysis consisting of lead, gold, and any silver, while still moist, is mixed with a suitable flux and made into briquettes. These latter are melted in a reverberatory furnace as rich lead bars, are refined in an English cupelling furnace, as described under "Refining Base Bullion," page 498. The pumps and piping of the mill are made of rubber to withstand the corrosive action of the chlorine.

**Making the Chlorine Solution.**—This is produced electrolytically from a

brine solution. The chlorine gas, arising from the electrolytic tank, passes to two sheet-iron stacks lined with glazed sewer pipe with cement between the pipe and the outer iron. Inside these is placed a filling of perforated hollow tile balls. Water is supplied to trickle downward through the balls, while the chlorine gas admitted at the bottom is absorbed by the water spread upon the extended surface of the balls.

BARREL CHLORINATION

This process was evolved as being better suited to large tonnages of ore than the vat process, and its flows-sheet is shown in Fig. 92.

An example of such an ore is that of Cripple Creek. The ore contains gold telluride, and must be roasted to release the gold from combination

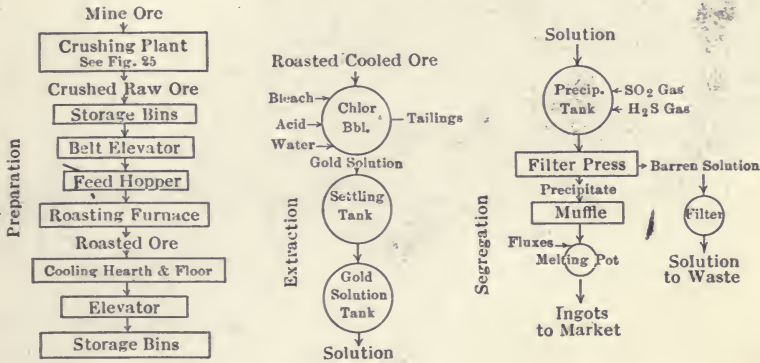

FIG. 92.—Flow-sheet of Barrel Chlorination.

with tellurium, and to expel all sulphur above 0.1 per cent. The complete process of barrel-chlorination is as follows:

**Crushing and Roasting.**—The coarsely crushed ore from any of the storage-bins is drawn off as needed to the feed-hopper of the dryer. It is dried and fine-crushed.

Cripple Creek ore is roasted in a mechanical furnace, such as the Edwards, Figs. 74 and 75. The finishing temperature should not be higher than necessary to break up the sulphates formed in roasting.

The cooled ore is raised by an elevator to storage-bins, whence it is drawn as needed to the chlorination barrels.

**The Chlorination Barrel.**—This is shown in perspective in Fig. 93, and in transverse and longitudinal section in Fig. 94.

Within the barrel for a filter a perforated 2-in. plank floor is used. On the perforated floor rests a lead sheet of 4 lb. per sq. ft. with 0.05-in. holes,  $\frac{3}{8}$  in. between centers. To hold down the filter-sheet, a wooden frame or grating is placed upon it. This is held by blocks *h*, and heavy

strips *i*, securely bolted to the barrel. The wood frames beneath last three months; those above, but two or three weeks. This wood-work, if immersed in boiling tar or asphalt until thoroughly impregnated, lasts longer and absorbs but little solution. The common size of barrel is 6 ft. diameter by 12 ft. long, and the capacity is 8.5 tons.

**Charging the Roasted Ore.**—Into the cylinder is run 800 gal. water, the charge of 8 tons and 8 lb. of liquid chlorine. Chlorine can be obtained in this form in strong steel cylinders or drums. The charge-openings of

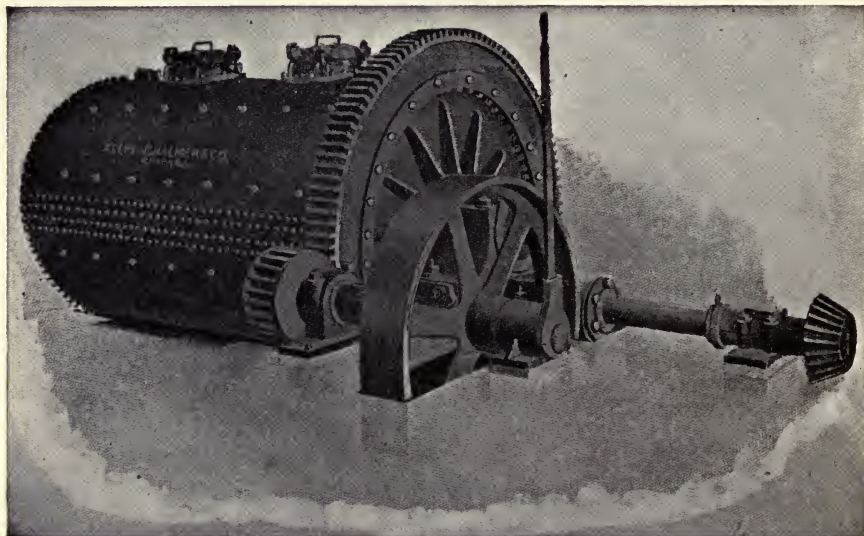
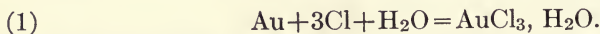

FIG. 93.—Chlorination Barrel.

the barrel are now closed, and it is rotated at the rate of 12 R.P.M. for a period of three hours. The chlorine roasts thus:



To see if the saturation with chlorine is complete the stopcock *j* is opened and the issuing gas is tested with ammonia, which produces a white fume with chlorine.

If needed the barrel is stopped and more chlorine is added.

The precipitate collects upon the bottom of the tank, and after several charges have been treated, the united precipitate is drawn off at *D* and delivered through the man-hole *L* into the pressure tank *z* by the hose *y*. The precipitating tank is then washed clean with the aid of a hose. The pressure-tank is 4 ft. diameter by 4½ ft. high. When charged the cover *L* is clamped in place, and compressed air, under a pressure of 40 lb. per sq. in.,

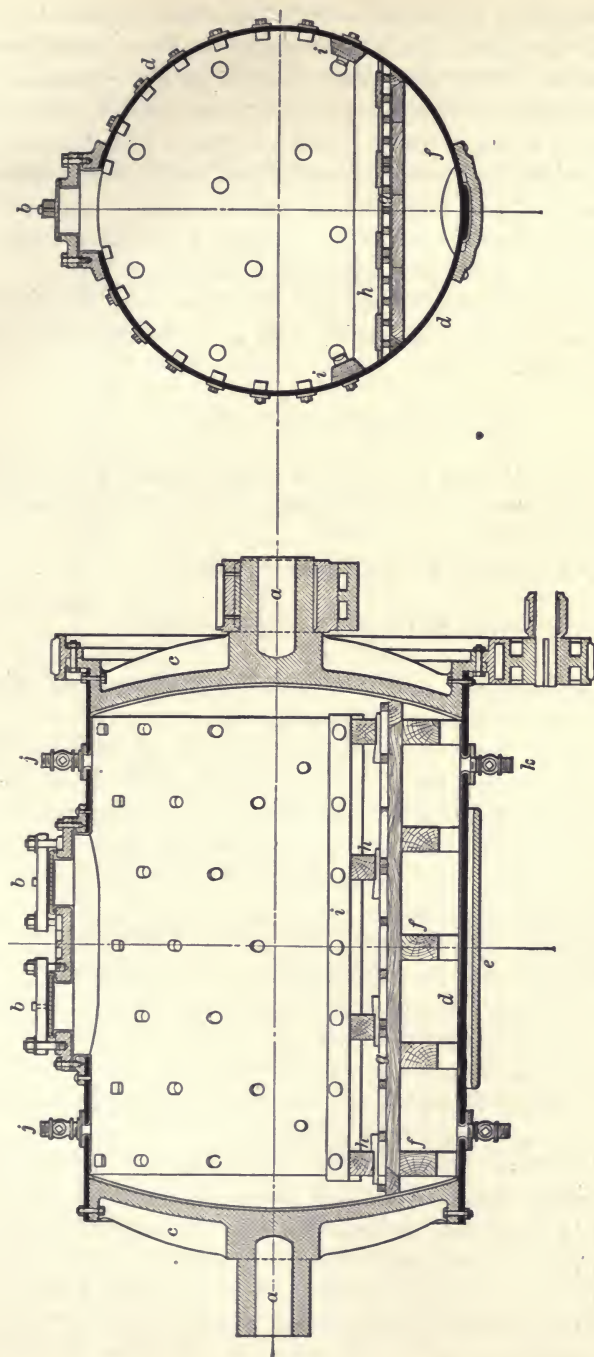
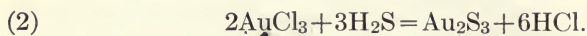

FIG. 94.—Sections of Chlorination Barrel.

is admitted through *t*. At the same time connection is made to the filter press *T* through the pipe *u*, and the precipitate collects in the press under the above pressure. This filter-press is more clearly illustrated in Fig 112. The filtrate from the press passes over a sawdust filter-bed, as a safeguard before it is run to waste. The sawdust is collected occasionally, and burned, to recover the small amount of gold which it may have caught.

The precipitate of gold sulphide also contains sulphur, and sulphides of arsenic, antimony, copper, and silver, forming a "sulphide cake." The press is next opened and the precipitate withdrawn.

Compressed air, entering by the pipe *w* and the valve *c*, drives the gas through the pipe *v* and the lead pipe *r* into the solution in the tank, and precipitates the gold as follows:



The gold is thus thrown down as an auric sulphide in a solution containing both sulphuric and hydrochloric acids. The reaction is rapid, taking about ten minutes.

At first,  $\text{H}_2\text{S}$  is oxidized by the chlorine, thus:



Sulphuric and hydrochloric acids are formed by the reaction, after which auric sulphide is precipitated as in Equation (2).

**Filtering.**—After being precipitated,  $\text{Au}_2\text{S}_3$  is allowed to settle two hours. The clear solution then is drawn off at *C*, 10 in. above the bottom of the tank, through the pipe *n* into the filter-press. This is done to recover any possible flakes of gold sulphide that failed to settle in the tank *x*. In three or four hours after precipitation, the tank can receive a fresh charge of gold-bearing solution.

After saturation with chlorine, the barrel is revolved for an hour, then stopped in position for filtering with the filtering floor down and level. The outlet pipe *k* is connected by a hose to the settling tank and opened; and water is pumped into the barrel above the charge through the valve *j*. The solution is now drained off, and the water above the charge forced rapidly through by means of compressed air introduced through the valve *j*. The excess of chlorine is absorbed by the wash-water, and does not enter the building. The operation of filtering is next suspended, connections are broken, valves closed and the barrel revolved a few times to mix the contents again, and to break up channels that may have formed during the leaching. The barrel is then stopped, water run in, compressed air admitted, and the washing resumed. This is repeated until no gold is found in the escaping filtrate when tested. The compressed air admitted is under a pressure of 40 lb. per sq. in. The time of filtering and

washing on an average is  $2\frac{1}{2}$  hours. The water used is 50 per cent the weight of the ore. All connections are finally broken, valves closed, and manholes opened, and the cylinder is revolved several times to discharge the contents. It is then washed out with a hose to prepare it for another charge.

**Concentration.**—The washed tailings are, before being discarded, sub-

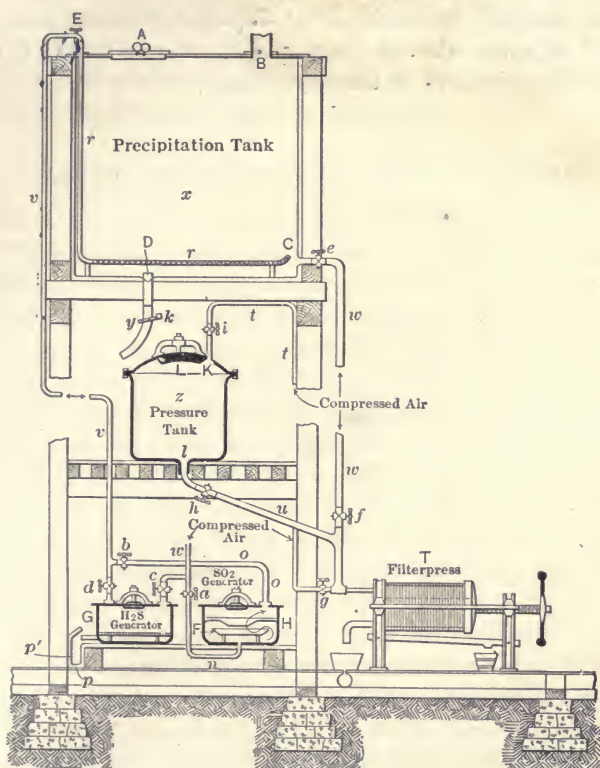

FIG. 95.—Precipitation Plant for Barrel Chlorination.

jected to a table concentration to recover any particles of unroasted sulphides or tellurides which would contain gold.

**Clarifying.**—The filtrate is run through a clarifying press and sent to the stock tanks. From this it is pumped through the opening *A*, Fig. 95, into the precipitation tank, *X*, which is 10 ft. diameter by 12 ft. high.

**Precipitation.**—We are now ready to precipitate the gold by passing in  $H_2S$ . To do this, the pipe *v* is connected to the lead-lined generator *G* which contains lumps of iron sulphide resting on a perforated lead false-bottom. Dilute sulphuric acid admitted below the false-bottom comes in

contact with the iron sulphide and abundantly generates  $H_2S$  according to the equation:

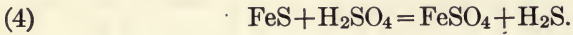

This method of treatment, successfully conducted at the Colorado Springs plant, was abandoned in favor of the cyanide method in 1912.

When the ore is refractory and requires preliminary roasting, this cost adds much to that of treatment. In chlorination, roasting is common, and in any case it improves the condition of the ore, and makes it porous and so permeable when leached or filter-pressed.



## CHAPTER XV

### (2) CYANIDING OF GOLD ORES

This is a hydrometallurgical method of treatment, that is, the gold is recovered in a weak water solution of cyanide.

#### GRAVITY CONCENTRATION PRIOR TO CYANIDING

This precedes cyanide treatment, on account of being more conveniently applied at this point, but in many cases it would be advantageous if it were feasible to have it follow cyanide treatment. When it precedes cyanide treatment, a considerable proportion of the readily soluble gold and silver may be removed in the concentrate, when it might be more advantageous to recover them as bullion. In the case of low freight rates and favorable smelter contracts this may be an advantage rather than otherwise; but for the majority of plants the more gold and silver turned out as bullion, the better. Therefore, the ideal practice in most cases would be to recover all the gold and silver possible as bullion by the cyanide process and then concentrate the tailing to recover as high a percentage of the remaining gold and silver which had escaped dissolution as feasible. Obviously there are many cases where the percentage of extraction of gold and silver from the residue leaves no margin for concentration.

At times concentration can be introduced into the cyanide flow sheet to advantage for the purpose of removing the minerals which are difficult, if not impossible, to treat by the regular milling scheme, so that they may receive the special treatment necessary without having to incur the expense of subjecting the whole tonnage to the special treatment made necessary by a comparatively small proportion of refractory minerals. On the other hand, the introduction of concentration adds to the first cost of the plant and the complexity of its operation, so that these disadvantages must be carefully weighed against the advantages which are likely to accrue.

#### OUTLINE OF THE PROCESS OF CYANIDING

The ore is crushed to such fineness that its contained gold is left open to the action of a weak solution of potassium or sodium-cyanide. The gold, brought into solution, is then precipitated from the clear filtrate and this precipitate melted into form of a bar or ingot. The gold in the

cyanide solution is present as potassium or sodium auro-cyanide. With certain refractory ores the solvent power of the solution is greatly increased by the addition of bromine or bromo-cyanogen.

Extraction of gold by cyaniding is successful, where gold cannot be completely removed by amalgamation. This is the case with pyrite ores, and such extraction can be practiced to advantage, not only where amalgamation is unsuitable, but where smelting is too expensive.

Practically all gold or silver ores can be treated by the cyanide process or by the cyanide process in combination with some other preliminary or accessory treatment, with the exception perhaps of certain ores containing a considerable amount of copper, lead, etc. In such cases, the desirability of recovering the base metals leads to smelting the ore upon either the lead or copper basis, and the necessity for hydrometallurgical treatment for the recovery of the gold and silver disappears since the precious metals are recovered by the smelting operation in connection with the base metals.

Cyanidation has proved a remarkably cheap and efficient method of extraction, but it has limitations, not only in respect to the solubility of the gold, but because of the action of certain compounds, notably those of copper, that are sometimes present and interfere with extraction in various ways. The process has the advantage over the chlorination method in that silver, as well as gold, can be extracted. Under favorable conditions the extraction is high, and modern methods have reduced the cost of treatment to a low figure.

**The Use of Hot Solutions in Cyaniding for Better Extraction of Silver and Gold.**—At the Belmont mill, Tonopah, the temperature at the stamps is  $60^{\circ}$  to  $70^{\circ}$  F., and by the use of exhaust steam at the Pachuca agitators, the pulp is raised to  $90^{\circ}$  to  $100^{\circ}$  F., resulting, as reported, in increased extraction over using cold solutions of 2 per cent. At the Montana-Tonopah mill crushing is done at  $50^{\circ}$  to  $60^{\circ}$  F., and by live steam in the agitator, the temperature is brought up to  $110^{\circ}$  F. It is found at this mill that when heating is not done extraction falls off, also that heat aids settling. At the MacNamara mill, Tonopah, the pulp was heated to  $115^{\circ}$  to  $120^{\circ}$  F., using live steam in the agitators, whereby, as compared with cold solutions the extraction increased and the time of agitation was lessened. Even as compared with a temperature of  $80^{\circ}$  an increase to  $120^{\circ}$  improved extraction by 1.5 per cent to 2 per cent. The cost of this heating may be reckoned at 18 to 30 cents per ton as against a saving at 2 per cent or 60 cents per ton on dollar silver. On gold ore savings are not so secured. At Kalgoorlie, Western Australia, where ores are roasted, the temperature, after mixing with solution, is as high as  $200^{\circ}$  F., but they prefer to cool the ore before mixing.

## ORES SUITED TO CYANIDATION

Dealing with gold-bearing ores, the following classes are amenable to treatment:

1. **Talcoses or Clayey Ores.**—When crushed, these produce a high percentage of slime, which is too fine for leaching, and gives trouble in any type of filter. Generally, the capacity of a plant treating these ores is not high.

2. **Free-milling Silicious Ores.**—These constitute the bulk of the ores treated by the cyanide process throughout the world. The gold may be fine or coarse, in the latter case being removed by amalgamation before subsequent cyanide treatment. It is not economical to dissolve coarse gold in cyanide.

3. **Pyrite Ores.**—Gold in this class is in most cases mechanically mixed with the iron pyrite, which when crushed, liberates the gold for the solution in cyanide. It has been found in several mining districts that it is possible to treat the pyrite mixed with the ore, no concentration being necessary; but in the majority of cases, it is found better to concentrate, and treat this product separately.

4. **Telluride Ores.**—These occur at Cripple Creek, Goldfield, Kalgoorlie, and other places, and while not complex, have given considerable trouble in treatment. Ordinary cyanide solutions are not effective on tellurium compounds, and the ore should be either concentrated and treated by ordinary cyanide or bromo-cyanide, or all the ore roasted, followed by the usual cyanide methods.

5. **Antimony Ores.**—Antimony is a troublesome mineral to deal with in gold extraction. It occurs in gold ores in Rhodesia to some extent, and in New South Wales. Roasting seems to be effective, while caustic soda solutions have helped cyanidation. Tailing containing antimony has been successfully treated in Australia with no special process.

6. **Graphite Ores.**—At Ashanti, West Africa, Kalgoorlie and Gympie, Australia, graphitic slate or schist is mixed with the ore, and while not containing a high percentage of gold it causes a premature precipitation of gold from cyanide solutions.

7. **Copper Ores.**—Many gold ores contain a low percentage of copper, and with care may be treated with a fair recovery. Copper gradually changes cyanide solutions, and then is precipitated on the zinc shaving, preventing a proper precipitation of gold. Copper in the resultant bullion with care may be refined.

8. **Arsenical Ores.**—A mineralized ore often contains a little arsenic, but pure mispickel, or arsenical pyrite, requires skill in treatment. The ore may be roasted after fine crushing, or concentrated, and the product roasted alone. Noted cases of mines producing this ore are at Bendigo,

in Victoria; the Lancefield and Transvaal mines, in Western Australia; the Deloro and Hedley in Canada. From the first mentioned group, the pyrite is roasted and treated by cyanide or chlorination; at the Lancefield both wet and dry processes have been tried on large tonnages; the Transvaal mine ore is very refractory; while at the Deloro, bromo-cyanide was used for several years. At the best, it may be said that such a gold-bearing ore is difficult to treat.

#### CHEMISTRY OF THE CYANIDE PROCESS FOR GOLD ORES

When a solution containing from 0.1 to 0.5 per cent cyanide is brought into contact with crushed ore containing very fine gold, this metal is easily dissolved. According to Elsner, the equation is as follows:

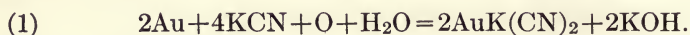

The gold is dissolved by the action of potassium or sodium cyanide in the presence of oxygen and water, forming an auric-potassic cyanide and caustic potash. Oxygen is needed to fulfill the requirements of the reaction, and consequently ore, or solution acting on ore, must be aerated in some manner. When oxygen of the dissolved air is consumed, action ceases, but resumes with a fresh supply of air. Oxidizing agents such as potassium chlorate and permanganate, and the peroxides of lead, manganese, sodium, and barium may be used to furnish oxygen in place of air, but have been found too expensive for practical use.

The inadequacy of this equation as a guide to consumption of cyanide is at once apparent in the treatment of complex ores, with their various constituents. The equation calls for 1.51 units of Au or 0.83 unit of Ag per unit of KCN. With many silver ores this relation is closely approximated, but with gold ores a consumption of 20 of KCN to 1 of Au is considered satisfactory, and 40 to 1 is more common. The mixed potassium cyanide salt (98 to 99 per cent KCN) has been quite generally supplanted by sodium cyanide (120 to 129 per cent, in terms of KCN). Subsequent references to cyanide will be in terms of 100 per cent KCN, although sodium cyanide is used.

When an ore containing pyrite is exposed to the weather, air and moisture slowly act on the mineral, with the following reaction:

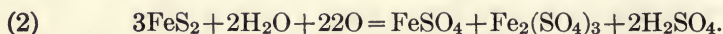

Ferrous and ferric sulphates and sulphuric acid are thus formed. The first two named would tend to precipitate gold. Ferric sulphate is acid in its reaction, and with sulphuric acid, if not neutralized, it would decompose and cause a serious loss of cyanide. Such compounds are called "cyanicides." Ore, therefore, which contains pyrite, and has been exposed to the

weather needs caustic soda or lime to neutralize the acidity, and an excess to provide for any acidity resulting from further decomposition. This excess is termed the "protective alkalinity." To remove the soluble ferrous sulphate and sulphuric acid, water-wash before treatment should be sufficient, but would require some time, so a certain quantity of lime is added. Lime is cheaper than and preferable to caustic soda, the latter making undesirable compounds, often noticed later in treatment. In some districts, the question of freight will decide which should be used. The action of lime is as follows:

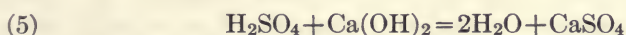
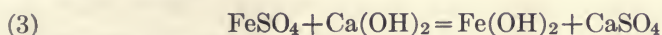

The result is the formation of a harmless iron hydroxide and calcium sulphate.

The reaction that takes place, when a gold-bearing solution comes in contact with zinc-shaving in the precipitating boxes, or when zinc-dust is mixed with it is:

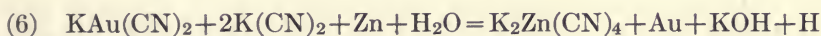

in which one part of zinc is computed to precipitate three parts of gold. The gold forms a brown or black precipitate and the zinc potassic cyanide remains in solution.

Cyanide is also used up by direct combination with the zinc as follows:

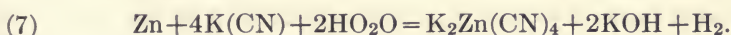

In both the foregoing reactions hydrogen escapes in bubbles.

When aluminum is used we have:

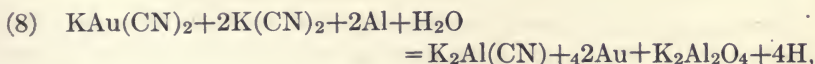

in which one part of aluminum precipitates 7.2 parts of gold.

The barren solution, from which the gold has been extracted, is used again in the mill, and accumulates impurities from ore that is being treated, and from the zinc with which it was in contact in the zinc-boxes. As a result, it gradually becomes less efficient than fresh solution. It has been found that, on adding lime to a cyanide solution, its solvent power upon a clean ore is increased, but not on a sulphide ore. Such a solution, if treated with sodium sulphide to the point of exact neutrality, and with a small

excess of lead acetate, and given time to permit the resultant sulphide to precipitate, is improved in dissolving power as follows:



The cyanide is here regenerated, while the zinc sulphide separates. This is a means of overcoming the accumulation of zinc in solution, which is one of the drawbacks to the use of zinc for precipitation, compared with electrical deposition. Chemicals, however, are not indispensable for disposing of the zinc. In Elsner's equation, caustic potash is set free. This reacts upon the sulphides in an ore, forming soluble sulphides, which in turn react like the sodium sulphide in the reaction above, precipitating zinc sulphide from the ore.

The following minerals and chemical compounds destroy or combine with cyanide, and render it incapable of dissolving gold: Copper in the form of sulphate, carbonate, copper glance, erubescite, or copper pyrite. (The sulph-antimonites of copper are without action.) Manganese as "wad" (impure hydrous oxide), but not the carbonate or oxide; zinc as smithsonite, but not blende or zinc silicate.

Graphite, which is found in certain ores, also carbon remaining in burned lime, both interfere with extraction by causing a premature precipitation of gold. Also leaves, roots, and other organic matter act in the same way.

It has been found that gold thus prematurely precipitated is soluble in a solution of sodium-sulphide, this being added when leaching the sands after practically all the cyanide has been displaced by a water-wash. Precipitation of the gold is effected by passing the  $Na_2S$  through boxes filled with copper shaving; but little copper going into solution.

To increase the activity of zinc shaving in precipitating gold, it may be dipped in 10 per cent lead acetate solution, or a drip of the latter may be fed in at the head of the zinc-boxes. This forms a zinc-lead couple, which reacts electrically on the gold solution. Both potassium and sodium cyanide, 98 and 128 per cent pure, are used with varied results, the latter being rather more favored as a dissolving agent.

The cyanogen contents of potassium and sodium cyanide respectively are about 38 and 51 per cent, so for the same weight of salt there is the extra percentage of cyanogen, a consideration where freight is costly. Commercial cyanide contains small quantities of alkaline sulphides, whose presence diminishes the solvent power of the cyanide. It pays, therefore, to buy the salt on a guaranteed analysis.

**The Concentration of the Cyanide Solution** is a vital point. In general, the stronger the solution, within certain fairly well-defined limits, the more rapid the dissolution, and, furthermore, the less the interference of a given percentage of impurity which might be present in solution. On the other hand, a greater proportion of impurity may be dissolved by the stronger

solution. In the case of a plant which is operating at forced capacity a stronger solution may be used to advantage in order that the maximum extraction may be attained under this condition of operation. Stronger solutions may result in increased cyanide consumption, although the magnitude of this loss in a properly operated plant is not so great as has been supposed.

However, in a plant where there is considerable mechanical loss of solution the additional cyanide loss would prove an important factor. For this reason a strong solution is not generally favored when continuous decantation is used. The tendency in some cyanide plants has been to use a lower concentration in cyanide than that capable of giving the highest economical result. This probably is through the fear of excessive cyanide loss.

**The Bromo-cyanide Process.**—Tellurides of gold and silver are practically insoluble in plain cyanide, but are soluble in bromo-cyanide solutions. The latter process was first used on a large scale in 1899 at the Hannans Star mill, Kalgoorlie, which was mainly a customs plant receiving many shipments of rich telluride ores. The process involved is commonly known as the Diehl.

The bromo-cyanide solution is made according to the following equation:

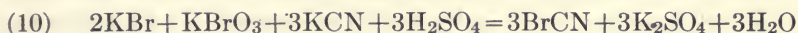

Its action in the treatment vat is supposed to be as follows:



The first two quantities in Equation (10) are contained in the mixed salts having about 40 to 44 per cent Br as KBr, and 20 to 22 per cent Br as KBrO<sub>3</sub>; the proportion of Br as bromide being about twice that of Br as bromate. A 30-lb. charge is usually made up, 50 lb. of 63 per cent H<sub>2</sub>SO<sub>4</sub>, 20 lb. of KCN of 93 per cent and 36.8 lb. of mixed salts as above given.

The solution is made in a closed wooden vessel, holding about 200 gal., stirred by rotating arms. In making up a charge, a portion of the water and all the H<sub>2</sub>SO<sub>4</sub> are first mixed, and allowed to cool to normal temperature. The KCN, which is dissolved in a separate vessel in sufficient water to fill the mixing vessel, is then run in, and at the same time the proper weight of "mixed salts" is gradually added. The whole is then agitated for six hours before being used, and in a closed vessel it will retain its strength for some days. The cost of a 30-lb. charge of BrCN is about \$21.60.

Experiments have shown the following points necessary for good work:

1. The daily ore sample should be taken in the morning, and assayed

as soon as possible, so that the value of the ore passing to the vats in the previous twenty-four hours may be determined.

2. The pulp should have a long KCN treatment.

3. A vat should be kept under KCN treatment until the value of the KCN residue is known.

4. The alkalinity of the vat should then be determined and corrected to 0.01 per cent by  $H_2SO_4$  before adding BrCN.

5. The quantity of BrCN added should then be determined from the value of KCN residue, and the tonnage of the vat.

6. The lime added to the ore during crushing should be varied according to the alkalinity-test after KCN treatment, so that the plant-solution tests about 0.02 per cent.

7. Lime water should be made and added to the vats or to the solution from the presses, instead of adding lime to the vats.

8. Metallic iron should be kept out of the pulp as far as possible, as it is both a cyanicide and a bromo-cyanicide.

In operation, a vat, when full, was given its charge of KCN, and three hours afterward a "dip" KCN residue was taken, and the charge of BrCN solution added. After a total agitation of twenty hours a quantity of lime was added, and the vat-charge "pressed." The quantity of BrCN added was varied according to the residue of preceding vats, and the value of the ore being treated as shown by the daily ore-sample. Each charge of bromo-cyanide was totally destroyed. In places where fuel and furnace supplies were expensive, this chemical process would show a decided advantage. The process requires more metallurgical skill and constant attention to the progress of each vat under treatment; but, if this is available, the results are highly satisfactory, and the process has definite claim to be a cheap and efficient method of treatment for such ores as the Kalgoorlie sulpho-tellurides.

#### THE STANDARD SYSTEMS OF CYANIDATION

These may be divided into three as follows:

1. **Sand leaching**, where the whole ore pulp after grinding is classified into two products, sand and slime, the sand being sent to percolation tanks for leaching; the slime or fine product being filtered or decanted to yield a pregnant solution and a solid residue.

2. **Filter slime treatment**, where the whole pulp is ground fine and filtered to yield a pregnant solution and a solid residue.

3. **Slime Agitation**, where the whole pulp is ground fine and agitated for a considerable period, then by countercurrent decantation yields a pregnant solution and a barren or nearly barren residue that is thrown away.

Practically the "sand" is the portion of the pulp treated by percola-



tion or leaching; while the balance is considered to be slime and is treated by suction or pressure filtration.

With the important exceptions of the Rand and the Homestake the earlier practice of sand leaching, that is of comparatively coarse grinding and treating the sand and slime separately has largely given way to the present practice of (2) filter slime treatment or (3) slime agitation (both "all-sliming" treatment) the pulp being finely ground and treated as a single product.

Referring back to the so-called **sand leaching**, the pulp, rather coarsely ground, is classified in cone classifiers such as the Caldecott giving a sand for percolation and a slime such that 90 per cent of it will pass 200-mesh (0.0029 in.).

In **all-sliming plants** the pulp varies from 60 to 90 per cent through 200-mesh, depending on the economical limit of fine grinding, and subsequent treatment. In sand and slime plants, crushing is almost universally done in water, while with all-sliming, crushing in cyanide solution is almost universal.

#### (1) SAND LEACHING

**Separation of Sand from Slime.**—This is an interesting problem, and is performed either to furnish from the pulp a sand for fine grinding or again to make two products, sand and slime, the sand to be leached into vats, the slime to be separately treated. The machines used in separating the sand from the slime and their principles of operation are fully described under head of "Classifiers."

**Leaching the Sands.**—Cyanidation was first applied to the recovery of gold in accumulated tailings from stamp-mills. In South Africa this material still containing \$3.50 per ton, was impounded or retained behind dams until cyaniding could be undertaken. The tailing was shoveled into cars and hauled to large leaching vats. Here the ore was leached with weak cyanide solution, the gold precipitated from the filtered solution by passing it through boxes containing zinc shavings. The precipitate was treated, melted, and obtained in form of gold ingots or bars. This practice, as long as the impounded tailings lasted, was quite simple, but it has been abandoned with the exhaustion of those accumulations.

**Description of Vats.**—Leaching vats are constructed with filter bottoms and may be made of wood or steel. In warm countries, like Australia, South Africa and Mexico the steel vat is preferred; but in cold countries, where it is necessary to house the plant, the wooden vat gives satisfaction. The latter is cheaper in first cost and easier to set up, though the wood absorbs gold solution. The steel vat, on the other hand is less liable to leak, but should be painted. A wooden vat, also, when requiring it, should be painted. In Western America wooden vats predominate.

Fig. 96 is a perspective view of a wooden vat with the filter-cloth omitted. This shows the false-bottom of slats and the hinged bottom-discharge opening through which the exhausted tailing is shoveled or sluiced

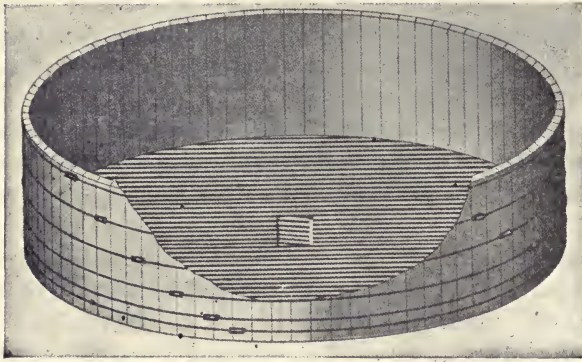

FIG. 96.—View of Wooden Leaching Vat.

out. A wooden ring, 2 in. high and  $2\frac{1}{2}$  in. thick, is nailed to the bottom of the vat, leaving a space of  $\frac{3}{4}$  in. between it and the side. Parallel strips, 1 in. high, are nailed a foot apart upon the bottom, and across these 1- by

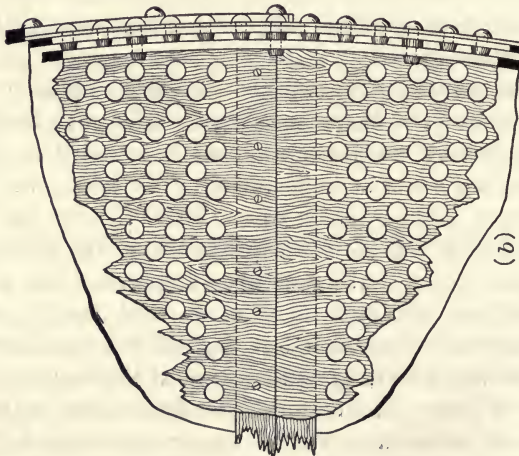

FIG. 97.—Plan of Steel Leaching Vat.

4-in. strips or slats are laid with 1 in. space between. Upon this false-bottom cocoa-matting is spread, and over it 8-oz. canvas filter cloth cut 12 in. larger in diameter than the vat. The edges of the cloth are held

down by a rope laid upon the canvas and driven into the  $\frac{3}{4}$ -in. space between the staves and the wooden ring.

Figs. 97 and 98 represent in plan and in elevation respectively, the construction of a steel vat having a perforated board bottom. A ring of flat iron  $\frac{1}{2}$  by  $2\frac{1}{2}$  in. is riveted to the side of the vat, with spacethimbles to hold it  $\frac{3}{4}$  in. from the side. The cleats that sustain the false bottom are 2 in. high by  $1\frac{1}{2}$  in. wide. The 1-in. bottom-boards are bored with  $\frac{3}{4}$ -in. holes and screwed to the cleats. As in the case of the wooden vats, the thick stiff cocoa-matting is laid upon the false-bottom, and covered with a filter-cloth of 8- to 10-oz. canvas. The edges are calked with  $\frac{3}{4}$ -in. rope into the  $\frac{3}{4}$ -in. space, as shown at *g* in the sectional view, Fig. 98.

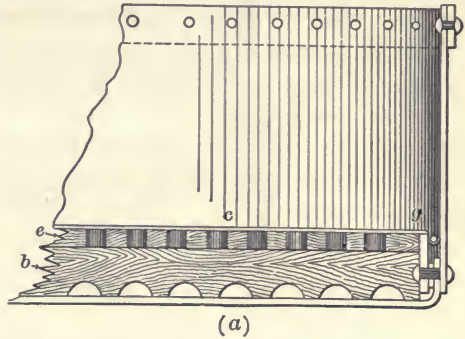

FIG. 98.—Section of Steel Leaching Tank.

Leaching vats vary in size from 16 to 50 ft. in diameter and 4 to 9 ft. in depth. The shallow ones are for the more finely ground sand.

Leaching vats vary in size from 16 to 50 ft. in diameter and 4 to 9 ft. in depth. The shallow ones are for the more finely ground sand.

**Double Treatment.**—Fig. 99 shows the two steel vats or intakes used in this system as practiced in South Africa. It consists of an upper or settling vat 40 ft. diameter by  $7\frac{1}{2}$  ft. high to which the sands are conveyed to be spread out and to receive a preliminary leaching, and of a lower or leaching vat 12 in. deeper. Both vats are carried on a steel structure for access both above and below. When the leaching is sufficiently completed in the settling vat, then seven bottom doors or valves are opened and the material is shoveled into the leaching vat beneath, 40 ft. by  $8\frac{1}{2}$  ft. high. When thus again handled, the tailings become more bulky, and more open and even for leaching. Here leaching and washing is completed. The exhausted tailings are then withdrawn at the discharge openings similar to those of the upper tank, and trammed away to the waste dump.

**Leaching the Sands.**—While transferring the sand from collectors to leaching-vats, lead acetate, previously dissolved in water ( $\frac{1}{2}$  lb. per ton) is added and slacked lime (4 lb. per ton) is thrown into the collecting vat, thus thoroughly mixing the lime with the sand. After transferring, a little shoveling is done to level the sand. The first leaching solution, amounting to 30 tons, is brought up to 0.25 per cent strength by the addition of a sufficient amount of potassium cyanide solution of known strength to the vat under treatment. This amount of strong solution is allowed to drain slowly through the partly opened drain-valves and is followed by repeated washings of weak solution from 0.15 to 0.20 per cent, after which

the charge is drained for transfer. This first treatment occupies five days, including time of the latter.

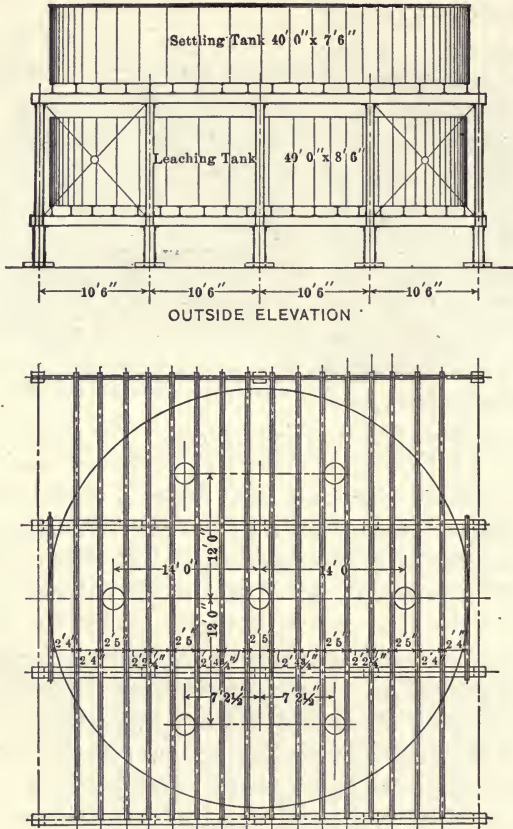

FIG. 99.—Vats for Double Treatment.

SIZING TEST ON SAND RESIDUE

	Screen Mesh.	Percentage.
Remaining on.....	20	0.15
Remaining on.....	30	11.64
Remaining on.....	40	13.98
Remaining on.....	50	12.31
Remaining on.....	60	10.48
Remaining on.....	80	17.54
Remaining on.....	100	12.77
Passing.....	100	21.05
		99.92

The second treatment averages five days and consists of repeated washings of strong and weak solutions, that are drained off, and the sand transferred to another vat for the final treatment, which consists of as many washes of wash solution as there is time to apply, followed by two or three of water to displace all the solution. Then the vat is finally drained by vacuum for discharging from the plant. Each charge of solution is allowed to disappear below the surface of the sand before the succeeding one is applied. Sand undergoes treatment for twelve to fifteen days.

All leachings from the sand vats, as well as the plant solutions, are sampled, assayed, and titrated for cyanide and alkalinity daily. Attenuated leaching solutions are sent direct to weak sumps. Centrifugal pumps, when not pumping to treatment-vats, are in service circulating solution in sumps through cones, Fig. 58, for the purpose of aërating.

All potassium cyanide used in the treatment of sand, is dissolved in a small vat from which a 2-in. pipe-line is connected to the suction of a 4-in. centrifugal pump used to pump solutions on sand. By means of a table and float arranged on the vat, the desired strength of solution can be obtained by opening the 2-in. line and allowing the requisite amount of standard solution to be drawn through the pump with the weak solution from the weak sumps.

The Rand is the greatest present-day exponent of sand leaching, comparatively few plants in other parts of the world retaining separate sand and slime treatment. The important improvements made in fine grinding and the handling of slime created a marked tendency toward all-sliming and the abandonment of sand leaching, this trend, in a few instances resulting in inadequate consideration of the question of highest commercial recovery versus theoretical extraction. A few all-sliming plants, after careful research and consideration, have found it advisable to revert to the former sand and slime practice. But even in the strongholds of sand leaching, the present day trend is toward finer grinding and a gradual reduction in the proportion of total mill pulp treated by percolation.

The removal of the residue from the leaching tanks, which now range up to 70 ft. diameter by 12 ft. deep, is accomplished by sluicing, shoveling, or mechanical excavators, the method depending on local factors such as cost and abundance of water, and labor and storage requirements. A recent trend in the method of sand-residue disposal has been to sluice the sand into dewaterers, or classifiers, from which it gravitates under ground, for stope filling. The destruction of the cyanide present in the residues is accomplished, where necessary, by the addition of some 0.08 lb. of  $\text{KMnO}_4$  per ton of sand. Since its introduction on the Rand, sand filling of stopes has been very advantageously adopted in other countries

**Rand Metallurgical Costs.**—In this practice, the following comparison of the cost per ton for transferring drained sand from tank to tank is: (a)

by truck haulage, 3.96 cents; (b) by shoveling and conveyor belt, 3.36 cents; (c) by shuttle belts and main conveyor belts, 2.44 cents.

In offering sand-leaching cost-data, it may be well to cite the working of a few representative plants. Again, it must be noted that no comparisons are here intended, local conditions being at too great a variance. Fifteen Rand plants show that an average of 57.6 per cent of the mill pulp is leached as sand by double treatment, the proportion ranging from 70 per cent sand in the older plants, to 40 per cent sand in recent plants. The economical limit of fine grinding of the sand approximates 70 per cent through 100-mesh (0.0058-in. aperture). With intermittent collecting, revolving distributors are preferred to hose-filling. The transfer of the drained sand to the treatment tanks is by truck-haulage, or by shoveling, in cases where the collectors or settling tanks are set above the treatment tanks. With continuous sand-filter collecting, the collected sand is transferred by conveyors or pumped to revolving distributors. The residue is discharged by belts, trucks, buckets, or sluicing into cone-dewaterers for sand filling of stopes. The total ratio of solution to sand for dissolving and washing approximates 1.5 to 1. About four days are allowed for collecting and draining and seven to eight days for treatment. Approximately one ton of solution is precipitated per ton of sand. The strong solution is about 2 lb. KCN, while the weak is about 0.5 lb. KCN.

Figures from ten Rand plants for 1912, with daily sand tonnage running as high as 3500 tons, show the following averages:

Total cost of sand treatment per ton of sand (including classification, collecting, treating, precipitating, refining and residue disposal), ranging from 37 to 45 cents, average.....	39.8 cents
Average extraction on \$3.17 sand heads.....	79.8 per cent
Average extraction in recent sand plants.....	89.5 per cent

**Costs of Rand Plants.**—The capital expenditures for various capacities of plants, per ton of sand treated per twenty-four hours, are as follows: 350 tons of sand per day, \$264; 700 tons, \$254; 1400 tons, \$244; 2800 tons, \$233.

Estimated capital costs of sand plants using continuous sand-filter collecting, yielding 55 per cent sand, are given as follows: 275 tons of sand per day, \$230 per ton of daily sand capacity; 550 tons of sand, \$212; 1100 tons of sand, \$195; 2200 tons of sand, \$177.

**Cost of Homestake Plant.**—The actual combined cost of the two Homestake sand plants, of a total capacity of 2500 tons, amounted to \$255 per ton of daily sand capacity. This figure includes power, heating, precipitating, and clean-up plants.

## (2) FILTER-SLIME TREATMENT

**Decantation.**—As largely practiced on the Rand, the slime is settled in slime collectors, large cone-bottom tanks provided with outlets for the escape of the water, and in adjustable decanter, all the slimes settling to the bottom of the cone. The settled slime, containing approximately 50 per cent of moisture, is then sluiced out by aid of a weak cyanide solution and is pumped to the "first settlement tank." Here the charge is kept in agitation by means of a circulating pump which withdraws from the bottom of the tank to discharge at the top. The charge when sufficiently agitated is allowed to settle and the gold-bearing solution decanted, then precipitated at the zinc boxes. The settled charge of slime in this tank is transferred to the second settling tank with addition of weak cyanide solution, and after settling and decanting of the supernatant solution, the thickened slime is discharged, using for that purpose sufficient fresh water. Settlement is aided by the judicious use of lime. This method, while simple and inexpensive, has the drawback that there is an inevitable loss through the imperfect washing, though for low-grade ores such loss is inconsiderable.

**All-sliming.**—Except in the case of certain low-grade mines, such as the Rand and Homestake, the earlier practice of comparatively coarse grinding, then treating the sand and slime separately has largely given way to the practice of finer grinding and treating the entire pulp. "All sliming" is the term applied to this. Where a separate sand slime treatment has prevailed the two products have been separated by classifier, the slime of such fineness that 90 per cent of it will pass a 200-mesh screen. In the all-sliming plants the pulp varies from 60 per cent to 90 per cent through 200-mesh, depending upon the economic limit of fine grinding and subsequent treatment. In the sand-slime plant the grinding is done in water, while where all-sliming prevails, this is done in cyanide solution.

## (3) SLIME AGITATION

This is done for the purpose of bringing the slimed ore intimately in contact with the cyanide solution and with air according to Elsner's reaction.

The matter of proper dilution at which pulp should be agitated is one demanding careful consideration for each individual plant. Experimental work points to high dilutions, but practical considerations generally necessitate as thick a pulp as can be regularly drawn from the thickeners. A dilution of 1.5 to 1 is, perhaps, an average. Inasmuch as the cost of agitating a ton of slime for twenty-four hours should not exceed 3 cents, it is evident that the agitation period, to be commensurate with this low cost,

should be well advanced toward the point where further dissolution ceases. In determining the proper length of agitation, such items as capital charge on the agitators and accessories, consumption of cyanide, lime, and other chemicals, possible premature precipitation of dissolved metals in prolonged agitation, and the mechanical cost of agitating, should be carefully balanced against the net returns from the metals dissolved. Then, too, the possibility of decreasing the fineness of grinding by prolonging the agitation should be examined.

The modern trend is in favor of continuous agitation, as compared with the former intermittent system. Change of solution during agitation is found advisable with certain ores; although with present-day agitators, capable of giving ample aëration, the entire agitation step is frequently carried out in one stage.

The types of agitators may be divided into (1) *pneumatic*, (2) *mechanical*, (3) *combined mechanical and pneumatic*, (4) *pump transfer system*.

#### (1) PNEUMATIC AGITATORS

These include the Parral and the Pachuca (or Brown). The latter is an efficient machine for concentrates, but in the majority of cases the cost of pumping the pulp into these tall tanks is one serious thing against them. It is also costly to erect.

**The Pachuca or Brown tank**, shown in Fig. 100, consists of a steel cylinder ordinarily 30 ft. high and 10 ft. in diameter, terminating below in a cone having an angle of  $60^\circ$  at the vertex. Vats 60 ft. high and 15 ft. in diameter are being constructed in some mills. In the lower part of the cone there is a 6-in. pipe with a gate valve for discharging the contents of the vat after treatment. The apparatus in the interior of the vat consists of: (1) A central 10-in. tube called the elevator. (2) A pipe for compressed air passes through the center of the elevator and rests on the bottom of the cone. This pipe is closed at the bottom end, but has a number of small holes in it at the level of the bottom of the elevator tube. These holes are covered by a section of rubber hose slipped over the pipe and having its lower end tied to the pipe with wire just below the holes in the

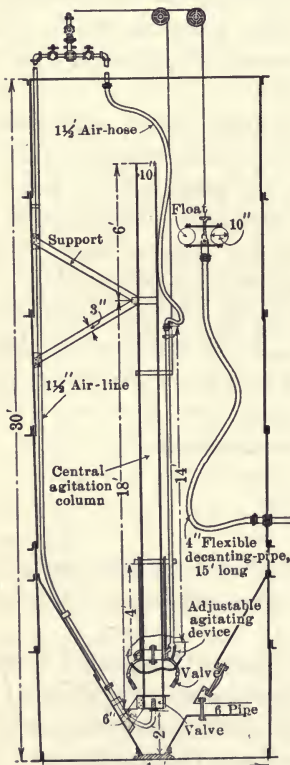

FIG. 100.—Pachuca Tank.

pipe, so that the hose forms a sort of collar valve through which the air



may escape into the vat, while the pulp is prevented from entering the pipe. When the pressure of air in the pipe is greater than that due to the column of slime in the vat the air escapes through the collar valve and passes up through the end, but has a number of small holes in it at the level of the bottom elevator tube, carrying the slime with it. (3) Another air pipe with its collar valve is placed outside of the elevator to keep the slime in circulation during the filling and emptying of the vat. (4) An adjustable agitating device consisting of an annular pipe having several small pipes with collar valves so arranged that compressed air, water, or solution may be forced through them in order to wash off any sand or slime which may have deposited on the sides of the cone after the agitation has been stopped.

The method of operation to cause the agitation or circulation of the slime in these vats is very simple, being as follows: When the vat is filled with pulp and solution, the valve is opened, admitting compressed air into the bottom of the elevator where it mixes with the pulp in the elevator, and as this mixture is lighter than the pulp in the vat, it rises to the top of the elevator and overflows into the vat, while another portion of the slime in the vat enters the elevator at the bottom which in turn is raised to the top and overflows, thus obtaining a perfect and continuous circulation of the pulp as long as the compressed air is allowed to enter. Upon starting the circulation the air pressure must be greater than that of the column of slime, but as soon as the circulation is well established less pressure is required, it having been found in practice that while 50 lb. pressure is required to start the circulation, as soon as the sand and slime which have settled in the bottom of the cone have been cleared out by the scouring of the circulating pulp, the circulation may be maintained by a pressure of but 25 lb. per square inch. The quantity of air required in any particular case depends on the proportion of sand to slime, the fineness of the pulp, and the viscosity of the slime. Ordinarily, in the Pachuca plants, 100 cu. ft. per minute is used to maintain a vat containing 100 tons of slime in active circulation and to prevent the settlement of the sand on the sides of the cone bottom, but in the Goldfield Consolidated plant, Nevada, and at the Komata Reefs, New Zealand, only 30 cu. ft. per minute is used.

## (2) MECHANICAL AGITATORS

**Mechanical Agitators.**—For the agitation of heavy sulphides we have the old mechanical agitator with plowshoes revolving at 16 to 18 R.P.M. Much power is required to operate it.

Top-drive paddle-arm stirrers or agitators were used from the start of the slime-agitation process, and with proper design, still hold a fair place at this day. The bottom-drive agitator, as used in Kalgoorlie, Mexico,

and the Rand, eliminates the submerged step bearing of the top drive, allows of a simpler overhead construction, and due to the increased rigidity of the drive, operates with very moderate power. Assuming a tank 30 ft. diameter by 12 ft. deep as an approximate standard, a satisfactory agitating speed for the bottom drive type may be given as 8 R.P.M. and the power as 6 H.P. In addition, the power for furnishing 20 cu. ft. of free air per minute at 10 lb. pressure, for requisite aëration, amounts to 1 H.P. This type of agitator works quite satisfactorily, although it is troublesome to start up after a protracted shut-down, tends to bank up near the center and gives *en masse* agitation. Inclined baffle-boards bolted to the side of the tank will materially assist agitation.

The average erected cost of a 30×12-ft. bottom-drive, steel-tank, mechanical agitator may be given as \$2395. Such a tank will have an available depth of 11 ft. 6 in., and, with pulp at a dilution of 1.5, will hold 134 tons of dry slime, making the total erected cost \$17.87 per ton of dry slime capacity.

**Agitation of the Slime.**—By fine grinding even microscopic particles of gold have been set free from the gangue or waste. These particles can be dissolved provided they can be brought intimately in contact with the cyanide solution in presence of air. This is done by agitation, preferably using an air jet for so doing. In this way the solution is well circulated and is brought in contact with each particle of the slimed material as ordinary stirring or mixing will not do. Even then the solution of the gold particles takes hours of time, and agitation is continued until assay shows that further dissolution has ceased.

### (3) COMBINED MECHANICAL AND PNEUMATIC AGITATORS

These include the Dorr, the Trent, and the Hendryx machines. The Dorr agitator appears to be the cheapest in first cost, requires less power, and will operate with the least amount of trouble. It is well suited for a concentrate, ground to pass a 200-mesh screen. The Trent and Hendryx machines are not well suited for heavy sulphide material.

**Dorr Agitator.** This comparatively new type of agitator, combining mechanical and pneumatic agitation, has met with merited success. It is usually operated at 3 R.P.M., the speed depending, of course, on the character of the pulp. Under average conditions, a 30×12-ft. Dorr agitator will require about 1.5 H.P. for moving the arms, at 3 R.P.M., and 2.5 H.P. for furnishing 30 cu. ft. of free air per minute at 20 lb. pressure, a total of 4 H.P. The total erected cost of such an agitator with steel tank will approximate \$2510. With an available depth of 11 ft. 6 in. and with pulp at a dilution of 1.5, this agitator will hold 134 tons of dry slime, making the total erected cost \$18.73 per ton of dry slime capacity.

Fig. 101 is a view of this tank. In a flat-bottom steel tank is a central vertical cylinder or pipe carried by a shaft supported from the top of the tank and having two stirring arms with plows as in the Dorr thickener. The plows both agitate the pulp and draw it toward the center. The pulp is raised through the cylinder by means of air, supplied under pressure from an air pipe whose nozzle points upward at the foot of the vertical cylinder. The pulp, rising through the cylinder, is delivered by two opposite launders attached to the cylinder by which it is distributed over the surface of the liquid contents. A continuous supply of fresh pulp enters at the intake at the left, and is distributed through the tank, and after thorough agita-



FIG. 101.—The Dorr Agitator.

tion and aëration, escapes by the outflow on the right. Thus we have a method of continuous agitation which has its advantages over agitating in charges.

#### AGITATION TREATMENT

Dilution or ratio of solution to dry ore in the pulp undergoing treatment is generally recognized as a factor to which proper attention must be paid if the highest extraction is to result. If a higher dilution is used than is necessary the capacity of the plant is cut down, and, on the other hand, if the dilution be too low the maximum extraction is not attained. It is quite impossible to give general figures for minimum dilution as these figures vary for different ores. In general, lower dilutions can be used with gold ores than with silver ores, probably on account of the greater weight of metal to be dissolved in the latter case. Other conditions being equal, it appears that lower dilutions can be used with the Pachuca agitator than

with the mechanical agitator on account of the greater proportion of air brought in intimate contact with the pulp.

**The time of treatment** depends upon the character of the silver and gold minerals and upon their degree of comminution, and, as previously pointed out, also upon the concentration or strength of the solution in cyanide. It therefore follows that finer grinding, or increase of the cyanide concentration of the solution, or both, will in general result in reducing the time of treatment necessary. In cases where the cost of power is high, and as a consequence the cost of fine grinding would be excessive, the ore may be ground to the point where the minerals are liberated from the gangue and then separated into sand and slime, the slime being treated by agitation followed by either decantation or filtration. The sand containing the coarse mineral particles requiring a long period of contact for dissolution can be given the long period of contact necessary at a reasonable cost by leaching. Cases of this kind clearly indicate where combined sand and slime treatment can be employed to advantage.

**Thickening the Slime.**—As a preliminary adjunct to any filter operation, the pulp is first settled to a minimum moisture content; in average practice this will be found to approximate closely to 50 per cent, or equal parts of liquid and solid. In some plants this thickening is all done prior to dissolution, while in others, thickeners are used, both before and after the agitation.

For filtration, the moisture should be reduced to such a point that the heavier particles will remain in suspension, or at least settle very slowly during the cake-forming period. This governs the uniformity of the cake and is one of the most vital points in all filter operations, and since the size of the largest particles is, in turn, governed by the limits of economic grinding, the required buoyancy is best obtained by proper thickening.

The use of the Dorr continuous thickener has become almost universal for this work in America, and is being largely adopted in foreign countries as well. The machine requires a minimum of power and attendance, and when used in conjunction with a diaphragm pump or air lift, for elevating, the discharge may be operated with practically no loss of mill head. Discharges as low as 33 per cent moisture are obtained in the Porcupine district, but on other ores careful attention may be needed to obtain 60 per cent.

On the Rand, with colored labor at \$0.75 or less per day, and power at \$5.50 per H.P.-month, it is still found economical to retain the large intermittent settlers. These are steel tanks, varying from 50 ft. to 70 ft. in diameter, with from 10-ft. to 14-ft. sides and cone bottoms, giving an additional depth of from 4 to 8 ft. Peripheral overflows and adjustable decanting arms are provided, and the tanks are emptied by sluicing the settled slime into the suction of a centrifugal transfer pump.

This system of settling or dewatering is particularly well adapted to African conditions, where flat open mill sites are used, and where all tanks

are unhoused. But it is to be noted that while the intermittent settlers on the Rand, particularly during the warm summer months, frequently settle down to 40 per cent, and even to 38 per cent, moisture, the best that continuous thickeners seem able to do is 50 per cent. Since the extra 10 per cent of water must be brought up to treatment strength in cyanide, and then wasted, its elimination is highly desirable. With any settling equipment satisfactory moisture figures are seldom attained during the winter months, when 60 per cent is more nearly the average figure, with, of course, the higher losses in cyanide and in gold.

The area required for proper continuous setting is, of course, mainly a function of the nature of the ore and the dilution of the pulp and varies from 4 to 15 sq. ft. per dry ton of daily capacity with a pulp feed of from 90 per cent to 75 per cent moisture.

With intermittent settling as practiced on the Rand, the period required for discharging introduces an additional time factor, and it is usual to allow 14 to 25 sq. ft. per ton of dry slime. It should be noted that, in this practice, practically all the water used in crushing and classification goes to the slime collectors, which thus handle a feed containing from 90 to 95 per cent moisture.

The cost of thickening operations will vary from \$0.005 to \$0.02 per ton milled, depending upon local conditions and the scale of operations.

Naturally, there is no standard size recommended or used, as this depends on the capacity desired, settling qualities of the pulp, density to which thickening is to be carried, clearness of overflow, alkalinity, temperature, and dilution of the feed. As a general rule, it may be stated that approximately 6 sq. ft. of tank area are needed per ton of granular slime per twenty-four hours, while 10 to 15 sq. ft. should be allowed for flocculent slime. Several installations in different localities show an average of \$2500 for the complete erected cost of a standard, steel, 30×12 ft. unit. In terms of tonnage of dry slime handled per twenty-four hours, the capacity of a 30×20-ft. standard thickener, under normal conditions, may be given as 125 tons of granular slime and 65 tons of flocculent slime, making the erected cost of the thickener \$20 and \$38.46, respectively, per ton of daily capacity.

**The Dorr Continuous Thickener.**—As shown in Fig. 102, this 30×12-ft. tank has a slowly moving central vertical shaft with radial arms equipped with plows to bring the thickened settled material to its discharge point at the center. The thick slime discharge is pumped to another tank for further treatment. The feed launder delivers to a central drop pipe so as to cause no agitation. The clear solution escapes to the peripheral launder of the tank and thence overflows. The vertical shaft will revolve about once in twelve minutes.

Fig. 103, a sectional elevation of this thickener, shows its operation.

The feed of this pulp at the center of the tank, the overflow of clear liquid at the periphery and the discharge of thickened pulp are continuous. There are four zones of settlement. At the top is a zone of clear water *A*, beneath this is zone *B*, consisting of flocculated pulp of uniform consistency;

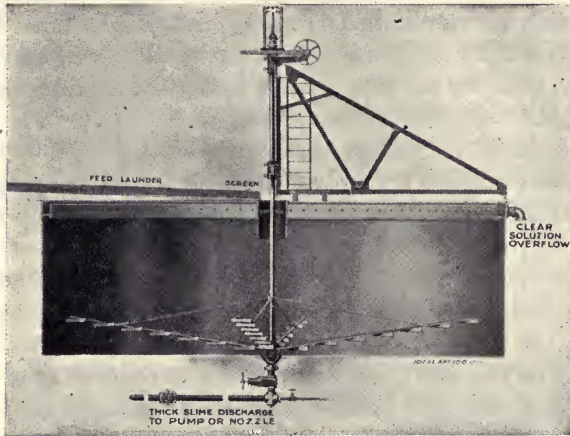

FIG. 102.—The Dorr Continuous Thickener.

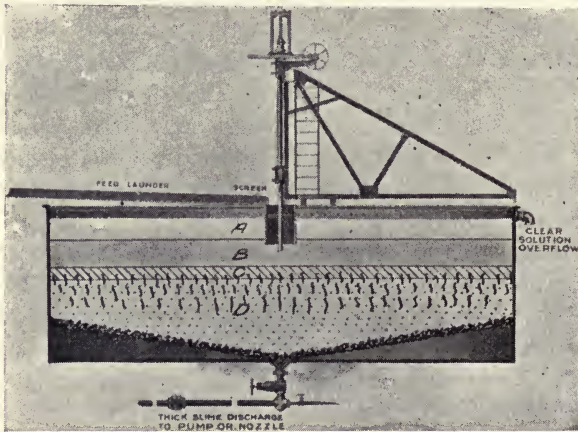

FIG. 103.—Dorr Thickener, Showing Slime-settling Zones.

directly beneath this is a transition zone *C*, and at the bottom a zone of pulp which is undergoing compression. The pulp in zones *B* and *C* is termed "free settling."

#### CONTINUOUS COUNTER-CURRENT DECANTATION

This method of separating dissolved values from treated slime, by means of a series of Dorr continuous thickeners, is becoming very popular in

America, particularly in small plants, and more especially in those treating a granular product, which readily settles to 40 per cent moisture or less and is amenable to treatment with very low cyanide strengths.

In operation, the slime passes through a series of tanks, the thick underflow of each being diluted with solution overflowing the second following thickener of the series. The solids thus move constantly in one direction, while the solutions travel in the opposite direction. Water, in quantity sufficient to replace the moisture finally discharged with the tailings, is added at the final thickener. The solution, traveling successively toward the head of the series and mixing with constantly richer pulp, is finally used in the crushing department, whence it overflows the first, or primary, settler and is sent to precipitation. The tanks are generally set so that solutions gravitate throughout the series, and the necessary elevation of the thick underflow is made either with diaphragm pumps or with air lifts.

In most plants where continuous decantation has been successfully used, underflows of 35 to 40 per cent moisture are usually maintained and solution equal to from four to six times the weight of the ore is clarified and precipitated. Under these conditions, the recovery of dissolved metals is excellent, but the loss of cyanide is higher than with filters.

This mechanical loss of cyanide is recognized as one of the principal factors limiting the use of continuous decantation without filters, where even moderately strong solutions are used. Solutions of less than  $\frac{1}{2}$  lb. per ton KCy are seldom precipitated in American practice, and at this strength, the mechanical loss in the final residue will vary from  $\frac{1}{4}$  lb. to as high as 1 lb., depending on underflow moistures. In milling silver ores, there will be an additional loss, owing to the fact that dissolution of the metal continues as long as the slime is in contact with solution.

The actual operating cost of the thickeners is very low, and the simplicity of the plant, enabling labor and supervision to be reduced to a minimum, must appeal strongly to operators of small plants.

As a most interesting adaptation of continuous decantation and vacuum filtration may be cited the practice at the recently enlarged Hollinger mill at Porcupine. Small thickeners, operating as classifiers, separate the tube-mill product into amorphous and granular. The former is thickened and sent to a vacuum filter for washing, without other agitation than that obtained in grinding, pumping and thickening.

The granular portion is concentrated, thickened, agitated, and then sent to counter-current decantation tanks for washing. This system eliminates amorphous or colloidal material from the bulk of the tonnage, where a very thick underflow is imperative, and, at the same time, furnishes a satisfactory product for the filter.

This is now known as the C. O. D. system. The flow sheet of it, shown in Fig. 104, illustrates the method where there are four Dorr thickeners.

W, X, Y and Z in series. It is assumed that the crushing is done in cyanide solution, the overflow from the thickening Tank X, being returned to the mill for mill solution. The ground pulp enters tank W, whose overflow, called the pregnant solution, goes to the next step in cyaniding, the precipitating of the gold from the solution. After having here deposited its gold content the solution, now called "barren," is used to dilute the underflow of thickener X, as it enters tank Y. The overflow of thickener Z is also mixed into the feed to Y, receiving also water for washing its pulp, which is then sent to waste. The overflow from Y meantime enters X, together with the partially exhausted thickened pulp from W. It is thus seen that pulp passes from tank to tank from left to right, losing more and more of its gold, to be discharged and exhausted from Z; while the wash-water flowing into Z picks up an increasing load of gold as it encounters the progressively richer pulp in its passage to the left. It finally leaves W at its full possible strength.

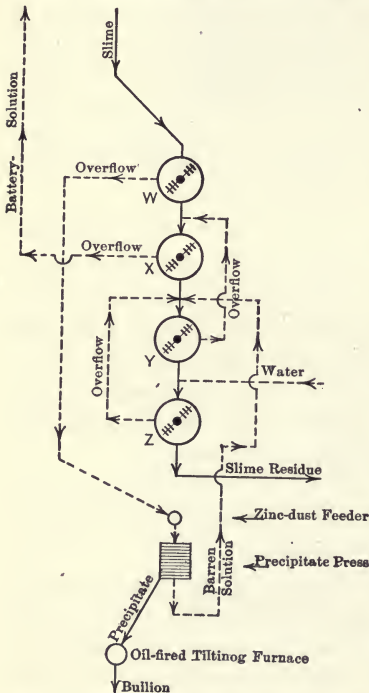

FIG. 104.—Continuous Counter-Current Decantation.

This method is best adapted to low-grade, easily leached and settled ores, and it dispenses with agitation other than that resulting from the crushing and classifying and the movement through the thickeners, and likewise with filtration about to be described.

At the Hollinger mill, Porcupine District, Ontario, Canada, where some 50,000 tons of a soft quartz ore with schist and pyrite is treated monthly, there are five sets of 40-ft. tanks as just described. The tanks are arranged with a difference of elevation of  $2\frac{1}{2}$  ft. between the steps, the last of the series Z, being the highest so the solution flows from tank to tank and to precipitation. Thence it is pumped to the mill-solution feed-tank. The cost of decanting is given at 2.09 cents and the tailings carry 9.75 cents per ton.

At the Hollinger mill, Porcupine District, Ontario, Canada, where some 50,000 tons of a soft quartz ore with schist and pyrite is treated monthly, there are five sets of 40-ft. tanks as just described. The tanks are arranged with a difference of elevation of  $2\frac{1}{2}$  ft. between the steps, the last of the series Z, being the highest so the solution flows from tank to tank and to precipitation. Thence it is pumped to the mill-solution feed-tank. The cost of decanting is given at 2.09 cents and the tailings carry 9.75 cents per ton.

#### FILTRATION OR SEPARATION OF METAL-BEARING SOLUTION FROM SLIME RESIDUE

Probably the most vital point in the practical application of the cyanide process is the filtration or separation, after dissolution, of the metal-bearing solution from the slime residue. Certainly no other point has called forth such a combination of inventive ingenuity and practical ability



as has been expended in developing a satisfactory technical and economical solution of this problem.

The reason for this is readily appreciated when one stops to consider that for every unit of dissolved metal finally discharged with the residue, there is incurred a net loss equal to the market value of the unit plus the mechanical loss of cyanide, amounting to a further \$0.05 to \$0.10 per ton. Since filtration or decantation is almost the last step in gold and silver production, and amounts at most to 5 per cent of the total cost, there is obviously every incentive to obtain the highest possible efficiency.

The amount and character of this material produced will depend chiefly upon the nature of the ore and upon the degree of comminution necessary to obtain an economic extraction. Many so-called "all-slime" plants find it feasible to agitate and filter, or decant, a product of which fully 40 per cent will remain upon a 200-mesh screen, while others grind to a point where only a fraction of 1 per cent will remain upon this mesh. The governing factors are purely individual, such as size and nature of plant, location, character of ore, etc., and can hardly be generalized.

All ores after fine grinding may be classified into two products—granular and amorphous, and most of the difficulties experienced in slime filtration and decantation may be traced to extreme conditions as regards either the one or the other.

An undue amount of coarse, granular material will not only increase the power consumption in the agitators and thickeners, but will also choke and cause frequent interruptions, and unless filtered at 50 per cent moisture, or less, will result in classification and uneven washing.

On the other hand, where the percentage of the amorphous product is high, it is seldom possible to thicken to less than 60 per cent moisture, even with a very large settling area, and a pulp of this dilution will not give economic results with either continuous or intermittent decantation, and even for filter treatment requires a largely increased area and frequently results in slow and imperfect washing. Cracks and channels will also develop with any type of filter in which the cake is exposed to the air before or during washing.

It may be safely stated that for ideal slime-washing results with any of the methods now in vogue, an all-slime product should fulfill the following conditions.

It should be ground in closed circuit with suitable classifiers so that not more than 25 per cent of the total product will remain upon 200-mesh screen and all of the metallic or sulphide portion will pass the same aperture.

It should settle from 85 per cent moisture to at least 50 per cent with a continuous settling area of 6 to 10 sq. ft. per ton of dry solids per day.

The various processes and machines now in use include 95 per cent of the slime tonnage produced in the cyanide process throughout the world.

## MAIN SYSTEMS OF FILTERING

1. **Thickening.**—The Dorr continuous filter; settling tanks.
2. **Vacuum Filtration.**—Butters, leaf; Moore, Oliver, drum; Portland, drum; Ridgway, leaf; American, continuous suction.
3. **Pressure Filtration.**—Merrill sluicing plate-and-frame press; Dehne, plate-and-frame-press; Kelly, enclosed-leaf; Burt, revolving cylinder; Sweetland.
4. **Continuous Decantation.**—Dorr system.
5. **Intermittent Decantation.**—Rand system.

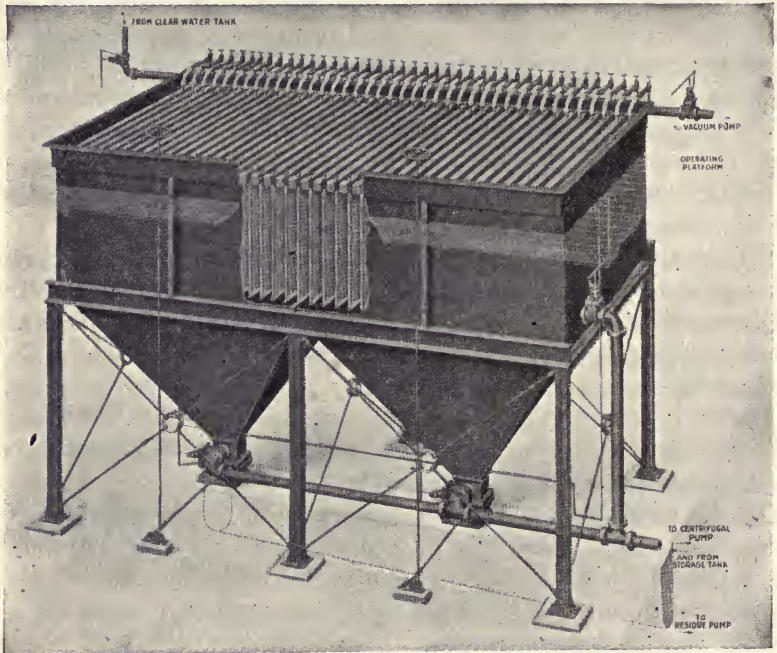

FIG. 105.—The Butter Vacuum Filter.

## (2) VACUUM FILTRATION

**The Butters Vacuum-leaf Filter.**—Fig. 106 is an elevation and Fig. 107 a view of a filter leaf on which a layer of slime has been built up and part of it removed to show its thickness. A vacuum filter plant consists of several filter tanks (see Fig. 105) with vertical sides and a V-shaped bottom, in which are suspended a number of filter-leaves constructed of pipe, with either cocoanut-matting, wooden laths, or ripple iron as a support for a cloth which is sewn around and covers the whole as shown in Fig. 106. Leaves vary in construction and 5 by 9 ft. is a handy size. Connected with the vats is suitable piping and centrifugal pump of large capacity for filling and emptying with slime, wash-solution, or water as desired. In operation, the filter vat is filled with pulp

to a point over the top of the filter leaves, and a valve opened connecting the vacuum pump directly with the filters. Clear cyanide solution is drawn from within the filter leaves and delivered to a clarifying tank for precipitation, the slime remaining as a cake on the outside of the filters. The filters are kept submerged by refilling the vat at intervals, and jets of air are introduced at the points of each hopper to keep the slime in suspension. When a cake 1 in. to 1½ in. thick has been formed, the surplus pulp is pumped back to the stock pulp vat, and the box is then filled with solution to wash the cake. During the time of forming and washing the cake, the vacuum is maintained at the highest possible point, but when the cake is exposed to the air during the transfer of pulp and wash solution the vacuum is reduced to 5 in. to prevent the cake cracking. It is possible to form a cake with some ores in five minutes, while others take up to ninety minutes.

Sufficient wash solution, about 2 tons per ton of slime, is drawn through the cake by the vacuum pump to effect a complete displacement of the original valuable solution. A portion of this solution goes to the clarifying tank before precipitation. When the wash is complete, the vacuum is disconnected, and a flow of solution or air is introduced into the interior of the filters, causing the cakes to drop. The mass of thick sludge remaining in the vat is diluted with water and agitated with air for a few minutes to make a homogeneous pulp of 1 to 1, which is then pumped to the residue pond. Typical cycles of operation are as follows:

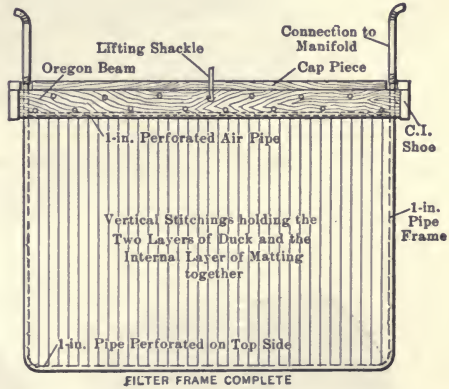
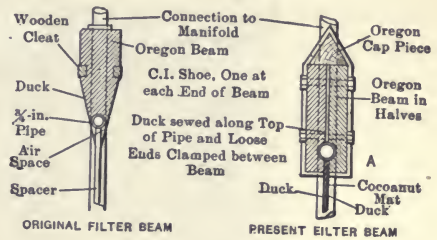

FIG. 106.—Butter's Filter-frame.

	Rand Ore.	Tonopah Ore.
Filling vat and forming cake, minutes.....	45	85
Transferring pulp and solution, and wash .....	70	95
Discharging.....	20	15
Total, minutes.....	135	195

The Oliver continuous revolving filter as shown in Fig. 108 consists of a drum or cylinder with open ends, rotating on a horizontal axis, with the lower portion submerged in a tank containing the pulp to be filtered. The surface of the drum is divided into compartments or sections, the



FIG. 107.—Slime-cake partly removed to show section.

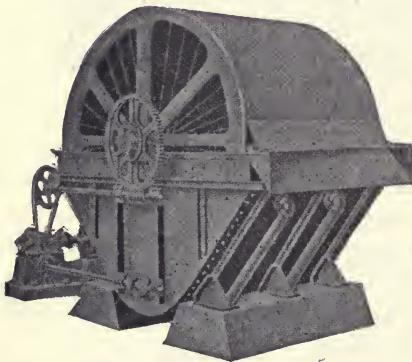

FIG. 108.—Oliver Filter.

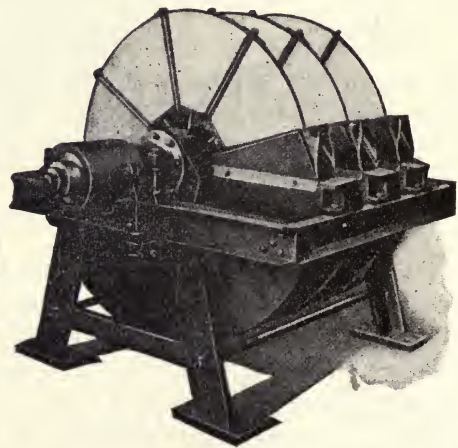

FIG. 109.—The American Filter.

divisions running parallel to the shaft. These sections are covered by a screen, and a filter medium is stretched over it, being held in place and protected from wear by a wire winding. Each section of the drum is connected by two pipes passing through a hollow trunnion to an automatic valve which controls the application of the vacuum for forming and wash-

ing the cake, and the admission of air for its discharge. A scraper is fitted across the tank and rests on the wire winding so that the washed cake is removed when released by air. Vacuum filtration costs vary from 5 to 10 cents per ton.

**The American Continuous Suction Filter.**—Fig. 109 shows a view of a three-disk filter and Fig. 110 an end view. Each disk is made up of eight segments. At one end of the shaft is a distributing valve having eight openings, each to one of the eight segments. The valve housing has three inner recessed ports. Port No. 1 on the underside connects to the filtrate suction line and applies suction to the four submerged leaf-segments. Port No. 2 connects with the wash-water suction and drying line, taking

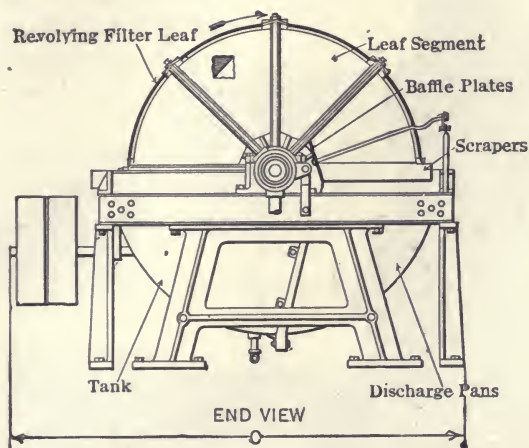

FIG. 110.—End View of "American" Filter.

care of the three upper left-hand leaf segments. Port No. 3 admits compressed air to a segment as it passes this port. The air is admitted for a few seconds only, inflating the filter cloth of the segment and loosening the formed cake thereon, while the scrapers remove it so that the product drops into a hopper or conveyor below.

### (3) PRESSURE FILTRATION

Both the Kelly and the Dehne presses have been extensively used. They have the advantage over the suction filters that high pressure can be carried, since against 10 lb. suction in the one we can carry 50 lb. or more in the pressure filter. This makes for quick filtering and washing.

Dehne presses are used extensively for concentrate in Western Australia and at Waihi, New Zealand. Three-in. cakes are formed at 40-lb. pressure and are washed satisfactorily.

**The Kelly Filter.**—Fig. 111 shows a twin unit of a filter, the right-hand unit open for discharging the washed precipitate. Into the closed unit

at the left the pulp is pumped filling the cylinder around the filter leaves as seen at the right-hand unit. The escaping solution through pipes that connect to each leaf is discharged to a launder. This continues until a thick cake has been built up on the leaves. The excess of unfiltered slime is run out and fresh water is introduced to wash the caked accumulation. To discharge, the front head of the

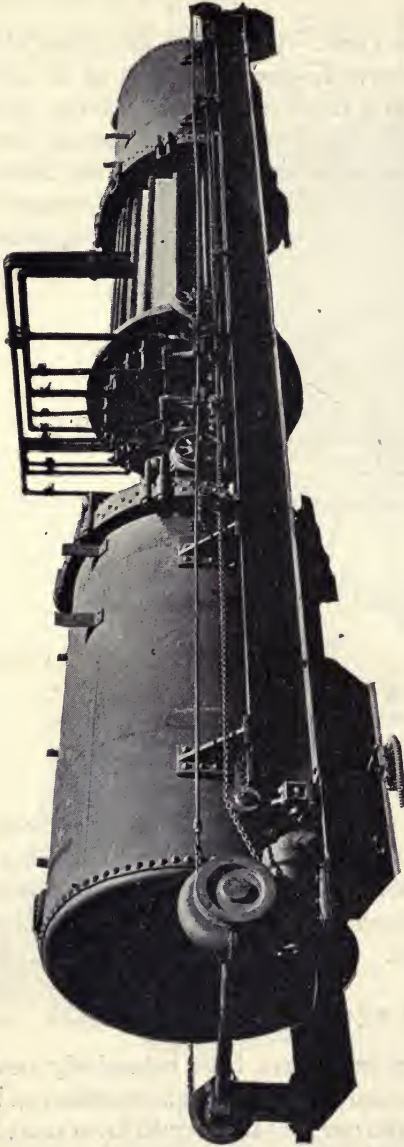

Fig. 111.—Perspective View of Kelly Filter Press.

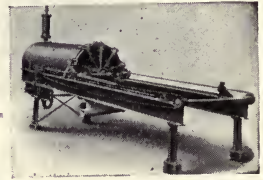

FIG. 112.—Single Kelly Filter Press.

press is unlocked, and the head with the attached carriage which sustains the filter leaves is run out, as shown in the right-hand unit, this unit by the same movement being closed and locked. The cakes are dislodged by inflating the filter leaves with air. The carriage is run into the cylinder and the head again automatically locked in place.

The Kelly press is used at the Goldfield Consolidated and the Alaska Treadwell with satisfactory results.

**The Rectangular or Dehne Filter Press.**—This, as shown in Fig. 113, consists of a heavy frame carrying forty filter leaves 42 in. square, one standing at the left leaning against the press and forty filter frames, one of

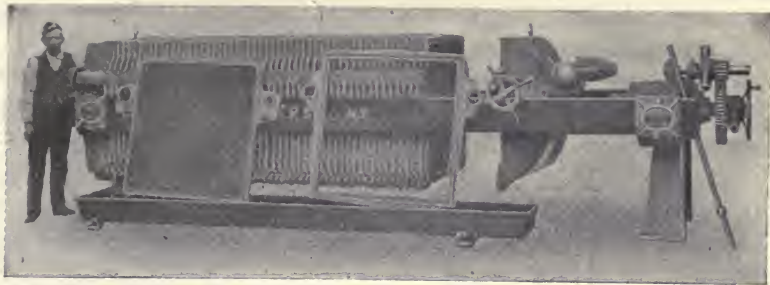

FIG. 113.—Rectangular or Dehne Filter Press.

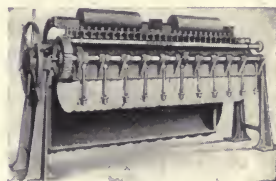

FIG. 114.—Sweetland Filter Press.

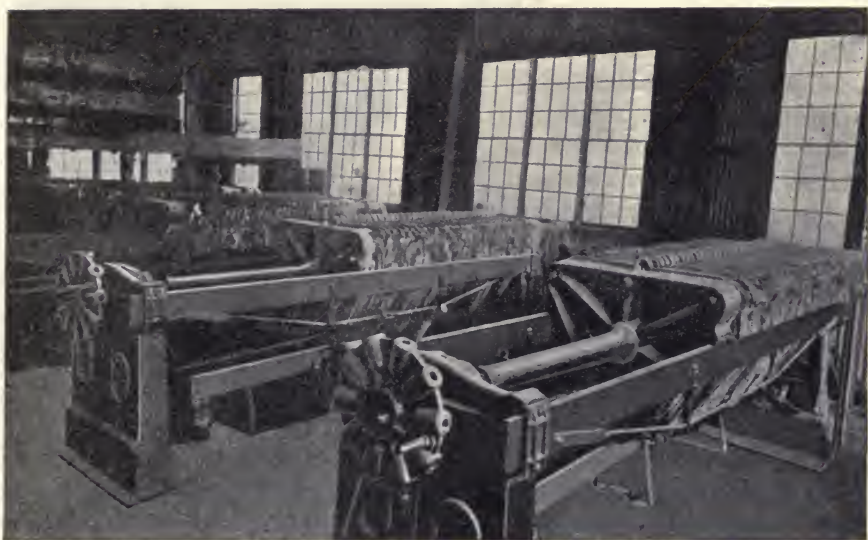

FIG. 115.—Merrill Filter-press Installation.

these showing at the right. The filter leaves are covered by a canvas filter cloth, one on each side. Fig. 116A shows the roughened surface of a leaf, or plate, the surface grooved so that the filtered solution is carried by the grooves to the outlet channels, circular openings at the sides of frames and leaves.

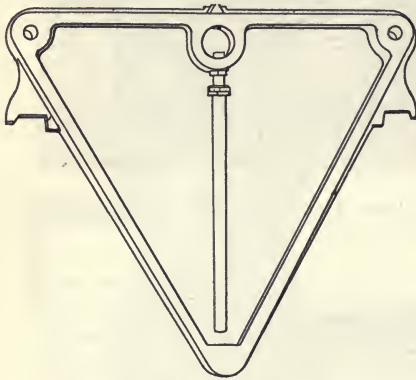

FIG. 116.—Merrill Press-frame.

The filter cloths are pierced with openings at the channels for the circulation of the pulp and the filtrate. These cloths are large enough to extend beyond the frames. The follower, a solid plate at the right, is now brought against the assembled parts and the joints tightly compressed by the follower screw.

Filling is generally done by a three-throw pump, which will charge a press, forming a 2-in. cake in from eight to fifteen minutes

according to the thickness of the pulp from the last agitating vat. The final pressure is as much as 60 lb. per square inch. In operation, the pulp flowing along the left-hand channels of the frame finding no outlet, the solution passes through the filter cloths, leaving the solids behind. The solution from each leaf flows out through a cock at the left-hand lower corner into a launder set beneath and thence to the gold solution tanks. Washing the cakes is the next operation, taking thirty minutes at 75 lb. pressure per square inch. The wash-solution goes to the wash-solution vats. The cakes are now dried by compressed air for about two minutes, the press is opened and discharged. A cycle of operations takes seventy-two minutes.

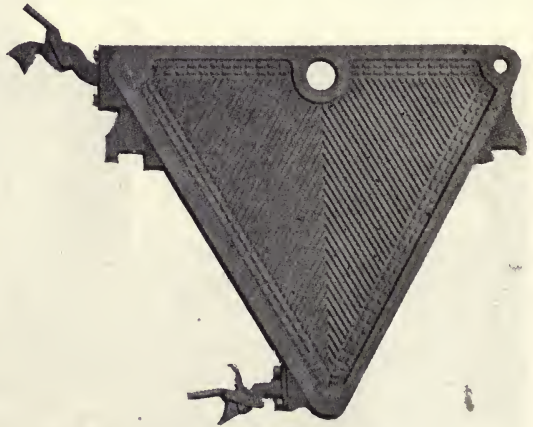

FIG. 116A.—Merrill Press-plate.

The Merrill press was the outcome of treating low-grade slime, and at the Homestake this is filled into the presses, the gold dissolved in them and the residue automatically discharged without the apparatus being opened, except for necessary repairs. It has been very successful at this mine and



others in North America. In principle the Merrill press is similar in many respects to the Dehne. The Merrill is essentially of the ordinary rectangular flush-plate-and-distance-frame pattern with internal channels, but equipped with the automatic discharging device which is the distinguishing feature of the press. A standard press to hold 25 tons of slime contains up to ninety-two frames 4 in. thick, each with a cross-sectional area of 25 sq. ft. Between the frames are the usual solution plates, and all are made with suitable channels for flow of solutions. When empty, a press weighs about 70 tons. The filling and washing is similar to the Dehne, only pressures are about half of that used in the latter type. Slime may be leached in the press or not, according to the character and value of the ore. In discharging a Merrill press the procedure is as follows: In a lower central channel in the frames is a 3-in. pipe, resting on supports, bolted to plates at intervals, throughout the length of the press and connecting at the front standard with the water supply and rotating mechanism for the pipe. Projecting into each frame compartment from the sluicing pipe is a 0.16 in. nozzle through which water is discharged against the cake of slime, while the whole pipe is rotated through an arc of about 200°. The cycle of operations at the Homestake mill is 560 minutes and at Santa Gertrudis mill ninety minutes; at the former the slime is leached in the press and at the latter it is previously agitated.

As typical of the operating cost of a large Merrill filter installation in Mexico, may be taken the following figures from the Esperanza Mining Company at El Oro. Approximately 1000 tons of slime are filtered daily with six presses, averaging eighty-two frames each, being equivalent to 100 lb. per square foot per day. Caking effluent carries \$3.20 in gold and 1 oz. silver. Dissolved metal loss is \$0.03 in gold and 0.01 oz. silver. Operating charges are: Canvas, \$0.0108; acid, 0.0035; labor, 0.02; miscellaneous, 0.00005; sluicing water, 0.0102; a total of \$0.045 per ton filtered. The item for sluicing water represents all charges incidental to settling and returning for re-use all water sent out with sluiced residues.

As illustrating the additional dissolution of metal which almost invariably occurs during washing in pressure filters of this type, the following data from the Merrill installation at the mill of the San Luis Mining Company, in Durango, may be cited: The caking effluent carries 25 oz. silver per ton, while re-washed filter heads and tails show 4.7 and 4.08 oz., respectively.

#### GENERAL REMARKS ON FILTERS

For large output are used the various types of suction filters, whether intermittent like the Butters, or continuous like the American or the Oliver. Where, however, the temperature of the solution approaches the boiling-point they are not effective, due to the vapor generated under vacuum.

Their highest suction is not to exceed 12 lb. per sq. in., but this may be an advantage due to the fact that the lower the suction the more open the porous structure. Colloidal slime is very apt to pack, making slow filtering. One may note that in the American suction filter the mud layer is automatically washed in the revolution and is scraped off against an inflated filter cloth at the critical instant.

The filter presses, such as the Merrill or the Kelly, work under a high pressure of 40 to 50 lb. to the square inch, and so act rapidly, especially on granular material. They work well on hot solutions. In the case of the Kelly press the frames must be washed, then withdrawn and unloaded. Sometimes the press-men get careless and do not wash the cake; this results in loss of valuable solution. With less slime proportionately to handle they are at their best, since stoppages to unload are less frequent. The Merrill press has the advantage that it may be unloaded ready for the formation of a fresh cake without having to open up. The press is well adapted to clarification or to filtering precipitate from cyanide solution, since the amount filtered out is small compared with the total bulk of the solution. Washing and air drying can be well done in the press.

#### CLARIFYING

The solution from decantation or from filter pressing is not always quite clear. A little slime may get into it by leakage through the filter cloth, or an overflow may at times be turbid. Such solution may be passed through a sand filter, vacuum filter, or a filter press of a few leaves; with little solid matter this is quite readily done, and leaves a bright and sparkling liquid. If the solution is not quite clear a little slime may deposit on the precipitant, whether zinc shaving or zinc dust, thus diminishing the activity of precipitation.

Of the filter presses the Merrill occupies a small floor space, has a capacity of 1000 tons of solution daily and is readily cleaned without opening the frames. To this end the press is sluiced out every six hours, using barren solution. The filter cloths are of No. 10 duck, and last six weeks. They get coated with a lime and alumina deposit, so that they must receive a HCl acid treatment about every three days. To do this an 0.9 per cent acid solution is pumped through the press at a pressure of 50 lb. for an hour. This is withdrawn, and stored for re-use, while the press receives a water wash. The slime caught by the press is sent back to one of the thickeners, since it still has gold values and cyanide.

Where sand filters are in use an extra tank is required in reserve. A sand-filter plant of ample capacity occupies a large floor space and is expensive to erect.

Unquestionably, the handling of slime, as produced from the operation

of the cyanide process, has reached a point where no further radical changes should be expected. The operation of separating the dissolved metal from the treated residue may now be carried out at a cost of \$0.05 per ton, under favorable conditions, and recoveries of 98 and 99 per cent are not at all unusual. The mechanics of the various machines will, of course, be modified and improved to suit the needs of special problems, and there is always the possibility of reducing capital cost. In comparison, however, with the development of the last ten years, these further modifications will be relatively unimportant.

#### THE CROWE VACUUM PROCESS

This consists in removing from the solution, just prior to precipitation, substantially all the dissolved air and oxygen. Generally, cyanide solution going to precipitation is saturated with air absorbed during the air agitation of the slime pulp, this air containing 30 per cent of oxygen and 65 per cent of nitrogen as against 23 per cent of oxygen and 75 per cent of nitrogen as found in ordinary air. Indeed in zinc boxes exposed to cold in winter a white precipitate, a hydrated zinc oxide, will form, due, doubtless, to the dissolved oxygen of the solution. In presence of the zinc precipitant the oxygen polarizes or reverses the action of the precipitating couples and causes re-resolution of the precipitated gold (or silver). Complete precipitation can take place only when sufficient hydrogen has been evolved to combine with the free oxygen, and in this evolution results the consumption of both zinc and of cyanide.

The Crowe apparatus consists of a receiver or drum 4 ft. diameter by 10 ft. high. The solution, coming from a steady-head tank set 24 ft. above the top of the receiver, pours through the top downward over a series of perforated trays. This breaks it up into a spray. A vacuum pump continually sucks away the occluded air of the solution. The solution level at the bottom of the receiver is maintained .30 in. deep by a float operating a butterfly valve in the intake pipe. The solution flows away at the very bottom to a pump set 33 ft. below so that one may be sure that the pump foot-valves are covered and that no air can be drawn in when pumping. It is into the suction pipe of this pump that the zinc-dust is introduced for precipitating. It is computed that by using this process, a saving of 50 per cent of the zinc dust can be effected.

#### THE PRECIPITATION OF GOLD FROM CYANIDE SOLUTIONS

**Precipitation.**—We have our choice between the ordinary extractor-box, using zinc-shaving, and the Merrill precipitation press, using zinc-dust.

Zinc-boxes are efficient, but occupy considerable floor-space, and are not simple when it comes to the clean-up. There is always the aggravating problem of the "zinc shorts."

Merrill presses are compact, thief- and fireproof, and allow a quick clean-up. In precipitating strong (0.2 to 0.3 per cent KCN) and rich solution with concentrate treatment, they give good satisfaction.

### THE MERRILL PRECIPITATION PROCESS

This consists of the introduction of zinc-dust into the suction of a pump from a pregnant solution tank, or the flow from the Crowe Vacuum treatment, by means of a special feeder through a filter press. Fig. 117 shows

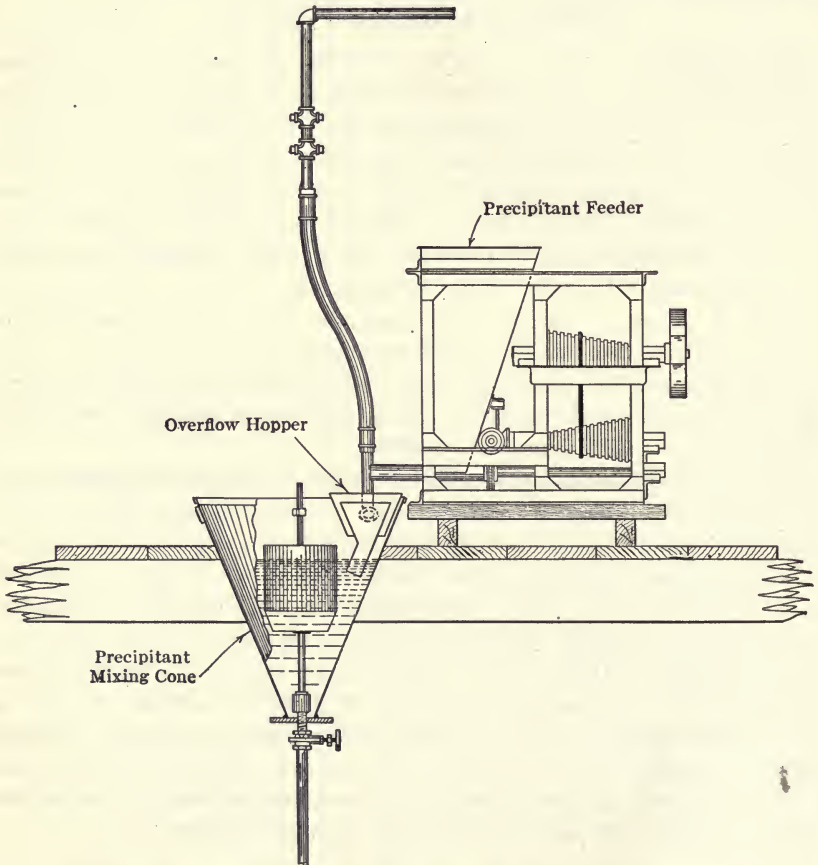

Fig. 117.—Merrill Precipitation Apparatus.

the preferred type of feeder for zinc dust. This is contained in a hopper marked "precipitant feeder." By means of a screw feed the dust is fed in an accurately adjusted manner through a small hopper into the "precipitant mixing cone" there mixing with a stream of solution. The mix-

ture is maintained at the proper height by means of a float-controlled valve at the bottom of the cone.

The design and construction of a satisfactory feeder is considerably more difficult than might appear at first sight. The original type as proposed by Merrill was an endless belt. On the top surface of this belt was placed the amount of zinc necessary to precipitate the given tank of solution. The belt was actuated by means of a series of floats, so as to cause the belt to travel forward and feed the zinc dust in exact proportion to the rate at which the solution was lowered in the sump tanks. A later type, illustrated in Fig. 117 makes use of a screw located at the bottom of a hopper, the hopper being provided with a hammering arrangement or a reciprocating arm to prevent arching of the zinc dust. Provision for regulating the speed of the screw is made by means of double cone and belt drive.

**Operation.**—The rate of zinc feeding is checked by weighing the amount run in in five minutes, experience deciding how much will be needed according to the assay value of the solution. When a newly cleaned press is "cut in," that is, brought into use, 20 lb. of zinc-dust is added at once, and for six hours the rate of feed is doubled, all to form a zinc-dust coating upon the filter cloths of the press. Also the solution for the first fifteen minutes is returned to the gold or pregnant solution tank as having been imperfectly precipitated. Where two presses are operated the flow is turned to the first one until it is normal, then the flow is through both.

**The Clean-up.**—The press is dressed with four thicknesses of cotton sheeting, the outside cloth being removed at each cleaning (every five or six days) and a new one added on the bottom. To clean a press, the solution is cut off, the press drained, then blown with compressed air for sixty to ninety minutes; this dries the precipitate to about 45 per cent moisture. The press is opened and the precipitate, amounting to perhaps 130 lb. is scraped into the precipitate wagon set beneath. The outside cloths are burned, the resulting ashes being added to the rest.

The barren solution from the Merrill presses is returned to No. 4 thickener.

**The method of precipitation employed,** assuming equal efficiency as regards the precipitation and recovery from solution of the precious metals, may exert an important influence upon extraction, either through introduction of the precipitant used into solution or its failure to precipitate certain interfering elements. For example, zinc in the presence of arsenic may interfere in the treatment of certain ores. If aluminum precipitation is used the difficulty is overcome through the elimination of zinc. When copper reaches a certain concentration in solution difficulties arise with both extraction and precipitation. Neither zinc nor aluminium precipitate

copper to any extent, hence if copper is to be removed from solution electrolytic precipitation must be used.

**Carbon**, which at times occurs in gold and silver ores, may occasion difficulty in cyanidation. It has been generally assumed that carbon occurs in gold and silver ores in the form of graphite, but the evidence available by no means supports this view in all cases. The two extremes of carbon as regards its behavior in cyanide solutions are graphite and charcoal. Graphite is dense and does not possess pores, therefore cannot occlude gases, while charcoal is porous and has the property of occluding relatively large volumes of gases. Graphite does not precipitate gold and silver from cyanide solutions while charcoal does. Intermediate between these two extremes are various forms of carbon which will precipitate gold and silver to a greater or less extent.

Feldtmann has shown that the graphitic or carbonaceous schist from the mines of West Africa will precipitate gold from cyanide solutions roughly in proportion to the carbon content of the schist. Gold so precipitated is not soluble to any appreciable extent in fresh cyanide solution, but is soluble in sodium sulphide solution. He thinks that the compound formed is possibly carbonyl aurocyanide, which may react with sodium sulphide according to the following equation:

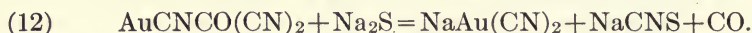

However, the graphite was found definitely to interfere with cyanidation. Experiments with deflocculation of the colloidal portion of the ore including the graphite, gave negative results, but it was discovered that if the physical state of the graphite were altered, most conveniently by heating, the extraction was wonderfully improved. The results below show clearly the effect of heating:

TABLE I

	Per Cent of Gold Extracted.	Pounds of Cyanide Consumed.	Per Cent of Graphite.
Wet slime.....	36.14	0.9	1.65
Dried at 100° C.....	64.60	0.6	.....
Check.....	64.60	0.6	.....
Heated to 300° C.....	80	0.7	1.55
Check.....	83.00	0.5	.....
Wet slime boiled with water, graphite skimmed off.	56.00	0.6	.....
Wet slime boiled with water, graphite not skimmed off.....	54.60	1.32	.....
Roasted in open dish.....	90.10	0.12	.....
Roasted in open dish.....	90.10	0.24	0.63

Attempts have been often made, with some degree of success, to precipitate the gold electrolytically upon plates suspended in the turbid solution. In present-day practice, however, the solution is invariably clarified before precipitation is attempted. The solutions from sand-leaching are generally clear enough for precipitation, but the solutions from slime treatment need clarifying after filtration.

When the slime and sand treatments are combined much of the solution from the slime treatment can be clarified and built up in value by using it for the first washes upon the sand, but even then the solutions from the sand plant should be later clarified before attempting precipitation. This has been done by the use of the sand filter, but this is of limited capacity, and the preferred method is the use of a leaf filter of the necessary size, as already described under head of clarifying.

An expedient sometimes used has been to fill the head compartments of the zinc box with excelsior or other fibrous material to act as a filter. This must be removed at frequent intervals and washed. However, at present the Merrill clarifying press is preferred.

Gold dissolved by cyanide solutions is recovered by passing the solutions through zinc shaving, zinc dust, zinc wafers, aluminum dust, or charcoal. The last precipitant is not used much, as, although efficient, it is rather a nuisance in requiring a good deal of attention during operation and at clean-up. The most commonly used precipitant is zinc-shaving arranged in a long narrow box, in which the solution is made to flow up through the mass. This is the original MacArthur-Forrest process. The reactions involved are fairly well understood, and in depositing gold the equation is as follows:

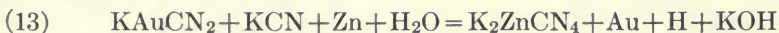

Generally speaking, gold-bearing solutions should be no lower than 0.03 per cent KCN strength for good results, and if lower, a drip of strong solution, or lumps of KCN added at the head of the boxes will strengthen them. If copper has been dissolved from an ore, it will precipitate on the zinc, thus preventing proper deposition of gold and silver. A partial remedy for this is to either dip the shaving in a 10 per cent solution of lead acetate, or add the latter solution regularly at the head of the boxes. In fact, a little lead acetate is at all times quite useful in the boxes. Also the addition of strong solution will delay precipitation of copper. Silver ores always make more precipitate than gold.

#### THE ZINC OR EXTRACTOR BOX

A description of a typical apparatus used in precipitation is as follows: A zinc box (Fig. 118) contains seven compartments, each 12×15×24 in. These have perforated false-bottoms of sheet-iron or wire-cloth that hold

up the zinc-shaving with which they are filled. The partitions are set alternately up and down, to compel an upward flow of the gold-bearing solution through the shaving, and to bring it intimately in contact with and insure the precipitation of the gold upon the surface of the zinc. At *a* in the side elevation the solution enters the box through a pipe *m* at the left, passed through all the compartments, flows over the last partition, and discharges through a down-turned pipe into the sump tank. The box is set at a grade of  $\frac{1}{4}$  in. to the foot.

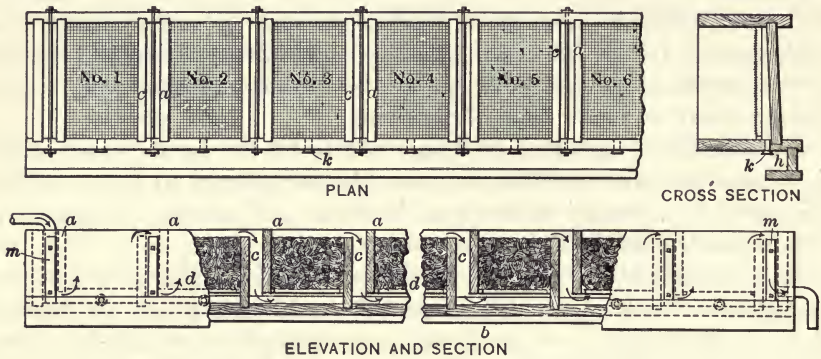

FIG. 118.—Seven-compartment Zinc-box.

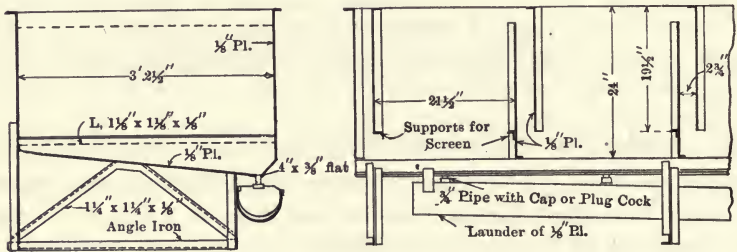

FIG. 119.—Sections of a well-designed Zinc-box.

In Fig. 119 we have a section of a well-designed zinc box and launder of sheet steel with wooden interior partitions. The supports of three screens (forming the false bottom through which the solution rises) is as indicated. The bottom is inclined to drain to an outlet which itself is plugged from the inside.

**The Clean-up of the Zinc-boxes.**—This is made monthly or bi-monthly, according to the bulk of the precipitate to be treated, and the need of realizing values for operating expenses.

**Cleaning the Zinc Boxes.**—At the time of the clean-up, only one zinc-box is taken care of at a time, the flow continuing in the others. The



flow of gold solution to this box is stopped, and water is run in to displace the solution contained. Beginning in the first compartment, the fine material is lifted out, while the shaving is agitated in the water with the hands protected by rubber gloves. This is not done roughly, for the brittle shaving would be unnecessarily broken and the water would be black with the floating precipitate. The plug in the side (see *k* in the cross-section Fig. 119) is gradually withdrawn, and the accumulated slime and water allowed to flow into the launder *h*. The plug is replaced and the compartment is again filled with water. The zinc again is rinsed and rubbed, and the loosened precipitate once more drawn off. About three such washes free the shaving from precipitate and short-zinc. The compartments are thus successively cleaned up, and the shaving from each compartment is moved toward the head, and in the last compartment, where needed, replaced by fresh shaving. Finally the launder is cleaned with a hose, and everything washed into an acid-tank or clean-up sump along with the material first lifted out of the compartments, and sulphuric acid added.

When all the boxes have been cleaned, the precipitate is allowed to settle a short time in the acid-vat and the supernatant liquid is siphoned into a settling tank. In this larger vat the particles of precipitate have opportunity to settle, and to be recovered subsequently in the filter-press. The acid-vat is stirred by hand with a wooden hoe, or preferably a power-driven agitator in constant motion. This insures a thorough agitation of the sludge and precipitate in the acid treatment.

**The Acid Treatment.**—Upon the watery slime about 30 lb. of sulphuric acid is poured. This acts upon the short zinc and produces a violent effervescence. After subsidence the whole is stirred. When the action again abates 15 lb. of acid and the same amount of hot water are added with occasional stirring. This is repeated until further addition of acid produces little effervescence. Then the mixture is allowed to stand two hours, and a portion is tested with more acid to see that decomposition is complete. The total time for the operation is four to six hours.

**Filter-pressing the Precipitate.**—The black mixture, containing zinc sulphate in solution, is diluted with hot water to within a few inches of the top of the vat. The whole content is stirred and then pumped through a lead-lined filter-press, see Fig. 113. The vat is washed and the washings are also pumped through the press. Finally the residue in the press is washed with hot water to entirely remove the zinc sulphate.

The entire precipitate, having been transferred to the press, while in this position is washed with water under pressure. The water is followed by compressed air to dry the precipitate, which, after this, is ready to discharge. To discharge the press, the tightening-screw is slackened, the

follower is drawn back, and the frames are successively separated. The grayish black residue in the recesses of the frame containing 20 per cent or less of water, drops into a drying-pan placed beneath the press to receive it.

**Dressing the Boxes.**—At the start, compartments Nos. 1 to 4 inclusive are packed with fresh zinc shavings; in two days the fifth and in two days more the sixth compartment. As zinc is consumed fresh shavings are added and this dressing of the boxes is more frequent as the time of the monthly clean-up approaches. The first compartment, however, takes already-plated long filaments from the next compartment and on top of them shavings now nearly consumed, the so-called short zinc.

#### DRYING AND REFINING THE GOLD PRECIPITATE

The product, still damp, is transferred to pans 24×44 in. by 4 in. deep. A pan is slid into a cast-iron muffle, and heated until the precipitate is dry and finally to an incipient red. It is then removed, allowed to cool, and the weighed contents cautiously mixed with 50 per cent borax, some sand and soda. Since the product is light and dusty, care must be taken in handling it, and for fusing it must be put carefully into melting furnaces. The molten metal is stirred in the crucible, then poured into crucible molds, and on cooling, the slag is removed and the gold remelted into an ingot.

#### REFINING WITH BICHROMATE

Where a filter press is not used a good method is to proceed as follows: To the acid-treated and washed precipitate is added five times its estimated weight of water, also sulphuric acid and bichromate of potash, but each stirred in separately in the proportion of four parts of 60° acid to one part of the solid bichromate, the latter first dissolved in hot water. Careful additions are made until a slight coloration, still showing, tells that enough bichromate has been added. The remaining precipitate is decanted, well washed, and dried. It is transferred to a clay crucible with an addition of borax for fluxing and niter for oxidizing carbonaceous matter, is melted and poured into an ingot free from zinc, lead, or copper.

**Refining in a Cupelling Furnace.**—As practiced at the Alaska-Treadwell cyanide plant, the acid-treated precipitate, containing 17 per cent of silver, 5 per cent lead, 14 per cent copper, 5 per cent zinc and 20 per cent insoluble matter, is treated on the hearth or test of an English cupelling furnace (see Fig. 278). The furnace is charged hourly with the precipitate to which have been added fluxes. This melts down into the lead bath contained on the hearth. Here it is oxidized, yielding slag and

lead-bullion, which are tapped off intermittently at opposite sides of the hearth as they accumulate. A typical charge mixture would consist of precipitate 100 lb., glass 22 lb., sodium carbonate 25 lb., old slag 80 lb., iron turnings 15 lb. Such a charge would yield about 35 lb. of rich lead, 10 to 15 lb. matte, and 160 to 180 lb. of slag.

**Drying and Refining at the United Eastern Cyanide Plant.**—After determining the moisture content, the undried raw precipitate is fluxed with 11 per cent borax glass,  $11\frac{1}{2}$  per cent sodium bicarbonate, 6 per cent manganese dioxide, 3.3 per cent ground bottle glass, and at least 10 per cent of old slag shells from former melts, the percentage being in terms of the calculated weight of the dry precipitate.

A precipitate press ordinarily runs from five to six days, and yields about 130 lb. dry precipitate. In resuming precipitation after a final clean-up, one press is given the entire flow. When this builds up a pressure of 35 to 40 lb., the second press is opened just enough to maintain the pressure of the first press below 45 lb. When the second press reaches 20 lb. pressure, the entire flow is turned into it and the first press is cleaned. This method is carried on until the end of the month, when a final clean-up is made. The solution is metered by a revolution counter on the triplex pump, which is calibrated at intervals with a known tonnage of solution. Solution samples are taken each shift; the heads are a dip sample every hour and the tails a drip sample from the barren flow. The tonnage and the average solution assays give the ounces of gold precipitated daily; this is checked monthly against the bullion sold.

**Melting.**—The fluxed wet precipitate is placed in No. 5 paper bags and fed to an oil-fired No. 150 Case tilting furnace, using a No. 100 long-lipped, graphite pot. When ready for pouring, the pot contains fifteen sacks of precipitate and yields a 600- or 700-oz. button and some 40 to 50 lb. of slag. This charge is poured into a conical mold and allowed to set a few minutes. The slag is then tapped through a hole about 2 in. above the gold button, and run into cold water for granulation. The cold skull of shell left in the mold, which contains most of the shot, is put back with a subsequent charge. The granulated slag, which carries some 25 oz. of gold per ton and as much silver is ground in a small ball mill and concentrated with a laboratory-sized Diester table. The resulting slag tails from each month's run, of which we usually have less than 400 lb. carries a total value of about \$50. This is shipped to the smelter once a year.

An average month's run will show: Crude dry precipitate, 21,000 oz. troy or 1440 lb. avoirdupois; 71 per cent bullion yield, 14,936 oz. troy or 1024 lb. avoirdupois; 39.7 per cent gold yield, 8538 oz. troy or 573 lb. avoirdupois; 21.4 per cent silver yield, 4497 oz. troy or 308 lb. avoirdupois.

The crude precipitate contains from 6 per cent to 7 per cent of zinc and about 10 per cent of lead, the latter coming from a lead acetate drip added as the solution leaves the clarifying filter.

The bullion buttons are remelted and cast into bars weighing about 150 lb. each. A dip sample is taken with a 10-gm. clay crucible just before pouring. This sample is granulated in cold water and is sent to the assayer. The bullion, as shipped, has an approximate fineness of 560 in gold and 301 in silver.

#### CAPITAL COSTS OF SLIME PLANTS

It may be of value to cite approximate figures from Rand practice, where the intermittent decantation and pump transfer type of plant has reached such high development. The total approximate capital costs of slime plants, in dollars per ton of slime treated per twenty-four hours is as follows: 150 to 225 tons, \$292; 300 to 450 tons, \$276; 600 to 900 tons, \$260; 1200 to 1800 tons, \$243. Such slime plants provide for collecting and two washes, two days being available for collecting and treatment, and include complete pulp, solution, decanting, and water services, together with solution clarifiers, but exclude precipitation, refining, and power plants. It must be noted that Rand plants require very little expenditure for buildings.

#### COSTS OF DISSOLUTION BY SLIME AGITATION

Costs of dissolution may be of some interest, although it must be remembered that such costs depend on numerous widely varying conditions, such as character and grade of ore, cost of labor, power, and supplies, amount of extraction effected prior to agitation, arrangement and capacity of the plant, and the recovery percentage achieved. Furthermore, such accessory steps in the cyanide process as fine grinding, filtration, or decantation, precipitation, melting, and refining, will depend on the dissolution method in use and, hence, should be taken into account in comparing "slime agitation" with "sand leaching" or "filter treatment." Then too, the higher percentage of dissolution obtained by "slime agitation" must be weighed against the value of the dissolved metals and cyanide lost by imperfect filtration or decantation. It is to be understood that the following figures are merely numerical averages of compilations from representative plants in various parts of the world. The cost of dissolution per ton of slime is made up of the charges for thickening, agitating, proportionate pumping, supervision, cyanide, lime, and lead salts.

COST OF FILTRATION OR DECANTATION

	Dissolution.	Precip. and Refining.	Total.
Average gold ore.....	\$0.29	\$0.25	\$0.54
Average silver ore.....	0.83	0.42	1.25

Included in the above, but so far below the average as to require special notice, is the intermittent decantation method practiced on the Rand, where the slime is particularly amenable, in so far as concerns thickening, dissolution, and chemical consumption. Figures from nine Rand slime-plants show an average cost of dissolution, decantation, precipitation, and refining, of 24.5 cents per ton of slime, the extraction averaging 85.9 per cent on slime heads of \$1.92. Recent Rand slime plants have adopted filtration in place of decantation, and obtain extractions ranging from 92 to 95 per cent. From the above Rand figures, about 4 cents should be deducted for precipitation, refining and assaying.

COMPARATIVE AGITATOR DATA

M.—Bottom Drive Mechanical  
 P.—Pachuca  
 D.—Dorr

Sp. Grav. of Pulp=1.326  
 Power at \$5 per H.P. per month.  
 Labor at \$3 per eight-hour shift.

Type.	Size, Feet.	Capacity, Dry Tons of Slime.	Total Corrected Cost.	Erected Cost per Ton of Capacity.	Power per 100 Tons of Slime.	Total Operating and Repair Cost per Ton of Slime per Twenty-four Hours, 500 Ton Plant.
M	30×12	134	\$2395	\$17.87	D—3.0 H.P.	D—1.8 cents
D	30×12	134	2510	18.73	M—5.2 H.P.	P—2.3 cents
P	15×45	102	1935	18.97	P—6.9 H.P.	M—2.4 cents

Agitator Requisites.	Violence of Agitation.	Total Operating Cost per Ton.	Regulation of Amount of Air for Aeration.	Freedom from Choking or Settling.	Ease of Starting after Shut-down.	ADAPTABILITY TO			Operating Simplicity.	Minimum Loss in Mill Height.
						Varying Pulp Conditions.	Continuous System of Agitation.	Selective Agitation.		
In order of preference	P D M	D P M	M D P	D P M	P D M	P D M	D P M	P D M	D M P	

The rich lead must be again cupelled, this time to remove impurities such as copper and lead, using an air blast for oxidizing. A fine gold bul-

lion is produced which is remelted in a Faber du Faur retort furnace (see Fig. 156), to yield ingots or bars of 880 fine in gold.

At the refinery of the Goldfield Cons. Co. they have adopted blast-furnace smelting of briquettes, a mixture of the precipitates 100 parts, litharge 100 to 125 parts, and heavy sulphides concentrate from the mill (S 0.35 per cent;  $\text{SiO}_2$  30 per cent) together with some mill sweepings. The furnace yields a lead bullion (cupelled as above described, also copper matte and slag. The matte and slag may be sold to a regular smelting works.

## CHAPTER XVI

### TYPICAL GOLD MILL PRACTICE

The following pages give descriptions of various cyanide mills:

#### CYANIDING FREE-MILLING POROUS ORES

These include ores which are somewhat porous and which may be cyanided by leaching when coarsely crushed.

#### THE WASP NO. 2 MILL, SOUTH DAKOTA

The ore is a massive iron-stained quartz.

Its average gold content is \$2.40 per ton. The ore is mined by steamshovel, and crushed by two No. 6 and one No. 4 Gates crushers, to  $1\frac{1}{2}$ -in. size. Four sets of 16×36-in. rolls reduce the ore to  $\frac{1}{4}$ -in., when it is elevated to storage bins. The rock is fed from the storage bins through rack and pinion gates to an 18-in. rubber belt conveyor, mounted on a frame which moves back and forth on an 18-in. track, so that it can dump to any one of the six individual conveyors, each of which serves one vat. A 1 H.P. motor and rope drive serves the main conveyor, and a 40 H.P. motor the individual conveyors and feeders. There are six leaching vats 12×32 ft., holding 420 tons each, fitted with the usual filter bottoms. Cyanide solution is pumped to the vats so that it flows under the filters and up through the ore. Two or 3 lb. of lime is added per ton of ore for protective alkalinity. The solution contains 5 lb. of cyanide per ton. This stands for twelve hours, is drawn off and followed by seven weak-solution washes. Gold is precipitated by zinc shaving. Cyanide consumption averages about 0.4 lb. per ton, and costs are 67 cents with an extraction of 76 per cent.

#### ORES OF CLAYEY NATURE BY CYANIDING

Any ore which contains a high percentage of alumina is difficult to treat, and two good examples of this ore are the Buckhorn, Nevada, and Victorious, Western Australia.

## THE VICTORIOUS MILL, WESTERN AUSTRALIA

The lodes of the Victorious mine are of soft kaolinized material, through which run small veins of ironstone quartz, which carry the gold. This ore has been successfully treated by the following process, of which a flow sheet is shown (Fig. 120). The present daily output averages 320 tons.

**Coarse Crushing.**—The ore is broken by a 10×18-in. Blake-type rock-crusher running 250 R.P.M. After being crushed the broken rock passes to a 14-in. Robins belt conveyor, set at an angle of 20° and is distributed into a bin by means of a Robins 14-in. hand-tripper with a double chute. The total storage capacity is 600 long tons. The bin is fitted with rack and pinion doors and steel chutes.

The ore is ground by four 5-ft. Huntington mills fed by four ore-feeders, driven by means of a short belt from the Huntington mill shaft. Cyanide circulating solution is used for crushing, and mercury is used in the mills with the present ore. The product of the mills equals 1 ton of ore to 1 ton of solution, and is discharged into a cement launder and thence to the pump well. From here it is lifted 35 ft. to the top of four sets of cone separators by a duplex plunger pump. The sand separated is conveyed by launders to a pair of Wheeler pans. Here more coarse gold is collected and the sand is ground. The overflow from the grinding pans joins the main body of pulp

from the separators in a collecting-box situated 4 ft. above the thickeners, from which it is distributed to four pulp thickeners. These are steel vats 25 ft. diameter by 9 ft. deep. The agitators are 20 ft. diameter and 6 ft. deep and the arms revolve at 7 R.P.M. From the agitators the pulp is pumped to a distributing agitator near the filters. Filtration is done by three Ridgway filters whose capacity is estimated at 300 tons per twenty-four hours on this ore. This machine has a large shaft carrying two arms on which are suspended a basket of filter-leaves. This is dipped into a pulp tank to form a cake, then turned into a wash tank, and finally discharged into a hopper in the center. The ore averages \$7 per ton, and an extraction of 90 per cent is obtained at a total cost of \$1.10 per ton.

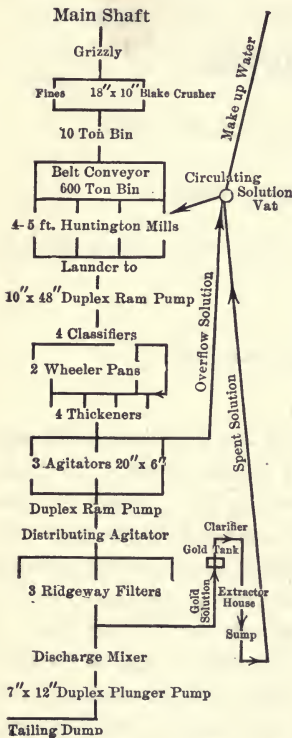

FIG. 120.—Flow-sheet, Victorious Mill, Western Australia.



## THE KOLAR FIELD

The ore mined at the Kolar field, India, is free milling. The percentage of pyritic content varies on the different mines, but taken as a whole it does not average more than 1.5 per cent and for this reason the sand can be weathered without detriment. The weathering, while oxidizing the pyrite, and freeing the gold content, is further advantageous in freeing the sand of surplus moisture, reducing it from 12 to 16 per cent down to about 3 per cent. This converts it to a more friable state, in which any slime present can be easily powdered. Having no water to displace, it can thus be easily saturated with solution, and the lixiviation and subsequent washings more thoroughly and quickly carried out.

## THE CITY DEEP MILL

This treats ore from the reefs on the Rand which may be described as a conglomerate of quartz pebbles cemented together by a matrix having a dark bluish appearance when freshly mined. The "banket" carries up to 75 per cent silica and 2.5 per cent pyrite. The ore from the mine is divided into two classes by screening through grizzlies; the fine is conveyed by a 20-in. belt direct to the main ore bin. The coarse is taken by four inclined sorting belts, see Fig. 121, where the waste rock is picked out by hand, each belt feeding three crushers with 12×24-in. jaw-opening. The return portion of each sorting belt receives the rejected waste rock and delivers it to a belt that takes it to waste.

The transport of ore to the mill and all necessary surface work is effected by heavy electrical locomotives using 2000-volt, 50-cycle, 3-phase current. The mill of 2200 tons daily capacity is equipped with 200 stamps arranged in units of ten, each unit driven by a 50 H.P. motor. The weight of the stamps, which have long heads and short stems, is 2000 lb. One special feature is that there is only a layer of  $\frac{1}{2}$ -in. felt between the mortar bases and concrete foundations. King-posts are entirely dispensed with, the concrete foundations being carried, with indented steel-bar reinforcing, to above the level of the top of the mortar-box. Each cam-shaft is carried by a steel frame and rests on eleven bearings, so as to minimize the risk of breaking. Stems are 4 in. by 13 ft. long and the stamps are arranged for a heavy duty if necessary.

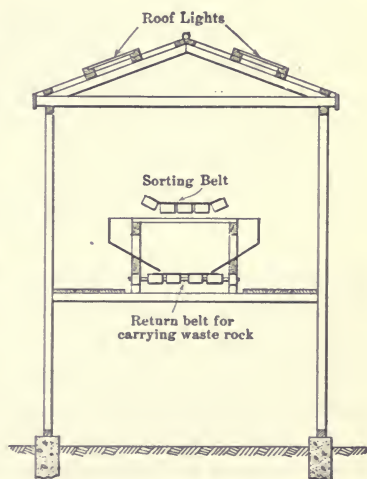

FIG. 121.—Sorting Belt.

Each battery is provided with four Challenge feeders. Referring to diagram, Fig. 122, the watery pulp, after elevation by a sand pump, is classified in Caldecott diaphragm cones, Fig. 58, and the underflow delivered to the tube mills. There are nine of these, 5½ ft. diameter by 22 ft. long driven by a 100 H.P. motor. The tube mill discharge is conducted to amalgamating tables in the gold-recovery house and under the same roof are arranged the extractor or zinc boxes, the clean-up machinery, strong room and the refinery so that all operations are performed in one building under the supervision of a responsible man. The pulp from the table is again elevated to four coarse sand classifiers, the coarse underflow of which goes back to the diaphragm cone for regrinding. Meanwhile the overflow of three classifiers passes to the slime separators, the overflow to slime collectors as described, the sand underflow to the sand collectors consisting of six steel vats, 50 ft. diameter by 10 ft. deep, set on reinforced concrete supports. A 24-in. conveying belt, running

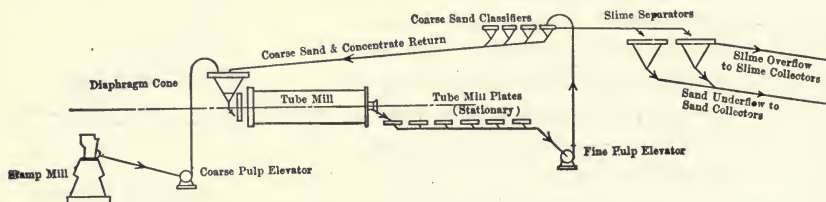

FIG. 122.—Grinding and Classifying on the Rand.

under the center line of these vats, takes the sand excavated from them by a Blaisdell excavator and by conveying belts removes it to twelve leaching vats. The sand is fed to these leaching vats by a Blaisdell distributor, and, after leaching, it is discharged by a Blaisdell excavator through a central discharge opening at the bottom of the vats to two 24-in. conveying belts, one under each row. A cross belt delivers it to a 24-in. inclined belt which takes it to the tailings dump, where it discharges 100 ft. above the ground.

The slime is collected in four conical-bottom steel vats also on reinforced steel supports. From there it is taken for treatment in two steel conical-bottomed air agitator vats, 32 ft. diameter by 38 ft. deep and later washed in eight steel conical-bottomed vats 70 ft. diameter by 16½ ft. to 20½ ft. deep. This washing is done by decantation.

It is thus seen that from start to finish the labor of the South African native has been eliminated as far as possible. The various products either flow from point to point by gravity or the fluids are pumped and the solid products are transferred by mechanical methods.

THE MILL OF THE CONSOLIDATED LANGLAAGHTE CO.,  
RAND, SOUTH AFRICA

The mill is designed for a capacity of 45,000 tons per month of twenty-six days. The receiving bin, which is of steel and concrete construction, delivers the ore on to three 30-in. belts running at a speed of 150 ft. per minute. Each belt discharges over a short grizzly into a washing trommel. The undersize from the grizzlies and trommels discharges on to a 30-in. belt, which delivers on to the main 30-in. conveyor belt leading into the mill. The washings from the trommels and the sorting belts are conveyed by launder to the coarse sand pumps. The oversize from each of the trommels is delivered to a 36-in. sorting belt, running at a speed of 40 ft. per minute. Waste rock and tube-mill pebbles are thrown into separate bins under the sorting belts. Each sorting belt discharges to jaw crusher, the product from which is carried by a 24-in. belt to the mill conveyor belt. The dust produced in breaking the ore is exhausted by a fan, and, after spraying with water is delivered to the launder carrying the trommel undersize. The sorted waste is transported from the bins by trucks to the dump. The ore is elevated at an angle of  $18^{\circ}$  by a 30-in. belt conveyor, running at a speed of 300 ft. per minute, and is distributed over the 3000-ton mill bin by means of a tripper. The tube-mill pebbles are conveyed in a similar manner from the crusher station and thence to the pebble-storage bin at the west end of the mill building. The mill, is supplied with 100 stamps each of 1750 lb. Ten stamps are driven by a 50-H.P. motor operating through a counter shaft to two cam-shafts, each of which carries five stamps.

There are ten  $6 \times 16\frac{1}{2}$ -ft. tube-mills, each driven through spur gearing and belt by a 100-H.P. motor. The battery pulp from each ten stamps gravitates to a 6-ft. primary cone classifier at the head of each tube-mill. One secondary cone of smaller size is provided for each two primary cones. The underflow from the primary cones passes to the tube-mills, and the overflow passes into the secondary cones. The overflow from the latter is led direct to the fine-sand pumps, while the underflow is led to the coarse-sand pumps. The tube-mill pebbles are brought from the pebble-bin by cars and are deposited into a hopper placed at the inlet of each tube-mill. In the platehouse there are forty stationary amalgamating tables, each  $5 \times 7$  ft., and recovery by amalgamation is 72 per cent. Each tube-mill discharges through a launder on to a set of four tables. Opening out of the platehouse is the clean-up room, which is equipped with two retorts, two bullion furnaces, three amalgam barrels, batea, and amalgam press. A strong-room is also provided. The pulp from the plates is conveyed by a launder to a reinforced concrete sump having a capacity equal to the product of ten minutes' crushing in the mill. The pulp is elevated by 10-in. pumps with 12-in. suction and is distributed to the tube-mill primary

cones by means of launders. The overflow from the secondary cones passes as mentioned above, direct to the fine-sand pumps. These pumps are provided with suction hoppers, having overflow launders leading back to the coarse-pump sump. The fine-sand pumps elevate the final pulp to the sand classifiers. The principle of double classification is adopted, the classifiers being cones 8 ft. diameter by 10 ft. deep. The primary cones, six in number, are fitted with rings to catch candle grease and wood fiber from the mine. The underflow, suitably diluted, passes to three secondary cones, which are fitted with water regulators giving a wet underflow. The underflow from the secondary cones passes to three sand-collecting tanks, which are each 55 ft. diameter by 10 ft. deep, and are provided with peripheral launders. Butters distributors are used. The overflow from the primary classifiers is led to four sand return cones, each  $7\frac{1}{2}$  ft. diameter by 5 ft.  $10\frac{1}{2}$  in. deep. The percentages of sand and slime are 39.5 and 60.5



FIG. 123.—Steel Tank, 70 ft. diam., for Rand Practice.

respectively. The overflow from these cones, together with the overflow from the secondary classifiers and the sand collectors, goes direct to the slime collectors and the underflow is returned to the fine sand-pumps for reclassification.

The sand is discharged from the collectors by bottom discharge doors on to belt conveyors, which carry it to a Blaisdell distributor, placed over the treatment vats. There are twelve treatment vats, each 40 by  $9\frac{1}{2}$  ft., and the treated sand is discharged into cars and conveyed to the dump by mechanical haulage. Recovery by sand treatment is 12 per cent. The extractor house contains zinc boxes and is provided with an acid-treatment plant and smelting-room. The latter contains calcining and reverberatory furnaces, ball-mill, and strong-room. The decantation slime plant consists of the following tanks: two collecting tanks 70 ft. diameter by 12 ft. with 7-ft.  $6\frac{1}{2}$ -in. cone, see Fig. 123; five collecting tanks 50 ft. diameter by 12 ft. with 6-ft. cone; two treatment vats 70 ft. diameter by 12 ft. with 6-ft. cone; one intermediate transfer tank 50 ft. diameter by 12 ft. with 7-ft.  $6\frac{1}{2}$ -in. cone; ten treatment vats 50 ft. diameter by 12 ft. with

6-ft. cone. Recovery by slime treatment is 12 and total extraction 96 per cent. The overflow water from the collectors is led to a return water sump, from which it is pumped to the mill supply tanks by 10-in. pumps. The residue is worth 23 cents per ton.

#### THE HOMESTAKE MILL, LEAD, SOUTH DAKOTA

The ore is a garnetiferous hornblende schist carrying 7 to 8 per cent of pyrite and pyrrhotite together and of the value of \$4 per ton. It is treated by *amalgamation and cyaniding*. The coarsely crushed ore is fed to 640 stamps having, as shown in the flow sheet, Fig. 125, an output of nearly 2800 tons per day. Here it is crushed in cyanide solution in the ratio of eleven parts solution to one of ore. A tube-mill is here introduced to increase the fineness of the stamp-battery product. The battery pulp passes over in all two-thirds of an acre of amalgamating plates set upon a  $12\frac{1}{2}$  per cent slope of  $1\frac{1}{2}$  in. per foot. With inside amalgamation in addition to these plates 72 per cent of the gold is caught. The tailings now flow to fourteen gravity cone classifiers *I*, each 4 ft. diameter by 5 ft. 5 in., which yield an overflow going to the *sand classification system* and an underflow of 8 per cent of the ore which goes to the regrinding system to be reground in tube-mills. All the pulp is of such a nature that a solution contact of some four to eight hours is ample. Direct filter slime treatment is, perhaps, the most efficient and satisfactory practice of the day. The partially thickened slime, in water, is charged directly into the filters, where the slime cake is in an excellent condition to receive preliminary treatment, such as aëration, solution leaching, and washing. The entire dissolution is effected in the filter, with a minimum amount of solution, precipitation, consumption of chemicals, power and labor, and loss in dissolved gold. The plant is very simple and compact, while the various operations are susceptible of accurate technical control. The pulp from the grinding machines unites with the main stream of pulp before arriving at the second battery of classifying cones. Classification of crushed products into sand and slime is effected by means of four series of sheet iron cones with 50 to  $80^\circ$  slope with peripheral overflow, each unit discharging at the apex through a short cast bushing. Nearly all of the material overflowing from the various cones of the classification system will pass a 200-mesh screen, and is treated as slime. It is thickened, and then run to the slime plant storage tanks, lime is added and treatment continued as described later.

**The Sand-plant.**—The prepared sand contains 40.5 per cent coarse particles that remain on a 100-mesh screen; 30.8 per cent middling, between 100 and 200 mesh, and 28.7 per cent fine passing 200-mesh. This leaches at the rate of 3 or 4 in. per hour. Before the sand enters the leaching vats it receives a stream of milk-of-lime which has been prepared by being

stamped in a one-stamp battery reserved for the purpose. From 4 to 5 lb. of the lime is added per ton of sand. The classified pulp and lime thus mixed pass to a Butters distributor, which can be transferred from one vat to another by an overhead trolley. There are 20 leaching

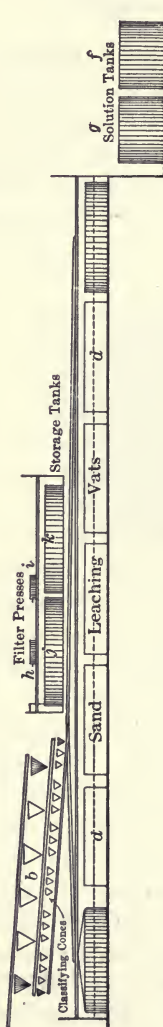

FIG. 124.—Elevation of Sand-plant, Homestake Mill.

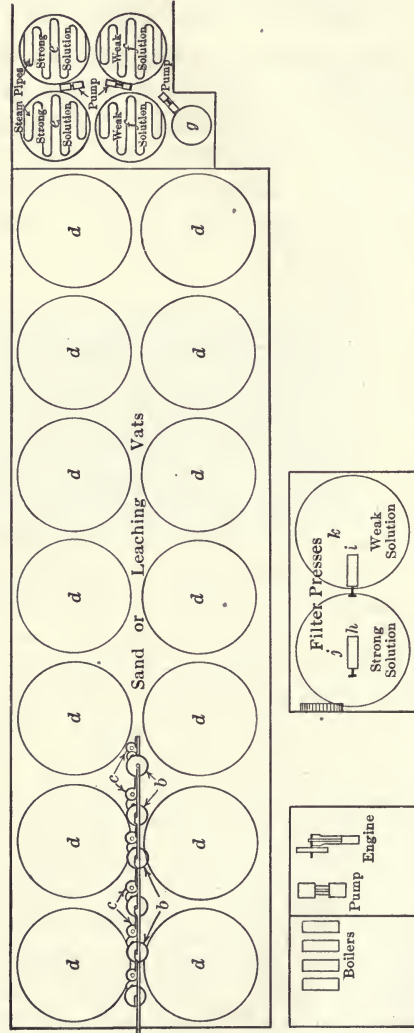

FIG. 125.—Plan of Sand-plant, Homestake Mill.

vats, each 44 ft. diameter, 9 ft. deep, and capable of holding 600 tons. The vat is filled with water and the sand runs in. It takes nine hours to charge the vat, and treatment lasts five days. When the vat is filled the ore is drained and a series of washes of the stronger of the stock solutions

(containing 0.14 per cent KCN) is run in, allowing each wash to drain off below the top of the ore to draw in air. Besides this, air is introduced below the filter. The effluent, its strength reduced to 0.10 per cent, is run to the two weak-solution precipitation tanks *f, f*, Fig. 125, each 26 ft. diameter by 19 ft. deep. After this, the weak solution is brought upon the charge and retained two days more. The solution escaping during this period is run to the two strong-solution collecting tanks, *e, e*. This is followed by a water wash which finally reduces the unextracted gold to 5 to 7 cents per ton.

The charge is now ready for sluicing out. This is done by two men in  $2\frac{1}{2}$  to  $3\frac{1}{2}$  hours, four side gates and one bottom gate being used for the purpose. The 8-oz. duck filter-cloth underlaid with another of cocoa matting is washed clean. The vat is then filled with water and is ready for the next charging.

**The Slime-plant.**—The slime pulp, amounting to 1600 tons daily, has an average value of 91 cents per ton. It contains 3 tons of water to 1 ton of solid, and is carried two miles by a 12-in. pipe at a grade of 1.5 per cent to the slime-plant. Here, two small vats are provided for slaking lime. The content is drawn to a screen-bottom box where the undissolved lumps separate. The box overflows into an agitator from which the milk-of-lime continuously runs into the main slime-stream at the rate of 5 lb. of lime per ton of dry slime. Two storage vats, 26 ft. diameter and 24 ft. deep, having conical bottoms with  $47^\circ$  sides, receive the stream. From the bottom of these storage vats the slime-pulp is drawn continuously through a 10-in. pipe to large Merrill filter presses, 65 ft. below, to obtain a pressure of 30 lb. per square inch. The 11-in. main extends the whole length of the press-building. Between each pair of presses the main branches into 10-in. pipes, which in turn send two 4-in. branches to each press. The smaller branches connect to a 4-in. passage or channel that extends along the center of the top of the filter-press frames. From the channel the slime-pulp flows into the press. There are ninety-two frames each 4 by 6 ft. and 4-in. distance-frames to form slime-cakes 4 in. thick.

Collecting is by revolving distributors, while the residues are sluiced out with 1 ton of water per ton of sand.

Total cycle approximates seven days. Screen sizing of sand: 35-mesh (0.0164 in.), 23 per cent; 35-65 (0.0082 in.), 29 per cent; 65-100, 21 per cent; 100-200, 18 per cent; 200, 9 per cent.

Extraction on \$3.15 sand heads, 79.9 per cent.

Cost of sand treatment per ton of sand, exclusive of neutralizing, precipitating, refining and assaying, 23.5 cents.

## COST OF SAND TREATMENT PER TON OF SAND

<i>Rand</i>	Cents.	<i>Homestake</i>	Cents.
Labor . . . . .	6.54	Superintendence . . . . .	1.06
Assaying, sampling . . . . .	0.32	Assaying . . . . .	.48
Lime . . . . .	0.56	Neutralization . . . . .	1.54
Transferring, discharging . . . . .	8.62	Transportation . . . . .	0.17
Cyanide . . . . .	7.23	Classification . . . . .	1.18
Precipitation . . . . .	1.56	Treatment . . . . .	8.59
Zinc shavings . . . . .	1.28	Precipitation and pumping solutions	1.18
Clean-up smelting . . . . .	2.92	Refining . . . . .	.38
Sodium bisulphate . . . . .	0.94	Heating . . . . .	0.51
Miscellaneous supplies . . . . .	2.30	Miscellaneous . . . . .	0.81
Water . . . . .	1.60	Repairs . . . . .	1.88
Power and lights . . . . .	6.48		
Miscellaneous . . . . .	0.59	Total . . . . .	17.78
	<hr/>		
Total . . . . .	40.94		

## TOTAL COST OF HOMESTAKE DIRECT-FILTER SLIME TREATMENT PER TON OF SLIME

Cents.	Or, combined as:	Cents.	
Superintendence . . . . .	0.93	Works labor . . . . .	6.70
Assaying . . . . .	.31	Shop labor . . . . .	.84
Neutralization . . . . .	2.03	Power . . . . .	1.84
Thickening . . . . .	.34	Chemicals . . . . .	6.78
Treatment . . . . .	10.73	Miscellaneous . . . . .	2.22
Precipitating and pumping solution .	1.65		
Refining . . . . .	.66	Total . . . . .	18.38
Heating . . . . .	.17		
Miscellaneous . . . . .	.88		
	<hr/>		
Total . . . . .	18.38		

## CONSUMPTION PER TON OF SLIME

	Lbs.
Sodium cyanide . . . . .	0.161
Zinc dust . . . . .	0.118
Lime . . . . .	3.840
HCl . . . . .	0.393
Power in Kw. Hrs. . . . .	1.150

Actual cost of dissolution, deducting precipitation, refining, assaying, and one-third of superintendence and miscellaneous items . . . . . 0.1516

**Capital Cost.**—Assuming an average total cycle of six hours, the complete capital cost of this plant including classification, thickening, filters, precipitation, refining, pumping, heating—all enclosed in buildings—will approximate \$265 per ton of daily slime capacity.



## THE LIBERTY BELL MILL, TELLURIDE, COLO.

The mine produces a hard ore containing 85 per cent silica, 10 per cent lime and about 4 per cent pyrite. The treatment consists in amalgamation, concentration and cyanide treatment of the concentrates.

The ore coarse-crushed at the mine to 3-in. size is delivered by tramway into the battery ore bins, see the plan, Fig. 126. The mill contains eighty stamps of 850 lb. each in eight batteries set on concrete foundations. The ore, fed from the bins by Challenge feeders, is wet stamped to 10- to 12-mesh in a solution containing 2 lb. cyanide per ton. For each battery there are two plates 4 by 8 ft. set across the flow, the first plate with a grade of  $2\frac{1}{2}$  in. to the foot the second  $1\frac{5}{8}$  sq. in. The slower flow on the flatter plate ensures recovery of the finer gold particles. The pulp is now treated in four Richards three-spigot vortex classifiers followed by six 6-ft. settling cones, the spigot discharge being concentrated on 18 Wilfley tables. The concentrate is reserved for special treatment by fine grinding and cyaniding while the tailings pass on to be reground in three tube-mills 5 ft. by 22 ft. long. The discharge of the tube-mills is re-amalgamated by being flowed over eight sets of transversely set amalgamating plates where the remaining gold particles are caught, and reconcentrated on ten Deister slime tables. The concentrate is united to the first above mentioned and the slime tailings are combined with the overflow of the cones into one pulp to go to the nine 33 ft. diameter by 10 ft. deep Dorr thickeners, where adequate settling of the slime can be effected. The thickened underflow or spigot discharge of these goes through six Hendryx agitators, 17 ft. diameter, operated continuously in series, the discharge of the last one being pumped to the equalizer tank of the filter system. Here it is drawn off as needed into any one of the five Moore suction filters resembling the Butters. The flow or strong solution from the Moore filters passes to solution storage thence to the sixth filter used as a clarifying filter and so on to the precipitating house where the zinc boxes are. The weaker solution resulting from the washing of the filters also goes to the clarifying filter and to other zinc boxes, the discharge being pumped to a tank to be used in the Moore filter for blowing off the cake. The precipitate from the zinc boxes is acid treated in the precipitation house and with the retorted amalgam of the plates is melted in the melt house and shipped to the Denver mint.

## TREATMENT OF TELLURIDE ORES

This class of ore is mined at Cripple Creek and Kalgoorlie, but the percentage of tellurium is now quite small, the bonanzas having been worked out for several years.

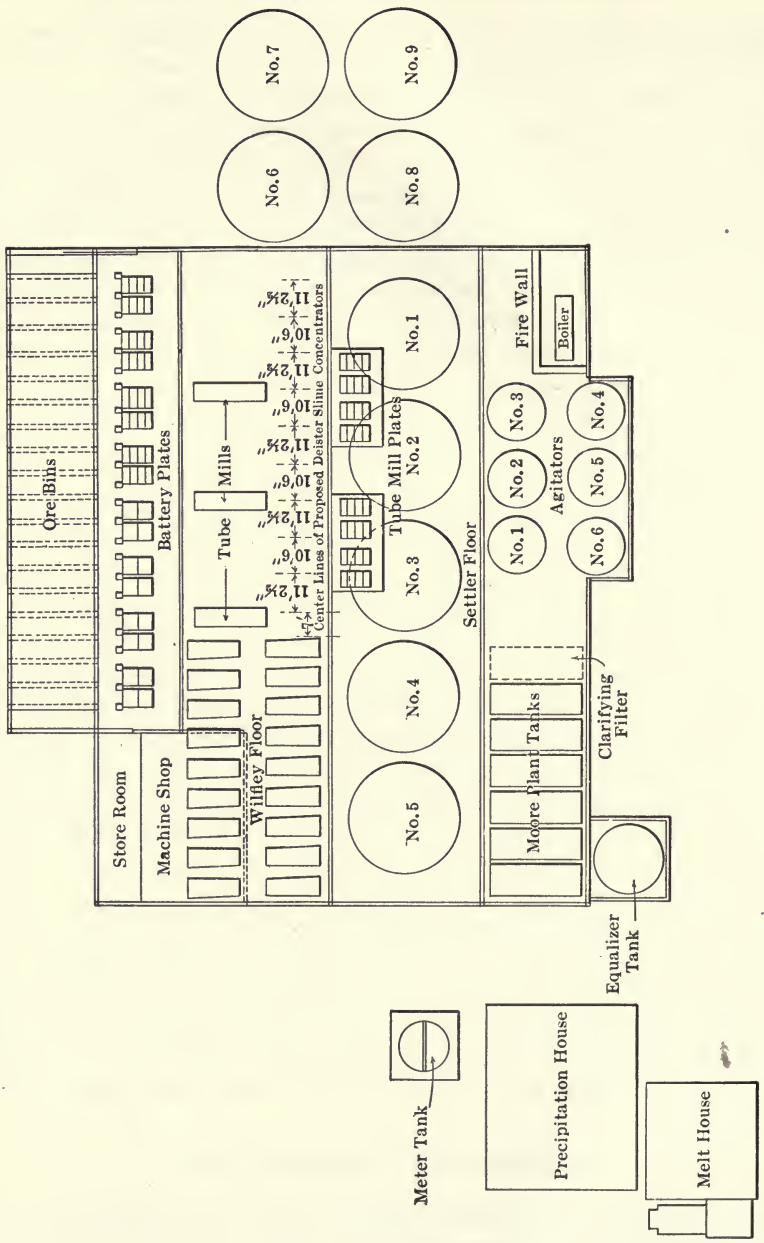

FIG. 126.—Plan of Liberty Bell Mill.

THE GOLDEN CYCLE MILL, COLORADO SPRINGS, COLO.

This is a custom mill treating Cripple Creek telluride ores, containing no other deleterious metals, by roasting and cyaniding. The ores, varying in size from 1.5 in. diameter to fine sand, after sampling, are taken by belt conveyors to one of the three large bins, called bed-

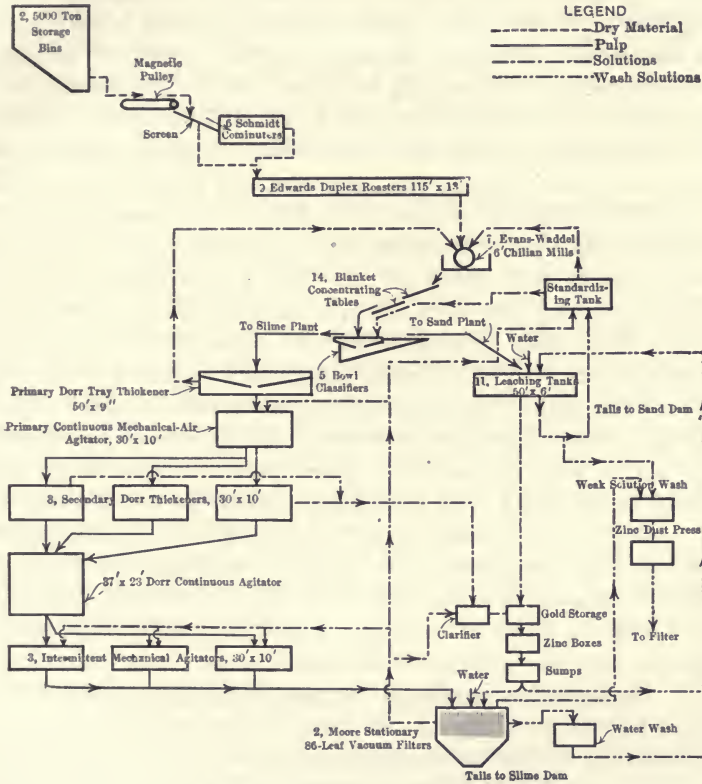

FIG. 127.—Flow-sheet of Golden Cycle Mill.

ding floors. They are classified into the grades A and B, according to the lime content, and separately and uniformly distributed in large beds of 5000 tons, so as to ensure a good mixture. Class A contains  $\text{SiO}_2$ , 76.7 per cent and  $\text{CaO}$  1.57 per cent; class B all over that, a typical analysis of the latter being, insoluble matter 75.9 per cent;  $\text{Al}_2\text{O}_3$  3.4 per cent;  $\text{Fe}$  3.5 per cent;  $\text{CaO}$  5.1 per cent;  $\text{S}$  1.8 per cent;  $\text{MgO}$  1.1 per cent. Class A resembles it except in the lime content. From the bedding floors the ore passes by belt conveyor to six ball-mills and is then dry crushed to pass a  $\frac{1}{8}$ -in. screen and with an average of not more than 30 per

cent coarser than 10-mesh. The basic ores need finer crushing than the silicious ones. The united capacity of these mills is 1250 tons daily. The ore from the mills is carried by a belt conveyor to steel bins set above nine duplex Edwards roasters, Fig. 74. This furnace 165 ft. by 13 ft. wide has a roasting hearth area of 1495 sq. ft. The rabblers revolve 6 R.P.M. There are three fireboxes to each roaster. There is a cooling hearth 44 ft long by 14 ft. wide or with an area of 572 sq. ft. In roasting class A ore, the temperature in the flow of heat at No. 2 firebox is  $800^{\circ}$  to  $850^{\circ}$  C. For the class B ore, a higher temperature of  $850^{\circ}$  to  $900^{\circ}$  C. is maintained. The ore escapes from the roasting hearth at  $485^{\circ}$  C. and leaves the cooling hearth at  $278^{\circ}$  C. For roasting class A ore 12.5 per cent of fuel is used; class B, containing so much more lime, takes a higher heat and at least 17 per cent of a local lignite coal. Each furnace roasts 125 to 150 tons of class A ore, 80 to 100 tons of class B ore daily. The roasted ore falls from the cooling hearth upon a reciprocating drag conveyor, where it is sprayed with water to cool it to about  $90^{\circ}$  C. ( $194^{\circ}$  F.), so that it may fall upon the rubber conveying belt to be taken to bins set above seven 6-ft. Chilean mills where the cyanide treatment begins. Here the ore is fed with addition of cyanide solution to the mills and ground to pass a 50-mesh screen. The discharging pulp is distributed upon the tables, blanket-covered and set at a slight slope, where the pulp spreads out in an even layer and where, with the aid of some solution, the lighter pulp is washed away, while the coarse gold developed in the roasting is caught in the interstices of the blanket. The pulp now passes to the bowl-type Dorr classifiers where it is separated into two products, clean sand for leaching, and slime, which is agitated and the gold solution removed by vacuum filters. One may note here the beneficial effect of roasting for not only is the telluride of gold decomposed, but the colloids of flocculent portions are shriveled up by the heat. Precipitation is effected by zinc shaving in the usual manner.

Cripple Creek ore, if slimed and given a long period of agitation, will yield as much as by the above-described method. Yet roasting prevails since, while it costs 50 to 60 cents per ton, it is not necessary to grind so fine, the extraction is a matter of hours rather than of days, cyanide consumption is less, and the solutions are less likely to become foul.

#### THE VICTOR PLANT OF THE PORTLAND GOLD MINING CO., VICTOR, COLO.,

was built for the treatment of the ore from the Portland mine which would not withstand the high cost of freight and treatment when shipped to the Portland plant at Colorado Springs.

The ore is brought to the mill in 5-ton electric cars and dumped into a cylindrical steel bin above the crushing plant. From this bin it is fed by an apron conveyor to a 15 by 30-in. Blake crusher, which reduces the ore

to about 3-in. size. It then passes to a 36-in., style B Symons disk crusher, which machine reduces it to  $1\frac{1}{2}$  in.; thence to a set of 20 by 48-in. rolls, the entire product of which will pass a 1-in. ring. A belt conveyor takes this 1-in. product to the main mill building, where, after passing through a Vezin sampler, it is distributed into four steel storage bins. These four bins discharge by plunger feeders to four 6-ft. Akron Chilean mills. At this point a weak cyanide solution is introduced, the mills discharging a pulp through a 30-mesh screen, which flows and is distributed to thirty-six Wilfley tables. The concentrate from these tables is finished on six Wilfley finishing tables. This last set of tables yield heads, high in iron sulphide and containing some gold which goes to the smelter, and a silicious tailings, which after sliming in a tube-mill is mixed with the regular mill slime.

The tailing from the Wilfleys runs to four Akins classifiers, where it is divided into sand and slime. The sand goes to a continuous wash system (Akin classifiers) whence, after being washed free of soluble gold, it is hauled to the dump. The slime is pumped to thickening cones, where, after thickening it is reconcentrated on Card tables. The concentrate from the Cards join that from the Wilfleys. The tailing from the Cards runs to the Akins thickeners, the thick pulp from the same going to air agitators and thence to Portland filters, whence, after being washed free of soluble gold, it is hauled to the dump. The effluent solution from the Portland filters joins the clear overflow from the thickeners is clarified, treated by the Crowe vacuum method and by the Merrill precipitating process, and goes to the zinc-dust precipitating plant. The mill has a capacity of 500 tons daily, and uses only 1,000,000 gal. of precipitated water per month.

#### KALGOORLIE DISTRICT, WESTERN AUSTRALIA

The ores are silicious and contain pyrite and tellurides of gold and silver. There is but little free gold and that mainly in the pyrite. At the Kalgoorlie mills two systems of treatment grew up, the dry or roasting process as described for the Portland plant at Colorado Springs and the wet process. It soon was found that the telluride ores were not soluble in ordinary cyanide solutions, but bromo cyanide proved to be effective (see "The Bromo-cyanide Process.")

Grinding pans appear to hold their own in the treatment of telluride ores in the Kalgoorlie district. They are used for intermediate grinding, but for sliming, tube-mills are considered preferable to pans. The Forwood-Down pan has a classifying discharge, the pulp issuing from the pan by a row of 1-in. holes near the top. Outside the pan is a pocket or launder having a slot at the bottom leading back to the pan. Heavy sand

settles in this pocket and is returned through the slot while the fine flows over the outer edge of the pocket.

Gradually the filter-press on the Kalgoorlie field is being discarded in favor of vacuum-filters. In the past an immense sum has been spent on press plants, about 100 presses being erected, 75 of which are treating 100,000 tons monthly. The others are out of commission, but the benefit derived from this machine at Kalgoorlie has been admittedly large. With a press, washing can be carried to a degree that cannot be beaten, but the labor cost is high, and it is expected that the press will have to give way. The Associated Northern, Boulder, and Oroya Links filter their current mill slime by vacuum systems of their own, while others are talking about introducing the system.

#### THE OROYA-BROWNHILL MILL, KALGOORLIE DISTRICT

This uses a *wet* process of concentration followed by cyaniding. The ore after coarse crushing in a rock-breaker goes to the stamps. Here it is crushed in a weak solution of about 0.4 per cent or 0.8 lb. per ton of cyanide, kept alkaline by the addition of lime and the pulp run to hydraulic classifiers. Here in closed circuit with Wheeler pans, Fig. 135, the sand is finely ground, the classifier overflow then going to Wilfley tables. The concentrates from the tables receive a special treatment as follows:

These amount to 6 per cent of the ore milled and contain 11 ounces gold per ton and the great bulk of the refractory elements in the ore, thus leaving a tailings product well suited to subsequent cyaniding. The concentrate is sent to three single-deck Merton roasting furnaces similar to the Edwards furnace (Fig. 74), where it is roasted with from 0.5 to 2.2 lb. salt per ton, each furnace easily roasting 10 tons per day. The roasted product is removed by push conveyor as shown in the Edwards roaster to two pairs of Forwood-Downs 5-ft. pans in parallel. The first pair is used both for fine grinding and amalgamation, their overflow passing to the second pair used for fine grinding only. Mercury is added to the first pans three times daily, amalgamation recovery is about 30 per cent of the value of the concentrate. The second set of pans give an overflow which passes on for cyanide treatment. It is agitated in vats with mechanical agitators with a solution of 0.1 per cent or 2 lb. per ton for 100 hours, lime and lead acetate being sometimes added in the pans. The pulp is afterwards filter-pressed. The pregnant solutions are precipitated in ordinary zinc boxes using zinc shavings, that have been dipped in lead acetate solution.

Returning now to the tailings from the Wilfley tables, these are classified in closed circuit with tube-mills, so as to give an all-slimed product for cyaniding. This is dewatered or thickened and goes to the agitation

vats having mechanical stirrers. Here it is agitated with cyanide solution of 1 per cent or 2 lb. cyanide per ton for three hours, the cyanogen bromide is added at the rate of about 1 lb. for each ounce of gold and the agitation continued for twelve hours. About two hours before the completion of the agitation quick lime, 2 or 3 lb. per ton is put in. After agitation the pulp is discharged to a stirrer or agitator to keep it properly mixed while it is being pumped into the filter-presses. The gold-bearing solution from the filter-presses passes through clarifying presses and thence to the zinc boxes for precipitation. All the tailings are taken from the presses to the dump by conveying belt. In 1905 when the ore carried \$32 per ton in gold the extraction was 94.6 to 95 per cent.

#### THE HOLLINGER MILL, PORCUPINE DISTRICT, ONTARIO, CANADA

This is one of the new mills of the district and treats 499 tons of \$20 ore daily, recovering 93 per cent of the gold. The ore is of quartz and schist with a high percentage of pyrite. It is soft and easily crushed, yielding a heavy pulp which gives rise to some mechanical difficulties in the agitation. The gold is free. Treatment consists in **concentration**, cyaniding the **concentrates** and the **tailings**. Fig. 128 is a flow-sheet of this mill. The ore is coarsely crushed in two stages, the product from the first or gyratory breaker being screened by a trommel having 2½-in. holes. The oversize of this is crushed by a 20- by 10-in. Blake crusher so that a product of less than 2½ in. passes by belt conveyor to be distributed to the mill bins. Thence it is drawn off in regulated quantity by Challenge feeders to the stamp. It will be noted that the feed bins hold 2½ days' supply of ore. Stamp crushing is done in a solution of 1.5 lb. cyanide per ton, using 5 tons per ton of ore crushed. The ore is now crushed to 6-mesh size through Dorr classifiers and tube-mills in closed circuit. The overflow from the classifier is first again treated by means of large Spitzkasten, 20½ ft. long, 6 ft. wide, and 6 ft. deep to yield two products, an overflow for direct cyaniding and an underflow, a product that undergoes extensive concentration in order to recover the free gold. The underflow of 25 per cent solids is concentrated upon Deister slime tables similar to the Wilfley table (Fig. 84) yielding concentrates largely pyrite, containing the free gold and a tailings which joins the Spitzkasten overflow for cyanide treatment. The concentrate, comparatively free from solution, is taken by a spiral screw conveyor and bucket elevator to four small bins ready to be fed into Wheeler pans in charges of 1½ tons of the concentrate with 100 lbs. of mercury. After grinding for several hours the contents of the pans are discharged to 8-ft. settlers, Fig. 136, where the tailings overflow for cyaniding while the amalgam collects in the mercury well of the settler. Referring now to the various overflow products for cyaniding, these are pumped to Dorr

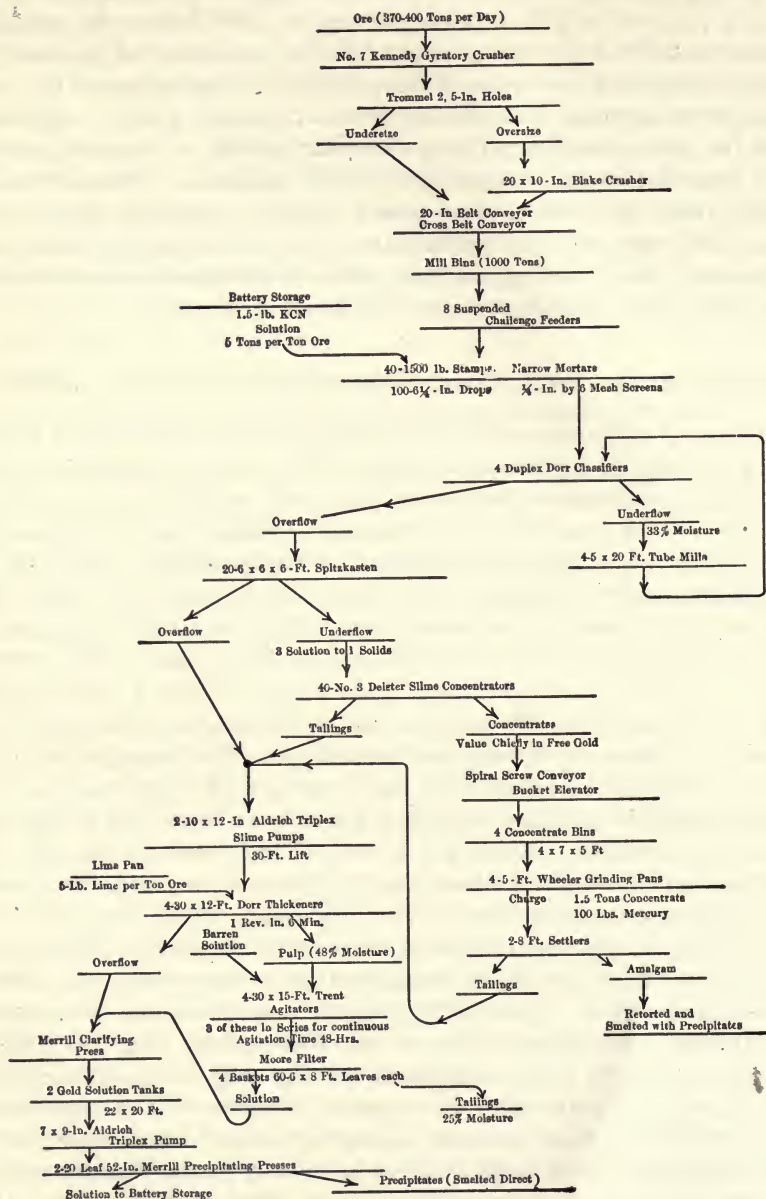

FIG. 128.—Flow-sheet of Hollinger Mill.



thickeners which deliver an underflow containing 50 per cent solids. With an addition of barren cyanide solution this product is agitated for forty-eight hours by Trent agitators in series and is then filtered by Moore suction filters to give a tailings that is rejected still holding 25 per cent moisture. The clear overflow of the Dorr thickener is joined by the filtrate from the Moore filters, but must be clarified before precipitation. Precipitation, using zinc dust, is performed as described under the head of "Merrill Precipitation Process." The filtrate returns as barren solution to the battery storage tank near the stamps.

#### THE TOM REED MILL, OATMAN, ARIZ.

The treatment is by cyaniding using continuous counter-current decantation. The gold occurs principally as hematite in quartz ore of low grade, but in large bodies. Referring to the flow-sheet, Fig. 129, the run of mine ore crushed through a gyratory and a Dodge jaw-crusher in series is reduced to a maximum size of  $2\frac{1}{2}$  in. and is taken by an inclined belt conveyor to the feed bins. A 16 by 16-in. steel chute at the bottom of the bin makes it possible to draw off the ore to a Stephens-Adamson apron feeder to a 6 ft. by 5 ft. ball-mill which grinds in closed circuit with a Dorr classifier, with addition to some pregnant cyanide solution from the decantation tanks. The overflow from the classifier passes to two pairs of similar classifiers on the floor below, each pair in closed circuit with a 5 by 6-ft. ball-mill. Here a further addition of pregnant solution results in a product 85 per cent of which is less than 200-mesh size, this fine grinding being necessary to ensure contact of the gold by the cyanide solution. The pulp thickened in the primary 40-ft. Dorr thickener to a specific gravity of 1.5 is raised to the first of four 40-ft. agitators, where it is agitated in series with addition of air. From the last of these machines the pulp passes to the lower of two Eronier sand pumps. The lower pump delivers to the upper one and that in turn to a distributing box. From this box, the pulp is divided between the head tanks of two series each of four Dorr thickeners, Fig. 103, operating on the continuous counter-current decantation system (C. C. D.). From the last of the series the residual tailings go to a settling pond. The overflow from the head tanks flows as already mentioned to the ball-mills and through them to the primary thickener. The nearly clear overflow of this thickener passes on to a vacuum classifier filter and after treatment by the Crowe vacuum method is precipitated with zinc dust by the Merrill precipitating process in a building near the barren solution sump. The filtrate from the Merrill process flows by gravity to two 6 by 6-ft. measuring tanks that are alternately filled and emptied by the action of a tilting launder operated by two floats, one



the tailings, is added in the fourth tank of each series. For refining there are provided two muffles where the precipitate is dried and roasted in pans and a Steel Harvey tilting furnace Fig. 3, where the roasted precipitate is melted down into an ingot.

#### THE UNITED EASTERN MILL, OATMAN, ARIZ.; 300 TONS DAILY CAPACITY

The ore is a mixture of calcite and quartz with some undecomposed andesite. It contains 1 oz. gold and but 0.34 oz. silver per ton. The gold is so finely disseminated that fine grinding is essential. Figs. 130 and 131.

**Treatment.**—This consists of (1) single-stage coarse crushing; (2) two-stage ball-milling in cyanide solution; (3) combined air and mechanical agitation; (4) straight counter-current agitation; (5) removal of air by the Crowe vacuum treatment; (6) precipitation by zinc dust using the Merrill process; (7) fluxing and melting the wet precipitate into bars.

With the exception of the Merrill filter-press for separating the precipitate no filters are used about the mill. It is remarkable that such a high-grade ore can be well extracted by counter-current decantation.

**Coarse or Preliminary Crushing.**—All lumps of ore that will pass a 10-in. grizzly are sent to a gyratory crusher, chosen rather for a sufficient-sized jaw-opening for the grizzly discharge, than for its capacity in excess, this being 35 tons per hour. Lately the fines of this run of mine ore have been screened out by grizzlies set at  $1\frac{3}{4}$  in. opening, thus relieving the crusher and reducing crusher repairs. It is now thought that this crushing might better be performed in two stages for the production of a finer product; it would secure a finer feed for the ball-mills that come next, thus increasing *their* capacity.

One should note here that for an assured supply, storage for several days should be provided. This point is often overlooked.

**Coarse Grinding.**—From the feed bin the ore is fed to the ball-mill by the traveling feeder, Fig. 320. The setting of a feed gate and the varying of the specific gravity of the pulp in a special Dorr classifier determine how thick a feed shall come out. The coarse grinding is done in a Marcy ball-mill in closed circuit with a Dorr classifier (see Fig. 40), forged chrome iron balls being used in the mill. The grinding is done in a 1.6 per cent KCN solution, showing 1 lb. protective alkalinity.

**Fine Grinding.**—This is done in two ball-mills 5 ft. diameter by 6 ft. long, also in closed circuit with Dorr classifiers, each mill being of 90 tons' capacity and giving a product, 82 per cent of which is minus 200-mesh. The mills both in the coarse and fine grinding discharge a product of 30 per cent moisture only.

**Agitation.**—From the fine-grinding department the pulp flows to No. 1 Dorr thickener, marked U on the flow-sheet, Fig. 131, arriving there with

a specific gravity of 1.12 and a dilution of 1 part ore to 4.5 parts solution. The thickened underflow from this thickener of a specific gravity 1.4 and amounting to 290 tons daily is pumped to the seven agitators Nos. 1 to 7

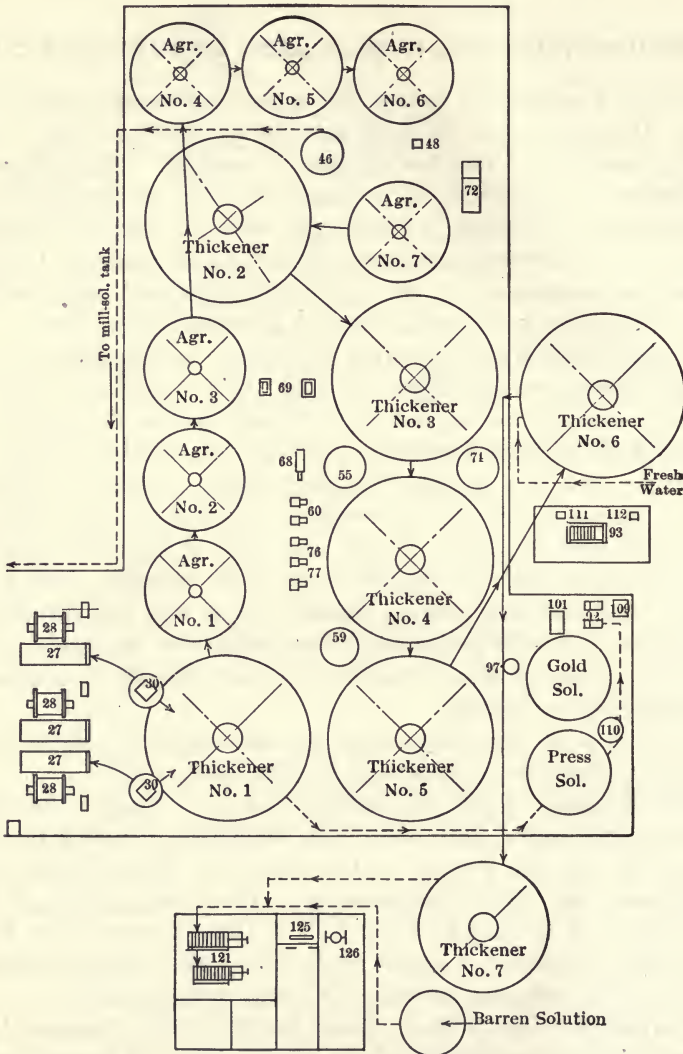

FIG. 130.—Plan of United Eastern Mill.

of the plan and indicated by the single rectangle A of the flow-sheet, there being an addition of 197 lb. of NaCN to the first agitator as this is done. The period of agitation is sixty-two hours for complete solution.

Agitation is carried on by air at a pressure of 30 lb. per square inch, using two belt-driven compressors of 15 kw. each.

**Thickening.**—From the thickeners *A* the pulp flows through five 40-ft. thickeners marked No. 2 to No. 6 on the flow-sheet and plan. These are arranged for straight counter-current work. The pregnant solution from No. 1 agitator after passing the zinc-boxes becomes barren solution to go to No. 4 thickener and the wash water is introduced at No. 6 thickener. The flow at No. 6 is split and about one-third is sent to No. 7 thickener (see the plan). The underflow discharges of Nos. 6 and 7 flow together to the tailings pond at a moisture content of 0.82 ton solution per ton of ore.

No. 1 or primary thickener, which takes the dilute overflow from the last Dorr classifiers, has a settling area of 4.37 sq. ft. per ton of ore. It is necessary to operate it with a low mud line to prevent colloidal material getting over into the gold solution tanks. About 870 tons of solution pass to the press solution vat while 600 tons go back to the mill storage.

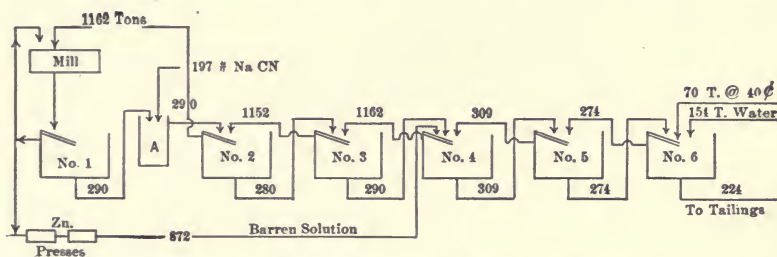

FIG. 131.—Flow-sheet of United Eastern Mill.

The regulation of the thickeners is maintained by varying the speed of the diaphragm pumps which feed them, the specific gravity of the discharge, and the depth of the mud line being recorded every four hours. In maintaining alkalinity lime is added dry to the Marcy mill feed. The loss per ton is \$3.215 and the loss of cyanide 0.525 lb. per ton of ore.

**Cost of Plant.**—The cost of the mill proper is \$133,539.09, to which should be added the crushing plant \$11,975.37, the coarse ore bins \$1,916.27, the refinery \$5,789.13, and the lime house \$272.54, or a total of \$153,492.40, which on a basis of 200 tons daily would be \$767.46 or \$2.13 per annual ton.

Operating costs are based upon \$5 per day for helpers, \$5.50 for mill men and \$6 for solution shift foremen.

In 1918 the cost of operations averaged for operating labor \$0.47, repair labor \$0.09, supplies \$1.06, power \$0.52, miscellaneous \$0.04, making a total of \$2.17 per ton. Coarse crushing cost \$0.07; coarse grinding \$0.32, and fine grinding \$0.50 per ton.

As respects particular costs also in 1918 per ton of ore: Those for

heating solution were \$0.03, of general expense \$0.18, of lighting \$0.008, of assaying \$0.03, sampling \$0.03, of tailing disposal \$0.02, of clarification \$0.04, and of precipitation \$0.12.

The metallurgical report shows in 1918 that 92,339 tons were milled carrying 100,903.02 of gold and 54,137.02 of silver. with a recovery of 96.75 per cent.

## CHAPTER XVII

### TREATMENT OF GOLD MILL CONCENTRATES

#### CLASSIFICATION

For this treatment it is recommended that for the grinding a tube-mill be used with a Dorr classifier in closed circuit. It yields an overflow, which passes on for agitation, and an underflow or spigot discharge, which goes back to the tube-mill. In this manner no granular particles can escape the grinding action of the tube-mill. The ground product goes to Dorr agitators followed by Dorr thickeners to be subjected to continuous counter-current agitation. Even then, before the tailings are sent to waste, they are filtered and washed, using Oliver or similar filters. On the other hand, the clear overflowing pregnant solution of full strength is sent to the Merrill precipitation and clarifying process. The solution is handled by aid of triplex plunger-pumps. For the above methods of treatment a side-hill location may be used, with ample fall throughout with good dumping ground below for the tailings. This should be so arranged that the tailings can be stored, not carelessly allowed to run to waste. In the planning, the all-gravity arrangement is preferred so as to avoid the use of troublesome bucket elevators and pumping. The raising of solutions by pumping is another matter, even to raising them 60 or 70 ft. from sump to supply tank; there is no grit in the solution, a fruitful cause of pump wear.

The concentrates which are to receive the special treatment above specified come to this special treatment plant, either in boxes filled from the head launder of the tables or in cars that have directly caught the product, or indeed into a launder that by aid of a stream of water carries it to the sump of a sand pump, this pump lifting it to collecting vats where it is drained before subjecting to the special treatment.

The stuff can be treated in several ways.

(1) It may be treated with strong cyanide solutions in ordinary percolating vats for an extended time.

(2) It may be stacked to expose it to the weather, then percolating it as in method (1).

(3) It may be shipped at once to the smelting works.

(4) It may be treated by chlorination.

(5) It may be all-slimes as outlined above, then agitated with cyanide solution and the tailings carefully filtered and washed.

(6) It may be roasted, then finely ground, agitated and the residue filtered.

A clean iron pyrite may be treated by method (1) with fair results, but time, cyanide consumption, and the necessary retreatment are against it. At a small mine in an out-of-the-way district, as a temporary method it is worth trying.

When concentrate to be treated by method (2) has been weathered, it becomes highly acid, and needs special alkaline washes.

According to method (3) all complex concentrates, that is, those containing copper, zinc, or lead, or complicating impurities, should be smelted, although in Western-Australia pyrite containing as much as 21 per cent arsenic has been roasted and cyanided with a 90 per cent extraction.

Chlorination or method (4) is not much used now. At Bendigo, Victoria, Australia, one custom "pyrite" works uses chlorine in the vats, and this pyrite contains as much as 12 per cent arsenic.

Referring to method (5) the concentrate plant of the Treadwell group of mines uses fine grinding and agitation with cyanide solution. At Waihi, Western Australia, a concentrate treatment plant specially treated 5368 tons in 1911 equal to 1.42 per cent of the ore crushed at the mills. This concentrate product contained 5.25 oz. in gold and 3.2 oz. of silver per ton, and the recoveries were 96.2 per cent of the gold and 94.8 per cent of the silver, at a cost of \$6 per ton of concentrates treated.

As to method (6), at many places the concentrate is roasted prior to cyanidation, especially at the Goldfield Consolidated, Goldfield, Nevada, and at Kalgoorlie, Western Australia. At the Ivanhoe mine at the latter place, the annual output to be treated is 24,000 tons, which is collected in ordinary tanks roasted in five Edwards furnaces, Fig. 74, mixed with cyanide solution, ground in five 5-ft. pans, Fig. 135, agitated and filtered. An extraction of 95 per cent was obtained at a cost of \$2.68 per ton.

The five mills on Douglas Island, Alaska, contain a total of 900 stamps, and crush approximately 5000 tons per day. The crushed ore after amalgamation is concentrated on 360 Frue vanners, yielding an average of 90 tons of concentrate per day, of from 2.5 to 4 oz. gold per ton. To treat this product, a cyanide mill, owned jointly by the Alaska-Treadwell Gold Mining Company, the Alaska Mexican Gold Mining Company, and the Alaska United Gold Mining Company, was built to treat the concentrate made in their various mills, and has proved an unqualified success.



## THE ALASKA-TREADWELL CONCENTRATE TREATMENT-PLANT

consists of three buildings situated on a hillside 200 ft. above the stamp-mill. The upper building contains the grinding and amalgamating plant, with a lower floor for solution-storage tanks. The lower contains the cyanide equipment proper, while the refinery is in a concrete building at one side. The flow-sheet of operations is shown in Fig. 133.

The concentrate is received in two 100-ton steel storage bins, 4, 4, 15 ft. diameter, with 55° conical bottoms. Here it is kept covered with water, which effectually prevents oxidation of the sulphides. From this point until the cyanide treatment begins, the concentrate is in strong lime solution at all times. At the apex of the conical bottom of each bin, tight-fitting gates control the outflow, which is at once sluiced directly into Dorr

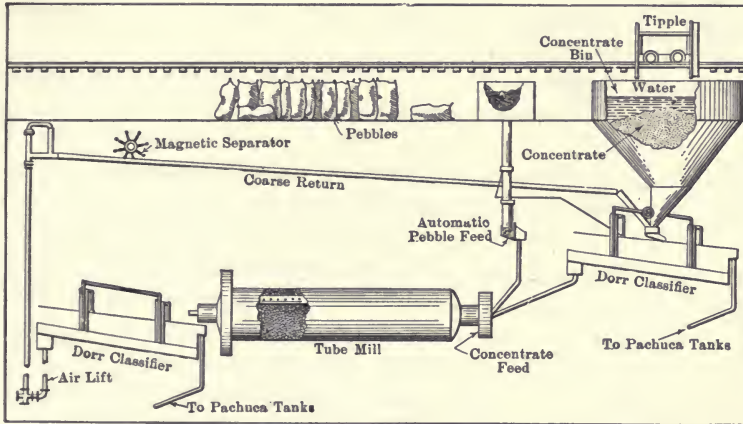

FIG. 132.—Outline of Tube Mill Circuit, Alaska-Treadwell Mill.

classifiers, 5, 5. The sluicing medium is the coarse return product referred to later. There are two Dorr classifiers driven by one 7.5 H.P. electric motor, one feeding into each tube-mill and making twenty-four strokes per minute. This rate of speed (causing greater agitation) was found necessary to separate the large bulk of the fine from the coarse.

The coarse product of the classifiers falls into the spiral feeders of the tube-mills. These mills, 6, 6, are of the Abbé type, 5 by 22 ft., with corrugated sectional liners: and 3-in. Danish flint pebbles are used for the grinding. Amalgamation was formerly part of the process, but the whole product is now being cyanided direct without this. From a sump in the launder, an air-lift elevates the pulp to a spitzlutte, from which the coarse material is continuously drawn into a Dorr classifier, 11, the coarse from which feeds a 4 by 12-ft. Abbé tube-mill, 12, similar to the larger ones



This is equal to the regular charge of 30 tons of concentrate with 40 tons of solution. The floors under the Pachuca tanks, as well as all other floors in the building, are of smooth concrete, sloping to a central sump, supplied with small pumps to return any escaped solution and to pump it to the proper tanks.

The first cyanide treatment consists of eight hours' agitation in a 2-lb. (0.1 per cent) cyanide solution, either potassium or the mixed cyanides being successfully used. Alkali is kept at 1.25 lb. (0.063 per cent) of lime (CaO) per ton of solution. Lime is added during the treatment if the titrations show below that figure; eighteen hours is allowed for settlement and decantation of this solution. Decantation takes place through a flexible hose.

The long settlement allowed, with the excessively fine condition of the concentrate, its high specific gravity, from 4.6 to 5.0, and the high alkalinity of the solution, leaves a 30-ton packed mass in the bottom of the Pachuca. This is brought into agitation within fifteen minutes by a device designated as the "spider," which is an adjustable hollow annular casting with radiating fingers, the whole encircling the central agitation-column, see Fig. 100.

The second cyanide treatment of the charges is with solution drawn from the barren-solution storage tanks or the wash-solution storage, the cyanide strength being 1.5 lb. (0.075 per cent) per ton of solution. After two hours' agitation the air is shut off and almost immediately decantation is started. This decanted solution is pumped directly on to an incoming fresh charge, being strengthened in cyanide as it enters the tank, and becoming the first cyanide solution for the new charge. This cycle in handling solution—barren to wash-solution, then to second cyanide treatment at 0.075 per cent cyanide, then to first treatment at 0.1 per cent cyanide, thence to precipitation and back to barren—gives at each step, just the conditions best suited for that step, and is very satisfactory in practical operation. The settled pulp after the second decantation has a specific gravity of 1.8, and is readily agitated by means of the spider, and then discharged into the pulp-storage tank by a Byron Jackson 4-in. centrifugal pump.

Filtering is done in two type-1-B Kelly presses. By opening valves in the circulation-lines directly under each press it is filled with either pulp or wash-solution as desired. The excess pulp or wash-solution from the press-cylinder is returned into its proper line by displacing with compressed air admitted into the cylinder. The amount of wash given depends upon the comminution of the concentrate, the usual pulp being washed with 0.5 ton of solution per ton of concentrate. The cake formed during decantation of the first treatment-solution, being very fine slime and more impervious to wash-solution than the regular pulp, is given 1 ton of wash

per ton of concentrate. When filling the press, the contained air is allowed to escape through an overhead pipe attached to the highest point of the press-cylinder. The change in sound of the exhaust indicates to the pressman when the press is full. After drying the cake with compressed air until it contains not more than 10 per cent of moisture, the press is opened and the cakes shaken off with wooden paddles, and then sluiced with water to the tailing-dam. A distributor below the press-laundry sends the gold-solution to two gold-sumps and the wash-solution to the two wash-solution storage-tanks. These four tanks, as well as a clarifying-tank which is in the same group, are built of 3-in. redwood, 15 ft. in diameter by 16 ft. deep, and each holds 75 tons of solution.

The wash-solution is pumped to a Pachuca tank as needed, becoming a second-treatment solution. From the gold-tank the solution is drawn into the clarifying-tank, in which are suspended vertically six canvas filter-leaves, all connected to the suction of a triplex 7 by 9-in. Aldrich electric pump, used exclusively for pumping gold-solution through the precipitation-presses. A traveling-belt, driven by ratchet-gears and a pair of eccentrics connected to the pump-drive, feeds zinc-dust into a cone. Here the dust is emulsified with a small stream of gold-solution tapped from the discharge-column of the same pump, and is then drawn into the suction-line. An automatic float in the cone prevents the introduction of air into the pump-suction. The pump raises the solution with the zinc dust to the upper part of the building and forces it through two 36-in. triangular, 16-frame Merrill presses. An average of 145 tons of solution is precipitated daily, with a consumption of 1-3 lb. of zinc dust per ton of solution, equivalent to 0.86 lb. of zinc dust per ton of concentrate. The average strength of solution before precipitation is 1.25 lb. (0.0625 per cent) of cyanide; 1 lb. (0.05 per cent) of lime, and \$9.50 (9.2 dwt.) gold. The barren or precipitated solutions are kept at 10 cents (2.3 grains), or less, gold per ton, and are used for wash-solution or returned to the Pachuca tanks, as desired.

#### CONCENTRATE-TREATMENT AT THE GOLDFIELD CONSOLIDATED MILL GOLDFIELD, NEV.

The raw concentrate amounting to 6 per cent of the weight and containing 67 per cent of the value of the ore, is collected in flat-bottomed-agitator tanks. It is here neutralized with lime and pumped to three Pachuca agitators, in which it is agitated during eight-hour periods in a 2-lb. solution of cyanide. Decantation at the end of the period is still practiced and the charge is re-agitated with a freshly precipitated solution. Five periods of eight hours each, followed by decantation, are sufficient to remove from 80 to 85 per cent of the value of the concentrate. It is the intention to send to the roaster a product valued at \$25 to \$30, and this

treatment is varied with the grade of the ore so as to accomplish this result. The pulp from the Pachucas, when dissolution is completed, is delivered to a storage tank from which it is pumped to Kelly filter-press for filtration and drying. This drying is accomplished with air and the moisture is reduced to 12 per cent. The consumption of cyanide during the raw treatment is 2.5 lb. per ton and lead acetate is used in the proportion of 1 lb. per ton of concentrate.

The product is dumped into a bin, and a 14-in. conveyor, set at an angle of 17°, carries it over a Blake-Dennison automatic weighing machine en route to the bins in the roasting plant. The concentrate from this conveyor is distributed by means of a swinging bucket elevator to two bins having 45° sloping bottoms and 1620-cu. ft. capacity, from which it is fed by means of two 12-in. screw-conveyors, making three-quarters of a revolution per minute, to two slow-moving belts. These belts discharge the concentrate through the arches of the furnace between the first two rabbles.

Roasting of concentrates is done in two 54-spindle duplex Edwards furnaces, each having 1456 sq. ft. hearth area. The capacity of each furnace is 40 tons of concentrates per day, although the amount roasted in the two furnaces is approximately 55 tons per day. The raw concentrates, after a preliminary cyanide treatment, assay 1.23 oz. Au and 18.76 per cent S, the sulphur, after roasting, being reduced to 0.90 per cent. The cost of roasting, per ton of concentrate, is \$0.82; while the complete cost of the two furnaces, dust flues, stack, 65 by 158 ft. steel building and miscellaneous bins and machinery amounted to \$70,459.16. The concentrate loses 17 per cent of its weight in roasting; and of the 1½ per cent of the material passing out of the furnace as dust, only ½ per cent is lost out of the stack. Five Merton furnaces for the roasting of 120 tons per day of Kalgoorlie sulpho-telluride ore cost \$38,900.

The bins are filled on the day shift, and have sufficient capacity to run for twenty-four hours. Each furnace requires 4½ H.P. By means of iron goose-neck flues, the gases from the roasters at a temperature of 450° F. are delivered to a concrete dust-flue 264 ft. long, having a cross-section of 50 sq. ft. From this flue, 20,700 cu. ft. of gases per minute escape through a steel stack, 100 ft. high and 54 in. diameter having a temperature at the base of the stack of 325° F. Velocity of the gases in the dust-flue is 7½ ft. per second.

The roasted ore is discharged into a Baker cooler, 5 by 22 ft., revolving in water with about 40 per cent submergence. It is delivered to one tank for twenty-four hours, then settled and decanted to a consistence of 1 to 1 and sulphuric acid added in the proportion of 20 lb. per ton of concentrate. Agitation with the sulphuric acid is continued for eight hours. Water is then added to fill the tank and the charge allowed to settle. When clear, the wash is decanted and the tank refilled with fresh

water. Four water washes are given, equivalent to eight tons of wash water per ton of concentrate. All washes are clarified and the overflow sent to six redwood tanks, 10 ft. diameter and 5 ft. high, arranged in series for recovering the copper. These tanks are kept filled with cyanide tins and all kinds of scrap from the mill. The average copper content of the washes is 0.4 lb. per ton, and 70 per cent is recovered.

The thoroughly washed charge is neutralized with lime, and by means of centrifugal pumps elevated to one of four Pachuca agitators, 14 ft. diameter by  $25\frac{1}{2}$  ft. high. Here the roasted charge is agitated for eight hours in a 2-lb. solution of cyanide, containing 1.2 lb. CaO as protective alkali. At the end of eight hours, agitation is discontinued, the charge settled, decanted, and re-agitated with a freshly precipitated solution in the same manner as described above in the treatment of the raw concentrate. Five periods of agitation followed by decantation are given, and a total of 3 tons of solution per ton of concentrate is decanted. Consumption of chemicals amounts to  $4\frac{1}{2}$  lb. cyanide and 2 lb. lead acetate per ton of concentrate. After agitation is completed, the settled charge is delivered to a storage tank 18 ft. diameter by 8 ft. high, fitted with the adjustable square-shaft agitator. Placed centrally in the bottom of this tank is a 4-ft. cone with pipe connections through which the thickened pulp is fed to a 5 by 18-ft. tube-mill. The pulp issuing from the tube-mill is elevated by means of a belt and bucket elevator back to the above-mentioned storage tank. This circulation grinding is continued for sixteen hours, at the end of which time 95 per cent of the material will pass a 200-mesh screen. From 80 cents to \$1.25 per ton is removed in this circuit. Since the change of solution increases extraction and since the final tailing is sent to the mill proper for filtration, it was decided to re-grind after the greater part of the gold had been removed. After re-grinding, the pulp is delivered by means of a centrifugal pump to the filter storage tank in the mill proper, mixed with the mill pulp, filtered, and sent to waste. Costs are as follows: Labor, \$1.02; power, \$0.78; and total supplies, \$3.88; making a total cost of \$5.68 per ton. During 1912 results were as follows: value of raw concentrate, 6.58 oz. gold; value after treatment, 1.23 oz. gold; recovery, 81.3 per cent; value of tailing after roasting and treating 0.097 oz. gold; recovery, 92.16 per cent; total recovered from roasted material, 17.23 per cent; and recovered from both treatments, 98.53 per cent.

The treatment at each plant was as follows:

(A) Raw concentrates are agitated in 2 lb. KCN solution for five eight-hour periods, decanting after each period; after filter-pressing, they are roasted in two Edwards duplex 54-spindle furnaces. The roasted concentrates are agitated for eight hours in  $H_2SO_4$  solution (20 lb. acid per ton of concentrates). After four water washes, the charge is neutralized and agitated in 2 lbs. KCN for five eight-hour periods, decanting after each.

CYANIDATION OF GOLD BEARING CONCENTRATES

Plant.	Daily Production in Tons.	ASSAY OZ. PER TON.		% EXTRACTION		KCN per ton Concentrates. lbs.	COST PER TON OF CONC'TS.						
		Au.	Ag.	Au.	Ag.		Grinding.	Roasting.	Dissolution.	Acid Treatment.	Filtering.	Precipitate and Refining.	Total.
A—Goldfield, Cons., Nev. . . .	55	6.58	..	98.53	..	7.	.33	.82	2.34	.77	.30	.18	\$5.68
B—Alaska, Tread- well. . . . .	75	2.92	..	96.5	..	2.3	.57	..	.78	..	.22	.81	2.81
C—Geldenhuis Deep, Transvaal	..	16.0	..	98.75	..	3.3	3.65	..	2.67	..	..	..	6.32
D—Oriental, Cons, Korea. . . .	..	2.2	..	93	..	..	..	..	..	..	..	..	2.87

Then it is tube-milled for sixteen hours and sent to the regular plant filter, using 3 lb. lead acetate per ton of concentrates. (J. W. Hutchinson, Min. and Scientific Press, January 25; February 1, 1913.)

(B) Clean and docile pyritic concentrate is ground through 200 mesh; agitated in 1.5 lb. KCN for eight hours; decanted; agitated for four hours with barren solution; filter-pressed and precipitated by zinc dust. (1911 Mine Report, Min. and Scientific Press, June 29, 1912.)

(C) Mill scrap and black sands. After amalgamation, the concentrate pulp for cyanidation (98 per cent 200 mesh) assays 16 oz. Au. (R. Lindsay, J. C. M. & M. So., S. A.)

(D) All-sliming in a tube-mill with KCN, then forty-eight hours' combined air agitation and leaching, followed by filter-pressing.

**Aëration.**—Oxygen-absorbing compounds, such as pyrrhotite, hornblende, etc., not only cause an increased cyanide consumption, but frequently reduce the extraction of the gold by robbing the solution of its oxygen. Suitable oxidation of the pulp, prior to the application of cyanide solution, by forcing compressed air through the charge, renders many of these oxide-consuming compounds harmless.

**Roasting.**—In the treatment of ore in which the gold is intimately associated, either physically or chemically, with such telluride compounds as sylvanite or calaverite, or with arsenical or antimony compounds, preliminary roasting is frequently the only known recourse. The practical object of the roast is to so liberate the gold as to permit ample contact with the cyanide solution and destroy deoxidizers and cyanicides. (A "dead" or "sweet" roast is usually essential.) The most extensive application of roasting is at Kalgoorlie, though some Cripple Creek ores receive

this preliminary treatment, as do the graphitic ores of the Ashanti Goldfields. In the treatment of rebellious concentrates by cyanide, roasting plays an important part at the Goldfield, Nevada, plant.

The usual furnaces are the Edwards, Merton, Pearce, and Holthoff.

On the telluride ores of Kalgoorlie, crushed through approximately 28-mesh roasting with Edwards and Merton furnaces, costs approximate 65 cents per ton of ore. The sulphur content of the raw ores varies from 3 to 6 per cent, although the elimination of the sulphur affords only a rough indication of the success of the roast. The hearth area, per ton of ore roasted per day, varies from 17 to 29 sq. ft. Consumption of wood varies from 10 to 13 per cent of the weight of the ore. The temperature is approximately 650° C.



## CHAPTER XVIII

### VARIOUS TREATMENTS AND CALCULATIONS

#### FLOTATION AND CYANIDING AND CALCULATIONS

**Concentration by Flotation, Cyaniding or Smelting the Concentrates and Cyaniding the Tailings.**—The method would be suited to a low-grade gold ore, that, owing to its refractory nature, could not be profitably treated by cyaniding.

**First Case.**—The ore would be all-slimes, then subjected to flotation, yielding a small proportion of high-grade flotation concentrate and a clean tailing for cyaniding. The concentrate would be subjected to special cyanide treatment as described under head of "treatment of gold mill concentrate."

**Second Case.**—The ore would contain copper or zinc sulphides that would interfere with cyaniding. The ore would be crushed, saving the concentrate and wasting the tailings. The concentrates would then be shipped to the smelter.

**Third Case.**—The ore could be cyanided and the tailings concentrated. In this case the aim is to treat by cyaniding alone, but from the tailings to recover some concentrates by means of flotation. The concentrate would be subjected to special cyanide treatment.

#### DRYING AND CYANIDING

The ore of moderate grade contains graphite that would interfere with cyaniding. The crushed ore would be dried at  $150^{\circ}\text{C}$ . so as to render the graphite inactive and less flocculent. It would then be cyanided.

#### TREATMENT OF TAILINGS FROM ACID OR AMMONIA LEACHING

The original ore has a quartz gangue. If treated by sulphuric acid leaching it must have but little lime or magnesia carbonates. If treated by ammonia those carbonates do not interfere. In either case the ore carries oxidized copper minerals and even some microscopic metallic copper. The copper having been removed the tailing is in fair state to recover any contained gold or silver by cyaniding (see "Sulphuric Acid or Ammonia Leaching of Copper Ores.")

#### CALCULATION OF TONNAGES IN MILLS

In wet-crushing mills, concentration and hydro-metallurgical works it is often desirable to measure the water and ore handled, either the amounts

contained in tanks or the quantities passing in a given time. In some mills such measurements are systematically made, but in others the amounts are merely guessed, or they are measured once and ever after assumed to remain constant. Discrepancies between theoretical and actual recovery are due to errors in sampling and assaying the material before treatment, added to the corresponding errors affecting the material after treatment, and multiplied by errors in the estimate of the tonnage treated. The last item is therefore fully as important as the others in calculating probable returns.

The tonnage of sand in vats filled by settling under water is best ascertained by means of boxes of stout sheet iron (conveniently made of exactly 1 cu. ft. capacity, but in any case accurately measured), having a number of small perforations in the bottom and provided with handles. Several of these are placed in the vat at various stages of the filling, and are allowed to remain throughout the treatment. While the vat is being discharged these are carefully removed and "struck" level; the contents are then dried and weighed, giving the pounds of dry solid per cubic foot. Several charges should be thus tested and averaged to obtain a constant value for the ore or tailing treated. It is desirable to place some of these boxes near the center and others near the periphery of the vat, so as to represent variations in horizontal as well as vertical distribution. The mean weight per cubic foot and the volume of sand in the charge give the total weight of sand. While cubic boxes are often used, a cylindrical form is preferable, as being less liable to deformation.

In estimating the cubic content of a round vat several diameters should be measured (preferably three or four making equal angles with each other at about the middle depth), and for the greatest accuracy a similar set of measurements should be made near the bottom and another near the top, the arithmetic mean of all the diameters measured being used in the computation. In supposedly cylindrical wooden vats of over 25 ft. diameter differences of 6 in. or more may be found, due to imperfect construction, to settling, or to unequal shrinkage of the staves, owing to their upper portions being intermittently dried while the lower ends remain wet.

If  $D$  be the internal diameter, and  $H$  the depth, in feet, of a cylindrical tank, the volume is  $0.7854 D^2 H$  cu. ft.,  $0.024544 D^2 H$  fluid tons,  $5.89 D^2 H$  U. S. gallons, or  $4.008 D^2 H$  imperial gallons.<sup>1</sup>

<sup>1</sup> The U. S. gallon will hold  $8\frac{1}{4}$  lb. of water, the British imperial gallon 10 lb. of water. The percentage  $P$ , of dry slime in the pulp, is computed by the formula

$$P = 100 \frac{S(a-1)}{a(S-1)},$$

where  $S$  is the sp. gr. of the dry slime, and  $a$  the sp. gr. of the wet pulp. The sp. gr. of the pulp can be ascertained by a hydrometer or by weighing a unit measure of it.

The capacity of a filter-press is most accurately determined by blowing the charge as nearly dry as possible before opening, then selecting a certain proportion of the frames at equal distances from end to end of the press, weighing the entire content of each separately, and taking an individual moisture sample from each frame tested. The dry weight of slime in each is separately calculated and the average multiplied by the number of frames.

In ascertaining the weight of solid in a vat filled with uniformly liquid pulp, such as slime in an agitator, a cubic foot or any convenient measured volume may be dried and the residue weighed, whence the weight in the entire volume is obtained by proportion. If the mixture is weighed before drying the percentage of solid in the pulp may also be found.

A much easier and more rapid method is to find the specific gravity of the pulp, either with a hydrometer or by weighing a liter or other convenient volume. The density of the dry solid must also be known, at least approximately. Knowing these two values, specific gravity of mixture and density of dry solid, the weight of dry solid per cubic foot can at once be calculated.

## CHAPTER XIX

### SMELTING OF GOLD ORES

#### BLAST-FURNACE SMELTING VS. CYANIDING OF GOLD ORES

Gold may be recovered from its ore by the processes of silver-lead, or of copper-matte smelting. It often is found in copper- or lead-bearing ores and when in excess of 0.02 oz. per ton, is paid for by the smelting works at the rate of \$19 to \$19.50 per ounce. Practically all the gold is recovered in smelting, and this would be the best method of treatment were it not for the high cost of freight and for treatment. If smelted near the mine in a works operated by the mining company, the cost of freight is eliminated. The charge for lead-free, fairly silicious ores, from Cripple Creek and from Boulder county, Colorado, is from \$4 to \$10 per ton, according to grade. The low-grade ores are subject to a low-treatment rate. On the other hand, ore treated by milling and amalgamation, or by cyanidation, while the extraction is less, often yields higher net returns. A sample is found in the case of the silicious gold ore from Boulder county, Colorado, containing 0.5 oz. Au per ton, giving 70 per cent extraction by milling and amalgamation, or of 90 per cent by cyanidation. In comparing the costs we have:

SMELTING		
100 per cent of 0.5 oz. Au at .....	\$19.00	\$9.50
Mining .....	2.00	
Freight .....	1.50	
Treatment .....	4.00	7.50
		<hr style="width: 50%; margin-left: auto; margin-right: 0;"/>
Net returns .....		\$2.00
MILLING AND AMALGAMATION		
70 per cent of 0.5 oz. Au at .....	\$20.50	\$7.17
Mining .....	2.00	
Milling .....	1.00	3.00
		<hr style="width: 50%; margin-left: auto; margin-right: 0;"/>
Net returns .....		\$4.17
CYANIDATION		
90 per cent of 0.5 oz. Au at .....	\$20.50	\$9.23
Mining .....	2.00	
Cyaniding .....	1.65	3.65
		<hr style="width: 50%; margin-left: auto; margin-right: 0;"/>
Net returns .....		\$5.58

From the above comparison it is seen that cyaniding is the most profitable method of treatment for this grade of ore, and at this place.

**THE PRICE OF GOLD ORE, ALSO COST OF PRODUCING AND SELLING  
THE PRICE OF GOLD**

**Price of Gold Ores.**—When lead free or so-called dry ores containing gold (and silver) are sold to a smelting works they are paid for on the basis of dry ore, which see under head of "Purchase of ores, silver-lead smelting."

**Costs at the Belmont Tonopah Gold Mill in 1914-1915.**—This mill of 500 tons daily capacity has, per ton of ore put through, labor, \$0.419; supplies, \$1.318; power, \$0.419, using 1.68 H.P. per ton; being a total of \$2.156 per ton of daily capacity.

**Costs at the Homestake Gold Mill in 1915.**—Cost of stamp-milling and amalgamating, \$0.2811 per ton of ore. The tailings from the mill were reground at a cost in 1914 of \$0.1264 per ton of product reground. By classification, this reground material yielded two products, sand and slime. The sand was leached in vats 44 ft. diameter at a cost of \$0.1772 per ton. The other product, the slime, was all filter-pressed and all the slime plant operating costs were \$0.1838 per ton in 1914.

**Costs at the Modderfontein Gold Mill.**—Rand district, South Africa, in 1914, the cost was \$0.686 per ton of ore milled.

Speaking broadly the treatment cost per ton of concentrate will vary between \$2.50 and \$5 per ton, depending upon tonnage cost of supplies delivered at the plant, also labor. The extraction of gold, using the all-sliming process varies between 90 and 97 per cent on a raw concentrate amenable to cyaniding, as at the Oriental Cons., the Alaska-Treadwell, the Esperanza, Waihi and elsewhere.

The price of gold as sold to the mints is unchanging, being \$20.67 per troy ounce, 1000 fine. From this the mint makes a deduction of 2 cents per ounce to cover the cost of melting and assaying.



PART III  
SILVER





## CHAPTER XX

### SILVER, ITS ORES AND THEIR TREATMENT

**Physical Properties of Silver.**—This is the whitest of metals, harder than gold, softer than copper, more malleable and ductile than any but gold, and the best of conductors of heat and electricity. Its specific gravity is 10.5; it melts at  $962^{\circ}$  C. and boils at  $1850^{\circ}$  C., then volatilizing and yielding a green vapor. When pure and molten it will absorb oxygen, which when the metal again solidifies causes the so-called spitting of the metal, well known to assayers.

#### CHARACTERISTICS OF SILVER ORES

The silver minerals of importance in treatment are as follows:

Native silver, which sometimes occurs as flakes or leaves, and as wire-silver and metallic silver adherent to native copper. Native silver can be readily amalgamated, but when present in particles of visible size it is so slowly soluble in cyanide, that practically no extraction can be obtained.

Cerargyrite (horn-silver, silver chloride),  $\text{AgCl}$ , is widely distributed. At mines it is found in the upper oxidized zones. It is probable that much of the so-called chloride ore is really a chloro-bromide (embolite). The ore is readily amalgamated and is free-milling. The silver chloride of it also is readily soluble in cyanide and in sodium hyposulphite solutions.

Argentite,  $\text{Ag}_2\text{S}$ , is one of the common silver ores. By using chemicals (bluestone and salt) it can be amalgamated in pans, and the silver extracted thus from the ore. It is soluble in potassium cyanide solution.

Stephanite,  $5\text{Ag}_2\text{S}, \text{Sb}_2\text{S}_3$ ; pyrargyrite,  $3\text{Ag}_2\text{S}, \text{Sb}_2\text{S}_3$ ; proustite,  $3\text{Ag}_2\text{S}, \text{As}_2\text{S}_3$ ; drycoasite,  $\text{Ag}_3\text{Sb}$ , are silver sulph-arsenides or sulphantimonides, refractory in amalgamation, even with chemicals, sparingly soluble in cyanide solution, but readily soluble in a solution of mercurous potassic cyanide.

Finally we have those silver sulphides that contain also copper. These are polybasite,  $9(\text{Ag}_2\text{Cu})\text{S}(\text{SbAs})_2\text{S}_3$  and tetrahedrite (gray copper ore, fahlerz),  $4\text{CuFeAg}_2(\text{HgZn})\text{S}(\text{SbAs})\text{S}_3$ , the most complex of all, in which the silver varies from 0.06 to 31 per cent, being higher in the arsenical and lower in the antimonial varieties. These sulphides are refractory to any amalgamation method and because of their copper content are precluded

from treatment by cyanide, even when roasted. This does not interfere with treatment by hyposulphite lixiviation after roasting.

A number of rare minerals containing silver could also be enumerated, but for the metallurgist the minerals above named are the important ones.

Silver ores in general contain but a small percentage of precious metal. They are composed mostly of gangue (waste matter of the ore) and many are treated that contain less than 0.1 to 0.2 per cent silver. Thus we have at the Comstock Lode, Nevada, silver in native form and as sulphide, but oxides of iron and manganese with the associated sulphides, pyrite, blende, galena, and chalcopyrite. At the Ontario mine, Park City, Utah, the silver occurs as argentite and tetrahedrite in a gangue of quartz and clay associated with a little of the heavy minerals blende and galena. These sulphides carry silver which is recovered with the concentrate in case of concentration.

### THE EXTRACTION OF SILVER FROM ORES

Silver is extracted from its ores by milling methods, and by smelting. Certain ores contain the silver in a form suitable for cyaniding, and in consequence that method of treatment is coming forward. The other methods have largely dropped out of use. No reason appears why hyposulphite lixiviation should not revive under the stimulus of the recent methods of agitation and filter-pressing. The patio process formerly much practiced in Mexico where conditions favored, has been superseded by cyaniding in many cases, on account of the lower cost of operating the latter process, but in the past, large quantities of silver have been extracted by the patio process.

### TREATMENT OF SILVER ORES

These, as in the case of gold ores, may be treated by milling or by smelting. Milling processes, with the exception of amalgamation, are called hydrometallurgical methods. Since these methods are often combined with amalgamation and concentration it would appear that all might better be grouped under head of silver milling. We may divide the methods of silver milling into:

#### A. *Amalgamation.*

- (1) *Wet silver-milling, or the Washoe process.*
- (2) *Plate and pan amalgamation and concentration.*
- (3) *Dry silver-milling, or the Reese River process.*
- (4) *The patio process.*

#### B. *Milling using hydrometallurgical processes.*

- (1) *The Augustin process, based upon the solubility of silver chloride in brine.*

(2) *The Ziervogel process*, dependent on the solubility of silver sulphate in hot water.

(3) *The Patera process*, in which silver chloride dissolves in a solution of sodium hyposulphite.

(4) *The Russell process*—a modification of the Patera process in which a so-called “extra solution” is used.

(5) *The cyanide process*, in which the silver minerals either with or without roasting, dissolve in dilute cyanide solution.

## CHAPTER XXI

### AMALGAMATION OF SILVER ORES

The silver ores suitable to treat by milling and amalgamation are those that contain the metal in such form as to be acted upon by mercury when assisted by agitation, heat, and certain chemicals. The ore is first crushed fine by stamps, as in gold milling, then treated for several hours in grinding pans, the reactions being slow compared with those of the amalgamation of gold. In gold milling, the greater part of the gold can be arrested on an apron-plate during the few seconds in which the ore is passing over it, while in silver milling, the ore-pulp has several hours' contact with mercury, aided by heat and chemicals, and is but slowly amalgamated. In gold milling, ore containing 0.5 oz. Au per ton can be profitably milled. In silver milling, ore of equivalent value would contain 10 oz. Ag per ton, or 20 times as much metal. Thus is seen why so much time is allowed in silver milling, and why so many precautions must be taken to be sure that all metal possible is recovered. Several ounces of silver per ton often remain in the tailing.

The silver metals suited to pan amalgamation are cerargyrite (horn-silver, silver chloride), native silver in flakes, wire, or other forms, and certain silver sulphides, notably argentite ( $\text{Ag}_2\text{S}$ ). When the ore is refractory, containing arsenical and antimonial sulphides, and especially containing tetrahedrite, galena, or blende, it is necessary to roast with salt, setting free the silver or converting it into the form of a chloride, which becomes susceptible to amalgamation. There is no sharp line of demarkation between free-milling and roasting-milling ores. Often the upper part of a vein is free-milling while in depth base metals and sulphides begin to come in, and it finally becomes necessary to roast the ore. The best extraction therefore is obtained from decomposed or oxidized ore, in which the silver materials occur in a form that renders possible the action of the mercury. There are few deposits of oxidized ores containing silver chloride and native silver that as a whole are suitable for free silver milling. Such ore, so far as silver chloride is concerned, can also be treated by cyanidation, but the latter method would not recover native silver.

Arsenic and antimony compounds interfere with amalgamation by fouling the quicksilver, checking the reactions of the chemicals added to

promote amalgamation, and by carrying off silver, which is incapable of being amalgamated with them.

The **Washoe process**, developed through the combination of the California stamp mill with an elaboration of the Norwegian Tina for fine grinding and amalgamation (pan) and the chemicals of the Patio process, was introduced for the treatment of Comstock ores in 1860. This amalgamation process, adapted to American conditions, rapidly assumed the same position in the United States for the treatment of silver-gold ores as was occupied by the patio process in Mexico for the treatment of the same class of ores.

A later development when treating complex ores was to give a chloridizing roast preceding grinding and amalgamation in the pans. This was known as the **Reese River process**.

### (1) WET SILVER-MILLING WITH TANK-SETTLING

This is also known as the Washoe process, receiving the name from the place where it was perfected for the treatment of ores from the Comstock Lode, Nevada. The process is applicable to the so-called free-milling ores, in which the silver occurs native, as chloride or in small amount as argentite. The ore should be free from lead and from any tough clayey gangue.

In wet silver-milling, the process consists in coarse-crushing the ore, stamping it fine, and collecting it in settling-tanks. The crushed sand is ground in amalgamating-pans using mercury to collect the silver. The sand is separated from the silver-bearing mercury in settling-pans and is rejected. The amalgam is strained from the mercury, retorted, and the retort-residue melted into silver ingots. Gold present in the ore is recovered as well as the silver. The process resembles gold-milling except that amalgamation and the removal of the amalgam is effected in pans.

Fig. 134 is a sectional elevation of a wet-crushing tank-mill for the treatment of free-milling silver ores. The ore from the mine is amalgamated on plates precisely as in gold milling, which see. The coarse crushing is done during the ten-hour day-shift.

Water (6 to 8 tons per ton of ore) is at the same time supplied in the mortar, and forms a pulp, which is splashed through the 30-mesh screens by the motion of the stamps using a double-discharge mortar. The large screen-opening possible with a double discharge favors a more rapid pulverization than would be possible with a single-discharge mortar. The pulp flows by launders *f* into the settling-boxes or tanks *g* 7 ft. square by 3 ft. deep. There is a double row of these tanks, twenty in a row, occupying the length of the mill in front of the stamps. The flow of the pulp is from box to box in series, until it goes by launder to a settling-pond outside the mill. Most of the solids settle in the first boxes, a further portion

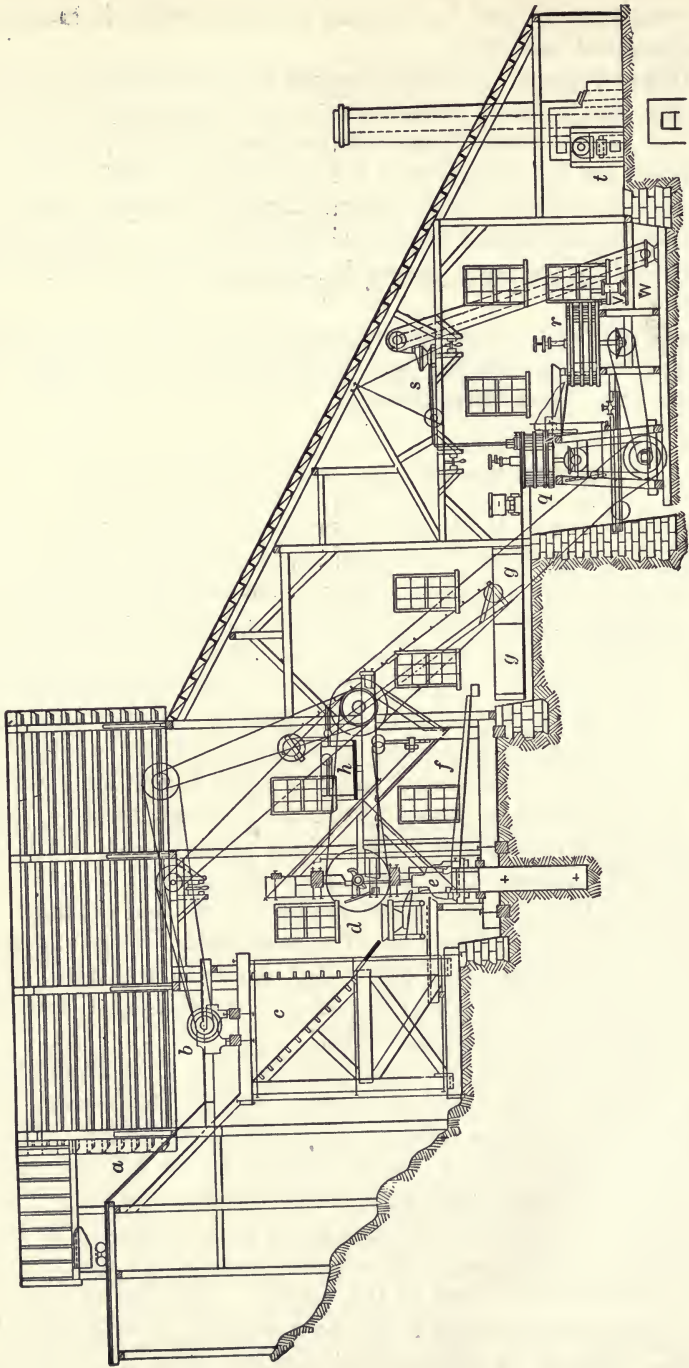

FIG. 134.—Wet Silver Mill.

dropping in the succeeding ones, and the turbid water passing to the pond. Here it has its final chance to settle before running to waste, or it may be again used in the mill if water is so scarce that it pays to do this. The settled slime is dug from the pond at a later time and treated like the rest of the crushed ore.

A variation of this method, shown in Fig. 134, consists in conducting the flow from the last box *g'* by an inclined elevator to a tank *h* situated in front of and above the battery, the dirty water being again used for stamping. When the first settling-box is full the flow of the pulp is by-passed into the next one. The contents of the full box are shoveled upon the floor adjoining, and thence taken as needed to the amalgamating-pans *q*. The emptied box has the flow of the last one turned into it, thus making it the last in the series, and the launders are so arranged that this can be done.

The ore, thrown out upon the floor, is fed directly into the pans or loaded into the tram-car seen in Fig. 134 and conveyed to them.

Fig. 135 represents a pan.

It is 5 ft. diameter by 30 in. deep, and is furnished with a central sleeve or cone through which rises a shaft carrying a cylindrical casting called a spider, which becomes bell-shaped and broadens into feet below. The spider carries, bolted to the feet, a flat cast-iron ring called a muller, and to the under side of the muller are attached six shoes or plates of chilled cast-iron  $2\frac{1}{2}$  in. thick. The spider, muller, and shoes are raised or lowered as desired, by means of a hand-wheel and screw at the top of the shaft, which is driven by

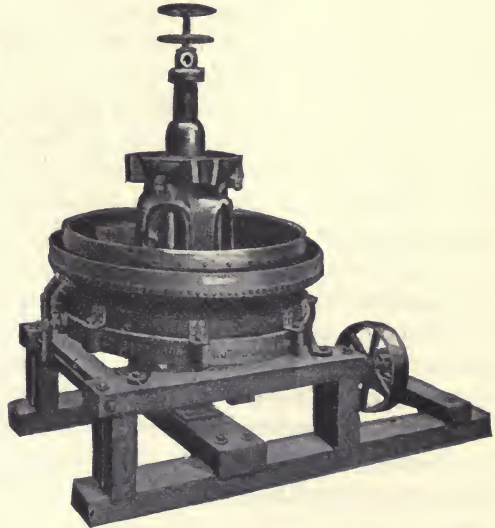

FIG. 135.—Five-foot Continuous Grinding Pan.

bevel gearing from the horizontal shaft and pulley below. Upon the bottom of the pan rest chilled cast-iron plates or dies that furnish the lower or fixed grinding surface. The shoes attached to the muller revolve 60 R.P.M. and rubbing upon the dies, grind the ore.

In working the pans, the shoes are raised  $\frac{1}{2}$  in. from the dies and set in motion, the pan is partly filled with water, and 3000 lb. of the damp pulverized ore is shoveled in. The ore and water nearly fill the pan and the mixture is stirred until it is of the consistence of honey. The motion estab-

lishes a movement or current of pulp beneath the muller toward the periphery. At the periphery it rises, flows toward the center, sinks, and passes again under the shoes. To assist the action, the rising pulp is deflected inward by cast-iron wing-plates.

After thorough mixing in the pan the shoes are lowered until they touch the dies, and grinding goes on for  $1\frac{1}{2}$  hours, the content of the pan being meanwhile heated nearly to boiling by steam under pressure from a pipe that dips beneath the surface of the charge, the pan being covered.

After grinding, the shoes are raised and 300 lb. of mercury (10 per cent the weight of the ore) is added, by sprinkling it through a fine strainer. The mixing is then continued four hours. The mercury takes up silver most rapidly at first, but the action afterward slackens. The globules of mercury suspended in the pulp take the silver as they come in contact with it. Care is taken to have the pulp of the right consistence so that mercury will not settle out. This condition is shown when a wooden stick, dipped in the pulp and withdrawn, is found to be covered with a thick mud in which are disseminated minute globules of mercury. If the ore is refractory, salt and copper sulphate are advantageously added at the beginning of grinding to accelerate the reactions, promote amalgamation, and increase the yield of silver.

The charge above treated having been amalgamated, the pan is ready to empty into the settler *r*. About fifteen minutes before the discharging, the speed of the muller is reduced to 40 R.P.M. and the pan filled to the top with water. A plug closing the discharge opening at the bottom of the pan, seen at the left in section, Fig. 135, is pulled out, and the entire content run by launder to an 8-ft. settler, at a lower level, shown at the right of the amalgamating-pans in Fig. 134. Emptying the pan and washing it with a hose takes half an hour, after which time the plug is replaced, and the pan is ready for another charge. Thus the total time for the cycle of operations described is six hours, making it possible to treat four charges daily.

The reactions that take place in the pan are as follows:

Native silver in threads, films, flakes, or grains readily combines with the mercury and forms an amalgam which contains a large excess of mercury.

Silver chloride in contact with the mercury decomposes as follows:

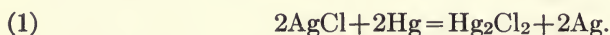

The metallic silver liberated amalgamates with additional mercury. The particles of iron, abraided from the stamps and the bottom of the pan, decompose the mercury salt and liberate the mercury as follows:

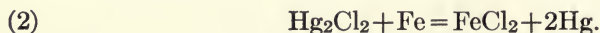



Many so-called free-milling silver ores contain argentite which in part is decomposed by mercury as follows:

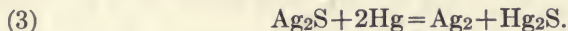

The sulphide of mercury thus formed is lost. We have already stated that chemicals, notably copper sulphate and common salt, are added to promote the decomposition of the silver sulphide. There is added in the amalgamating-pan from 6 to 18 lb. salt and from 3 to 9 lb. copper sulphate per ton of ore treated. The reactions as generally given are the following:

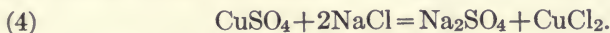

The chloride of copper acting on the silver sulphide decomposes it:

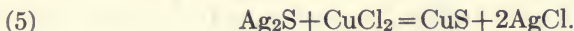

The silver chloride amalgamates as shown by reaction (1).

The complete separation of the mercury with the silver-amalgam is effected in the settler, there being one settler provided for two amalgamating-pans. The settler is 8 ft. diameter by 3 ft. deep, three times the capacity of the amalgamating pan, but of similar construction, as shown in Fig. 136. No grinding is required, but the pulp must be agitated with the wooden shoes with which the settler is provided. The shoes nearly touch the bottom of the settler, the exact height being adjustable. The grooved border at the bottom just within the sides of the settler has a slight grade to the outlet and mercury-well at the left. The mercury settles from the pulp, flows to the lowest point and stands at a height that balances the hydrostatic head of the content of the pan. Since the specific gravity of mercury is 14 and the content of the settler approximately 1.5, the height of the mercury is a little less than 4 in. The bottom outlet-hole of the well is plugged. At different heights in the side of the pan there are provided openings that are kept closed by plugs. When the plugs are withdrawn the tailing and water, free from mercury, pass out of the pan.

The shoes of the settler having been set in motion, at the rate of 15 R.P.M., and raised 8 in. above the bottom, the contents of the two pans are run in, as has been described. Water is then added to within 6 in. of the top, greatly thinning the pulp, and filling the settler. After half an hour the shoes are gradually lowered until, at the end of two hours, they nearly touch the bottom. The purpose of the agitation is to keep the lighter portion of the ore (now called the tailing) in suspension, while the silver-bearing mercury, the heavier particles of sulphide, and the particles of iron from the stamps collect at the bottom. The stirring is continued  $3\frac{1}{2}$  hours, after which the highest plug in the side of the settler is removed, and the turbid water containing tailing is allowed to escape by launder, a stream of clear water being meanwhile allowed to flow through. The

plugs are then withdrawn one by one until the settler is emptied of all the content except the heavy portion containing sulphide, iron particles, and the mercury. Emptying takes half an hour, and the cycle of operations becomes six hours as in the case of the amalgamating pan. Since escaping tailing contains sulphide, it may be run over riffles, or blanket-lined launders, before running to waste.

The silver-bearing mercury or diluted amalgam, a mixture of silver-amalgam and mercury, collecting in the mercury well, overflows by an

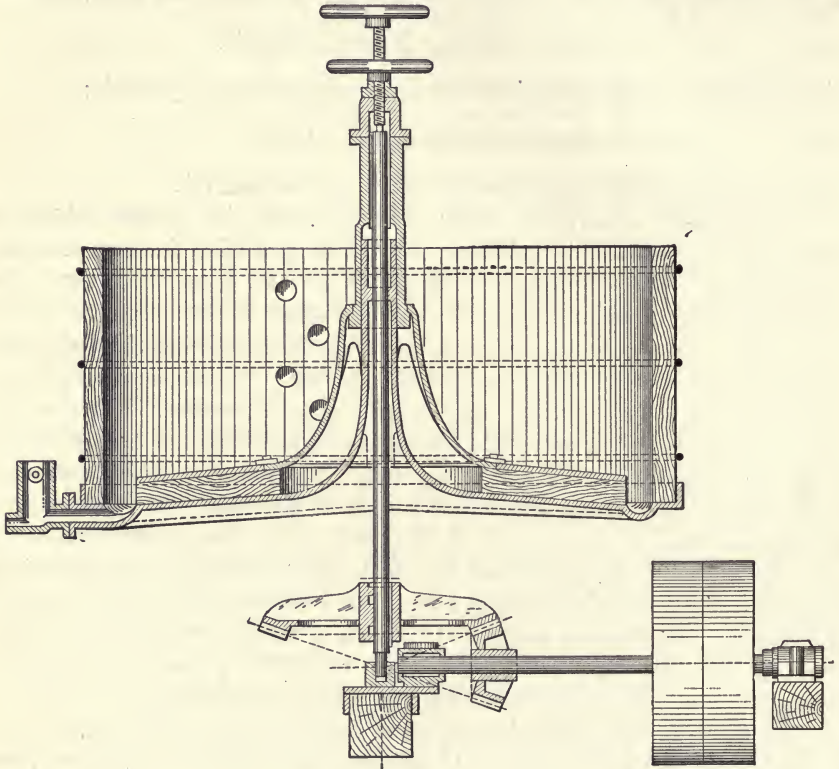

FIG. 136.—Eight-foot Settler.

escape-opening indicated in Fig. 136. From the opening it passes by a half-inch pipe to the amalgam safe shown at the right of the settler, Fig. 134. The safe, arranged to prevent theft of the amalgam, is shown on a larger scale in Fig. 137. The amalgam and mercury enter a conical canvas sack or filter. The mercury oozes through the pores of the canvas while the amalgam containing as little as 14 per cent silver is retained. Occasionally, after amalgam has accumulated, the sack is squeezed between the hands to remove the surplus mercury, and the compressed amalgam containing 20

to 28 per cent silver, is reserved for retorting. The mercury flows out at the bottom through an outlet provided, as seen in Fig. 137, and is collected at a lower level in the boot *w*, Fig. 134, of the mercury elevator, shown at the right. The elevator discharges to a mercury tank *s* commanding the amalgamating pans, to which it is delivered as needed through the pipe shown in the figure. Over the stamps and the pans are seen the overhead tracks that carry crawls by which the heavy parts of the machines are lifted or transferred. This facilitates the work of repairs and replacements.

The loss of mercury is commonly 1 to 1.5 lb. per ton of ore treated. A part is lost in handling, but the principal loss is the flouing, which causes the mercury to escape in the tailing. The loss is greater with talcose or clayey ores, and in those carrying cerussite, chalcopryrite, or galena. Loss is caused by grease coating the particles of mercury, in case this enters the ore from the machinery.

**Treatment of the Amalgam.**—Since the weight of metal recovered in silver milling is much greater than in gold milling, the retorting of amalgam must be performed on a larger scale. Fig. 138 shows a sectional elevation and a plan of a combined retorting and melting furnace with the overhead crawl and chain-blocks by which the large melting crucibles are lifted from the fire in the melting furnace and transferred for pouring. At the left is shown in the elevation a cross-section of the cast-iron cylindrical retort which is 10 in. diameter inside by 28 in. long, resting upon arched cast-iron supports. There is a horizontal pipe, and a vertical water-cooled pipe, not shown in the illustration, in which the mercury condenses and from which it falls into a tub of water below. As seen in the plan, the front end of the retort is provided with a cover which can be securely clamped in position.

The charge of amalgam, containing 20 per cent mercury, should weigh 500 lb. and only half fill the retort. After filling, the cover is clamped on, first luting the joint with flour paste. A wood fire is started on the grate under the retort. The temperature is kept low at first, increasing to a red-heat at the end,  $\frac{2}{3}$  to  $\frac{3}{4}$  cord of wood being used. The operation lasts ten to fourteen hours, care being taken not to heat the retort rapidly, nor, for fear of blistering it, to raise the temperature too high. The fire is then allowed to burn down, and the retort to cool. The lid is taken off



FIG. 137.—Amalgam Safe.

and the silver residue removed to a crucible. This is seized by basket-tongs, which clasp it firmly so that it can be lifted by the chain-hoist, transferred by the crawl to the ingot mold, and poured. These molds, 11 in. long by  $4\frac{1}{2}$  in. wide and deep, hold 1000 oz., or 70 lb. silver.

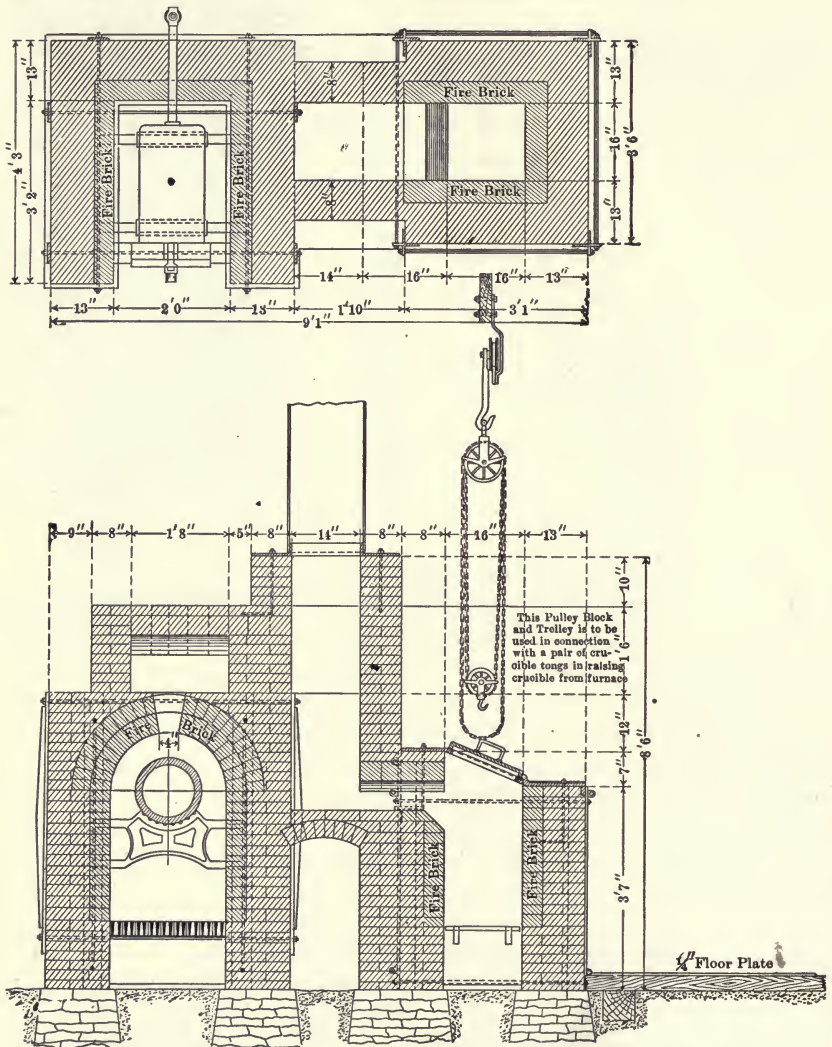

FIG. 138.—Horizontal Retort and Melting Furnace for Silver Mill.

The settler tailing contains heavy unaltered ore which may be concentrated to recover heavy sulphides and particles of amalgam.

**Costs.**—The costs of pan-amalgamation with tank-settling (Washoe process) in 1910 per ton of ore treated is:

Power.....	\$0.087
Labor.....	0.361
Chemicals (salt, acid, bluestone).....	0.465
Loss of mercury.....	0.750
Wear of pans.....	0.200
Wear of dies and shoes.....	0.400
Oil, interest, and superintendence.....	0.100

---

Total cost per ton..... \$2.363

One notes in particular the larger cost of supplies (chemicals, mercury, and castings) compared with like items in gold milling.

### THE BOSS PROCESS OF SILVER MILLING

This system, originated by M. P. Boss, a California engineer, differs from the Washoe process in being continuous and generally requiring less labor. However, the Allis-Chalmers Co. has designed, for the Washoe process, a wet-crushing mill in which the settling-boxes have sloping bottoms, so arranged that the content is transferred to the pans with but little labor. This takes away the advantage urged in favor of the Boss system. It may be added that the settling of the pulp in large tanks, combined with a mechanical system of excavating the content as in the cyanide process, ought to be efficient and labor-saving. The Boss system may be applied to free milling ores and to refractory ores that need to be first roasted.

### THE HIGH-GRADE NIPISSING MILL, COBALT, ONTARIO

The ore, containing native silver and argentite, together with the arsenides of cobalt and nickel (6 per cent Ni, 7 to 8 per cent Co, 40 per cent As), after being crushed to 70-mesh at the sampling mill, is delivered at the plant with an average content of 2600 oz. silver per ton. It is fed to a tube-mill (see Fig. 149), 20 ft. long by 4 ft. diameter. The charge consists of 3½ tons of ore, 4½ tons of mercury, and a 5 per cent cyanide solution. The tube-mill is closed at both ends. Air, to accelerate chemical action, is introduced through a pipe.<sup>1</sup> There is also an ingenious device whereby the excess of air is subsequently expelled. After nine hours in the tube-mill, 98 per cent of the silver has been extracted from the ore, which, in the form of pulp, then passes to a settler, where the amalgam is separated by gravity. Thence it goes to a clean-up pan and drainers. These last are canvas bags for removing any excess of mercury.

The pulp and solution, deprived of amalgam, pass to a vat and are fed to a Butters filter, the clarified solution going to zinc boxes where

<sup>1</sup> As the result of the oxidation of the arsenides the temperature of the charge would rise to the boiling-point were not the air supply to the barrel controlled.

the dissolved silver is precipitated on zinc shavings, thus obtaining an additional 2 per cent recovery. The shavings are in the form of coarse wire, necessary on account of the strength of the cyanide solution. The residue, left on the filter, containing 8 to 9 per cent cobalt, is afterwards sold for the value of this metal plus 85 per cent of the silver contents, so that from ore of 2600 oz. silver per ton, only about 4 oz. of silver value is lost.

The amalgam, containing 80 per cent mercury and 20 per cent silver, is placed in retorts, each of which holds 450 lb. After the mercury has been distilled, the silver, still containing 1 per cent mercury, is taken to a reverberatory furnace. Here it is melted in a charge of 25,000 oz. After fifteen hours' exposure to a hot oxidizing atmosphere, without addition of any flux, the molten metal is cast in ingots, each weighing 1100 oz. silver, which is 999 fine. Two oil-burners afford the necessary heat. The flue from the furnace is provided with a water-jet condenser, whereby 1000 to 2000 lb. mercury is arrested monthly. The gases escape at 100° F. During February, 1912, 550,000 oz. of silver was melted in this small plant.

The richness of the mine product under treatment and the completeness of the metallurgical operations leave a vivid impression. Within a small building it was possible to watch the successive stages by which a complex ore of a refractory type yielded its precious content in metal of such purity as to be ready for the mint. The entire process is so expeditious that the silver is delivered at New York within a week of the day when the ore is received at the mill and payment for the yield is received concurrently with the shipment. No less than 20 tons of mercury is in use at a given time. The cyanide has a cleansing action upon it; indeed, the use of mercury would be impracticable without the cyanide, for the mercury would become "sick" or fouled, so as to hinder amalgamation with the silver in the finely ground arsenical ore. The yoking of cyanidation and amalgamation constitutes another remarkable feature.

The right half of the flow-sheet, Fig. 149, gives a clear idea of the progress of operations. The product received consists of two-thirds hand-picked ore of 2800 oz. per ton, the rest, jig products of an average value of 2400 oz. per ton.

## (2) PLATE AND PAN—AMALGAMATION AND CONCENTRATION OF SILVER ORES

This is used on ores carrying silver, gold, and sulphides of the heavy metals, such as galena, blende, and pyrite, and sulphides which contain silver and gold. It is necessary that the silver not in the sulphides be amalgamable, as is silver chloride, argentite or native silver.

The process consists in wet-stamping the ore, running the pulp over apron-plates as in gold milling, concentrating the sulphides, which are

shipped to the smelter, and, as in the Washoe process, pan-amalgamating the tailing and retorting the amalgam to recover the silver and gold.

Compared with either wet or dry silver-milling, the process has much to commend it. The ore being refractory, the wet process would recover little value. The tonnage stamped by the dry method with roasting would be low compared with wet-stamping, which is one and one-half to twice as rapid. It is true that by dry-stamping and roasting we are able to extract at least 10 per cent more metal than can be obtained by raw amalgamation, but this is offset by the cost of treatment and the loss of precious metal in roasting. The process also saves lead and removes galena, sulph-arsenides,

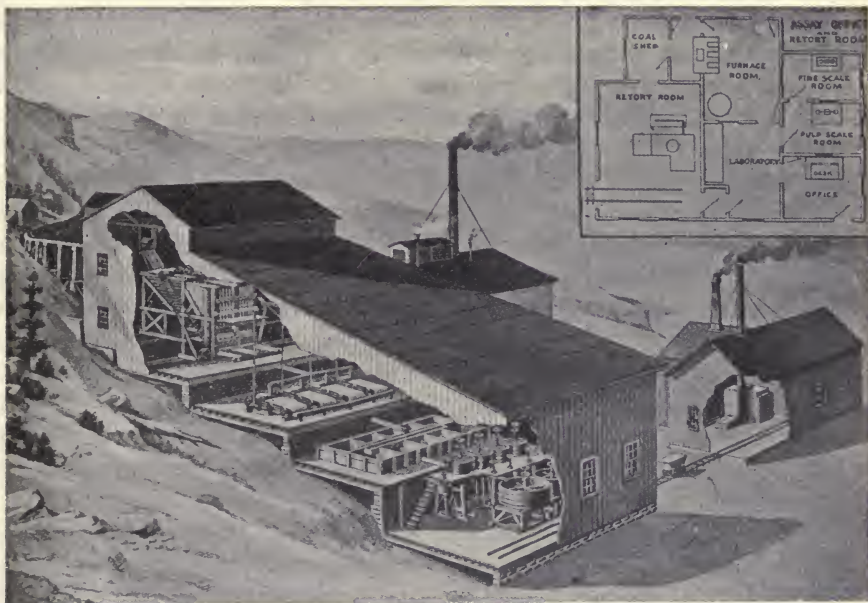

FIG. 139.—Stamp Mill Using Amalgamation and Concentration.

and sulph-antimonides, all of which tend to foul and cause the loss of mercury. Such minerals are not amenable to amalgamation, and by removing them for smelting there results a cleaner or higher-grade bullion. Manganese minerals that consume chemicals in the pan are also removed by concentration.

**Amalgamation and Concentrating Mill.**—Fig. 139 is a perspective view of a 10-stamp mill. Let us suppose we are to treat an ore, in part oxidized, but containing the heavy minerals of lead and copper, with pyrite, arsenides, and manganese minerals. The ore contains the precious metals, a gangue of quartz, calcite, and a little clay, and disseminated through it gold and the amalgamable silver minerals cerargyrite, argentite, and native silver.

The purpose is to save the precious metals by plate and pan-amalgamation, and the heavy minerals with silver and gold by concentration. Some of the silver and gold escapes recovery and is lost in the tailing. Since sulph-arsenides and manganese minerals are mostly removed, they do not interfere with subsequent pan-amalgamation where arsenic would sicken the mercury and manganese consume chemicals.

The ore and water are fed automatically to a 10-stamp battery, each stamp crushing 4 tons per twenty-four hours to pass a 30-mesh screen. The pulp issuing from the mortar flows over two apron-plates (one for each five-stamp mortar) and a part of the gold and silver is recovered. The flow is distributed evenly to four concentrating tables at a lower level, the concentrate (10 per cent of the whole) being separated to ship to smelting works, while the tailing is carried to the ten settling-boxes in a double row. These are seen at the left of the pans. The distribution is into a double launder between the two rows. By drawing the plugs in the bottom of the launder, the flow can be directed into any box desired. From this point on, the operation is conducted as described for the Washoe process. There are four amalgamating-pans and two settlers. Bluestone and salt are used to decompose the argentite. Mercury or amalgam escaping the apron-plates finds its way into the settling-boxes and thence to the pans, and is more thoroughly recovered than if it depended upon obtaining it in the concentrate as in gold-milling. The four 5-ft. combination grinding and amalgamation-pans each treat 3000 lb. per charge, and with a four-hour treatment, this equals 36 tons daily, which with the 4 tons of concentrate already mentioned is a 40-ton output of the mill. Some ores, not so readily treated, take six to eight hours, and lessen the capacity of the mill accordingly.

In a certain ore of this kind, containing 0.40 oz. Au and 9.02 Ag per ton the recoveries on the apron plates were 22 per cent of the gold and 3 per cent of the silver respectively; at the concentrating tables 28 and 32 per cent; in the pans and 32 and 35 per cent; lost in the tailing 18 and 30 per cent. Of the lead and copper 85 per cent was saved in the concentrate.

Concentrating adds but little to the cost of this milling, so that \$3 per ton may be taken as a fair estimate in 1910.

#### THE CHLORIDIZING ROASTING OF SILVER ORES

Silver ore containing sulph-arsenides, sulph-antimonides, or tetrahydrite, cannot be treated directly by amalgamation nor by cyaniding. Such ore is subjected to a roast with salt to convert the silver into a chloride, before it can be successfully treated by these methods. The above minerals are often accompanied by pyrite, blende, chalcopyrite, and galena.

Preliminary to roasting, such ore is dry-crushed, either by rolls or by



stamps. Ores containing galena and blende are preferably crushed to 40-mesh size, those having pyrite to 8 to 10 mesh. The "Roasting" is done in a reverberatory furnace, and requires the use of salt. There must also be 3 to 8 per cent pyrite present to furnish sulphur for the reactions, and if the ore does not contain this, it must be added. If more than 8 per cent sulphur is present, the percentage is reduced to that point by roasting before the salt is added. The amount of salt required varies according to the quantity of copper and iron sulphides present which consume the evolving chlorine.

**Chloridizing Roasting.**—This operation is at first an oxidizing one conducted at the temperatures specified in the chapter on roasting. The action is chiefly upon the heavy metals, converting them into either oxides or sulphates. It may be divided into three stages: (1) the kindling, (2) the desulphurization, and (3) the chlorination of the ore.

**First Stage.**—In the first or kindling stage we find the loosely held sulphur being driven off, and the ore taking fire, producing a blue flame.

**Second Stage.**—In the second stage, the air oxidizes the sulphides, and particularly the newly formed iron sulphide. Reacting upon the sulph-antimonides and arsenides, it volatilizes them and removes them from the ore. Copper and iron sulphates are also formed, the latter according to the following reaction:

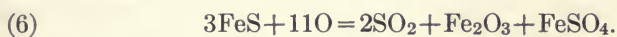

**Third Stage.**—In the third stage, at  $590^\circ \text{C.}$ , the sulphate formed in conjunction with air reacts upon the salt, thus:

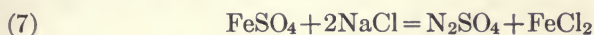

and



The chlorine thus liberated acts at once upon the silver compounds and converts them into chlorides. Thus:

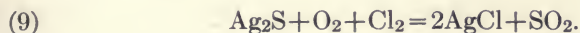

Zinc blende becomes oxide and zinc sulphate, while sulphur dioxide escapes. Galena and zinc sulphate remain inactive and fail to decompose the salt. They roast slowly, while pyrite, in presence of salt, decomposes quickly, and generates chlorine at a period in the roasting when neither the blende nor galena is sufficiently oxidized to expose silver to the action of the chlorine. If, therefore, the salt is mixed with the ore at the battery, the chlorine generated by the reaction of the ferrous sulphate and salt is lost, an imperfect chlorination results, no matter how long roasting is continued, nor how much salt is added. Hence in roasting an ore containing

blende and galena it is of the greatest importance to add the salt later and not at the battery. On the other hand, if the roasting continues until the sulphides are well oxidized, the iron sulphate decomposes and no chlorine is generated, and again we have a badly chloridized ore. The desirable time to add the salt is after continued roasting at a low heat that does not break up the iron sulphate. This is shown when the black color of the ore changes to brown, but shows still the presence of black particles. A distinct odor of chlorine is then to be noticed, due to the decomposition of the salt. The best results could be obtained by adding a mixture of green vitriol (ferrous sulphate) and salt; but the ore would hardly justify the expense.

The salt is added to the dry ore at the time of charging, if the percentage of sulphur is suitable, or later if the excess of sulphur must be first removed by roasting. The temperature is increased only gradually to kindle or start the ore to burning and to begin oxidation. As the temperature rises oxidation and the formation of sulphates occur, and at the necessary high temperature these act upon and decompose the salt and chloridize the ore.

**Heap Chlorination.**—It is not considered necessary to continue the roasting to convert all possible silver into chloride, but to withdraw the charge while hot before this stage is reached. During the gradual cooling (twelve to thirty hours) further chloridizing proceeds, due to the mass action of the free chlorine, with which the ore is saturated, acting on the undecomposed silver sulphide. This may increase the chloridization 10 to 40 per cent.

Upon completion of the operation of "heap chlorination," as it is called, and with ores containing copper chloride, a wetting down or sprinkling causes an additional chlorination of 3 to 6 per cent. Thus at the Lexington mill, Butte, Mont., the ore, after roasting in a Stetefeldt furnace, was chloridized to 65 per cent, after two hours in the heap to 75 or 80 per cent, and at the end of thirty-six hours to 92 per cent of the silver content.

The loss in silver by volatilization, when the ore has been properly and carefully roasted, should not exceed 8 per cent except in presence of volatile elements like arsenic, antimony, selenium, or tellurium. If, however, the roasting is completed at a high temperature the loss may rise to 18 per cent.

**Remarks on the Chloridizing Roast.**—The most difficult, and at the same time the most important process for the treatment of base silver ores by wet methods, is undoubtedly chloridizing roasting. It is always the safest plan for the operator to roast as thoroughly as possible. If the ore is well chloridized, sodium hyposulphite or cyanide extracts all the silver chloride. A high chloridization does not necessarily involve a high loss by volatilization. It is well suited to refractory manganese silver ores, as

most of the silver is converted into a readily soluble silver chloride. It has never been favored for gold ores on account of high volatilization losses; in fact, this is also the weakest point with silver, since silver chlorid is quite volatile.

**Chloridizing by Blast-roasting.**—The Dwight-Lloyd machine, Fig. 83, bids fair to be successfully used for a chloridizing roast. It is claimed that the volatilization of the silver is entirely under control, and moreover the cost of roasting is low.

### (3) DRY SILVER-MILLING (REESE RIVER PROCESS)

This process for the treatment of rebellious silver ores, in which the metal is so locked up as to require roasting before it can be amalgamated, was developed at Reese River, near the Comstock Lode at Virginia City, Nev. The ore contains silver sulphide, particularly the antimonial sulphides, and the sulphide of the base metals such as copper, iron, zinc, and lead. Galena, however, if present exceeding 5 to 10 per cent, renders the ore unsuitable for chloridization.

The treatment in brief consists in dry-crushing and roasting the ore then amalgamating in pans to recover the silver and gold. The dry-crushing is done either with rolls or stamps. Crushing with rolls is described in the chapter on Crushing. If dry-stamping is employed the work is done in the dry-crushing silver mill.

### (4) THE PATIO PROCESS

The patio, or Mexican amalgamation process, was introduced by Medina into Mexico as early as 1557, and has been practiced in that country down to the present time. The ores best suited to it are silicious ones carrying finely disseminated native silver, silver sulphide, and chloride. A limited amount of pyrite, galena, cerussite, or the copper minerals may be present without serious interference with the process, but much blende causes low extraction. Where any gold occurs this is not recovered.

In outline, the process consists in finely crushing the wet ore, and treating the mud or fine product in a flat pile in a large paved yard or patio, salt and bluestone being added upon the pile and well trodden in by mules. Mercury is next sprinkled on and mixed in the same way. The above operations require two to four weeks. The fine product is then washed in tanks to separate the heavy mercury and amalgam from the light tailing, and the amalgam is recovered and treated as in silver milling.

## CHAPTER XXII

### SILVER MILLING BY HYDROMETALLURGICAL PROCESSES

#### PRINCIPLES OF THE HYDROMETALLURGY OF SILVER

A wet-process for the recovery from the ore consists in dissolving the metal by means of a solvent and precipitating from the solution in a convenient form. The silver compounds which can be obtained readily in solution are the sulphate and the chloride. In cyanide solution argentite is readily soluble, while ruby silver, freislebenite, and stephanite, are sparingly so, though readily soluble in mercurous potassic cyanide. Silver sulphate is soluble in hot water, while silver potassic chloride is dissolved by brine solution or by sodium hyposulphite (thiosulphate). From the aqueous solution of the sulphate silver is precipitated by metallic copper; from the brine solution of its chloride by copper, or when in dilute solution by zinc, iodide; from the hyposulphite solution by sodium sulphide; and from the cyanide solution by metallic zinc.

The Augustin and the Ziervogel processes, introduced in 1840 to 1850, were used in a limited way almost exclusively for the treatment of matte. However, the recent application of the Augustin process in connection with blast roasting for the treatment of low-grade complex silver ores containing lead and copper is worthy of note.

#### THE AUGUSTIN PROCESS

This has been used for the extraction of silver from ore and from copper-bearing matte, obtained as a product of smelting. At Kosaka, Japan, ore consisting of one-half heavy spar and containing 10.5 oz. silver per ton is thus treated. The ore is crushed and roasted with salt in a reverberatory furnace, and, after drawing from the furnace and moistening on the cooling-floor, contains 80 per cent of the silver in the form of chloride. It is leached with a hot 18 per cent salt solution in regular leaching-vats. The leaching is continued until a polished plate of copper shows no precipitate of silver when held in the flowing filtrate. It requires 0.66 ton of brine to leach a ton of the ore. The sand is washed with hot water, and the tailing rejected.

## THE ZIERVOGEL PROCESS

This process, practiced at Mansfeldt, Germany, and at the Boston & Colorado smelting works at Argo, Colo., is adapted to the treatment of rich copper matte containing little or no arsenic, antimony, or bismuth, any of which would form insoluble compounds with silver. The method may be divided into three parts: the roasting for silver sulphate, the leaching, and the precipitation of the silver.

**The Process.**—Referring to the flow-sheet of the process (see Fig. 140)

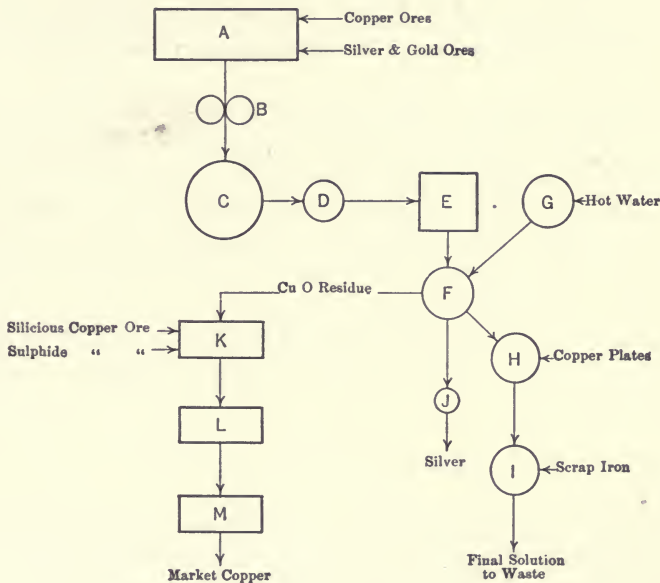

FIG. 140.—Flow-sheet of Ziervogel Process.

we have in furnaces *A*, the operation of producing the matte or regulus from gold- and silver-bearing copper ores. The details of the process are described in the chapter on the Metallurgy of Copper, under the head of "Reverberatory Matte Smelting." The composition of the matte is Cu, 47.3 per cent; Pb, 8.1; Zn, 2.7; Fe, 17.7; S, 21.6 with 400 oz. silver and 15 oz. gold per ton.

**Preparation of the Matte.**—The matte is crushed and passed through rolls at *B* to reduce it to 6-mesh size, and sent to a reverberatory furnace *C*, where it receives preliminary roasting. The roasting reduces the sulphur to 6.3 per cent, and converts the iron and copper sulphides to the corresponding oxides and sulphates, as described in the chapter on the chemistry

of Oxidizing Roasting. This partly roasted product then goes to a Chilian mill *D* (see also Fig. 46), where it is finely ground to 60-mesh.

**Sulphatizing Roasting.**—The partly roasted matte is next treated by hand in charges of 1600 lb. by a sulphatizing roast in small single-hearth reverberatory roasters at *E*. In the process the iron and copper remaining in the form of sulphides are converted into sulphates which react on the silver sulphide at a slightly higher temperature, as follows:



It has been found that the addition of 2 per cent sodium sulphate (salt cake) facilitates the change. The roasting takes place in four stages as shown below.

During the first stage, of  $1\frac{1}{2}$  hours, the draft is checked, the side doors kept open, and the charge held at a low temperature. The charge becomes evenly heated throughout, and glows from the oxidation of  $\text{Cu}_2\text{S}$  to  $\text{Cu}_2\text{O}$ .

During the second stage, of  $1\frac{1}{2}$  hours, the heat is increased and the charge constantly rabbled. Iron sulphate is decomposed with the consequent formation of copper sulphate. The charge swells and becomes spongy by the formation of this salt.

In the third stage, the temperature is increased for an hour until tests show that the silver is "out," that is, in the form of sulphate. The following reaction occurs:

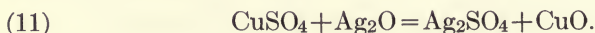

During the fourth stage the temperature is kept constant. The charge is gathered and pressed down with a heavy, long-handled iron paddle to break the lumps, and then vigorously stirred to oxidize the remaining  $\text{Cu}_2\text{O}$  to  $\text{CuO}$ , and decompose copper sulphate. The temperature is not further increased, since it would decompose silver sulphate, forming silver oxide, rendering the silver again insoluble.

The progress of the roast is tested by dropping small samples from time to time into hot water. Soluble sulphates dissolve in the hot water; and in the tests made early the solution becomes deep blue. Later, as the silver sulphate begins to form, it is immediately reduced to silver spangles by the cuprous oxide present. As the roasting advances during this stage, the copper sulphate decomposes, and the solution becomes less blue in the test and the silver spangles increase and afterward diminish. During the fourth stage the  $\text{Cu}_2\text{O}$  is changed to  $\text{CuO}$  and the spangles no longer show. A light-blue color of the solution remains, due to the presence of a little copper sulphate, which indicates that the silver sulphate is not itself becoming decomposed. A sample thus roasted showed by analysis

2.5 per cent  $\text{FeSO}_4$  and  $\text{ZnSO}_4$ ; 0.6 per cent  $\text{CuSO}_4$ , and 1.73 per cent  $\text{Ag}_2\text{SO}_4$  (348 oz. silver per ton), so that there was left in the matte (there being no loss of weight in roasting matte) 52 oz. per ton or 13 per cent of the silver in insoluble form.

**Leaching.**—The roasted matte is charged into tanks *F* and leached with hot water to dissolve the sulphate above described. The filtrate goes to a series of boxes *H*, containing copper plates upon which the silver precipitates in the form of white shining crystals. The silver-free solution, containing in addition to the original copper sulphate that which it has taken from the copper plates, goes to tanks *I*, where the copper is precipitated upon scrap-iron to recover the copper. The final solution is rejected.

The cement-silver from the precipitating boxes is transferred to a tank, and dilute sulphuric acid is added. It is boiled by forcing in a mixture of air and steam from an injector. The treatment oxidizes and dissolves the traces of copper still retained by the silver crystals, and keeps them in agitation at the boiling temperature of the acid mixture. The copper sulphate solution is now run off and the residue repeatedly washed by decantation with hot water to free it entirely from copper. It is transferred to a long pan over a coal fire for drying and is then melted down in crucibles in a wind-furnace and obtained in ingots 999 to 999.5 fine.

**Residue from the Leaching Tanks.**—The extracted residue remaining in the tanks *F*, still retaining 52 oz. silver per ton as above stated, freed from sulphates, and composed mainly of iron and copper oxides, is sent to a reverberatory furnace *K*, to form copper matte. The slag produced in the treatment goes back to the ore-smelting furnace *A*, while the matte, tapped into sand molds, is sent to the reverberatory furnace *L*, to be treated by the English process of making "best-selected copper." Here the matte, in large lumps, is piled up in the furnace near the bridge and exposed to a flame made oxidizing by an excess of air admitted through the fire and through openings in the bridge and roof of the furnace. The effect is to "roast" the matte as the lumps slowly melt and the drops of liquefying matte come in contact with the air. Finally the whole charge becomes melted, and the copper oxide which has been formed, acts on the unoxidized copper sulphide of the matte as follows:



The aim is to extend the roasting only so far as to obtain in the form of metallic copper one-fifteenth of the total matte. When the charge is tapped from the furnace into molds, made in the sand, the copper is found in the form of plates or bottoms in the first of the molds beneath the lighter matte. The bottoms absorb the impurities such as arsenic, antimony, lead, and bismuth, practically all the gold (100 to 200 oz. per ton) and

some of the silver. On the other hand, the supernatant matte has risen to the grade of white-metal of 75 per cent copper, and carries 90 to 100 oz. silver but not more than 0.2 oz. gold per ton.

To prepare it for the extraction of the silver, the matte is again given a sulphatizing roast, but in a different furnace from the one used for the first matte. The residue after this second treatment, principally a copper oxide containing 10 oz. silver per ton, is sold to the oil refiners. The bottoms, formerly treated at the Argo works by a secret process for the extraction of the precious metals, is now electrolytically refined.

#### THE HYPOSULPHITE LIXIVIATION OF SILVER ORE (VON PATERA PROCESS)

Hyposulphite lixiviation can be practiced upon ore containing simple or compound sulphides of silver that have undergone a preliminary chloridizing roasting. The silver sulphides, in the roasting, become converted into silver chloride. The process also applies to silver ore already containing the silver as chloride. Free-milling ore, such as oxidized ore containing the silver in the native state, or as chloride, or to some extent as argentite, are preferably treated by milling and amalgamation. Native silver and silver sulphide in a favorable form can be recovered by milling and amalgamation, whereas by hyposulphite extraction, they would remain insoluble. The process is not suited to the treatment of gold ore. The extraction of gold is low; usually less than 50 to 70 per cent. One of the most useful applications is to the treatment of argentiferous blende that has been hand-picked or concentrated from galena, and may still contain lead up to 8 per cent.

The hyposulphite process is based upon the fact that silver chloride readily dissolves in dilute solutions of sodium hyposulphite. The chloridizing roasting is unquestionably the most important part of the process, and the chief attention and study is to be given it.

It consists in crushing the ore, roasting it, and treating the roasted ore in filter-bottom vats, first with water to remove the soluble chlorides and sulphates of the heavy metals (base metal leaching), then leaching with a dilute solution of sodium hyposulphite to dissolve the silver chloride. Silver sulphide is precipitated from the filtrate with sodium sulphide, dried, and roasted to remove the sulphur, and the residue is sent to the smelting works, or treated in an English cupelling furnace.

#### THE RUSSELL PROCESS

This is a modification of the Patera process, principally by the use of another solution, in addition to the hypo-solution, for the extraction of the silver. By mixing in solution two parts of the hypo-salt with one of copper



sulphate we obtain a double salt  $\text{Na}_2\text{S}_2\text{O}_3 \cdot \text{Cu}_2\text{O}_3$ , called the extra-solution. It has a solvent power nine times as great as that of the ordinary hypo-solution for native silver, silver sulphides, silver arsenides, and silver antimonides. In the case of an imperfectly roasted ore the use of the extra-solution insures the extraction of more silver from the compounds mentioned than could be obtained by the use of ordinary hypo-solution.

## CHAPTER XXIII

### CYANIDATION OF SILVER ORES

#### PRINCIPLES OF CYANIDATION

Silver ores carrying gold, and in which the silver occurs as chloride, or argentite, or stephanite, have been successfully cyanided. Manganese silver ores contain the silver intimately associated with the manganese and will give no extraction when treated raw, unless there be a preliminary acid treatment.

Of the silver minerals, native silver, in particles so large as to be visible, is insoluble in potassium cyanide in any reasonable time. Silver chloride, bromide, and argentite, are readily soluble. Ruby silver, stephanite, and freieslebenite are sparingly soluble in potassium cyanide, but readily soluble in mercurous potassium cyanide solution.

A chloridizing roast is always beneficial to ores containing silver sulphides as it increases the percentage of extraction. However, it is not essential and is seldom employed in the cyanide treatment of silver ores.

In handling silver ores the reactions are more complex than in treating ores of gold, owing to the greater chemical activity of the silver compounds, and to the fact that owing to the larger quantity of contained metal the cyanide solutions are necessarily stronger.

Important matters in cyaniding silver ore are the following:

(a) A long time, ten to twenty-five days in the case of sand treatment, is needed for leaching. For slime treatment from forty-eight to ninety-six hours would suffice for a complete cycle, in which time a higher percentage of extraction would be obtained than by a fourteen-day treatment of the corresponding sand. The silver compounds are not so easily soluble as gold, and a larger amount must be dissolved.

(b) Thorough oxygenation is necessary, not only because of the large amount of silver present, but because silver compounds need at least initial oxidation to become properly soluble in cyanide solution. Hence an advantage is secured by the double treatment of sand. Also during leaching, if the solution be allowed to sink several inches below the top of the charge, before another wash-solution is run on, air is drawn in and penetrates the ore, and the solution following forces the air downward through the ore. In the treatment of the slime the pulp may receive thorough aëration by agitating with air.

(c) Stronger solution is used than for the treatment of gold ore. Thus the first or strong solution may be 0.7 per cent, the weak one 0.25 per cent, while for gold ore, a 0.5 per cent solution would be called strong and 0.05 per cent weak.

(d) The consumption of potassium cyanide is higher than in the treatment of gold ores. It varies from 1.5 to 4 lb. per ton as compared with 0.4 to 0.8 lb. consumed in the treatment of gold ores.

(e) The precipitation of silver from cyanide solution by zinc shaving presents no difficulties and is practically complete. Despite the fact that a relatively great amount of silver has to be precipitated, as compared with gold, no more zinc is consumed.

### THE PRECIPITATION OF SILVER FROM CYANIDE SOLUTION

Silver in cyanide solution may be recovered by precipitating upon zinc shaving or by zinc or aluminum dust according to the reactions (6) and (8), page 147. In presence of copper the precautions described under head of "Precipitation of Gold from Cyanide Solutions" will equally apply to silver precipitation. Silver ores of course make a much larger bulk of precipitate than gold. On this account the Merrill precipitation process is preferred to the use of the zinc boxes illustrated on page 258, though for a small plant they might be used.

Fig. 141 shows in outline the course of procedure for the clean-up, the pressing, drying, and melting of the precipitate from clarified silver solutions. The novel feature is the washing of the fine precipitate from the zinc box with pregnant solution into the filter press, where it is collected. The pumping of pregnant solution through the filter press is continued at intervals, until the tail solution rises to approximately the value of the pregnant solution precipitated. During the earlier stages of pumping, the tail solution from the filter press is of low enough grade to divert to the milling solution, but, during the later stages, it is advisable to return it to the head of the zinc boxes. With solutions in which silver occurs in the ratio of 50 parts to 1 part of gold, precipitate is at times obtained which contains approximately 90 per cent of silver and gold. There is no difficulty in obtaining precipitate, regularly, well over 80 per cent of silver and gold. When of this grade it is very easily melted, with a minimum consumption of fluxes and fuel, and, of course, produces a high-grade bullion. At a certain Mexican plant, where this plan was adopted, the grade of the precipitate was very materially raised and the fineness of the bullion was increased from 800 to 900. This resulted in a monetary saving of several hundred dollars per month. A similar plan appears to be feasible with zinc dust precipitation. It is still a question as to how far such a plan could be carried with solutions in which gold predominates.

With the Merrill process double precipitation is generally practiced, as shown in Fig. 117; the apparatus is in duplicate, constituting two circuits.

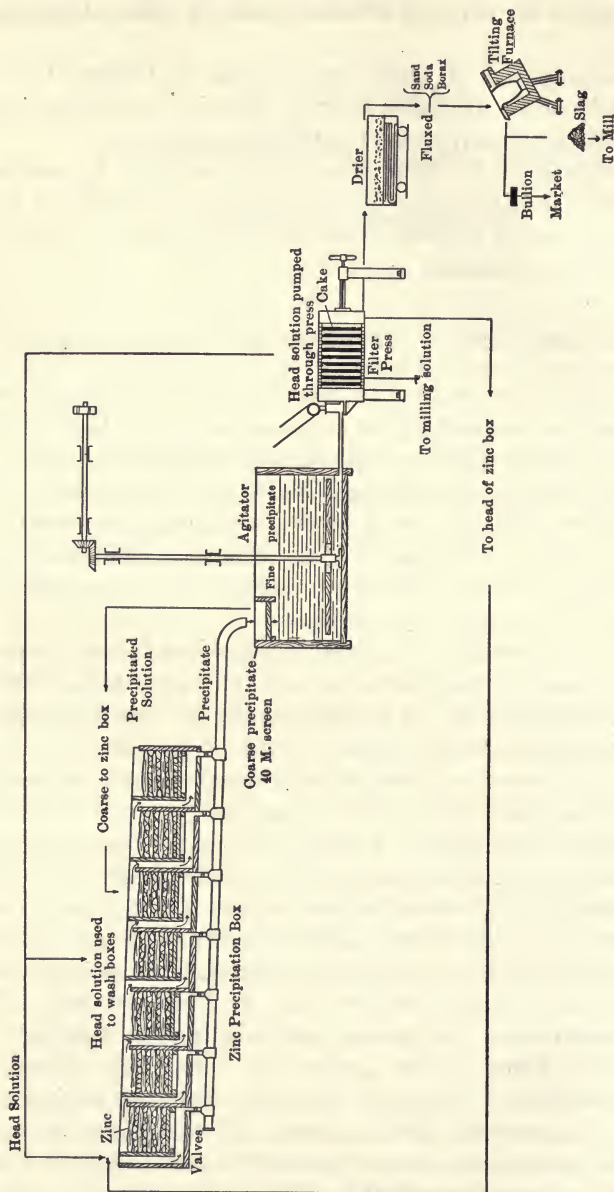

Fig. 141.—Zinc-box Clean-up and Treatment of Precipitate.

In the one circuit the heavier feed of zinc-dust is maintained to give a barren solution, while in the other there is just sufficient to precipitate the bulk of the silver. The amount of the barren solution to be made is

determined by the needs of the final washes, while the other, needing less zinc-dust and carrying a few cents worth of silver, is used in the agitation tanks. Thus in a Mexican silver-mill of 500 tons capacity, about half the solution was completely precipitated to retain but 1 to 2 cents worth of silver per ton, using 1.1 oz. of zinc-dust to one of silver. On the other hand the partially or almost precipitated solution needed but 0.74 oz. of dust to one of silver and this retained but 10 cents of solution, well suited for re-use.

#### THE SANTA GERTRUDIS PRECIPITATING AND REFINING PLANT

Fig. 142 is a plan of this installation, showing the method used for double precipitation by the Merrill process.

There are four pregnant solution storage tanks, so that an exactly measured quantity of solution can be precipitated by a known weight of zinc-dust. Owing to the large quantity of zinc-dust needed this is slowly fed to the zinc-dust mixing cone by an endless belt through a worm-gear drive, this belt taking its feed from a supply-hopper in regulated quantity. Referring now to the partial precipitation circuit, the two tank-discharges unite in one just before the zinc-feeder. The emulsion from the mixing cone drops by a vertical pipe into the tank discharge which constitutes the 12-in. suction of pumps Nos. 1 and 2 of the circuit. From the pumps the solution now impregnated with the zinc-dust, passes to the Merrill presses Nos. 1, 2, 3, and 4. When the desired tank, such as tank No. 9, is emptied and the solution, now nearly freed from its silver, is filtered and washed, the filtrate goes by a 10-in. pipe line to mill-solution sump-tank No. 15. The emptied presses are blown with air to drop off the precipitate on the filter leaves and the press opened for the removal of the precipitate. For the production of barren solution a similar procedure is followed, taking the pregnant solution from tanks Nos. 11 and 12 and delivering through presses 5, 6, and 7 to the barren solution sump-tank No. 14.

Fig. 115 is a view of the style of press used. The filter press frames are triangular, the pulp entering at the bottom of the frame. The solids gradually accumulate on the filter cloths of the frames, providing a uniform filtering layer of a fine-grained precipitant through which the solution must pass to ensure contact between the zinc and the gold particles for instant precipitation. The barren or nearly barren solution, the product of the press, then passes by way of the discharge launders to the completed precipitate or to the partially precipitated solution tank.

For a clean-up the press-cakes are dried by forcing air through the precipitate on the filters, the press is opened and the caked material dumped into tram-cars. The product is sampled, weighed and determined for contained moisture, thus giving its exact dry weight.

We give in Figs. 116 and 117 views of a press-frame and of a press-plate. There are forty such frames in a press. The plate is covered on both of its faces by a filter cloth. When the frames and plates are placed tightly

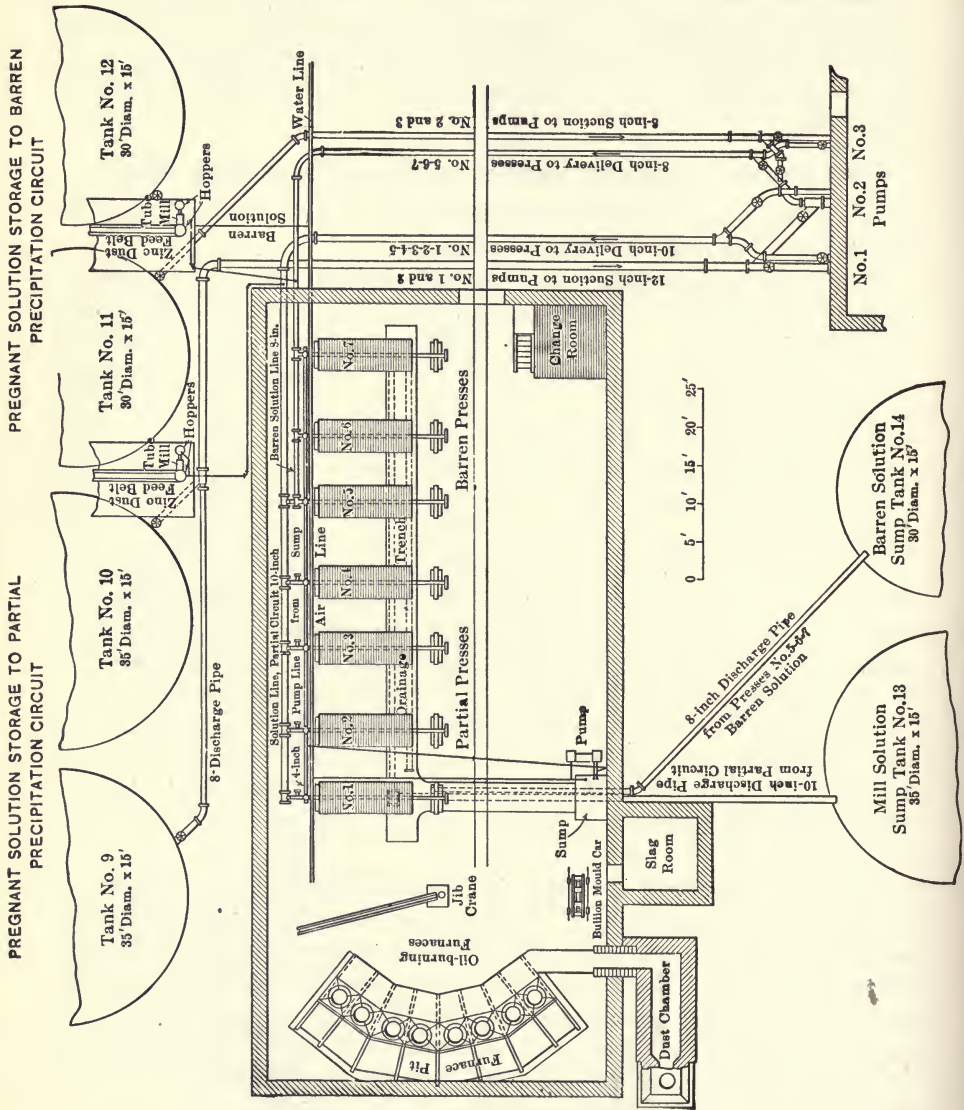

FIG. 142.—Santa Gertrudis Refinery.

together in the press the common circular passage along the top admits the solution to each frame. It is led to the bottom of the frame by the drop pipe there shown. Passing through the filter cloth it escapes by a cock at the left-hand upper corner of the plate.

## PRECIPITATION BY ALUMINUM DUST

This is not new as far as the actual knowledge of its use is concerned; but it was only recently that its use in a practical way on a large scale was studied. This is done at Deloro plant and the Nipissing mines, Ontario, where rich silver ore containing arsenic and cobalt is treated. They are perhaps exceptional cases, rendering its use necessary.

**Precipitation at Nipissing.**—It was found here that, after solutions had been precipitated by zinc they rapidly lost their dissolving efficiency, so experiments led to the use of aluminum dust. The metal must be well agitated with solutions before precipitation. The fact that aluminum does not replace the precious metals in the cyanogen compound renders necessary the presence of a caustic alkali. The reaction in precipitation is probably



From this equation it will be seen that there is a regeneration of cyanide.

At this plant the pregnant solution is pumped to a sand-filter. It is then precipitated by the Merrill process as above described. Some 550 to 600 tons of solution are handled daily, the head-assay running about 8.25 oz. the tail assay or barren solution 0.10 oz. of silver per ton. Precipitation averages 98 per cent, using 0.02 lb. of aluminum per ounce of silver at a cost of 18.5 cents per ton of ore treated.

## DRYING AND REFINING SILVER PRECIPITATE

The early practice of selling the precipitate to smelters is still adhered to by a few companies, but the majority convert it into bullion before marketing. Cyanide bullion varies greatly in fineness, depending upon the character of the ore treated as well as the equipment provided for refining and the degree of skill exercised in its use. It is, obviously, not good practice to carry local refining to the point where the cost is greater than the advantages to be realized from marketing higher-grade bullion. The only case that I know of where fine bullion is produced which requires no further refining is that of the Nipissing Mining Company, Cobalt, Ont., Canada. Here, unusual conditions make the production of fine bullion a comparatively easy matter.

**Acid Treatment.**—Preliminary acid treatment of the precipitate has been found unnecessary in most cases where silver predominates, but is still adhered to in the majority of cases for gold precipitate.

**The Tavener Method.**—The Tavener method of refining, involving the melting of the precipitate in a small reverberatory furnace with various fluxes and lead, followed by cupellation, is still in general use in South Africa, but has not gained ground in this country.

**Cupelling.**—The Homestake method of refining, involving acid treatment and briquetting with lead flux, followed by melting and cupellation in the ordinary English cupel furnace, as well as the treating of all the by-products in a small blast furnace, is used by a few American plants.

**Blast-furnace Treatment.**—The melting of the precipitate, briquetted with the proper fluxes, in a small blast-furnace, followed by cupellation of the lead, has been found of advantage when dealing with a large volume of low-grade precipitate. Losses from dusting, which might appear to be the chief objection to this method of melting, are claimed to be insignificant when a proper flux system is provided. This method of melting is more economical than either the Tavener or Homestake practice.

**The Electric Furnace.**—The electric furnace has also been used in a few cases.

**The Tilting Furnace.**—The most simple and satisfactory method of converting the high-grade precipitate which is obtained, by proper manipulation, from ores in which silver predominates is to melt the precipitate directly, with the minimum proportion of flux, in the tilting type of furnace. A few mills use a double-chamber tilting furnace, in which the flame comes in direct contact with the charge being melted. This furnace is perhaps more economical of fuel, but, unless the precipitate is briquetted there is greater risk of loss through dusting than when the precipitate is melted in a closed crucible. In the case of silver precipitate, with proper manipulation in the crucible furnace, it is a serious question whether it pays to briquette, the losses being less under these conditions than the cost of briquetting.

Let us take the case of a low-grade precipitate containing 25 per cent gold and silver; 39 per cent lead, 20 per cent zinc,  $\frac{1}{4}$  per cent copper;  $\frac{1}{2}$  per cent sulphur, 3 per cent lime and 1.4 per cent silica. In the following table we will have:

SLAG BALANCE.			OXYGEN.	
Substance.	Weight, Pounds.	Combined as.	Acid, Pounds.	Base, Pounds.
Zn.....	20.60	ZnO	.....	5.10
Pb.....	37.50	PbO	.....	2.90
Cu.....	0.27	Cu <sub>2</sub> O	.....	0.03
CaO.....	2.30	CaO	.....	0.66
SiO <sub>2</sub> .....	19.00	SiO <sub>2</sub>	10.2	
*B <sub>2</sub> O <sub>3</sub> .....	27.00	B <sub>2</sub> O <sub>3</sub>	18.5	
*Na <sub>2</sub> O.....	22.50	Na <sub>2</sub> O	.....	5.80
			28.7	14.49

\* Computed from weights of borax and niter used.



Here the ratio of acid to basic oxygen is as 2 to 1. There was yielded 134 lb. of slag and  $5\frac{1}{2}$  lb. of a white-looking layer or cover of sulphate of soda. Of niter there was used 35 lb., of which 6 lb. was needed for the cover, leaving 29 lb. to give the 22.5 lb. of soda for the slag. Of borax 39 lb. was required to yield 27 lb. of  $B_2O_3$ , so that there was a total of 93 lb. of fluxes for 100 lb. of precipitates. When melted the resultant bullion was 972 fine. A plumbago crucible is preferred, but where there is much copper there is a clay crucible used because a plumbago crucible would tend to reduce the copper which would then enter the bullion, reducing its fineness.

**Types of Furnaces Used.**—Various types of furnaces are used in melting precipitate, namely, the ordinary wind-furnace holding from a 60- to 200-size crucible (see Fig. 1); the Faber-du Faur tilting furnace as used at

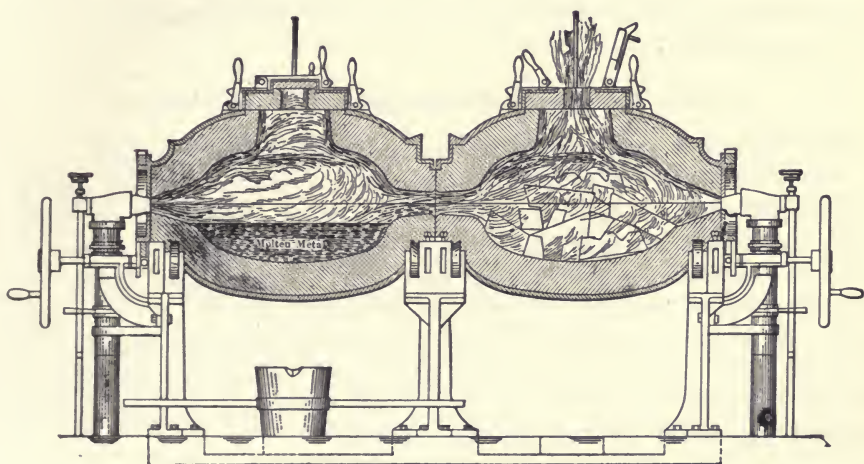

FIG. 146.—Monarch Rockwell Refining Furnace.

Kalgoorlie; the Steele-Harvey oil-fired tilting furnace; the Monarch-Rockwell as used at the Belmont, Tonopah, the latter as shown in Fig. 146.

**Drying, Melting and Refining by Fusion.**—The damp precipitate from the ore is well mixed with a calculated amount of fluxes, the moisture loaded into pans and placed in a large muffle furnace and gradually heated to a red heat. Moisture is driven off and the precipitate in the acid settles to about one-third of its original bulk. The sintered mass, free from dust, gives an excellent product for crucible melting. The fluxes used are generally Chili niter (sodium nitrate) for oxidizing soda-ash to take up the sulphur, borax, and sand as acid fluxes for the bases. These are added in such proportions as to produce with the silica and the bases in the precipitate a slag of two of acid to one of base oxygen. The ratio

of borax glass to silica should be as 2 to 1; or in presence of much lead as 1 to 1.

**Smelting in an Oil-burning Reverberatory Furnace.**—The hearth of the furnace is 11 ft. by 4 ft. 9 in. wide and will take a charge of 5 tons of precipitate. Before using, the furnace is seasoned by melting in 700 lb. of old slag which consolidates the bottom. The precipitate is properly fluxed and melted down, giving about  $2\frac{1}{2}$  tons of bullion of 883 fine in silver. The furnace is operated as often as a 5-ton charge is ready, the smelting taking from sixteen to twenty-eight hours.

#### CHEMISTRY OF THE CYANIDE PROCESS FOR SILVER ORES

When a solution of potassium cyanide is brought in contact with finely divided silver or silver chloride the metal is dissolved according to the following equation:

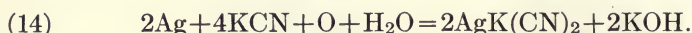

The reaction is similar when the cheaper sodium sulphide is used.

Oxygen is needed to complete the reaction, so that the ore-pulp should be properly aerated. This may take many hours. When the occluded oxygen is used up the reaction ceases, but resumes with a fresh supply of air. As described for gold ferrous and ferric sulphates result from the decomposition of pyrites and tend to precipitate silver. To overcome this an addition of quicklime is made in more than sufficient quantity to overcome the acidity, the excess being termed "protective alkalinity." When silver-bearing sodium cyanide solution is brought in contact with zinc shavings or zinc dust we have the reaction:

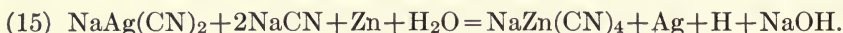

One part of zinc is calculated to precipitate 1.7 parts of silver. But cyanide is also used up by direct combination with the zinc.

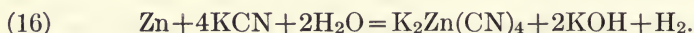

In both these reactions there is an escape of hydrogen bubbles.

When aluminum is used as precipitant we have:

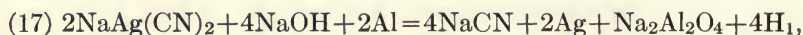

in which one part of aluminum precipitates four parts of silver, in this respect being so much more efficient than zinc.<sup>1</sup>

<sup>1</sup> In place of writing sodium cyanide NaCN it is often written NaCy, the Cy being a convenient way of specifying the CN.

## TYPICAL SILVER MILLS

The following are descriptions of silver mills:

## BELMONT MILLING CO. MILL, TONOPAH, NEVADA

The ore is a fine granular quartz of about 72 per cent silica with a few per cent of sulphides. The silver occurs as disseminated silver sulphides, antimonides, and selenides; a little native silver, and a little gold. Thus to 0.32 oz. of gold there would be 32 oz. silver, or in weight 1 of gold to 100 of silver. The ore is treated by concentration and the tailings agitated in cyanide solution and filtered. The operations may be divided into five; (1) picking, coarse crushing, and delivery to the mill bins; (2) stamping, tube-milling, and concentrating to remove the heavy part to be sold to the smelter; (3) cyaniding the tailings from the concentrating tables to yield a pregnant solution; (4) precipitation of the gold from the solution; (5) refining the precipitate.

(1) **Picking, Coarse Crushing and Conveying.**—This is done in a separate building. The ore, broken underground to 9-in. size or less, is stored in two 1000-ton flat-bottom bins. It forms a natural slope, so about half of it can be drawn off at the side gates through shaking grizzlies, having 2-in. openings. The undersize goes by a conveying belt 6, to a trommel 8, while the oversize falls upon an endless picking belt, 40 in. wide, traveling 45 ft. per minute. Here the ore-sorters pick out the waste and throws it down chutes to a 20-in. conveyor belt, which discharges upon the waste dump. The picking belt discharges upon a shaking feeder which feeds it to a gyratory crusher 8. The crusher discharge joins the undersize from the shaking grizzly in the trommel, 4 ft. diameter by 14 ft. long that has 1½-in. openings. Its undersize goes direct to the inclined conveyor belt 11, and the oversize feeds the gyratory crushers set to crush 1-in. size. The discharge from the crushers joins the trommel undersize on the inclined belt-elevator.

*Sampling.*—An inexpensive sampling of the ore is thus effected. On a vertical shaft is a bevel gear with a bucket of 5½ lb. capacity attached to it. When in the revolution of the gear, the bucket traverses the stream of falling ore from the top end of the inclined conveyor it takes out a sample. Now, on the gear, one-third of the teeth are removed and at that space a counter-balance actuates the gear, allowing the bucket to make a quick cut through the ore. In this way a sample of 1 ton in 500 is taken to be cut down by the usual sampling methods.

(2) **Stamping, Tube-milling and Concentrating.**—From the head of the inclined belt the ore is conveyed by a horizontal belt and distributed evenly to flat-bottom mill bins 16 ft. wide, 17 ft. high, by 110 ft. long, of 1500 tons capacity. Half of the ore which will run freely is fed to the stamp-batteries.

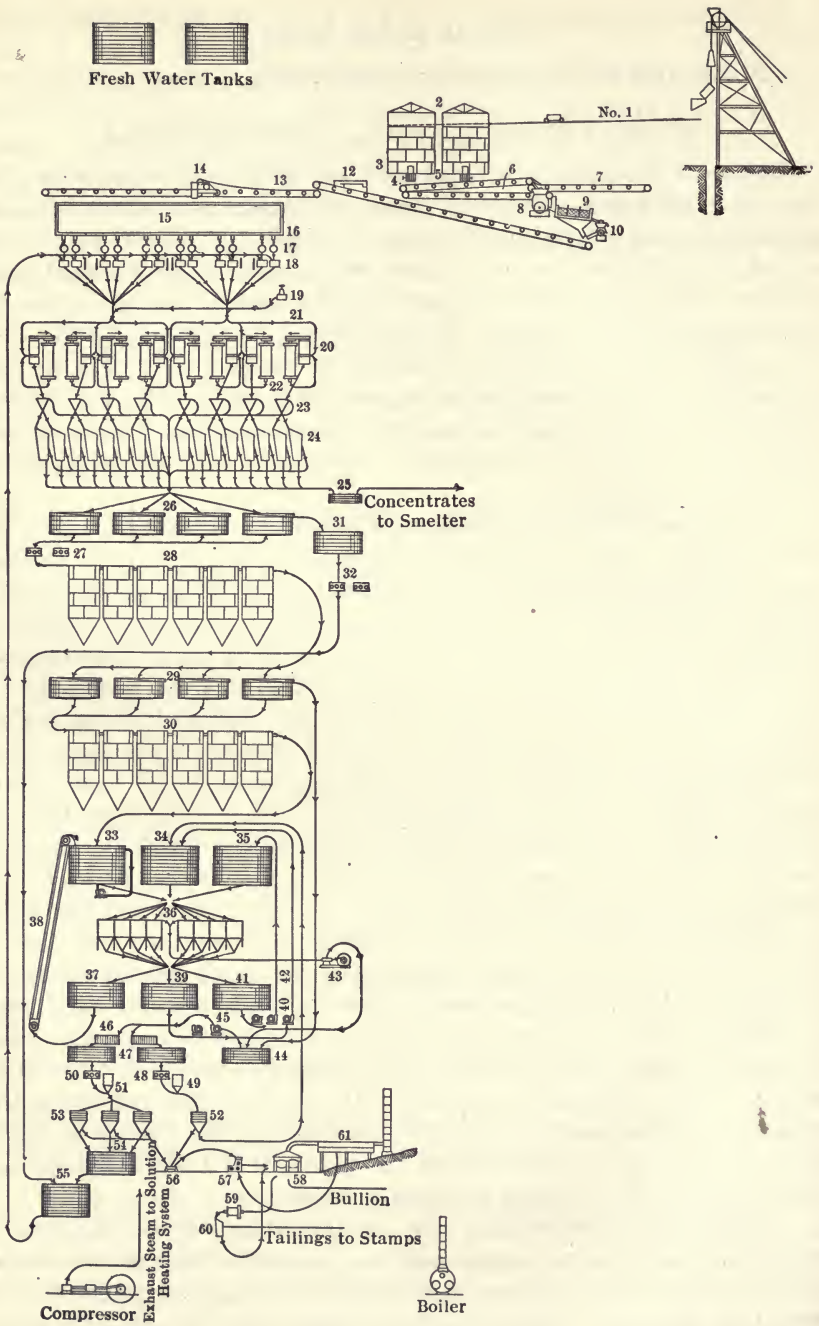

FIG. 147.—Flow-sheet of Belmont Mill.

Crushing is done by sixty stamps of nearly 9 tons duty per stamp through 4- to 6-mesh screens. It is done in cyanide solution at the rate of 5 tons and with the addition of 1 lb. quicklime per ton of ore. The battery is shown in Fig. 87.

The stamp battery discharge is delivered to eight Dorr duplex-classifiers placed in closed circuit with their respective tube-mills as shown in Fig. 40. A further addition of lime as milk of lime is made at this point, also an addition of 0.15 lb. lead acetate per ton of ore. The most economical point in grinding has been to yield a product 75 per cent of which will pass 200-mesh. The overflow from the classifiers passes now to eight 5-ft. Callow cones used as sloughing-off cones; that is, there is a turbid or slimy overflow going to Dorr thickeners and a spigot discharge forming the feed for sixteen No. 6 Wilfley concentrating-tables running 300 strokes per minute, with a  $\frac{5}{8}$ -in. throw. Close concentration is not attempted, but rather to obtain a clean concentrate product. This is put into a vacuum tank 14 ft. diameter by 3 ft. deep, and allowed to dry under vacuum for forty-eight hours. Afterward it is shoveled from the tank to a steel bin below. It is sampled and shipped by rail to the smelter. In attempting to treat these concentrates on the spot, it was found that, while a good extraction could be made with fresh solution, soon this became foul and inactive and the extraction became poor. Even where this was good, the cost of treatment would be higher than the shipping and marketing expense. Farther it was found, even when roasting, a satisfactory extraction was not attainable by cyaniding. These concentrates were about 60 per cent pyrite, 30 per cent insoluble and contained 1.6 per cent silver and gold, or 467 oz. per ton. The tailings pulp from the Wilfley tables joins the overflow from the Callow cones to go to four 30 by 12-ft. Dorr thickeners (see Fig. 102). The proportion of solution to ore in this united flow, which had been added in the prior operations, is as follows: At the stamp batteries 5 to 6 parts; to correct the water at the tube-mill feed 0.8 part; at the Dorr classifiers, in order to thin the pulp for proper classification, 1 part; as wash-water at the Wilfley tables about 1 part. Two of these classifiers are fitted with trays, being another bottom with a central opening. Additional settling area is thus afforded, increasing their capacity by about 75 per cent. The overflow from these, the first set, is sent to the partial precipitated solution tank 54 while the underflow of 1.26 specific gravity, is pumped to the first tank of the first series of Pachuca agitators 28, and passes through them all in series. Each of these tanks, 15 ft. diameter by 45 ft. high, is agitated by a central air-lift (see Fig. 100). The pulp from the last agitator, diluted with four more parts of partial precipitated solution from 54 goes to a second set of Dorr thickeners, the overflow to the press-solution tank 44, while the thickened pulp is delivered to be treated in series through a second set of agitators, whereby the silver has

been thoroughly brought into solution. The flow from the last agitator goes to 33, a filter stock-tank 28 diameter by 20 ft. high, equipped with a Trent mechanical agitator to keep the pulp from settling. The total period for agitation is forty-eight hours. By thus thinning the pulp with a nearly barren solution after it has passed through the first series of agitators a large proportion of the dissolved silver is displaced, which relieves the vacuum filters 36, from much work, and allows a change of solution for final agitation. At No. 1 agitator enough cyanide has been added to bring up the solution-strength to 6 lb. cyanide per ton; also 0.18 lb. per ton of lead acetate is then put in. In the central columns of the agitators are steam coils for heating the rapidly rising slime, it having been found that by thus heating a 2 per cent better extraction is attained. The watery slime in the filter stock-tank is now ready for filtering. This is accomplished at the filter boxes or tanks, of 250 filter leaves. The pregnant solution from the vacuum filter boxes (now to be precipitated) is pumped to the press solution tank 44, which is 30 ft. diameter by 10 ft. deep. It is treated in a Crowe vacuum cylinder, clarified and sent on to the partial precipitation or complete-precipitation supply tanks.

**The Refinery.**—Here, for partial precipitation are three Merrill triangular presses and for complete precipitation one press. Only enough solution is *completely* precipitated to a value of about 10 cents per ton, and is used for dilution at the second set of Dorr thickeners for table-wash solution and tube-mill feed-solution. The completely precipitated product carries 75 per cent silver (and gold), 7 per cent insoluble matter, 3.6 per cent lime carbonate, and nearly 5 per cent zinc and other impurities, notably selenium to the extent of  $\frac{1}{4}$  per cent. For a clean-up the product is well mixed with  $2\frac{1}{2}$  per cent of borax and 6 per cent each of soda and sand, and made into briquettes. These briquettes are melted in double-compartment carborundum-lined furnaces, Fig. 146, to produce a bullion containing 93 per cent silver (and gold), 2.5 per cent lead and 1.8 per cent selenium.

On about half a million tons of ore the extraction of silver was by concentration 9 per cent; by cyanidation, 84 per cent, a total of 93 per cent. Of the gold 6 per cent was recovered by concentration, 90.2 per cent by cyaniding.

#### CYANIDATION OF MIXED SILVER ORES AT THE SAN FRANCISCO MILL, PACHUCA, MEX.

This plant treats ores from a number of different mines, each of which is different in chemical composition and requires a variation in the treatment. The first Pachuca tanks used in North America were installed at this plant.

The average content of the ore received has been 17.4 oz. silver, and 0.08 oz. gold per ton.

The plant contains a complete sampling mill where all ores are received, crushed, automatically sampled, and dumped into bins, from which they are carried to the battery-bins in cars. The batteries consist of forty stamps, weighing 1250 lb. each, which drop  $7\frac{1}{2}$  in. at the rate of 100 drops per minute. The ore is crushed in the batteries to pass through a No. 9 roll slot-screen and thence falls onto eight Wilfley concentrating tables, whence the tailing runs into four Dorr classifiers, from which the slime and excess solution fall into four Frenier pumps, by which they are elevated to two Dorr slime-thickeners, 24 ft. in diameter by 10 ft. deep. The sand from the Dorr classifiers falls into four tube-mills,  $4\frac{1}{2}$  ft. in diameter by 13 ft. long, so placed that each mill receives the sand from one classifier. After the sand is reground in the tube-mills, it passes into four Frenier pumps, which return it to the Dorr classifiers until the whole of the pulp has been converted into slime which passes to the two Dorr slime-thickeners previously mentioned.

From the bottom of these slime-thickeners the slime of the proper consistence for good concentration, is drawn off and fed to fifteen concentrating tables by means of which the heavy minerals which have been liberated by regrinding, or which escaped concentration on the Wilfleys, are concentrated out of the slime. The tailings from the concentrating tables are elevated by a 3-in. centrifugal pump to a third Dorr slime-thickener 24 ft. in diameter by 10 deep, whence the thickened slime, containing 1 ton of dry slime to  $1\frac{1}{2}$  of solution, flows to the Pachuca vats for agitation, while the overflow of this, as well as the overflow of the other two slime-thickeners, flows to a tank from which, when clear, it is pumped to the vats above the mill which supply solution to the batteries. It sometimes occurs, when milling certain classes of ore, that the third Dorr slime-thickener will not have a sufficient capacity for settlement of the ore milled, so that the overflow contains unsettled slime. When this is the case the overflow from this thickener is run into a series of four masonry settling-tanks, where the slime is settled before pumping the solution to the vats which supply the batteries.

There are eight Pachuca tanks in this plant, each of which is charged with from 80 to 100 tons of dry slime for treatment. The slime resulting from the milling and classification, which is treated in these tanks, is of such a fineness that 80 per cent will pass through a 200-mesh screen.

The slime is elevated by pumping to a slime storage tank placed above the filters, from which it is fed to the filters as required. There are two filter-plants in this mill, each having a capacity of 150 tons per day. The Butters filter has seventy-eight filter-leaves, while the Moore filter has two baskets of forty leaves each. Each filter-plant is supplied with all of the

latest improvements and they give entire satisfaction. After filtration the solutions are pumped to the sand filters above the precipitation room while the slime tailing, after being filtered and washed, is discharged into the tailing-dam. The solution from the tailing-dam, after settlement of the slime, is pumped to a tank above the filters for use in them as wash-water.

The precipitation room contains ten zinc-boxes made of sheet steel, each 15 ft. long, 3 ft. wide, and  $2\frac{1}{2}$  ft. deep which are divided into five compartments each. The precipitation of the clarified solutions from the sand filters is almost perfect in these boxes, as the solutions entering the boxes assay from 100 to 250 gm. of silver and from 1 to 3 gm. of gold per ton, while the precipitated solutions leaving the boxes do not carry more than 1 gm. of silver and 0.1 gm of gold per ton.

The cakes of precipitate from the filter-press are dried until they contain from 5 to 10 per cent of moisture. Then, after breaking up the larger lumps, a mixture is made, consisting of precipitate 81 per cent, sodium carbonate 7 per cent, borax glass 10 per cent, quartz tailing, 2 per cent.

A graphite crucible, No. 300, is placed in the coke furnace, and, as soon as it begins to heat up, is filled with the mixture of precipitate and flux, and melted in the usual way. Total treatment costs are \$1.93 per ton, with recovery of 92.4 per cent of the silver and 94.5 per cent of the gold.

#### THE WAIHI GRAND JUNCTION MILL, WAIHI, NEW ZEALAND

The ore from the mine consists essentially of a gangue of quartz and calcite, with 8 to 10 per cent sulphide—pyrite, sphalerite, galena, chalcopryrite, and traces of arsenic and antimony. In stoping, this is mined with the well-defined lode, thus bringing into the mill at times a considerable quantity of hard country rock. The gold exists in an exceedingly fine state of division, consequently rendering it necessary to grind very fine to obtain a satisfactory extraction. The ore averages about \$8 gold and \$1 silver per ton. There are forty 1100-lb. stamps fed by a hanging type of improved Challenge ore-feeder. Cyanide solution of 0.10 per cent is added here in the proportion of 10 of solution to one of ore, also lead acetate equal to 0.5 lb. per ton of ore.

From the stamps with a duty of 7.6 tons a day the pulp flows to three elevator wheels,<sup>1</sup> by means of which it is raised to a series of conical boxes or spitzkasten. The overflow from these boxes passes on to the Wilfley tables. The underflow, after passing through the tube-mills, is again returned by the same elevators to the conical boxes. The Wilfley tables are used merely as classifiers. The discharge is taken from 18 in. along the

<sup>1</sup> The tailings wheel, though of greater first cost, is reliable and the cost of repairs is small.



side, and the tables are so set that their overflow is practically fine enough for economic treatment. The heads, consisting of the larger particles of

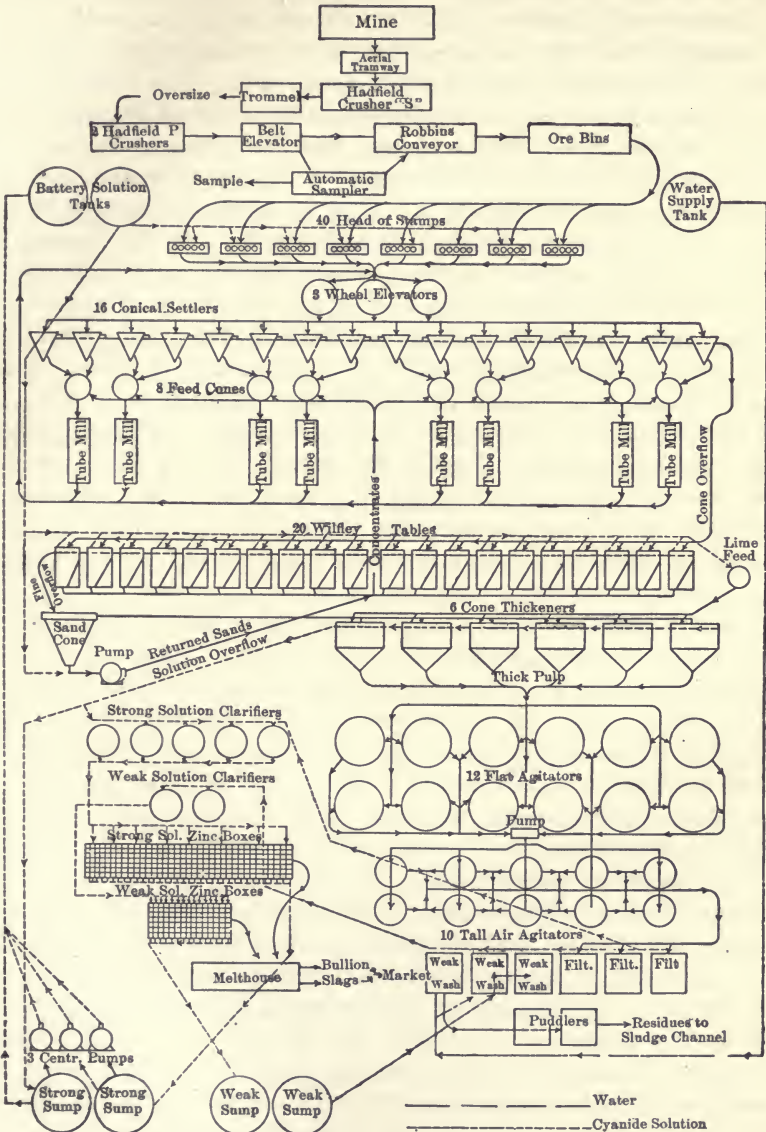

FIG. 148.—Flow-sheet of Waihi Grand Junction Co.'s Mill.

concentrate and sand, are sluiced to belt elevators, which raise and discharge into the feed-cones of the tube-mills.

There are fourteen tube-mills, run at 27 R.P.M. The average life of the liners is eighteen months. The angle shoes are also made of hard cast iron, and have an average life of ten months. The pulp is fed into the mills by means of injectors. The feed nozzles are  $1\frac{1}{4}$  in. inside diameter and discharge into larger cast-iron pipes which are bolted on to the end of the mill. The clearance between these pipes is  $\frac{1}{8}$  in. The ratio of solution to ore in feed is as 1 is to 1. Cost of tube-milling is about 28 cents per ton.

The overflow of the Wilfley tables flows to a spitzlutte, the spigot product of which is returned to the tube-mills by a centrifugal pump. The overflow, consisting of solution and slime in the proportion of 10 to 1, flows to the settlers or thickeners, lime being added to the launder that conveys it. Of the overflow of clear solution, from the settlers, 75 per cent flows to the strong solution sump and 25 per cent to the strong solution clarifying tanks. The pulp is drawn continuously from the bottom of the settlers, and is of a consistence of  $1\frac{1}{2}$  of solution to 1 of slime. This is pumped into one of a series of 12 flat agitators, each  $22\frac{1}{2}$  ft. by 6 ft., provided with four arms revolving at the rate of 4 R.P.M. These agitators are used as storage tanks. When three are full they are discharged by a pump into a tall tank, 55 ft. by  $13\frac{1}{2}$  ft. Agitation is by compressed air at a pressure of 38 lb. per square inch. Each tank has a capacity of 250 tons of pulp. Agitation is continued in these tanks for an average of 18 hours and gives a further extraction of 12 cents per ton. The strength of cyanide is maintained by a continuous flow of strong stock solution, which is added to that supplying the mortar boxes. This is the only place where cyanide is added. The consumption of KCN is 1.258 lb. per ton.

From the tall tanks the pulp gravitates to the Moore filter plant. Each basket is composed of ten frames, 16 ft. by 4 ft., giving a total filtering area of 1280 sq. ft. per basket. The weight of slime cakes in each basket is equivalent to five tons dry weight; seventy-five minutes is required for formation with a vacuum of 25 in. of mercury. The loading tanks are fitted with conical bottoms, and an air-lift is arranged to prevent settlement of slime. The basket is raised by an overhead traveling crane, electrically driven, and transferred first to a wash-tank of weak solution (0.04 per cent KCN), where the charge is washed for forty minutes, then to a water tank, where a further wash of water is drawn through for ten minutes. The basket is now raised and suspended over the discharge tank, drained thoroughly, and the tailing sampled for assay. When the vacuum is destroyed the charge falls on to the revolving arms in the tank, and is sluiced away with water jets to the sludge channel.

The cost of treatment, which includes agitation and vacuum filtration, is 64 cents per ton.

The vats, receiving the solution from the slime treatment, are provided with filters to prevent slime from passing into the zinc-boxes. From these

vats the gold-bearing solutions flow through meters, which register the tonnage, to the launder feeding the extractor boxes. There are twenty-two boxes, seventeen of which are used for strong solution (0.10 per cent KCN) and five for weak solution (0.04 per cent KCN). The strong solution boxes have eight compartments, with total available zinc space of 740 cu. ft.; the weak solution boxes have a total zinc space of 145 cu. ft. All are provided with a screen of 4-mesh near the bottom of each compartment. The average rate of flow of solution through the strong boxes is 1.4 tons per cubic foot of zinc per twenty-four hours, and, through the weak, 1.1 tons. Precipitation of the metals from the weak solution is assisted by first dipping the zinc in a solution of lead acetate. At the head and tail of each set of boxes is an automatic solution sampler. These samples are assayed daily, and from the results, together with the tonnage passed through the boxes as registered by the meters, the amount of bullion precipitated can be calculated. The bulk of the precipitation takes place in the first two compartments. The first four are cleaned out every seven days, and all the compartments every twenty-eight days—that is, at the end of each period. When the boxes are cleaned the zinc is washed in the first cells, the precipitate is drawn off by means of a suction hose into a receiving cylinder, thence into vacuum filters. The short zinc, which passes 4-mesh and remains on 25-mesh, is treated with 1 to 6 per cent sulphuric acid in vats fitted with revolving arms, which agitate the charge, which, after being well washed with hot water, is dried with the balance of the precipitate. The precipitate is dried in cast-iron ovens without stirring. The slime and fluxes are mixed in a small tube-mill, which is entirely enclosed and dust-proof, and when thoroughly mixed it is discharged into a truck. Melting of the precipitate is conducted in No. 120 graphite crucibles. Kerosene fuel is used, and, with four furnaces, two men melt and refine 1100 lb. of precipitate in eight hours. The bullion and slag are poured together into conical molds, and, when solid, the bullion is detached and re-melted in the same crucibles and poured into bars weighing about 1100 oz. each. The slag is crushed by stampers through 25-mesh screen, passed over blanketing to retain prills of bullion, and collected in settling boxes. It is afterward air-dried, bagged, and shipped to smelters for treatment. The cost of precipitation and melting is 5 cents per ton of ore crushed in mill.

Two Balback tilting furnaces, using coke fuel, have been installed, and are used for melting the precipitate, the kerosene furnaces now being used for remelting the bullion into bars.

The total cost of milling and treatment is \$1.50 per ton.

## MILLING PRACTICE AT COBALT, ONTARIO

There are two grades of ore, the high and low grades, each treated by a different process. The treatment of the high-grade ore is given on page 243; the milling of the low grade is described below.

**The Ore.**—This is complex, containing chiefly native silver occurring in particles entangled in a mixture of nickel and arsenic minerals (smaltite and niccolite) and calcite. It is classified in two grades, the "high grade," chiefly of native silver of 2500 oz. per ton, and the "low-grade," having native silver, also considerable sulphides and antimonides, whose silver is difficult to recover.

**Preliminary Treatment.**—At the washing plant, as shown on the flow sheet, Fig. 149, the mine ore is delivered to a trommel 40 in. diameter by 10 ft. long, where with the addition of water it is washed and separated into two products, the oversize going to two sets of trommels to yield products for two sets of jigs. The jigs yield a high-grade head which joins the corresponding product from the 30-in. picking belt to go to the high-grade ore mill. This ore amounts to about 9 per cent of the total, and its treatment in the high-grade mill, as indicated at the right side of the flow-sheet, is described under head of "amalgamation of silver ores," page 243. This preliminary treatment lessens the period of agitation necessary with cyanide solution.

Many experiments involving the preliminary reduction of telluride gold ores in caustic soda solution with aluminum and zinc, as well as cathodic reduction in both caustic soda and salt solution, have shown that with cheap fuel and efficient roasting this form of preliminary treatment would present no advantage. The gold telluride compounds are in general more difficult to reduce than the sulphide and sulpho-antimonide silver minerals.

To go back: the undersize from the last trommel, together with the jig tailings, is elevated to a dewatering trommel, 30 in. diameter by 6 ft. long. The oversize joins the ore from the picking belt destined for the low-grade mill, while the undersize after dewatering is sent to join the battery pulp in the same mill.

## THE NIPISSING CO.'S "LOW-GRADE" MILL, COBALT, ONTARIO

The ore, of about 26 oz. silver per ton is treated by *all sliming cyaniding*. The left-hand portion of Fig. 149 gives the flow-sheet of this mill. There are forty heavy stamps of 1400 lb., each battery of ten stamps being driven by a 40 H.P. motor, wet-crushing through a 2- to 3-mesh screen and using for each ton crushed 7 tons of a solution containing 0.7 lb. of caustic soda per ton. This caustic soda addition is necessary as a preliminary to the desulphurizing treatment to follow.

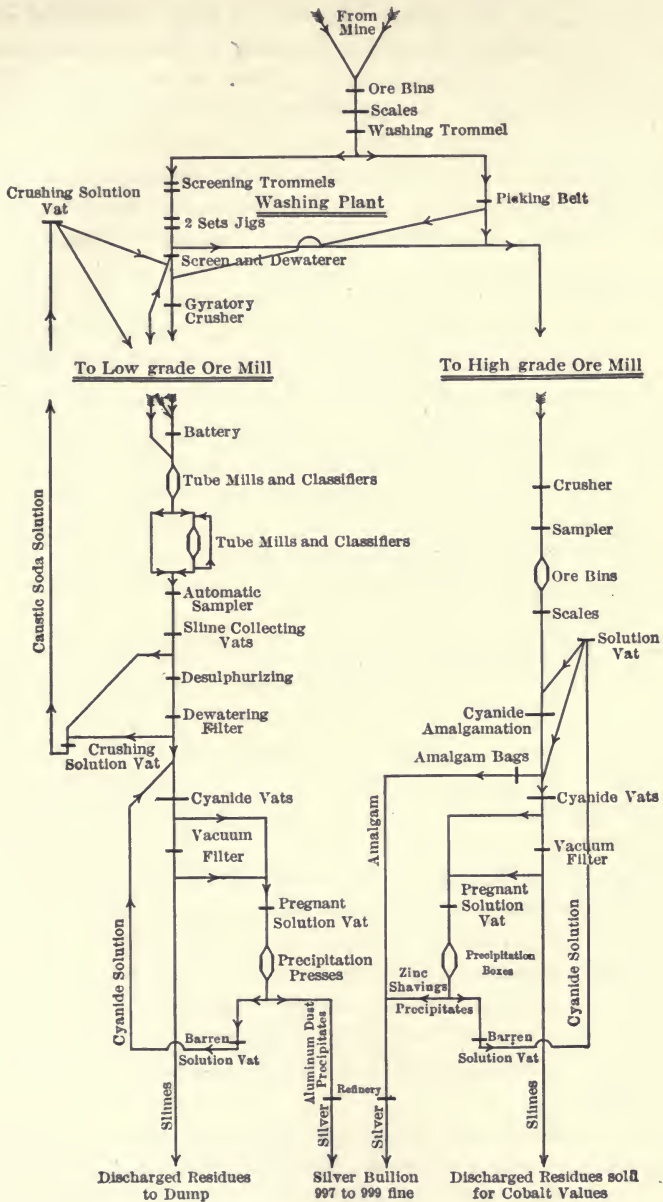

FIG. 149.—Flow-sheet of Nipissing Co.'s Mill.

**Classification and Fine Grinding.**—For high extraction the ore must all be ground to pass 200-mesh. The battery pulp is classified in a first set of four Dorr classifiers, the slime overflowing direct to one or other of the slime-collecting vats in the cyanide plant, the oversize going to two coarse-grinding tube-mills. The discharge from these mills flows into a second set of Dorr classifiers whose overflow joins that of the first set at the slime-collecting vats, and the sands are elevated to two fine-grinding tube mills. The discharge from these flow into a drag classifier, then back to the second set of Dorr classifiers all in closed circuit with the fine-grinding mills.

**Cyanide Plant.**—This is in the largest building, where the vats are placed in two rows, and, with the exception of the solution vat, fitted with mechanical stirrers driven by a 125 H.P. motor at 8 R.P.M. The working load in each vat is 140 tons of dry slime with 280 tons of solution. The slime-collecting vats are dewaterers delivering a clear overflow to a lower crushing solution vat and thence by pipe line marked "caustic soda solution," to the upper crushing vat for re-use at the battery. When one collecting vat is full of a charge the pulp flow is switched to the other. The charge is then agitated for an hour and the thickened pulp, consisting of 1.5 parts of caustic soda solution to one of the pulp, is pumped to desulphurizing treatment.

**The Wet Desulphurizing Process.**—This breaks up the refractory silver minerals, the slimed pulp being brought in contact with aluminum in the caustic soda solution in a tube-mill and the silver left in the spongy metallic state amenable to cyanide treatment. To do this the collecting vat pulp passes to a desulphurizing tube mill, revolving 10 R.P.M. where it comes in contact with a load of about 4000 lb. of aluminum pieces of  $1\frac{1}{2}$ - to 2-in. cubes. The pulp discharge from the mill gravitates to the desulphurizing vat adjoining. In this tank 34 ft. diameter by 13 ft. deep and lined with aluminum in plates, the pulp receives mechanical agitation for a period of twenty-four to thirty-six hours. In order to keep the mill cyanide solution in balance it is necessary to eliminate as much as possible of the caustic soda solution from the desulphurized pulp. This is done in a 60-leaf Butters vacuum filter, marked "alkaline filter" in the plan view. This preliminary treatment lessens the period of agitation necessary with cyanide solutions.

The filtrate passes to the crushing solution vat while the thick slime is pumped to one of the seven cyanide treatment vats fitted for mechanical agitation. There it is treated in charges of 130 tons of dry slime to 260 tons of cyanide solution of 0.25 per cent (5 lb. per ton) with 0.2 per cent alkali. An air lift is operated constantly during agitation, the pulp being drawn off from the bottom and discharged into the top of the vat and treated at the same time. After agitation the charge is allowed to settle

so that the clear solution may be decanted to the "pregnant solution vat." The pulp is then stirred and pumped to a 34-ft. cyanide stock-pulp vat, where it must be kept agitated until drawn off to the 80-leaf Butters vacuum "cyanide filter." The clear solution from the filter is delivered to the "pregnant solution" tank, the residue slime is discharged to the residue dump.

The pregnant solution is now ready to go to the precipitation department at the right of the tube-mill house to be subjected to aluminum precipitation treatment for twenty-four hours.

The cost of treatment in 1912 was given as \$3 per ton. The cost of the plant \$254,000 to treat 244 tons daily.

### CYANIDATION OF SILVER-BEARING CONCENTRATES

	Daily Production in Tons.	ASSAY OZ. PER TON.		% EX- TRACTION.		KCN per ton Concentrates Lbs.	COSTS PER TON OF CONCENTRATES.							
		Au.	Ag.	Au.	Ag.		Grinding.	Roasting.	Dissolution.	Acid Treatment.	Filtering.	Precipitate and Refining.	Total.	
C. Esperanza, Mex.	1	22.68	54.2	99.4	95.8	6.0	..	..	..	..	..	..	..	\$4.85
D. Waihi, N. Z. . .	17	5.6	62.3	96.3	93.5	20.0	..	..	..	..	..	..	..	6.25

C. Tube-milled in 1 lb. KCN solution; agitated in 6 lb. KCN for ten to fourteen days, with two decantations; filter pressed and precipitated by zinc dust; 2 lb. lead acetate and 1 lb. mercuric chloride per ton of concentrates.

D. Tube-milled and agitated in 3 lb. KCN solution for eight to ten days.

## CHAPTER XXIV

### PARTING SILVER-GOLD BULLION

#### PARTING SILVER-GOLD INGOTS OR BARS WITH ACIDS

The bars from reduction works commonly contain gold and silver alloyed with copper, but sometimes also zinc and lead. It is customary to remelt the bars and assay them, buying them on the result of the assay.

The bars are parted in nitric or sulphuric acid. Sulphuric acid, being cheaper, is the acid commonly employed.

Bars containing a large proportion of gold are inquartated by melting them with silver in order to decrease the ratio of gold to silver to at least 1 to 2.5, otherwise the acid fails to attack the silver. In parting with sulphuric acid the copper should be less than 10 per cent, but in nitric-acid parting more than 10 per cent is allowed. To adjust this percentage, bars low in copper are melted with those high in that metal.

**Nitric-acid Parting.**—This method, still practiced at the United States Mint, Philadelphia, is an efficient way of parting, especially on a small scale. The bars having been melted and proportioned as above described, the molten metal is granulated by pouring it into a tank of water. The granulated metal is transferred to porcelain, glass, or platinum vessels, and treated with nitric acid, 1.20 sp. gr., until action ceases. The solution is allowed to settle, then is decanted, and fresh acid is added for the purpose of dissolving the remaining traces of silver. This is again decanted, and the gold residue is washed thoroughly with hot water. It is then ladled out, drained, dried, and mixed with a little flux, and melted in a graphite crucible.

From the decanted silver solution the metal is precipitated by adding common salt. The silver chloride thus formed is washed, thoroughly granulated, zinc is added to reduce the silver to metal, and the zinc chloride resulting from the reaction is washed from the precipitated silver. The silver is pressed into cakes, melted, and cast into ingots for bar-silver.

**Sulphuric-acid Parting.**—Since for this method of parting there should be less than 10 per cent copper present in the gold-silver alloy, and not less than 2.5 parts silver to 1 of gold, the bars to be parted that exceed the required limit, are so selected and melted with others as to afford the required proportion. The melted metal is cast into flat ingots and parted in this form.



The ingots are placed in a cast-iron kettle, covered with a sheet-iron hood that is connected with a chimney so that the acid fumes from the kettle are carried away. Here they are treated with sulphuric acid of full strength ( $66^{\circ}$  B $\acute{e}$ .). When action has ceased the solution is allowed to settle, after which the clear supernatant part is decanted, being drawn off by a lead-pipe siphon into a lead-lined precipitating tank. The residue in the kettle is treated six or seven times with fresh boiling acid. In this way the silver completely dissolves, the acid solution being removed after each treatment. The brown gold residue is finally boiled with water, being heated and agitated by live steam from a pipe inserted in the water. In this way the gold is "sweetened." The residue is removed from the kettle, dried, melted in crucible with a little borax for flux, and cast into a bar of gold 999 fine.

The acid solution from the kettles, which flows to the precipitating tank, is diluted with water, and the silver is precipitated by hanging copper plates about 1 in. in thickness in the solution. The copper replaces the silver in the acid solution, which becomes blue in color. When precipitation is complete the clear solution is decanted, and the cement silver at the bottom of the tank is washed with hot water to remove the acid copper-solution. The "cement" silver, or precipitated silver, is removed to a box, then pressed into cakes or cheeses in a hydraulic press. Thus compressed, it is ready for melting in plumbago crucibles after adding a little borax flux. In large establishments the silver is melted in a small reverberatory furnace where it can be conveniently fluxed, skimmed, and ladled into bars for the market. The bars weigh 35 lb. or 500 oz. each. On refining, each bar is marked with a number and the exact weight and fineness, and the name of the refinery that produced it.

#### ELECTROLYTIC PARTING OF GOLD FROM SILVER

The U. S. Mint, San Francisco, receives bullion of 200 fine or over of gold and silver. Gold bars of 900 fine or over are treated by a gold-refining process, while others are melted together to be cast into cathodes 600 fine in silver, 300 in gold, and the remaining 100 in base metals.

**Silver Refining.**—The anodes,  $3\frac{1}{2}$  in. wide by  $8\frac{3}{4}$  in. high by  $\frac{1}{2}$  in. thick, are hung in earthenware cells together with thin sheets of silver for cathodes, using for an electrolyte a nitrate of silver solution that carries 3 per cent silver and  $1\frac{1}{2}$  to  $2\frac{1}{2}$  per cent of free nitric acid and using a current of 0.8 ampere per square foot. The pure silver collects on the cathodes as a sponge deposit. Part falls to the bottom of the cell as slime. From time to time the anodes are taken out and the sponge jarred off. This and the slime are melted to produce a gold bar. The pure silver collects on the cathodes in crystalline condition and they are lifted out daily to remove the silver. The final product is melted into silver bars.

**Gold Refining.**—The anodes of the same size as the silver ones should be at least 900 fine in gold and less than 70 fine in silver. They are hung in porcelain cells with thin pure gold sheets for cathodes and in an electrolyte consisting of gold trichloride having 7 per cent gold and 10 to 12 per cent of free hydrochlorine acid. A high current (90 amperes per square foot) is used. The cathodes when built up to 160 oz. each are removed and cast into ingots of 999 fine.

The spent electrolyte is replaced by fresh. When it gets impure it is separately treated to recover some silver and the base metals.

#### PRICES AND COSTS

The prices of silver ores sold to custom smelteries are given under head of the schedule of silver-lead ores being for a dry ore.

**Silver.**—At New York the quotations are on silver bars, per troy ounce of silver, 1000 fine. It takes 14.58 troy ounces to make 1 lb. avoirdupois. London prices are for sterling silver, 925 fine. The value of the pound sterling is also given, so that with the London quotation, we may compute the equivalent price in cents there. Let us say that sterling exchange is \$4.86, and that silver is selling at 25d. per sterling ounce, we have then:

$$\frac{25}{240} \times 4.86 \times \frac{1000}{925} = 54.8 \text{ cents per ounce of fine silver.}$$

PART IV  
IRON AND STEEL



## CHAPTER XXV

### IRON ORES AND THEIR SMELTING

#### CLASSIFICATION AND OCCURRENCE OF IRON ORES

These, the oxides and carbonates of iron occur accompanied by earthy minerals forming the "gangue." Only those are regarded as iron ores that contain sufficient iron to make the recovery of the metal profitable. In this discussion of iron ore it is to be understood that reference is made to them as smelted for the iron they contain, and not as a flux as used in silver-lead and copper smelting where the iron enters a slag to be thrown away.

There is a general division of iron ores into two classes, viz., Bessemer and non-Bessemer. This arises from the fact that a steel containing more than 0.10 per cent phosphorus is brittle, and hence, in the acid-Bessemer steel-making process, the pig iron used must have rather less than that quantity. Now since about 2 tons of iron ore make a ton of pig iron, the iron ore should, for safety, not contain more than 0.045 per cent phosphorus. At about that limit the ore is called non-Bessemer. In the duplex process of steel making this distinction has become of little importance, since a steel from the Bessemer converter, high in phosphorus, can be freed from it in the open-hearth treatment that follows.

Iron ores, especially in the United States, are oxides. They may be divided into hematites, magnetites, and brown iron ores. The carbonates are there found sparingly.

**The Hematites.**—The iron in them exists as  $\text{Fe}_2\text{O}_3$  (70 per cent Fe). Of iron ores red hematite is the most desirable. Most of the Lake Superior deposits are of this variety. The ores from the Michigan and Wisconsin districts or ranges are called "old-range ores." Much hard or lumpy ore comes from these ranges while from the Minnesota ranges much of the ore is soft.

Following we give the composition of some of these ores as shipped to the iron furnace in their natural (or moisture-containing) condition.

But Mesabi ores will vary from 39 to 67 per cent in iron. The poor ores are now concentrated to bring them up to shipping grade.

Range.	H <sub>2</sub> O.	Fe.	SiO <sub>2</sub>	S.	P.	Mn.
Marquette, Mich.....	2.0	56.0	12.0	0.01	0.04	
Menominee, Mich.....	7.5	59.0	4.5	0.01	0.38	
Gogebic, Wis.....	11.0	54.0	6.0	0.03	0.07	0.4
Vermilion, Minn.....	3.5	64.0	4.0	Tr	0.10	
Mesabi, Minn.:						
Bessemer.....		60.5	5.2	0.04		
Non-Bessemer.....		58.0	6.5	-.09	0.9	

An average analysis of Lake Superior shipping ores in 1919 gave H<sub>2</sub>O, 11.3 per cent; Fe, 58.4 per cent; SiO<sub>2</sub>, 7.7 per cent; S, 0.06 per cent; P, 0.09 per cent; Mn, 0.7 per cent, the bulk of the ore being of Bessemer grade.

Among the ores of the United States we should also mention the Alabama beds, and those of Colorado and Wyoming in the West.

There is a red hematite at Sunrise, Wyo., which carries Fe, 62 per cent and beds at Orient, Colo., of easily reducible limonite of 50 per cent.

The Alabama ores may be divided into three varieties: First, the brown ore or limonite, averaging Fe, 51 per cent; P, 0.4 per cent and S, 0.10 per cent; second the soft hematite of Fe, 47 per cent and with as much as 17 per cent in silica; and third the hard red carbonate ore of Fe, 37 per cent; SiO<sub>2</sub>, 13 per cent; P, 0.37 per cent CO<sub>2</sub> and 12.2 per cent. They are hard, heavy and hence, usually nearly black in color.

**Magnetite** occurs in large deposits in Sweden, and in various parts of the United States. While some of the beds are rich, many contain no more than 40 per cent iron and carry so much silica that the fluxing and smelting is not profitable. Much work has been done in the concentration of these ores, both in Sweden and the United States. In New Jersey extensive beds occur that have been utilized by Edison for the production of a high-grade ore on a commercial scale. He has mined the deposit, crushed and concentrated it, and made it into briquettes that contain as little as 3.3 per cent silica and 0.04 per cent phosphorus, and as high as 67 per cent iron. The enterprise, however, could not continue at a profit in competition with foreign ores from Cuba and Spain. Cuban ores include magnetites of Fe, 50 per cent; SiO, 10 per cent; S, 0.37 per cent; Cu, 0.10 per cent. The Spanish spathic ore has H<sub>2</sub>O 0.91 per cent; Fe, 48 per cent and SiO<sub>2</sub>, 10 per cent. Some of the New York beds near Lake Champlain have been considered valueless on account of the presence of titanium, it having been asserted that this element produces an infusible sticky slag. This, however, has been proved to be unfounded, and it should not prevent their use as a source of iron. It is to be noted that the famous Iron Mountain, Missouri, is a deposit containing 31 per cent iron and 6 per cent titanium oxide, but the deposit

is not now worked. In Pennsylvania the Cornwall beds are the most important, and yield a pig-iron carrying not more than 0.04 per cent phosphorus. The ore runs 2.5 per cent sulphur, and about half of this is removed by kiln-roasting before smelting. It contains also copper, which will be found in the pig to the extent of 0.5 to 0.75 per cent. This does not matter in the finished product, but, if the pig-iron is made into steel, the copper causes "hot-shortness" or brittleness when hot, thus causing imperfections when rolled into shapes. The average of ore mined is 40 to 42 per cent iron and 20 per cent silica.

At Fierro, N. M., is a large deposit of hard magnetite running up to 61 per cent in iron.

**The Brown Ores.**—These are hydrous sesquioxides and may, when pure, be represented by the formula  $\text{Fe}_2\text{O}_3 + 3\text{H}_2\text{O}$ , equivalent to 60 to 68 per cent iron. Limonite, locally known as bog ore, a brown hematite, when roasted has this water of combination expelled, changing then to true hematite. Oolite is a variety that exists in the form of grains or nodules, and contains silica and lime. When silicious, as in places in Alabama, the ore is well-nigh worthless, but when limy, as in the Minette region of Alsace and Lorraine, the ore is self-fluxing, that is, the lime will flux the silica that the ore contains. A typical Minette ore carries Fe, 38 per cent;  $\text{SiO}_2$ , 9.2 per cent; CaO, 12.1 per cent. In the United States these ores occur parallel to the Appalachian range from Pennsylvania into Alabama, and on both sides of the Mississippi, in Tennessee and Missouri. Due to the presence of much phosphorus these ores are of non-Bessemer grade. They will vary from 40 to 50 per cent in iron, 5 to 20 per cent in silica, 0.05 to 0.4 per cent in phosphorus, and from 0.3 to 2.0 per cent in magnesia.

**Carbonate ore**, siderite ( $\text{FeCO}_3$ ), as a pure mineral contains 48.3 per cent iron. The varieties are spathic, black band, clay-band, or clay iron-stone. It is often roasted to expel the moisture and carbon dioxide before going to the blast-furnaces. In England it forms the well-known clay iron-stone of the Cleveland district, but in the United States, though widely distributed, it is too low in grade to be used in competition with the abundant rich ores.

At Eisenerz, Styria, is a celebrated deposit of siderite. The ore, which averages 39 per cent iron, is worked in vast open cuts. The Spanish spathic ore has  $\text{H}_2\text{O}$ , 9.1 per cent; Fe, 48 per cent and  $\text{SiO}_2$ , 10 per cent.

### ROASTING IRON ORES

In order to expel moisture, carbon dioxide, and sulphur, and to render the ore more porous, and so more susceptible to reduction in the blast-furnace, as well as to decrease its weight, iron ores, especially carbonates, are

often roasted, preferably in kilns of which Fig. 150 is an example. The ore is charged to the kiln in layers alternated with sufficient fine coal, so that the roasting heat is maintained and the kiln is kept quite full. Peep-holes or openings at the boshed part of the kiln are for observation and for loosening the charge by aid of a bar as needed. Ore is unloaded, as shown, from cars into the kiln. The roasted material runs out at the bottom as

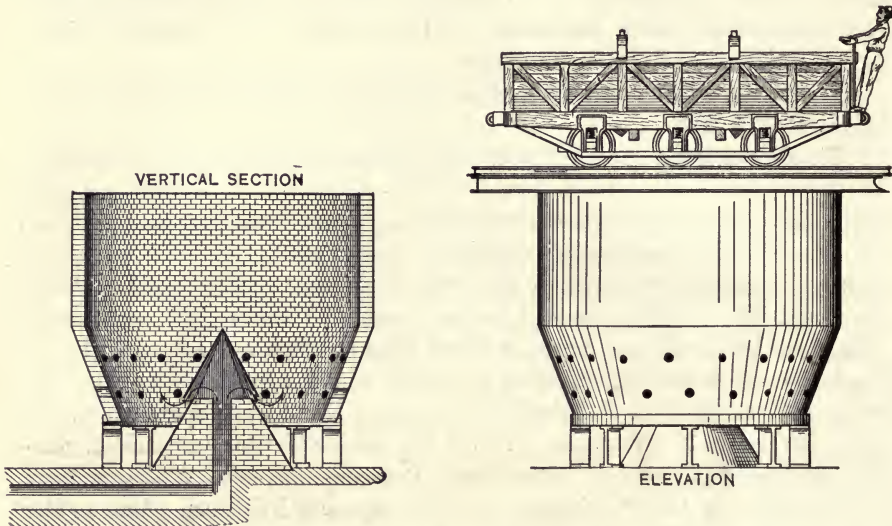

FIG. 150.—Gjiers Calcining Kiln.

fast as it is removed. Air is admitted to the midst of the charge under the cast-iron hood, at the apex of the central cone.

#### THE AGGLOMERATION OF FINE ORES

In modern blast-furnaces, due to their high stacks and heavy blast pressure, it is difficult to smelt a high percentage of dusty or finely granulated ore, such as those of the Mesabi range. Where 60 or 70 per cent of such ores must be used there is a heavy flue-dust loss, scaffolding of the furnace, and frequent explosions. The fine ore, descending more quickly than the rest of the charge, is imperfectly reduced, causing disturbances in furnace operation and the production of "off-iron," that is of pig iron of other than the expected grade. Fine ores, therefore, ought to be put in lump form. This may be accomplished:

- (1) By nodulizing in revolving kilns or cylinders similar to Fig. 72 but longer. For such ores as shrink much in roasting the method is valuable, but the product is seldom uniform.
- (2) By blast-roasting. This is done on a Dwight-Lloyd sinter machine,



as described on page 112. The product is porous and well sintered to blast-furnace smelting.

(3) By briquetting. This is done with or without binding material, and is usually followed by the heating of the briquettes to resist breaking and the heat in the blast-furnace. Care must be taken in making them that they retain their porous character.

### SMELTING FOR PIG-IRON

**Outline of the Process.**—The operation is conducted in a furnace, often 100 ft. high, filled with a mixture of coke, iron, ore, and limestone. Superheated air is blown in at the bottom. The coke is burned to maintain a high temperature in the furnace and to reduce the iron in the ore to the metallic form as pig iron. The pig iron collects at the hearth or bottom



Fig. 151.—Three Traversing-bridge Tramways with 5½-ton Grab-buckets; Storage capacity, 500,000 tons.

of the furnace, and is removed from time to time. The gangue, or silicious part of the ore, is fluxed with limestone, and produces a worthless slag, or cinder, which is also removed (tapped) as it accumulates in the furnace.

### IRON BLAST-FURNACE AND PLANT

**Blast-furnace Plant.**—Fig. 152 is a view of an iron blast-furnace plant for the manufacture of pig iron from iron ores. In the foreground is a cylindrical furnace-stack 100 ft. high, immediately in front of which is the forked “down-comer” (see 39, Fig. 155), a large pipe that conveys the smoke from the stack near the top downward to the flue-system that carries it away. In front of the down-comer is seen the inclined hoist for the “stock” or the materials that are put into the furnace. At the middle of the illustration are the four cylindrical “stoves,” as high as the furnace, used for preheating the air blown into the furnace, while the highest stack

behind them draws away the gas from the stoves. In front of the four stoves is the blast-main, a pipe 5 ft. diameter by which the air is conducted to the furnace. At the left of the stoves is the building (not shown),

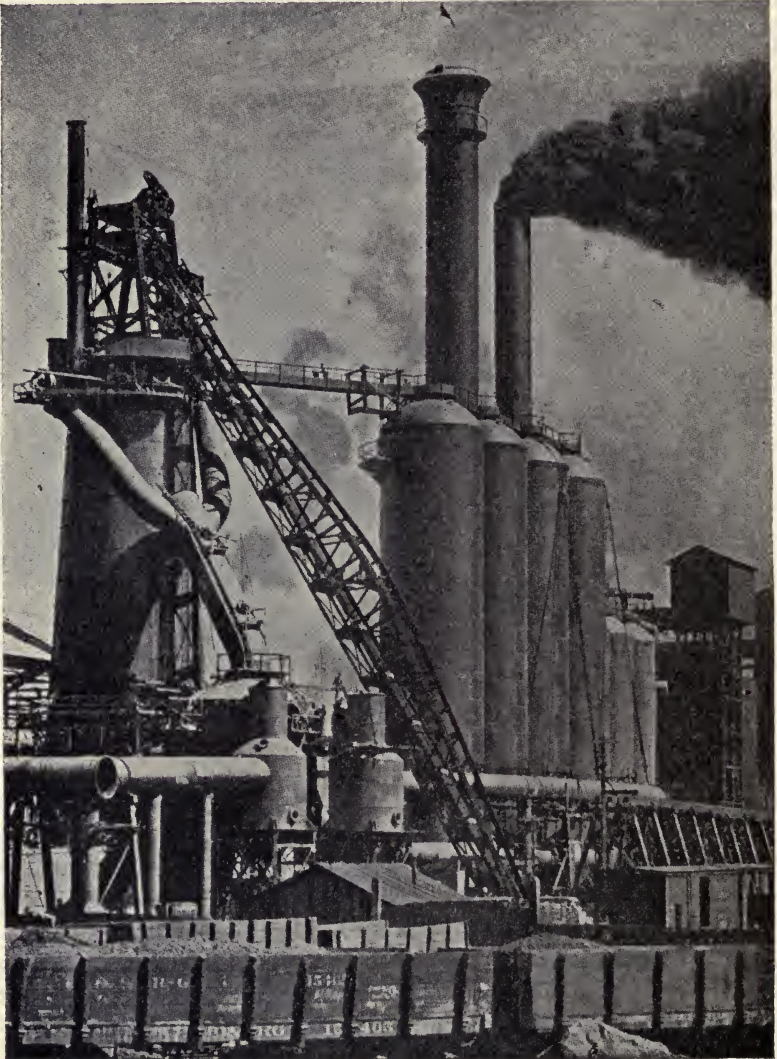

FIG. 152.—Blast-furnace Plant.

that contains the vertical blowing engines by which air, under 15-lb. pressure, is delivered through the stoves to the blast-furnaces. Fig. 160 represents a vertical blowing engine.

The general arrangement about the furnace is understood from the elevation Figs. 151 and 153 and the plan Fig. 159. The blast-furnace 100 ft. high is at the right. It is served by an inclined hoist, one skip of which is in position in the pit ready for loading, the other in discharging position at the top. Within the stock-house, at the left, are three standard-gauge tracks on three levels. The upper one at the left is for the hopper-cars that deliver iron ore and fluxes to sloping-bottom bins beneath, shown in section.

The second one leads to similar bins (not shown in section), and the third to the floor on the ground level. On this level is a charge-car, elec-

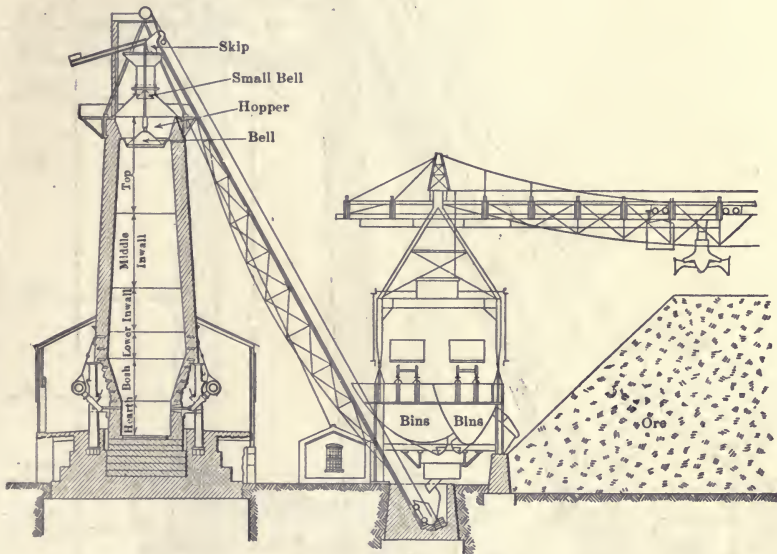

FIG. 153.—Section of Blast Furnace, Showing Filling Arrangement, Bins and Ore-bridge.

trically driven, with a weighing attachment that can be brought to any bin to receive a weighed amount of stock. The load is then transferred to and discharged into the skip. In case of accident to the charge-car, or any trouble at bins, the furnace can be supplied by the use of hand-barrows or buggies, taking the stock from the piles that have been made beneath the third track. Hoisting is done by a hoisting engine set well out of the way at the top of the stock-house. Just beyond and at the right of the furnace is the cast-house, where the molten iron is molded into pigs when a cast is made.

**Iron Blast-furnace Plant at a Lake Port.**—We give in Fig. 151 a transverse elevation of a furnace plant as arranged at a lake port where the ore has been stored for use in the winter months and where a

traveling crane is used to reclaim it. The same crane has also been used to unload from the ore boat at its other end. The ore is taken from the pile by means of a 10-ton grab bucket which loads it into cars standing upon tracks, these set so they can readily discharge into the feed pockets

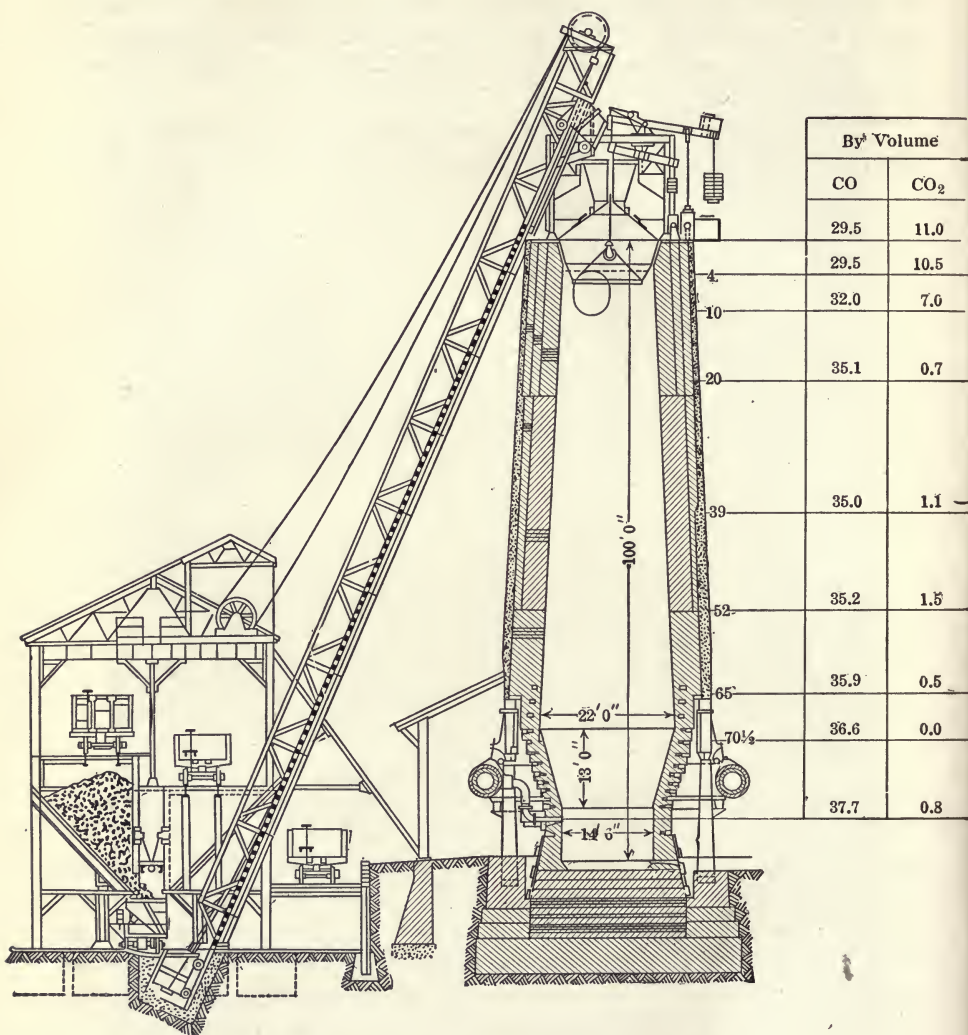

FIG. 154.—Blast-furnace with Automatic Charging.

of the blast-furnace. Coke is brought in directly from the coke ovens by car. The feed pockets, as shown, are semicircular and both coke and ore are withdrawn from them much as shown in Fig. 154. It will be seen that the charge-car, which is self-weighing, runs under any of the feed

pockets, and the materials weighed into it are then taken to the feed skip of the furnace.

**The Iron Blast-furnace.**—Fig. 155 is a furnace, shown in part section, and part elevation. It is circular in cross-section.

Beginning at the bottom there is a heavy foundation of concrete and firebrick upon which rests the hearth 15 and columns 4 which support the

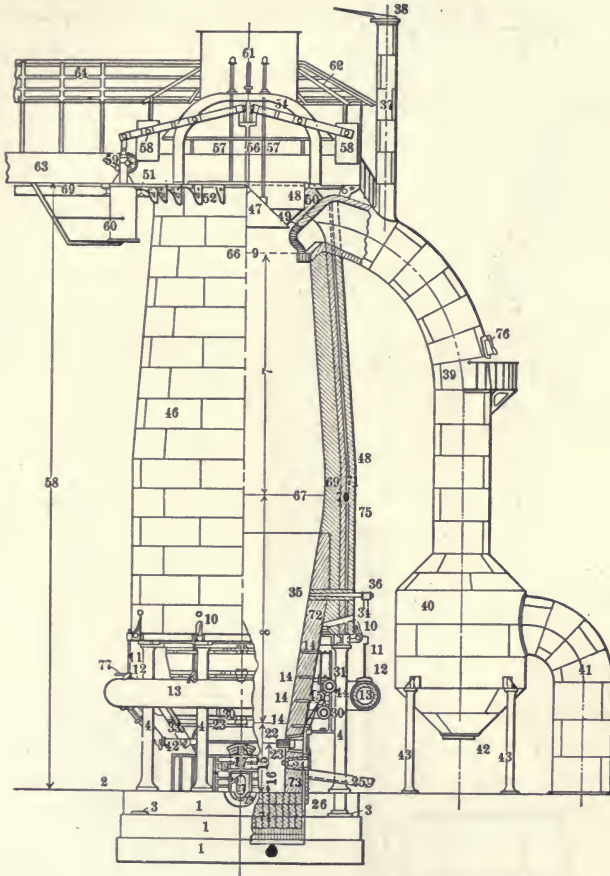

FIG. 155.—Blast-furnace, Detailed Section.

upper brickwork that constitutes the shaft of the furnace. The hearth or crucible ( $14\frac{1}{2}$  ft. diameter by  $9\frac{1}{2}$  ft. deep), that contains the molten iron and slag, extends from the foundation to a height slightly above the tuyeres 22. The bottom and walls (see Fig. 156) are of firebrick, high in alumina like Y of page 34, but soft and porous. Near the bottom is the iron-tap 27, through which the molten pig iron is withdrawn when a quantity has

accumulated. At 23 is the cinder-notch or tap by which the slag or cinder is drawn off. The crucible is surrounded by a hearth-jacket of steel plates,

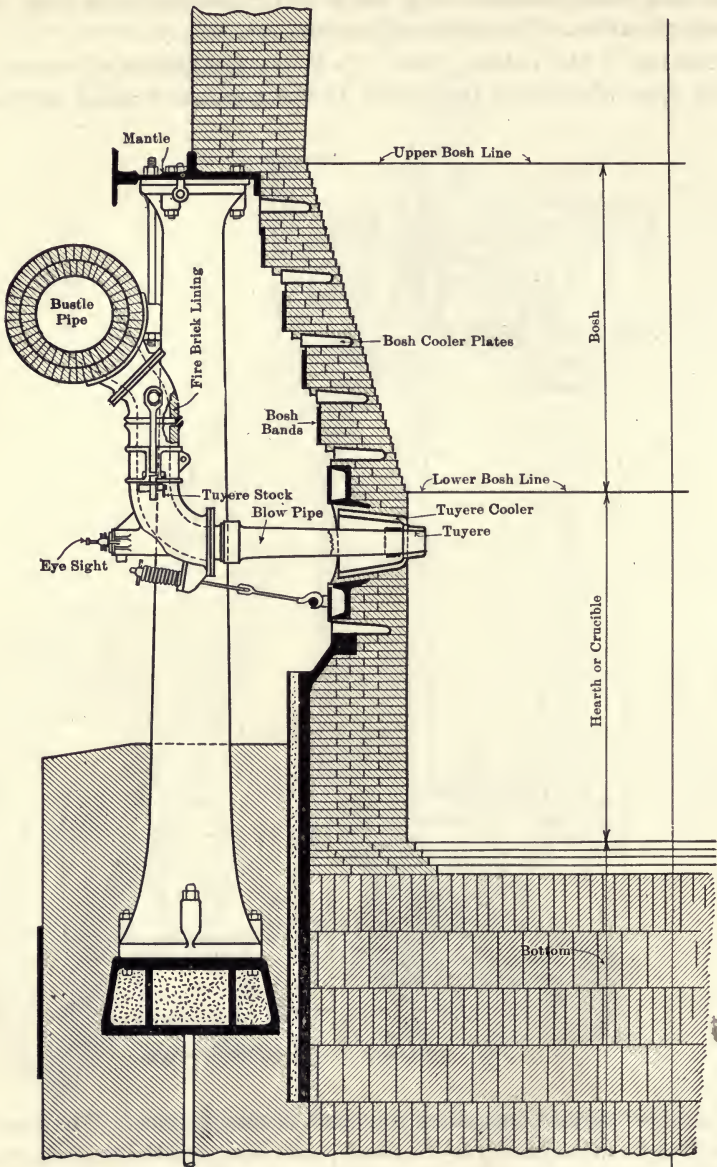

FIG. 156.—Blast-furnace Hearth and Bosh.

cooled on the outside by sprays of water that play against it, cooling and protecting it and the brickwork lining from the corrosive action of the mol-

ten slag inside. Air, under a pressure of 5 to 14 lb. to the square inch, enters through the tuyeres 21, which have projecting nozzles 22, as more fully shown in Fig. 156. Care is taken to withdraw the slag before it reaches the level of the tuyeres, for it would enter the openings and close them. Of these tuyeres there are six. The air is supplied through the tuyere-stocks 33 from the bustle-pipe 13, which encircles the furnace, and connects with the blast-main supplying air at the temperature of a red heat from the stoves. The bustle-pipe, tuyere, and tuyere-stock are shown in the section Fig. 156. The bosh, or that part of the furnace that widens from 14 ft. 6 in. at the hearth to 22 ft. in a vertical distance of 13 ft., is also shown. It is in the region of the bosh that the formation of the slag occurs, and the brickwork of the bosh is subject to a slagging and scouring action that tends to attack and destroy it. To prevent this, hollow water-cooled bosh-cooler plates are laid in the brickwork of the bosh, making rings around the furnace at nearly every two feet vertically. The slag cuts into the brickwork nearly as far as the inner ends of these plates, but the circulation of water within them protects the adjacent brickwork from deeper corrosive action. The bricks of the bosh are a little harder than in the crucible, but are high in alumina and porous.

That both the bustle pipe and the tuyere are lined with firebrick is well indicated.

The shaft, or main brickwork structure of the furnace, is carried by the cast-iron mantel 5, resting upon the columns 4. It extends from the top of the bosh to the throat at 9. The upper part of the furnace is closed by a bell 47 (Fig. 154 shows a double bell), and the gas escapes at the side through the down-comer 39. The in-wall 69, is of a hard firebrick like IV, page 34, while the main portion is of common brick and is sheathed with a shell 46, of steel plates.

The tendency in modern practice is to insert cooler-plates extending through the inwalls from the mantle upward, carrying these higher and higher as the necessity for protection demands.

When in operation the furnace is kept full to a level just below the outlet to the down-comer. This level is known as the stock-line, and the furnace at this point is 15 ft. diameter. As the stock smelts and sinks, charges are introduced and the stock-line is maintained at this level.

Ordinarily the top of the furnace is kept closed by the conical bell 47, which is suspended from the ends of the counterweighted beams 55. The bell closes the bottom of a circular hopper 48, into which the charge in this particular furnace is supplied by buggies brought up by the elevator to the upper or charge-floor of the furnace or "tunnel-head," as it is called. To drop a charge into the furnace, the outer end of the lever is raised by the piston-rod and piston of the air-cylinder 60. The bell thus lowered permits the charge to slide into the furnace, after which it is immediately raised

to close the opening and stop the outward rush of smoke and gas that mainly escape through the hood 61. The gas, containing dust from the charge, passes off by the brick-lined down-comer 39 to the dust-catcher 40 (where a part of the dust settles), and by the goose-neck pipe 41 to an underground flue that leads to the stoves and boilers where the gas is burned. Rising from the down-comer is the bleeder 37, that is used when it is desired to relieve the top pressure of the gas rising from the charge. It is occasionally used. Other openings are provided closed by weighted doors, called explosion doors, so that in case of a slip or fall of material due to the giving way of a scaffold or handing up in the furnaces, relief is given to the high pressure of gases suddenly released. At many furnaces the stock is raised in hand-barrows or charge-buggies to the furnace-top or tunnel-head 51 by means of a platform hoist.

In Fig. 154 is shown the present method of charging with the inclined hoist. A double bell is used to prevent the escape of the gas. The charge is dropped from the hoist into the upper hopper, where it is retained until the lower hopper is empty. The smaller upper bell is then lowered and the charge slides from the upper into the lower hopper, while the upper bell is closed. The hopper is then ready to take another charge. The charge in the lower hopper, when needed, is dropped into the furnace by lowering the lower bell. It slides outwardly to the walls, forming a ring or ridge, the stock in the middle being a little lower than at the sides.

However, the skip, dumping only in one direction, is apt to deliver the coarser ore to the opposite side of the furnace, so that the blast comes up more freely there, producing greater heats and a "hot spot" on that side. To overcome this trouble distributors are used where the charge in the bell is rotated through a varying arc which delivers it successively to the different segments of the furnace. Just beyond and below the lower bell is noticed the oval outlet to the down-comer. The stock-line must be kept below this.

The skips of the hoist run in balance and are charged as follows: The charge-car on the ground level is run to the chute of an iron-ore bin to receive the required weight of ore. It is moved to the limestone bin beyond to get the needed quantity of limestone, and then to the skip standing below in the charge-pit, where it is discharged. The skip is next hoisted and dumped, while the empty one is in position to take the load of coke. After elevating the fuel, a charge of ore and flux goes next. These charges alternate in the furnace and form layer upon layer.

The dimensions of a blast-furnace are limited. The considerations are as follows: The hearth should be not more than 15 ft. diameter lest the blast fail properly to penetrate to the center and maintain intense combustion there. The slope or angle of the bosh-wall must be such as to give proper support to the charge, which rests upon it, and yet allow the solid



coke to slip down; an angle of  $80^\circ$  is preferred. The height is limited to the height of the smelting zone. These conditions limit the diameter of the bosh to 22 ft. From the top of the bosh the stack wall must decrease in diameter to the throat to give room for the descending charge to swell by reactions that occur in its downward progress. This leaves, at the throat, a diameter suitable for the proper distribution of charge. Furnaces have been built higher than 100 ft., but such height has been found to be excessive, especially for fine ores; and the best practice calls for 90 ft. or less.

### GAS CLEANING

The top gas coming away from a blast-furnace, especially when smelting fine ore, carries much dust caused by the agitation of the blast. Some of this is settled out in the dust-catcher, but the gas still remains quite dusty. When the gas is subsequently burned at the stoves the dust settles in the checker work and at the boilers it attaches itself to the stoves. If the gas is cleaned it burns more efficiently and, moreover, it can then be used for driving a gas-engine blower plant.

Fig. 157 gives the views of a scrubber plant for gas cleaning for stoves and boilers for two furnaces. Of the figure, *W*, is a front elevation, *X*, a side elevation, *Y*, a separate elevation of the dust-catcher, and *Z* a plan view of one of the scrubbers, to show the arrangement of the water sprays. The gases from the dust-catchers of the two furnaces are united in the 7-ft. gas main, *a*, to go to either of two dust-catchers, *b*, each leading to the scrubbers, *s* and *s'*. It should be here noticed that one of the scrubbers, if pushed, will clean 40,000 cu. ft. of gas per minute while the other may be by-passed and used as a spare, though for the best work both are used. In each scrubbing tower, 14 ft. diameter by 74 ft. high, are two sets of ring pipes each sending up jets of water, these effectively cleaning the ascending gas, wetting down the dust particles and causing their fall to the sump below. Here is a goose-neck siphon that permits the discharge of the wetted particles or ore pulp. The cleaned gas from the top of the towers passes by the down-corer, *c, c*, to dust catchers *d, d*, that discharge into the clean-gas main *E*, for use at the stoves and boilers.

### THE HOT-BLAST STOVES

The efficient operation of an iron blast-furnace requires that the air entering at the tuyeres be brought, generally to a red heat ( $500$  to  $750^\circ$  C.). To do this the furnace is equipped with three or four (as in Fig. 152) regenerative firebrick stoves 80 ft. high and 14 ft. diameter. The Cowper stove (of Fig. 158), for example, consists of a tight shell, like a boiler shell of steel plates, lined with firebrick, and containing a

checker-work of bricks of special shape laid in open order so as to have numerous openings or passages from the top to the bottom of the stove.

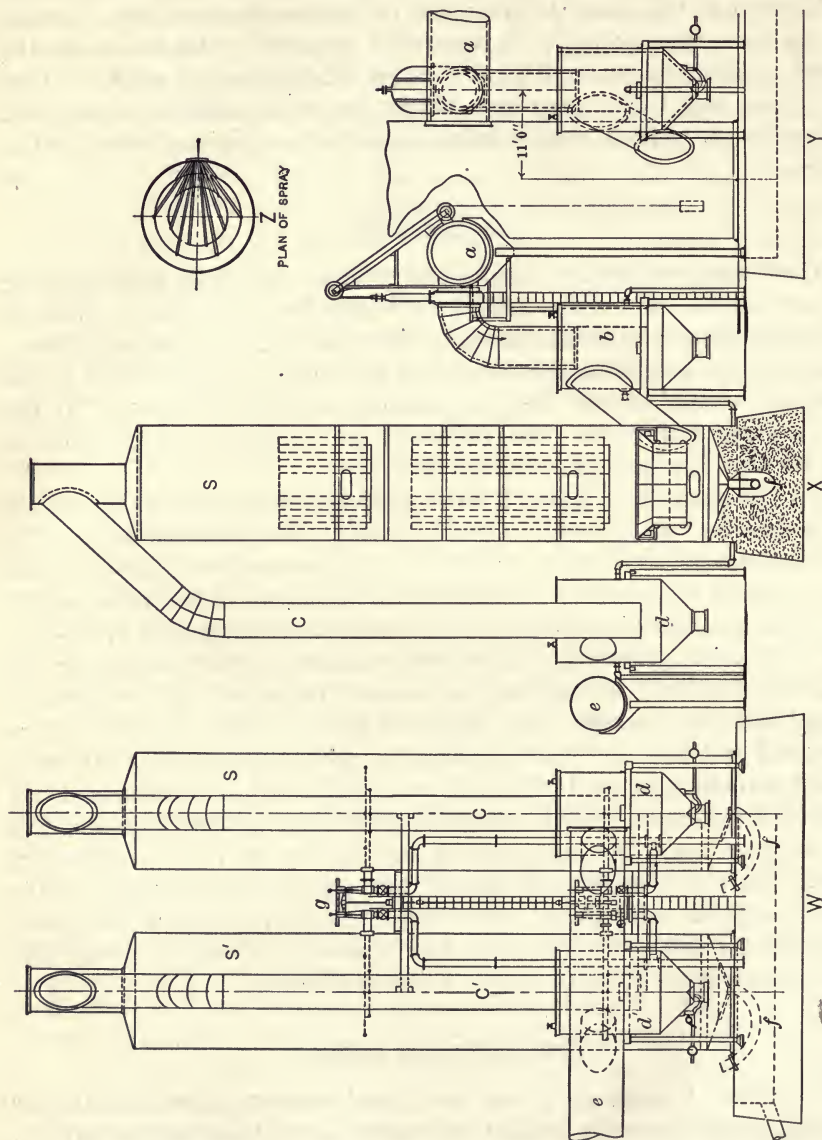

Fig. 157.—Scrubbers for Stoves and Boilers.

The gas from the furnace, containing 24 per cent  $\text{CO}$ , which in burning supplies the heat, flowing along the underground flue from the goose-neck before mentioned, enters the stove  $g$ , while the air is admitted at  $a$ ,

the two mingling and burning in the vertical circular flue *f*, and heating the checker-work in their passage to the valve *s*, as shown by the arrows. The gas thence passes by an underground flue to a tall stack, 200 ft. high, shown behind the stoves in Fig. 152. Gas having burned in this way a half hour, the stove becomes heated. The valves *g*, *a*, and *s* are closed, and the cold-air valve at *c* near the bottom of the stove is opened, admitting air under pressure from the blowing engine; the hot-air valve *h*, at the bottom of the flue *f*, being at the same time opened. The air rises through the hot checker-work, descends the flue *f*, and passes out at *d* to the brick-lined hot-blast main, and to the furnace.

Meanwhile the gas has been turned into the other stoves, and is heating them in the same way. After the blast has been received in the first stove a half hour it is turned into the next heated stove, and so on. The extensive surface of the checker-work serves to absorb a large amount of heat from the burning-gas, and to impart the heat subsequently to the blast-air. It will be noticed that the air enters at the coldest and leaves at the hottest part of the stove. It flows in a direction opposite to that of the burning-gas, thus insuring the maximum rise in temperature. In the course of half an hour, the hot air, leaving the stove, falls at least 100° C. in temperature.

Not all the gas from the furnace is needed for heating the stoves, and a

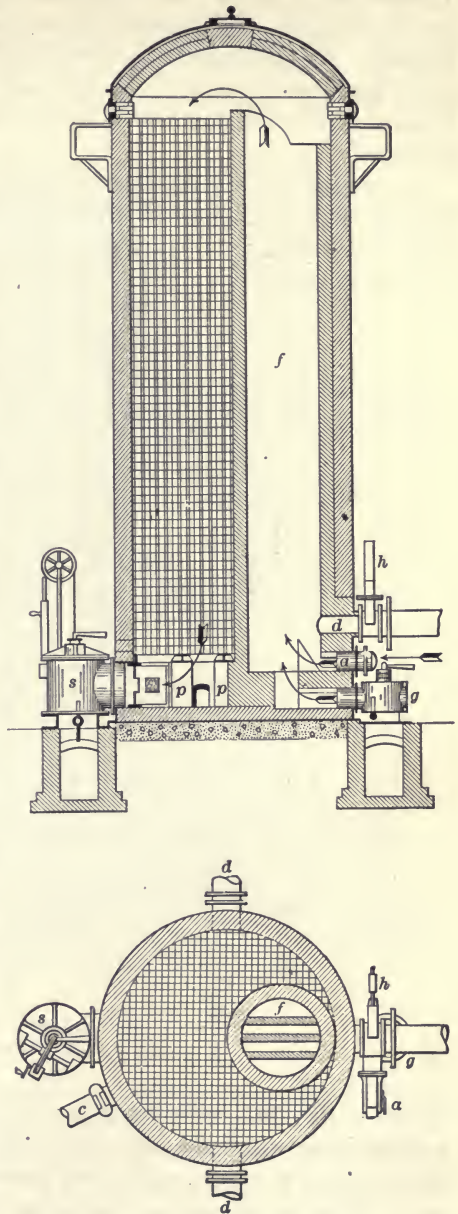

FIG. 158.—Cowper Hot-blast Stove.

portion is burned under the boilers of the plant for making steam for power. The amount of steam thus available is sufficient to run the blowing-engines, hoisting-engines, hoisting-mechanism, and all machinery belonging to the furnace. At some plants the surplus gas, after the stoves have been supplied, has been cleaned from dust and used in gas-engines. Power can be gained in this way and is more available for rolling mill or other purposes.

Formerly the air was heated in iron-pipe stoves, the air circulating through a nest of pipes inclosed in a furnace or brick heating-chamber. These are no longer used, but have been supplanted by the regenerative stoves just described.

### BLAST-FURNACE AND ACCESSORIES

Fig. 159 is a plan of the blast-furnaces, showing the course of the gases throughout the plant. From near the top of the blast-furnace, as well

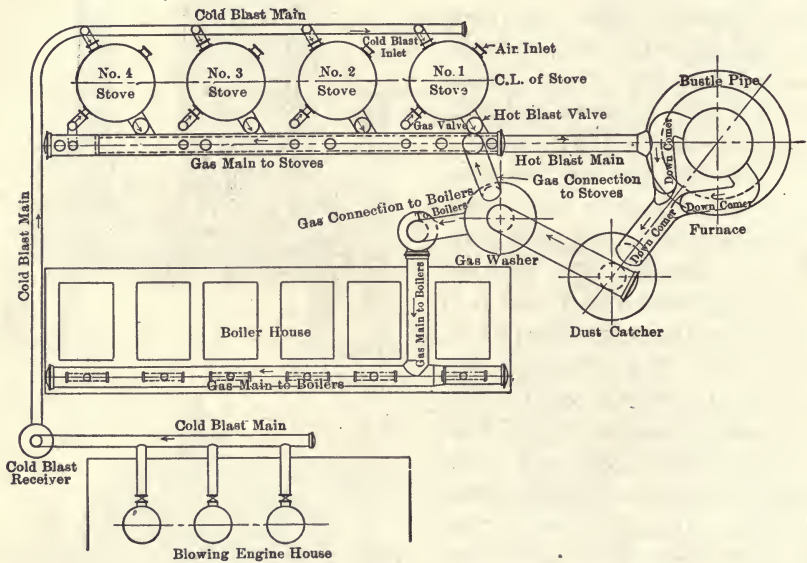

FIG. 159.—Plan of Furnaces and Stoves.

shown in Fig. 152, come away the two branches of the down-comer which uniting in one enter the top of the dust-catcher. This settles out much of the flue-dust in the furnace gases produced by the heavy blast in the furnace. The rest is removed at the gas washer, so that a dust-free gas may be used at the boilers and the stoves. A gas-main, taken off at the gas-washer, passes along the front of the boilers with branches to each, where it is burned for the generation of the steam needed for driving the blowing

engine, that taking some 9 per cent of the total heat. The other branch from the gas-washer passes along in front of the stoves, some 14 per cent of the total heat being there utilized. From the blowing-engine house, where there are three blowing engines, comes away the cold-blast main to the stoves. Here the air is heated  $500^{\circ}$  to  $750^{\circ}$  C., and goes by the hot-blast main to the bustle pipe, thence through the tuyeres, into the blast-

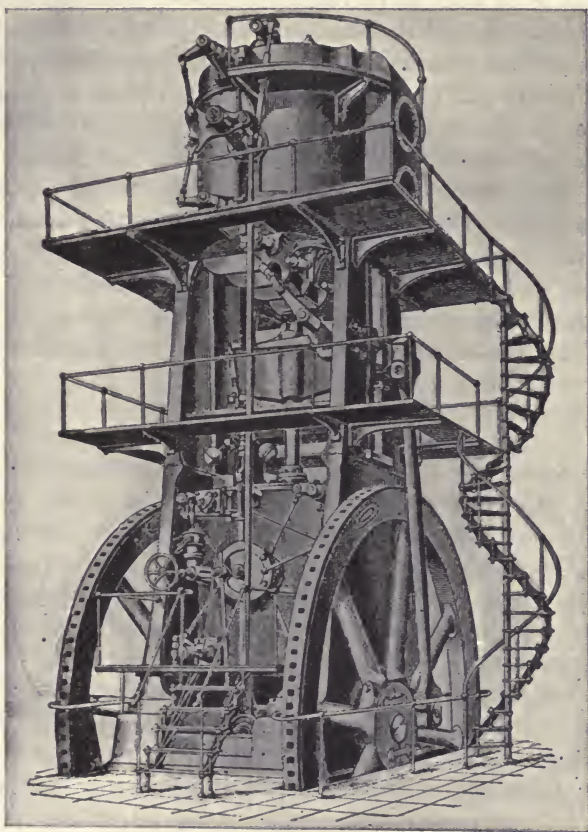

FIG. 160.—Blowing-engine.

furnace. Both the hot-blast main and the bustle pipe are lined with tile to prevent heat loss by radiation from the pipes.

**Blowing Engines.**—Fig. 160 gives a view of a vertical blowing-engine, having an air-cylinder at the top 7 ft. in diameter and of a 5-ft. stroke. The cylinder displaces 385 cu. ft. air per revolution, or 15,400 cu. ft. free air per minute, and delivers it at 15-lb. pressure. The air-admission and discharge valves are arranged to operate positively, and to open and

close at exactly the right moment. Enough of these engines are installed to supply the amount of air required by the furnace.

### OPERATION OF THE BLAST-FURNACE

The ore is dumped into the furnace with 45 to 60 per cent of its weight of coke, and the limestone needed to form the predetermined slag. The furnace should be at least 65 ft. high, and is now built 80 to 100 ft. high. It is kept full of stock, and the combustion of the coke is supported by the air introduced at high pressure at the tuyeres. As smelting progresses, the coke burns, the slag and iron produced from the charge is withdrawn, and the surface or stock-line sinks. Thus the removal of molten products below and the addition of fresh stock above, cause the greatest production of heat next the tuyeres, where the coke largely burns, the temperature decreasing toward the stock-line. The actual melting zone, or zone of fusion, extends upward through the bosh region. The most intense combustion occurs within 4 ft. of the tuyeres, where an excess of air, driven in under high pressure, burns the coke to carbon dioxide. In the reaction, the  $\text{CO}_2$  may be said to dissolve the carbon, it being as follows:

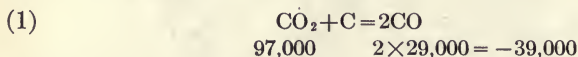

The reaction being endothermic, lessens the temperature in this second region. The temperature is so high, however, that the glowing coke reduces to iron any iron oxide that descends as far down in the furnace as this region. The rising gas consists of  $\text{COCO}_2$  and  $\text{N}$ . The carbon monoxide, in the ascent reduces the iron oxide to iron. On reaching the lower part of the furnace the iron, with carbon taken from the  $\text{CO}$ , forms pig iron. The iron takes up silica, phosphorus, and sulphur from the earthy constituents of the charge. The carbon amounts to 3 or 4 per cent, and the other impurities to 2 per cent the weight of the product. It is the 5 per cent of the metalloids present in the pig that makes it fusible.

We have, therefore, in the blast-furnace beginning from above, three zones:

(1) The **zone of preparation**, where  $\text{CO}_2$  is driven from the limestone and moisture from the charge.

(2) The **zone of reduction**, where the  $\text{CO}$  of the rising gas reduces the iron ore, first to the ferrous form, then to iron, and where the iron in a spongy or open form absorbs carbon from the reducing gas.

(3) The **zone of fusion**, where the temperature of the furnace is high and the slag is formed, the iron at the same time absorbing silicon, phosphorus, and sulphur.

In the upper zone of the furnace, the carbon dioxide of the limestone is expelled, leaving quicklime ( $\text{CaO}$ ) ready for fluxing the gangue or waste

matter of the charge. The action is endothermic, lessening the heat of the escaping gases. The quantity of limestone needed to form a suitable slag is calculated in advance.

The gas varies in composition, but commonly contains 61 per cent nitrogen, from 10 to 17 per cent  $\text{CO}_2$ , and 22 to 27 per cent  $\text{CO}$ . The carbon monoxide is the combustible constituent of gas that produces the heat when the gas is burned in the stoves and boilers.

In the foregoing description it has been assumed that coke is the fuel employed as is true in most cases. Anthracite coal has been used when cheap enough to compete with coke, but even then a more satisfactory result is obtained when coke forms part of the charge. Furnaces in which a part of the fuel is anthracite are called anthracite furnaces, but the name is somewhat misleading. Other furnaces use charcoal exclusively. Charcoal is supposed to give an iron of great toughness that is particularly valuable for cast-iron car-wheels and other castings requiring toughness. Its superiority over other kinds having the same constitution has been widely disputed, but there is testimony in favor of charcoal-iron.

Thirty years ago blast-furnace practice was regulated by rule-of-thumb methods. They were "born of a bigoted belief, on the part of ignorant furnace-men, that particular ores and fuel could be worked in a furnace only on special lines, and that it was impious to drive a furnace faster than a certain rate established by time-worn tradition." In 1879 certain experiments made at the Edgar Thompson Steel Works, Pittsburg, Pa., showed that it was possible to increase the output of a furnace enormously by increasing the air-supply. It was also found that the amount of air, not the pressure, determined the rapidity. Under the new system it was thought necessary to make a steep-angle bosh ( $80^\circ$ ) resembling that in Fig. 155 more than that in Fig. 154. With the more rapid driving, reduction decreased, and the slag contained more iron. To secure the reduction, the fuel had to be kept high, using one ton of coke per ton of pig iron produced, and where coke was expensive this was a serious matter. E. C. Potter at the Illinois Steel Works, South Chicago, showed that by reducing the bosh-angle to  $75^\circ$  and using somewhat less blast, it was possible to cut the coke consumption from 2240 lb. to 1800, or even 1750, per ton of pig produced. Furnaces with large hearths were then built, which also increased capacity.

**Blowing-in.**—The furnace is first dried several days by a wood fire in the crucible. The lower part, halfway up the bosh, is filled with cord-wood. Upon this is placed a heavy bed of coke with limestone to flux the coke-ash, followed by successive layers of the normal charge of coke, with gradually increasing amounts of ore and limestone, and decreasing quantities of slag, until the normal charge of ore and flux is reached. The wood is ignited at the tuyeres, and a weak blast of air supplied. The pressure is gradually

increased during twenty-four hours, and the furnace becoming entirely filled during this time the regular pressure is reached.

**Regular Operation.**—The old way of charging the furnace by hand is as follows: Ores, flux, and fuel (the "stock") is brought in buggies from the stock-house to the scales, weighed, hoisted to the top of the furnace, or tunnel-head, wheeled by top-fillers to the bells, and dumped evenly, the fuel separately, the ore and "stone" (limestone) together. The furnace is kept full to a level just below the outlet of the down-comer. In automatic charging, as indicated in Fig. 154, the stock is charged to the skips, as has been described, and is hoisted to the furnace-top and dumped into the double hopper. No top-fillers are needed, and the bells are often operated from the ground-level, so that no attendant is needed at the tunnel-head.

#### IRREGULARITIES IN BLAST-FURNACE OPERATION

In the upper part of the smelting zone semi-fused material may attach itself to the walls of the furnace, and this is the beginning of an accretion which forms a "scaffold." This scaffold or hanging may gradually build out until it arches over, holding up the charge and nearly stopping the furnace. Such a mishap is more liable to occur with fine ore such as that of the Mesabi range. Sometimes this scaffold may be broken down by suddenly cutting off the blast pressure, and allowing the full weight of the charge to come upon the obstruction. If this proves ineffective, then, by cutting a hole through the wall of the furnace, the obstruction may be melted out by the aid of a blow-pipe burning oil or gas.

Sometimes the scaffolding may give way in part, causing slips by which material is suddenly precipitated to the hearth, and there results an upward rush of gases resembling an explosion. This may do damage to the charging, interrupt operations and throw stock out of the top of the furnace. Some furnaces are provided with explosion-doors or valves which open under the sudden pressure and relieve the strain.

So much cold material, precipitated toward the hearth by a slip, tends also to cause a "freezing" or solidification of the slagged material near or over the tuyeres. The solid layer may sometimes be broken away by driving in a steel bar to enable the blast again to enter. This may result in the heating up at this point, and a final melting away of the obstruction. Sometimes it is necessary to melt through the frozen material by the aid of a blow-pipe, or, in extreme cases, to break through with the aid of explosives.

Or the molten iron near the metal notch may get so cold as to solidify so that it becomes impossible to enter. Then another tap-hole must be made by boring through into the crucible at a higher level. When the furnace is again regularly working the heat gradually descends until the



whole contents of the hearth are melted out, when the regular tap-hole can be again used.

Irregularities in the smelting change the character of the iron made. Thus cold material coming down to the hearth will chill the smelting zone, and cause the silica to be low and the sulphur high, that is, will make white iron when gray or soft iron is desired.

#### DISPOSAL OF SLAG OR CINDER

On account of its low specific gravity, slag floats upon the iron. The iron occupies the lower part of the crucible, and accumulates until it reaches

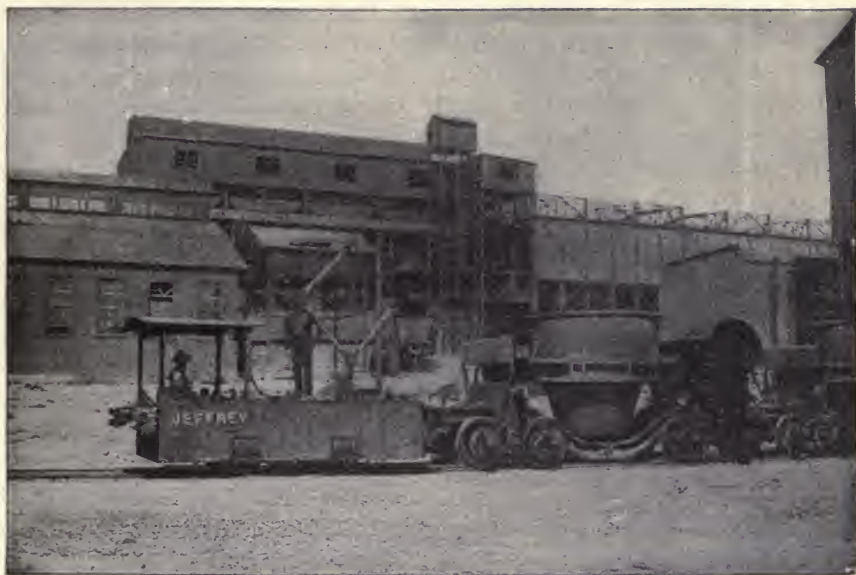

FIG. 161.—Slag Ladle and Locomotive.

the tuyeres, when it should be drawn off. Every  $1\frac{1}{2}$  to two hours, the plugged cinder-notch is pierced with a pointed steel rod, and the cinder above the level allowed to flow out. It flows along a cast-iron launder a distance of 15 to 30 ft. and falls into a 14-ton slag-car standing on a track below. When loaded the car is hauled by a locomotive to the dump that may be a mile away, and the contents of the ladle is poured out at the side of the track. The track is gradually raised and moved outward toward the edge of the dump as it grows.

A large coke furnace, yielding 500 tons of pig daily, when smelting ores of good grade, produces 300 tons of cinder. In smelting silicious ores, the quantity of slag may be twice as great.

## DISPOSAL OF PIG IRON

Every four to six hours the metal is tapped from the furnace, 50 tons at a time. The flow is started by a pointed steel bar which is driven through the clay-plugged iron-notch or tap-hole. A clay-lined launder conducts the flow to ladles similar to the cinder car. Distant from the furnace 10 to 15 ft. is a cross-channel made in the sand. The slag that floats on the stream of iron is diverted into the cross-channel with a skimmer. An iron plate is placed across the flowing stream in such a way as to permit the heavy iron to flow beneath, while the light slag is diverted. A charcoal furnace, having an output of 100 tons per day, produces so little cinder that none is tapped at the cinder-notch, but flowing out with the metal it is skimmed as above described. It is run outside the cast-house upon the ground, is allowed to cool, and is then broken up and carted away. The iron contained in the ladles is called "direct metal" and may be taken to the steel works and used in molten form.

In practice elsewhere, the iron is cast in molds in the sand of the floor



FIG. 162.—Heyl & Patterson Pig-casting Machine.

of the cast-house. The floor, 40 ft. wide and 80 to 150 ft. long, consists of the sand in which the depressions are molded and connected by a main channel or runner, which receives the molten iron flowing from the furnace. The molds fill successively and form pigs of iron weighing 150 lb. each.

To reduce the cost of handling the pig metal, and to give a product smooth and free from adhering sand, casting machines have been introduced in modern plants. Fig. 162 is a Heyl & Patterson pig-casting machine, consisting of an endless-chain conveyor composed of a series of molds, each capable of holding 120 lb. iron. The iron, brought from the furnace in a large ladle shown at *d*, Fig. 162, is poured into the molds as they travel slowly along. The pig-iron chills quickly, and by the time it reaches the discharge end, it consists of solid pigs of iron and drops into the railroad car that is placed in position to receive it. The molds on their return, inverted, take at *c* a spray of whitewash, the water of which quickly dries by the heat of the mold. It leaves a coating of lime inside that prevents the iron from adhering. Mechanical casting has the advantage over casting in sand-molds that it does away with the hot and severe work of

breaking and handling the pigs. In hot weather the work can hardly be borne, and there always is difficulty in getting or keeping the men.

**Blowing-down.**—When a furnace is to be put out of blast, charging is stopped, and a layer of coke is added for the last charge. With continued blast the stock-line descends and the operation progresses as long as iron and cinder can be tapped out, the blast being gradually diminished. Finally the blast is stopped, and the remainder of the contents is withdrawn through a hole broken in the brickwork near the bottom.

DRY-AIR BLAST

This aims to regulate the one big variable in the operation of the blast-furnace. All the other materials, the ore, stone, and coke vary at the most but a few per cent in their composition from time to time, while the moisture in the air may vary more than 100 per cent from day to day, and of this air the production of a ton of iron requires almost double the weight of the other raw materials.

The moisture in the atmosphere is removed by refrigeration previous to the introduction of air into the stoves. Any moisture, on entering the furnace at the temperature at the tuyeres, is at once dissociated by the intense heat into the component gases according to the reaction.

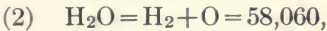

or per pound of hydrogen 29,030 pound-calories per pound.

The amount of air necessary to burn the fuel for smelting 100 lb. of pig varies with the temperature of the blast, but a fair average may be taken at 5300 cu. ft. With the amount of moisture contained under average conditions, as pre-

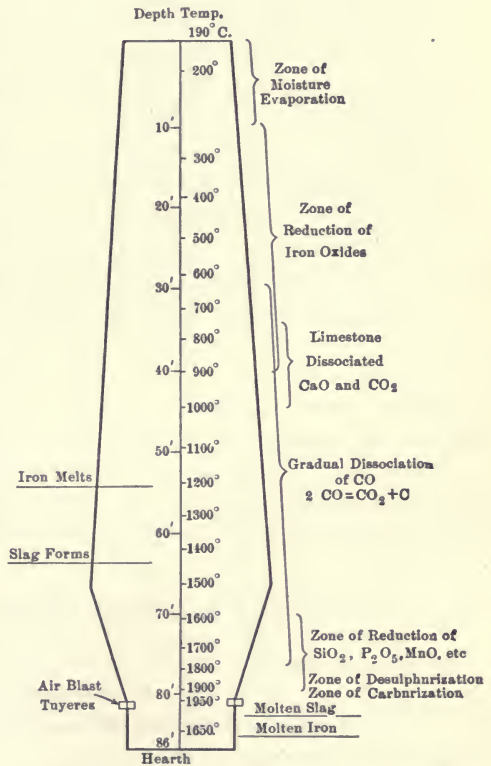

FIG. 163.—Section of Blast-furnace Showing Temperatures.

viously assumed for Pennsylvania (3.44 grains) the total moisture will then be:

$$\frac{5300 \times 3.44}{7000 \text{ (grains per lb.)}} = 2.6 \text{ lb.}$$

1545 calories  $\times$  2.6 = 4020 calories.

The above figure represents the heat lost per hundred pounds of iron smelted, due to the moisture in the atmosphere or, expressed in coke consumption, somewhat over 50 lb. of coke per ton of pig made.

The Gayley process, as installed at several plants, has removed by cooling to 25° or 30° F. approximately 65 to 70 lb. of water per ton of pig smelted during some of the more humid months of the year, a theoretical saving in the consumption of coke of some 55 lb. per ton of iron, but the actual saving has proven far greater.

It will be seen that the actual saving far exceeds any that can be theoretically accounted for, either by the elimination of moisture or by the rise of temperature in the blast.

There has been much discussion regarding it, but probably the greatest saving is in reality attributable to the securing of uniformly favorable operating conditions. Regularity is a prime essential for economical running and with these conditions uniformly good there is no need for the excess fuel necessary to provide for contingencies.

It would not, however, be the part of wisdom to assume that such enormous saving could be made at all plants and under all conditions, but it is probably safe to say that the average plant can decrease its coke consumption at least 12 per cent and increase the production 10 per cent, while in very many cases it is perfectly feasible to raise these percentages to 14 per cent and 12 per cent respectively. This, of course, refers to what may be relied upon the year through and not merely for short periods under the stress of record breaking output.

#### CHEMICAL REACTIONS OF THE BLAST-FURNACE

A blast-furnace may be likened to an immense gas-producer in which there is a column, 70 ft. high, of alternate layers of coke, iron ore, and flux. The column ranges in temperature from a heat that shows no color at the throat, to a white heat at the tuyeres.

The hot air of the blast, entering at the tuyeres, strikes the white-hot coke with the immediate formation of CO<sub>2</sub> followed by an instantaneous reduction to CO. The air therefore need only burn the fuel to CO as indicated by the following reaction:

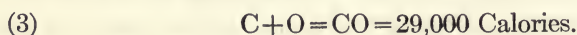

Per pound of carbon burned 2415 pound-calories are generated. Since 23 per cent of air is oxygen, and at the sea-level 1 lb. of air equals 12.38 cu. ft., we have  $\frac{16}{12} \times \frac{12.30}{0.23} = 72$  cu. ft. of air per pound of carbon, or 61 cu. ft. per pound of coke of 85 per cent carbon.

Fig. 164 shows graphically the chemical reactions under a set of conditions assumed, while the temperature and places where the reactions take place are shown in the section of the furnace at the extreme left in the diagram. To produce a ton of pig iron (2240 lb.) there is to be used 3520 lb.

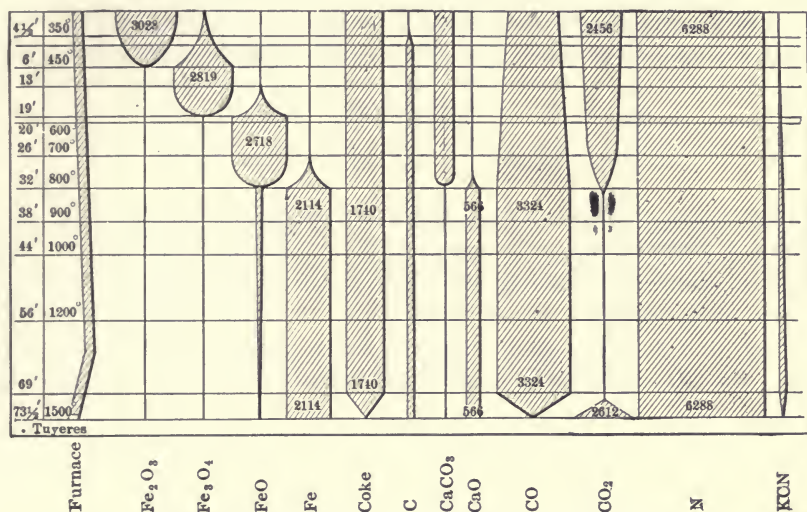
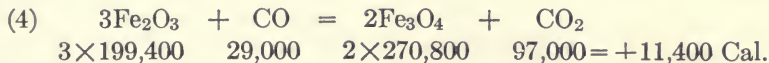

FIG. 164.—Chemical Reactions of the Blast-Furnace.

of 60 per cent iron ore containing 3020 lb.  $\text{Fe}_2\text{O}_3$ , 1888 lb. coke, and 1010 lb. limestone.

At the tunnel-head, the iron ore ( $\text{Fe}_2\text{O}_3$ ) plunges into an atmosphere of 24 per cent  $\text{CO}$ , 16 per cent  $\text{CO}_2$ , and 60 per cent of  $\text{N}$  at a temperature of  $260^\circ \text{C}$ . Reduction of ferric oxide to  $\text{Fe}_3\text{O}_4$  by the  $\text{CO}$  begins thus:



The reaction is completed at a temperature of  $450^\circ \text{C}$ . when the ore has reached a depth of 10 ft., shown at 2 of the diagram. During this period the peculiar reaction resulting in carbon-deposition begins, caused by the reaction of the gas on the ore, forming a deposit of soot or carbon in the pores.

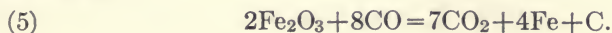

Continuing the descent the ore undergoes further reduction. At a depth of 19 ft. and a temperature of  $600^{\circ}\text{C}$ ., the  $\text{Fe}_3\text{O}_4$  formed, as shown above, has become further reduced to  $\text{FeO}$ , as indicated in column 4, the reaction being as follows:

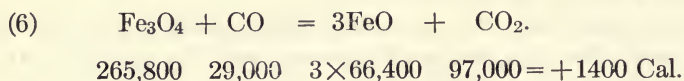

The  $\text{FeO}$  thus formed, impregnated with carbon (see column 7) descends with little change, until at a depth of 26 ft. and at a temperature of  $700^{\circ}\text{C}$ ., the  $\text{CO}$  of the gas reacts upon it, and spongy iron begins to form. The reaction is complete at  $800^{\circ}\text{C}$ ., and at a depth of 32 ft., and is as follows:

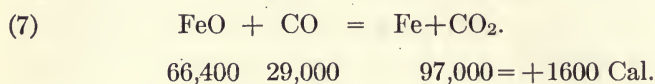

In the passage downward the limestone gradually loses its  $\text{CO}_2$ , and at this point the expulsion is complete, as indicated at column 8. The quicklime, column 9, thus formed, unites at the zone of fusion and fluxes the silica of the charge. From the depth of 19 ft. to the depth at which all carbon dioxide is expelled, that is between the temperatures  $550^{\circ}$  and  $880^{\circ}\text{C}$ ., the  $\text{CO}_2$  reacts upon coke, dissolving it according to the following reaction:

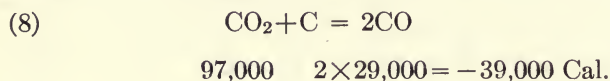

Thus heat is absorbed from the gas, and some coke is consumed. The coke, however, as can be seen from column 6, remains but little changed until it reaches the region of the tuyeres.

Below the 32-ft. level at  $800^{\circ}\text{C}$ ., reactions practically cease, the chief action now being a reduction of a small amount of  $\text{FeO}$ , left undecomposed by the  $\text{CO}$ . This is gradually reduced (see column 4) by the glowing coke as follows:

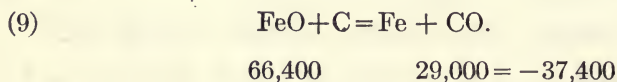

Silicon having less affinity for oxygen than carbon at a high temperature is formed from the reduction of the silica, and as a metalloid enters the pig iron after the following reaction:

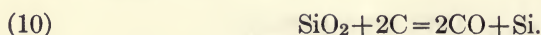

Below the 32-ft. level, the temperature rises gradually and uniformly until the intense combustion at the tuyeres produce  $1500^{\circ}$  C. as a maximum.

Of the air entering the furnace, 77 per cent is nitrogen, and of the escaping gas 60 per cent, thus showing nitrogen to be by far the largest constituent present. As is shown in column 12, nearly three tons of nitrogen pass through the furnace for each ton of pig iron produced. At the high temperature of the lower part of the furnace, potassium cyanide is formed, the potash of the coke-ash uniting with carbon and nitrogen to form the salt. It decomposes before the top of the charge is reached.

Referring to columns 10 and 11, we note that the  $\text{CO}_2$  formed so freely at the tuyeres, is at once (column 10) changed to CO. The carbon monoxide rises unchanged until it reaches the 32-ft. level, when it begins to act on the iron oxides with the formation of  $\text{CO}_2$ . The carbon dioxide from this source united with that from the limestone is the total of the escaping  $\text{CO}_2$  gas.

Sulphur occurring as FeS in the coke and as pyrite in the ore, is speedily driven off by the heat of the furnace, giving FeS. The sulphur of the FeS is taken up by quicklime, and enters the slag as calcium sulphide according to the following reaction:

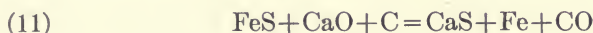

Thus it is separated from the iron, upon which it would have an injurious effect.

#### THE HEAT BALANCE OF THE BLAST-FURNACE

The heat yielded by the fuel and blast on the one hand, and that absorbed in the various reactions, taken by the blast, and lost by radiation, may be stated for a particular case as follows:

To produce a ton (2240 lb.) of pig iron of the composition, carbon 42 per cent, silicon 1.35 per cent, manganese 0.64 per cent and iron 93.6 per cent, there was needed 4093 lb. of ore, 795 lb. of limestone, and 1682 lb. of coke, and besides the 2240 lb. of pig iron, there was yielded 1010 lb. of slag and 89 lb. of flue-dust. There was blown into the furnace 6673 lb. of air (say 80,000 cu. ft.) and there came away 9309 lb. of top-gas of the composition by weight  $\text{CO}_2$ , 22.3 per cent; CO, 22.4 per cent;  $\text{H}_2\text{OCH}_4$ , 0.1 per cent and nitrogen 54.9 per cent. The coke contained 89 per cent of fixed carbon and 9.4 per cent ash, while the composition of the ore (including a little scrap returned) was 51.2 per cent iron and 0.74 per cent manganese. The specific heat of air-blast was 0.248, the air carrying 5.5 grains of moisture per cubic foot, and the average blast temperature was  $672^{\circ}$  C. The heat balance sheet for 1 ton of pig iron is:

<i>Generated by</i>	
	Cal.
Combustion of carbon to CO.....	2,220,000
Combustion of carbon to CO <sub>2</sub> .....	3,752,000
Heat content of blast air.....	1,147,000
Heat content of moisture in air.....	20,000
	7,142,000
 <i>Consumed by</i>	
	Cal.
Reduction of Fe <sub>2</sub> O <sub>3</sub> .....	3,407,000
Reduction of Fe <sub>3</sub> O <sub>4</sub> .....	272,000
	3,679,000
Reduction of MnO.....	27,000
Reduction of SiO <sub>2</sub> .....	232,000
	3,938,000 Cal. or 55.3%
Calcination of carbonates.....	400,000 Cal. or 5.5%
Dissociation of moisture in the blast.....	220,000 Cal. or 3.1%
Carried off with the iron.....	635,000 Cal. or 8.9%
Carried off with the slag.....	550,000 Cal. or 7.1%
Carried off with the dry top-gas.....	417,000 Cal. or 5.9%
Carried off with the moisture in the top-gas.....	388,000 Cal. or 5.4%
Radiation, cooling-water and unaccounted for.....	631,000 Cal. or 8.8%
	7,179,000 Cal. or 100.0%

It should also be noted that the heat carried off by 1 lb. of iron is 261 calories, and that by 1 lb. of slag 483 calories. By a careful study of the above figures one may arrive at a just estimate of the value of the various furnace operations, and so can compare them with the performance of other furnaces.

#### BURDENING THE BLAST FURNACE

This involves the calculation of the proper proportion of ore and flux needed for the production in the furnace of a slag of suitable composition. In order to accomplish this we must have an analysis of the materials of the charge and of the fuel. The furnace must work freely and regularly, and must produce the kind of iron desired as more particularly shown on page 315. This is accomplished by so burdening the furnace as to produce a slag of the proper composition, and by properly regulating the quantity of fuel and the temperature of the blast.

**The Slag.**—This results from the melting together of the non-volatile solid constituents of the charge, that is, the silica and bases of the ore and fluxes, since slags are essentially silicates of these bases.

Below we give the composition of typical slags that have proved altogether satisfactory in practice.



	SLAG.					IRON.	
	SiO <sub>2</sub>	Al <sub>2</sub> O <sub>3</sub>	CaO	MgO	CaO and MgO	Si	S

## Averages for Hot Furnaces.

Cuban ore.....	33.2	13.7	40.7	11.1	51.8	3.8	tr.
Spanish ore.....	34.8	11.7	41.3	9.8	51.1	2.5	0.02
Spanish ore.....	31.8	12.0	45.6	9.0	54.6	1.3	0.02
Lake ore.....	35.5	12.0	40.5	8.9	49.4	1.8	0.03

## Averages for Cool Furnaces

Cuban ore.....	32.2	10.3	45.6	9.8	55.4	0.9	0.07
Spanish ore.....	30.7	11.3	47.4	8.4	55.8	0.4	0.03
Lake ore.....	34.7	11.3	40.1	10.9	51.0	0.8	0.06
Lake ore.....	35.0	11.4	39.1	11.3	50.4	0.6	0.10

In these slags the ratio of SiO<sub>2</sub> to CaO + MgO will average as 33 to 53 or as 1 to 1.6. Alumina is not regarded as an acid or a base, but as a neutral constituent dissolving in the slag. As seen in the table a hot-running furnace reduces more silicon to enter the pig, producing gray or soft or foundry pig; when run cool more like the gray forge, the mottled or white iron; also the retained sulphur in the pig is higher.

The weight of the fuel of charge for a good-sized furnace should be such as will fill a skip of 5 long tons capacity, the iron ore and "stone" (limestone) being separately hoisted and put in to the furnace. These two skip loads are called a "round." About a ton of coke is needed to produce a ton of pig, though for a cool furnace as little as 1600 to 1800 lb. of coke has been used. Two tons of iron ore of 50 per cent Fe should yield one ton of pig. We may decide, that, as experience suggests, we need one-fourth of its weight of limestone. On this basis we will prepare the charge sheet as shown on page 312.

The amount of the items are written in, with their percentage composition. The corresponding weights of the elements are calculated through and their totals obtained. The 11,800 lb. of iron is to have 1.5 per cent its weight of silicon, or 175 lb. Now 1.5 per cent Si corresponds to  $\frac{3}{8}$  of silica, or 374 lb., and this subtracted from the total, leaves 1589 lb. silica for the slag. This multiplied by 1.6, as already explained, gives us 2534 lb. Subtracted from the total it shows an excess of 672 lb., or of limestone twice that, say 1300 lb., so only 4200 lb. is needed. Erase where needed, put in the new figure of 4200 lb., recalculate and obtain new results, which should be nearly correct. If not, a second correction can be carried out.

## CHARGE SHEET

%	Weight.	SiO <sub>2</sub> .		Fe.		CaO-MgO.		P.	
		Per Cent.	Pounds.	Per Cent.	Pounds.	Per Cent.	Pounds.	Per Cent.	Pounds.
Gogebic iron ore....	22,000	6.3	1,286	53.5	11,770	0.6	132	0.01	2.2
Limestone.....	5,500	1.5	83	....	....	52.7	2,898	0.04	2.2
Coke.....	11,000	5.4	594	....	....	1.6	176		
Pig.....			1,963	....	11,770	....	3,206	....	4.4
Fe 94.5.....	For pig =		374	....	....	....	2,534	=needed	
Si 1.5.....	For slag =		1,589	....	....	....	672	=excess	
C 3.5.....									
99.5%									

Where manganese exists in the ore, about one-third of it enters the slag as MnO, making it more fluid. The rest accompanies the pig iron. A little iron may, as FeO, enter the slag, but this loss to the pig iron is more than made up by the additions of carbon and silicon that it receives.

## GENERAL ARRANGEMENT OF THE BLAST-FURNACE PLANT

Fig. 165 shows the general arrangement of a two-furnace plant. All parts of the plant are reached by railroad tracks on short easy curves. The ore is brought in by ore-cargo steamers and stored for the winter period in an extensive ore storage yard. From the yard it is reclaimed by a traveling crane and stored in ore pockets adjoining the furnaces and next to the coke pockets. The coke is brought in by an overhead track and unloaded to the pockets. The blast-furnaces, marked respectively A and B, have each their cast-house where the iron can be cast in sand-beds. At the end of the building is the pig-breaker where the pig is broken in order to determine by fracture its grade. Between the furnaces are seen the stoves, four for each furnace. The large building, between the cast houses, A and B, may be called the power house, and contains the engines, with their blowers and the boilers heated by furnace-gas, also the machine shop. To the right of the yard is the building for the pig-casting machine. The molten pig iron from the furnaces is brought by ladle car to the "ladle house" adjoining the pig-casting house and there poured into the molds of the machine. Alongside each cast-house is the hot cinder track where the cinder-car is run in to receive the molten slag as it is tapped from the furnace, and thence taken to some distant dump.

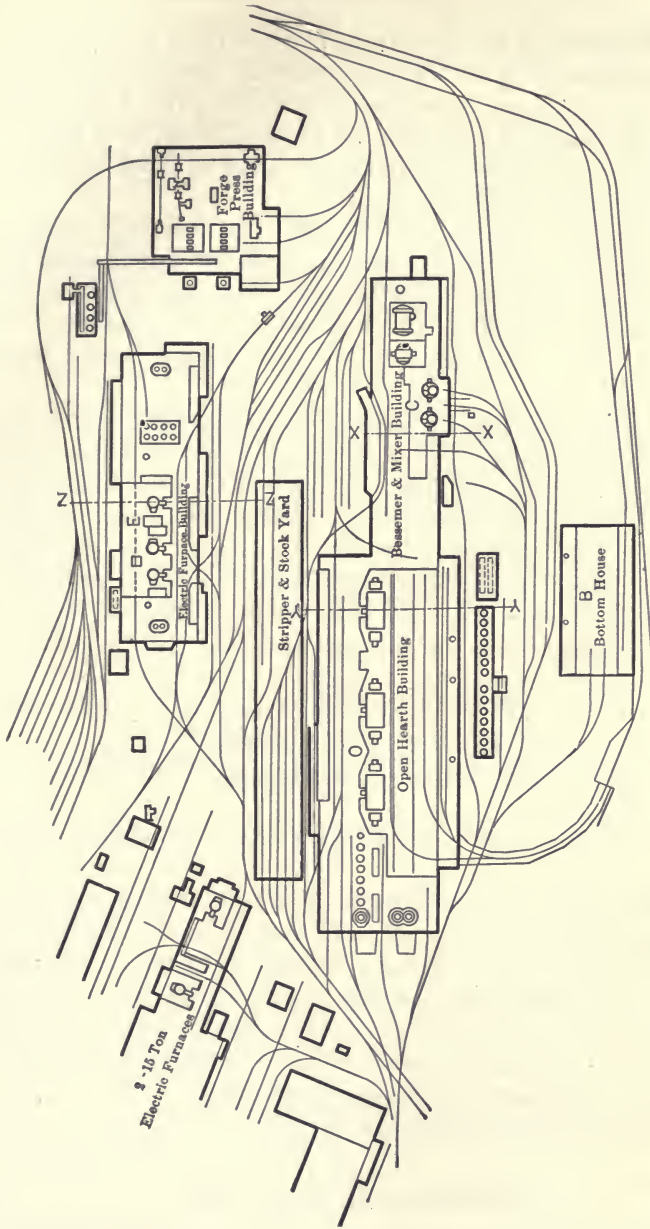

FIG. 165.—General Plan of Blast-furnace Plant.

## PIG IRON

The iron produced in the blast-furnace is not pure, but contains  $3\frac{1}{2}$  to 4 per cent carbon and  $1\frac{1}{2}$  to 3 per cent silicon. Some of the carbon is combined chemically, some separated as graphite. If a large proportion is combined, the metal is hard and the fracture of the iron looks white. If a large proportion is free, the fracture is gray or black with scales of graphite, and the iron is soft and tough.

Under "Chemical Reactions of the Iron Blast-furnace," Equation (3) indicates the formation of carbon, and Equation (8) the reduction of silica to silicon, both elements entering the pig iron. A small amount of sulphur, seldom less than 0.2 and often 0.25 per cent or more, is present. As the amount increases above 0.1 per cent the iron becomes harder and more brittle.

The percentage of silicon and sulphur in the iron depends in large measure upon furnace-conditions; hence it can be controlled; but all the phosphorus present enters the pig iron. In pig iron for steel manufacture by the usual, or acid Bessemer process, the phosphorus in the pig must not exceed 0.10 per cent. Therefore, in the ore, it must not be higher than 0.05 or 0.06 per cent. In the acid Bessemer process the phosphorus is not eliminated, and it tends to make steel red-short (brittle when hot) a quality that interferes with the subsequent rolling. Phosphorus, on the other hand, imparts the quality of fluidity to cast-iron. Iron that contains 3 per cent P is in demand where intricate castings are to be made, and can be used where brittleness is of minor importance.

Cast iron as compared with steel and wrought iron has the following characteristics:

(1) It is brittle because of the presence of the metalloids, carbon and silicon.

(2) Because of the presence of the metalloids it is fusible; and it derives thus the most valuable property. It runs freely from the blast-furnace and can be cast in intricate molds to form castings of any kind. Wrought iron at the same temperature would be pasty and would not run. Steel, which is intermediate between wrought iron and cast iron in the contained carbon, can be made into castings, however, but not readily like cast iron. The making of steel castings is becoming more common.

(3) It cannot be forged either hot or cold.

## CLASSIFICATION OF PIG IRON

Pig iron for further treatment or use may be thus distinguished:

**Mill Iron.**—For puddling, a pig low in silicon is needed, but otherwise of a different quality.

**Bessemer Pig.**—By this is meant an iron containing less than 0.10 per cent phosphorus and less than 0.05 per cent sulphur.

**Basic Iron.**—This should be low in silicon, that has been cast in an endless-chain casting-machine, thus being free from sand. Silica attacks the lining of a basic-lined open-hearth.

**Malleable-iron Pig.**—Used in making malleable iron castings. It is non-Bessemer, low in silicon and graphitic carbon.

**Charcoal Iron.**—This is made in charcoal furnaces, and is used for special purposes in the foundry—as, for example, in making car wheels.

**Foundry Pig.**—Is used for making castings for all purposes. The iron should readily fill the mold and not shrink much when cast. Otherwise a grade of iron is used to suit the purposes to which the casting is to be put.

**Grading Pig-iron by Fracture.**—The pigs are broken in two, either over a wedge-shaped block or in a machine, and the fracture is observed. Foundry No. 1 is dark gray in color, the grain large and even; foundry No. 2 has a small uneven grain and is lighter in color; foundry No. 3 is close-grained and light in color but has less than 3 per cent silicon, in fact a white iron.

**Grading by Analysis.**—This is a more reliable method than by fracture. The character of the grades of Alabama pig iron is indicated by the table below:

ALABAMA PIG IRON

Name of Iron.	Graphite Carbon.	Combined Carbon.	Silicon.
Silver gray.....	3.13	0.02	5.5
No. 1 soft.....	3.48	0.03	3.5
No. 2 soft.....	5.53	0.03	3.5 to 4.0
No. 1 foundry.....	3.49	0.07	2.8 to 3.5
No. 2 foundry.....	3.55	0.07	2.2 to 2.6
No. 3 foundry.....	3.48	0.10	2.0 to 2.4
Gray forge.....	3.00	0.57	1.3 to 1.7
Mottled.....	2.11	1.22	1.1 to 1.6
White.....	0.10	2.92	0.7 to 1.2

This table shows the increase of combined carbon, and the decrease of silicon, as the grade approaches white iron.

The first grades are more difficult to make, and command a higher price.

**Pittsburg Pig Iron.**—For the Pittsburg district we give a similar table but with the silicon, on the whole, lower and disregarding the carbon.

Name of Iron.	Silicon.	Sulphur.	Phosphorus.	Manganese.
Gray forge.....	0.75 and over	Over 0.05	0.40 to 0.60	0.50 to 0.80
Basic (chill cast)....	Less than 1.00	0.05 and less		
Strong foundry and car-wheel.....	0.75 to 1.50	0.05 and less	0.03 and less	
Bessemer.....	1.00 to 2.00	0.05 and less	0.10 and less	
Low phosphorus.....	1.00 to 2.00	0.035 and less	0.035 and less	
No. 2 foundry.....	1.75 to 2.25	0.05 and less	over 1.00	0.35 to 0.70

#### INFLUENCE OF ITS CONTAINED ELEMENTS ON THE CHARACTER OF THE PIG-IRON

**Carbon.**—This occurs graphitic and combined, in ordinary pig up to 4.5 per cent, and in high manganese and chrome iron to as much as 7 per cent. . When molten the carbon is regarded as being combined, but in cooling more or less separates as graphitic carbon. When much of the latter separates the fracture is darker in color and softer than where the carbon remains combined; it is well suited to machining, though not so strong as when the carbon is combined. In smelting, to obtain a pig that will be high in graphite, the temperature of the blast and the proportion of fuel should be high, so as to secure a good reduction, and that much carbon shall be taken up from the fuel. This also ensures reduction of much silicon to enter the pig, and cooling compels carbon to take the graphitic form.

**Silicon.**—This is reduced from the silica of the charge at the hearth of the blast-furnace. It then dissolves in the forming iron. For a high-silicon iron a high temperature is here needed and this is accomplished by a light burden and a good hot blast. Iron, containing as much as 20 per cent silicon has been made in the blast-furnace, and when the pig contains more than 6 per cent it is called ferro-silicon, a product much used in steel making.

**Phosphorus.**—All of this element present in the ore is readily reduced in the blast-furnace to a phosphide which combines with the iron. It makes the iron more fluid so that it better fills the mold but the casting is more brittle.

**Manganese.**—This is reduced like the iron. It aids the pig in holding the carbon in combined form. Manganese increases the strength and fluidity of the pig, and makes it harder and less fusible. Likewise it tends to remove oxygen and sulphur from the iron, and to counteract the detrimental effect of other impurities. To make ferro-manganese alloys, much used in steel-making, a separate blast-furnace is operated, using a very hot blast and a light burden (a high fuel), since manganese is difficult to reduce. An alloy containing 10 to 25 per cent manganese is called spiegeleisen

(mirror-iron) because of its shining crystalline appearance; and when containing 25 to 95 per cent manganese it is known as ferro-manganese.

**Sulphur.**—This detrimental element occurs dissolved in the pig metal as  $\text{FeS}$ . It makes it hard and brittle and tends to keep the carbon in combined form. A high percentage of sulphur makes porous castings, but the iron is more fluid when cast. In the blast-furnace, using a high lime slag, this tends to take it away from the iron.

## CHAPTER XXVI

### WROUGHT IRON AND STEEL

Cast iron, because of the large proportion of contained metalloids, which indeed makes it fusible, and easily cast, is too weak and brittle for many structural purposes.

Therefore three-fourths or more of the pig iron in the United States, together with much steel scrap, is made into steel because of its superiority as an engineering material. About 3 per cent of our pig iron is made into wrought iron, a product superior to steel for certain purposes, because of its welding quality and ductibility as compared with ordinary Bessemer or open-hearth steel. For most engineering purposes steel is, however, superior to wrought iron and as cheap.

#### THE MANUFACTURE OF WROUGHT IRON BY THE PUDDLING PROCESS

Almost all wrought iron manufactured in the United States, about  $1\frac{1}{2}$  million tons per annum, is made from pig iron by the puddling process, invented in England by Henry Cort about 1780, and greatly improved by Joseph Hall, fifty years later. The grade of pig used is either gray forge or white—see page 315. Sulphur should not exceed 0.10 per cent and phosphorus should preferably be less than 1.0 per cent. Pig containing as much as S, 0.35 per cent and P, 2.5 to 3.0 per cent is sometimes used, since a high phosphorus in the resultant wrought iron is not so objectionable as it would be in steel. The slag, mechanically mingled with wrought iron, hinders it from becoming brittle under shock, the difficulty produced by phosphorus in steel.

**The Furnace.**—Fig. 166 is a longitudinal section of a puddling furnace of about 1500 lb. per charge capacity. It is a reverberatory furnace having a hearth of 7 ft. by 7 ft. in size, the grate being 2 ft. 10 by 4 ft. by 9 in. size, and relatively large for so small a hearth, in order to obtain a high furnace temperature. The hearth lining of mill cinder and iron ore suffers wear and is repaired between the heats.

**Puddling.**—The pig is charged by hand into the furnace, and is rapidly melted down in thirty to thirty-five minutes. Iron ore or mill scale ( $\text{Fe}_3\text{O}_4$ ) is now added, this taking seven to ten minutes, and the charge is thoroughly mixed and cooled to a point where the slag will begin to oxidize



impurities, especially phosphorus and sulphur. As this takes place, a light flame begins to break through the slag-covering, due to the carbon of the pig iron reacting on the oxides of the bath thus,

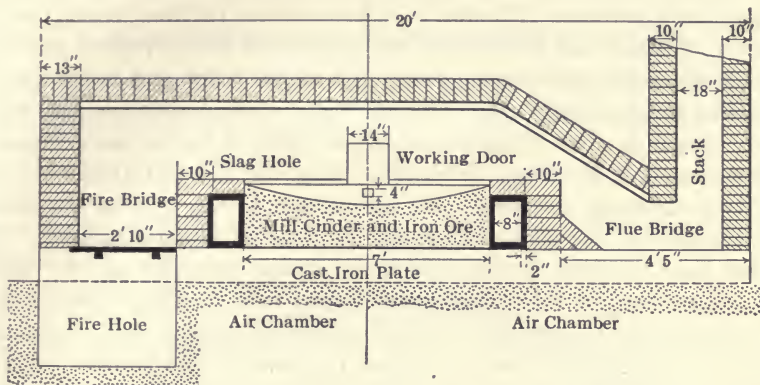

FIG. 166.—Longitudinal Section of a Puddling Furnace.

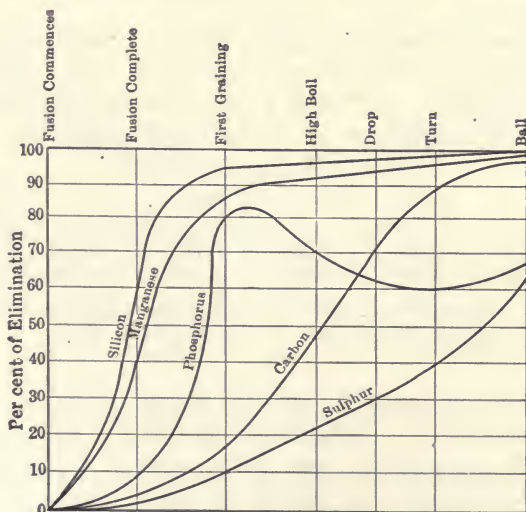

FIG. 167.—Sequence of the Reactions of the Puddling Process.

The CO coming in contact with the air burns to CO<sub>2</sub> with its characteristic blue flame. As the carbon monoxide increases in volume, the charge becomes agitated and the "boil" is in progress. The charge swells and the slag pours out at the slit beneath the working door. This slag may amount to 12 to 25 per cent of the charge. The boil continues for

twenty to twenty-five minutes and during the time the puddler stirs the charge with his long-handled rabble. Toward the end of the boil the metal begins to "come to nature," and pasty masses to form in the bath, and to show above the slag. Those masses are stirred and gathered by the rabble until all the metal becomes pasty, when the "balling" period begins. The metal at this time is gathered into three or four portions, each of which are rolled up into a ball made up of many particles partly welded together. The balls are rolled up near the bridge out of the flame and in the hottest place, until the puddler is ready to draw them. They are removed one by one for squeezing, after which the hearth is repaired for the next charge.

**Squeezing and Working.**—The balls, weighing 125 to 180 lb. each, are withdrawn, dripping with slag, and are carried to the jaws of a squeezer by which most of the slag is squeezed out and then made smaller. The squeezed balls are sent to the rolls to be rolled into bars called "Muck bar." These are cut into lengths and wired into bundles, half the bars piled crossways of the others. These bundles are reheated in a reheating furnace to welding heat and rolled again into bars. The rerolled material is known as "merchant bar," and the effect of the second rolling is to eject more slag and to form a cross-fiber structure as the result of the cross piling.

When rolled into strips this is called "skelp." Skelp bent into shape of tubes and butt-welded or lap-welded makes iron pipe. Steel billets are similarly rolled, forming "steel skelp" and made into steel pipe.

Following is the composition of various puddled products:

	C.	Si.	S.	P.	Mn.
Muck bar.....	0.10	0.108	0.052	0.193	Not over 0.10
Skelp.....	0.05	0.040	0.050	0.10	Not over 0.10
Puddled bar.....	0.30	0.120	0.134	0.139	
Wrought iron.....	0.10	.....	.....	0.12	

Usually there is more than 1.0 per cent of slag in wrought iron and less than 0.2 per cent in steel. Ordinary wrought iron is practically free from manganese, while open-hearth steel will contain 0.5 per cent or more, hence the greater liability to rusting of steel. Most of the wrought iron made in the United States goes at once into commerce; a little is consumed for "crucible steel" (tool steel).

#### STEEL-MAKING

In the year 1918, of the 39,000,000 tons made in the United States, 47 per cent was for basic steel and 33 per cent was Bessemerized. This is due largely to the fact that a pure pig iron (Bessemer pig) is needed for

this process, while the basic open-hearth can handle the pig from impure ores high in phosphorus, which are more plentiful. Also basic open-hearth steel has become of as good quality as Bessemer steel. The duplex process, later described, combines the speedy steel-making by the converter with the efficiency of the open hearth in purifying.

**STEEL-MAKING BY THE ACID BESSEMER PROCESS**

The pig iron used in the Bessemer process preferably contains 1 per cent silicon and 0.5 per cent manganese, but to make a salable steel, the

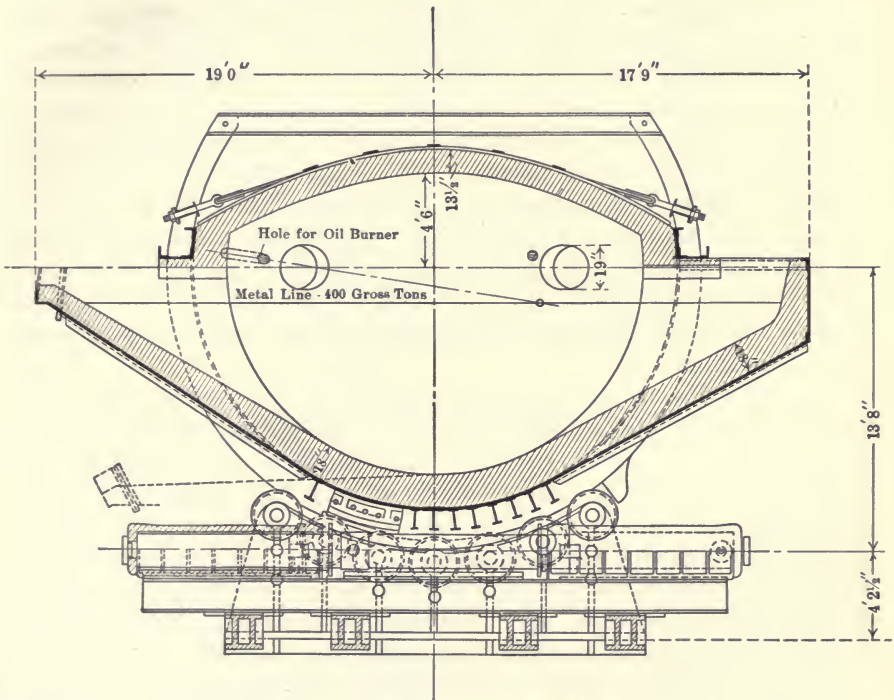

FIG. 168.—400-ton Hot-metal Mixer.

phosphorus should be below 0.10 per cent and the sulphur below 0.08 per cent, since neither element is removed in the converter. If the silicon is above 1 per cent the large quantity of slag produced carries away iron. If far below 1 per cent, the charge does not blow hot. When manganese is high (1.5 per cent), it makes the charge sloppy, the slag then being highly fluid and easily ejected during the blow.

The converters in a large plant are supplied from several blast-furnaces, and to insure a good average pig metal, it is customary to collect the product of the several furnaces in a single tilting reverberatory furnace, or hot

metal mixer capable of holding 300 to 1300 tons of pig metal. From the mixer it is drawn to the converters as needed, and a regular supply is thus assured.

**The Hot-metal Mixer.**—Fig. 168 is a section of a 400-ton mixer. Like the tilting open-hearth, this is carried on rollers so that its contents can be poured into a casting ladle to go to the converters.

It is driven by two 75 H.P. electric motors which act in series during pouring, but in parallel during the return of the mixer to its normal position. It is lined with  $13\frac{1}{2}$  in. of firebrick face, in order to cut down radiation, with 9 in. of magnesite firebrick.

**The Converter.**—The conversion is done in an upright converter, lined with silicious material held together with fireclay. Fig. 104 represents views of a converter. It is 9 ft. diameter by 15 ft. 6 in. high and is capable of treating a charge of 20 tons of pig-metal. It is swung on trunnions, through one of which the compressed air needed in operation enters to the tuyeres at the bottom. The slag made in a converter is high in silica, and has but little effect on the lining, so that this lasts several months. The mouths of the tuyeres at the bottom come in contact with the iron oxide formed during the blow, and hence this part of the converter lasts only twenty to twenty-five hours. This bottom accordingly is made so that it can be replaced by another, causing a delay of twenty minutes in changing.

**Converter Lining.**—For the acid process the converter is lined to the thickness of 26 to 30 in. with ganister, that is, quartz rock mixed with some clay to bind it. In a 20-ton converter, Fig. 169, there are fourteen tuyeres of well-burned clay, 6 in. diameter by 30 in. long, each tuyere having eight  $\frac{9}{16}$ -in. holes extending from top to bottom for the blast-air. The tuyeres are set in place upon the bottom and the ganister is rammed around them. This work is done at the bottom house (see the general plan of duplex and electric furnace building), where are situated the bottom-ovens and the grinding and mixing machines for preparing the ganister.

The bottoms on transfer trucks are run into ovens 15 ft. square, where they are thoroughly dried out. These are heated by coal, using a forced draft. A bottom may last for 30 to 35 heats, or only for a single one. The side-lining is of ganister, especially around the nose. Bottoms are changed commonly by unbolting while the vessel is bottom side up, then lifting it off by crane.

**Operation of the Acid-lined Converter.**—The hot converter, from which the metal of a blow has just been poured, is placed in a horizontal position and 15 tons pig iron is poured into it by means of a ladle that is brought from the mixer. When the converter is in this position no metal can flow into the tuyeres and obstruct them. After the metal is poured in, the blast (or "wind") is applied at the rate of 25,000 cu. ft. per minute, the con-

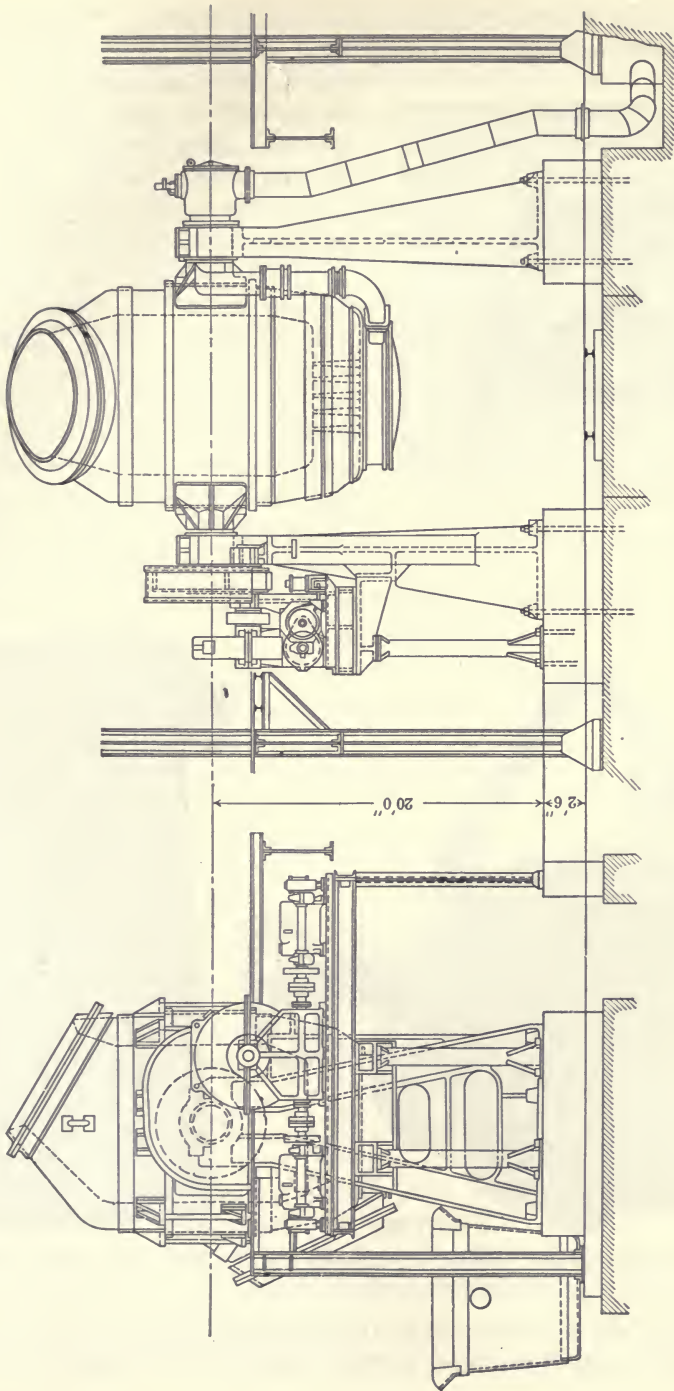

FIG. 169.—Electrically-operated, 20-ton Converter.

verter being at this time turned to the vertical position. The blast now blows in fine streams upward through 18 in. of molten metal. Active oxidation of the manganese and silicon results and in about four minutes they are oxidized by the oxygen of the air and have become slag. The carbon now begins to oxidize to  $\text{CO}$ ,

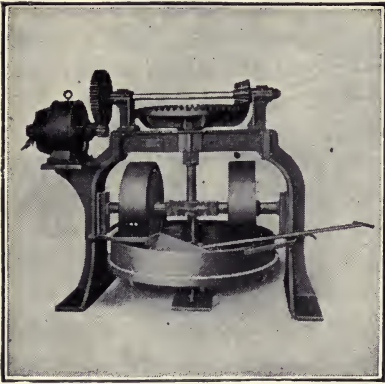

FIG. 170.—Mixing Pan, Philips & McLaren, Pittsburgh.

and this also streams upward through the metal and issues with the air from the mouth of the converter in a body of flame. After another six minutes the flame shortens or drops, and the operator, knowing that the carbon has been eliminated, turns the converter into horizontal position, the wind being at the same time shut off. In anticipation of this, a weighed quantity of spiegel iron or "spiegel"

has been tapped from the spiegel-cupola, where it is kept melted, into a



FIG. 171.—Worm-gear Bottom-tap Ladle, Pittsburg Elect. Furnace Corp.



FIG. 172.—Ingot Mould.

ladle. The ladle is transferred by the traveling-crane and poured into the converter. So great has been the heat evolved by the oxidation of the

impurities of the pig during the ten minutes of the blow that the temperature is higher than at the start, and we have a white-hot liquid consisting of comparatively pure metal. Oxidation-products remain in the bath, and the carbon and manganese of the charge tend to reduce these, the unused carbon being in sufficient quantity to impart the desired strength to the steel. Silicon, which also is introduced, tends to dispose of gas contained in the metal. After the speigel or "re carburizer" has been added and the reactions have ended, the steel is poured from the converter into the ladle, as shown at the left of Fig. 174, also the ladle is in position to receive the steel. This, after a short interval, is carried to a position over the ingot molds into which the steel is to be teemed or poured. The teeming-ladle, Fig. 171, is "bottom-poured," that is, a tap-hole and plug are arranged in the bottom, so that when the ladle is brought over the ingot mold a stream of metal drops straight downward into it until it is filled; in this way the molds are filled successively until the ladle has been emptied.

The stopper-rod, actuated by a lever-arm outside, plugs the hole from within. The end of the rod is covered by a fireclay lining, to withstand the attack of the hot metal. The ladle is tipped by operating a hand wheel or by auxiliary hoist, to pour out the slag that remains.

Fig. 172 is the ingot-mold having lugs near the top by which the mold is picked up by crane when ready for stripping, leaving the ingot standing on the car. The handle on the side is where the crane takes hold when the mold is to be laid on its side for cleaning.

The metal remains until cool, after which the molds

are stripped or lifted off, leaving the ingots standing. The ingot is picked up and conveyed to a reheating furnace, and finally sent to the rolls to be formed into the shapes desired for market use. Fig. 173 illustrates graphically by curves the progress of the reactions, and the elimination

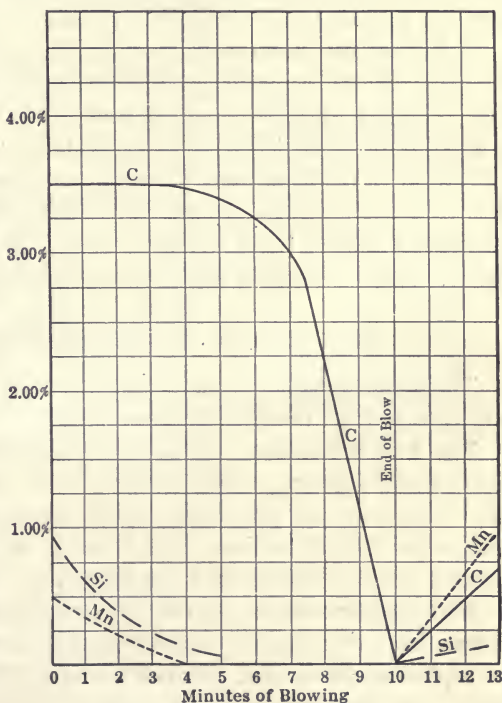

FIG. 173.—Acid Bessemer Blow (American practice).

of impurities during the blow. From it we see the rate at which the easily oxidized manganese and silicon are burned and also the carbon, which is but little acted upon until these disappear, but which after they are gone oxidizes rapidly. The pig contains at the beginning 3.5 per cent C, 1.0 per cent Si, and 0.5 per cent Mn, all being removed. The recarburizer adds to it, as Fig. 173 indicates, 1 per cent Mn, 0.7 per cent C, and 0.15 per cent Si. The manganese is added to take from the metal the oxygen absorbed during the blow; the carbon is to give the steel the required strength and hardness, and the silicon to dispose of the gas contained in the bath.

### THE BASIC BESSEMER PROCESS

The converter has a basic lining of dolomite mixed with tar stamped into place. The process is used where it is desired to treat high phosphorus ores. It is little used in the United States.

A typical pig, such as is used in this practice, would contain C, 4.25 per cent; Si, 1.0 per cent; S, 0.05 per cent; P, 1.5 per cent; Mn, 0.2 per cent. This is charged, using 11 tons of the pig with the addition of 2600 to 2800 lb. of burned lime to ensure a basic slag. The blown metal would still retain C, 0.03 per cent; P, 0.07 per cent; S, 0.05 per cent; while the slag would contain SiO<sub>2</sub>, 14 per cent; CaO, 48 to 51 per cent; MgO, 2 to 4 per cent; P<sub>2</sub>O<sub>5</sub>, 17 to 19 per cent; MnO and FeO, 14 to 16 per cent. The high phosphorus content makes it a good fertilizer and it is so used.

### STEEL-MAKING IN THE OPEN-HEARTH FURNACE

This reverberatory furnace (Fig. 175) is used in the melting down of the materials used in the manufacture of steel.

**The Two Processes.**—There are two processes of producing steel in the open-hearth furnace, called respectively, the *acid* and the *basic*. The only difference in the open-hearth furnace used is that for the acid process the hearth is lined with a sand; in the basic process with basic material such as dolomite or magnesite.

**The Acid Process.**—By the *acid* process the carbon, silicon, and manganese, impurities of the molten charge, are removed, but no phosphorus or sulphur is eliminated. Hence the acid open-hearth can only treat pure ores of the Bessemer type low in these two latter metalloids.

**The Basic Process.**—On the other hand the *basic* process can remove from the charge when melting not only carbon, silicon, and manganese, but also sulphur and phosphorus. Thus a charge of non-Bessemer material can be used, since by the basic process it is possible to eliminate the sulphur and phosphorus below the permissible limit of 0.05 per cent sulphur and 0.095 per cent phosphorus necessary for a good grade of steel.



THE OPEN-HEARTH REVERBERATORY FURNACE

Fig. 175 is a perspective view of the front of a stationary open-hearth furnace with its three charging doors. In 183 is a transverse section of one of the tilting kind, to be later described. The furnace is fired by producer gas, see the Hughes producer, Fig. 14.

During the past fifteen years the Bessemer process has been gradually giving way to the basic open-hearth process, due to the fact that low phosphorus ore is being exhausted. It is claimed that for most purposes open-

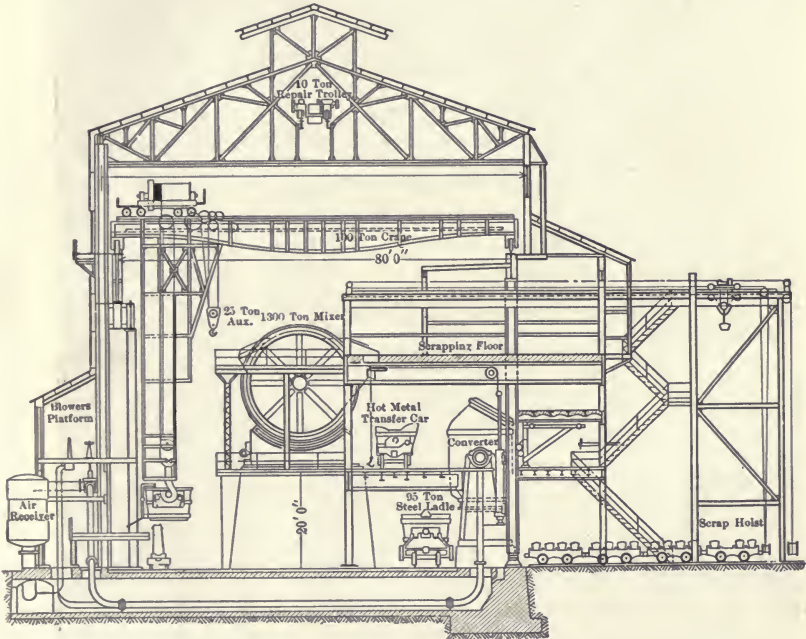

FIG. 174.—Converter and Mixer Building.

hearth steel is better than Bessemer, but the latter gives the most satisfactory product for tin plates, and is well suited to the manufacture of rails. An important advantage in the basic open-hearth process is that it can be used for making steel from pig iron and ore high in phosphorus.

Fig. 176 is a half sectional plan and elevations of the furnace, having water-cooled devices designated for the better preservation of the parts exposed to high heat and corrosive action. It is basic-lined with material specified by the legend annexed.

The furnace hearth *H* is rectangular and open at each end o t admission of air and gas at the ports *C* and *D* respectively. The roof is of silica brick, 12 in. thick. The whole furnace is heavily ironed. The entire

bottom and hearth of the furnace is built in and supported by a pan of heavy plates, riveted together and supported on I-beams resting on piers. At the skew-backs are water-cooled plates set against the I-beam buckstaves to receive the thrust of the arch. On the charging side are shown the five charging doors, counterbalanced and lifting vertically, large enough

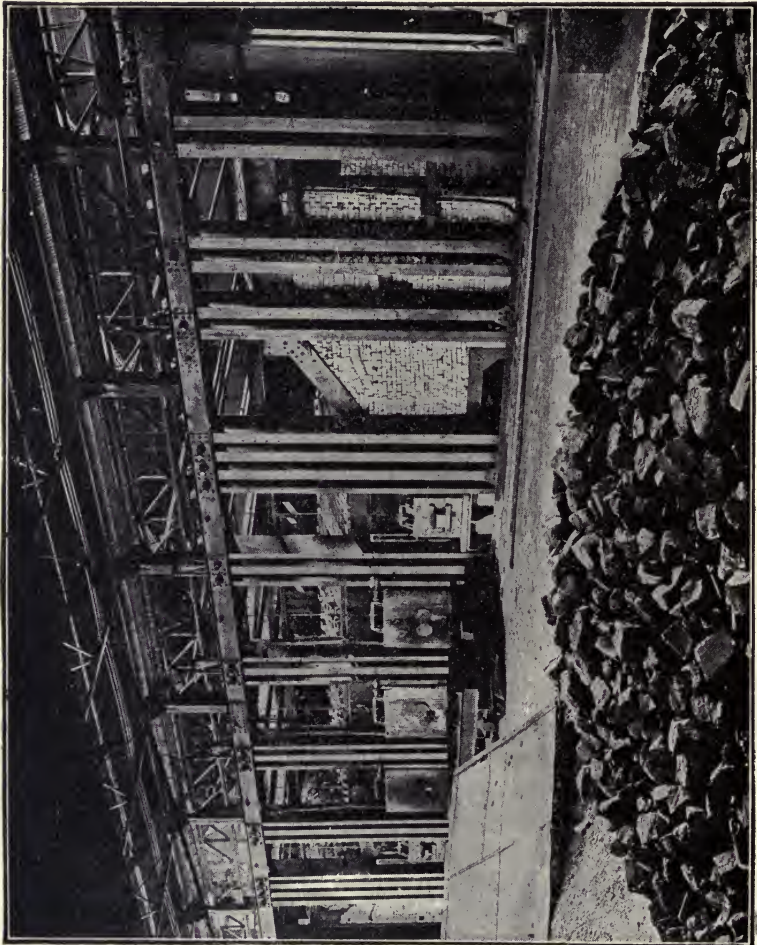

FIG. 175.—View of Open-hearth Furnace.

to enter the charging boat using a mechanical charging-machine, Fig. 181. At the middle of the back side is the tap-hole where slag and metal are drawn off.

Underground, and at one side at each end, are two checker or regenerator chambers, one for the preheating or regeneration of the air, the other for the gas. The arrangement of these is well shown in section

plan and elevation, in Fig. 178. The checkers are built up of 9-in. bricks into a series of pre-heated flues through which the air and gas pass to their respective horizontal flues and vertical uptakes, the ports delivering to the hearth of the furnace.

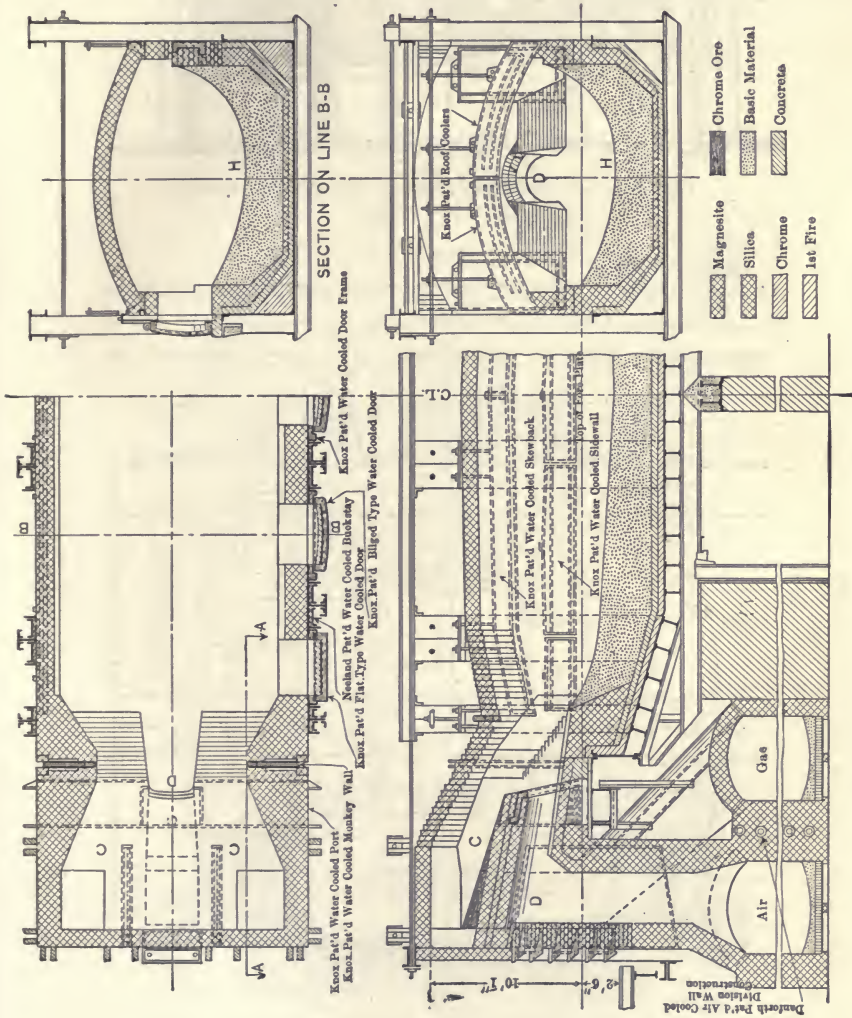

FIG. 176.—Open-hearth Furnace Equipped with Water-cooled Devices.

The general arrangement of the furnace and its accessories is given in the sectional plan, Fig. 178, particularly the passages and flues that lead eventually to the stack. As indicated by the figure, gas from the main gas flue and air through an open valve at the left are traveling along their respective gas and air checker chambers and entering the furnace by the

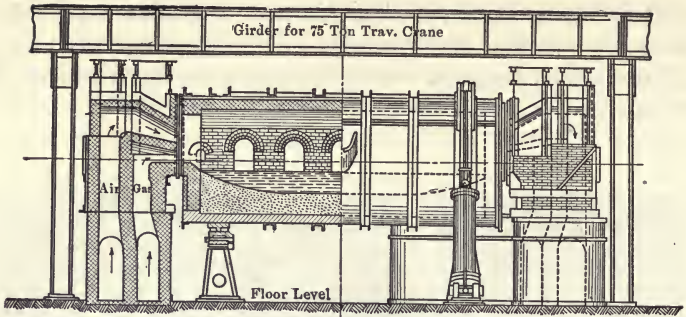

FIG. 177.—Open-hearth Furnace (transverse section).

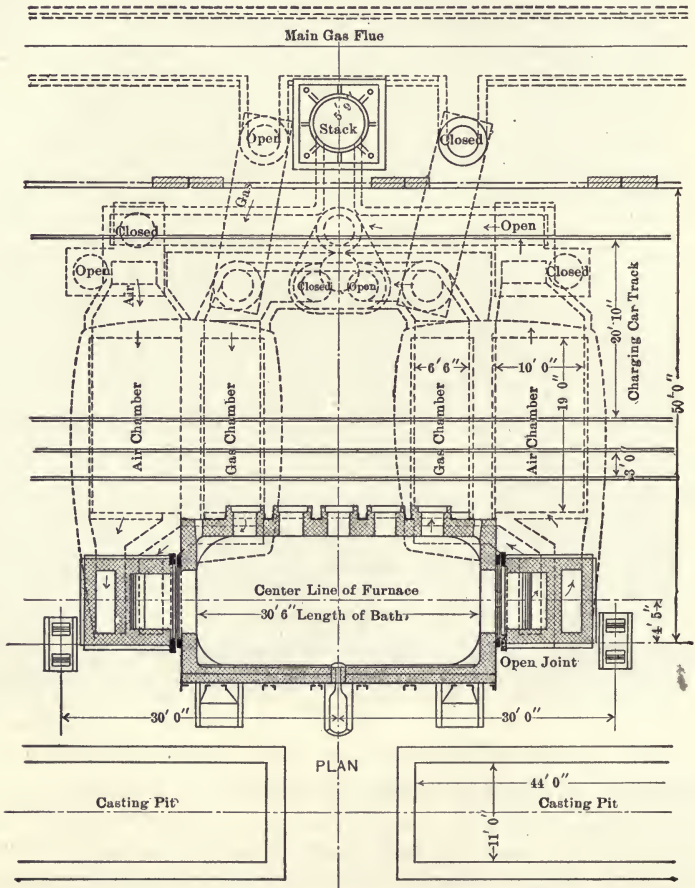

FIG. 178.—Sectional Plan of Open-hearth Furnace.

gas and air intakes and ports at the left. They are leaving the hearth by the uptakes on the right, passing through both of the checker chambers and thence through a three-way valve at the point marked "close," "open" to the stack.

The flow of gases having passed in this direction for fifteen minutes,

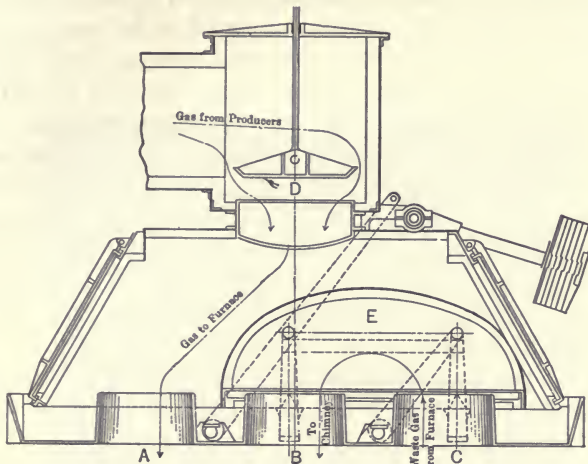

FIG. 179.—Reversing Valves (gas to left end of furnace).

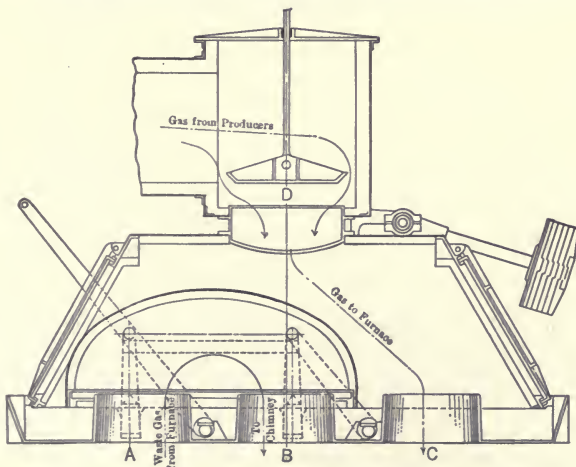

FIG. 180.—Reversing Valves (gas to right end of furnace).

the valves are reversed and the gases pass in the opposite direction for a like time. During the fifteen minutes the flame is drawn through the checker chambers highly heating them. On reversal of the gas current the producer gas and the air, before they reach the hearth, are heated by

the checker-work and both, thus preheated, burn at a higher temperature. By successive reversals the temperature of the regenerators is raised and with it the intensity of the flame of the air-gas mixture. This accretion of heat can go on to the point where the brick lining begins to soften and to a temperature that readily melts the furnace charge.

Figs. 179 and 180 show a sectional elevation of the three-way reversing valve, already referred to. In the upper view the producer gas is seen passing through a disk-valve *D*, and by the port *A*, to the furnace, while, at the same time the escaping gases passing through the checker chambers at the right and the port *C*, go through *B* to the chimney or stack of Fig. 178. The valves for the admission of air and of gas are of the disk type.

**Tapping.**—At Fig. 178 are to be seen the two casting pits where the ladles are set, adjoining the tap-hole and tapping-spout *S*. When the heat is ready to tap, a bar is driven through the tap-hole and enlarged by reaching through from the charging side by a long bar until the slag and metal flow out freely. The tap-hole should be carefully cleaned out after each heat, then replugged with clay.

**Fuels.**—The fuels employed for the open hearth are natural gas, producer gas, and oil, and of these natural gas is the best where it can be had, as indicated by the following table:

Constituent.	Natural Gas, Per Cent.	Producer Gas, Per Cent.
Carbon dioxide.....	0.40	5.7
Carbon monoxide.....	1.70	22.0
Oxygen.....	1.80	0.4
Ethylene.....	1.40	0.6
Ethane.....	12.95	0.0
Methane.....	68.85	2.6
Hydrogen.....	.....	10.5
Nitrogen.....	12.90	58.2

The heating power of natural gas is 550 Cal., and of producer gas 150 Cal. Oil is an excellent open-hearth fuel. It can be vaporized by steam or air jet, and needs no preheating. The flame of it is, however, sharp and is liable to cut out the roof and to over-oxidize the metal of the molten bath.

**The Tilting Open-hearth Furnace.**—This differs from the stationary type chiefly in that the entire furnace body may be tilted or rotated through a considerable arc, thus pouring slag or metal at any stage of the process, frequently a great advantage.

A cross-section of such a furnace is shown in the sectional elevation of an open-hearth building, Fig. 183. This shows the furnace, in melting position. This type of furnace does away with tap-hole troubles, the

tap-hole being above the slag-line in melting position; also the furnace can be readily emptied between heats and drained easily to make repairs.

**Mechanical Charging.**—At 181 is a perspective view of a charging machine. In this view is shown one of a line of trucks carrying the charging boxes. These are picked up, one at a time, by means of a charging ram, thrust through the charge-door, inverted to discharge their contents of steel scrap, then withdrawn and set once more on the truck. In this way the contents of box after box is put into the furnace.

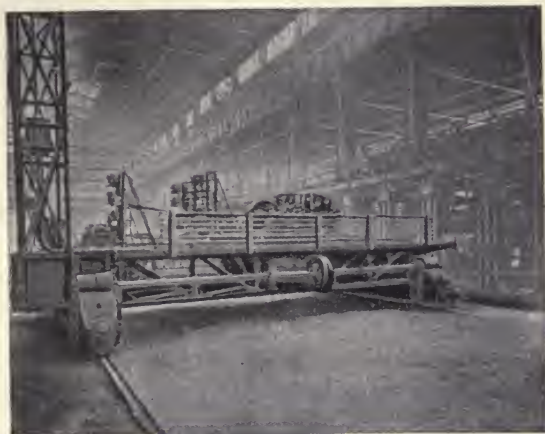

FIG. 181.—Charging Machine.

#### THE ACID OPEN-HEARTH PROCESS

**Object to be Attained.**—The process aims to reduce within defined limits the carbon, silicon, and manganese present in the charge of scrap and iron, but leaves unchanged whatever sulphur or phosphorus there is.

**The Charge.**—This, of say 100,000 lb. weight, is made up commonly of scrap steel and pig iron, the usual average being 50 to 75 per cent scrap, the remainder pig, the proportions depending on supply and cost, and being such as to produce 6 to 10 per cent of slag preferably of the composition 50 per cent silica and 45 per cent of FeO and MnO together.

The following are representative percentage analyses:

Elements.	Pig-iron.	Structural Steel Scrap.	Rail Steel Scrap.
Carbon.....	3.00 to 4.00	0.20	0.45
Silicon.....	1.00 to 2.00	0.10	0.15
Manganese.....	Under 1.00	0.50	0.90
Phosphorus.....	0.10	0.04	0.10
Sulphur.....	0.05	0.04	0.75

Computing the silicon to silica and the manganese to MnO, the latter in the charge should be less than half the silica. Silica comes also from the sand attached to ordinary pig iron and is yielded by corrosion of the silicious bottom.

**Melting Down.**—By the time the charge is melted down both manganese and silicon have been oxidized, and the resultant silica has united itself to the MnO and the little iron oxide in the stock, since the melting has been effected with a natural or even a reducing flame. In the next stage, in a hot furnace with an oxidizing flame, iron is oxidized to enter the slag, and carbon (till then but little affected) is burned off. To aid this operation 1000 to 2000 lb. of iron ore is added in calculated proportions and reacts with the carbon of the charge thus:

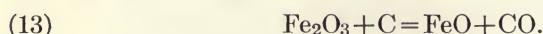

The iron oxide enters the slag, the CO is burned to CO<sub>2</sub>. The ore is added gradually according to the judgment of the melter, faster in a hot furnace and according to the character of the slag.

The following instructive table shows the composition of the charge both, before and after melting and of the resultant slag:

Elements.		GROUP I. 19 HEATS, SOFT-COAL GAS.		GROUP II. 6 HEATS, OIL GAS.	
		After Melting, Per Cent.	End of Operation, Per Cent.	After Melting, Per Cent.	End of Operation, Per Cent.
In Metal	Si.....	0.02	0.02	0.5	0.01
	Mn.....	0.09	0.04	0.6	0.02
	C.....	0.54	0.13	0.64	0.12
In Slag	SiO <sub>2</sub> .....	50.24	49.40	49.46	49.36
	MnO.....	21.67	16.50	13.16	11.30
	FeO.....	23.91	29.79	33.27	34.11
	MnO-FeO.....	45.58	46.29	46.43	45.41

The acid open-hearth process, due to its limitations, is decreasingly in use.

#### THE BASIC OPEN-HEARTH PROCESS

To make steel by this process, lime is added to the charge to produce a basic slag, and the hearth is lined with basic material to withstand this basic slag. Iron and scrap steel that contain phosphorus are used. There are in the United States vast bodies of non-Bessemer ores yielding a pig-iron too high in phosphorus for the acid open-hearth process, and too low for the basic Bessemer converter, but which the basic open-hearth can remove without difficulty for the production of a suitable steel.

The method employed for the removal of carbon, silicon, and manganese



are the same as in the acid open-hearth process, except that in basic practice there is an addition of lime for the formation of a distinctly basic slag which will not attack the basic-lined bottom.

Under the oxidizing action of the flame, and by the addition of some iron ore, the phosphorus is oxidized to phosphoric acid, and the sulphur is removed as calcium sulphide and manganese takes up a farther amount as manganese sulphide.

The phosphorus, carbon, silicon manganese, and sulphur are eliminated by oxidizing them; the oxygen being obtained principally from the iron ore. The reactions which take place are as follows:

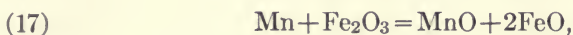
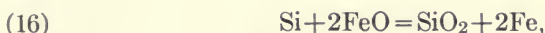
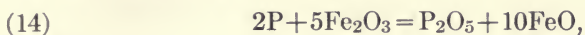

Of the products of these reactions the CO and SO<sub>2</sub> are volatile, and escape as fast as formed, the speedy escaping of the CO causing the boiling of the bath. The phosphoric acid (P<sub>2</sub>O<sub>5</sub>), silica (SiO<sub>2</sub>), and manganese oxide (MnO) separate from the molten iron and unite with any bases present to form the slag, a phosphate and silicate of iron, manganese, lime, magnesia and alumina, the slag floating upon the surface of the bath to be removed by pouring.

CALCULATION OF CHARGE

BASIC OPEN-HEARTH CHARGE-SHEET

	Weight Pounds.	SiO <sub>2</sub> +P <sub>2</sub> O <sub>5</sub> .		FeO+MnO.		CaO+MgO.	
		Per Cent.	Pounds.	Per Cent.	Pounds.	Per Cent.	Pounds.
Pig iron.....	50,000	4.0	2,000	1.0	500		
Steel scrap.....	60,000	0.2	120	1.2	720		
Iron ore.....	1,500	5.0	100	77.0	1155		
Limestone.....	8,000	1.0	80	0.6	48	54.7	4376
			2300	.....	2423	.....	4376

Slag

SiO<sub>2</sub>+P<sub>2</sub>O<sub>5</sub>=23.0 per cent

FeO+MnO=23.0 or 1 SiO<sub>2</sub>=1 FeO+MnO.

CaO+MgO=46.0 or 1 SiO<sub>2</sub>=2 CaO+MgO

Other elements 8.0

100.0

**The Charge.**—Above is given a typical charge to produce a slag of the composition given. The proportions of pig and scrap depend on the cost, abundance, and relative analyses of the pig and scrap. Both these should be as low as possible in sulphur contents, so that in the pigs, for instance, this should be under 0.05 per cent.

**Method of Charging.**—The common method is to charge practically all of the limestone, then the pig iron, and lastly the steel scrap. A portion of iron ore is also usually charged with the limestone and the scrap, the heat then has the benefit of the oxidizing action all the time that the metal is in the furnace.

**Calculation of the Charge.**—Referring to this charge we give the following analysis of its constituents:

Elements.	Pig Iron.	Steel Scrap.	Iron Ore.	Limestone.
Si(SiO <sub>2</sub> ).....	0.75 (1.6)	Trace	(5.0)	(1.0)
P(P <sub>2</sub> O <sub>5</sub> ).....	1.04 (2.4)	0.10 (0.2)	0.04 (0.08)	(0.01)
Mn(MnO).....	0.75 (1.0)	0.50 (1.2)		
Fe(FeO).....	.....	.....	60.0 (77.0)	0.6
CaO.....	.....	.....	0.2	53.6
MgO.....	.....	.....	0.1	1.1
C.....	4.00	0.12		
S.....	0.05	0.06	Trace	Trace

The silicon is oxidized to SiO<sub>2</sub>, the phosphorus to P<sub>2</sub>O<sub>5</sub>, the manganese to MnO by the air and the iron ore. The percentage of each element is multiplied by its factor to express its amount when oxidized, viz., SiO = 2.1; Si, P<sub>2</sub>O<sub>5</sub> = 2.3 P; MnO = 1.3 Mn. The computations are quite simple. It will be noted, for the slag specified on the charge-sheet, the combined FeO + MnO should be equal to the combined silica and phosphoric acid, the alkaline bases (CaO + MgO) twice that quantity. As figured, the limestone might be increased slightly.

A typical open-hearth charge for a 50-ton furnace is as follows: Molten pig iron from the mixer, 50,000 lb.; steel scrap, 60,000 lb.; limestone, 8000 lb. After melting, the additions in the furnace would be: Iron ore fed in, 1500 lb.; feldspar, 250 lb. (to promote fluidity). The additions in the ladle are coke, 280 lb.; ferro-manganese, 500 lb.; aluminum, 1 lb. The ordinary method is to charge all the limestone, then the molten pig and lastly the scrap.

**Operation.**—As shown in Fig. 182, it takes four hours to melt a charge, and six additional hours to complete the manipulation, so that in ten hours the charge is ready to draw. During the three- to four-hour melting period, the carbon, manganese, and silicon we can see are reduced. The reactions are controlled by the melter, who sees that the carbon is eliminated last,

and if it is oxidizing too fast he must "pig up" the charge by the addition of pig iron to increase the carbon. On the other hand, if phosphorus is oxidizing too fast, the oxidation of the carbon can be hastened by "oreing down" (adding iron ore) to produce the following reaction:

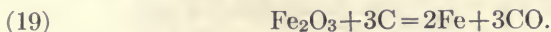

If carbon is eliminated too soon, much iron becomes oxidized. With the oxidation of silicon and phosphorus to silica and phosphoric acid, these acids form with lime and iron oxide a basic slag containing 10 to 20 per cent  $\text{SiO}_2$ , 5 to 15 per cent  $\text{P}_2\text{O}_5$ , 45 to 55 per cent  $\text{CaO}$ , and 10 to 25 per cent  $\text{Fe}$ . The slag does not attack the basic-lined hearth, and retains the phosphorus and the sulphur, but the  $\text{CaO}$  must be as high as possible for

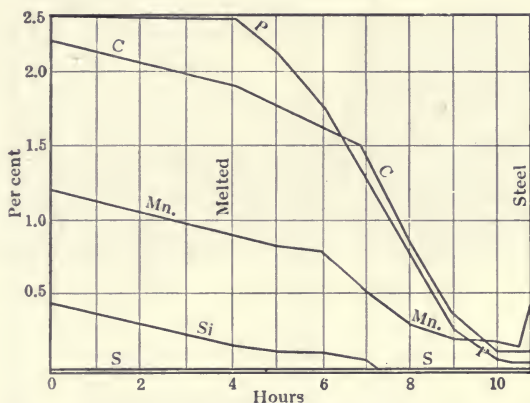

FIG. 182.—Chemical Changes in the Basic Open-hearth Furnace.

this, and yet not so high as to render the slag infusible. After melting, active oxidation begins, and the bath boils by the escape of gas. Upon the completion of the operation the charge is ready for tapping into a 50-ton ladle, the metal filling the ladle and the light slag overflowing and being thus removed. If the slag remained, phosphorus would be reduced from it, upon addition of the recarburizer, and would again enter the steel.

**Recarburization.**—Alike in acid and basic practice, this signifies the addition of ferro-manganese, containing both manganese and carbon, which restores to the melted charge just enough of these elements to give the desired qualities to the steel. The amount needed to give 0.50 per cent manganese in a heat of 100,000 lb. may be thus calculated for Group I, where there is 0.46 per cent or 460 lb. in the steel. If a ferro of 80 per cent manganese is added in the ladle, when the steel is tapped out, there will be a loss of 25 per cent so that 770 lb. of ferro-manganese should be added. Where more silicon is desired it can be supplied by the use of ferro silicon.



Alloy steels take their appropriate metal. To increase the carbon as a hardener charcoal or coke in paper bags is thrown into the ladle and half of this is lost. Aluminum in small quantities is also added to quiet the metal and make sound ingots. It takes the oxygen from dissolved iron-oxide and itself rises to unite with the slag as  $Al_2O_3$ .

**Charge Composition.**—In present practice the charge for a basic furnace consists of steel scrap (steel trimmed in the process of manufacture, old steel rails, and steel collected by junk dealers); of pig-iron containing less than 1 per cent Si, more than 1 per cent Mn, and up to 2 per cent in P;



FIG. 184.—Crane and Magnet.

of calcined limestone (quicklime) 8 to 30 per cent of the charge; and of iron ore.

#### THE OPEN-HEARTH BUILDING

Fig. 183 is a sectional elevation. Beginning at the left is the underground hopper, vertical elevator and storage bin for the coal for the producers that make the gas for the three 200-ton tilting open-hearth furnaces. By a goose-neck pipe the gases pass to the underground system of flues and chambers as already described.

On the elevated track, just within the main building, stands the locomotive which brings in the 65-ton metal ladles. These are picked off their trucks by the 100-ton crane and poured into the tilting 200-ton open-hearth furnace as shown. Just beneath the ladle on the elevated working platform is a track on which are brought in the boxes of scrap or pig needed for the charge. The open-hearth metal when finished is poured into a 110-ton bottom tap ladle, and then picked up by the heavy 175-ton traveling crane by which it is tapped into the ingot-molds near the right side of the open-hearth building. One notes the small recarburizing ladle by which the ferro-silicon, etc. (first melted) and other additions are

made. The supernatant slag, as it accumulates, is poured into a slag pot, set directly beneath the spout.

The three open-hearth furnaces each of which has a hearth area of 900 sq. ft. are electrically operated. They are so constructed as to be heated either by producer gas or by fuel oil. Fig. 181 shows the charging machine. The cars carrying the boxes of cold stock, whether scrap iron, steel, or pig iron are set in front of the furnace charging-door. The charging bar of the machine hooks upon a box, lifts it off the transfer car and carries into the furnace. The box makes a half-turn which dumps the load, and the empty box is at once withdrawn. In this figure the fixed open-hearth is shown as in Fig. 176: in Fig. 183 is a 50-ton tilting furnace. Beneath the charging floor will be seen a section of the gas chamber leading to the stack.

The casting ladles receive the finished charge or heat which is tapped into ingot molds standing on the pit floor. The pit slag from the furnaces is handled in steam-dumping ladles.

**The Gas-producer Building and Stock Yard.**—This building (not shown) is parallel to the open-hearth building. It contains nine self-cleaning Hughes producers (see Fig. 14). For furnishing basic lining there are also two dolomite kilns and a crusher. The stock yard, where is assembled the iron and steel scrap and the iron ore and limestone, is located between the gas-producer building and the open-hearth building. In the stock yards by means of a 10-ton magnet crane, Fig. 184, the scrap is picked up and loaded into the charging boxes. The boxes are then brought into the open-hearth building and placed close to the furnaces ready to be loaded into any one of them by means of the charging machine (see Fig. 181).

#### THE DUPLEX PROCESS OF STEEL MAKING

The duplex process, now largely in use in large plants, is generally understood to mean the making of steel from non-Bessemer pig iron by a combination of the acid-Bessemer and the basic open-hearth process. The acid-lined converter oxidizes the silicon, the manganese and a certain portion of the carbon of the pig, the amount of the carbon depending upon the practice. The blown metal is then transferred by ladle to the basic open-hearth furnace where the phosphorus and the remainder of the carbon are removed. The oxidation or burning off of the silicon, manganese and carbon proceeds rapidly in the converter, while in the open-hearth the phosphorus as it oxidizes enters the basic slag which does not attack a basic lining. The duplex process shortens the open-hearth purification by more than five-sixths of the usual period, giving a steel of the same quality as the straight open-hearth process.

In practice the pig-iron is poured into the converter, the blast turned on and the heat blown until in the judgment of the blower the metal is of the desired metalloïd content. In the case that high-phosphorus iron is used the blow is stopped when the metal still retains about 1.00 per cent of carbon; while, when treating a low phosphorus pig, the metal is nearly decarbonized. The blown-metal together with 2 to 3 per cent of lime to give a basic slag is now charged to the open-hearth furnace. If the metal has been decarbonized 10 per cent molten pig iron is added either in the transfer ladle or in the open-hearth furnace. In the furnace a reaction takes place; the phosphorus oxidizes and enters the slag as phosphate of lime while the carbon is removed as carbon dioxide. When the phosphorus is within the specified limits, as determined by a rapid laboratory analysis, the heat (the charge) is tapped into a ladle where proper addition for the required manganese and carbon content are made in the steel ladle. The usual way is to have three 20-ton converters supplying one sixty-ton open-hearth furnace with metal. If the three 20-ton converters are blown together and their united metal assembled in one transfer ladle for removal to the open-hearth, such a plant can keep four or five open-hearth furnaces in continuous operation. This is due to the time needed for the respective purifications, the Bessemer taking from fifteen to twenty minutes while the open-hearth will take from ninety to 110 minutes.

#### DUPLEX AND ELECTRIC-FURNACE PLANT

Fig. 185 gives the general arrangement of the converter and open-hearth departments of a large plant using the duplex process with the addition of an electric furnace building and a forge-press building. It is arranged to provide Bessemer metal for open-hearth refining, and open-hearth metal for electric refining; also directly made Bessemer ingots and open-hearth ingots.

The location of the Bessemer, the open-hearth and the electric furnaces is shown, also the bottom house where the converter bottoms are made and dried. The position of the forge press building is also indicated, but the latter is not described.

**The Converter and Mixer Building, Fig. 174,** shows many details of operation in making steel from Bessemer pig from the receipt of the molten metal from the blast-furnaces to the production of the ingot.

The molten metal is tapped from the blast-furnaces into a "65-ton ladle" carried on a truck at the ground level near the converter. It is lifted from the truck by the "100-ton crane," and poured into the "1300-ton mixer" where a large body of molten metal is accumulated of the average grade produced by the blast-furnaces. When a charge is needed for any converter, the mixer is tilted and a part of its contents poured into

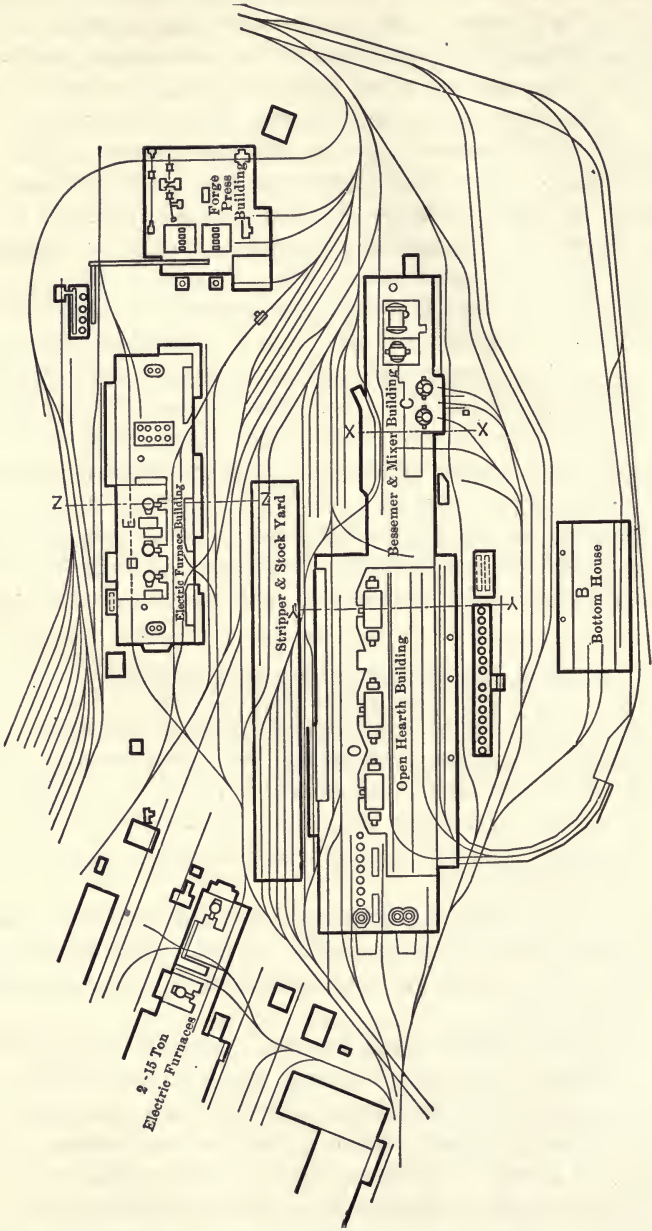

Fig. 185.—Duplex and Electric Furnace Plant.



the "hot-metal transfer car" which travels on an elevated platform at the height needed to enable it to pour into any converter when this is turned down into receiving position. To do this, the ladle being in position, a hook beside it tips the ladle. The hook is attached to a steel rope traveling over pulleys and actuated at the converter, so that as the converter turns down the ladle begins to pour. As the converter is turned back blowing begins. Additions of scrap or pig metal are made to the mixer or to the converter during blowing from a concrete scrapping platform above them. The scrap is brought in boxes carried on trucks and these boxes are hoisted from the trucks and delivered to the platform to be added to the charge as needed.

The blown metal is poured from the converters into a bottom-tap ladle which is then brought over the ingot molds standing upon trucks seen close to the side of the building at the left. The ladle is bottom-poured or teemed into the molds. For closer observation in pouring the craneman's cab is carried on a frame secured and braced to the traveling crane. A platform at the level of the top of the molds is for the tapper who does the pouring. Just outside the building and near by is the blowing platform where the converter man stands to operate the converter 80 ft. away. The air supply comes from a pressure blower in an adjacent building. When cool, the ingot trucks are taken to the stripper yard, when the molds are stripped or lifted off from the ingots and these are sent to the rolling mill.

### ELECTRIC STEEL-MAKING

The manufacture of electric steel is becoming well established in the United States, the estimated tonnage for the year 1919 being 1,215,000 short tons. This increase has been due:

- (1) To the production of a more uniform quality of steel.
- (2) To the fact that electric steel can be poured at a much higher temperature when still or dead, ensuring the production of thinner castings.
- (3) That the tensile strength and other physical properties show that the steel is stronger and tougher than other steel.

In addition one has to remember that in the United States in 1919 there were about 85 electric furnaces in the non-ferrous metal trades and about 100 producing ferro-alloys.

**The Electric Furnace.**—Figs. 186 and 187 are perspective views of an electric furnace and control panel and of the transformer and substation equipment respectively. As shown in the sectional elevation, 188, it is a three-electrode tilting furnace, resembling in its action a great arc-light. It uses an alternating current. The current in the substation is transformed from the supply line to a low-voltage, high-ampere current, thus giving a heavy current for the melting. In the figure a

clean pit is shown beneath the furnace while, in Fig. 189, the furnace is set so as readily to pour to ladles set on the floor. The furnace shell is a steel pan having a brick and ganister lining and with a firebrick roof. It

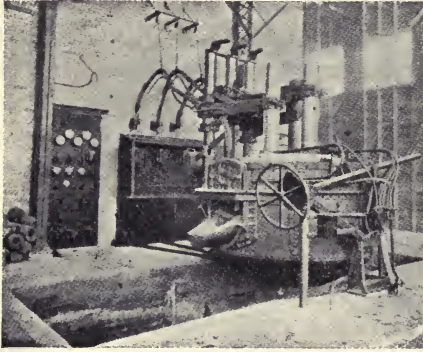

FIG. 186.—Electric-furnace and Control-panel.

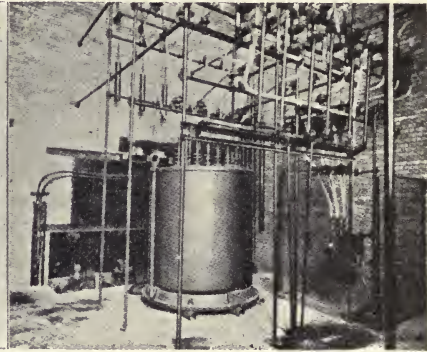

FIG. 187.—Transformer and Substation Equipment.

is charged with steel scrap through a door at the right, and the electrodes are lowered upon the charge heating and melting it. When ready, the slag is poured off through a spout at this side, while the metal is received into a ladle at the left, as shown in Fig. 189.

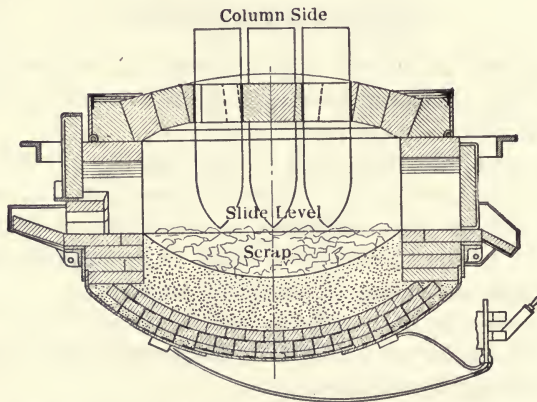

FIG. 188.—Section of Electric-furnace Showing Lining and Bottom Neutral Connection.

**The Electric-furnace Building.**—Centrally in the sectional elevation of Fig. 189 is placed the three-pole electric furnace, having at the ground level at the right a 50-ton steel transfer ladle and on the left a slag pot or car for removal of the slag from the furnace. The whole building is

commanded by a 60-ton traveling crane for charging, and removal of the finished metal in a 30-ton ladle to the ingot molds. At the left side is a 5-ton wall crane for stripping. The mechanism beneath the crane is for electrically tipping it through medium of a sector and spur gearing. The furnace has three carbon poles, as shown in Fig. 188.

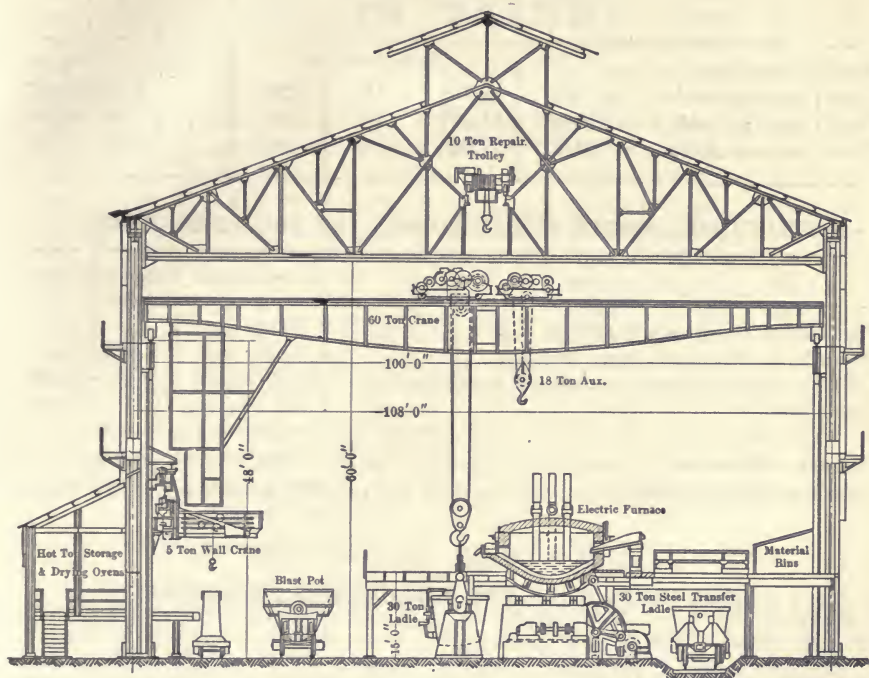

FIG. 189.—Electric-furnace Building.

### VARIETIES OF STEEL

**Basic Open-hearth Steel.**—This is a quite pure steel containing less than 0.10 per cent impurities.

**High-Grade Steel.**—A steel made in the electric furnace.

Steel rails are designated as follows:

(Chemical Specification, Asso. of Amer. Steel Manufacturers)

	C.	Si	P.	Mn.
Bessemer.....	0.35 to 0.55	Not over 0.20	Not over 0.10	0.70 to 1.14
Open hearth.....	0.46 to 0.75	Not over 0.20	Not over 0.04	0.60 to 0.90

## STEEL-CASTINGS HAVE THE FOLLOWING PROPERTIES

(Extract from Specifications, Amer. Society for Testing Materials)

	MINIMUM PHYSICAL REQUIREMENTS.				MAXIMUM.		
	Tensile Strength Lb. per Sq. In.	Yield Point Lb. per Sq. In.	Per Cent. Elong. in 2 In.	Per Cent. Red. in Area.	C.	S.	P.
Ordinary castings . . . . .		None required			0.40	....	0.08
Tested castings, hard. . . . .	85,000	38,250	15	20	....	0.05	0.05
Tested castings, medium. . . . .	70,000	31,500	18	25	....	0.05	0.05
Tested castings, soft. . . . .	60,000	27,000	22	30	....	0.05	0.05

## STRUCTURAL STEELS FOR BUILDINGS ARE THUS DESIGNATED

	Structural Steel.	Rivet Steel O. H.
Phosphorus, maximum, Bessemer. . . . .	0.10 per cent	
Phosphorus, maximum, open hearth. . . . .	0.06 per cent	0.06 per cent
Ultimate tensile strength, pounds per square inch. . . . .	55,000-65,000	48,000-58,000
Yield point. . . . .	$\frac{1}{2}$ Ult. tens. str.	$\frac{1}{2}$ Ult. tens. str.
Character of fracture. . . . .	Silky	Silky
Cold bend without fracture. . . . .	180° to diam. of 1 thickness	180° flat

## TOOL STEEL IS OF THE FOLLOWING COMPOSITION

	Tungsten.	Chromium.	Car.	Sul.	Phos.	Sil.	Vanadium.
Carbon steel. . . . .	....	....	1.10	0.03	0.015	0.20	
High-speed steel. . . . .	18.00	3.50	0.55	0.012 or less	Trace	Trace	1.00

Alloy steel may be defined as ordinary properly melted carbon steel to which have been added ferro compounds of certain rare metals in sufficient though small amount to materially modify the qualities of the original carbon steel as shown in the following table.

The alloy steels are divided into two groups, those with one metal alloyed as in (3) and quaternary steels with two metals alloyed as in (7). They have high elastic limit, great strength and toughness. The first two qualities are enormously increased by heat treatment (quenching and tempering) and the steel still retains great toughness. The most important of the structural alloy steels are those of nickel, chromium, and vanadium, which by heat-treatment can be given a tremendous range of strength, varying from 100,000 to 250,000 lb. per square inch.

## COMPOSITION OF ALLOY STEELS

	Carbon Per Cent.	Manga- nese Per Cent.	Nickel Per Cent.	Chromium Per Cent.	Vanadium Per Cent.	Elastic Limit Lbs. per Sq. In.	Tensile Strength Lbs. per Sq. In.	Elonga- tion in 2 In. Per Cent.	Reduc- tion of Area Per Cent.
(1)	.27	.55	.....	.....	.....	49,000	80,000	30	65
(2)	.27	.47	.....	.....	.26	66,000	98,000	25	52
(3)	.45	.50	.....	.....	.....	65,000	96,000	22	52
(4)	.43	.60	.....	.....	.32	96,000	122,000	21	52
(5)	.30	.60	3.40	.....	.....	75,000	105,000	25	67
(6)	.33	.63	3.60	.....	.25	118,000	142,000	17	57
(7)	.30	.49	3.60	1.70	.....	119,000	149,500	21	60
(8)	.25	.50	2.00	1.00	.....	102,000	124,000	25	70
(9)	.38	.30	2.08	1.16	.....	120,000	134,000	20	57
(10)	.42	.22	2.14	1.27	.26	145,000	161,500	16	53
(11)	.36	.50	1.30	.75	.16	140,000	157,500	17	54
(12)	.30	.50	.....	.80	.....	90,000	105,000	20	50
(13)	.23	.58	.....	.82	.17	106,000	124,000	21	66
(13)	.35	.64	.....	1.03	.22	132,500	149,500	16	54
(15)	.50	.92	.....	1.02	.20	170,000	186,000	15	45

Lathe tools made from high-speed steel can be run at a speed of 30 ft. per minute, indeed so that the cutting edge shows a just visible red, a speed four times as great as that which ordinary tool steel will stand.

## IRON ORE AND PIG-IRON PRICES

**Pig-iron, Pittsburg Market in 1920 (Quotations for Carload Lots).—**Standard Bessemer, \$29.35; malleable Bessemer, \$28.65; basic, \$27.15; No. 2 foundry, \$28.15; gray forge, \$27.15. Standard Bessemer is used for making steel in the Bessemer converter, malleable Bessemer for malleable iron castings, basic for steel suited to the basic open-hearth furnace, foundry for making foundry castings suited to machining, and gray forge for wrought-iron. In the Chicago markets both Southern and Northern pig-iron are quoted. The first, from the great iron center at Birmingham, Ala., though cheap, is high in phosphorus. The Northern iron from nearby points is made from Lake Superior ores. Pig iron, cast in sand, is weighed to 2260 lb. for a long ton, the 20 lb. excess being allowance for the sand that sticks to the pigs.

**Steel, Pittsburg Market.**—Bessemer and open-hearth billets are quoted at \$38.50. These are ingots 4 in. square by 6 ft. long that are re-heated and rolled into the required merchant-steel bars.

**Iron Ores** are purchased by guarantee on the part of the shipper that they will come up to a given standard that generally is based upon the percentage-content in natural condition, thus including the contained

moisture. For Lake Superior ore the prices for 1920 at Lake Erie ports, per long ton (2240 lb.) were:

Old range Bessemer, 55 per cent iron base.....	\$6.45
Old range non-Bessemer, 51.5 per cent iron base.....	5.70
Mesabi Bessemer, 55 per cent iron base.....	6.20
Mesabi non-Bessemer, 51.5 per cent iron base.....	5.55

On a non-Bessemer ore, as it varies from this, a premium of 11.95 cents is paid for each per cent iron over the guarantee, and a penalty or reduction is made of 11.95 cents down to 50 per cent iron, and 17.95 cents down to 49 per cent iron, and a double penalty down to 48 per cent iron. Below 48 per cent, the penalty becomes 27 cents per unit. On Bessemer ore, provision is made for a premium only in case the ore exceeds the guaranteed 55 per cent iron.

The Old Range ores come from the iron ranges on the south side of Lake Superior, and command a higher price because of the better mechanical condition. The Mesabi ores are soft, friable, and carry much fine, which makes flue-dust. When smelting such ore, in ratio of 85 per cent soft to 15 per cent hard ore, as much as 6 per cent flue-dust or dirt is made.

**Steel Works, Scrap, 1920.**—Heavy melting steel per gross ton delivered at works \$19.00 to \$21.00.

**Cost of Production of Pig-iron** in the electric furnace in 1915 was \$26.21 per long ton and of steel from steel scrap \$29.90 per long ton based on a cost for common labor of \$2.50 per eight-hour shift.

PART V

COPPER





## CHAPTER XXVII

### COPPER ORES AND THEIR TREATMENT

#### CHARACTERISTICS OF COPPER ORES

We are to think of copper ores as mineral aggregates, carrying frequently 10 to 15 per cent copper or less, with associated minerals and an earthy gangue. Treating the ore is a problem not only of obtaining the copper, but of separating and eliminating the gangue and associated minerals. Though there are many kinds of copper ores, those of commercial importance are few in number. We may divide them into three classes: (1) the sulphides; (2) the oxides, including the carbonates and silicates; (3) ores containing native copper.

**Sulphides.**—Chalcopyrite,  $\text{CuFeS}_2$ , when pure contains 34.5 per cent copper. This is by far the most widely distributed and most abundant of the ores of copper, and furnishes the world's principal supply of the metal. It is frequently accompanied by iron pyrite, and has silicious gangue even when the sulphide is massive. In consequence, the ore often carries no more than 3 to 4 per cent copper, but is particularly suited to pyrite smelting, that is to smelting with little fuel. Silver and gold are found in the ore in small quantity. The deposits at Mt. Lyell, Tasmania, that have been so successfully worked by pyritic smelting, are chiefly of massive iron pyrite, containing chalcopyrite, and carrying 4.5 to 5 per cent copper with 0.15 oz. gold and 3 oz. silver per ton.

Chalcocite (copper glance),  $\text{Cu}_2\text{S}$ , is computed to contain 79.7 per cent copper, but it is seldom pure even in the crystalline form, the copper having been replaced by iron and other metals. The impure mineral shows the characteristics of the pure mineral when carrying as little as 55 per cent copper. The pure crystals resemble the artificial product "white metal," a high-grade copper matte produced in the furnace.

Bornite (peacock ore),  $\text{Cu}_3\text{FeS}_3$ , when pure contains 55.6 per cent copper. It is found associated with chalcopyrite and chalcocite in proportions varying from 42 to 70 per cent copper, without losing the characteristic varied colors.

Enargite ( $3\text{Cu}_2\text{S} \cdot \text{As}_2\text{S}_5$ ), 48.3 per cent copper, an arsenide, occurs in Butte, Mont., ores.

Tetrahedrite (gray copper fahlerz),  $-(\text{Cu}_2\text{S}, \text{FeS}, \text{ZnS}, \text{Ag}_2\text{S}, \text{PbS})$ ,

( $\text{Sb}_2\text{S}_3, \text{As}_2\text{S}_3$ ), may be computed as containing 30.4 per cent copper, but it varies greatly in the copper and silver content. It has already been mentioned as a silver ore. Because of the contained arsenic and antimony it is unfavorable as a copper ore, and it is only because of the richness in silver that it is treated.

**Oxides, Carbonates, and Silicates.**—These ores are the result of the decomposition of the copper sulphides, by air and water. We find them in the upper zones of mineral deposits accompanied by iron oxide, which also is the result of the decomposition of iron sulphide. As we sink on the vein we find the oxidized ore of the upper levels giving place in depth to the unaltered sulphides.

Cuprite (red copper-oxide),  $\text{Cu}_2\text{O}$ , 88.8 per cent copper, is a product of decomposition. It often permeates large masses of iron ore. Large lumps of the ore are sometimes found, the center of which contains unaltered metal. These evidently are the result of the oxidation of a mass of native copper.

Melaconite (black oxide of copper),  $\text{CuO}$ , contains when pure 79.8 per cent copper. The ore, with the copper in part replaced by oxides of iron and manganese, is sometimes found in masses large enough to pay for extraction, and containing 20 to 50 per cent copper. The so-called black oxide of the Blue Ridge region, on the border of Tennessee, North Carolina, and Virginia, seems to be an intimate mixture of copper glance, black copper oxide, copper carbonate, and native copper with iron oxide and sulphide. The ore can be readily roasted in lump form.

Malachite,  $\text{CuCO}_3 \cdot \text{Cu}(\text{OH})_2$ , 57.3 per cent copper, occurs widely distributed, ordinarily in non-paying quantities as a decomposition product in surface deposits, but sometimes sufficiently rich to work. It is found mixed with limestone, dolomite, oxides of iron, manganese, and silica. It is difficult to judge the copper content of the ore from the appearance, but the green color makes its presence readily recognizable.

Azurite,  $2\text{CuCO}_3 \cdot \text{Cu}(\text{OH})_2$ , is computed to contain 55.2 per cent copper. The ore is blue, as the name indicates, and the appearance is striking. It occurs in the same way as malachite, and often is associated with malachite, but it is less abundant, and often is only a coloring on other oxides.

Chrysocolla, a hydrated silicate of copper, containing when pure 40 per cent copper, is a decomposition product of copper sulphide, and is often accompanied by malachite.

**Native Copper.**—Native copper is found extensively in the copper region of Lake Superior. Elsewhere it occurs sparingly and is not commercially important, though it often accompanies the oxidized ores. In the Lake Superior region it is found in wide lodes disseminated through the lode-matter 0.65 per cent to 4 per cent of the whole, and even when the lowest grade mentioned, by concentrating can be recovered at a profit. The con-

concentrate or "mineral," as it is locally named, is produced in different grades, ranging from 30 to 94 per cent copper. Much of the native copper is pure; in other instances it carries a little arsenic.

**Properties of Copper.**—Its melting point has been established at  $1083^{\circ}$  C., and its specific gravity at 8.89, while its latent heat of fusion is 43.3 calories, and its specific heat at  $170^{\circ}$  C. is 0.09244 closely one-tenth that of water. Traces of oxygen are purposely left, even in the highest grades of copper, since otherwise it would be impossible to cast a sound ingot, as the copper in the refining process readily absorbs gases that are expelled during solidification. Even the best of copper castings are somewhat porous, and thus low in electrical conductivity. Castings of a conductivity of 97 Mathiessen's standard have been made by the addition of small amounts of boron in the ladle just before casting, thus deoxidizing the metal so that its mechanical properties are excellent, and it can be used for making even intricate castings.

Copper is mechanically improved by hot working: When it is heated to a bright red and quenched, maximum ductility is attained, while cold working increases the tensile strength, but lowers the ductility.

Solid copper can absorb arsenic up to a maximum of 4 per cent. In small quantities it increases its maximum stress without affecting the ductility. It has been found that the deoxidation of arsenical copper by addition of ferro-silicon greatly improves its qualities.

The physical properties of copper fall into two classes, viz., electric and mechanical, and the treatment best suited to attain the one is undesirable for the other. Pure, soft dense metal has the highest conductivity, but it is weaker for use on transmission lines.

### THE EXTRACTION OF COPPER FROM ITS ORES

Copper may be extracted from the ore by dry or by wet methods. By the dry method the ore is smelted, the process being one of igneous fusion. By the wet or hydro-metallurgical methods the copper is leached from the ore. The striking point of difference between the two methods is that, in the first, we melt the entire ore, effecting then a separation of the copper from the worthless part, while in the wet method we act upon the copper alone, leaving the greater part of the ore in the original condition.

**The Dry or Igneous or Pyrometallurgical Methods.**—Probably more than 90 per cent of the world's production of copper is by smelting. The methods of smelting vary with the nature of the ore. We may divide them into the following:

(1) **The Smelting of Oxidized Ores** that may contain a little copper, or of concentrates of native copper in blast-furnaces and in reverberatory furnaces is done for the production of a crude copper called blister copper.

When performed in the blast-furnace the process resembles the smelting of iron ore to produce pig iron. For fine ores or concentrate the reverberatory furnace is preferred, since in the blast-furnace much flue dust is produced.

(2) The smelting of ores containing sulphides of copper and iron in the blast-furnace or the reverberatory is to yield a copper-and-iron sulphide, called "matte." The amount of matte is dependent on the amount of sulphur per cent, so that if part of the sulphur is expelled by roasting, or by being burned off or volatilized in the blast-furnace, then less matte is formed. As much as 70 to 80 per cent of the sulphur may be got rid of in this way. The copper is concentrated into a small amount of matte as compared with the original bulk of the ore. This matte has to be further treated to obtain blister copper.

**Ordinary Matte Smelting.**—When roasted ores are smelted, this may be called ordinary matte smelting: About 10 per cent of the charge is coke, added to cause its melting. If the ore is imperfectly roasted or is smelted raw, then less coke may be used, since the sulphur in the ore burns, producing heat; also, this burning of the sulphur is in itself a kind of roasting. Thus, again, the amount of matte produced is materially reduced.

**Pyrite Smelting.**—The smelting of raw ore in the blast-furnace is called pyrite smelting because there is much iron or copper pyrite in the ore.

**Collectors.**—The blister copper produced in the oxidizing smelting is to take up or collect within itself any gold or silver present in the ore; the same is true of the matte; so that we say both blister copper and copper matte are collectors of gold and silver.

**In reverberatory smelting** the elimination of sulphur is less, say 25 per cent of the sulphur in the charge; so this way of smelting is not suited to the treatment of raw ore. Much material for smelting has been concentrated and so is fine. It is in good condition for cheap roasting in one of the mechanical roasters already described.

**Fine Concentrates.**—This fine product, if treated in a blast-furnace, would produce much flue dust; so for such material, the reverberatory is preferred, due to its large capacity, its quiet condition of smelting, and to the cheaper fuel needed.

**The Wet or Hydrometallurgical Methods.**—In these the copper is obtained from the crushed ore in water solution, either with or without the aid of other solutions. The ore may have first to be roasted. From this water solution the copper is precipitated, melted and refined.

## CHAPTER XXVIII

### COPPER BLAST-FURNACE SMELTING OF OXIDIZED ORES

This resembles the smelting of iron ores in that metal is obtained in metallic form in one operation. The ore, which does not contain sulphide, is charged into a blast-furnace and smelted with coke for fuel. The products are slag and blister-copper, the latter being metallic copper containing impurities that have been taken up in smelting, much as carbon and silicon are absorbed in iron smelting.

**Blast-furnace Plant for Oxidized Ores.**—Fig. 190 is a plan and Fig. 191 an elevation of a blast-furnace building suited to the smelting of oxidized copper ores. It has two floors or levels, the upper, called the charge-floor, and the lower, the slag-floor. The ground at the right drops away and furnishes a place for a dump. The ores and fluxes are stored in bins on the ground at the charge-floor level, and are brought in weighed charges to the furnace door, the sill of which is flush with the charge-door. This door is shown also in Fig. 65. The slag and blister-copper are withdrawn near the bottom. Behind the furnace is seen the pipe or blast-main by which air is conducted to the wind-box at the tuyeres. The furnace stack extends above the roof and at the side branches to a down-take leading to a dust-flue. Here much of the dust, as in the dust-catcher of the iron blast-furnace is removed. This dust-chamber terminates, as shown in the front of the plan view, at a stack which takes away the residual gases at a high level. On the plan we also see the boiler and engine which drive the furnace blower at a pressure of 12 to 15 oz. per square inch, equal to 24 to 30 in. of a mercury column. Waste slag, or sweepings, carrying copper, are returned to the feed-floor by a platform elevator shown in the corner of the furnace-room.

In Fig. 65 is a view of the cupola blast-furnace used for the production of copper from oxidized copper ores.

The crucible contains the molten contents of the furnace, the copper below and the lighter slag floating upon it. There are two tap-holes and two spouts; the lower, close to the bottom, is to remove the molten copper; the upper, a few inches higher, is to withdraw the slag. From time to time, as slag or copper accumulates, it is withdrawn by piercing a hole through the clay-stopping of the tap-holes by means of a pointed steel tapping-bar. The flow is arrested by thrusting into the opening a plug of clay stuck on

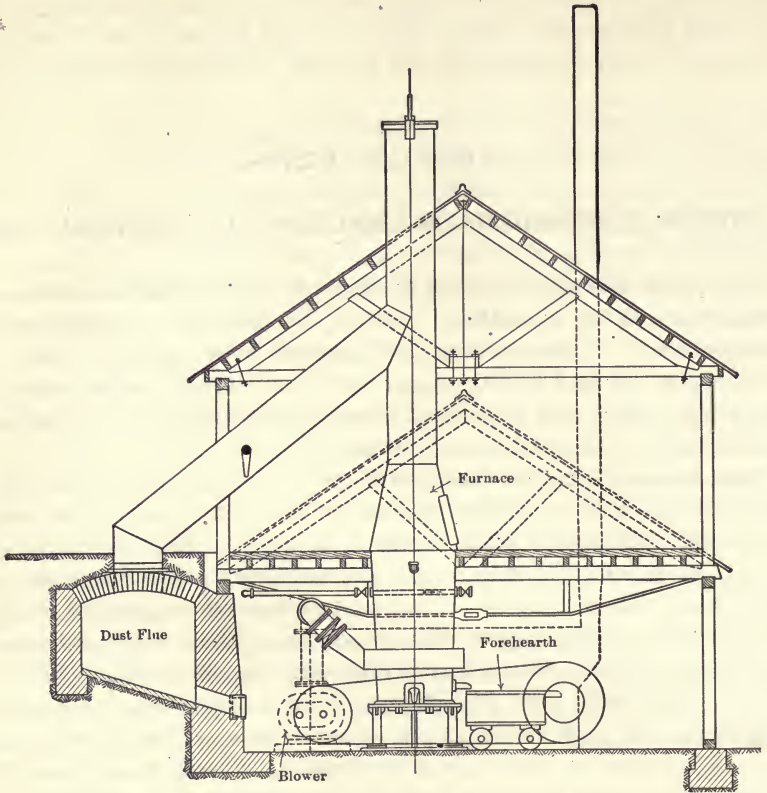

FIG. 190.—Sectional View of Small Smelting Plant.

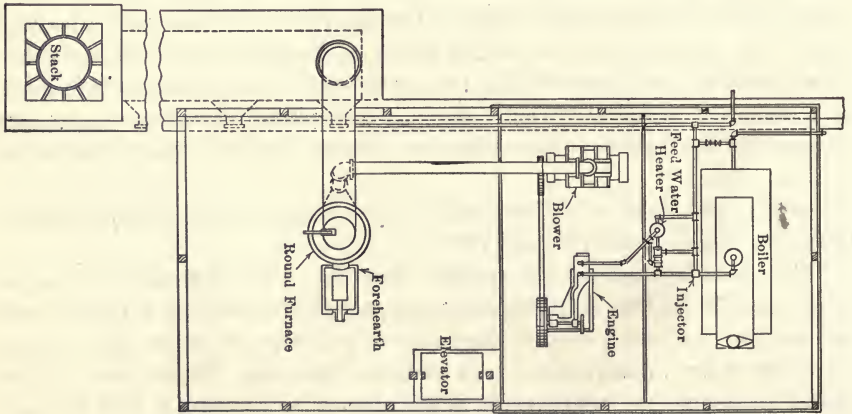

FIG. 191.—Plan of Small Smelting Plant.

the end of a button-headed stopper-rod or dolly. The slag is received into a fore-hearth mounted on wheels through which flows the escaping furnace slag. This slag carries with it drops of copper not settled out in the furnace. The molten slag quite fills the fore-hearth, crusting over, but maintaining a cavity, where the drops of copper settle out. The slag overflows at the spout at the opposite end into a slag-pot, Fig. 200, set to receive it. When the tap-hole is stopped by a plug of plastic clay, the slag flow ceases, and an empty slag pot replaces the full one.

The copper is received in a "bullion mold," which, after filling, stands until the copper has solidified. The ingot is then dumped out and the mold again used. The furnace shown is a round one, 36 in. diameter inside, thus having a bosh or enlargement of 6 in. on the side.

In operation, the furnace is kept full to the feed-door with alternate layers of fuel and charge. The blast rises through the column of materials (a distance of 7 ft.) and passes off through the down-take, which has sufficient draft to take away the gas and smoke and also the air that enters the feed-opening or door. The blast enters under pressure causing an intense combustion of the coke and the fusion of the charge. The copper reduced by the glowing coke, collects in drops and finds its way to the bottom of the crucible, while the gangue of the ore, fluxed by the addition of iron and limestone, forms a fusible slag.

The smelting of the oxidized copper ores, as above described, was formerly used in the southwestern United States so long as the oxidized ores lasted; it has been replaced by the more efficient and cheaper methods of matte-smelting either in blast-furnaces or in reverberatories.

The notable exceptions are those of the copper country of Northern Michigan and the large-scale work of the Union Minière du Haut Katanga, Southern Congo.

#### LAKE SUPERIOR COPPER COUNTRY BLAST-FURNACE SMELTING OF COPPER SLAG

Both the cupola furnace (Fig. 65) and the rectangular furnace resembling Fig. 196 are used. The smelting is conducted along the lines described for oxidized copper ore for the production of an impure blister copper. Reverberatory slags to which has been added native copper and briquetted material are thus smelted. The charge consists of slag 2000 lb., limestone 600 lb., and anthracite coal (steamer size or about  $2\frac{1}{2}$  in. diameter) 400 lb. It is the practice at one works to add much small mass or native copper to the charge, the idea being that, as the native copper in it melts and sinks to the crucible of the furnace in the form of drops, it carries down reduced copper with it. Elsewhere the fine concentrate has been thoroughly incorporated with a quicklime paste, briquetted in a briquetting





press and the briquettes treated in cylinders under steam pressure for twenty-four hours. This renders them quite hard, and in an acceptable form for smelting.

The products of the furnace are slag of less than 1 per cent copper and "cupola blocks," an impure blister copper, which is sent to a reverberatory furnace for refining.

It is to be noticed that the low percentage of copper in the slag is due to the use of the anthracite coal. This has an intenser reducing action than the coke. However, it slows down the furnace and the two fuels are to be used in judicious proportions, because, as the anthracite is cut down and the coke increased, the furnace will run the faster. This use of coal suggests itself in cases where oxidized ores have elsewhere to be smelted in a blast-furnace.

The cupola blocks, referred to above, which constitute the product of the blast-furnace smelting of the slag from the reverberatory refining-furnace, are melted and refined to produce a low-grade copper called "casting-copper." The cupola-blocks are impure and contain so much arsenic that it is practically impossible to remove it all. Other impurities (iron and sulphur) are eliminated.

#### SMELTING TO BLACK COPPER BY THE UNION MINIÈRE DU HAUT KATANGA

The company smelts oxidized copper ore from the great superficial deposits at Lubumbashi, near Elisabethville, Belgian Congo, producing black or blister copper as already described under the heading "Blast-furnace smelting of oxidized ores." There are six furnaces, Fig. 192, each 44 in. wide and 20 ft. long, the largest thus far made for the treatment of oxidized copper ores. They have two tiers of jackets, the lower side jackets being 10 ft. high and 2 ft. wide. The upper ones of the same width are 7 ft. 4 in. high. From the tuyeres to the feed-floor is 18 ft., and the side-bosh is 14 in., making the furnace shaft above the lower jackets 72 in. wide, for good reduction. At the left-hand end is a trapped slag-spout for the continuous flow of the slag; at the other end is a slag-spout to be used in case the furnace stops and the slag has to be tapped off. At one side, and nearer the right-hand end, is the bullion spout and tap-hole for removing the bullion (black copper) from the bottom of the crucible. To the top of the crucible from the slag-floor it is 7 ft. 2 in., so there is sufficient room for the fore-hearth beneath the trapped slag-spout. The bustle-pipe, 21 in. by 42 in., in cross-section is rectangular in order to save building space. The furnace is surmounted by a closed top (not shown) as in Fig. 196, with feed-doors the full length of the side.

## CHAPTER XXIX

### BLAST-FURNACE SMELTING OF SULPHIDE ORES

#### MATTE SMELTING

If we smelt raw sulphide ores of copper and iron in the blast-furnace just described, using, say 10 per cent of fuel, with added fluxes to form a fusible slag, we form an artificial sulphide or matte of 23 to 25 per cent sulphur. The copper that was in the ore and the iron from the charge enter the matte, but the quantity of matte so formed is but little less than that of ore originally put into the furnace. If, however, we first roast the ore, the quantity of sulphur present, and consequently the amount of matte made, is less, and the ratio of the ore to the matte may be five or ten to one. In the matte will be the copper as a sulphide, and, in forming, the matte will take up the silver and gold of the ore. By this operation we collect the precious metals in a product one-fifth to one-tenth the original ore, the matte being termed a "collector." It then can be further treated to convert it into metallic copper carrying the precious metals. By the process of electrolytic refining, the gold and silver are eventually separated from the copper. A charge suited to matte-smelting methods would therefore consist of roasted ore retaining 7 per cent sulphur together with oxidized copper and copper-free ores containing gold and silver added to recover the precious-metal content. It would also carry fluxes to make a fusible slag and to supply iron (if needed) for the matte.

The products of the furnace are slag and matte. The former is the result of the union of the silica in the charge with the various bases, chiefly iron oxide and lime. The latter is the complex artificial sulphide produced by the sulphur in the charge combining with copper and iron. The affinity of sulphur for copper is greater than for iron, and it takes the former first; then if it needs iron it takes that also, until a compound of both has been formed that contains approximately 25 per cent sulphur. Any further iron present enters the slag as ferrous oxide, and as the ratio of the iron thus available to the other bases varies so will the slag vary in composition; but the principal requirement is that the quantity of silica be enough to form a fusible slag. Slags of 25 to 40 per cent silica are common in copper-matting practice, and the 40 per cent limit is sometimes exceeded when, for economy in smelting, it is desired to use as little flux as possible.

In the matte-smelting operation the object is to collect the metals, copper, gold, and silver, into a small amount of that complex artificial iron-copper sulphide called matte. Now, in the pyritic smelting of copper ores, using an excess of air and little fuel, much of the sulphur (say 75 to 80 per cent) is dissipated or volatilized so that a small amount only is left to form matte. The same result is attained by first roasting the ore, only in such case much more coke must be used, as compared with that needed in pyritic smelting. Blast-furnace smelting is suitable to ore in lump form, whether unroasted, or as the product of heap-roasting.

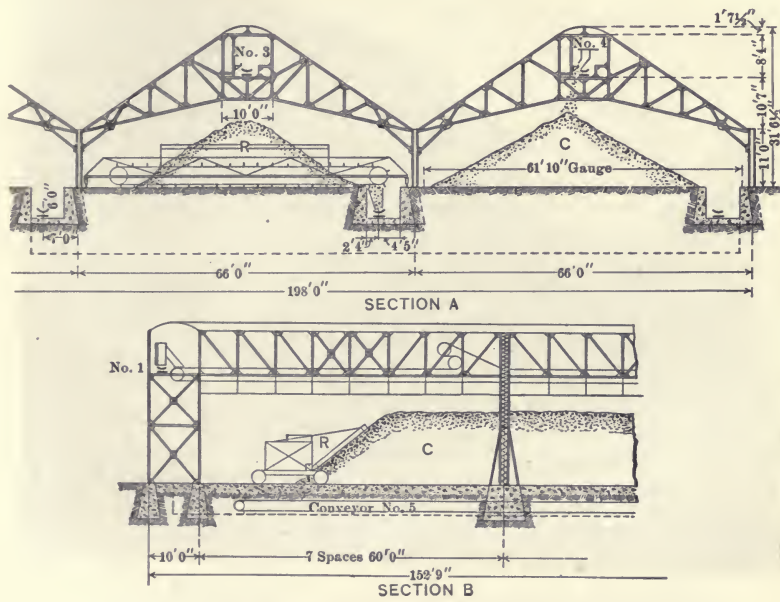

FIG. 193.—Messiter Bedding System.

**Ores for Matte-smelting.**—Ores suitable for matte-smelting are the oxidized ones containing some sulphur and ores that have been roasted; to which may be added silicious and oxidized ores containing gold and silver. Ores that require to be first roasted are better roasted in lump form in heaps or stalls or sintered, for the reason that the blast-furnace, because of its strong air currents, is not suited to smelting fine ore. The amount of matte made (matte fall) depends upon the quantity of sulphur in the charge, and to get sufficient concentration (little matte from much ore) the sulphur is kept low. To the ore above described is added limestone and iron ore as flux, and a quantity of fuel equal to 10 to 15 per cent of the charge.

## THE MESSITER SYSTEM OF BEDDING

Instead of storing ore in pockets, or bedding upon the ground as above described, the Messiter system of bedding and reclaiming ore is coming into increasing use for large plants. As shown in Fig. 193, it constitutes part of a complete belt-conveying system. The ore, coarse-crushed at the sampling and crushing mill, is there separated by trommels into fine and coarse ore, the fines going to pockets for roasting.

There are three bedding floors side by side upon which the coarse ore

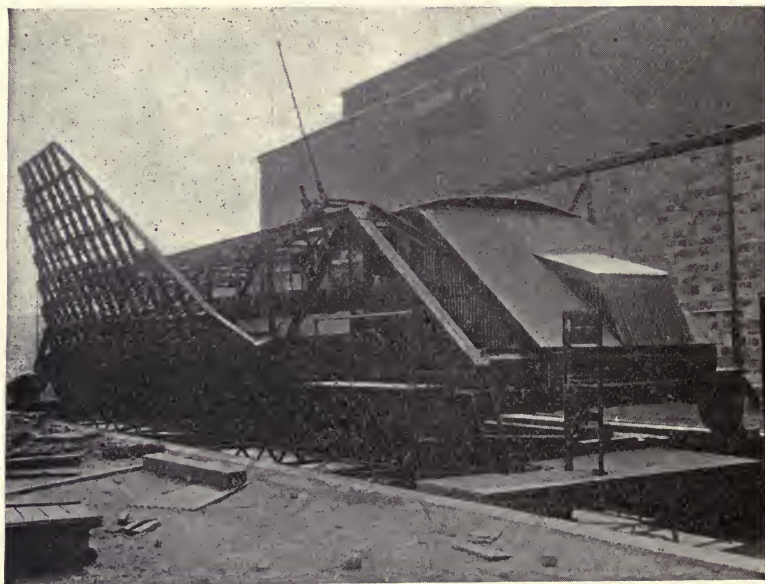

FIG. 194.—Robins-Messiter Reclaiming Machine.

is deposited, each bed when completed being of triangular shape in cross-section, 375 ft. long, capable of holding 10,000 tons. By an incline conveying belt the ore is delivered upon the cross-conveying belt, No. 1, at the left-hand end to the spreading belts Nos. 2, 3, and 4, by means of a tripper, each of these three extending from end to end of the bed. A tripper on each spreading belt travels back and forth over the extent of the bed at the rate of 400 ft. a minute, dropping its load in thin layers upon the bedding floor beneath. In this way lot after lot is distributed until the bed is completed.

To take up or reclaim the ore, a reclaiming machine Fig. 194 is used. It is a traveling frame, *R*, spanning the width of a bed, and a trench containing a conveying belt that takes away the ore delivered to it by the

reclaiming machine, as shown in Section A. Under the forward edge of the bridge is a scraper-conveyor, operating in a steel trough that has a flat bottom and a vertical back-plate. The flights of the conveyor, sweeping along this trough, carry the ore to the end of the machine to drop it upon the trench conveyor-belt. A triangular harrow covering the cross-

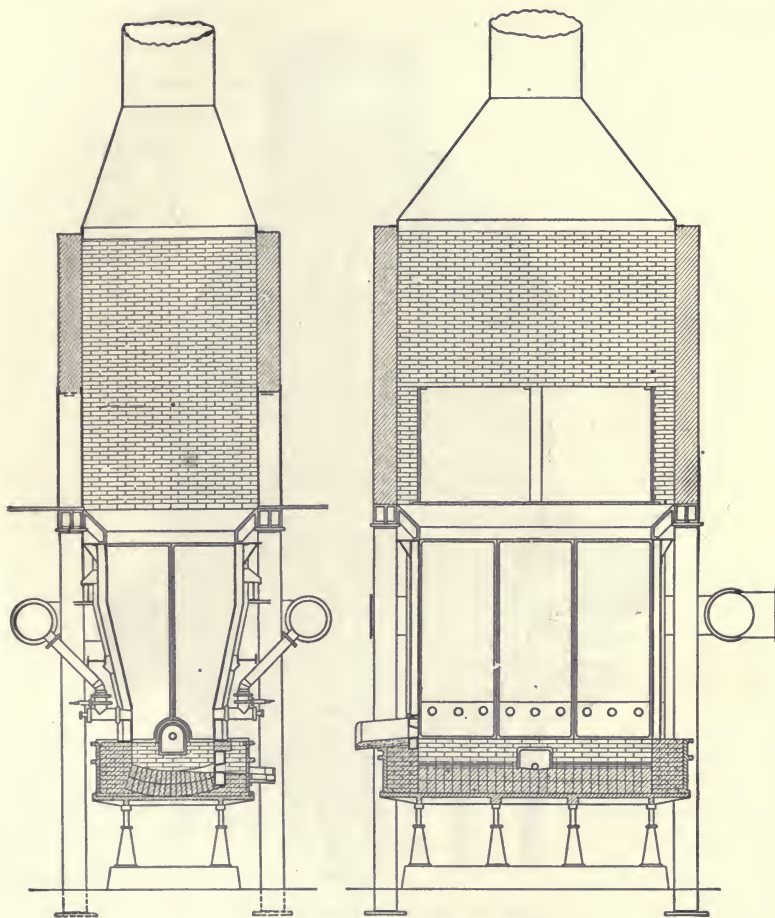

FIG. 195.—Copper-matting Blast Furnace.

section of the bed and set at a proper inclination has a slow but powerful action back and forth sufficient to dislodge the material which then rolls down within reach of the flights below. Both harrow and flight conveyor are motor-driven. Another motor advances the bridge into the bed at the desired rate or may move it backward, when it is transferred

to another bed. This is effected by a long transfer car (see Fig. 302) moving in a trench at one end.

### THE COPPER-MATTING BLAST-FURNACE

For producing matte from copper-bearing ores, whether these are to be smelted after roasting, or treated raw, by the method of pyritic

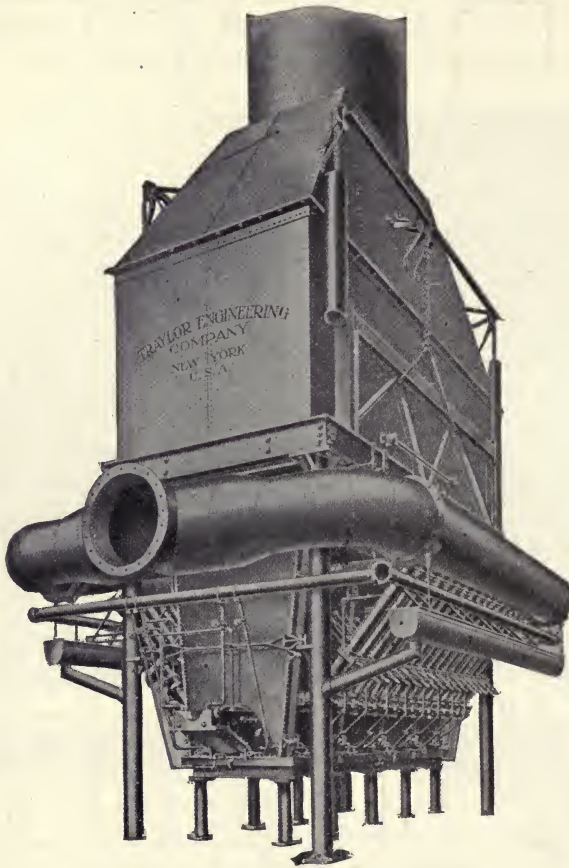

Fig. 196.—View of Copper Blast-Furnace.

smelting, we use the furnace, Fig. 190, already described, or one of the rectangular type, Figs. 195 and 196.

Fig. 195, at the left, represents a transverse sectional elevation of a furnace of 42 by 120 in. interior hearth-dimensions, having eighteen tuyeres, nine at each side, and a capacity of 150 tons of charge daily. Fig. 196 is a perspective view of a similar but larger furnace, differing from Fig. 195 in having a trapped slag-spout, more fully shown in Fig. 196.

The sole-plate of the furnace rests on jack-screws, and can be lowered and set aside when it is desired to make repairs or to clean out the furnace. It is protected from the action of the molten matte and slag by a 9-in. lining of firebrick. In Fig. 195 are seen crucible plates which rest upon the sole-plate. These are lined with 18-in. of brick. The hollow jackets filled with water, shown in Fig. 196, extend down to the sole-plate and the water-cooling is sufficient protection from the action of the molten materials. The sole-plate within the furnace, however, is covered by the brick lining. The jackets, shown separately in Fig. 197, are at least 9 ft. high, and in the furnace represented, there are two of them on each side, and one at each end. At one end the jacket is shorter, and the space below is filled with a water-cooled tap-jacket through which the slag is withdrawn. In Fig. 195 the longitudinal view shows the arrangement of a furnace with three

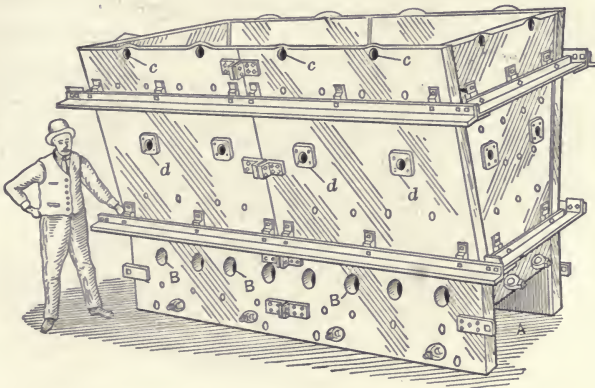

FIG. 197.—Water-jackets for Copper-Matting Blast-furnace.

jackets at each side, and two jackets at each end. The small jackets are easily handled and replaced. In Fig. 197 the inlets for water are at half the height of the bosh, and the water outlets are at highest point to keep them full of water. They are tied or clamped together with heavy angles, but in the other figures with I-beams.

A water-cooled trapped spout is used in connection with the furnace as indicated in Fig. 196. Through it flow the slag and matte. Before the slag can overflow it must fill the spout and cover the outlet or tap-hole through the jacket. It thus prevents the escape of the blast, and flows in a regular stream as fast as it forms within the furnace. The furnace shown in Fig. 195 is arranged differently. There is a spout and a water-cooled tap-jacket at the end of the furnace through which the slag is removed, while the matte, as it accumulates, is removed by a spout and a side tap-hole at the level of the crucible-bottom. In this case, the separation

between the slag and matte is affected within the furnace; in the former case, where the trapped spout is used (since matte and slag issue together) they are separated outside the furnace in the fore-hearth or settler, Fig. 199 or 195.

The transverse view, Fig. 201, shows the side-jackets. These have brackets or knees riveted to them and rest on I-beams that are secured to the columns. Thus, when the sole-plate is removed, the jackets remain in place. The distance between the side-jackets is 42 in. at the tuyeres, and 66 in. at the top. The bosh, or enlargement, is thus 12 in. on the side. Above the jackets are the cast-iron distributing plates, forming the sills of the feed-doors. The feed-doors in the opposite long sides of the furnace make it accessible from end to end, not only for feeding and trimming

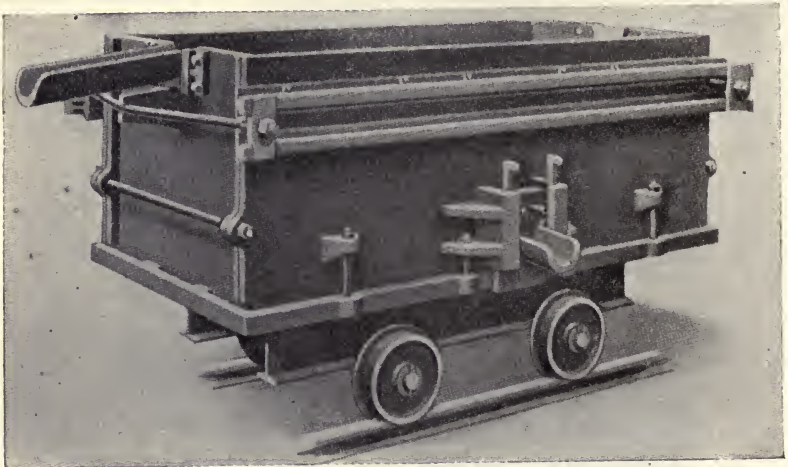

FIG. 199.—Portable Forehearth or Settler.

the charge, but for cutting with chisel-bars the accretion or scaffolding that may form on the interior surface of the jackets.

The portion of the furnace above the feed-floor level, called the stack or top, is of brick supported by a deck-plate or mantel-plate of I-beams resting on the cast-iron columns that extend down into the foundation. The upper portion of the stack is a hood of sheet-steel terminating in a pipe that extends through the roof of the furnace building. Sometimes a branch pipe leads from the hood to a dust-chamber where the dust is collected.

The bustle-pipe, by which the blast at a pressure of  $\frac{3}{4}$  to 2 lb. is brought to the furnace, extends around three sides and connects by the sheet-metal pipes to the tuyeres. The tuyere is 6 in. diameter and has a 6-in. screw-cap into which is inserted a nipple with a cap having



a mica-covered peep-hole, through which the condition of the furnace can be observed. At the branch above the tuyere is shown a slide-valve. In Fig. 196, just below the bustle-pipe, is a waste launder to receive the overflow from the jacket, and below it is a 3-in. water-supply pipe branching to each jacket, and to the water-cooled trapped spout at the front.

#### ACCESSORIES OF THE BLAST-FURNACE

**The fore-hearth**, made of cast-iron plates, 4 by 6 ft. inside dimensions, is lined with a layer of brick, and is mounted on wheels so that it can be quickly set aside and a new one put in the place when needed. The slag and matte flow into it at one end and keep it full of molten slag. At the other end the slag flows out. The matte settles on the way and collects in the bottom of the fore-hearth, and, when accumulated, is tapped at the tap-hole and spout seen at the side. Meanwhile the slag, flowing from



FIG. 200.—Two-wheeled Slag-pot.

the fore-hearth, is caught in slag-pots, Fig. 200, and taken to the edge of the dump and poured. The slag cools on the surface of the fore-hearth and forms a crust from beneath which the molten slag flows. Crust forms also at the sides and bottom, and becomes gradually thicker; and after several days becomes so thick that the molten part of the interior is too small to permit of a good separation of the matte from the slag. When this results, the fore-hearth is pried back on the wheels, and replaced by another. In the furnace, Fig. 196, at the middle side-jacket, another tap-hole furnished with a spout is seen. This is generally kept closed, but is opened when it is desired to empty the hearth of the matte and slag.

**The Slag Pot**, as shown in Fig. 200, is used for small furnaces both in making blister copper and for matting. It is hand-drawn and emptied at the edge of the dump.

**Ladle Cars.**—These are used for slag and matte in the operation of a large furnace and, as seen in 208, may be in a train drawn by an industrial locomotive.

Fig. 201 is the type of fore-hearth used for large furnaces. It lasts indefinitely. It is lined on sides and bottom with basic brick to resist the corrosive action of the slag. The slag flows into it at the back from the trapped furnace spout and escapes in a steady stream at the slag spout in front, to be taken away in a slag pot to the dump, see Fig. 210. At the side is seen the matte-tap whence from time to time the matte is tapped out into a large ladle and taken to the converter.

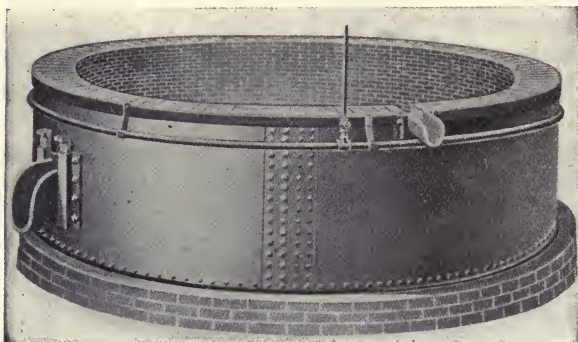

FIG. 201.—Stationary Fore-hearth.

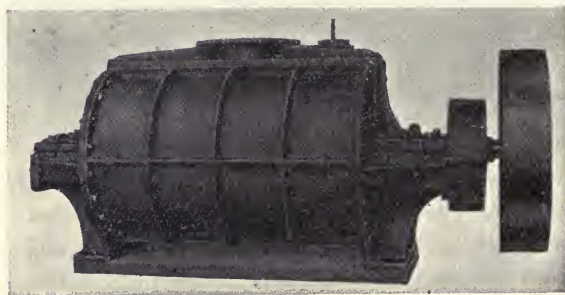

FIG. 203.—Positive-pressure Blower.

**Blowers.**—For furnishing the blast to the furnace the positive blast rotary blower is used, as shown in Fig. 203, and in section at 204. It will be seen that, by the rotation of the two impellers meshing into one another so that the air cannot escape backward between them, the air must be delivered to the furnace in a positive manner and not, as in a fan blower, be able to escape backward when the pressure rises sufficiently. The air delivered is reckoned at the displacement per revolution. If the pressure is greatly increased there is a backward leakage of air,

called the slip. Two boxed-in cut gears outside the blower keep the impellers exactly in mesh. Blowers are often direct-driven by electric motor; but the one described above is belt-driven.

### BLAST-FURNACE CONDITIONS

The diagram, Fig. 205, shows the reactions and conditions within the shaft when a furnace is smelting roasted ore with a full amount of coke. It will be understood that the furnace is full to the top with solid charge and the diagram shows the course of the descending charge and of the rising gases.

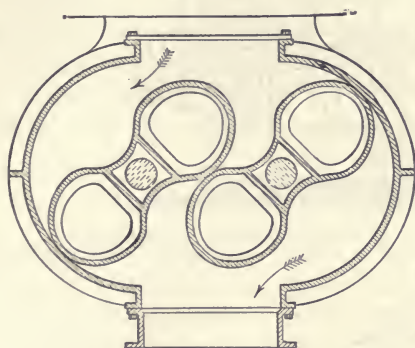

FIG. 204.—Cross-section of Blower.

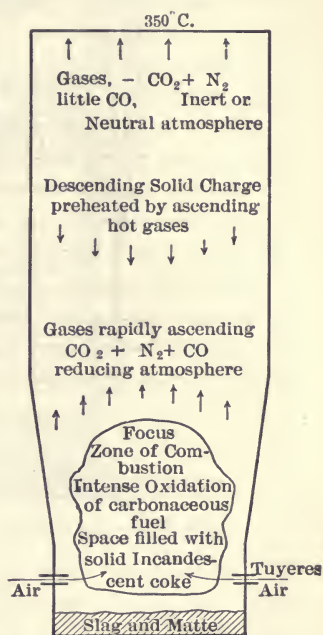

FIG. 205.—Section of Furnace in Pyritic Smelting.

### LARGE COPPER-MATTING BLAST-FURNACES

The tendency of late years has been to increase the size of copper-matting blast-furnaces. Increase in width would require higher blast pressure to drive the air to the center of the furnace; hence increased capacity had to be gained by increasing the length of the furnace. At the same time, to supply more air, the blast-pressure has been increased in some cases to 40 oz. or  $2\frac{1}{2}$  lb. per sq. in. A furnace 56 by 180 in. under these conditions smelts 400 tons of ore daily. For the matte to properly settle from the slag, with so large a flow, a cylindrical fore-hearth, Fig. 201, has been used, 16 ft. diameter by 5 ft. deep exterior dimensions, lined with hard firebrick; for a low-grade matte, basic brick is sometimes used. In the crusted-over pool of molten slag, the separation is effected. The molten contents of the furnace flow into it at one side and the slag flows out at the opposite side. From time to time the fore-hearth is tapped at



the lower tap-hole, and 5 to 10 tons of matte are drawn into a ladle, for further treatment at the converter. The lengthening of the furnace has been carried so far that, at the Washoe plant, Anaconda, Mont., a furnace 51 ft. long, having 1600 tons daily capacity, has been for some time in operation, and recently one 87 ft. long and 3000 tons daily capacity has been built and operated. The first furnace has two fore-hearths, each 16 ft. diameter and the second one three of that size.

Figs. 206 and 207 are elevations of a type of copper blast-furnace of the new plant of the Granby Cons. Co. at Anyox, B. C. It is 54 in. wide at the tuyere level and 30 ft. long. The crucible is supported upon a water-cooled base-plate, and its sloping bottom slants both ways to the trapped spout at the side. The jackets are in two tiers. The space between them widens to 6 ft. above and at the throat this is contracted to 4 ft. 6 in. At each side are feed-boxes and at the right is seen a charge-car dumping its load into one of them. When ready the charge is pushed into the furnace by a cylinder-operated plunger that forms the back of the box. It falls to the top of the charge several feet below. By varying the speed of the plunger, the cascade of ore can be made to fall nearer or farther from the opposite side, as experience suggests.

#### REGULAR OPERATION OF THE COPPER BLAST-FURNACE

**Starting the Furnace.**—Since a blast-furnace is water-jacketed the operation of warming it is a simple one. The firebrick lining of the crucible is dried and warmed by several hours' heating with a wood fire. The end and side tap-jackets are removed to permit the air to enter to the fuel. When the hearth is hot the wood ashes are scraped out and a fresh fire of wood, filling the crucible a foot deep, is started, wood of uniform sized pieces for uniform burning being selected. Upon the wood is placed charcoal, and upon the charcoal coke; until the surface is  $1\frac{1}{2}$  to 2 ft. above the tuyeres. The fire is increased uniformly and regulated by checking the draft at the front and admitting air at the rear as required. When the coke is thoroughly ignited, the furnace is ready for charging. The brick-lined fore-hearth, Fig. 201, is warmed while warming the furnace. The wood is placed carefully against its walls, leaving the center clear for the air to reach the fuel, so that the burning may proceed actively. As the wood burns, charcoal and ashes accumulate, and are shoveled out, since otherwise they form a layer through which the heat does not penetrate.

Suppose the charge of ore and flux to be 2000 lb., and that we intend, as in regular work, to use with it 12 per cent coke or 240 lb. per charge. We put in a layer of 240 lb. coke, then one of 500 lb. slag. This is followed by a half dozen charges each of 240 lb. coke alternated with 1000 lb. slag. Next we put in a half dozen charges of 240 lb. fuel and 2000 lb. slag, so

that the slag when melted shall entirely fill the fore-hearth. We now begin feeding the regularly calculated charges and required fuel. At this time the blast is admitted, gently at first, and increasing during a half hour, after which the furnace should be in full blast. Extra men should now assist in charging to rapidly fill the furnace. At the slag-floor, before the blast is turned on, the tap-jackets and the tapped spout are put in place, and all openings closed with a clay plugging mixture. This may be obtained from a neighboring bank if of suitable quality, or may be made from coarsely ground fire brick mixed with clay.

As the smelting proceeds, by looking into the tuyeres, we see that the slag is rising to their level. We then open the tap-hole and permit the slag to flow into and quickly fill the fore-hearth. The excess steadily overflows to the slag-pots set to catch it, or it may be granulated and removed by water.

When feeding the furnace, care is taken to distribute the charge evenly, not feeding coarse ore in one place and fine in another. Unless we exercise care in this regard we have irregular operation, blast and flame coming up in one place and the charge looking dead in another. When this begins to occur we load the active places with charge, feed lightly, and use coarser material where there is little action.

We may adopt either the intermittent or the continuous method of removing the slag from the furnace. In the intermittent method, as arranged in Fig. 195, the slag is tapped from time to time as it accumulates as already described, taking care that it does not gather in such quantity as to rise to and run into the tuyeres, or to "slag" them, as it is called. By the continuous method, the slag and matte flow continuously from the furnace through the trapped or open spout, see Fig. 196. The molten products enter a fore-hearth and the separation of slag from matte is there made.

Referring to the view of a smelting plant, Figs. 190 and 191, the furnace being filled to the feed-doors, we have a 7-ft. smelting column (distance from tuyeres to feed-door). As the charge smelts and the molten materials are withdrawn, the surface gradually sinks, making room for further additions. The coke is first added in a layer over the surface, and upon it is spread the weighed charge. The air, under pressure from the blowers, driven into the furnace at a pressure not less than  $\frac{3}{4}$  lb. or 12 oz. per square inch, burns the descending coke mostly at the tuyeres. The resulting gas with the sulphur dioxide from the burning sulphur in the charge appears as a whitish smoke mingled with dust mechanically carried. This passes from the furnace-top directly into the air, or to a dust-chamber and thence to the stack. The sulphur remaining unites with the copper and a part of the iron and forms a matte or copper-iron sulphide. The matte, in forming comes into contact with the gold and silver contained in the ore of the

charge and absorbs them. The coke reduces the iron not needed for the formation of the matte to ferrous form, and the ferrous iron, with the lime, alumina, and other bases, combines with the silica to form a slag, fluid at the high temperature prevailing at the tuyeres.

The molten slag and matte flow from the furnace to the fore-hearth where the separation is effected, and the supernatant slag, freed from matte, escapes by an overflow spout, and is received into slag-pots and conveyed to the dump, see Fig. 208. Another means of disposing of the slag is to allow the stream of slag from the fore-hearth to fall into a launder and be caught by a horizontal jet of water to break it into drops and cool it in granules about wheat-size. The granules are carried away by the water, in a cast-iron lined launder to the dump. The matte is



FIG. 208.—Pouring Slag.

tapped from the fore-hearth as it accumulates, through a tap-hole near the bottom, and flows over the matte spout shown at the right of the transverse section, Fig. 195.

#### COPPER MATTE

Matte is an artificial sulphide formed in smelting as a result of the union of sulphur with bases. Iron sulphide ( $\text{FeS}$ ), such as is used in the making of hydrogen sulphide in the laboratory, is the simplest form. To produce it in small quantities, a covered assay crucible may be filled with shingle-nails and brought to a white heat in a wind-furnace and roll-sulphur added gradually until the content fuses. The sulphide is then poured, and broken for use. In smelting a charge containing sulphur, scrap-iron will take up the sulphur and form matte. If copper oxide or copper sulphide is present in the charge, the sulphur takes the copper to form the matte in preference to taking the iron. When the copper is exhausted, the excess of sulphur expends any combining power that may remain by taking iron. We thus have a copper-iron sulphide, called copper matte. If lead or nickel are present in the charge, they partly enter the matte. Magnetic iron oxide, taken from the charge, also enters the matte. Thus we get, finally, a complex compound, as the following table shows:

## COMPOSITION OF COPPER MATTE

	Cu, Per Cent.	S, Per Cent.	Fe, Per Cent.	FeO <sub>4</sub> , Per Cent.	Sp. Gr.
Reverberatory furnace (Anacōnda, Mont.)..	60.76	23.25	11.43	1.13	5.4
Reverberatory furnace (Butte, Mont.).....	29.41	23.70	25.35	12.60	4.8
Blast-furnace (Butte, Mont.).....	36.15	23.38	24.97	8.51	5.1
Blast-furnace (Jerome, Ariz.).....	55.00	23.96	13.85	2.58	5.3
Blast-furnace (Elizabeth, Vt.).....	21.36	22.95	41.03	10.44	4.7
Blast-furnace (Sudbury, Canada).....	24.54	23.24	28.65	7.32	5.1

Sudbury matte contains also 15.56 per cent nickel replacing copper. It will be noted that the percentage of sulphur (23 to 24) is approximately the same in all cases.

**Melting-point of Mattes.**—32.6 per cent, 875° C.; 49.7 per cent, 955°; 61.2 per cent, 1070°; 71.1 per cent (white metal), 1121°, 5 Cu<sub>2</sub>SFeS; 80.1 per cent (pimple metal), 1098° remaining after separating bottoms; metallic copper, 1083°. Bottoms contain Cu, 60 per cent, Pb 33 per cent.

## COPPER-FURNACE SLAGS

Variation in slag composition is permissible in copper-smelting, the requirement being that the slag be fluid to flow from the tap-hole of the furnace. Slags having the maximum content of silica and of bases, as shown below, are employed successfully in the blast-furnace.

In silver-lead smelting practice, such variations are not allowable. Slags varying from the composition found in practice to be satisfactory, even though they be fluid and run well, carry off both lead and silver. In copper practice such slags would be clean and free from copper.

## THE COMPOSITION OF SLAGS

	SiO <sub>2</sub> , Per Cent.	FeO, Per Cent.	Al <sub>2</sub> O <sub>3</sub> , Per Cent.	CaO, Per Cent.	MgO, Per Cent.	ZnO, Per Cent.	BaO, Per Cent.
Minimum.....	20	2	2	2	0	0	0
Maximum.....	57	70	18	40	8	20	42

A slag low in silica could not carry much of the alkaline-earth bases, and would be high in iron, and of a specific gravity over 3.7. A silicious slag would work well with a heavy limy base, and would have a specific gravity of 3.5. Since the separation of slag from matte results from the difference in specific gravity of the two substances, we expect a better separation the lighter and more silicious the slags. Matte takes up zinc sulphide, where much is present, and becomes lighter, so in this respect, zinc is detrimental to effective separation.



CALCULATION OF CHARGE FOR MATTE SMELTING

A low sulphur charge may consist of roasted ore, oxidized copper-ore and silicious ores containing gold and silver. The requirement is that the charge contain copper-bearing ore, and enough sulphur to form with the copper a suitable matte that will take up the gold and silver that the charge contains. Enough flux is added to the charge to make a suitable slag, and 10 to 15 per cent coke or charcoal to smelt the mixture.

The products from the furnace are slag and matte, the former being the result of the union of the silica of the charge and the fuel, with the bases that are present. A part of the sulphur in the charge is volatilized by the heat of the furnace, but a large part, still remaining, combines with the copper and a part of the iron, to form the complex sulphide called matte. The iron not needed for the matte enters the slag. Since the copper-furnace slag may vary within wide limits, we use a silicious ore where silica is abundant and a basic one where plenty of iron is present, or in treating basic ores.

CHARGE-SHEET. REGULAR MATTE SMELTING

Name of Ore.	H <sub>2</sub> O.	WEIGHT.		Cu.		SiO <sub>2</sub> .		Fe + Mn.		CaO + MgO		S.	
		Wet.	Dry.	Per Cent.	Wt.	Per Cent.	Wt.	Per Cent.	Wt.	Per Cent.	Wt.	Per Cent.	Wt.
Roasted ore....	3.0	1030	1000	10.0	100	25.0	250	30.0	300	...	...	10.0	100
Limestone.....	0	....	300	...	...	4.2	12	...	...	52.0	156		
Coke (10 per ct)	0	....	130	...	...	7.2	9	1.2	...	1.8	2		
					100		271		302		158		100
			Cu in. slag =		4		For matte =		129				25
			Cu in matte =		96		For slag =		173		S in matte =		75
			Cu and Fe in matte =		225								3
			Fe in matte =		129						Cu and Fe in matte =		225

Slag.	In the Slag.	Matte.
SiO <sub>2</sub> = 35 per cent.	FeO = $173 \times \frac{9}{7}$ = 222	S = 23 per cent.
FeO + CaO = 55 per cent.	CaO = 158	Cu + Fe = 69 per cent.
Other bases = 10 per cent.	Actual FeO + CaO = 330	$\frac{Cu + Fe}{S} = \frac{69}{23} = 3$ (factor).
100 per cent	Needed = 425	
	CaO too little = 45	

$$\frac{FeO + CaO}{SiO_2} = \frac{55}{35} = 1.57 \text{ (factor) and } 271 \times 1.57 = 425 \text{ of FeO + CaO.}$$

Above is given a charge calculation, in which the problem is to treat a single roasted ore, producing a slag of predetermined composition, and a matte that will take up the copper that is present. Limestone is the only flux to be used. The charge is of a size to fill the charge-car or buggy in which it is brought to the furnace.

We will adopt 1000 lb. as a weight of the roasted ore, having the composition Cu 10 per cent, SiO<sub>2</sub> 25 per cent, Fe 30 per cent, and roasted so

that 10 per cent sulphur remains. This is to be smelted with limestone containing  $\text{SiO}_2$  4 per cent and  $\text{CaO}$  52 per cent to produce a slag of  $\text{SiO}_2$  35 per cent and bases ( $\text{FeO}$  and  $\text{CaO}$ ) 55 per cent, together 90 per cent, leaving 10 per cent to allow for other elements. The slag has been chosen of this composition as one that has been found to work well. The coke has 12 per cent ash that consists of  $\text{SiO}_2$  60 per cent,  $\text{Fe}$  10 per cent, and  $\text{CaO}$  15 per cent. These figures, calculated to the coke, are  $\text{SiO}_2$  7.2 per cent,  $\text{Fe}$  1.2 per cent, and  $\text{CaO}$  1.8 per cent.

A metallurgist, accustomed to types of ore, knows approximately how much flux he needs. Suppose we decide upon 300 lb. flux. For the calculation we enter on the charge sheet the 1000 lb. ore, the 300 lb. limestone, and 10 per cent of these or 130 lb. coke in the column of dry weight. When the exact figures have been computed, the wet weights may be inserted in the adjoining column, using the figures for per cent given in the column marked  $\text{H}_2\text{O}$ . The percentage of ore, flux, and fuel are then written in the appropriate columns, and the corresponding weights, calculated to the nearest pound, are written in and the totals added.

Beneath, and at the left of the sheet, tabulate the slag composition. Find the ratio of base to silica, which in this case will be 1.57 to 1. On the right of the sheet write the matte composition. We know it will carry 23 per cent sulphur, and roughly 69 per cent copper and iron. Also find the ratio of sulphur to base, which here is 1 to 3, or the factor 3.

Let us first consider the sulphur. Experience shows that in regular matte smelting we can depend upon a loss by volatilization of 20 to 40 per cent sulphur. We take 25 per cent as an average, and thus 75 per cent of the sulphur is left to form matte. This is 75 lb., and multiplied by the factor 3 indicates that 225 lb.  $\text{Cu}$  and  $\text{Fe}$  together are needed to satisfy the sulphur.

The slag produced is calculated by dividing the weight by the per cent of silica, expressed decimally, or  $271 \div 0.35 = 770$  lb. Allowing 0.5 per cent copper for the slag (and in good work it should not exceed this, the weight so lost is 4 lb., leaving 96 lb. to enter the matte. Subtracting this weight of copper from the total 225 lb. of copper and iron together needed for the matte, we get 129 lb. iron entering the matte, out of the total 302 lb. in the charge. The remainder (173 lb.) is available for the slag. But the iron existing in the charge as ferric iron is reduced to ferrous form, and we have, in the ratio of atomic weights, 56 parts  $\text{Fe}$  equal 72 of  $\text{FeO}$ , or 173 lb.  $\text{Fe}$  equal 222 lb.  $\text{FeO}$ . To this we add the 158 lb.  $\text{CaO}$ , making 380 lb. of the two bases. Multiplying the silica (271 lb.) by the factor 1.57 we find we need 425 lb. of the bases  $\text{FeO}$  and  $\text{CaO}$ , so that we have a deficit of 45 lb. Now, since the limestone consists approximately half of  $\text{CaO}$ , we need to add 90 lb. limestone to the charge, making in all 390 lb. as the required amount. Erase where needed, and re-calculate the charge.

throughout. This time we should come within a few pounds of the correct amount. As long as it is within 10 lb. it is close enough, since variations in the ores, imperfect weighing, and variation in the amount of sulphur volatilized easily exceeds such differences. When, by experience, we have learned the actual percentage of volatilization we substitute it for that above assumed. The actual percentage of copper and iron in the matte is taken in the same way.

The grade of the matte in copper is learned from the ratio of the sulphur (75 lb.) to the copper (96 lb.) or 23 to 29 per cent. In the same way we compute from the respective weights the percentage of  $\text{SiO}_2$ ,  $\text{FeO}$  and  $\text{CaO}$ , their aggregate being 90 per cent.

The metallurgist seldom can count on the slag and matte coming from the furnace precisely as calculated. There is a little variation due to the causes already mentioned. When the slag from a newly calculated charge comes down, a sample should be taken and a rapid determination made for  $\text{Cu}$ ,  $\text{SiO}_2$ ,  $\text{FeO}$ , and  $\text{CaO}$ . As an approximate rule, to increase an ingredient of the charge a given percentage, add to it the fractional part expressed by its ratio to the remainder of the 100 per cent. Thus, if analysis gives 33 per cent and we wish to increase it to 35 per cent, then to the  $\frac{2}{3}$  of 271 = 16.4 lb. add  $\frac{33}{7}$  ( $\frac{1}{2}$ ) of 16.4 lb., making the total silica to be added 25 lb.

#### PYRITE MATTE SMELTING

This consists in treating in a blast-furnace, such as that shown in Fig. 196, sulphide ore consisting largely of pyrite and chalcopyrite. The ore carries gold and silver, which are recovered in the copper-bearing matte produced. No preliminary roasting is given the ore, and the smelting is conducted in such a way that 70 to 80 per cent of the sulphur is burned in the furnace while the remainder, uniting with iron and the copper, forms the matte which acts as collector for the gold and silver. A slag is formed from the silica of the gangue and the bases of the ore and flux. At times when the quantity of base, especially iron, is large it is necessary, in order to make a suitable slag, to add silicious ore. The matte and slag flowing together from the furnace separate in the fore-hearth.

It will be noticed that the slow and expensive preliminary roasting of the sulphide ores is obviated, and that the amount of fuel needed is small (1.5 to 6 per cent) because of the heat developed by the burning of the sulphide. Pyrite or chalcopyrite contains iron that is available both for matte and slag, and when the matte can spare it for the slag the iron serves to flux the silica of iron-free ores on the charge. Iron ore or limestone acts in the same way, and either of them, though generally the latter, may be added for the purpose.

An iron matte alone does not entirely collect the gold and silver from

the ore-charge, and it has been found that copper, to the extent of 0.5 per cent or more, should be present to insure the collection of these metals in the matte. The slag then will be nearly free from the precious metals. Copper, therefore, acts as an efficient collector.

As a result of burning 70 to 80 per cent of the sulphur of the charge, there remains only 30 to 20 per cent to form matte. The remaining sulphur first takes up copper, for which it has a greater affinity than for iron. It is the burning off of the large amount of sulphur that enables one to dispense with roasting and to diminish the amount of matte produced. The matte produced per ton of ore, or the matte-fall, may be expressed as a percentage, or as a concentration of so many tons into one of matte. Thus, with a production of 200 lb. matte per ton of ore, we have a 10 per cent matte-fall, or a concentration of 10 into 1. It is desirable to concentrate the ore into a small bulk of matte. To show how much concentration is effected, both in regular matte smelting and in pyrite smelting, we enter upon the following considerations:

**In regular smelting** (with a charge containing 8 per cent sulphur, the volatilization-loss being 25 per cent, and the matte to contain 25 per cent sulphur), we have from 100 lb. ore 75 per cent of 8 per cent = 6 lb. sulphur to form matte. This makes 24 lb. matte and results in a concentration of 4.2 into 1.

**In pyrite smelting** with a charge containing 30 per cent sulphur, the volatilization loss being 80 per cent and the matte still to contain 25 per cent sulphur, we have from 100 lb. of ore 20 per cent of 30 per cent = 6 lb. of sulphur to form matte. This makes 24 lb. of matte, the same concentration as in the regular matte smelting just specified.

It will be noted that the percentage of volatilization, or the amount of sulphur burned, varies with the charge. It is low when only roasted or oxidized ores are used, and high for raw or unroasted ores, especially those containing pyrite. A defect inherent in pyrite smelting is the difficulty of regulating this loss. When the furnace, which is burning the right amount of sulphur, begins to run slow from any cause, the volatilization may increase to the point of burning the entire content of sulphur, so that no matte is produced. On the other hand, when the furnace begins to run fast, much matte, low in copper, is produced. The principal difficulty in pyrite smelting is the regulation of the matte-fall.

#### REACTIONS IN PYRITE MATTE SMELTING

Fig. 209 is a cross-section of a matting blast furnace smelting a pyritic charge, and consisting of sulphide ores with the addition of enough quartz or silicious ore to make a suitable slag. With this charge 3 per cent of coke is used, but this does not interfere with the reactions.

At the surface of the charge, which is maintained at 12 ft. above the tuyeres, where the temperature may be at  $250^{\circ}\text{C}$ ., the heat drives off from the  $\text{FeS}_2$  a portion of its sulphur, leaving as  $\text{Fe}_3\text{S}_4$ . The escaping sulphur fume, encountering the air entering the feed-door, burns with the characteristic blue flame to  $\text{SO}_2$ .

By the time the charge has gone down 5 ft. in the furnace where the temperature is much higher, more sulphur has been expelled, leaving  $\text{FeS}$ .

At 7 ft. down, and at a temperature of  $925$  to  $950^{\circ}\text{C}$ ., dissociation continuing, we find  $\text{Fe}_5\text{S}_4 = 4\text{FeS} + \text{Fe}$ , or a condition in which four equivalents of  $\text{FeS}$  hold one of  $\text{Fe}$  in solution, so that, if a sample of the compound in a molten condition could be withdrawn from the furnace we would find iron separating from the iron sulphide on cooling.

The  $\text{Fe}_5\text{S}_4$  at this zone begins to melt and falls, entering the silicious, porous structure or "nucleus" shown above and below the tuyeres in Fig. 209.

Within this porous structure the downward trickling sulphide is encountering the rising air according to the reaction

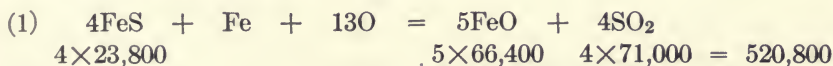

This is equivalent to 1874 pound-calories per pound of iron present.

The forming  $\text{FeO}$  at once unites with the silica present to form a molten slag which continues its journey to the crucible. The rising gases, intensely heated as the result of the reactions, expand, keeping the nucleus porous. The ore-column, therefore, instead of resting on a bed of burning coke in the crucible as in regular matte smelting, is sustained upon a network of quartz pieces constituting the nucleus, and which have thus far escaped slagging. The nucleus extends from the crucible upward to the zone of fusion of the iron sulphide 5 ft. above the tuyeres, having its greatest development at or about the tuyeres. At the sides of the furnaces the network is moving slowly downward, and is sustaining the portion which is descending regularly.

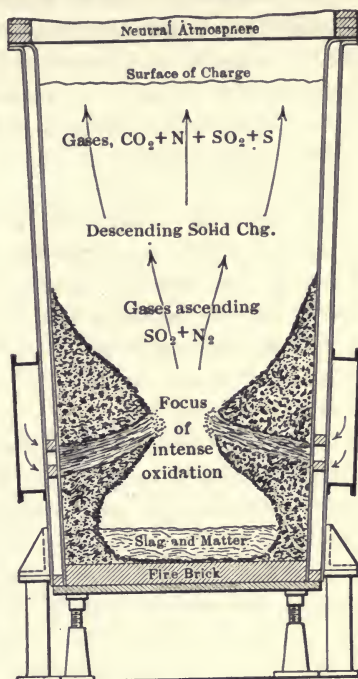

FIG. 209.—Section of Furnace in Pyritic Smelting.

Generally not all the FeS is oxidized, but a part, together with any copper sulphide present, forms matte and in molten condition seeks the crucible.

In a regularly working furnace producing its equivalent slag, this slag is, within limits, not changed in composition by a change in the amount of silica. It must be understood that the addition of silica has the effect of increasing the degree of concentration, that is, of raising the grade of the matte. There is then more iron oxidized and slagged off, but the effect is not to make the slag more irony, but simply to increase its quantity. If too much silicious ore is added, the excess remains undigested and chokes the furnace. If too little is added, the amount of matte increases while its tenor in copper becomes less, and at the same time the amount of slag decreases, but without altering its composition. Considered in another way, the pyrite furnace chooses its own slag.

As compared with other kinds of smelting, an abundance of air should be supplied to the furnace, not less than 300 cu. ft. to 1 lb. of sulphur present in the charge.

At Mt. Lyell, Tasmania, where great success has been attained in pyritic smelting, two parts of heavy sulphide ore containing 2 to 2.25 per cent Cu are used to one of silicious ore of 70 per cent  $\text{SiO}_2$  with a concentration of 18 to 20 parts into one, producing a matte containing 40 per cent Cu. Of the large amount of iron present 95 per cent is burnt or oxidized, the small remainder going into the matte. Under given conditions, a rise from 95 to 96 per cent of iron oxidized results in an increase in the grade of the matte to 50 per cent Cu.

The porous condition of the nucleus is practically preserved as the result of the reactions there taking place, while it is the duty of the metallurgist to see that such loose and porous condition is suitably maintained elsewhere in the shaft of the furnace, which must be kept properly open both below and above this fiery net-work. The proper maintenance of this condition is one of the principal secrets of success in order to avoid freeze-ups and to use the minimum amount of coke.

**Pyrite Smelting in Two Stages.**—For low-grade ores, carrying 2 per cent copper, for example, a concentration of ten into one gives matte of 20 per cent copper. By roasting the matte, or by smelting it pyritically, it is possible to increase the grade to 40 per cent or more, and this product can be treated in the copper-converter and brought to the grade of blister-copper. An ore containing 5 per cent copper can be smelted to give a matte of 40 per cent copper, so that the second smelting with the additional expense can be omitted. Now while it would not pay to smelt a copper ore of a grade as low as 2 per cent copper, for the copper alone, if the ore contained gold and silver the recovery of these metals would justify the expense of smelting.

**Two-stage Smelting at Ducktown, Tenn.**—At the works of the Tennessee Copper Co., the process is a two-stage one, the ore being smelted to give matte of 10 per cent Cu (“ore-smelting”), this matte being re-treated in another furnace to produce a 35 to 45 per cent matte (“matte-smelting”). The slag from the second furnace, not yet sufficiently clean to throw away, is remelted in the first furnace. The second matte is then converted to blister-copper of 98 per cent.

The furnaces (of the type shown in Fig. 196) are 196 in. long by 56 in. wide at the tuyere level, and have large circular fore-hearths, 16 ft. outside diameter by 5 ft. deep, lined with chromite brick to resist the corrosive action of the low-grade matte produced. The first, or ore-furnace, treats 400 tons of charge daily, with a coke-consumption of 2.1 per cent. The second or concentration furnace smelts 280 to 300 tons of matte, using 3.5 per cent coke. The following charge-sheet gives details regarding the charge and the matte produced in both the stages, and shows how such charges are computed in pyritic smelting.

CALCULATION OF CHARGE IN PYRITE SMELTING

**First Stage, the Ore Charge.**—In these calculations the quantity of coke is so small that no computation is required for the ash. The quantity of base in the ore is so large, and the silica is so low that it has been necessary to add silicious material (in this case quartz-rock) to the charge in order to obtain a slag of 35 per cent silica. The problem is to compute the amount of quartz to be added to give such a slag.

CHARGE SHEET I. ORE-SMELTING FURNACE.

Name of Ore.	WEIGHT.		H <sub>2</sub> O.	Cu.		SiO <sub>2</sub> .		Fe + Mn.		CaO + MgO		S.	
	Wet.	Dry.		Per Cent.	Lb.	Per Cent.	Lb.	Per Cent.	Lb.	Per Cent.	Lb.	Per Cent.	Lb.
Polk Co. ....	.....	1000	.....	2.4	24	20.7	207	34.2	342	9.2	92	20.4	204
Burra-Burra. ....	.....	3000	.....	2.1	63	9.4	282	38.0	1140	8.3	249	30.3	909
Quartz. ....	.....	700	.....	.....	.....	97.0	679	.....	.....	.....	.....	.....	.....
Coke. ....	100	.....	.....	.....	87	.....	1168	.....	1482	.....	341	.....	1113
				Cu in Slag = 6						Volatilized = 890			
				Cu in matte = 81						In slag = 43			933
										Matte =			180

Slag  
 SiO<sub>2</sub> = 35.0 per cent.  
 FeO + CaO = 55.0 per cent.  
 S = 1.3 per cent.  
 Cu = 0.2 per cent.  
 Slag = 1168 ÷ 0.35 = 3300  
 Factor  $\frac{35}{55}$  = 0.636

Matte  
 Fe + Cu = 65 per cent.  
 S = 25 per cent.  
 $\frac{Cu + Fe}{S} = 2.6$

We represent on the charge sheet the ores that are to be run, using amounts in accord with the rate at which the respective ores are supplied

(1000 lb. Polk county ore and 3000 lb. Burra-Burra ore). Experience shows that for such a charge and for the quantity of ferrous iron and lime present, we may enter the quantity of silicious material as 700 lb. We use a slag of 35 per cent  $\text{SiO}_2$  and 55 per cent  $\text{FeO}$  and  $\text{CaO}$ , making in all 90 per cent. With this slag, experience shows we may figure on 1.3 per cent sulphur and 0.2 per cent copper for this low-grade matte. A little zinc, when that element is present in the charge, also enters the slag. This is shown to be 0.3 per cent.

The percentage of ingredients of the charge is written and carried out in the respective columns, and the columns are added.

Beginning with the sulphur, of the 1113 lb. present, we have:

	Lb.
Sulphur volatilized (80 per cent of the total).....	890
Sulphur in the slag (1.3 per cent of 3300 lb.).....	43
Sulphur left for the matte.....	180
	<hr/>
	1113

The matte is assumed to contain 25 per cent sulphur, 65 per cent copper and iron, and 1.7 per cent zinc. We estimate that 80 per cent of the zinc will be volatilized. It is understood that in smelting other ores than these, the actual quantities of the different elements in the matte and slag will be determined and those figures substituted for the ones above.

Of the copper, 0.2 per cent of 3300 lb. or 6 lb. goes into the slag, leaving 81 lb. for the matte. Multiplying the sulphur for the matte, 180 lb., by the factor 2.6 we get the total Fe and Cu needed for the matte, 468 lb.; subtracting Cu for matte, 81 lb.; leaves Fe for matte, 387 lb.

But the total iron in the charge is 1482 lb., so that we have:

	Lb.
Fe in matte.....	387
Fe left for slag.....	1095
	<hr/>
Total.....	1482

The iron in the slag occurs as  $\text{FeO}$ , so that we must take 1408 lb.  $\text{FeO}$  equivalent to the 1095 lb. Fe. Adding to this the  $\text{CaO}$ , 341 lb., we get  $\text{FeO} + \text{CaO} = 1749$  lb., which multiplied by the factor 0.636, gives  $\text{SiO}_2 = 1112$  lb.

	Lb.
Actual silica in charge.....	1168
Silica needed.....	1112
	<hr/>
Silica in excess.....	56

By erasing the trial amount 700 lb. of quartz, and substituting 650 lb. then recalculating the charge, we get an approximation within 10 to 20 lb., which is accurate enough for practical purposes. The percentage of copper



in the matte is computed according to the proportion 159 : 81 :: 25 per cent : 10.4 per cent.

**Second Stage, Matte Concentration.**—This is run with slag from the converting operation, and quartz ore in sufficient quantity to produce a slag of the same composition as that of the ore-charge, except that it has 1 per cent of sulphur and 0.7 per cent copper.

CHARGE SHEET II. MATTE-CONCENTRATION FURNACE

Name of Ore.	WEIGHTS.		H <sub>2</sub> O.	Cu.		SiO <sub>2</sub> .		Fe + Mn.		CaO + MnO		S.	
	Wet.	Dry.		Per Cent.	Lb.	Per Cent.	Lb.	Per Cent.	Lb.	Per Cent.	Lb.	Per Cent.	Lb.
Matte.....	....	3000	....	10.0	300	...	...	55.0	1650	...	...	25.0	750
Quartz.....	....	1400	....	...	...	97.0	1358	...	...	...	...	...	...
Limestone.....	....	200	....	...	...	4.0	8	...	...	53.0	106	...	...
Convert slag.....	....	400	....	2.0	8	30.0	120	55.0	220	1.0	4	1.0	4
Coke.....	100												
					308		1486		1870		110		754
				Cu in slag =	30					Volatilized =	530		
				Cu in matte =	273					In slag =	43		573
													181

Slag  
 SiO<sub>2</sub> = 35.0 per cent.  
 FeO + CaO = 55.0 per cent.  
 S = 1.0 per cent.  
 Cu = 0.7 per cent.

Slgn = 1486 ÷ 0.35 = 4300 lb.  
 Factor  $\frac{35}{55}$  = 0.636.

Matte  
 Fe + Cu = 65 per cent.  
 S = 25 per cent.  
 $\frac{Cu + Fe}{S}$  = 2.6

The charge is estimated as in "Charge Sheet I," with a volatilization of 70 per cent of the sulphur, as experience has shown the result commonly to be. In the matte we have:

S.....	Lb. Per Cent.	181 = 25.0
Cu.....		278 = 83.4
(181 × 2.6) - 278 = Fe.....		193 = 26.6
		<hr/>
		652 = 90.0

Proceeding with the calculation for the quartz we have:

Total iron.....	Lb.	1870
Iron in matte.....		193
		<hr/>
Iron for slag.....		1677

or FeO = 2157, and the total base is 2266 lb.

This gives the silica needed, 2266 × 0.636 = 1509 lb. But we have already 1486 lb., and the difference may be made up by increasing the quartz 20 lb.

**Concentration of the Matte.**—In an example above, we obtained a matte 10 per cent in copper, and with copper low in the charge, the per-

centage may be even less. The matte is of too low grade to ship away, or to bring to the grade of blister-copper in a converter. It must be concentrated to one of higher grade. If we were to heap-roast the matte and then smelt it with silicious ore in a blast-furnace, we should obtain a small quantity of matte of a high grade.

There is, however, the expense and delay of the roasting to consider, and it has been sought to smelt the matte raw, with silicious ore, with the idea of burning off the sulphur in the blast-furnace. In regular matte-smelting, were this attempted, the matte would run through little diminished in quantity and little changed in grade, but by the new method, using little fuel, an abundant blast, and silicious slag, the concentration can be obtained.

#### DISPOSAL OF THE SLAG

The slag from a blast-furnace, being a waste material, is disposed of in the cheapest way possible. In the case of small furnaces, as it flows

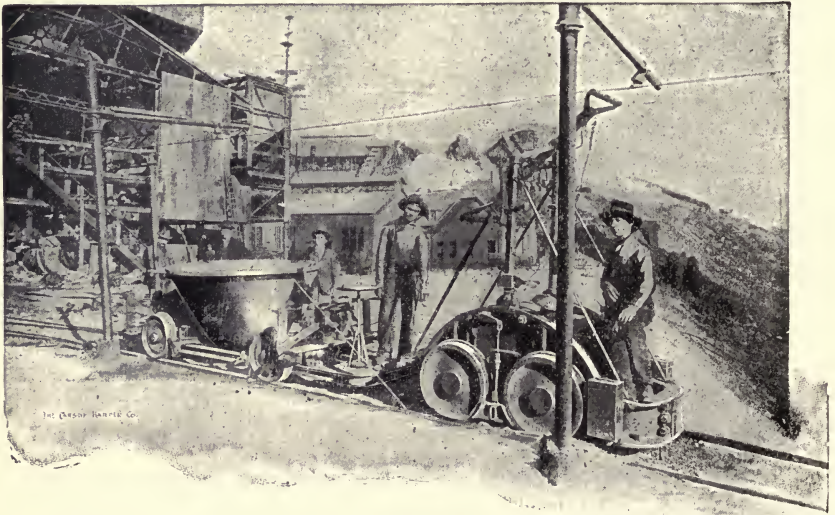

FIG. 210.—Electric Trolley System (removing slag-pot).

from the fore-hearth, it is caught in wheeled slag-pots (slag-carts), Fig. 200, that are taken to the edge of the slag-dump when filled and poured. As the dump grows the expense increases, and large slag cars, Fig. 210, are used. The cars are moved either by horses, or an industrial locomotive, or by trolley.

Another cheap and favorite way is to granulate the slag. To do this a cast-iron launder is arranged to receive the slag as it falls from the spout

of the fore-hearth. The launder has a grade of 1 in. to the foot, and through it water is made to flow constantly. In addition, a horizontal flattened jet of water strikes the falling slag, instantly cooling and breaking it into granules of various sizes averaging  $\frac{1}{16}$  in. in diameter. The flow of water carries the slag to the dump.

#### BLAST-FURNACE VS. REVERBERATORY SMELTING

Predictions have recently been made that the reverberatory was bound to supplant the blast-furnace, because of the advantage the former possessed in the treatment of the finer ore and flotation concentrates. It is pointed out, however, that where ore is coarse, and where it is possible to avoid roasting, the blast-furnace has its advantages even for sulphide ores.

"There is no doubt that at the moment, in favored localities where pulverized coal or fuel-oil can be obtained at a much cheaper rate than coke, the reverberatory has the better of the argument, but there is always something turning up in favor of the other side in every controversy. It resembles the perpetual fight between armament and projectiles that we are all much more familiar with at present than we were prior to 1914.

"Both styles of furnaces have their field, but for the moment, owing to the great increase in tonnage treated by oil-flotation and the improvements in reverberatory practice, the reverberatory seems to be gaining materially in tonnage treated.

"The latest improvement in blast-furnace practice is the introduction of pulverized coal at the tuyeres, the notable examples of this being the Tennessee Copper Co. smelter and the International Nickel-Co.'s plant at Copper Cliff, Ont. If the experiments now being tried at various plants, besides the two mentioned, prove that pulverized coal can be used economically in the blast furnace, either with or without a proportion of coke, the probabilities being that a certain proportion of coke will be necessary, the existing interest in blast-furnace practice will receive an impetus.

"The new plant being erected in Chile for the Braden Copper Co. contemplates the use of the blast-furnaces entirely, using nodulizing-furnaces to prepare the charge. To-day it is about a stand-off in cost between nodulizing or sintering for blast-furnace practice and roasting for reverberatory practice."\*

**Methods of Reverberatory Smelting.**—The essentials for successful reverberatory practice are self-fluxing ores, cheap fuel, and cheap silica brick, whereas for blast-furnace practice the charge may be more refractory, but must be either sintered, nodulized or come naturally in lumps, and in addition the fuel and power must be comparatively cheap.

While the blast-furnace in general is the cheapest means of smelting copper-bearing ores in coarse or lump form, one objection to it is that the

\* E. P. Mathewson.

blast may carry away 5 to 10 per cent of the fine dusty ore. This may be settled as flue-dust in flue or dust chambers, made into briquettes and resmelted, but the additional expense should be avoided if possible. Ore or concentrate in fine condition is better treated in the quieter atmosphere of the reverberatory furnace. If raw ore is treated in such a furnace about 25 per cent of the sulphur only would be expelled; hence, before smelting, sulphide ore would be roasted.

## CHAPTER XXX

### REVERBERATORY SMELTING

Two methods have been evolved for the reverberatory smelting of copper ores, viz., the Welsh process and the reverberatory matte smelting process. The Welsh process possesses the advantage that it can be used on a great variety of ores, the final product being a blister copper. In reverberatory matte smelting a great tonnage of roasted ore is put through, and the resulting product, which is, in the form of copper matte, must undergo a further treatment in the converter to bring it to the stage of blister copper.

#### THE WELSH PROCESS OF REVERBERATORY SMELTING

This consists in treating copper ore (sulphide and oxide as well as silicious ore) by a series of roastings and fusions to raise the grade of the copper in the product finally to blister copper, which is subsequently refined electrolytically, as any blister copper containing gold and silver naturally would be. The process has the advantage that a variety of ores, both coarse and fine, can be treated in a few small furnaces with a small investment of plant.

Fig. 211 is a furnace lined with refractory material having a shallow basin-shaped hearth. Square cross-bars in the fire at *a* sustain the grate

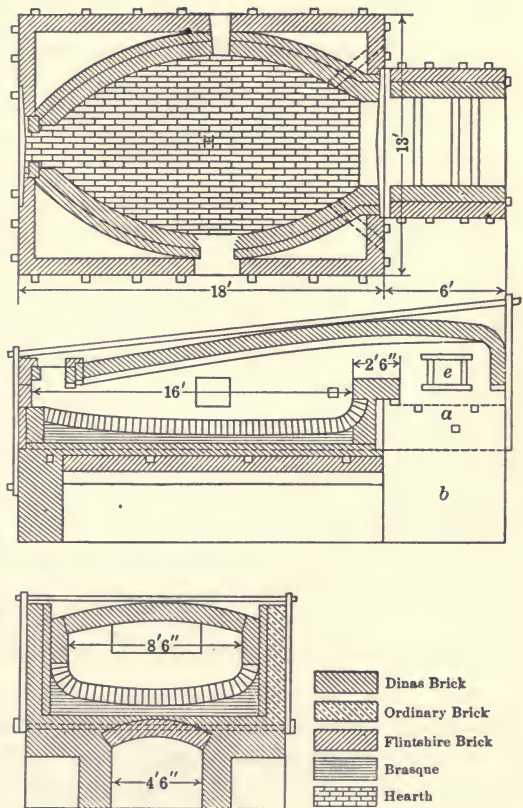

FIG. 211.—Reverberatory Smelting Furnace.

bars of  $1\frac{1}{2}$  in. square iron (not shown). A deep fire is maintained to the top of the fire door, *e*, and some cinder is allowed to accumulate on the grate, but so as to keep the fire open. Any grate bar can be pushed aside and the cinder dropped into the ash pit *b* when cleaning the fire. Next to the firebox is a "bridge" 2 ft. 6 in. wide, to confine the fuel to the firebox. A brick arch beneath it sustains the hearth foundation of brasque and on this the refractory brick of the hearth. The charge is thrown in at the side door, which is then quickly bricked up. The furnace is stirred from the front door, and the slag and matte removed by rabble. The products of combustion escape by a port or opening in the roof and by a flue are carried to the stack or chimney. The part of the roof toward the outlet port is called the "verb."

#### SMELTING OPERATIONS BY THE WELSH PROCESS

We may divide the smelting operation into five parts:

(1) "**Calcining**" the Ore.—Sulphide ore containing 5 to 15 per cent copper is roasted in a hand-reverberatory roaster (see Fig. 29) until not more than 5 per cent sulphur is left.

(2) **Fusion of Ore.**—The roasted ore is charged in a reverberatory furnace with such oxidized copper ore as is available, and melted. The sulphur contained in the roasted ore, with the copper and some of the iron, forms a matte of 35 per cent copper, called "coarse metal." The silica, uniting with the ferrous oxide not taken by the matte, and also with the alumina, and the alkaline-earth bases, forms a slag, fusible at the high temperature of the furnace. The molten bath boils from the escape of trioxide resulting from the reaction of the ferric iron upon unroasted ferrous sulphide, or from the decomposition of barium, lead, or zinc sulphate by silica, thus:



The sulphuric anhydride escapes as a gas, and upon meeting the moisture of the air at the top of the stack, changes to a white fume of  $\text{H}_2\text{SO}_4$ .

(3) **Calcining Coarse Metal.**—The coarse metal or matte that is run from the reverberatory furnace in operation (2) into sand beds, is crushed to pass a 5-mesh screen and fed to another hand-roaster. Rich sulphide of 20 to 70 per cent copper also is crushed and added to the charge. The whole is roasted until it contains not more than 5 per cent sulphur.

(4) **Second Reverberatory Fusion.**—The roasted material, now of 35 to 50 per cent copper, is charged into a fusion-furnace with oxidized ores containing 20 to 70 per cent copper. When the charge is melted

there results a matte of 75 per cent copper, called "white metal," composed chiefly of copper sulphide. As before, the silica contained in the ore added to the charge unites with the ferrous iron and other bases to form slag. This slag, however, having been made from such rich material, contains much copper and is not to be thrown away but returned to another charge in the fusion-furnace of operation (2).

(5) "**Roasting**" and **Formation of Blister-copper**.—The white metal is charged in large pieces, as broken when removing from the sand molds, into a reverberatory fusion-furnace where it is piled in an open fashion, particularly near the bridge. It is fired gradually for several hours with an oxidizing flame. A supply of air is admitted at a number of ports or openings 2.5 in. square in the roof over the fire-bridge, and at the sides of the furnace near the bridge. The operation is called "roasting." The oxidizing flame, acting at the surface of the lumps and upon the drops trickling down, converts a portion into cuprous oxide, so that we have present copper both as sulphide and as oxide. Finally the heat is raised and the whole charge is melted down, according to the reaction:

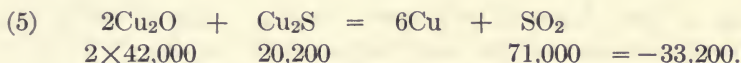

Copious fumes of  $\text{SO}_2$  issue from the boiling surface of the molten charge. Slag rich in copper is produced, getting the silica partly from the interior walls of the furnace, partly from silicious but entirely oxidized ore that has been added to supply silica. The slag is returned to operation (4). Finally the blister-copper is tapped. The metal obtains this name from the fact that, upon cooling, occluded gas seeking to escape from the molten metal, forms blisters on the surface of the pigs of metal.

The blister-copper now contains 98 per cent copper, but also impurities that must be removed to make it suitable for market. The refining process is described elsewhere. In case the copper contains gold and silver, taken from the ores that supplied the copper, it is customary to remelt it, pole it to remove copper oxide, and to cast it into anodes for electrolytic refining.

**Treatments of the Bottoms**.—Impure bottoms are remelted and cast into anodes for electrolytic refining, in which the impurities and gold are separated from the copper; or they may be formed into an inferior grade of copper (casting-copper) as follows: A charge is put into the blister-furnace as in operation (5), consisting of 14,000 lb. of 75 per cent roasted white metal, 21,000 lb. raw white metal, 8000 lb. bottoms and 1000 lb. silicious ore. This is melted down, and then is added 6000 lb. more roasted white metal. The charge aggregates 50,000 lb. This is treated precisely like the regular blister-charge, but it yields a higher percentage of copper.

### THE DIRECT PROCESS OF REVERBERATORY SMELTING

This is a modification of the Welsh method of producing blister-copper. Instead of "roasting" the matte or white metal in lump form in the blister-furnace or process (5), a portion is ground to 5-mesh size and calcined or roasted in a separate roasting-furnace, of either the hand or the mechanical type.

Into a melting-furnace, called the "blister-furnace," is charged 14,000 lb. of the roasted white metal, still retaining 4 to 6 per cent sulphur, 3500 lb. raw unroasted white metal, 4000 to 8000 lb. slag from a former charge, and 600 lb. silicious ore to unite with the FeO and other base present. When this has been melted, 6000 lb. more roasted matte is added, making a total of 23,500 lb. matte charged. When all is fused, the reaction begins. The surface of the charge is seen to be seething and boiling, and escaping bubbles of gas are set free according to the following reaction:



The bath is then skimmed to remove the slag, which contains copper oxide, reserved in part for the next charge and in part sent back to stage (4) of the Welsh process. From the charge here specified there are produced 75 pigs weighing 230 lb. each, or 17,250 lb. blister-copper, and also 23 pots of slag weighing 400 lb. or 9200 lb. containing 12 to 15 per cent copper. Slag is removed several times during the period. The copper, when free from slag, is tapped into a refining-furnace at a lower level. The refining is done in a 14- by 22-ft. furnace carrying a deep charge of copper. This charge is made from copper scrap, high-grade "mineral" of over 80 per cent copper, and mass-copper. It is melted, and a blister-copper, comparatively free from impurities, is obtained.

### LARGE-SCALE REVERBERATORY MATTE SMELTING

This and blast-furnace smelting are practically the two methods of treating copper ores in the United States. Such ores, principally sulphides, are roasted and smelted in large reverberatory furnaces for the production of matte and of a slag low in copper, which is sent to waste. Fuel, rapidly burned, maintains the furnaces at a temperature above the smelting point of the forming slag. We may divide them according to the method of heating into (1) **direct-fired furnaces** having a firebox for coal burning; (2) **furnaces fired with pulverized coal**, and (3) **oil-fired furnaces**. Except at the fire-end they are essentially the same.



## (1) THE DIRECT COAL-FIRED FURNACE

We give at Fig. 212, in plan and elevation, a large furnace showing, at the "back end," the ash pit and the large grate, 8 by 16 ft. area, and the solid fire-bridge immediately in front of it. At the outlet end the flue comes out at the roof. There is ample room in front for skimming and tapping the slag. This runs into a water-filled bosh where it is granulated and swept away by a powerful horizontal jet of water. At two points on the side the matte is tapped off at the hearth level and runs by gravity along a matte launder to a matte ladle set at a low level to receive it. At the left are shown the waste-heat Sterling boilers of 300 H.P. each. Thence the gases, having given up much of their heat pass on by an under-

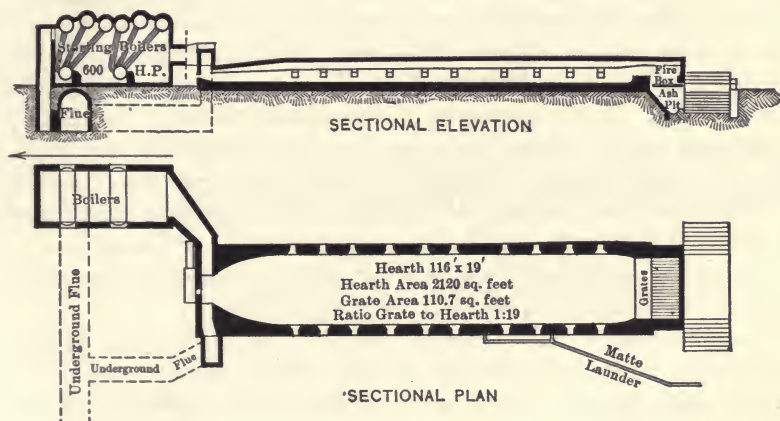

FIG. 212.—Coal-fired Reverberatory Furnace.

ground flue to the main stack. In case it is desired to cut out the boilers for repair the damper to the branch "underground flue" is opened and the boiler damper is closed. Two boilers are heated by the waste gas from the furnace, and develop, together, 600 H.P. The furnace treats, on an average, 275 tons in twenty-four hours, producing a 40 per cent matte concentrating 4 into 1.

The charge consists of hot roasted ore ("calcines") from MacDougall roasters, Fig. 77, and by analysis is shown to be composed as follows: Cu 9 per cent, FeO 24.4 per cent, CaO 2.9 per cent, S 8 per cent, SiO<sub>2</sub> 26 per cent. Every eighty minutes a charge of 15 tons is dropped into the furnace near the fire-bridge. This falls upon the bath of molten matte and slag that the furnace contains. It spreads in all directions, and much of it floats gradually toward the front. It readily melts by contact with the molten slag and matte below and the flame above. In

this great reservoir of heat there is but little variation in temperature, and the flame is transparent.

Every four hours 45 to 50 tons of slag is removed in fifteen minutes from the furnace and allowed to flow from the front door in a thick stream. It is granulated by a strong horizontal stream of water as it falls into the waste-laundry. The water sweeps it away to the dump several hundred yards from the furnace. The matte is kept at a nearly uniform level, 10 tons being tapped out at a time, while the total amount in the furnace is 100 to 150 tons.

The action of the slag upon the furnace is to erode or scour it, but because of the width, the sides are less acted upon than would be the case in a narrow furnace. To repair the furnace, both slag and matte are drawn off completely, then the side-doors are opened, and sand is thrown across the furnace against the sides where eaten away by the slag. They thus are protected against the inroads of the slag. A furnace runs six or eight months and then has to be shut down for the thorough repair of the roof, walls, and bridge. These parts are of silica brick, the walls being 30 in. thick, the roof 15 in. Silica bricks are practically infusible but expand on heating, so that allowance is made by leaving transverse slits in the roof. These close when the furnace is at full heat. An important point in efficient working is to have the outlet-flue, or "neck," of the proper size. It must be large to insure good draft, and yet retain the flame in the furnace. In the furnace shown it is 60 by 38 in. or 16 sq. ft. area.

The temperature at fire-bridge is 1550° C.; at the flue end 1200° C. The slag leaves the furnace at 1120° C. and drops to 1060° at the overflow spout of the settler. Gases reach boiler at 950° and leave at 330° C.

	Heat Balance of above Furnace. Per Cent
Heat in slag.....	16.2
Heat in matte.....	3.2
Heat lost in radiation.....	11.6
Heat lost in cooling-bridge plate.....	0.2
Sensible heat in grate droppings.....	0.8
Heat in steam generated at boilers.....	32.8
Heat in gases passing the boilers.....	13.2
	78.0

The remaining 22 per cent must be due to the excess of air over the theoretical amount needed for combustion.

## (2) FURNACES FIRED BY PULVERIZED COAL

In Fig. 213 is a sectional plan and elevation of a pulverized coal-fired furnace, with a hearth 116 ft. long by 19 ft. 9 in. wide and with side walls 22½ in. thick. At the firing end are two tall charge hoppers, but the most

of the charging is done by side hoppers having 6-in. feed pipes extending through the roof near the side walls. By opening a slide in the feed pipe, calcines can be charged against the wall as fast as the material melts down. At the firing end is an 18-in. blast pipe from two blowers with five air jets

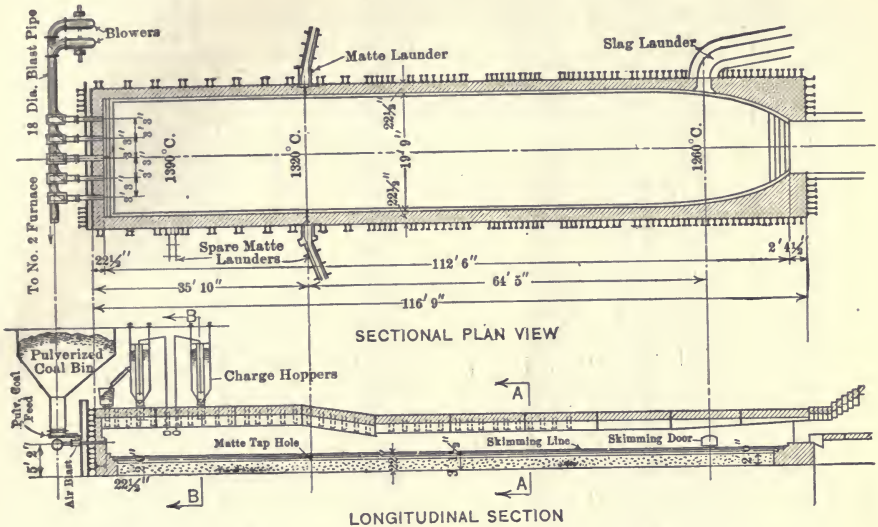

FIG. 213.—Reverberatory Furnace Fired with Pulverized Coal.

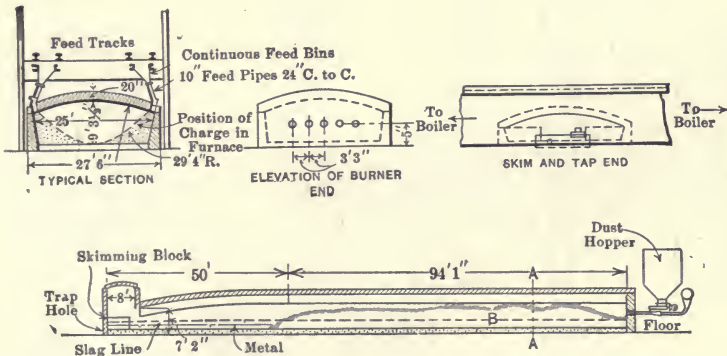

FIG. 214.—Method of Charging the Furnace.

to the furnace. From the pulverized coal bin come down five pipes supplying the coal by a screw feed to the tops of the air branches or burners. The coal as it drops into the burner is atomized and blown into the furnace, instantaneously taking fire and filling the furnace with flame. A slag launder at one side of the front end takes the flow from the tap-hole, while



a matte-launder towards the firing end takes away the matte at a tap-hole set, as shown in the sectional elevation at the hearth level. On the opposite side of the furnace are spare matte launders to be used in case of need. It will be seen that the furnace bottom is of sand fused in layers by heavy firing.

How the furnace is charged is well shown in Fig. 214. The calcine, hot from the roasters, is banked along the wall as at *B* and as shown in the typical section of the same figure. There is also a transverse section showing the position of the burners. It will be seen from the temperatures given in Fig. 213, plan, that the banking is near the hottest part of the furnace.

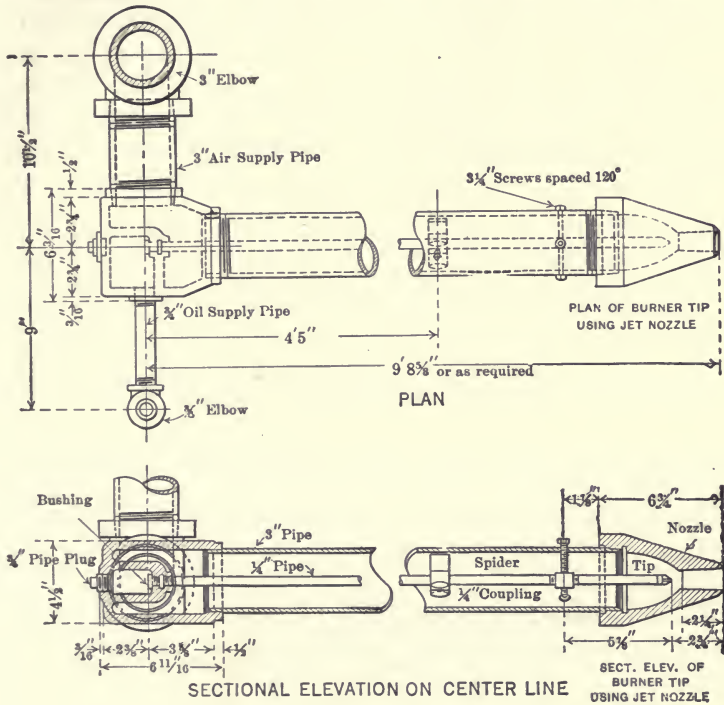

FIG. 216.—Low-pressure Oil-burners.

### (3) OIL-FIRED FURNACES

Where oil is the cheapest fuel it is to be preferred, and in Fig. 216 are shown in sectional plan and in longitudinal and transverse sections an oil-fired reverberatory furnace. In this case there are six charge hoppers placed at the zone of greatest heat, but no side charging. The charge as there melted down flows toward the front end, the matte settling out in quiet. Ore is brought to these hoppers by a charge car from the roasters. The side walls are thick and sloped up above the slag line at the

side. This furnace has side doors to give access to the hearth and walls for repairs. Tapping of slag is done at the front under the outlet flue, and matte just at the point where the furnace begins to narrow. The roof is high toward the firing end, sloping downward gradually to the verb at the front.

There are four oil burners located well above the slag line and made as shown in Fig. 216. Oil under high pressure is brought by a  $\frac{1}{4}$ -in. pipe to a burner tip or nozzle, where it is caught up and atomized by the air blast, and thus made ready for instant burning with an intense flame.

**Burning Temperature of Oil in a Reverberatory Furnace.**—A fuel oil of the composition C 85.0 per cent, H 12.4 per cent and 3.4 per cent, when completely burned, will yield 10,720 calories per pound. The products of combustion, including 0.5 lb. steam for atomizing the oil, will be (see page 80) 3.11 lb. carbon dioxide;  $9 \times 12.4$  per cent—0.5 H<sub>2</sub>O as water, a total of 1.618 lb. and in the steam 1.44 lb., a total of 3.70 lb. oxygen that comes from 13.91 lb. of air containing 10.71 lb. of nitrogen. Hence we have

3.11 lb. carbon dioxide.....	@ 0.364 = 1.132
1.618 lb. water vapor.....	@ 0.77 = 1.245
10.71 lb. nitrogen.....	@ 0.281 = 3.009
	5.386

The temperature of combustion is therefore  $\frac{10,720}{5,380} = 2000^\circ$  C. nearly.

In practice some excess of air must be used so the temperature is not attained. Thus, with the excess of 23 per cent of air, the theoretical temperature may be given at  $1800^\circ$  C.; and considering cooling influences not more than  $1500^\circ$  to  $1600^\circ$  C. We may assume that the gases leave the furnace at  $1200^\circ$  and the waste heat boilers at  $400^\circ$  C. Due to leakage of air into the furnace and to the cooling influence of the gases escaping from the charge the excess gases are increased to, say, 50 per cent. Summarizing we have

	Per Cent.
Calorific value of the fuel.....	100.0
Distribution of heat:	
Taken away by the matte and slag.....	13.5
Radiation from the furnace.....	10.0
	23.5
Taken up by the boilers.....	34.5
Radiation at the boilers.....	7.0
	41.5
Sent to the stack.....	35.0
	100.00

## OPERATION OF A LARGE REVERBERATORY FURNACE

These, whether coal fired, pulverized-coal fired or oil fired are charged much in the same way. Part of the charge is dropped into the furnace from time to time from hoppers shown near the firing end of the furnace; the rest is added through charge tubes so as to maintain a bank of ore against the furnace side wall at the hottest point, thus protecting the wall against the intense heat and the corrosion of molten slag. Ore is brought to the hopper as well as to the side wall hoppers by calcine cars placed on transverse overhead tracks. However, the Cananea oil-fired furnace is not so fed. It is provided with side doors through which ore can be thrown for fettling the walls to the opposite side of the furnace.

Increase of furnace output depends upon the increase of fuel burned with its increased and intenser consequent heat. It has been found that by enlarging the outlet flue to 70 sq. ft. as compared with half that dimension and by increasing the volume of low-pressure atomizing air with the increased fuel, the flame was shorter, began closer to the burner nozzle, and was intenser, so that melting proceeded more rapidly and a tonnage formerly of 400 was increased to 700 tons and over. In one instance in an oil-burning furnace of 100 by 21 ft. hearth area 800 tons was smelted daily, using 0.622 bbl. of oil (183 lb.) per ton of charge. Even this figure has been improved by charging the calcines promptly from the roasters.

In older practice the custom was to remove the slag intermittently, using a rabble to assist the flow. More or less crust and floating material imperfectly smelted was thus withdrawn. In present practice where 400 tons and over is smelted per furnace, the breast has been closed and the tapping holes made of such aperture that the flow is continuous and the crust near it is undisturbed. In this way the copper in the waste slag was cut from 0.4 per cent to 0.3 per cent per ton of slag.

Ribs are now introduced in the roof, arching from the buck-staves between the ribs, thus prolonging the life of the furnace roof.

## REACTIONS AND CALCULATION OF THE CHARGE

The sulphur of the charge unites with the copper and iron until its needs are satisfied. The matte thus formed, separating in drops, absorbs the precious metals contained in the ore, and by the greater specific gravity than that of the slag, penetrates downward to the hearth. The silica of the gangue unites with bases, such as  $\text{FeO}$ ,  $\text{CaO}$  and  $\text{Al}_2\text{O}_3$ , and forms a fusible slag that floats as a separate layer upon the matte.

When ore is roasted a part of the iron is oxidized to the ferric state,

and when the charge is fused the ferric iron acts upon the unroasted ferrous sulphide according to the following equation:

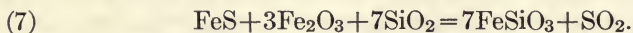

When ferric iron is present in the ore, sulphur is eliminated often to the extent of 25 to 33 per cent, and we find less matte than would be present if this reaction did not take place. The iron, thus reduced to ferrous form, enters the slag.

#### CHARGE CALCULATION FOR A REVERBERATORY FURNACE

**Charge Calculation.**—The charge of a reverberatory furnace generally consists of hot calcines from the roasting-furnaces to which limestone has been added at the time of roasting.

The charge for the reverberatory may be calculated as in the example under "Regular Matte Smelting." Below is given an example where the composition of the charge is known and we desire to compute the consequent composition of the slag and matte. It is assumed that not more than 30 per cent of the sulphur in the roasted ore will be volatilized, that approximately 0.4 per cent copper and 1 per cent sulphur go into the slag, which also carries 90 per cent of the three elements  $\text{SiO}_2$ ,  $\text{FeO}$ , and  $\text{CaO}$ ; that the matte is to contain 90 per cent of the three elements, sulphur, iron, and lime. The ore has been roasted with 10 per cent by weight of crushed limestone. The charge-sheet is arranged as in the table, and the percentages computed and added. The weight of the slag of 35 per cent  $\text{SiO}_2$  would be 1200 lb., containing 1 per cent sulphur, or 12 lb., and this added to the 30 per cent or 42 lb. of the sulphur burned off, will make 54 lb., leaving 86 lb. to enter the matte whose weight would be four times this or 344 lb. Some 65 per cent of the matte will be copper and iron. After allowing for 0.4 per cent or 5 lb. as being lost in the slag, there remains 115 lb. of copper, and 108 lb. of iron is consequently needed for the matte. Deducting this from the total iron there is left 294 lb., equal to 378 lb. of  $\text{FeO}$ . Let us now assemble the items for the slag. They are silica 408 lb.,  $\text{FeO}$  378 lb., and lime 140 lb., constituting 90 per cent of the slag. The resultant percentages are then computed. In the same way in the matte, since the three constituents, sulphur, iron, and copper, make 90 per cent, we can distribute the resultant percentages, i.e., 25 per cent to the sulphur, 33.5 per cent to the copper, and 31.5 per cent to the iron. The grade of the matte in copper is then 33.5 per cent.



CHARGE-SHEET. REVERBERATORY SMELTING.

	Dry Wt.	Cu.		SiO <sub>2</sub> .		Fe.		CaO.		S.	
		Per Cent.	Lb.	Per Cent.	Lb.	Per Cent.	Lb.	Per Cent.	Lb.	Per Cent.	Lb.
Roasted ore....	2000	6	120	20	400	20	400	2	40	7	140
Limestone.....	200			4	8	1	2	50	100		
			120		408		402		140		140
		Cu in slag = 5		For matte = 108				Volatilized = 42			
		Cu in matte = 115		For slag = 294				In slag = 12			
				FeO for slag = 378				Wt. of matte = 344			
								In matte = 86			
								Cu and Fe = 223			
								Cu = 115			
								Fe = 108			
											86 = 25 %
											344 per cent.
											65
											223 = 33.5 %
											115
											108 = 31.5 %
											90.0 %

Slag  
 SiO<sub>2</sub> = 408 = 39.8 per cent.  
 FeO = 378 = 36.6 per cent.  
 CaO = 140 = 13.6 per cent.  
 926 = 90.0 per cent.

## CHAPTER XXXI

### CONVERTING COPPER MATTE

**Principle of the Process.**—This consists in treating molten matte in a converter, a receptacle lined with refractory material. Compressed air, blown through the molten bath, as in steel converting, burns off the sulphur as  $\text{SO}_2$  and oxidizes the iron to  $\text{FeO}$ , this entering the slag. The slag is poured off, leaving blister-copper, and this in turn is poured from the converter into molds.

#### THE COPPER CONVERTER

Two types are in general use, the horizontal or barrel type, and the vertical or Great-Falls type. Both are electrically operated.

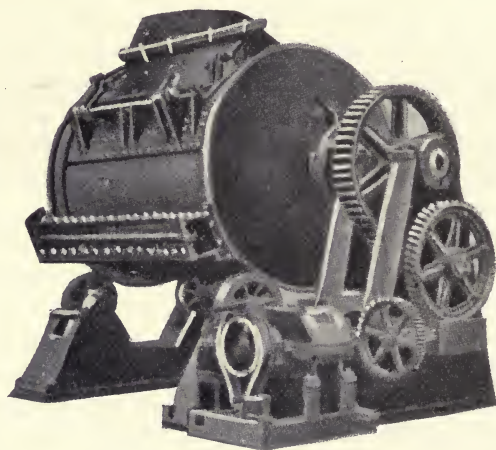

FIG. 217.—Horizontal Type of Converter.

**The Horizontal Converter.**—Fig. 217 is a view of the horizontal or barrel type, at first everywhere used. It consists of a cylindrical steel shell, having riding rings at each end by which it is carried, and revolved on four carrying rollers. By means of four links riveted to the converter top, the steel shell can be lifted from its stand and transferred where desired by 40-ton traveling crane for relining, a newly lined shell then being put in its place. To obtain better access to the interior the separate nose can be

unbolted and removed. At the front is seen the rectangular wind-box, having fourteen tuyeres. As better shown in Fig. 218, the air supply enters through a sleeve connection at the axis of the shell, and through a cast-iron passage to the wind-box. The motor, through a worm and worm gear, revolves the converter to any desired position. Immediately at the front in Fig. 217 is shown a band-brake by which the motor can be quickly stopped.

From the "blast main," Fig. 224 as marked, a 12-in. branch leads to the axial line of the converter, having there a sleeve. The air passing from this point curves around the converter to the wind box where are the tuyeres, and below them the "puncher's platform." A hinged platform at

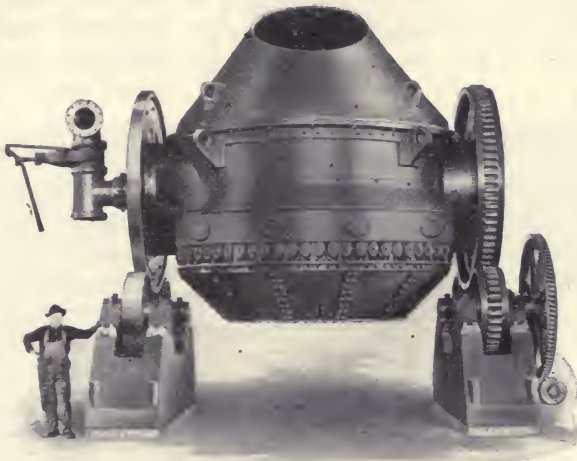

FIG. 218.—Great Falls or Upright Type Converter.

the front is used when spent-accretions are to be cut away or for throwing in cold matte, etc.

The Smith-Pierce is another type of horizontal converter, basic lined, and in successful use at several copper plants. They are made up to 13 ft. in diameter by 30 ft. long. (See Fig. 220.)

**The Upright Converter.**—This, called also the Great-Falls type, since it was there developed, is built in sizes up to 20 ft. diameter, though the 12-ft. converter is common. As shown in Figs. 218 and 219, it is cylindrical in plan with a tapering bottom and top. The converter-top comes apart just above the trunnions, so that, when the converter has been removed for relining, this may be unbolted and lifted off. Riding-rings are bolted to the shell, and are carried on rollers as in the horizontal type. The wind-box occupies the front half of the circumference, and its connection to the blast-main, also the control valves, is plainly shown. There are

twenty-four individual tuyeres branching from the wind-box, any one of which can be separately removed if desired. The hole through the lining for each is  $1\frac{1}{2}$  to  $1\frac{3}{4}$  in. In the view, Fig. 218, can be seen the end of the worm drive, but not the electric motor.

### THE CONVERTER LINING

Both acid and basic linings have been used, the first exclu-

sively for many years. It was contended that the acid lining was necessary in order to furnish silica for the slag necessarily produced as the iron was oxidized. An acid lining would last from seven to nine heats, or much less than twenty-four hours, and then had to be removed for relining. This was done, using a ganister of 85 per cent silica and 15 per cent clay; the converter was then dried and heated for re-use. The lower the grade of the matte, that is the higher it was in iron, the shorter the life of the lining, so that the converting of low-grade mattes was prohibitory.

It was found that by supplying silica to the charge directly upon the surface of the molten bath the operation could be carried forward with a basic lining, and so, since 1911, the acid lining has been given up in favor of the basic.

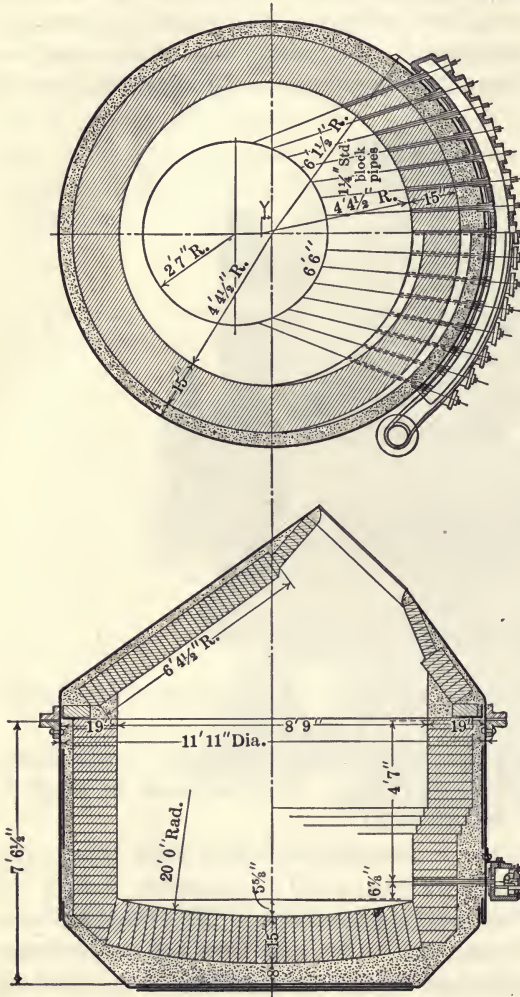

FIG. 219.—Sections of 12-ft. Basic Converter.

**The Basic Lining.**—The usual practice is to line the converter with magnesite brick to a thickness varying from 24 in. at the

tuyeres to 9 in. elsewhere. But the temperature in the converter is continually varying; the lining is hot during the blowing period, and cools during pouring or recharging. These variations in temperature cause the lining to crack and spall off, also there is the mechanical wear of the charge, contributing to shortening its life. This led to the idea of forming a protective coating. In blowing the initial charge of matte without silica and at a moderate temperature, it was found that above the iron oxide necessary to combine with any silica present there was an excess of iron, which under the oxidizing action of the blast, was converted to magnetite ( $\text{Fe}_3\text{O}_4$ ). At about  $1200^\circ\text{C}$ . this magnetite becomes mushy and attaches itself to the lining, forming the needed protective coating, which can by control of the temperature be added to at will. With proper operation and care, the lining, thus protected, should last indefinitely. It has the farther advantage that low-grade mattes can be readily treated.

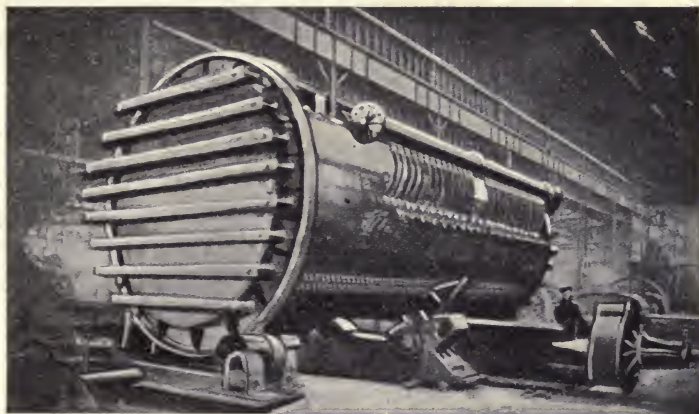

FIG. 220.—Pierce-Smith Horizontal Converter.

#### OPERATION OF THE BASIC CONVERTER

The operation of the horizontal converter may be thus described. The initial charge is 60 tons of matte to which is added 10 per cent of dried quartz for fluxing. The blast is now turned on for thirty to thirty-five minutes and the charge begins to heat up owing to the active oxidation of the  $\text{FeS}$  of the matte. The converter then is tilted to pour slag, the blast being at the same time shut off. With the completion of the pouring a ladleful or 6 tons is introduced and 3 tons of silicious ore added. Another blow then begins. This cycle of blowing and addition of matte and silicious flux is continued until 70 to 80 tons of blister-copper has accumulated. It means the charging of 300 to 400 tons of matte, and

a period of thirty to fifty hours of blowing time according to the grade of the matte. The molten copper is then poured into large, hot, lined ladles and transferred to the casting-furnace or directly to the casting-machine.

**Operating Precautions.**—As converting is primarily an oxidation process, the speed of working depends on the speed of blowing. Hence the tuyeres, which tend to slag over if untouched, should be kept well punched by the insertion of a punching bar, as is done in blast-furnace smelting, except that in converter practice this is done every few minutes. In this way the tuyeres are kept open, bright, and in working order. The temperature of the converter can be regulated by the addition of cold matte, ore and the rich sweepings that get spilled, and that accumulate during operations. An addition of a small amount of hot matte, about ten minutes before the charge is finished, will ensure hot copper when pouring.

**Introduction of Silicious Ore to the Converter.**—This has been done largely by using charging boats or trays that will hold 1 or 2 tons of material. These are provided with chains by which they are lifted and handled.

#### CHEMICAL REACTIONS OF THE CONVERTER

**The Slagging Period.**—Referring to operations in a 12-ft. converter, the matte may be taken as containing Cu, 43 per cent; Fe, 29 per cent, and S, 14 per cent; corresponding to  $\text{Cu}_2\text{S}$  and  $\text{FeS}$  with a little  $\text{Fe}_3\text{O}_4$ . The period begins when the first ladleful of matte has been poured in and the blast turned on. The heat at first drives off elemental sulphur according to the reaction:

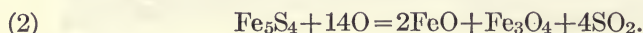
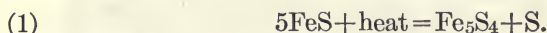

Here is revealed the source of the material to furnish a magnetite lining. But a subsidiary reaction then takes place by which this magnetite is reduced to  $\text{FeO}$ , then entering the slag:

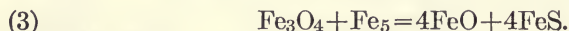

The principal reaction now becomes:

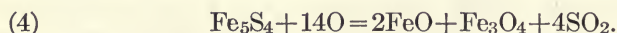

In this vigorous reaction much sulphur dioxide is evolved, the magnetite becomes reduced, according to reaction (3) into  $\text{FeO}$ , and this together with that resulting from reaction (2), also enters the slag. It is thus seen how necessary it is at this stage to add silicious ore to unite with the  $\text{FeO}$ . The reactions, at first slow, rapidly increase until in about forty-five minutes they are completed; much of the sulphur is gone and most of the iron

slagged, and the converter contents brought to the stage of white metal. The end of the stage is known by the appearance of the issuing flame, the greenish border, at first seen, changing to a pale permanent blue. Pieces of matte are thrown into the converter if it is wished to make the charge hotter, while sweepings from around the converter, rich in copper, when added tend to make it cooler. At this time the converter is turned down and the slag poured into the slag-ladle. To tell when the matte begins to escape, "the skimmer" passes a rabble through the flowing stream and can thus determine the presence of drops of matte, whereupon the converter is returned to blowing position. This converter slag, containing 1.5 to 2 per cent copper and about 0.5 to 0.1 oz. silver per ton, is sent to the blast-furnace for recovery of its metal contents.

**Conversion of White Metal to Copper.**—At the beginning of this blow there is but little iron left, and the matte has been brought to the stage of white metal of 75 per cent Cu, and we have:

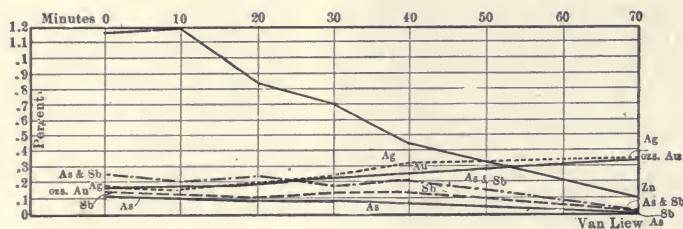
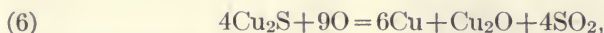
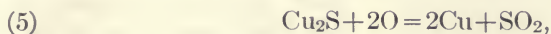

FIG. 131.—Elimination of Impurities in Converting.

with a further abundant evolution of  $\text{SO}_2$  and the formation of blister-copper. The  $\text{Cu}_2\text{O}$  of reaction (6) is soon reduced to Cu as per reaction (5). As far as the agitation of the blast permits, the molten contents separate into layers, an increasing layer of white metal above, and slag on top. The blast enters the bath horizontally 6 to 12 in. above the bottom, and blows largely through the white-metal layer. The escaping flame is white, gradually changing to rose-red and finally to a brownish red. It decreases, until at last there is but a brick-red flickering. The identification of the finish needs care and experience. If carried too far we have over-blown copper. The converter is now turned down, the blast being at the same time shut-off, and the blister is poured, either directly into molds, or into a ladle, to be taken to a tilting-furnace. The converter is then turned back to receiving position for treatment of a new charge. The air is supplied at a pressure of 12 to 15 lb. per square inch, using 150,000 cu. ft. of

air per ton of blister produced. It takes four hours for a cycle of operations, and in this time 25 tons of matte are treated, yielding 10 tons of blister-copper.

**Loss in Converting.**—The escaping gases contain nitrogen, sulphur dioxide, and traces of volatilized metals. The loss of gold is small; that of silver depends upon the amount of volatile metals. In the flue-dust in one case there was an average of 40 oz. per ton. The loss in converting may be given at 1 to 1.5 per cent of the copper and 2 to 2.5 per cent of the silver. When treating leady matte from a silver-lead furnace, this

loss of silver may be serious, amounting to 33 to 40 per cent. At Tooele, Utah, where the lead and zinc fumes are caught in a bag-house, the silver is saved.

We give, in Fig. 221, a graphic chart showing the losses in an acid-lined converter where the period of the blow was seventy minutes. It shows that after ten minutes the 1.2 per cent of zinc is gradually burned off. Antimony and arsenic, both present to the extent of 0.25 per cent in one case and to 0.15 per cent in another, are well eliminated toward the end.

**Crane Ladle.**—Fig. 222 is a view of a steel ladle used for transferring matte or blister-copper by means of the traveling crane from the forehearth of a



FIG. 222.—Crane Ladle.

blast-furnace or from a reverberatory furnace. When in position it is tipped by an auxiliary hoist of the crane which hooks into the eye shown at the left side of the ladle. The ladle is plastered on the inside with a coating of clay loam, which is dried out and heated before using.

#### BLAST-FURNACE SMELTING AND CONVERTING PLANT

Fig. 224 represents the plan of a blast-furnace plant with a two-stand converter-plant attached, the size of the latter being indicated by the number of stands or stalls in which copper matte can be blown. In the elevation, Fig. 223, the receiving track for coke is shown at the extreme right of the illustration unloading into the coke bins beneath. The



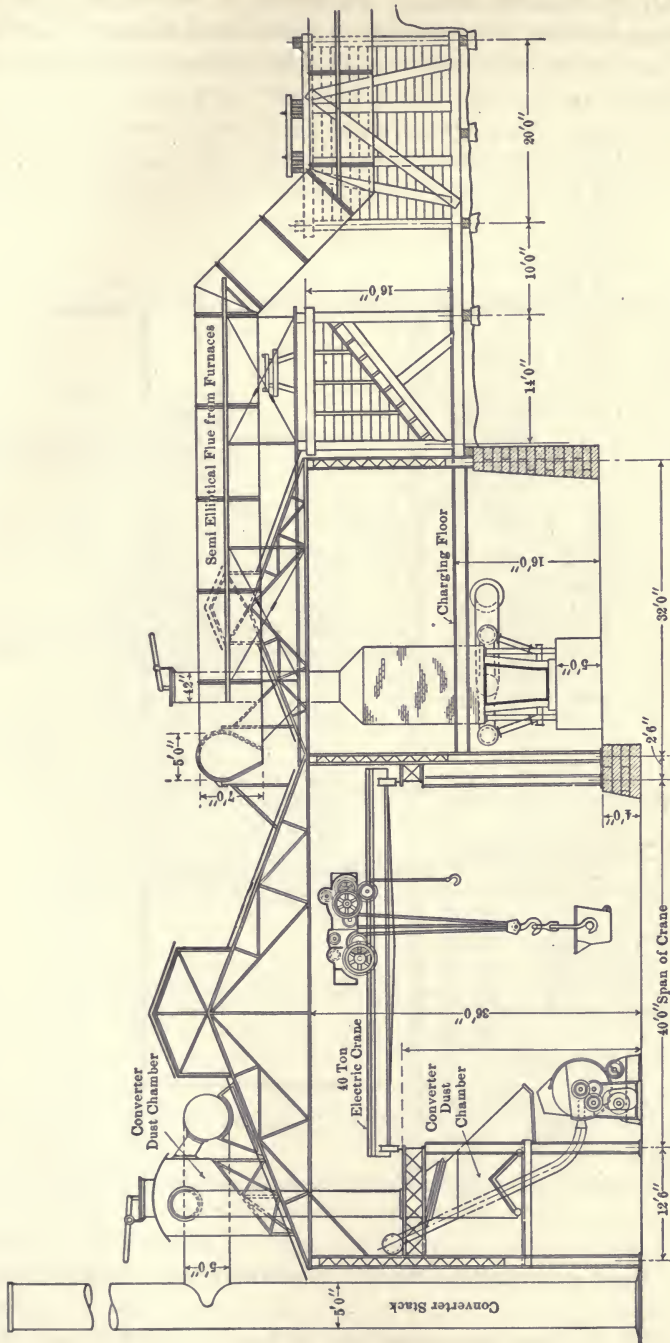

END ELEVATION OF FURNACE AND CONVERTER BUILDINGS

Fig. 223.—Elevation of Blast-furnace Smelting and Refining Plant.

ore-bins with the inclined bottoms are shown to be on the same level. In the furnace building there are two matting blast-furnaces, each 42 by 144 in. at the tuyere level and each having a settler or fore-hearth 10 ft.

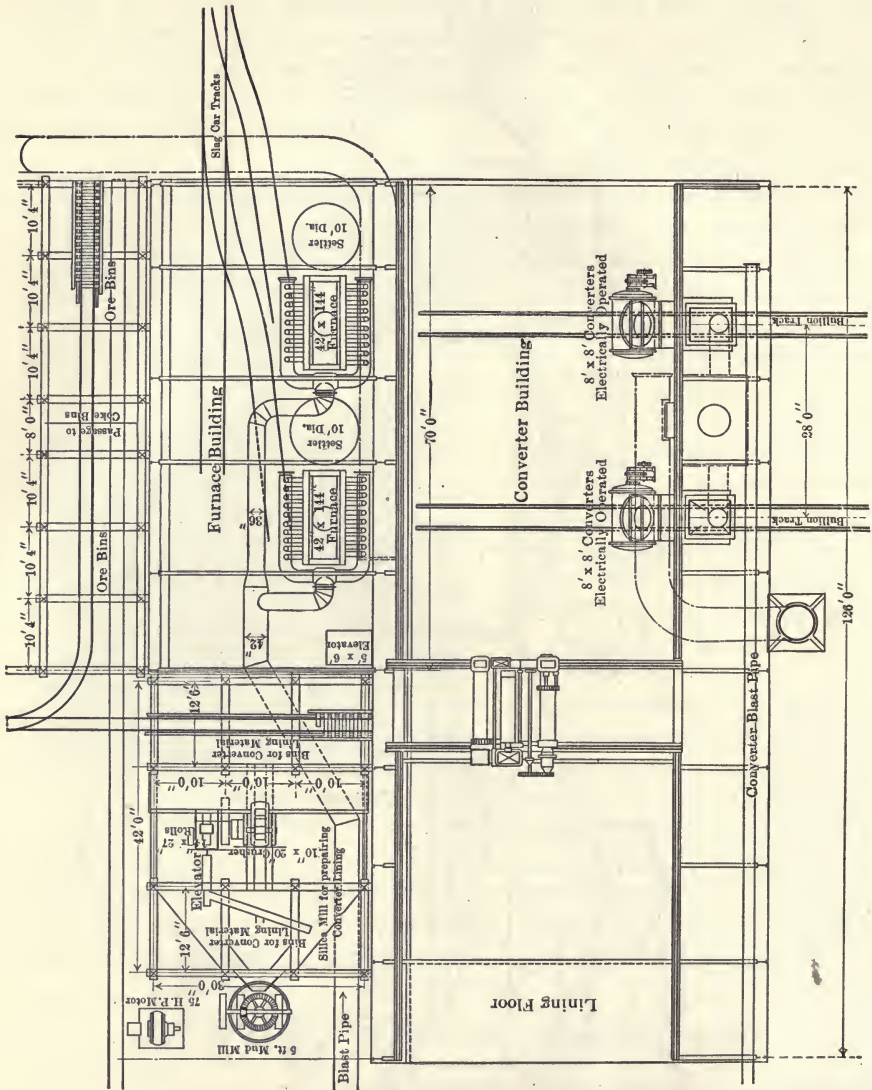

Fig. 224.—Plan of Blast-furnace Smelting and Converting Plant.

diameter. Blast is furnished to the furnaces from a power-house, not shown.

In Fig. 223 is shown the semi-elliptical flue 3 ft. by 7 ft. high, leading

from the blast-furnaces. This crosses the near end of the furnace building, as indicated by the dotted lines in Fig. 224. It is connected to a dust-chamber which leads to a stack. The slag is taken away over an electric-trolley system entering the building. The slag-cars are brought close to the settlers to receive the flowing slag while the matte, as needed, is tapped from a lower tap-hole into the steel ladle for transferring to the converters. A platform elevator, at the end of the furnace building, elevates slag and

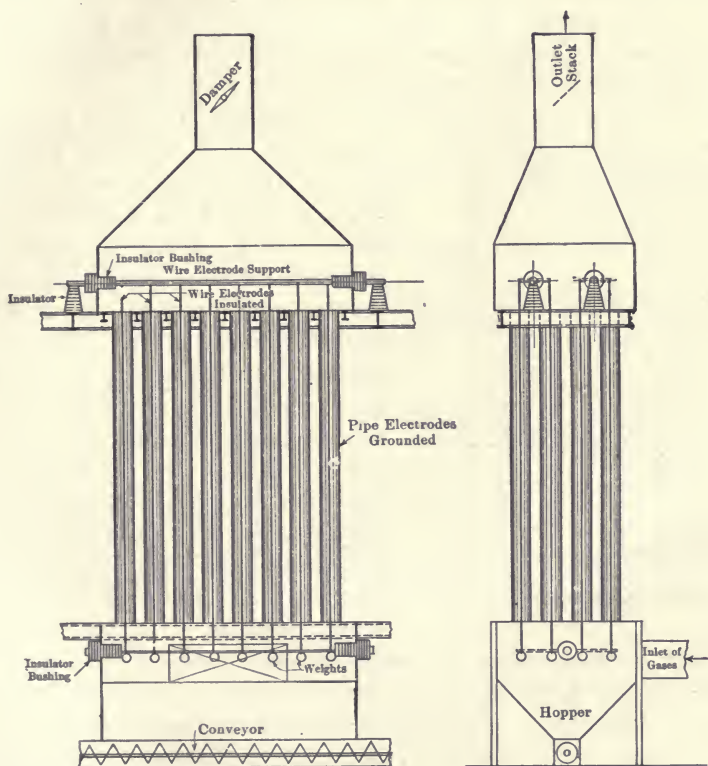

FIG. 225.—Cottrell Treater.

other material from the floor of the converter building to the charge-floor for the blast-furnace.

The converter building has at one end the lining floor, and is commanded from end to end, by a 40-ton electric traveling crane which serves to handle the converters, to supply them with matte, to take away the slag, and to handle all materials for and from the converters. For each stand there should be an extra shell, or four in all. The escaping gases from the converters are received in a hood attached to a dust chamber

so that the particles of matte blown out by the blast are collected. From the hood a flue connects with a dust chamber and this with a stack.

At one end of the furnace building (see Fig. 224) is the mill where the lining material is prepared for the converter (now no longer used).

#### ELECTROSTATIC RECOVERY OF COPPER BLAST-FURNACE AND CONVERTER DUST

This, called also the Cottrell process, has come into use since it is possible by it to remove the dust and fume from the hot gases produced in roasting fine ore, or the fumes escaping at the converter-plant where, due to the high temperature, a bag-house could not be used.

In principle, the fume and dust in suspension flow upward through a vertical tube 5 to 10 in. in diameter by, say, 15 ft. long, as shown in Fig. 226. No. 10 insulated copper wire, suspended axially, takes a high-voltage unidirectional current of 25,000 to 60,000 volts or more. The current, passing from the wire to the inner surface of the tube, electrifies the fume or dust particles negatively, and these are repelled to the inner surface of the tube, forming a coating upon it. This coating is occasionally removed by jarring it off into a hopper below, whence it is removed by a spiral-screw conveyor.

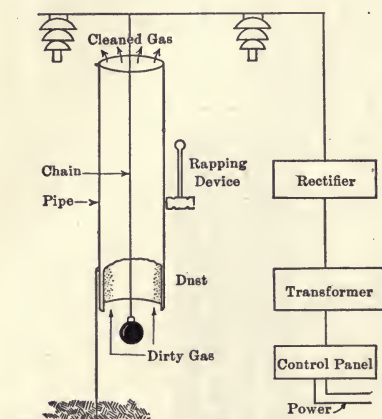

Fig. 226.—Diagram of Treater.

Another method, called the **plate system**, consists in having vertical corrugated plates about 10 in. apart and at 10 in. intervals chains of  $\frac{1}{4}$  in. diameter suspended. The current down those chains acts in a similar way, repelling the dust particles to the surface of the plates. A later variation of this consists in having rods passed horizontally equidistant between the plates to carry the current. A chamber full of pipes or plates with the rods thus insulated is called a Cottrell treater unit. The insulated wires are connected in one and receive the high-pressure current.

#### THE WORKS OF THE INTERNATIONAL SMELTING CO.

This comprises two separate installations, a roasting and drying plant and a reverberatory smelting and converting plant. The dried or roasted product of the first being smelted at the second, we have, therefore:

- (1) A roaster or dryer plant, with a Cottrell treater.

(2) A smelting and converter-plant where the converter dust is caught in a Cottrell treator.

At the dryers or roasters (see Fig. 227) are trippers that regularly feed to five-hearth Wedge roasters. Beneath are two rows of calcine hoppers, so placed that the calcine can be drawn off into cars that take it away to the smelting works. In Fig. 236 is shown one of the two fire-boxes which heat the roasters, two and two, respectively. The roaster arms of the furnace are cooled by air and the delivery of this air is by an underground pipe marked "cooling air" in Fig. 236. Above and between the roasters is the gas flue, which receives the branch pipes from the roaster. From the top of the gas flue are pipes that branch right and left to the respective gas treaters for each roaster. Each treator has thirty-six pipes 12 in. diameter by 15 ft. long with an upward flow of gases through them. Here the dust is separated, and the gas escapes by stacks or chimneys, three to each treator, high above the building.

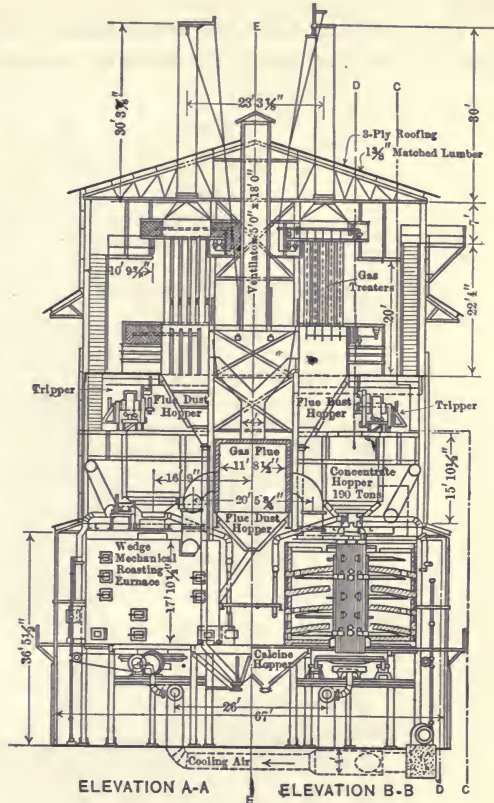

FIG. 227.—End Elevation of Roaster Plant.

**The Roaster Plant.**—This roasting, or rather drying plant of the company is for the drying of a flotation concentrate, to which is added a small amount of sulphide ore in order to produce the needed proportion of matte in the subsequent smelting. The material is so fine that a Cottrell installation had to be added in order to prevent excessive loss of flue dust.

Figs. 227 and 228 are two views of the roaster building, which contains five Wedge roasters, each roaster having its own treator. In the other end of the building is the "electrical machinery room" containing the switch boards, generator-exciter sets and the motor-generator-transformer sets.

Here are the elevating and conveying belts for delivery of the flotation concentrates to the furnaces. There is so little sulphur in this product that there is no need to roast it, and the wet material is simply dried before being sent to the reverberatory for smelting. Were it needed, roasting could be added. The material being so fine much flue dust is necessarily made.

**The Smelting and Converting Plant.**—Fig. 229 is a plan of this smelting plant for the treatment of a flotation concentrate, to which has been added

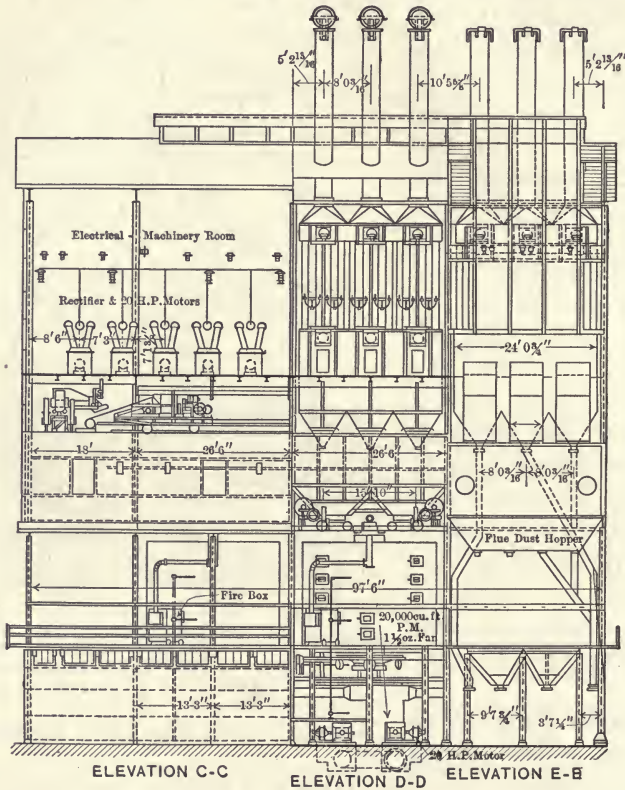

FIG. 228.—Side Elevation of Roaster Plant.

a small amount of sulphide in order to produce the needed proportion of matte. The plant consists of the converter house, its Cottrell treater and stack at the right, the reverberatory building at the center, and the boiler house for the waste-heat boiler with their flue and stack at the left, also auxiliary equipment of the plant above.

There are three large reverberatory furnaces (oil-fired), over which transversely run a double line of tracks which bring in the calcines from the

dryer and roaster building, some distance away. The firing end of the reverberatories adjoins the converter house set at a lower level, so that the matte ladles can be set low enough to take the matte when tapped. At the front end are seen the slag cars on a sunken track. As fast as filled they are removed by a locomotive.

**Waste-heat Boilers.**—Over this sunken track is the heater flue, which

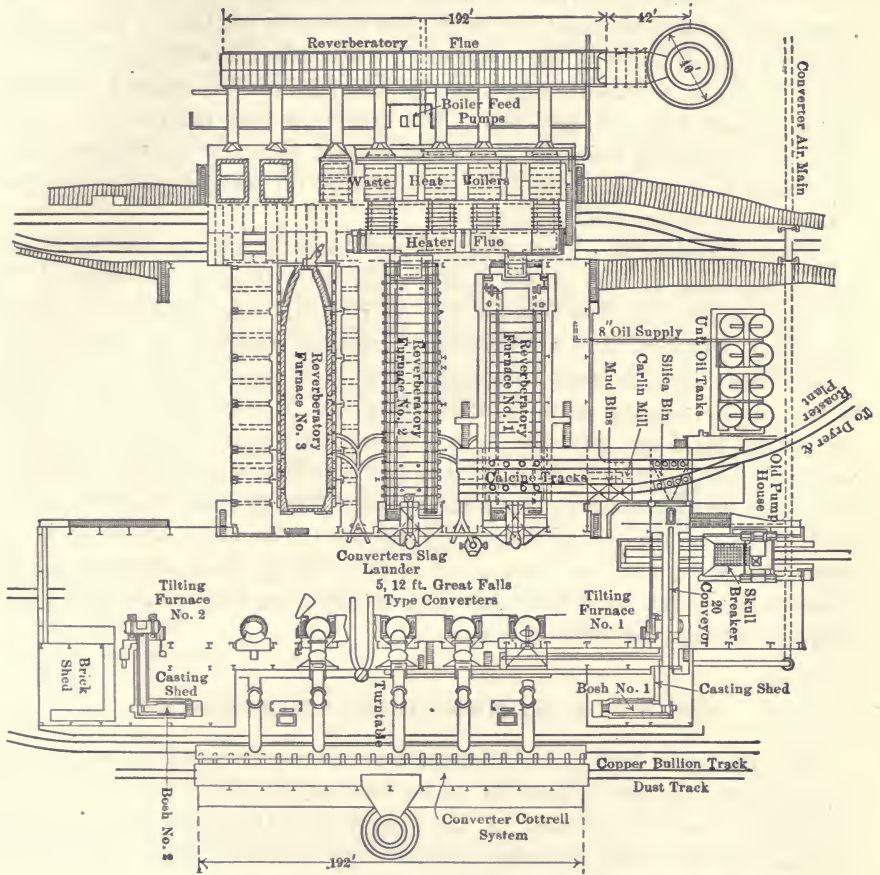

FIG. 229.—Plan of Reverberatory Smelting and Converting Plant.

takes the gases from the three furnaces. From this flue there are six branch flues to the six waste-heat boilers, and each of these in turn branches to the reverberatory flue, this latter leading to the main stack 300 ft. high by 25 ft. diameter.

**The Cottrell Treater for the Converters.**—In the converter house are five converter stands, each arranged as in Fig. 229, the goose-neck branch pipe leading to a dust bin, the hopper of a Cottrell treater where a part

of the dust settles out. The rest of it is taken out by a converter Cottrell system so that the valuable dust is quite recovered. The gases pass away by the converter stack. Beneath the dust bin is a dust track and parallel to it a copper bullion track for the removal of flue dust and the blister copper respectively.

**The Tilting Furnaces.**—There are two of these Nos. 1 and 2 of the plan, Fig. 229, so that one furnace is filling while the other is pouring. They resemble a large horizontal converter and receive a number of ladlesful of blister as this is made at the converters. When full, the tilting furnace is poled to make a smooth ingot and is poured into the casting machine adjoining, see Figs. 242 and 243. The ingots, as they fall into the water bosh of the casting machine, are there cooled, then, by an endless chain are raised and delivered into the casting shed for weighing and shipping away by the copper bullion track.

**Other Equipment.**—The converter air main brings in the air from the compressor in the power house (not shown) at a pressure of 15 lb. per square inch for use at the converters. A battery of eight oil tanks supplies the reverberatory furnaces through an 8-in. main. Near these tanks is seen the installation of "mud bins" where clay is stored for mixing with crushed silica ore in the silica bin. These are mixed to form ganister in a Carlin mill for use in lining the converters. They are now little used under conditions of modern practice. The skull breaker consists of a strong grated hopper into which the skulls or shells, that form like a lining on the interior of the ladles, are broken. A weight lifted by the traveling crane is let fall upon these skulls, breaking them to a size for convenient handling so that the pieces can be charged into the furnace for melting down.

#### COSTS OF A PROPOSED PLANT AND OPERATION

For the year 1919 we give these costs for a proposed plant for the Consolidated Copper Mines Co. to be built at Kimberly, Nev. For this Frederick Laist, in charge of the works at Anaconda, Mont., who planned it, prescribes a single reverberatory-furnace plant of 445 tons daily capacity, using a charge of these items:

(1) 133 tons of concentrates of the composition Cu, 18 per cent;  $\text{SiO}_2$ , 20 per cent; Fe, 25 per cent, yielded from 2000 tons daily of "porphyry ore" of 1.2 Cu.

(2) 37 tons concentrates of the composition Cu, 10.5 per cent;  $\text{SiO}_2$ , 15 per cent; Fe, 32 per cent, and S, 34 per cent, made from 150 tons "sulphide" ore containing 2.9 copper.

(3) 150 tons of oxidized ore containing 7.5 per cent copper.

(4) 125 tons of fluxing materials.



It is assumed that these ores can be delivered to the reduction works at a cost of \$1.10 for the porphyry ore, \$5 for the sulphide ore, and \$10 for the oxidized ore.

The **reduction works** needed for treating this quantity of ore consists of a concentrating plant having a capacity for 2000 tons of porphyry ore and 150 tons of sulphide ore also a power plant capable of generating 3000 kw. which will furnish the power needed for water supply, operating the mining, concentrating and smelting plants.

The cost of the **water supply** is high, since it must be pumped to a total height of 967 ft., or against a total head of 1200 ft. and a distance of 13 miles.

The **concentrator** is to be constructed in two sections and provided with spare grinding mills and flotation machines, so that a breakdown of one of these will not affect operations.

The smelting plant mill comprises four 20 ft., seven-hearth Wedge roasters; one 100 ft. by 20 ft. reverberatory furnace equipped with waste heat boilers and a converting department containing two 12-ft. upright converters. The smelter building should be made of size to accommodate another reverberatory furnace. Such extension would cost \$50,000, while a second furnace would cost \$125,000 more.

#### ESTIMATED COST OF REDUCTION WORKS AS OUTLINED HEREWITH

Assume daily treatment—Porphyry ore.....	2,000 tons	
“ Sulphide ” ore.....	150 tons	
“ Oxidized ” ore.....	150 tons	
Water supply 1000 to 1500 gal. per minute.....		\$305,740
Crushing plant.....		100,000
Concentrating plant.....		450,000
Power plants—3000 kw.....		450,000
Drying plant.....		200,000
Reverberatory plant.....		350,000
Converting plant.....		150,000
Bins, rolling stock, shops, houses and miscellaneous.....		300,000
		<hr/>
		\$2,305,740
Engineering, drafting and contingency (say).....		194,260
		<hr/>
Total.....		\$2,500,000

This estimate is based on present cost of supplies and labor and is considered conservative.

The plant can be enlarged at any time, without interfering with operations, to 5000 tons of porphyry and 250 tons of oxidized ore, at an additional expense of about \$1,400,000.

## OPERATING EXPENSES

Assume smelter recovery at 95 per cent, operating costs are estimated as follows.

Power—\$0.01 per kw.-hr.

Concentrating—\$0.85 per ton.

Drying—\$0.45 per ton.

Reverberatory smelting—\$2.35 per ton.

Converting and casting—\$10 per ton of copper.

## TOTAL SMELTING EXPENSES

Crushing 275 tons ore, flux and secondaries at 15 cents.....	\$41.20
Roasting 445 tons at \$0.45.....	200.00
Reverberatory smelting 445 tons at \$2.35.....	1,045.00
Converting 37 tons Cu at \$7.50.....	278.00
Casting and loading 27 tons at \$2.50.....	92.60
	<hr/>
	\$1,656.80
Add 10 per cent for miscellaneous.....	165.68
	<hr/>
	\$1,822.48
Cost of smelting per ton ore concentrate mixture.....	5.70
Cost of smelting per lb. of copper produced.....	0.0246
Cost of concentrating per lb. of copper produced.....	0.0247

**Treatment of Porphyry Ores Alone.**—In order to convey an idea of the value of the porphyry ores alone, without admixture of high-grade "oxidized" ore, the following estimate is submitted. The complete treatment of porphyry ore alone locally would scarcely be feasible on a scale of much less than 5000 tons per day. This quantity of ore would, however, yield approximately 300 tons of concentrates, which would make the total amount of material to be smelted, including fluxes and secondaries, about 425 tons per day, which would be an economical operation for one reverberatory furnace.

The cost of the operation would be about as follows:

Assume recovery in bullion of 80 per cent of 1.4 per cent Cu = 22.4 lb. per ton.

## COST OF TREATMENT PORPHYRY ORE ALONE—5000 TONS PER DAY

	Per Lb. Cu
Mining at \$1.10 per ton of ore.....	\$0.0491
Concentrating at \$0.85 per ton of ore.....	.0379
Smelting at \$6 per ton of concentrates.....	.0179
Freight at \$16.60 per ton copper.....	.0083
Refining at \$22 per ton copper.....	.0110
	<hr/>
Gross cost.....	\$0.1242
Credit for gold and silver.....	.0050
	<hr/>
Net cost.....	\$0.1192

## CHAPTER XXXII

### THE HYDROMETALLURGY OF COPPER

#### PRINCIPLES OF THE HYDROMETALLURGY OF COPPER

The wet methods of extracting copper from cupiferous ore consist in obtaining the copper from the crushed and perhaps roasted ore, in water solution, either with or without the aid of other solvents such as a solution of ferric oxide or of sulphuric or hydrochloric acids. The copper must be in combination with elements that will permit it to dissolve in the solvents used. Thus, metallic copper would not dissolve in sulphuric acid, and chrysacolla is difficultly soluble. From the clear decanted or filtered copper-bearing solution the metal may be precipitated electrolytically, or with scrap-iron or with lime. The resultant "precipitate" is then melted and refined.

**Available Copper Ores.**—Copper has been extracted profitably from suitable ore of as low grade as 0.5 to 1.5 per cent copper when the conditions of an abundant and easily exploited supply and cheap labor prevailed. Such bodies of ore, much of it in oxidized form, occur throughout the world, often of too low grade to be treated by smelting, or too difficult of access. Besides this there are huge dumps, being the tailings of concentrating mills. Ore containing the copper as oxide, carbonate or sulphate is best suited to extraction, but if containing lime, magnesia, ferrous oxide, or manganese oxide, it is less desirable. Copper-bearing sulphides may be profitably treated for the extraction of the metal, the ore being oxidized by weathering until the sulphide has been changed into a sulphate soluble in water. Sulphide ores may be roasted with salt to bring them into form of a chloride, which then is extracted with brine solution.

**Advantages of Leaching.**—It would seem that for low-grade ores leaching should be superior to other methods, since the worthless gangue, which is the largest constituent of the ore, remains untouched, and the solvent acts on the relatively small quantity of valuable metal. Particularly does this seem to be true of silicious ores, the silica of which in no way interferes with the leaching, while they are expensive to smelt.

**EXTRACTION OF COPPER BY NATURAL OR WEATHERING METHODS**

- (1) By direct treatment of the raw or crude ore (Rio Tinto process).
- (2) By treatment of the ore which has been subjected to a preliminary roast in heaps (Shannon Copper Co. process).

**(1) THE RIO TINTO PROCESS**

**Outline of Process.**—The copper in the sulphide ore is brought into soluble form as sulphate, and from the filtrate the copper is precipitated by means of scrap iron. The copper-bearing pyrite is made into large flat-topped heaps which are oxidized by means of a regulated supply of water and air, and when the copper has been changed into sulphate, the material is leached with water to extract this. The clear solution is conducted to tanks filled with pig iron where the copper is precipitated.

When the copper in the ore occurs as chalcopyrite ( $\text{CuFeS}_2$ ) or as covellite ( $\text{CuS}$ ) oxidation proceeds slowly and imperfectly and, for successful working, it should be in the form of chalcocite or copper glance ( $\text{Cu}_2\text{S}$ ). It is because of the extent of the ore bodies and the cheapness of labor that the Rio Tinto process has been successful. This ore contains on an average 2 per cent copper.

**Preparation of Site and Heaps.**—A site is chosen upon impervious sloping ground for suitably draining off the solution as formed. A clayey or rocky bottom is required, or one properly puddled or coated with clay to render it impermeable. The heaps may contain 100,000 tons of ore and are constructed as follows: On the ground is first arranged a network of flues 12 in. square, made of lump ore. Vertical flues or chimneys that connect with the ground flues are built 50 ft. apart as the heap is made. The ore is broken to 3 or 4 in. diameter and some of the lumps are screened out for making the flues, leaving some fine. The run of ore is dumped and spread on the site in layers until this is 30 ft. high. The flat-top surface, having a grade of one in 300, is formed into 20 ft. squares by ridges of fine ore so as to ensure distribution of water within specified limits, and washing of the pile from the top to the ground flues or drains. Launderers are provided to carry water to the heap.

**First Operation.**—As the heap is forming, water is applied to extract any already-formed copper sulphate. Oxidation starts as the result of the wetting. The completed and wetted heap begins to oxidize rapidly, as shown by the heat evolved, the temperature of the air in the chimneys rising to  $70^\circ\text{C}$ . As the heat increases the ground flues are closed to control oxidation, and to spread the reactions through the heap. The surface assumes a brown color, due to the dehydration of the basic ferric salt that forms, and heating is made apparent by this drying action. Great care is taken to prevent the heap from catching fire.

**Chemistry of the Process.**—By the combined action of air and moisture the following reactions occur:

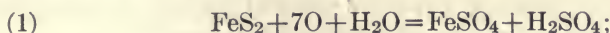

that is, pyrite is oxidized to ferrous sulphate and sulphuric acid. This ferrous sulphate is readily oxidized to ferric sulphate thus:



The thus-formed ferric sulphate acts on chalcocite and changes it in part to copper sulphate, itself reverting to ferrous sulphate according to this reaction:

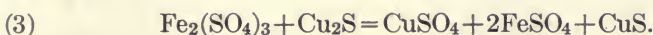

The cupric sulphide, hitherto unaffected is farther changed as follows:

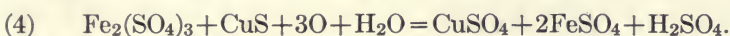

Reaction (9) is relatively rapid, and accordingly about half the copper goes into solution in a few months. Reaction (10) is slow, but in two years, under favorable conditions, yields 80 per cent of the remaining half of the copper.

**Extraction.**—When oxidation has advanced as far as is safe, water is applied at the rate of 220 gal. per minute until the soluble copper salts are extracted. The flow is then stopped and oxidation is resumed, and is followed by renewed washings. After a year the top-surface needs retilling; the ridges are arranged where the squares formerly were and the launders are shifted to conform. At the sides of the heap for the distance of some yards the ore has become cemented, and holds copper salts. These sides are dug down in terraces to expose the copper salts and to extract them by washing. When there remains but 0.3 per cent copper, extraction is considered complete. This pyrite heap, after the copper has been washed out, is still valuable as a sulphur-bearing pyrite, and many tons of such washed ore has been shipped away to the sulphuric acid makers.

**Reduction of Ferric Sulphate.**—The solution that flows from the heap contains ferric sulphate, and to prevent it from consuming iron in the precipitation tanks it must be reduced by running the liquor through a filter-bed of fresh iron-pyrite smalls or fines. The reaction is as follows:

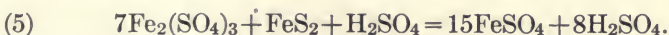

This filter-bed is retained within a reservoir formed by a masonry dam across a small ravine. The liquor, or solution after percolating the bed, flows to a common settling tank. It is then drawn off to a series of tanks, canals, or flumes containing pig iron. The typical solution entering the series would contain CuO, 4 per cent; Fe<sub>2</sub>O<sub>3</sub>, 0.1 per cent; FeO, 2.0 per

cent;  $\text{H}_2\text{SO}_4$ , 1.0 per cent and As, 0.03 per cent. The presence of so much FeO and  $\text{H}_2\text{SO}_4$  is due to the fact that a part of the waste or barren solution, leaving the series, is pumped back and used for watering the heaps, so that the solution tends to increase in these elements.

**Precipitation.**—The copper-bearing liquor or solution, drawn from the filter-bed, is run through precipitation launders containing pig-iron ingots piled in open order, and the copper is precipitated (replacing the iron which dissolves) in the form of “cement copper” or copper precipitate. Following the tanks the solution enters the canals, flumes or launders, arranged on the slope of a hill in such fashion that the solution may pass back and forth through them until it is discharged “barren” or free from copper from the end of the lowest series. These flumes are 320 ft. long,  $5\frac{1}{2}$  ft. wide by  $2\frac{1}{4}$  ft. deep. They begin at a grade of 2 in 1000, and the final flumes slope 11 in 1000. The rate of flow is thus increased and less pig iron is wasted. Some of the flumes are cut out from the flow or by-passed daily, the solution meanwhile going through the remaining ones. Those thus cut out are drained, and all the pig iron is removed and piled beside them, the copper attached to them being meanwhile knocked off and thrown back. The muddy precipitate at the bottom of the by-passed tanks and flumes is removed to the cleaning and concentrating plant, while the pig iron is piled back, and the flow of solution again directed through the flumes. Under the best conditions there is needed 1.4 tons of pig iron per ton of copper precipitated.

The first reaction in the tanks is that between unreduced ferric sulphate and the pig iron, thus expressed:



It is a reaction that wastes iron. Precipitation of the copper is brought about by an electro-chemical reaction, viz.,

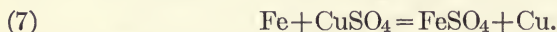

Finally a reaction takes place between the free sulphuric acid and the iron.

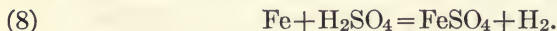

This reaction is evinced by bubbles of hydrogen rising through the tank liquor. It means a further waste of iron.

**Treatment of the Precipitate.**—At the cleaning plant, the crude precipitate, containing 70 per cent copper, by means of a strong jet of water, is gradually worked over and through a copper-plate screen, this screen being situated at the head of a long launder. The oversize of the screen,

consisting of leaf copper and small pieces of iron, is thrown into a heap to be picked over by girls who remove the scrap iron. The fine passes through the copper-plate screen, and is turned over by a stream of water that washes out the dirt and light particles, leaving the copper behind.

At the head of the washing launder for a few yards is found No. 1—precipitate of 94 per cent Cu and 0.3 per cent As. Farther along is No. 2—precipitate of 92 per cent Cu. Next comes No. 3—precipitate, which is fine, and contains 50 per cent Cu, 5 per cent As, some graphite (from the pig iron), and the bismuth and antimony precipitated from the liquor. Nos. 1 and 2 precipitate are sacked for shipment, and No. 3 is added to a blast-furnace matting charge, the copper combining to form matte, while the impurities mostly volatilize.



FIG. 221.—Method of Removing the Cement Copper.

It has been urged against the Rio Tinto process that it is a rather complicated and very lengthy process, and that it ties up too much capital. However, where labor is cheap, and forms the principal expense, where the ore is suitable and abundant, where the climatic conditions are favorable and water-supply sufficient, this, as experience has shown, seems to be the most practical of the methods thus far evolved. The process has been in use for centuries.

## (2) THE SHANNON COPPER CO. PROCESS

This process is principally used in treating oxidized ore together with sulphide. A typical oxidized ore may contain 1.9 per cent Cu, 40.8 per cent  $\text{SiO}_2$ , 16.5 per cent Fe; and 15.4 per cent of the alkali earths. If subjected to sulphuric acid leaching it would need 7.5 to 8.8 lb. of acid per pound of copper recovered and this proved so expensive that the present process was devised.

In operation, 1000 tons of the oxidized ore, crushed to 2-in. size, is piled on 100 tons of sulphide ore in circular heaps, and ore fines are added as a cover to the thickness of 1 ft. There are ground flues and stove pipes placed vertically, reaching from the sulphide bottom to the top of the heaps, all to provide draft for the burning of the pile. The sulphide ore, having been set on fire, evolves  $\text{SO}_2$  and  $\text{SO}_3$  gases which rise through the entire pile. At the same time the barren liquor from the precipitation tanks is sprinkled upon the heap. Reactions take place between the rising gases,

the iron sulphate solution and the oxides and carbonates of the ore, represented by the following:



and

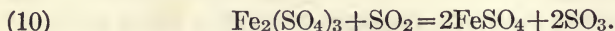

That is to say, ferric sulphate is alternately reduced to ferrous form by  $\text{SO}_2$  and the resultant ferrous salt again oxidized. In the reduction sulphuric acid is set free, and this is ready to dissolve the bases and the copper oxide. The sulphur trioxide combines with the bases directly, forming sulphates. Toward the end of the heap-treatment the pile contains much ferric sulphate, an effective solvent for basic sulphates and unaltered carbonates. Where the roast gases most effectively penetrate the pile, some 85 to 96 per cent of the copper is brought into soluble form, but the considerable quantity of clayey material in the ore causes clogging and hence imperfect action in sections of the heap.

The ore is transferred to circular tanks 25 ft. diameter, 5 ft. high and holding 75 tons each. These have a filter-bottom covered with cocoa matting. The ore, coarsely crushed, as already stated, is easily leached with water by percolation.

The copper solution from the leaching tanks, now containing much ferric sulphate, is run through a bed of raw oxidized ore, followed by a bed of sulphide ore or of tailings containing sulphide. The action of the ferric sulphate on the oxidized ore is to dissolve its contained copper, while the excess of ferric salt is later reduced to ferrous form as the result of its contact with the sulphides.

The copper liquors, as in the Rio Tinto process, are run into flumes or launders 300 ft. long, 5 ft. wide, and 2 ft. deep, containing scrap iron. The spent liquors from the launders carry as much as 3.5 per cent Fe as ferric and ferrous sulphate. The extraction ranges from 73 to 82 per cent of the contained copper. The copper precipitate is removed from the launders in the same way as in the Rio Tinto process.

#### EXTRACTION OF COPPER AS A CHLORIDE

By this method the ore, after crushing to 4-mesh size, is given a roast by which part of the sulphur is expelled. At this stage salt is added and the ore is finished by a chloridizing roast. After cooling, the roasted material is leached with a salt solution to extract the copper as chloride. The copper in the filtrate is precipitated on scrap iron. The process has the merit, that where gold and silver are present, they may also be dissolved and recovered. Ore of as high as 70 per cent silica, containing sufficient pyrite or chalcopyrite, and crushed to 16-mesh, can be given a



successful chloridizing roast with salt. If it contains no pyrite this can be added and a chloridizing roast given in from six to twelve hours, and the copper, gold, and silver leached out by means of water and dilute acid, the latter being obtained as a by-product of the roast.

We describe two methods, viz.: (1) The Henderson process, and (2) the Laist process.

**1. The Henderson Process.**—The well-roasted residue, or cinder, resulting from the pyrite used in making sulphuric acid, contains 2 to 4 per cent copper, with silver and gold. All these metals can be extracted by a chloridizing roast followed by leaching with weak liquor from a previous operation, containing water and dilute hydrochloric acid. The copper in the clear filtrate is precipitated upon scrap iron.

**The Plant.**—Fig. 232 shows the plan and a transverse sectional elevation of a plant of the Pennsylvania Salt Manufacturing Co., Natrona, Pa.

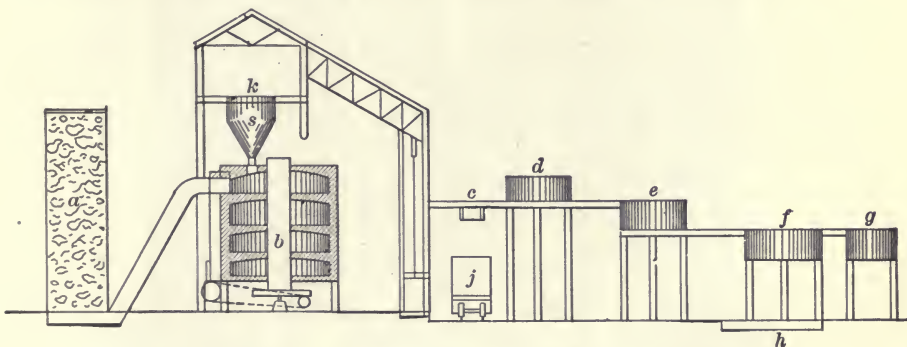
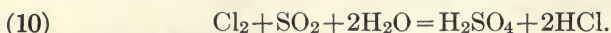

Fig. 232.—Elevation of Henderson Process Plant.

The cinder (red-roasted or burned pyrite) that is brought from the various sulphuric-acid plants throughout the country is ground dry to 20-mesh in a pan-mill, mixed during the grinding with 12 per cent of the weight of salt. This is raised by belt elevator to storage bins on the floor *K* and put into the roaster feed hopper *S*.

The mixture is sent to the five-hearth Wedge chloridizing roaster, Fig. 233. Each hearth is perforated with flues from side to side of the furnace. The flame from a firebox on one side, passing through these flues, reaches the vertical flue on the opposite side which leads away to the chimney. Dampers regulate the direction of the drafts. Thus the combustion gases are kept separate from the chlorine and the acid gases generated from the ore. Raw pyrite is charged with the mixture to have the ratio of copper to sulphur as one to  $1\frac{1}{2}$ . The hearth is maintained at a just visible red ( $525^{\circ}$  C.) by the use of 10 per cent of fuel. The gas, from the ore being chloridized, is down-drafted from the upper to the lower hearth,

then passes to the scrubber or condensing tower *a* filled with lump coke wet with a water spray. The water, in contact with the ascending gas, absorbs the chloride and sulphurous acid, reacting as follows:



That is, sulphuric acid and chlorine are formed, and these react in aqueous solution.

The charge when finished will contain 80 per cent of its copper in soluble form. It is drawn out upon the floor, allowed to cool, shoveled

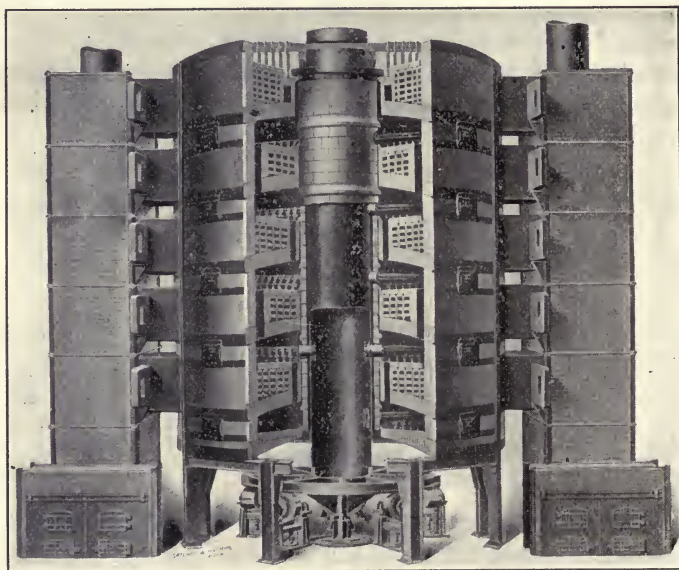

FIG. 233.—Wedge Chloridizing Furnace.

into charge-cars, raised by platform elevator to the charge-floor level, and put into the leaching-tanks *d*, each of which is 12 by 14 ft. in size.

The ore is first lixiviated with a weak liquor from a previous operation to remove most of the copper. The solution becomes a strong solution. The ore is then treated with water, to remove the remaining copper, and the solution becomes the weak solution of the succeeding operation. Finally, the weak solution of hydrochloric acid from the towers *a* is applied, dissolving the cupric oxide and cuprous chloride, hitherto insoluble. The residue, called "purple ore," is shoveled from the vats to the floor *c* and thence discharged into the railroad cars below.

The weak solution is sent to the lixiviation tanks. The strong solution, when the specific gravity reaches 18° B., is drawn to tanks 12 by 12 by 6 ft.

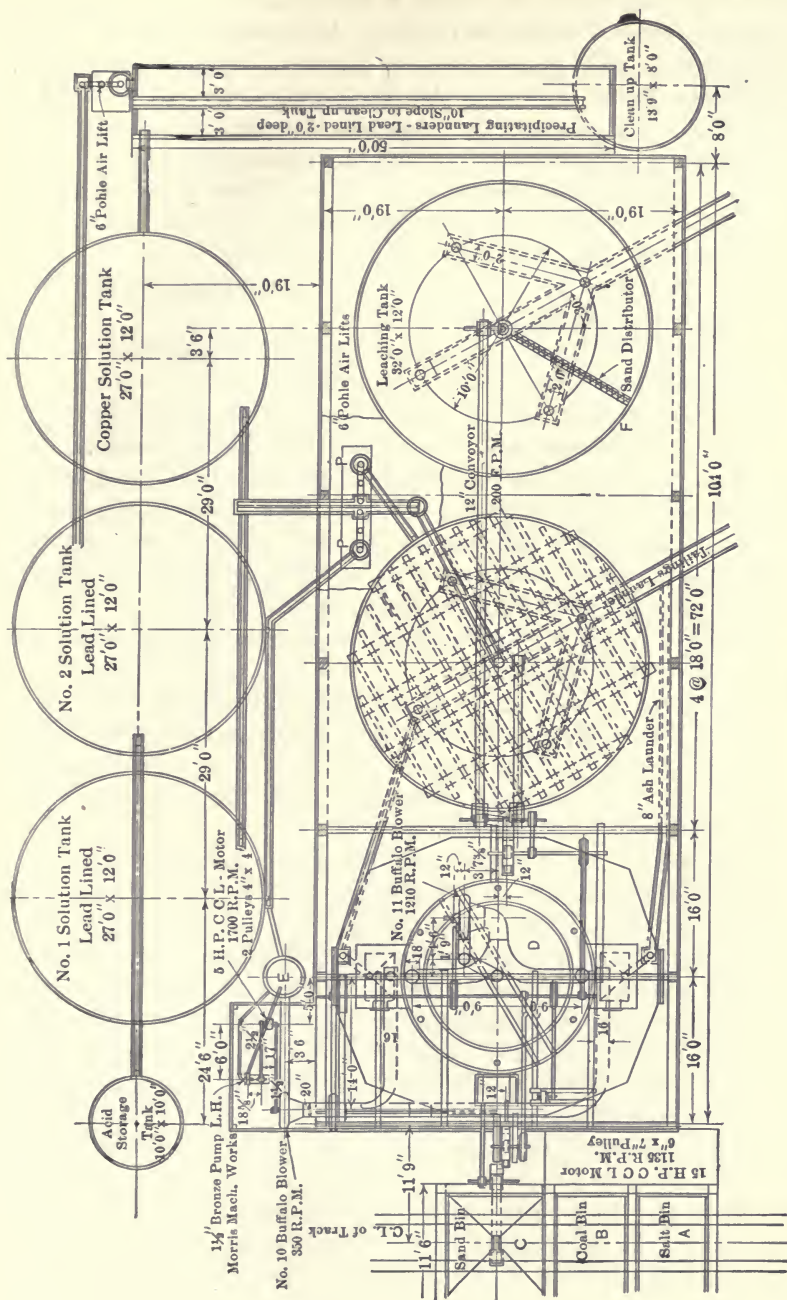

FIG. 234.—Plan of Leaching Plant (Laist process).

filled with scrap iron, where the copper is precipitated. The tanks have false bottoms of slats 2 ft. above the bottom. Live steam, directed into the solution, agitates it. The copper precipitating upon the iron, works down between the slats to the bottom of the tanks and is removed to tanks *g*, 10 by 10 by 5 ft. The solution from this tank is drawn into launders containing scrap iron as a guard, and to retain any remaining particles of precipitate. The precipitate is 90 per cent copper, 35 oz. silver, and 0.15 oz. gold per ton. It is sold to the blue vitriol makers, who pay 95 per cent of the silver and the full value of the copper and gold.

The cost of treatment by the process, with common labor at \$1.50 per day, is \$1.87 per ton of cinder treated.

**2. The Laist Process.**—This process is used in the treatment of mill tailings containing 0.55 Cu and 0.5 oz. Ag per ton.

The process consists in giving these tailings an oxide-chloride roast, using 1 per cent of common salt. The roasted ore is then leached, first with a No. 1 or weak solution containing 3.5 per cent  $H_2SO_4$  and 10 per cent salt, then with a No. 2 or strong solution of 6 per cent  $H_2SO_4$  and 10 per cent salt. The copper, dissolved by the weak solution, goes to tanks for precipitation on scrap iron; the strong solution, after use, is returned to be employed as No. 1 or weak solution on the next charge.

In Figs. 234 and 235 are given views of the leaching plant for the treatment of 60 tons of tailing daily.

Three bins, one *A* for salt, one *B*, for coal, and a third *C*, having a hopper bottom, are for the storage of the mixture of sand and slime tailing (4 of sand to 1 of slime) which is to be treated. These tailings contain 0.6 per cent Cu, 82.2 per cent  $SiO_2$ , 1.9 per cent Fe, 2.2. per cent S and carry 0.55 oz. Ag and 0.002 oz. Au per ton.

From the sand bin the material is delivered by a belt-feeder to a vertical elevator discharging into the feed-hopper of the 20-ft. MacDougall roasting furnace *D*. Referring to Fig. 236, the furnace is of the six-hearth type with a lower water-jacketed one for cooling the calcine or roasted ore. There are two fireboxes with shaking grates, discharging into hearth No. 2, which thus becomes a combustion chamber, where the coal gases burn with along flame and the products of combustion are drawn off by a No. 11 Buffalo blower to the chimney. On the upper three hearths or floors the tailings are roasted and brought to the temperature of  $540^\circ C$ . falling then to the floor, No. 4 where 1 per cent of common salt is fed in. During their passage over the fourth, fifth, and sixth floors the copper, as well as the silver compounds, are chloridized, the heat still present in the ore being sufficient to ensure the chloridizing reactions. A small volume of air is drawn through hearths Nos. 6 and 7 by a No. 10 Buffalo blower to an absorption tower, *E*, so as to catch any copper or silver that has been volatilized. This tower, filled with coke, is showered with water delivered to



it by a 1½-in. bronze pump. To withstand the chlorine fumes evolved from the cooling ore on the seventh hearth, copper rabbles are provided.

The cooled ore is delivered by a horizontal screw-conveyor to a ver-

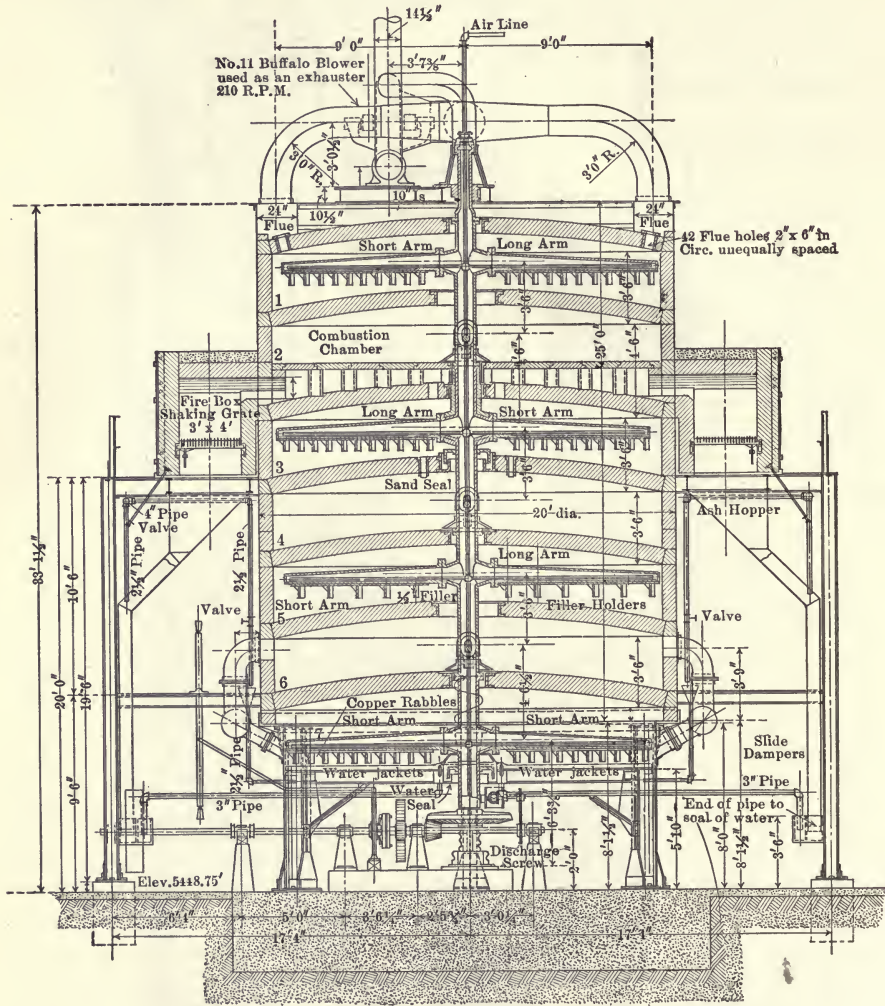

FIG. 236.—Sectional Elevation of Roasting Furnace.

tical elevator which discharges it upon a 12-in. belt-conveyor to the sand distributor of one of the 32 by 12 ft. "leaching tanks." The distributor, revolving about the axis of the tank, delivers the calcine evenly over its whole area. When ore has been roasted and its colloids destroyed, it

is in excellent condition for leaching. The leaching tanks will hold 350 to 400 tons.

There are two lead-lined solution-tanks each 27 ft. diameter by 12 ft. deep. "No. 1 solution tank" contains the No. 1 or weak solution of  $3\frac{1}{2}$  per cent  $\text{SO}_4$  and 10 per cent of common salt; "No. 2 solution tank" carries the strong solution of 6 per cent  $\text{H}_2\text{SO}_4$  and 10 per cent salt. For a 320-ton charge, the No. 1 solution is run on the tailing first to get out the bulk of the copper, and remains in contact with it for fourteen hours. This solution, the only one precipitated, is run out by a launder to one of the 6-in. Pohle air-lifts *P, P*, which raises it so that it is carried to the 27 by 12-ft. "copper solution tank." From this tank it flows in a regulated stream to one of the "lead-lined precipitating launders" at the end of the building filled with scrap iron, where the copper and silver are quite precipitated. The spent or barren liquor flows to waste. The precipitate, when a clean-up is made, is washed down into the "clean-up tank," and the precipitate collected for further treatment.

To return to either leaching tank: Twenty-four tons of strong or No. 2 solution is run on, and stands for seventy-two hours, after which it is returned to "No. 1 solution tank" as weak or No. 1 solution. Following this the remaining values are removed with water-washes. The final tailings are sluiced out of the tank with a 2-in. hose, and sent to waste by means of a launder carrying a 3-in. stream of water. The arrangement of the launders and of the four discharge valves of a tank are well shown on the plan.

The percentage of recoverable copper is 85.4 and of silver 91.1.

### SULPHURIC ACID LEACHING

This method of extraction is suited to a limited range of ores, those which will not consume much acid (generally lost in uselessly dissolving bases) and those in which the copper minerals are present in soluble form. As regards the first objection, there are oxidized copper ores containing iron oxide and especially the alkali earths which consume acid. The copper minerals unattacked by sulphuric acid are metallic copper, cuprite, fresh unaltered sulphides such as chalcopyrite and covellite, and massive chrysacolla. When, however, the ore contains malachite, azurite, copper oxide, and basic sulphates mainly, then it may be quite suited to sulphuric-acid treatment.

Although we have a suitable ore, still the acid will act on the clayey minerals, the iron oxides and the alkaline earths so that these bases should be present in small quantity only. The waste of acid is not the only drawback; the bases named accumulate in the solution, which naturally is to be re-used, and finally the whole has to be run to waste and fresh acid used.

When, to save scrap iron, electrolytic precipitation is employed copper is indeed precipitated, but the  $\text{SO}_3$ , released from the electrolyte, oxidizes the ferrous oxide present to ferric form and this at once proceeds to redissolve the copper. True, porous diaphragms have been used to confine the ferric oxide to the anodes, but this, aside from added expense, increases the resistances. Farther, no anode is altogether satisfactory. If of lead, this is gradually changed to peroxide by the oxidizing effect mentioned, and, while the peroxide may be recovered and again reduced to lead, this increases working costs.

The electrolyte becomes foul, owing to the accumulation of sulphates of iron and other metals, and it is necessary periodically to send some of the solution to waste, thus causing a loss of acid. Regeneration of the acid is effected, and in fact, when sulphur dioxide is injected into the electrolyte as a depolarizer, an excess of acid is obtained by the combination of the  $\text{SO}_2$  with the nascent oxygen liberated at the anode; still so many reactions occur among the foreign metals present in the electrolyte, and so much trouble has been found in properly regulating the current density, that a great deal of current is wasted in excess of that theoretically needed. In the deposition from a copper sulphate solution this would be 2.14 lb. of copper per kilowatt-hour, but in practice but 50 per cent of this has been obtained. With a pure electrolyte and taking proper precautions to prevent wastage at the cathode an efficiency of 90 per cent or 2 lb. Cu per kilowatt-hour should be attained. These precautions would consist in precipitating the interfering metals by chemical means before the solution goes to the electrolytic cells. With such efficiency the cost, especially where hydro-electrolytic power is available, should not exceed 1 cent per pound of copper deposited. The advantages of electrolytic precipitation are that the acid is regenerated and that a pure copper is produced.

We describe herewith two methods which have worked well upon suitable ores:

- (1) The Butte-Duluth process.
- (2) The Ajo Process.

#### (1) THE BUTTE-DULUTH PROCESS

The ore exists as a large body of decomposed granite carrying 2 per cent of copper as copper carbonates chrysacolla and cuprite.

Briefly stated: The crushed ore is leached with sulphuric acid, the filtrate heated to  $60^\circ \text{C}$ ., the copper electrolytically deposited, and the remaining solution, still containing copper, strengthened with acid and returned for re-use. The ore is farther leached with water, the water run through other ore, then over scrap iron to obtain the remaining copper.

The ore, crushed to suitable size for leaching as described under crush-



ing, is fed to three rectangular leaching tanks, 70 ft. long, 12 ft. wide by 6 ft. deep, lined with sheet-lead and having plugged bottom-openings 12 in. diameter. There is a false or filter bottom made of 2-in. planks, bored full of  $\frac{5}{8}$ -in. holes, for the passage of the solution. The leaching tanks, when filled, are treated with a 10 per cent solution of sulphuric acid, which remains upon the ore for twenty-four hours, dissolving most of the copper. This copper-bearing solution, still containing 5 to 8 per cent  $H_2SO_4$ , and having 2 per cent Cu, is drawn from the tanks and passes to a storage sump. From the storage sump it is lifted by steam-lifts into the

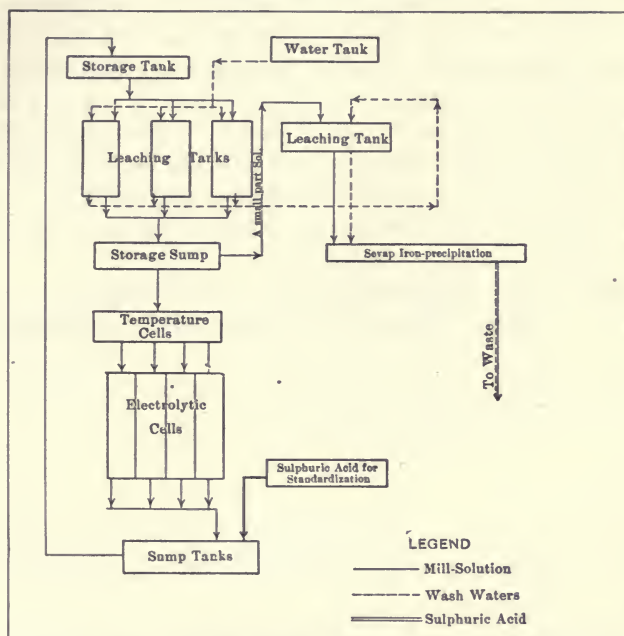

FIG. 237.—Solution Flow-sheet, Butte-Duluth Mill.

temperature cells, these heating the solution to the desired temperature of  $60^{\circ} C$ . The temperature cells are lead-lined wooden tanks.

From the temperature cells the solution flows through the electrolytic cells, where part of the copper is deposited and acid regenerated. After flowing through these cells, the  $H_2SO_4$  has been raised to about 1 per cent in strength. The cells (shown as a rectangle divided into four) consist of twelve cells each 8 ft. long 30 in. wide and 39 in. deep, lined with 4-lb. hard lead. In each cell are twenty anodes of hard lead weighing 10 lb. per square foot and nineteen cathodes, being starting sheets weighing 2 to 3 lb. when first placed. These remain in the cells seven to ten days. They grow to 40 to 60 lb. before removal and assay 99.96 per cent Cu. The anodes and cathodes are electrically connected in multiple, the cells in series.

The solution passes to the sump tanks where it is strengthened to 10 per cent  $H_2SO_4$ , the acid being received from a tank marked "sulphuric acid for standardization." From the sump tanks the strengthened solution is pumped to the storage tank placed 40 ft. higher, so as to connect the "leaching tanks" by gravity. The pumping is effected by the aid of two 4-in. lead-lined centrifugal pumps.

Returning to the leaching tanks: The ore has just been leached with the 10 per cent solution coming from the storage tank above. This is followed by several water-washes from the "water tank." The first wash-water containing sulphuric acid is added to the mill solution of the storage sump. The remaining washes, weak in acid, go to the leaching tank shown at the right side of the flow-sheet. In order to keep the mill solution pure, and prevent it from accumulating, a quantity of it, equal to the first wash-water, is passed by the line marked "a small part sol." through ore in the right-hand leaching tank until its contained acid is used up by acting on the ore, then run to the launder marked "scrap-iron precipitation"; the spent solution is wasted. Thus part of the copper is recovered electrolytically and a small part by means of scrap iron.

The costs are thus roughly given per pound of electrolytic copper produced on the treatment of 50 tons, recovering 2000 lb. of copper daily:

$3\frac{1}{2}$ lb. acid at \$27 per ton.....	\$0.04725
Power for crushing and electrolytic deposition.....	0.01
Management and labor \$160 daily.....	0.08
	\$0.13725

The cost for acid should be greatly reduced, and the labor costs are excessive, due to construction work and alterations in addition to actual operating.

## (2) THE AJO PROCESS

**The Process.**—This, in brief, consists in leaching the ore (crushed to  $\frac{1}{4}$ -in. size) for eight days by a counter-current system; reducing the ferric iron in the resultant solution to ferrous form, using sulphurous acid gas ( $SO_2$ ) to do so; and electrolytically precipitating out part of the copper, which is then returned to the leaching solution.

**Coarse Crushing.**—This is done during two eight-hour shifts, since there is no storage between the plant and the mine. The ore, some of 3 to 4 ft. in minimum dimension, is crushed in two sets of gyratory ore-breakers to 4-in. size, then delivered to a storage-bin of 10,000 tons aggregate capacity, as is clearly shown by the general flow-sheet, Fig. 238.

**Fine Crushing.**—This is done between 3 P.M. and 7 A.M., but can be kept up for twenty-four hours if necessary. The ore is crushed in two



stages by means of Symond's disk crushers, the ore being drawn off and crushed according to the immediate needs of the leaching plant.

**Leaching.**—Of the twelve tanks eleven are for leaching, the twelfth is a solution settler. Of the eleven, seven always contain ore in process of leaching. Referring to the flow-wheel, we may assume that the ore in tank No. 10 is the oldest, and No. 5 the newest in the circuit; the No. 6 is being charged with ore, No. 7 is empty, No. 8 is being excavated and No. 9 in various stages of washing and draining. When tank No. 6 has been charged, and it is ready for the leaching cycle, the "acid advance," that is, the amount of acid-bearing solution that proceeds from tank to tank is increased to its maximum amount of 2000 gal. per minute for four hours, this solution being gotten from storage tank *A* or *E*. Meanwhile the usual advance of 1000 gal. per minute continues to go from tank No. 5 to six reducing towers marked in pairs  $S_1$  to  $S_3$ , where it is subject to the reducing action of  $SO_2$  in water solution. The excess of 1000 gallons is advanced into tank No. 6 until the ore is covered with it—this, in order to prevent any interruption of flow to the towers. When the ore is covered the excess advance is cut off to the normal of 1000 gal. per hour. Solution on the new charge is now circulated on itself, until it is clarified, or for about four hours. Tank No. 6 is now put in circuit and the neutral advance (acid free solution) to the tower comes off from tank No. 6 in place of tank No. 5.

The leaching of the ore in tank No. 6, now begun, continues for seven days, during which the free acid in the solution increases from 0.5 per cent to 3.0 per cent on the seventh day. At the end of the seventh day, the "acid advance" from the tank house is transferred from tank No. 10 to tank No. 11. Upon the entrance of a new charge into the circuit, the solution remaining in the oldest tank is drained to solution storage, where it is standardized by additions of sulphuric acid and is later used as "acid advance." After draining the tank is ready for wash-water. As the copper that is taken away in the leaching is about two-thirds the total, the question of thorough washing, to remove the rest, is important. Four successive washings with the drainings between are used. During the three-hour circulation that each wash is given, an equilibrium between the dissolved copper in the tailings and that of the wash-water being applied, is expected to be reached. To follow more readily the method of washing a charge the flow-sheet must be referred to. When tank No. 9 has been thoroughly drained, the charge is covered with wash-water from *W*, circulated, then drained to solution storage tank *A* or *E*; this constitutes the first wash. It is now covered with wash-water from  $W_2$ , similarly circulated and drained to *W*. In the same way the wash-water from  $W_3$  is put on, circulated and drained. The fourth or last wash, consisting entirely of fresh water, is pumped, circulated and drained into wash-water tank  $W_3$ . In this manner the fourth wash of any one charge is used as

the third wash of the succeeding charge, the third as the second, and the second wash as the first. In other words each wash-water is used four times, the copper contents increasing each time, when it enters the system and makes up for the continuous losses of solution due to evaporation, to discard and to about 11 per cent of solution taken away in the tailings. Thus, before the first wash the solution contained 2.56 per cent acid and 2.4 per cent copper, while at the end of the fourth wash there remained 0.10 per cent acid and 0.38 copper. To obtain an even better extraction of the copper it has been proposed to give a fifth wash, then allowing the resultant solution to flow over scrap iron.

**Arrangement of the Leaching System.**—The twelve leaching tanks are arranged in two rows, as shown on the flow-sheet, and more particularly as seen in the sectional transverse section, Fig. 239. The aisle between the two rows of tanks is 108 ft. wide and contains what is called the "central structure" of the same length as the row of tanks. This consists of six heavy concrete piers each of four pillars supporting steel trusses from

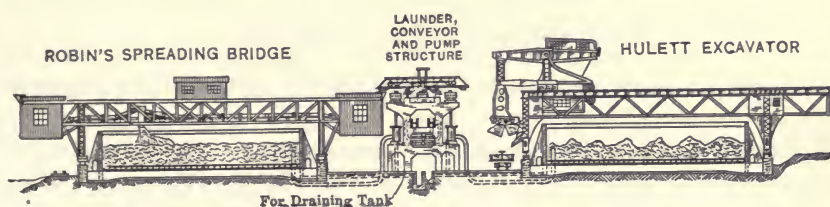

FIG. 239.—Cross-section of Leaching-tanks.

pier to pier. The structure has two decks, the upper carrying the belt-conveyor, the lower the solution launders and the pipe-lines. At each concrete pier are four pumps and pipe connections. Underneath the central structure and parallel to it are to be seen the two drainage launders used in carrying the solutions from the leaching tanks to the solution storage.

The ore, from storage as finally crushed, is conveyed through an automatic sampling plant, and thence by a main conveying-belt the full length of the central structure. To fill any desired tank there is a tripper on this main conveyor that delivers to the belt of a Robins spreading bridge. This bridge set over any desired tank delivers its load into it from side to side and can be moved to fill any part of the tank.

**Removal of Tailings.**—After a charge has been washed and drained, the tailings are removed by a Hulett excavator, similar to those used in unloading iron ore at the lower lake ports. A heavy steel bridge on tracks spans the leaching tanks and can travel their entire length. On this bridge travels the excavator, consisting of a walking-beam, bucket-leg, and bucket

of 12 tons capacity. This will unload the tank at the rate of 500 tons per hour. Two eight-car trains are released from mine-service at 4 P.M. for the transportation of tailings, and twenty-one to twenty-three train loads are required when removing the contents of a tank. When it is desired to exchange places for the spreading and excavator bridges it is thus performed: Just beyond the last tank is a transfer-table track and just beyond the transfer-pit are tail-tracks matching the bridge tracks. The unloading bridge, for example, is run over the transfer table upon its tail-track. The transfer table is then moved to match the excavator bridge, which is then run upon it, moved over to the other set of tracks and set in place ready for unloading a tank. The unloading bridge in its turn is put on the transfer table, transferred and set in place on the other set of tracks.

**SO<sub>2</sub> Towers.**—In the electro-deposition of copper from a sulphuric acid solution any iron in ferric form will be reduced by the current to ferrous form, thus using up electric energy. To overcome this SO<sub>2</sub> gas was employed to bring the ferric iron into ferrous form according to the equation



Where care was taken to send to the SO<sub>2</sub> towers neutral or slightly acid solutions, this proved easy.

**Roasting for SO<sub>2</sub>.**—Referring again to the flow-sheet, Fig. 238, there are six seven-hearth roasters which carefully roast 75 tons daily of Bisbee pyrite ore. The strong gas, containing 8 to 10 per cent SO<sub>2</sub>, leaving the roasters passes to a Cottrell precipitator or treater, where it is cleaned from dust before it enters the spray or cooling chamber. Upon the top and sides of the chamber are nozzles by which about 100 gal. per minute of "neutral advance" solution is sprayed to cool the gas before it enters the reducing towers. The ferric iron in this solution is at once reduced to ferrous form.

There are six towers built of sheet-lead and arranged in pairs. They are 20 to 28 ft. diameter by 40 ft. high and rest on a concrete base, the lower edges dipping into a lead-lined sump, 6 ft. deep, so that the edge below the surface of the liquid in the pan forms a seal against the escape of the gas. The tower space is filled with boards cross-piled on edge and 1 in. apart. The solution comes to the top of the tower by launder and enters it through gas seals, that is a siphon-shaped pipe, that lets the solution through without letting the gas escape. The solution going through these seals trickles down through the boards, wetting them, and is subject to intimate contact with the strong gas, cooling it to atmospheric temperature, and at the same time reducing all the iron present to ferrous form. Between the second and third towers is a 60-in. suction-fan made of lead. This draws the gas from the roasters through the Cottrell treater, spray-

chamber, and third set of towers, and forces it through the second and first sets to the atmosphere.

The solution or neutral advance, say 900 gal. per minute, travels counter-current to the flow of gas, that is, the most reduced solution comes in contact with the strongest gas. The solution from the newest tank of ore is pumped to the top of the third pair of towers ( $S_3, S_3$ ) by a 9-in. centrifugal pump. From the bottom of these it is lifted to the top of  $S_2, S_2$ , and from their pumps to the top of  $S, S$ . From the bottom of these it is pumped by  $P_5$  to the settling tank, the fourth tank of the nearest row. The purpose of this tank is two-fold; to settle out the slime and to cause additional reduction as the solution stands. The average of ferric iron in the solution entering the towers is 0.80 per cent and of that leaving the settling tank to go to the electrolytic tank house only 0.10 per cent  $Fe_2O_3$ .

**Electrolytic Deposition.**—The electrolytic tank house is arranged much as in electrolytic copper refining, which see. The tanks are arranged in banks with sills between. There are 12 banks of 10 tanks each and 4 banks of 8 tanks each. Each tank has 84 anodes and 77 cathodes per tank. The anodes are of hard lead, containing 3.5 per cent antimony; the cathodes are copper starting-sheets, originally 15 to 18 lb. in weight, while the finished cathodes weigh 130 to 140 lb. each. Of the total of 152 tanks, 25 are reserved, being employed making starting-sheets, the remaining 127 tanks are depositing copper on the sheets for the production of cathodes. The starting blanks upon which the starting sheets are made are of antimonial or hard lead like the anodes.

The electric current is passed through each tank in parallel and through them all in series. It is supplied by two identical units each of 15,000 amperes and each having seventy-six tanks in series.

**The Electrolyte.**—The solution entering the tank-house contains Cu 3.0 per cent, Fe in ferrous form 2-3 per cent, Fe in ferric form 0.085 per cent. When it leaves the tank house to go to T. H. R. (tank house return) sump its copper has fallen to 2.5 per cent, that is, 0.50 per cent has been deposited, the ferrous iron has decreased to 1.66 per cent and the ferric iron correspondingly increased to 0.75 per cent. Sulphuric acid has also been set free, there being 2.10 per cent as against 1.70 per cent entering the tank house. The average weight of copper deposited per kw. hour may be given at 0.8 lb.

As will be seen in the flow-sheet the tank-house return-solution is made up by addition of solution from tanks  $E$  and  $A$  and, if necessary, the acid in it is strengthened by the addition of strong acid made at another plant. This is in order that the strongest acid solution shall go to the newest tank. The new acid, that brought from the outside, will amount to 60 per cent of the total acid consumed. Of the remaining 40 per cent some 32 per cent is regenerated in the  $SO_2$  towers and 8 per cent at the electrolytic tanks.

Only about half of the total acid used in an eight-day leaching is utilized in dissolving copper, the remainder is used up in dissolving impurities. Therefore these impurities gradually accumulate, making the solution more and more sluggish. To keep the solution active a portion must be discarded and replaced by fresh water introduced at the last wash. This daily discard must be such that its impurities shall be equivalent to those taken up each day. In this particular plant it amounts to 90 gal. per minute out of the 1324 of neutral advance.

The copper in the discarded solution is recovered by passing through scrap-iron boxes or launders, just as described for the Rio Tinto process, which see. It takes 2 lb. of iron scrap to precipitate one of copper. The resultant precipitate, which contains perhaps 75 per cent copper, is shipped away for smelting. About 10 to 15 tons of copper is recovered in this way daily. The cathodes from the electrolytic tank house are quite pure, containing as high as 99.85 per cent copper.

#### AMMONIA LEACHING

**Limitations of the Process.**— This is suited to the treatment of a mixture of sulphide and oxidized ores, that may contain so much calcite and dolomite as to forbid acid leaching. The sulphides are removed by concentration and the tailings, containing the copper carbonates and oxides, are leached out with a carbonate of ammonia solution. Where, as in the Lake Superior region, the copper occurs native, then this is likewise removed by concentration except the finest particles of native copper which, with any copper oxide, may be dissolved by the ammonium carbonate. In the case of malachite we have the reaction



the  $\text{CO}_2$  gas escaping freely. The reaction with azurite is similar. The fine copper particles with free access of air are oxidized to copper oxide and

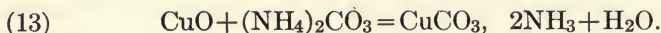

Where the air does not have free access, the cupric salt thus formed comes in contact with the oxidized copper particles and is reduced to the cuprous state.



However, this latter compound, coming where there is access of air, again rapidly oxidizes to cupric form, and can then proceed to dissolve an additional quantity of native copper.

Upon subjecting the solution to boiling by steam, the ammonia and carbon dioxide of the cupric carbonate are distilled off thus:

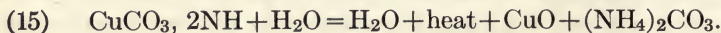



The copper oxide falls out of the solution as a heavy powder, and the ammonium carbonate is absorbed by water and this recovered for further use.

#### AMMONIA LEACHING AT KENNICOTT

We present in Fig. 240 the plans and elevations of an ammonia-leaching plant for the treatment of tailings containing 1.46 per cent copper or of 1.14 per cent copper in soluble form as copper carbonates. After ammonia treatment the residue, going to waste, still retained 0.26 per cent of copper indicating a recovery of 77 per cent of the soluble portion.

Referring to Fig. 240, section *Z, Z*, the tailings are brought by a launder to the 275-ton storage bin. Thence, when needed to fill the leaching tanks (see the elevation), they are raised by a vertical belt elevator, and after a Vezin sampler has taken out a portion, are transferred by a short, inclined conveyor to the long distributing conveyor, seen in the plan running over the leaching tanks. When leached, the exhausted tailings are removed by a tailings-discharge conveyor beneath. The tanks are 30 ft. diameter and will hold 500 tons. They are filled from the distributing conveyor by a revolving plate provided to distribute the feed evenly over the whole area and to give a uniform mixture of coarse and fine. A dome-shaped cover is then put on.

The first leaching solution, consisting of rich copper-ammonia solution from a previous leach, together with concentrated ammonia from the still is run into the tank at the **bottom**, and rises through the charge, displacing the moisture of the tailings before it. The first part of this moisture, practically barren, is sent to waste. Rich solution is now brought on **top** of the charge and leaches downward. As fast as the downward flow continues it is returned from below by means of a centrifugal pump to the top of the charge, this being kept up as long as the solution will dissolve the copper, or for about thirty hours. The leaching solution, carrying  $4\frac{1}{2}$  per cent Cu and 7.5 per cent  $\text{NH}_3$ , is now drawn off, part going to the evaporators *B*, part to the rich solution storage tank *A*. This is followed by a weak copper ammonia solution as a preliminary wash, which follows the rich solution down through the charge. When this begins to appear it is turned into the wash-solution storage tank *A*. Following comes the steam wash. Steam, at a pressure of 5 lb. per square inch, is admitted above, and gradually works to the bottom, heating the charge and condensing to a film of water which displaces most of the copper-ammonia solution. The remainder of the ammonia, volatilized by the steam, is carried out with it to be condensed in one of the condensers *D*. When the ammonia content of the vapors issuing from the tank has fallen to 0.5  $\text{NH}_3$ , the wash is considered finished, the steam is shut off and the tank is emptied of the exhausted tailings. The steam washing takes about twenty

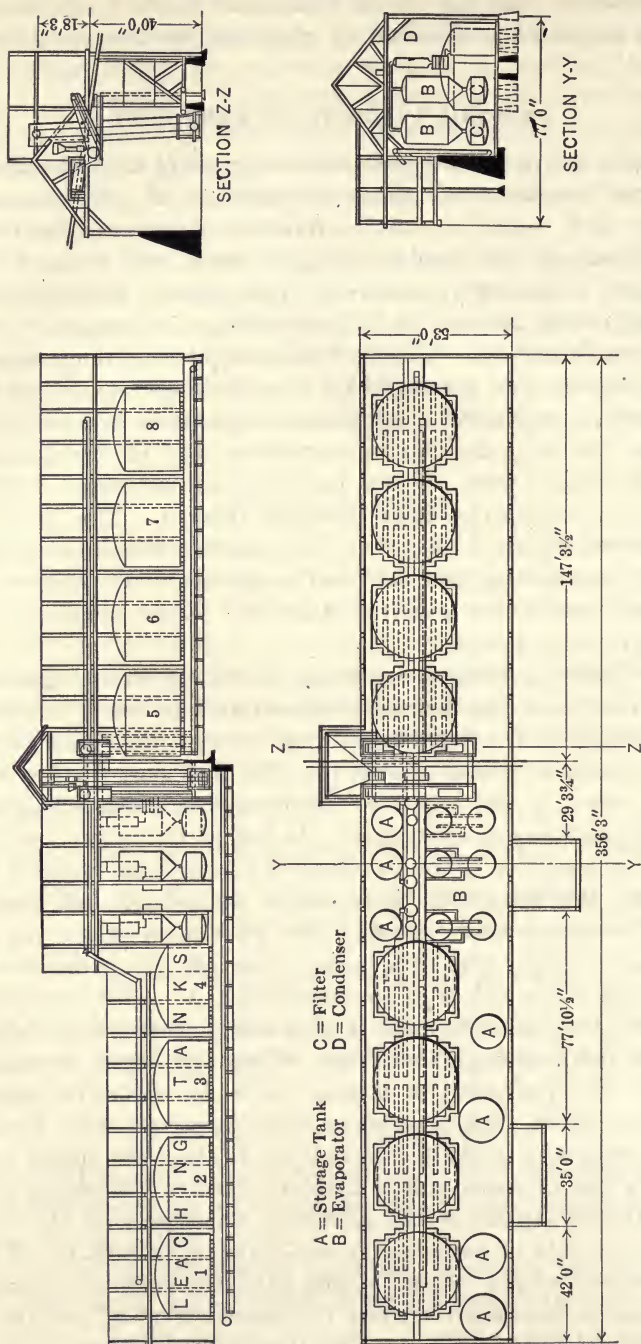

Fig. 240.—Ammonia Leaching Plant at Kennecott, Alaska.

hours, and about 100 lb. of steam is used per ton of charge. By this method of steam washing one can leach rich ores with little loss of ammonia in the tailings and without using a large volume of wash-water, which would too greatly dilute the distilling solution.

There are three units of evaporators. Section *Y, Y* shows one of these units, the evaporators *B B* in two stages, each provided below with a filter *C*. As the copper-ammonia-bearing solution is evaporated, the volatile ammonia vapor passes over to be condensed in the condenser *D*. By thus arranging the evaporators in double effect the ammonia, concentrated to at least 18 per cent  $\text{NH}_3$ , is obtained. The copper oxide falls out of the solution as the ammonia leaves it, to the conical bottom, of the evaporator and passes to the filters *C, C*. The precipitate contains as much as 80 per cent  $\text{Cu}$ , the filtrate carries but 0.4 per cent  $\text{Cu}$  and 0.9 per cent  $\text{NH}_3$ . This is re-treated in a secondary operation to precipitate the balance of the copper and to produce a waste solution of but 0.025 per cent  $\text{NH}_3$ .

The ammonia is originally purchased as aqua ammonia or ammonia hydrate, but soon picks up  $\text{CO}_2$ , then becoming ammonium carbonate. Due to the large amount of  $\text{CO}_2$  evolved in the leaching, vents are provided in the tank covers.

It will be noticed that if the tailings contain gold or silver in such quantity as will justify it, these metals may be readily cyanided. The tailings, acid free, are in excellent condition for such treatment.

## CHAPTER XXXIII

### REFINING OF BLISTER-COPPER

#### COPPER REFINING

Blister-copper, or black copper, whether produced in the blast-furnace, the converter, or the reverberatory furnace, or by melting the concentrate from the native copper ore of the Lake Superior region, still contains impurity, principally arsenic with sulphur and iron, and all impurity must be removed by refining. If the copper contains gold and silver in quantity to warrant (20 to 40 oz. silver per ton), it is melted without attempting to refine, and cast into anodes that then are subjected to electrolytic refining. If there is but little precious metal in the copper, it may be directly refined in the copper refining-furnace. Fig. 241 is a sectional elevation and plan of a 40,000 to 60,000-lb. copper refining furnace. It is 14 by 19 ft. hearth dimensions, and has a fire-box  $5\frac{1}{2}$  by  $6\frac{1}{2}$  ft., or 30 ft. area, and carries a fire-bed  $4\frac{1}{2}$  ft. thick. The hearth,  $2\frac{1}{2}$  ft. deep, has a brick or a sand bottom. If of sand, the bottom is carefully smelted in. Beneath, the hearth is vaulted for ventilation. The bridge, 5 ft wide, is strengthened by a double conker-plate, and on either side and in the roof over the fire-bridge, are ports that are opened when an oxidizing flame is desired. In the elevation, at the front end, is to be seen the outlet-flue that leads to the stack or chimney. The chimney is close to the furnace, but is not shown in the plan. The charge of ingots of blister-copper is put in at the side door. The door is then tightly closed, and vigorous firing follows. The charge melts after several hours. The front door is then opened, and whatever slag has formed during the melting is skimmed.

Next follows the rabbling, the object of which is to oxidize a portion of the copper and the impurities with it. The operation years ago consisted in striking the surface of the bath with a rabble in such a way as to splash the metal and agitate it, thus exposing it to the action of the air. The present way is to insert a  $\frac{3}{4}$ -in. pipe just beneath the surface of the metal and force compressed air through it to agitate, and at the same time to oxidize it. The air-ports of the furnace also are opened and the flame is made an oxidizing one. The action proceeds to the stage of "set copper,"  $\text{Cu}_2\text{O}$  having been by this time formed, and in part dissolved in the copper.

Iron, sulphur, and arsenic partly volatilize, and partly oxidize and enter the slag that is formed at the same time; this is skimmed off.

The copper oxide must be removed by poling. This is a reducing action in which the air-ports are closed to give a reducing flame, and spruce or

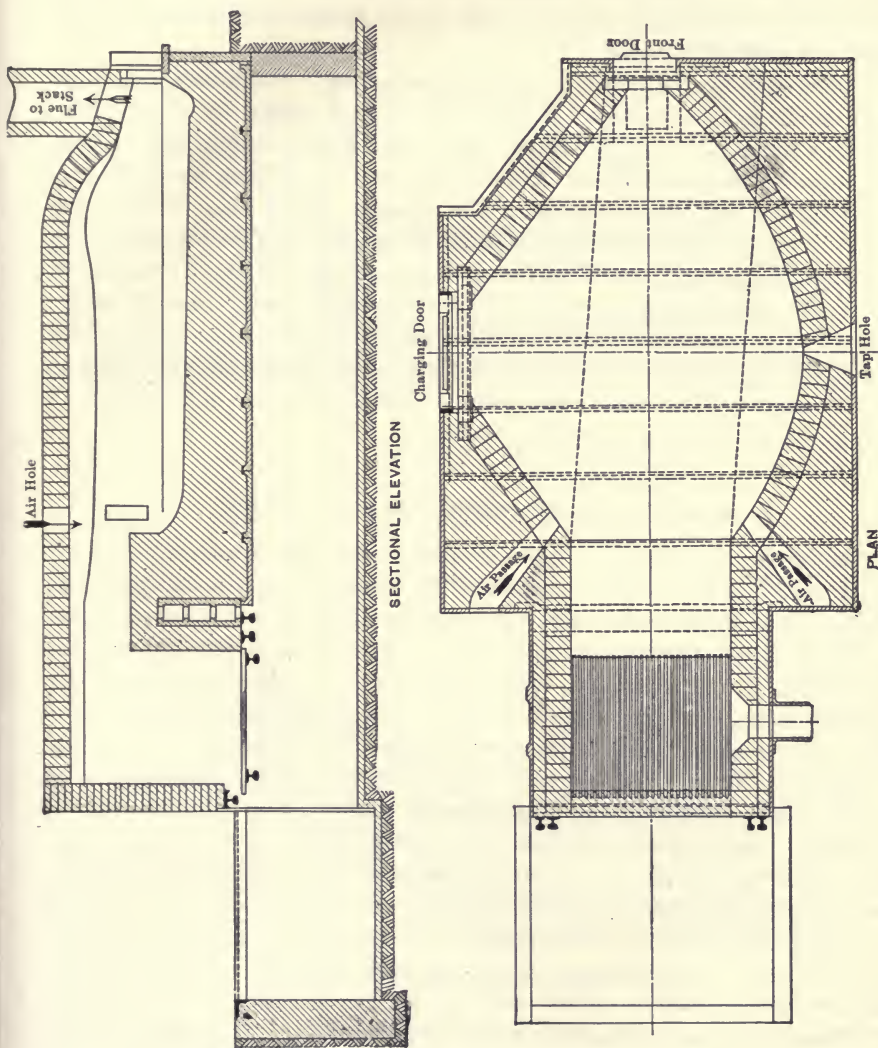

Fig. 241.—Copper-refining Furnace.

poplar poles are inserted at the front door into the metal. The outer end of the pole is raised to force the butt-end beneath the surface of the metal. At the same time a wheelbarrowload of charcoal is thrown in to cover the surface, to exclude air, and to reduce cuprous oxide. As the hydrocarbon

of the wood is evolved and the moisture evaporates, that is, as the wood burns, reduction takes place. The operation requires an hour or two. Additional poles are inserted to replace those consumed. Samples of a few ounces of the copper are removed in a small ladle from time to time and examined to note the progress of reduction. The "tough pitch" (the point at which the cuprous oxide is completely reduced to metallic copper) is the end in view.

The charge is now ready for dipping or ladling. Hand-ladles, holding 25-lb., or large "bull-ladles" holding 200 lb. and carried by an overhead trolley or crawl, are used. The dipping or molding consumes three hours. The copper is kept hot by occasional firing, and by keeping the surface of the metal covered with charcoal. The charcoal serves also to keep the copper in pitch, or in the condition of tough copper. The molds into which the copper is poured from the ladles are of the shape required by the trade. There are required ingots or bars suited to remelting for making brass; wire bars of a form convenient for rolling into wire; and rectangular cakes, often 18 in. square and 4 in. thick, but also of dimensions giving 2000 to 4000 lb. weight. The size of the cakes is suited to the size of the sheets of copper into which they are to be rolled.

#### MELTING AND REFINING "LAKE" COPPER

The product from which copper is made in the Lake Superior region is a concentrate (called locally "mineral"), which averages 70 per cent copper in native form, accompanied with a self-fluxing or fusible gangue. In addition there occur pieces of copper of different sizes, from that of the fist to several tons in weight, called mass-copper. The small pieces are handled easily, and are shipped to the smelting works in barrels. It is called barrel-work. The larger pieces called "mass copper" or simply "mass," are 70 per cent copper. For the large pieces that cannot be charged at the side doors, a hatch-opening with a clamped brick cover is provided. Large pieces are raised by a crane and charged through the hatch, also concentrate or mineral to make a charge of 36,000 to 40,000 lb. The charging takes place immediately after the dipping and the repairing or fettling the furnace. The furnace is now closed, and firing proceeds for several hours. As the charge melts and slag forms, it is skimmed until the metal is completely melted and the surface is clear. The operation of refining then continues as has been described above. The slag contains 15 to 25 per cent copper, partly as entrained prills and flakes, and partly as cuprous oxide.

This slag is smelted in a blast-furnace with added limestone to make the resulting slag fusible, using anthracite coal and a portion of coke for fuel.

In recent practice in the Lake Superior country the operation of melting is performed in one furnace and refining in another. A furnace, 18 by 40-ft. hearth area, melts 100 tons of mineral of 67 per cent copper in twenty-four hours, using 30 tons of coal. The charge to the second fur-

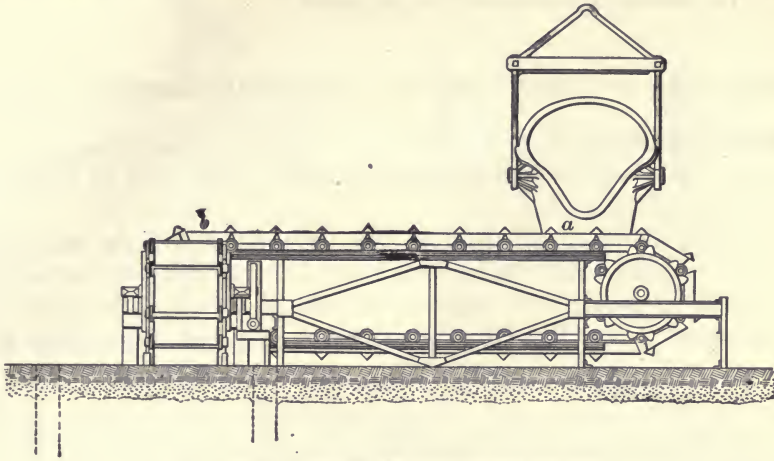

FIG. 242.—Endless Mold Casting Machine.

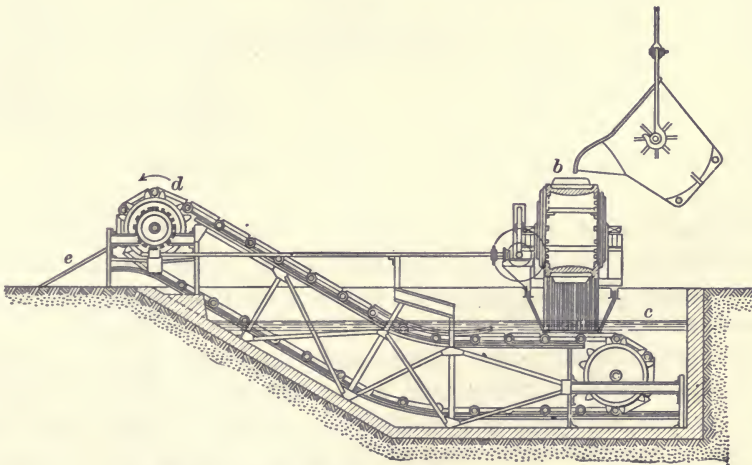

FIG. 243.—Endless Mold Casting Machine.

nace is supplied in two portions, the second following as soon as the first is melted.

The copper is poled, and when thus refined, is cast into ingots on an endless-mold casting-machine, see Figs. 242 and 243, or on a Walker casting-machine, see Fig. 245. The copper is tapped to casting-machine over a spout which is hinged, the lip being raised or lowered to regulate the flow.

In Fig. 147, the endless chain receives the molten copper upon the chain of molds at *a*, and this slowly travels along until the now solid ingot drops upon a grating and then on an endless chain conveyor in the water box at *c*. Here it is thoroughly cooled, lifted to *d*, and drops upon the floor at the foot of the slide *e* to be removed for shipment.

#### THE MAKING OF ANODES AND OF COMMERCIAL CATHODE COPPER

**Melting Furnace.**—The melting down of blister-copper in ingot form is performed in a coal-fired reverberatory furnace, 40 ft. long of a capacity of as much as 400,000 lb.

**Charging Machine.**—This, Fig. 244, consists of a crane carrying a transverse carriage whereby an arm or ram is introduced into the furnace, the paddle *B* at the end carrying its load of several ingots piled on one another. Upon the arm rests a racked bar that receives an inde-

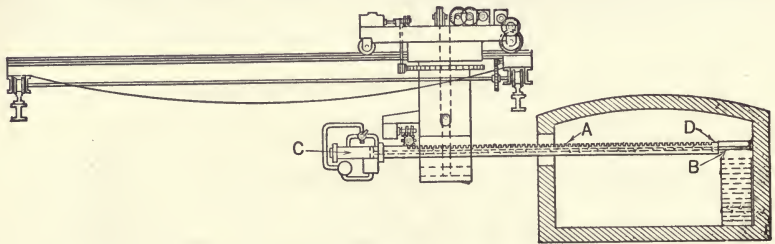

FIG. 244.—Clarke and Antisell Charging-crane.

pendent movement by means of the cylinder *c*. This, at the right moment, shoves the load off the paddle to drop upon the furnace bottom.

The charge is melted and poled to give a smooth anode, then tapped, in regulated flow.

The duty imposed upon these anode casting-furnaces is extremely severe and constant. They hold about 200,000 lb. of metal, and no sooner has the last anode of a charge been cast than a fresh charge begins. In order to complete their duty of 300,000 lb. copper ( $1\frac{1}{2}$  charges per twenty-four hours), it is often necessary to begin blowing compressed air into the metal as soon as the bath is sufficiently deep to submerge the air-pipes, taking care, however, not to let the oxidation proceed too far before the entire charge is collected, else there is danger of such a violent evolution of  $\text{SO}_2$  gas, from the reaction between cuprous oxide and the cuprous sulphide of the fresh converter copper, that there is danger of the melted metal being blown out of the furnace. Two of these furnaces are in constant use, with a third and larger one in reserve.



The pigs contain about 98.3 per cent copper, and this process brings them up to about 99.3 per cent, at which stage they will cast into smooth anodes.

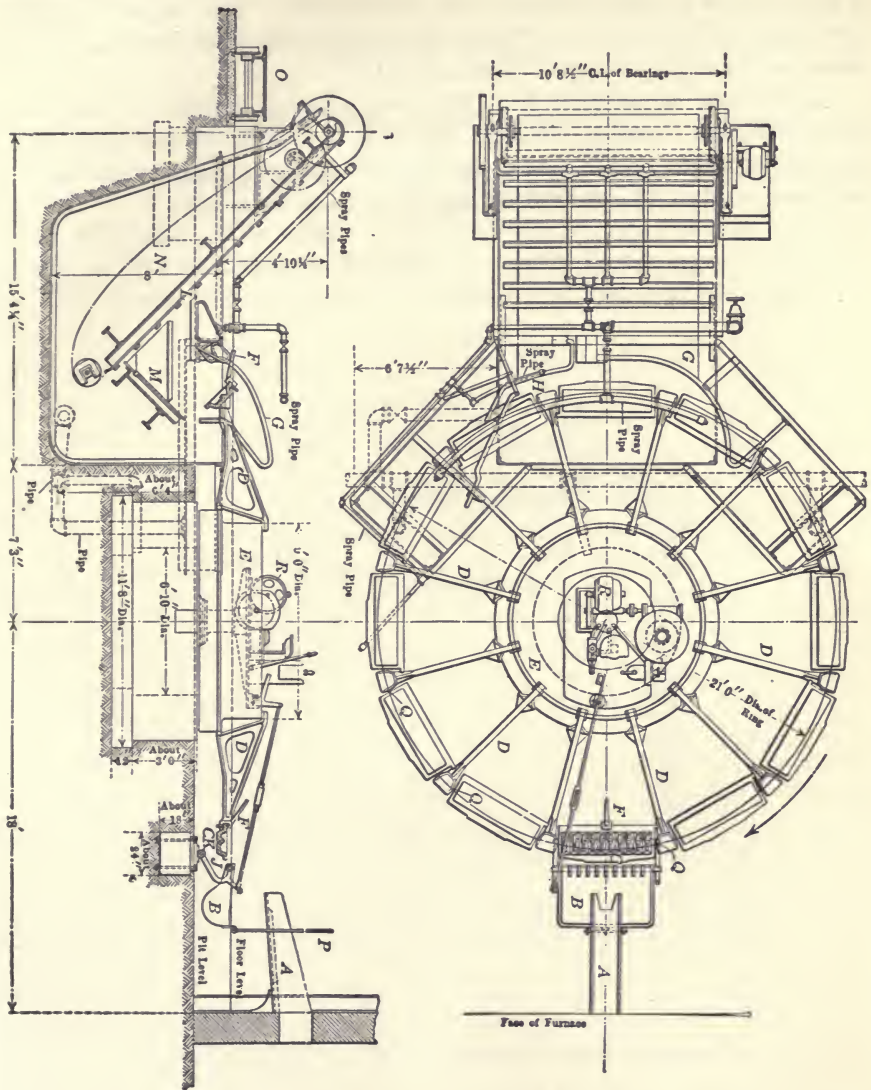

FIG. 245.—Walker Casting Machine.

**The Walker Casting Machine.**—This, as shown in Fig. 245, is of the horizontal wheel type and is capable of casting 25 tons per hour. The metal flows through the tapping-slit at the front end of the furnace into a

suspended ladle *B*, from which it is poured into an anode-mold attached to a platform conveyor operated hydraulically. When the mold is filled, the ladle is dropped to the horizontal position, and the conveyor is moved so as to bring the next mold into position. The copper is chilled by a spray and when "set" is dumped automatically from the mold onto a conveyor operating through a tank of water.

In the case of cathodes from the tank house of a refinery, these are charged by the charging machine, Fig. 244, to a large reverberatory furnace, melted down and tapped to the Walker casting-machine. The molds, as shown in Fig. 245, are making ingots for commercial use.

## CHAPTER XXXIV

### ELECTROLYTIC COPPER REFINING

#### ELECTROLYTIC COPPER-REFINING PLANT

Blister-copper from copper reduction works in the Western States, as well as that imported, is profitably treated by this process. Not only can pure copper be produced from impure material, but the gold and

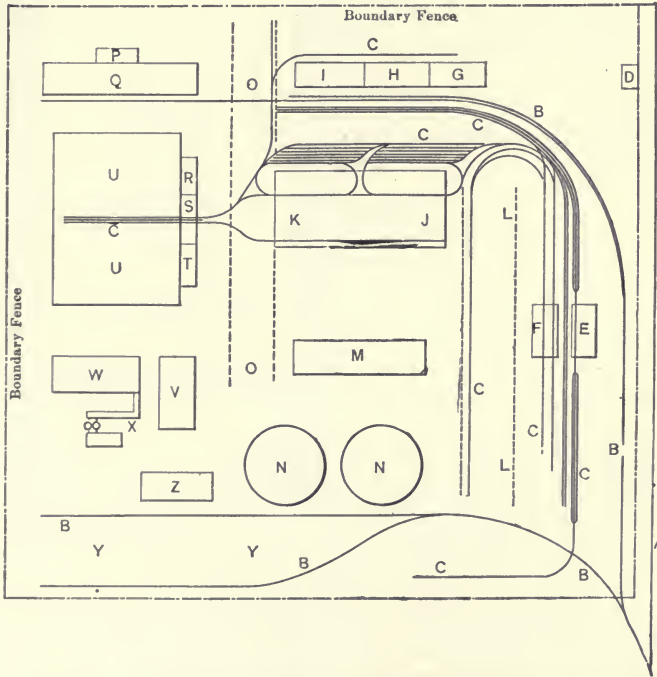

FIG. 246.—Ground Plan of Electrolytic Copper Refinery.

silver in the blister can be separated, parted and refined. The copper from the reduction works, in the form of rough ingots, or even as anodes, is sampled and assayed to determine the content of precious metal and of copper.

**Refinery.**—The following is the description of a refinery of the capacity

of 50,000 tons per annum, and covering 22 acres. It combines the best of the standard methods.

**Operation.**—Referring to Fig. 246, the blister-copper is received over the railroad spur *B*, weighed in the control weighing room *E*, sampled in the sampling room *F*, and then placed in storage under the crane-way *L*, from which it is taken as required, to the furnace building *J, K*. This has at one end two reverberatory anode furnaces for melting the blister, and two where the cathodes produced in the process are remelted into

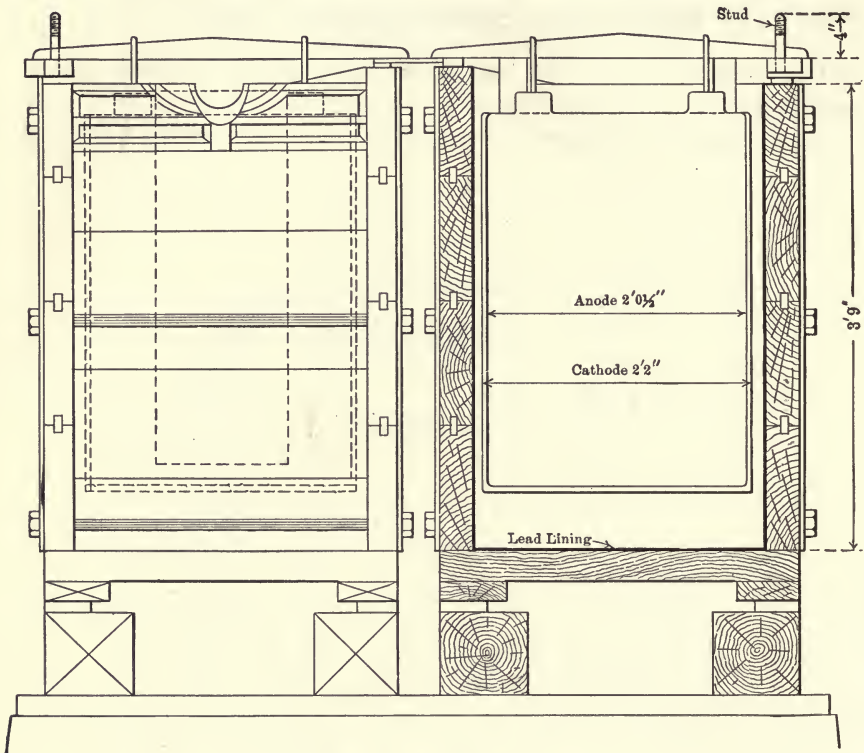

FIG. 247.—Electrolytic Tank.

merchantable form. The anode furnaces are lined with silica brick and are each of 100 tons' daily capacity. The furnaces are fired with slack coal, and have a waste-heat boiler, so as to utilize the steam for power purposes about the plant. The raw material is charged into the furnace on one side from the industrial railway by means of a charging machine (Fig. 244) and the molten copper is tapped from the other side into anode molds. The depth of the bath of molten metal is from 21 to 24 in. and during the twenty-four hour period the cycle of operations would be: For charging,  $1\frac{1}{2}$  hours; for melting down, nine hours; for refining and

poling, seven hours; for casting,  $6\frac{1}{2}$  hours. The anodes are stored under the craneway *O*, in plentiful supply to feed the tank-house *U*, where the electrolytic copper is produced.)

The tank-house contains 512 electrolytic tanks in two bays, a bay having 8 sections of thirty-two tanks each. Each tank, to hold 28 anodes and 29 cathodes, is 13 ft. long, and of cross-section shown in Fig. 247.

The current passes through each of the 30 plates or anodes to the cathodes placed between, and anodes and cathodes are 2.6 in. apart. Assuming that the anodes are 2 by 3 ft. in size, we have, in each tank, a total area of 360 sq. ft. through which the current is passing with a density of 20 amperes per square foot. We thus have a total of 7200 amperes. The pressure in passing through this 2.6 in. of electrolyte to the cathode is 0.40 volt. The tanks in series would therefore give a pressure of 102 volts.

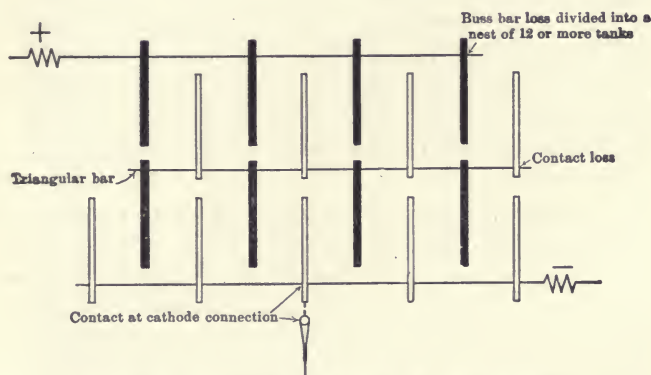

FIG. 248.—Current-flow Walker Multiple System.

Fig. 248 represents the arrangement of anodes and cathodes in the Walker multiple system. It will be seen that the flow of current through each vat is in parallel but from vat to vat in series.

The building must be kept at a uniform temperature of about  $80^{\circ}$  F., causing a tendency in cold weather to "sweating" on roof and walls, on account of the large amount of moisture evaporated from the electrolytic tanks. For this reason the heating should preferably be by the circulation of dry hot air to absorb the evaporated moisture.

The copper electrolyte consists of about 4 per cent copper in the form of sulphate, together with about 12 per cent of free acid. During the deposition of the copper the electrolyte becomes, in course of time, polluted by the impurities contained in the anode copper, on account of which a certain amount of the electrolyte is periodically drawn off and treated in the regenerating plant, the purified solution being returned to the copper electrolytic tanks. The rate of deposition of copper on the cathode will be governed

by the current density, which should not amount to more than 20 amperes per square foot of anode surface for copper carrying up to 100 oz. of gold and silver to the ton. Should the amount of precious metals be appreciably less, the current density may be increased up to, say, 30 amperes, thereby increasing the speed of deposition and shortening the time of operation. Should the deposition take place too quickly, there is danger of occluding precious metals with the cathode copper. A cycle of operations in the tanks at the 20-ampere current density would occupy from three to four weeks.

**Starting Sheets.**—One section of the tank house is devoted to the preparation of cathode starting sheets, for which purpose a copper plate coated on each side with oil or graphite is used as a cathode blank, and a thin layer of copper deposited thereon by electrolysis. This is stripped off from each side and forms the cathode starting sheet. In the routine operation the electrolytic tanks are first charged with anodes, and then hung with cathode starting sheets, and the current is started. It is kept on for a prescribed number of days, varying from ten to twelve; then the cathodes which have been formed on the starting sheets are removed, the solution is lowered in the tanks, the anodes are taken out temporarily, and the slime is removed and sent to the slime refinery. The anodes are then replaced, fresh cathode starting sheets hung, and the current is turned on for another period of ten to twelve days; then the "pulling" is repeated, except that upon this occasion what is left of the anodes is removed and goes back as scrap to be remelted in the anode furnaces. It will be noted, therefore, that for each anode going to the tanks two cathodes of lighter weight are formed. The theoretical deposition of the copper would be approximately 0.062 lb. of copper per ampere day, and a current efficiency of at least 90 per cent should be acquired. The necessary pressure would be about 0.4 volt per tank, and upon this basis the rate of deposit should amount to about 6 lb. of cathode copper per kilowatt-hour.

The cathodes are weighed on leaving the department, and stored, from which point they are fed to the refined copper furnace for melting into the shape required by the consumer, for example, ingots, wire bars, and cakes.

**The Slime Refinery W, Fig. 246.**—The precious-metal slime reclaimed from the electrolytic tanks amounts to about 30 tons per month, containing about 440,000 oz. of gold and silver. The slime is first freed of the electrolyte by settling until it contains about 50 per cent moisture. It is then boiled with sulphuric acid to remove soluble copper, after which it is put through a filter press and roasted. This roasted product is combined with a portion of unroasted slime to make up a furnace charge. The result will be the melting of about 20 tons per month of slime containing from 15 to 25 per cent moisture, the melt taking place in a small reverberatory furnace, the product of which is doré bars.

**Parting.**—Doré bars form the anodes for an electrolytic deposition, which takes place in an electrolyte slightly acidified with nitric acid, the silver being deposited on cathode blanks in crystalline form, and the gold settling as a black mud containing about equal quantities of gold and silver. The resulting silver crystals are scraped off the cathode blanks, washed and melted into fine silver bars. The gold mud is purified by treatment with nitric acid to part the gold from the silver, the solution going back to the silver electrolytic tanks, and the gold sand melted with borax into fine solid bars.

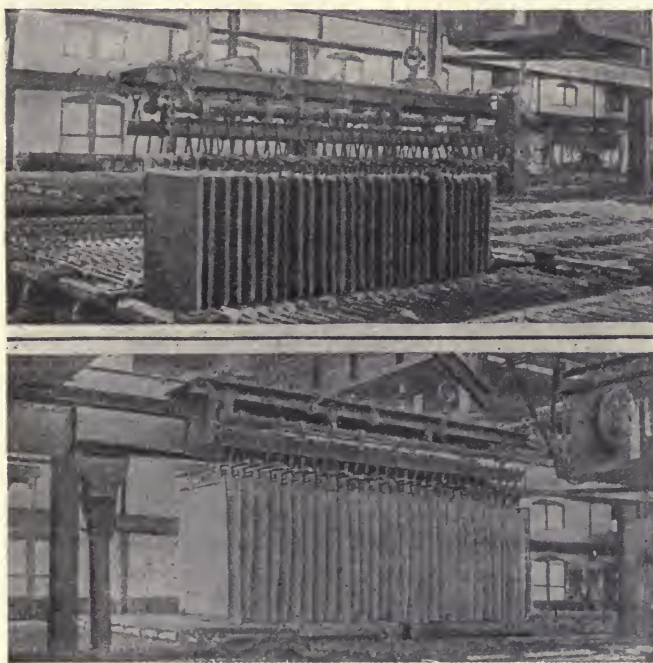

FIG. 249.—Mechanical Handling of Anodes and Cathodes.

**Mechanical Handling of Anodes and Cathodes.**—In Fig. 249, the view above shows the anodes, and below, the cathodes, the entire anode or cathode contents of a tank being lifted and transferred in one operation. The frame shown is brought down by a traveling crane over the tank, all the anodes or all the cathodes of the tank hooked on to it, the frame and its load lifted and transferred to a clear space at the end of the tank house where the fragments of anodes can be removed to be sent to the anode furnace, while the built-up cathodes are stored, to go later to the refined-copper furnace.

**The Regenerating Plant V, Fig. 246.**—The best proportion of acid and

copper for the electrolyte is 10 per cent  $H_2SO_4$ , and 15 per cent  $CuSO_4$  (equivalent to 6 per cent Cu). When the copper exceeds this quantity, the resistance increases; hence copper is removed from the circulating electrolyte or solution if in excess, to bring the amount to the required proportion, the quantity of iron, arsenic, antimony, and tellurium gradually increases, and a time comes when the electrolyte becomes foul with them and the excess must be removed. Antimony can be kept low by the daily addition of a small amount of salt, which precipitates as an oxychloride.

To purify the electrolyte the following method is used. A portion of the electrolyte is diverted in a constant flow to tanks reserved for the purpose of purification. These have insoluble sheet-lead anodes and copper cathodes. A strong current is used, so that not only is copper deposited, but also the impurity. The deposit collects loosely upon the copper plates and falls to the bottom of the tanks. Every two months the accumulated mud, containing 40 to 60 per cent copper, is cleaned out and reduced in a reverberatory-refining furnace to form impure bars of copper. The purified electrolyte is returned to the main system.

**Circulation of the Electrolyte.**—To avoid short-circuiting, and to increase the activity and regularity of deposition, the electrolyte is made to flow or circulate through the tanks, entering the top of each tank near the end, passing downward between the plates, and finally rising and flowing away through an overflow pipe at the other end. After the solution has flowed through two tanks in this way, it enters a launder that returns it to the collecting or sump-tank. Thus every pair of tanks has an independent circulation. The sump-tank receives all the electrolyte, to be here heated by means of a steam-coil to  $40^\circ C.$ , the effect of the warming being to decrease the electrolytic resistance. It is then pumped up to a distributing or stock-tank, and once more enters the circulation.

**Testing the Current.**—Besides the voltmeter and ammeter to be found at the switch-board in the power-house, it is customary to use a voltmeter for constantly testing the drop in potential between the anodes and cathodes. For this a forked rod is used, which touches the two plates and takes a small current through a portable voltmeter. A slight drop of pressure indicates short-circuiting.

**The Power-house, Q, Fig. 246.**—Here are installed five motor generator sets each to give a constant current of 5000 amperes at 60 to 115 volts. Four of these are arranged to work in groups of two in parallel directly to the two separate circuits in the tank-house. The fifth unit is connected to act as a spare for any of the others.

**Cathode Storage.**—Leaving the tank house as heavy cathodes, these are placed under the craneway *O*, thence delivered to the reverberatory refining furnaces *J*, there to be melted and cast in the forms required by the consumer.



## CAPITAL REQUIREMENTS

Not only is capital invested in the buildings and the equipment of the plant, but it is required for:

- (1) The stock of anodes in process of treatment.
- (2) The stock of anodes awaiting treatment.
- (3) The copper constantly contained in electrolyte.
- (4) The copper needed for the heavy conductors transmitting the current.

The result of this large demand upon capital is to restrict the operation of plants to places near financial centers, like New York, where cheap money is available, the copper near the market, and labor abundant. These considerations may outweigh the advantages of having the plant near cheap water-power.

## COST OF REFINERY AND OPERATING COSTS

**Cost of Refinery.**—To refine 50,000 tons of blister-copper annually containing gold and silver, the output, consisting of refined copper in the shape of wire bars, cakes, and ingot, of gold as fine gold bars, and silver as fine silver bars, the construction costs will be as follows:

## CONSTRUCTION COSTS

Furnace building.....	\$ 67,500	
Two anode units.....	95,000	
Two refined-copper units.....	92,200	
Four cranes, two services, two charging.....	40,600	
Auxiliary equipment.....	84,800	
Total furnace department.....		\$380,600
Tank house building.....	\$127,000	
Sixteen 32-tank sections and circulation system and equipment.....	258,000	
Electrolytic circuit conductors, etc.....	96,000	
Four service cranes.....	25,000	
Auxiliary apparatus.....	51,000	
Total tank house department.....		557,000
Power-house building and crane.....	\$ 42,000	
Five electrolytic motor generator sets and equipment.....	116,000	
Motor-driven pumps, etc.....	32,200	
Auxiliary apparatus.....	30,200	
Total power-house department.....		220,400

Slime refinery building.....	\$ 38,000	
Settling and boiling tanks, filter press and roaster.....	16,500	
Furnace and flue system.....	22,100	
Electrolytic parting cells and equipment.....	18,800	
Gold-refining equipment.....	2,600	
Auxiliary apparatus.....	11,700	
		\$109,700
Total slime-refining department.....		
Shops building and equipment.....	\$ 31,000	
Office and laboratory and warehouse equipment.....	44,000	
Sampling apparatus.....	7,500	
Control weighing scales and housing.....	7,400	
Storage cranes, craneways, and locomotive crane.....	36,700	
Receiving and shipping apparatus.....	3,600	
Industrial locomotives and cars.....	47,800	
Industrial tracks and railroad sidings.....	24,500	
Miscellaneous auxiliary apparatus.....	7,600	
Bluestone and acid necessary to make up electrolyte.....	25,000	
		\$235,100
Total miscellaneous.....		
Total.....		\$1,502,800

These figures are the more valuable that they show in what unusual ways the money has to be spent, causing costs to mount rapidly.

**Operating Costs.**—These are as below estimated, viz.:

	Labor.	Material.	Total Per Ton.
Anode making.....	\$1.155	\$1.213	\$2.368
Electrolytic refining.....	2.025	2.464	4.489
Refined-copper casting.....	1.00	1.304	2.404
Slime refining.....	.463	.461	.924
General expenses.....	.926	.464	1.390
Interest on investment (5 per cent).....		1.537	1.537
Totals.....	\$5.669	\$7.443*	\$13.112

\* Per ton of refined copper.

#### SCHEDULE OF COPPER AND COPPER ORE PRICES

In Utah, custom copper smelting works pays \$19 an ounce for the gold; for 95 per cent of the silver, based on the New York quotation, and for copper, after deducting 1 per cent from the wet assay, a further deduction of 3 to 4 per cent from the New York price per ounce. A charge of \$5 per ton is made for treatment and when the insoluble exceeds 40 per cent then 5 cents per unit for all over this. Zinc in excess of 10 per cent is charged for at the rate of 30 cents per unit. The deduction of 3 or 4 cents from the copper price is to cover the cost of freight and refining.

**Copper.**—The New York price is expressed in cents per pound, quotations being given for Lake copper cast in the form of cakes for rolling into sheets, into ingots for remelting to make castings, brass, and bronze, or for wire-bars for drawing into wire. Casting-copper is not as pure as that which is to be rolled into sheets or drawn into wire. Electrolytic copper is made by remelting cathodes (the product of electrolytic refining) into ingots, cakes, or wire-bars. Cathodes are held at  $\frac{1}{8}$  cent less than electrolytic copper, the difference paying for the remelting.

In London copper is sold by the long ton in English money, and is of various brands. Standard copper, formerly called g.m.b. (good merchantable bars), is the grade upon which the others depend. Besides these brands we have:

“English tough copper,” “best selected” or “standard.” If sold for immediate delivery it is called “spot copper”; if the customer will take it at the expiration of three months it is called “three-months copper.”

It is the business of dealers, and others interested in copper, to keep statistics of the supply of available copper, which is called the “visible supply.” When this is small the price naturally rises, and the reverse is true when it is large.



PART VI

LEAD



## CHAPTER XXXV

### PROPERTIES OF LEAD AND ITS ORES

**Physical Properties of Lead.**—This metal, so soft that its purity may be judged of by scratching with the thumb nail, is commercially divided into corroding, common, and antimonial lead. Of the base meals it is the heaviest, having a specific gravity of 11.37. It soon tarnishes on a freshly cut surface, becoming dull gray. It is malleable, so that it can be rolled into sheets and pressed into pipe, but it has little tenacity. It freezes at 325° C. and boils at 1525° C.

#### CHARACTERISTICS OF LEAD ORES

**Classes of Lead Ores.**—The lead ores are those in which lead is the principal constituent. The term is applied also to mineral aggregates consisting of more than 10 per cent lead. The lead ores may be divided into two classes, the sulphide and the oxidized. The terms are used only according to the constituent that is in excess; in many lead ores both sulphides and oxides are found. Ore containing no lead is called dry, and when carrying lead, leady. The latter term is the opposite of dry, but we do not term a leady ore a wet one.

**Galena.**—Pure galena contains 86.6 per cent lead and 13.4 per cent sulphur. In nature it occurs with gangue or vein-matter. When there is much of the latter it can readily be concentrated. The following table gives an idea of the lead-content of ore, before and after dressing:

GALENA ORES

Locality.	RAW ORE.	CONCENTRATE.	
	Pb, Per Cent.	Pb, Per Cent.	Ag. oz., Per Ton.
S. E. Missouri.....	4.3	80.0	12.0
Minnie Moore, Wood River, Idaho.....		62.0	80.0
Rockville, Wis.....			0.3
St. Joseph, Mo.....	7.0	70.0	
Kellogg, Idaho.....	11.0	60.0	30.0
Col. Sellers, Leadville, Colo.....	10.0	55.0	19.8
Cœur d'Alene.....		49.5	30.0

Galena from the Mississippi Valley contains little silver. Galena concentrate from S. E. Missouri contains Pb, 69 per cent;  $\text{SiO}_2$ , 1.4 per cent; Fe, 5.1 per cent; CaO, 3 per cent; Zn, 0.8 per cent; S, 15.5 per cent. That from the Rocky Mountain region is not only argentiferous, but may contain gold. The precious metals as well as the lead determine the value. Metallic sulphides, such as pyrite and blende, are often associated with galena, and with the gangue may carry so much of the gold and silver that concentrating leads to a serious loss of the metals and is omitted. If by hand-picking ore can be brought to contain 30 to 40 per cent lead, it is a desirable ore for the smelter. When of this tenor in lead, and free from other sulphides, it carries but 5 per cent sulphur and needs no preliminary roasting, and is smelted directly.

**Oxidized Lead Ores.**—Little lead oxide is found in nature. The ores classed here under oxidized ores are the result of the alteration of galena. They include the carbonate (cerussite) and the sulphate (anglesite) of lead. The minerals are mixed with metallic oxides and vein-matter or gangue in nature, and when sandy or earthy, the ore is called sand or soft carbonate, and when hard and stony, hard carbonate. In many deposits we find ore that originally was galena, profoundly altered to cerussite or anglesite. The subjoined table gives the composition of some of the so-called carbonates:

#### CARBONATE ORES

Locality.	Pb, Per Cent.	$\text{SiO}_2$ , Per Cent.	Fe, Per Cent.	CaO, Per Cent.	S, Per Cent.	Ag. oz. Per Ton.
Southwest Missouri.....	72.0					
Leadville, Colo.....	29.0	11.6	24.3	.....	.....	5.0
Leadville, Colo.....	21.0	22.5	18.2	2.4	0.9	65.0
Red Mountain, Colo.....	18.4	41.6	11.4	1.7	1.8	128.0
Eureka, Nev.....	33.2	3.0	24.1	1.1	2.0	27.5
Bingham, Utah.....	51.5	12.5	2.6	3.2	6.0	21.1
Horn Silver mine, Frisco, Utah	50.0	15.2	3.4	0.5	8.3	78.3

Of the ores of the table, that from Eureka, Nev., contains 4.2 per cent of arsenic, which forms an arsenical speiss when smelted. The Horn Silver ore, apparently oxidized, has the lead in the form of anglesite ( $\text{PbSO}_4$ ), and matte is formed from it in smelting. In oxidized ores the silver is apt to occur as a chloride; the gold probably is native.

There are many lead minerals, but those not mentioned occur in small quantity and are not considered among the commercial lead ores.



## THE SMELTING OF LEAD-BEARING ORES

When lead concentrates are to be smelted only for the lead content, as is done in parts of the Mississippi Valley, a simple plant with a reverberatory furnace,\* or the American ore-hearth, is sufficient. In the rocky Mountain region the lead ore is not smelted to recover only the lead. The lead of the ore is employed as a collector of the gold and silver of other ores that are smelted at the same time. By use of the ore hearth, a large part of the lead is recovered cheaply and simply, but a part is lost in the resultant slag. In silver-lead smelting it is essential that the slag be comparatively free from lead and consequently from silver.

## SMELTING ON THE ORE-HEARTH

The ore-hearth cannot, as regards capacity, or cost per ton of ore treated, be used in silver-lead smelting. It can be quickly started or stopped, and put in operation with little cost for fuel, so it well serves the purpose of extracting the lead from small amounts of low-silver ore, from time to time, by the men who themselves have mined the ore.

**The Hearth.**—Fig. 250 represents a sectional elevation, a front elevation of the lower part, and a plan of an American ore-hearth. It consists of a cast-iron pan or crucible *a*, 2 by  $2\frac{1}{2}$  ft. by 1 ft. deep, to contain a bath of lead. The back *p* and the two sides *n*, *n*, above the crucible, are water-cooled castings. The blast from a fan-blower (not shown) enters by the tuyere-pipe *b* through the back at *o*. At *g* is a sloping cast-iron plate called the work-stone, and at *i*, a pot, placed to recover the lead that flows down over the work-stone. The pot is kept hot by a wood fire below. The structure is surmounted by a brick top to receive and carry off the fumes.

**Operation.**—By means of the blast, a glowing coal fire is made that fills the crucible of the hearth, *a*; residue from the previous run, containing metallic lead, and 15 to 20 lb. galena, not finer than pea-size, is spread over the fire. The charge soon becomes red hot, and the lead, set free, finds its way to the crucible at the bottom. More ore is then added, and the material in the hearth is pried up gently with a bar to keep the mass open and hot throughout. Lumps form, and are drawn out on the work-stone, *g*, and gray slag that forms at the same time is separated and the rich residue returned to the hearth. Ore and fuel are again added,

\* The treatment of lead ore in reverberatory furnaces has not made headway in the United States. There are two reasons for this: In the silver-lead districts, the ore has not been of sufficient grade in lead to warrant the treatment, and lead ore has been in great demand as a collector to mix with other ores. Secondly, in the Mississippi Valley where silver-free lead concentrate is made, the question of skilled labor for reverberatory furnace work has had an influence.

15 to 20 lb. at a time, and operations continue until lead fills the crucible, while on the top floats the fuel, unreduced ore, and half-fused material. One man with a bar at intervals loosens and stirs the charge, raising it slowly, while another with a shovel draws upon the work-stone the half-fused mass floating on the lead. Here he separates and rejects the gray slag, and returns the rich residue to the charge. A fresh charge is then added, and the work progresses in the manner described. The lead over-

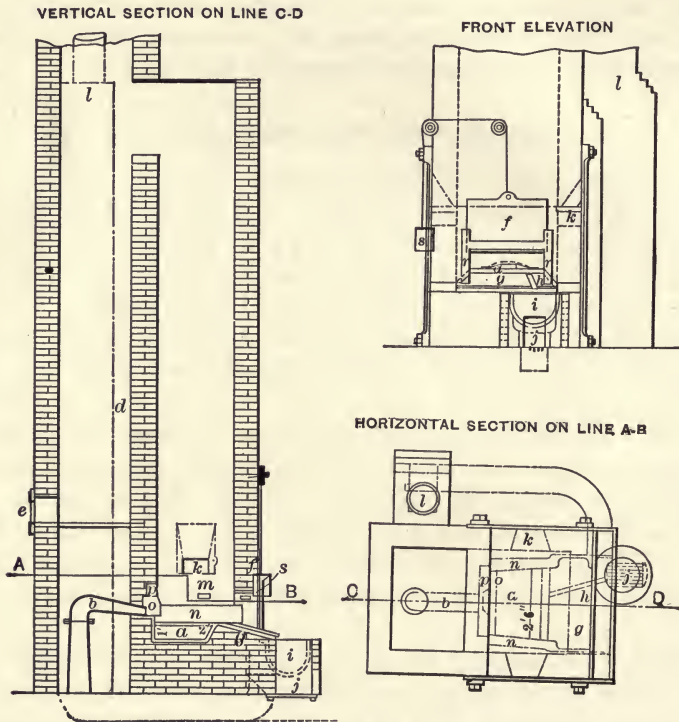
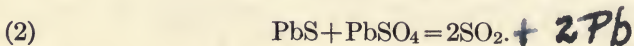
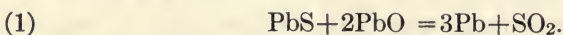

FIG. 250.—American Ore-hearth.

flows the crucible and runs down a groove made in the work-stone into the kettle, *i*. When the kettle fills, the lead is skimmed and ladled into molds.

With air in excess the red-hot galena is in part oxidized to  $\text{PbSO}_4$ , in part to  $\text{PbO}$ . Both these react upon the galena thus:



Also the glowing fuel, reacting upon any remaining oxide, completes the reduction.

To operate the ore-hearth, a blower and power to run it are needed. Much lead is volatilized, and so the treatment is not suited to argentiferous galena. The gray slag that is produced still contains 35 to 40 per cent lead, and is sold to smelting-works. The direct recovery of the lead is 75 to 85 per cent, the higher figure having been obtained in recent practice.

**The Newnam Hearth.**—A recent development of the ore-hearth has been the introduction of mechanical rabbling, thus doing away with the

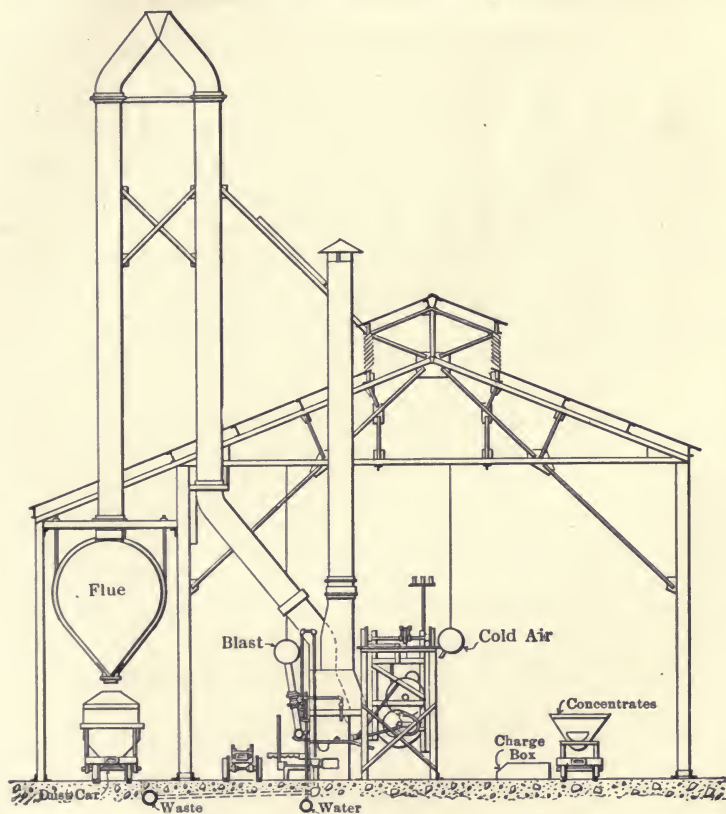

FIG. 252.—Newnam Hearth (end view of plant).

most laborious and hottest work of the hearth, that is, the rabbling of the charge. The increase in its size and capacity is another advantage.

Fig. 251 shows such a rabbling machine, which is electrically traversed upon an overhead track, free from possible obstruction. The machine carries a rabble or poker, which plows its way through the crust of the molten bath from the left to the right end of the furnace, a distance

of 8 feet. Following it is a furnace helper, who, with a long-handled shovel, removes the gray slag and pushes back unfused lumps, while the furnaceman adds a thin layer of ore and a little coal, as in the American ore-hearth as just described. The rabble, seen in 251, sloping downward into the bath, is now lifted, and the machine returned to the left end of the furnace to make another stroke.

Fig. 252 is a cross-section of the plant with the many details plainly marked, the goose-neck rising above the building carries the dust and fume to a balloon flue, where the material is withdrawn into a car.

## CHAPTER XXXVI

### SILVER-LEAD SMELTING

#### SILVER-LEAD BLAST-FURNACE SMELTING

This is a blast-furnace method of treatment, applicable to a great variety of ores containing lead, silver, gold, and even copper. By it, ores containing the precious metals with no lead, are treated with lead-bearing ores, thus using the lead of one ore as the collector of the gold and silver of another. This is the most effective method of treating such ores. The precious metals are extracted from the ore by a blast-furnace treatment, using lead-bearing ores, carbonaceous fuel, and flux.

Oxidized ore can be directly smelted in the blast-furnace, but sulphide ore is first roasted. Methods of roasting are described in the chapter on Roasting.

The ore to be smelted is charged into the blast-furnace as in iron or copper smelting, with a calculated quantity of flux, which, for lead ore, is iron ore and limestone. The precaution is taken to use lead-bearing ore enough to make the lead content of the charge at least 10 per cent. It has been found that if a smaller proportion of lead than this is used, the precious metals are not so well collected in the base-bullion, or work-lead, produced in the smelting. To a charge, as above constituted, is added 10 per cent or more of coke, not only to melt the charge, but to reduce the lead oxide to metal and the ferric oxide to the ferrous form.

#### RECEIVING, SAMPLING AND BEDDING OF LEAD ORES

Where ore is treated in a small way for the recovery of the lead, as in Missouri, no particular provision is made for storage. In various custom smelting works in the Rocky Mountain region, where lead ores are treated with others by methods of silver-lead smelting, and where ores are bought outright for treatment, the handling becomes complicated. A plant treating ore from its own mine is called a mine's works, and here less attention is given the sampling and storing of the ore. In a custom works, therefore, ores of many kinds are received, some containing lead, some having little lead but carrying silver and gold.

## BEDDING ORES AT A CUSTOM WORKS

The ore is received in lots of a few tons up to those of several carloads. Each lot is separately weighed, sampled as described in the chapter on Sampling, then assayed, and purchased. If different kinds of ore were smelted separately the process would involve endless change and labor, and so it has become the custom to "bed" the ore in large bins or stalls, each holding several hundred tons. When so bedded the mixture, called a "mix" is treated as a single ore. The different kinds of

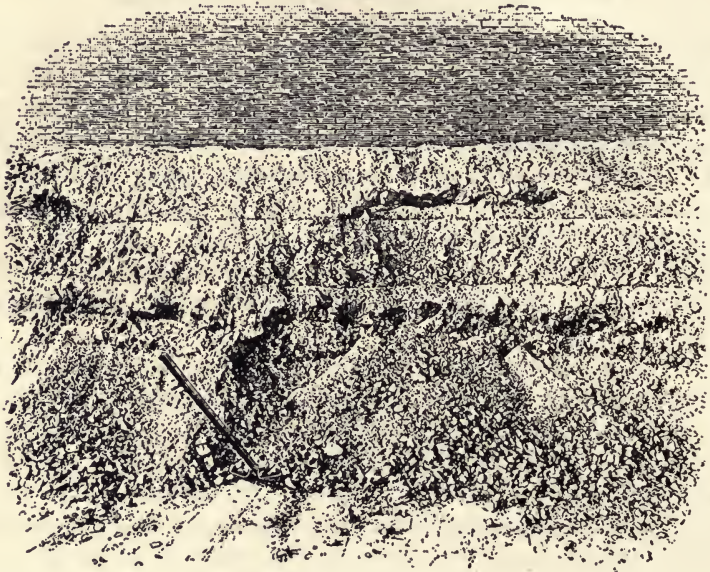

FIG. 254.—Ore-bed.

ore are unloaded separately into the bin, and each kind is spread out in an even layer before the succeeding one is added, as indicated in Fig. 254. When the ore is to be used, shoveling is done at the floor and all parts above fall down and mix, since a steep face of ore is constantly maintained. Thus a uniform mixture of the different ores is obtained for smelting. The contents of the bed are treated in the books of the company as a single ore.

**Side Ores.**—Besides ore bedded in this way, large lots may be kept separate. Even smaller lots, of which a moderate amount is to be used per charge, may be so kept. Such are called "side ores."

**Charging from Feed-bins.**—Ore and fluxes are often stored in hopper-bottom bins or pockets, to be drawn off in weighed quantity into the fur-

nace charge-car. Fig. 253 shows such an installation. The charge is dropped into the furnace by opening the double-hinged bottom of the car.

The coke and fluxes are stored separately in large piles, so that in case of failure of railroad delivery due to washouts, etc., the furnace shall not have to close down.

**Charging Fuel.**—Coke for the charge is forked into the coke-buggies, using a fork with 1½-in. spaces, thus leaving fines which are generally thrown away. Such loss may amount to 5 per cent.

A bed, formed of 10 to 15 per cent  $\text{SiO}_2$ , 20 to 28 per cent Fe, and 20 to 28 per cent Pb, roasts well. Mixtures containing less lead and more pyrite than this roast readily, but a mixture pulverulent, when roasted, tends to make more flue-dust in the blast-furnace, while with the proportion of lead above specified it sinters and makes a desirable lumpy product.



FIG. 253.—Charging Feed-car.

**Sintering Ores.**—Besides sintering by blast-roasting, the Dwight-Lloyd machine, described on page 112, has come extensively into use, not only for silver-lead ores, but for fine iron ores as well.

#### GENERAL ARRANGEMENT OF A SMELTING WORKS

**A One-furnace Smelting Plant.**—In Fig. 256 we illustrate a completely assembled works. Since the materials pass downward from level to level this is called a side-hill or terraced plant. To suit present practice the reverberatory roasting furnaces would be replaced by a multiple hearth-roaster and a Dwight-Lloyd sintering machine occupying but one-third the space.

The 30-in. Dwight-Lloyd machine has treated 60 tons of sulphide ore, or 80 tons where non-sulphide ores are mixed in. The 42-in. machines will yield 80 to 120 tons under similar circumstances, and at higher speeds 200 tons and over.

Fig. 255 is a cross-section of a Dwight-Lloyd sinter plant, containing 42-in. machines. An inclined conveying belt delivers charge to a

horizontal one on the top floor which has a tripper to deliver it to the feed hoppers. At the right it discharges to a railroad car receiving the sintered ore. From the building a 9-ft. balloon flue leads away the gases to a stack. An exhaust fan, one to each furnace, draws these away to the stack.

**Composition of the Charge for Sintering.**—The sinter charge may be quite variable. It is customary to rough-roast ore high in sulphur until it is reduced to about 12 to 15 per cent in sulphur. A satisfactory charge would contain 13 per cent Pb, 23 per cent  $\text{SiO}_2$ , 25 per cent Fe plus Mn, 12 per cent sulphur. This rough-roasted product is blast-roasted down to 3 per cent sulphur.

Ore in cars, which has to be sampled or crushed for roasting, enters by the track *a'* on the extreme left, or otherwise by the track *j*, Fig. 256. At the latter track, while unloading, every tenth shovelful can be retained in the

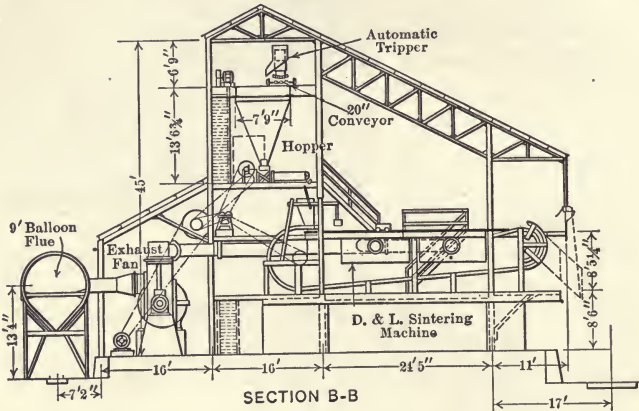

FIG. 255.—Cross-section of Sinter Building.

arc while the nine-tenths is bedded upon the mixing floor. The car can then be sent to the sampling mill by track *a'*. Crushed ore for the roasters is received in a car *b*, then trammed to the pile *d*. Here it is withdrawn, as needed, and taken to the hoppers *e'*, *e'*, of the two reverberatory roasters in the roaster-building *H*. A flue *X*, common to them both, leads to the stack *f*. The roasted ore is taken by wheelbarrows to the cooling floor *R*, then to any bin *V* of the mixing floor. Non-roasting, sampled ore is trammed by the tracks *s'*, *t*, for bedding at any bin *V*. Fuel and fluxes are also unloaded to the mixing floor. Charges, as fast as assembled and weighed, are raised by the "lift elevator" to the blast-furnace feed-floor. The blast-furnace is supplied with air by a rotary blower *w*, driven by a steam engine in the "engine-blower room."

The gases from the blast-furnace pass away to the flue *p* by the goose-neck down-take *o*, thence to the dust-chamber *I* and to the stack *g*. The





Fig. 257 is a perspective view and Fig. 258 shows elevations of a furnace, giving many details of construction. The brick crucible, heavily bound with plates and steel rails, has, as shown in the transverse section, a channel called a "lead well," widening upward from the bottom of the crucible and having a spout where the molten lead (which fills crucible and lead-well alike) may be removed. There are six water-jackets on

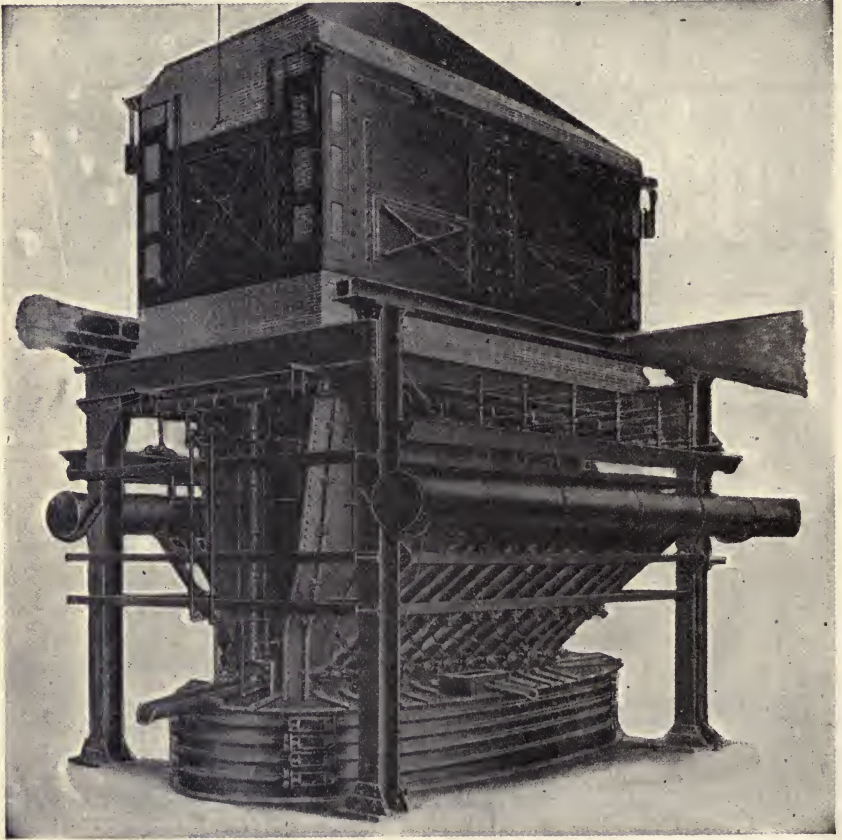

FIG. 257.—Perspective View of Silver-lead Blast Furnace.

each side and one at each end (see Fig. 258), forming the furnace bosh. Another tier of jackets forms the lower part of the shaft, while its upper part of brick reaches to the charge door. On each long side are two counter-weighted doors. When a furnace is to be fed the doors are opened, one at a time, to do so. Each lower side jacket is pierced with two tuyere openings, making twenty-four tuyeres in all, there being none in the

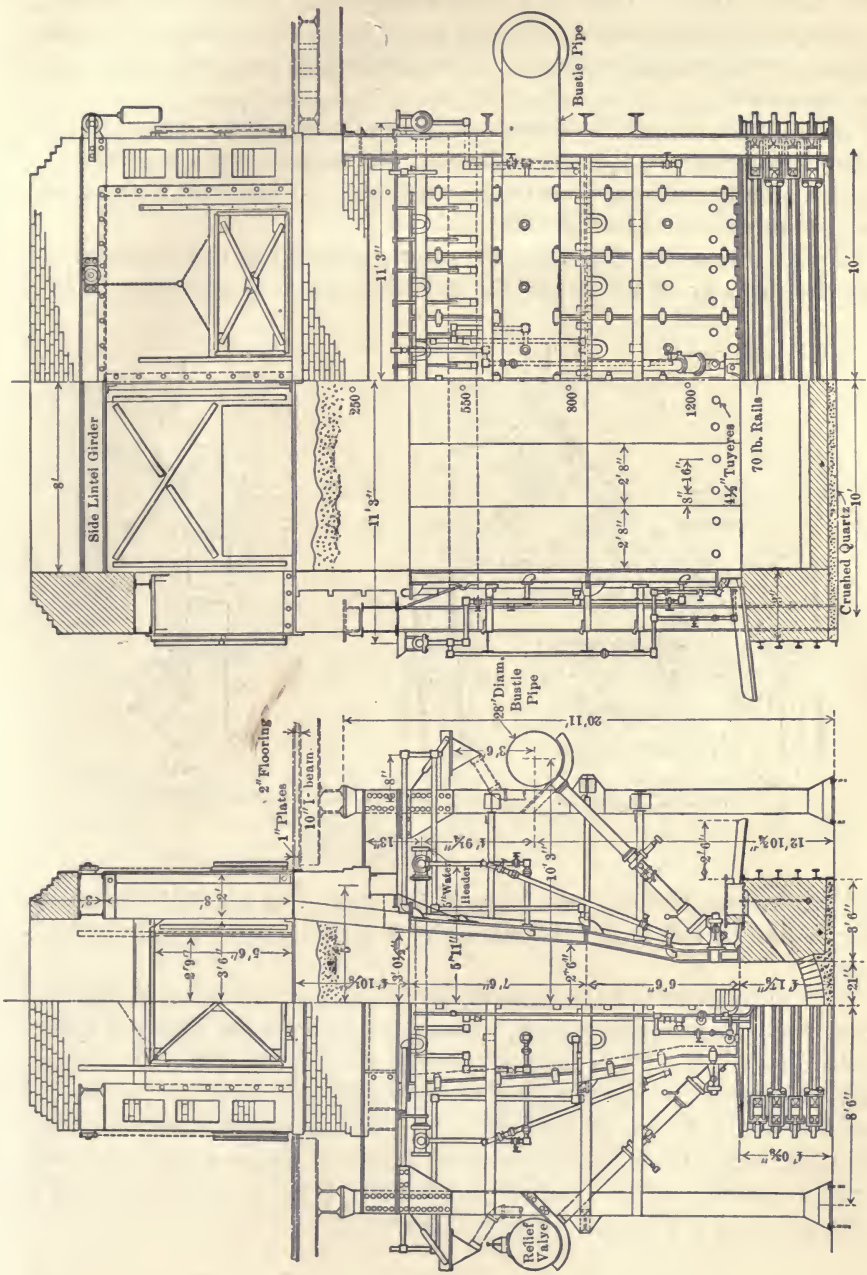

FIG. 258.—End and Side Elevations of Lead Blast Furnace.

end jackets. The jackets are held in place by a frame of I-beams that bear against them. There is a main water-supply pipe whence proceeds a feed-pipe to each jacket. The spill from the jackets is taken to a waste trough, set above the bustle-pipe. The bustle-pipe surrounds the furnace on three sides.

The tuyeres themselves are well shown in Fig. 259. Each one has its own gate-valve so that it can be shut off for any desired purpose.

Air is supplied by the bustle-pipe *e*, Fig. 261. Iron-pipe connections are now preferred, as in Fig. 259.

In the case of the closed top the gases pass away to the dust-flue *p* of Fig. 256 by way of the down-take *o*, which slopes at an angle of  $45^\circ$ ;

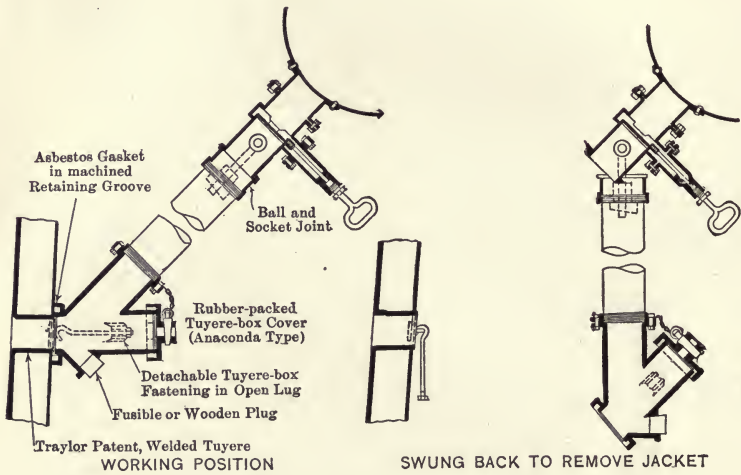

FIG. 259.—Blast-furnace Tuyere.

so that the flue-dust will not lodge in the pipe. At Fig. 261 the down-take is flatter, but it can be cleared by a rabble worked from the feed-floor.

The arrangement of the water-cooled tap-jacket, as shown in Fig. 262, is an end jacket, having a bosh. Beneath this is set the cast-iron water-cooled tap-jacket *t*, 12 in. square. This is wedged beneath and on either side with brick and fireclay, and the breast is bricked up. The conical aperture or tap-hole is plugged with clay. When sufficient slag has accumulated within the furnace, say every fifteen minutes, a hole is pierced through the clay of the tap-hole and the slag flows out over the spout *s*, being received in a slag-pot or into a fore-hearth.

## OPEN- AND CLOSED-TOP BLAST-FURNACES

In the blast-furnace building, Fig. 256, and in Fig. 257, are views of a closed-top furnace, while in Fig. 261 we have sections of an open-top one. In the former the smoke is caught in the closed-top and passes away overhead and the furnace can be fed to the level of the feed floor; in the second the gases pass away by the down-take *x* which limits the charge level to its bottom. On the other hand the whole furnace is accessible

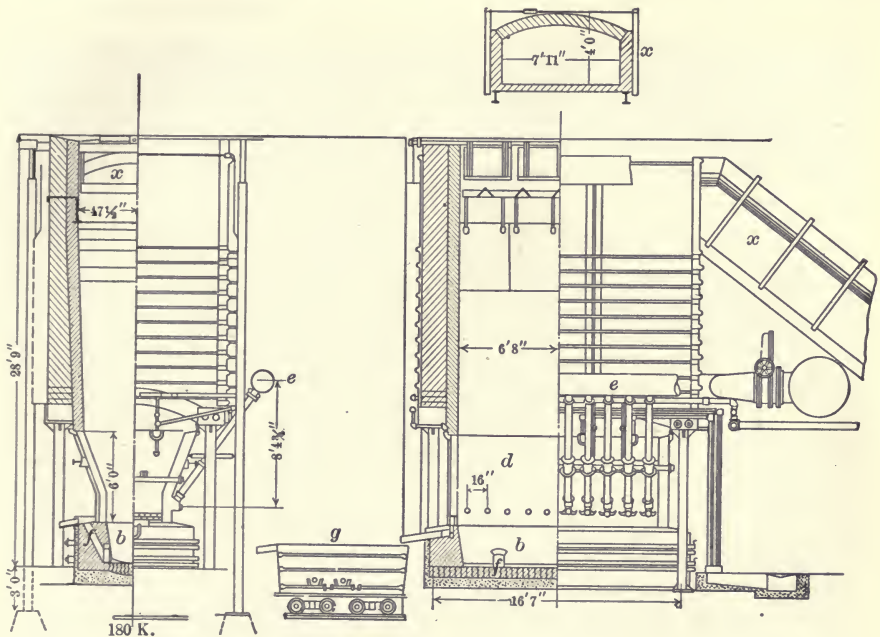

FIG. 261.—Lead Blast Furnace.

from above both for dumping charges and for cleaning out the furnace after shutting down.

**The Open-top Furnace.**—The furnace, Fig. 256, is fed by hand, shoveling the charge through the feed-doors into the furnace. At large smelting plants this method has been superseded by “automatic charging” (see Fig. 261). To prepare for this the closed top above the feed-floor is omitted. Then for charging a large car having a drop-bottom is brought to the furnace and the contents of the car dropped into it. Such a furnace is shown at Fig. 261. On the left we have a half section, half elevation, transverse to the furnace; at the right there is shown on one half, a longitudinal section, and beside it a fore-hearth. On the right half

is the longitudinal elevation and the brick down-take  $x$ , also a cross section of the down-take.

The furnace is 45 by 160 in. at the tuyere level, and widens to 95 by 160 in. at the top. There is a single steel jacket at each end, and two boshed jackets at each side. It will be noticed that the shaft widens out as it ascends. There are twenty tuyeres, ten on each side, the openings in the jackets being  $3\frac{1}{2}$  in. diameter. Each tuyere has its own metal blow-pipe and shut-off valve. The down-take  $x$  is 3 ft. 3 in. by 7 ft. 11 in. inside dimensions, and leads the smoke to a flue common to several furnaces. When a furnace is to be charged a light sheet-iron cover at the floor level is readily removed by hand. At 3 ft. below the charge-floor are set transversely angle-iron "spreaders," so that the materials, falling from the car, shall be spread or distributed evenly. In this particular installation the charge-car, of about the same width and length as the furnace, approaches it at the side; in other cases at the end of the furnace.

#### OPERATING THE BLAST-FURNACE

**Blowing In.**—The crucible and lead-well are dried out and warmed by a wood fire for twenty-four hours. They are then cleaned out and the crucible is filled, using the well-cleaned lead ingots from the drossing kettles. These are piled in cross order, filling the crucible. On them is laid a wood fire as high as the top of the breast, and after closing this the fire is lit at the tuyeres. The wood ablaze, more dry wood is added, then coke to the depth of 2 ft. with a little iron ore and limestone, just enough to flux the coke-ash. Then begins the charging, at first using double the usual quantity of coke, then, with the furnace full, dropping to the usual proportion.

The blast is increased gradually during one to two hours, until the furnace is in full operation. As the slag accumulates it is tapped, while the lead, accumulating in the crucible and lead-well, is either dipped from the lead-well with ladles, or tapped through a lead tap-hole at the level of the top of the crucible. The amount of lead removed at one time is limited to 1000 to 1500 lb. to keep the crucible always full. The operation of filling and starting takes seven hours.

**Regular Work on the Charge-floor.**—In a small furnace this consists in wheeling ore and fuel from the bins to the charge-scales, weighing the required amounts into charge-barrows or charge-cars, then dumping the charge thus prepared upon the feed-plates in front of the furnace doors. Every material except the fowl slag is weighed, and even the slag is added by shoveling in regular amounts. A charge is dumped on one charge-plate and the coke for it on the other. The coke is fed in an even layer, and the plate thus cleared receives an ore-charge. The ore-charge on the other

charge-plate is then added, taking care to place the larger ore at the middle of the furnace and the fine at the walls and corners. Such a distribution should be made as to cause the smoke and gas to rise evenly throughout. The blast tends to ascend at the walls more than in the middle, but by the distribution it is compelled to rise evenly. The plate, now cleared of the ore-charge, receives the coke that is next to go in. The content of the furnace remains at the level of the charge-floor, new charges being supplied as the surface sinks.

**Regular Work at the Ground or Slag-floor.**—This consists in regulating

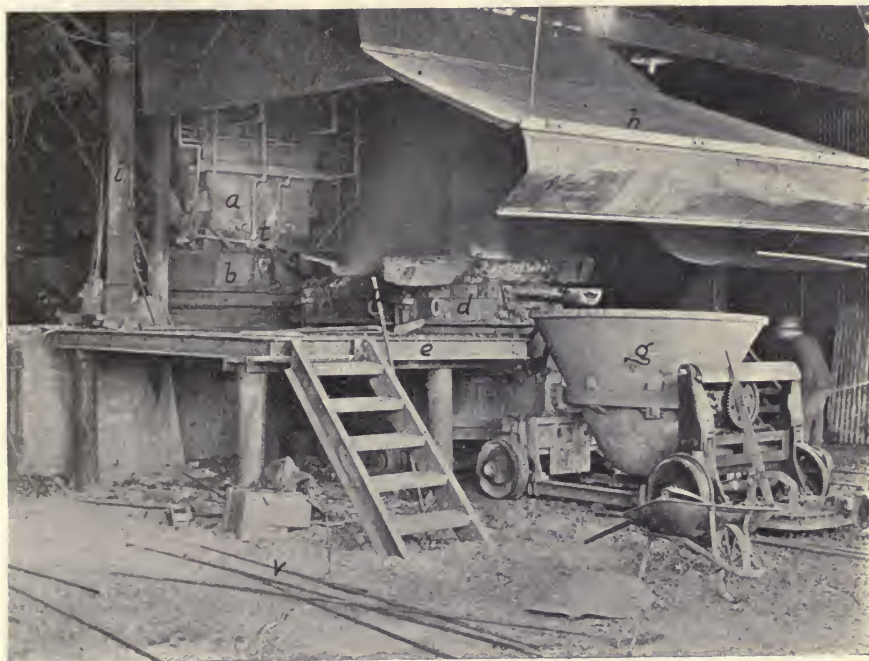

FIG. 262.—Front of Silver-lead Blast Furnace.

the water-supply at the jackets, seeing that the tuyeres are clean and open, tapping and stopping the slag, and when the slag and matte are separated in a fore-hearth, tapping the matte, placing the slag-pots (see Fig. 262), and removing them to the dump when full.

**Front End of Furnace.**—We show at Fig. 262 the front end of a large blast-furnace. Immediately at the front is to be seen the fore-hearth, *d*, 6 ft. by 9 ft. in size, mounted on wheels, and here the separation of the matte from slag is effected. The top of the slag in the fore-hearth soon becomes crusted over with a slag crust, but beneath this is the molten

slag and matte. The heavier matte settles out while the lighter slag escapes by a spout at the front of the fore-hearth into the bowl of a large slag-car, *g*, mounted on wheels. There is a tap-hole on the side opposite that shown, where the fore-hearth is tapped in order to remove the matte which then accumulates. This matte is generally received into flat or dish-shaped bowls and, when solidified, it is removed by a traveling crane. It is broken by hammers and is then ready for crushing to 3-mesh size for roasting.

When a slag-bowl is filled it is removed by an electric motor to the dump. A shell or "skull" of solidified slag has formed, lining the interior of the bowl and the top. A hole is broken in the top and the molten contents poured out as shown in Fig. 263. This shell is returned to the feed-floor to add to the charge, since it contains enough lead and silver to make this worth while. Of late some smelting works reject it all, saying that it contains so much zinc as an impurity that it does not pay to return it.

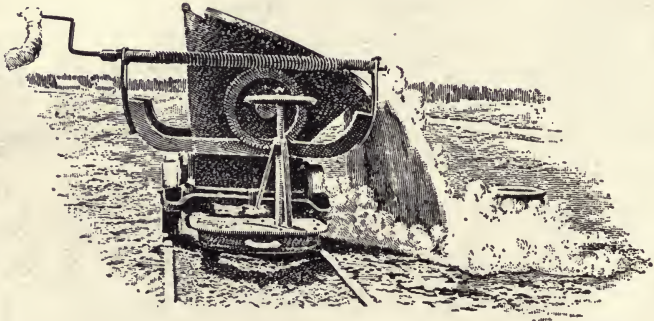

FIG. 263.—Side-dumping Slag-pot.

Slag is also conveniently removed by means of large slag pots mounted on trucks and drawn by an industrial locomotive, see Fig. 155, where the first two trucks are carrying shallow matte-bowls, the farther two slag bowls.

**Drossing Base-bullion.**—When handling base-bullion from the small blast-furnace of 50 to 100 tons capacity of a generation ago, the ordinary custom was to tap it when full from the lead well, into a cooler, a pot of one ton capacity. The dross of the metal would form a crust on top, and by aid of a perforated skimmer was put into molds, the clean lead being then added on top to yield a smooth-looking bar. The refinery got the copper-containing dross, and so did not complain.

The present method, using large furnaces, is to dross the lead as follows: The lead is tapped into pots on wheels, and this is accumulated in the drossing-kettle until it is filled with the molten lead. It is now skimmed, using a Howard press, the skimming, after pressing, being dumped upon a chute,



where it is broken up and returned to the blast-furnace. The hot molten lead is allowed to cool to the casting temperature and siphoned into molds, as described on page . The resultant lead, well freed from copper, still retains all its antimony, say 1.5 per cent, and this is sent to the refinery. The product is quite even, and its assay is accurate.

#### CHEMICAL REACTIONS AND PHYSICAL CHANGES OF THE BLAST-FURNACE

The surface of the charge should look dead, showing no visible heat or flame (over-fire). With much over-fire, there is a loss of lead due to volatilization. The moisture in the charge soon dries at the temperature of the rising gases (200° C.). The heat thus absorbed is small and by calculation it is found to be but one-thirtieth of the total supplied by the fuel when 5 per cent moisture is in the charge. As the materials of the charge descend in the furnace, carbon dioxide begins to be driven from the limestone, and the iron reduces from the ferric to the ferrous form. Half way down at a temperature of 800° C. the reactions are complete. The lead in oxidized form is reduced by the CO of the gas and by the red-hot coke. Galena reacts with the iron oxide and carbon as follows:

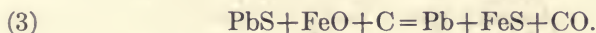

Sometimes scrap iron is added to the charge, and acts with galena or other sulphides as in the nail assay for silver, as follows:



As the lead, thus reduced, drops through the charge, it collects the gold and silver as well as a part of the arsenic and antimony, and enters the crucible as base-bullion. When antimony is present it is reduced like lead and alloys with the latter. Anglesite is reduced by contact with the fuel and iron oxide according to the following reaction:

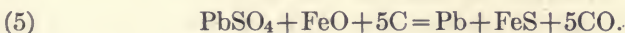

Where much anglesite is in the charge, more than the usual quantity of fuel is demanded. Since the affinity of sulphur for copper is greater than for iron, copper sulphide remains unreduced, and copper as an oxide takes sulphur from the charge and with the iron forms matte. Lead to the extent of 10 to 20 per cent, either as sulphide or in metallic form, is also taken up by the matte. To some extent zinc sulphide also enters the matte.

The ferrous oxide, not needed to satisfy the matte, and the CaO and MgO in the charge must be present in sufficient quantity to form a suitable fusible slag with the silica. Oxidized arsenic compounds react with iron and carbon producing a speiss, often of the form  $\text{Fe}_4\text{As}$ , and require extra fuel. The reaction is as follows:



The molten products separate at the hearth according to the specific gravity, that of lead being 11.5, speiss 6.0, matte 5.2, and slag 3.6. The lead, collected in the crucible, is withdrawn at the lead-well. The slag, matte, and speiss are drawn off at the slag tap-hole on the level of the top of the crucible and of the lead. The separation of matte from slag is generally effected in a fore-hearth outside the furnace.

#### SLAGS IN SILVER-LEAD SMELTING

The object of silver-lead smelting is to reduce the lead, and incidentally the gold and silver, from the ore. The sulphur present forms, with the copper, iron and a part of the lead, a complex artificial sulphide (matte), while basic flux is added to form a slag of the composition that experience shows necessary.

Slags are silicates of extraordinary complexity; and not all merely fusible slags work well in a silver-lead blast furnace. Type slags are those so proportioned in silica, iron oxide, and lime as to work well in a blast furnace. Slags that vary from the proportions become defective in operation. To fulfill the requirements of good slag, it should have, in the normal operation of the furnace, not more than 0.7 per cent lead, or 0.5 oz. silver per ton, when producing base-bullion not higher than 300 oz. silver per ton. The density should not be greater than 3.6. It should not permit accretions to form at the hearth, nor the creeping-up or appearance of over-fire. If a slag varies from one of the types given, it is either poorly reduced or makes other trouble in the furnace. Thus a slag of the three-quarter type, in which the CaO falls to 20 per cent (the other constituents being given in the table), is found to contain, for example, 1 per cent lead, and more than 1 oz. silver per ton; that is, it is "dirty." It easily may happen that a dirty slag is fusible, but we know that the slag will work satisfactorily if correct according to the type, the other conditions of good running being in evidence. Indeed, it is a common experience that a furnace, working poorly on an incorrect slag, begins to run well when a correct slag comes down. Following we give a table of type-slags that have been found to work well in practice:

TABLE OF TYPICAL SLAGS

Type.		SiO <sub>2</sub> , Per Cent.	Fe(Mn)O, Per Cent.	Ca(Ba,Mg)O, Per Cent.
Quarter-slag.....	C	28	50	12
Silicious quarter-slag.....	H	32	47	11
Half-slag.....	E	30	40	20
Half-slag.....	J	31	38	21
Silicious half-slag.....	I	35	38	17
Three-quarter-slag.....	F	33	33	23
Silicious three-quarter-slag.....	M	36	31	23
Whole, or 1 to 1 slag.....	G	35	27	28

According to the ratio of CaO to FeO the slag is called a "quarter," a "half," or a "one-to-one" slag, etc. Thus the slag E of the subjoined table is called a half-slag, the CaO being but half of the FeO. The slag C is a quarter-slag, the CaO being quarter of the FeO. In this table of typical well tested slags the three elements SiO<sub>2</sub>, Fe(Mn)O, and Ca(Mg,Ba)O are calculated to comprise 90 per cent. If the sum varies from this, the ratio is still to be preserved.

Since any of the slags of the table can be used, the question arises, which is to be chosen? In this we are guided by the economic conditions. If the ore of the district is silicious, and most profit is derived by treating the ore at hand, use a silicious slag that needs the smaller amount of flux. If irony or limy ores are plentiful and profitable to smelt, we use them, substituting them for flux. It is found, however, that slags of the type M and G of the table drive more slowly and require more fuel than the basic ones. Perhaps the most satisfactory of the slags, and the one that can be used where silicious ores are plentiful, is the three-quarter slag, F. When a slag of a certain type, for example a silicious one, is not working well and is forming accretions in the furnace, a radical change to a basic type is found beneficial, or from a basic slag to a silicious one.

#### ACTION OF VARIOUS BASES IN SLAGS

**Iron.**—Iron ore is quickly reduced to ferrous form under the action of the CO in the furnace or of the highly heated fuel thus:

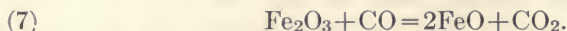

Iron oxide, being a stronger base than lead oxide, replaces it in the slag, and the latter is reduced by carbon to metallic lead.

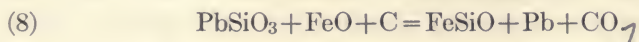

**Manganese.**—The equivalent for manganese is 55, and for iron 56, and they are reckoned as having equal values for fluxing. Manganese is found in some of the Leadville iron ores to the extent of 10 to 15 per cent, and since by introducing another element, it adds to the complexity of the slag, it also adds to the fusibility.

**The Alkaline Earths.**—Lime, magnesia, and baryta act in inverse ratio to their atomic weights in fluxing silica, hence to obtain the equivalent in lime, the percentage of magnesia is multiplied by 1.4 and of baryta by 0.4. A slag, high in lime and consequently low in iron like the last three in the table, is of low specific gravity. Its use thus results in a better separation of slag from the heavier matte. Lime being a stronger base by one-half than iron, and generally a cheaper flux, the tendency is to choose the limy slags. It is noticed that the higher the silica content of the slags of the table the higher is the lime, and that high silica calls for high lime. Dolomite, having a high content in magnesia, generally is avoided in silver-lead smelting, for it tends to make slag pasty and streaky, and the unfavorable effect is aggravated when zinc is also present. Two analyses of limestone and of dolomite are given below to show conditions typical of actual practice.

**Canyon City Limestone.**—CaO, 49.8 per cent; MgO, 3.0 per cent; SiO<sub>2</sub>, 3.1 per cent; Fe, 0.8 per cent.

**Iron County, Missouri, Dolomite.**—CaO, 26.6 per cent; MgO, 17.6 per cent; SiO<sub>2</sub>, 5.1 per cent; Fe, 3.3 per cent.

**Fluorspar.**—This has no unfavorable, but rather a favorable effect upon the quality of the slag. The fluorine, however, uses CaO, and hence the slag must analyze higher in CaO than the type requires, or it will not be clean.

**Alumina.**—It is uncertain whether alumina acts as an acid or a base. It is sufficient for the purpose of silver-lead smelting to regard it as a neutral constituent that dissolves in slag and acts in neither way.

**Zinc.**—Either blende or zinc oxide causes difficulties in the blast-furnace, the blende being the more objectionable. Blende is in part decomposed in the presence of iron to zinc oxide, but the zinc in any form tends to make a stiff, pasty, difficultly fusible slag. It may be regarded, like alumina, as being dissolved in the slag. It goes into both the slag and the matte and diminishing the specific gravity of the latter it causes a less perfect separation of the two. Where much zinc is in the charge, it is customary to modify the type-slag by calculating the zinc oxide as replacing one-half the percentage of lime. Take, for example, the half slag J of the table.

In the first column we write the slag as the type requires. In the second column we add the 8 per cent Zn and reduce the lime by 4 per cent by which the total becomes 94. Since the constituents should amount to but 90

	Without Zinc, Per Cent.	With Zinc, Per Cent.	Recal- culated Zinc, Per Cent.
SiO <sub>2</sub> .....	31	31	29.5
FeO.....	38	38	36.0
CaO.....	21	17	16.0
ZnO.....	.....	8	7.5
	90	94	90.0

per cent, all are reduced proportionately in the third column so as to give 90 per cent as the sum.

**Copper.**—Copper present in the charge enters the matte when, as generally is the case, sulphur is present with which it can combine. In smelting carbonate or oxidized ores, which furnish no sulphur, the copper becomes reduced, and enters the base-bullion, giving a lead so drossy sometimes as to clog the lead-well, and accumulate and solidify in the crucible. The remedy is to supply sulphide to form matte into which the copper can enter.

**Antimony.**—Either as an oxide or a sulphide, antimony is reduced like lead. It alloys with the base-bullion, making it hard, and is removed and recovered later in refining the base-bullion.

**Arsenic.**—This frequently is encountered in silver-lead smelting. When present in small quantity it is volatilized, but in large quantity it forms a speiss. Where it is intended to produce a speiss, iron is provided with which the arsenic unites. In the fire-assay of arsenic-bearing lead ores, a bead of speiss is found attached to the lead button. From the percentage of this we can compute the weight of the speiss that will be formed; and we may assume that 70 per cent of it is Fe. Where a direct determination of arsenic is made we can compute the weight, and multiply this by 2.3 to express the quantity of Fe to be provided on the charge for the purpose.

#### FUEL IN SILVER-LEAD SMELTING

The fuels used in silver-lead smelting are coke, charcoal, or a mixture of the two. Wood and hard coal have been used experimentally, the former in certain cases of scarcity of fuel.

**Coke.**—Coke is the kind of fuel commonly used. The ash varies from 10 to 22 per cent, and the fixed carbon from 89 to 77 per cent. In coke of high ash, not only is the ash to be smelted, but the carbon is correspondingly low, so that the coke is less efficient. A great difficulty with high-ash coke is that it is often friable, making accretions or scaffolds. Analyses of two typical samples of coke give the following results:

Connellsville coke contains fixed carbon 87.5 per cent, ash 11.3 per cent and sulphur 0.7 per cent; El Moro coke, fixed carbon 77.0 per cent, ash 22.0 per cent and sulphur (when the coke is made from unwashed coal) 0.9 per cent.

In computing a charge the coke-ash is taken into account, analyses being as follows: Ash of Connellsville coke:  $\text{SiO}_2$ , 44.6 per cent; Fe, 15.9 per cent;  $\text{CaO}$ , 7.0 per cent;  $\text{MgO}$ , 1.9 per cent; ash of El Moro coke:  $\text{SiO}_2$ , 84.5 per cent and Fe, 5.0 per cent.

**Charcoal.**—This fuel is used in districts far from railroads, where the cost of coke is high. It is a good fuel for oxidized ores, but is friable and makes undesirable fine which may form accretions or scaffolds in the furnace. It renders a charge more open than coke, and contains less than 2 per cent ash. Coke weighs 25 lb. and charcoal 10 lb. per cubic foot when loose, the weight of a bushel of charcoal being 14 to 16 lb. Even where charcoal is cheap it is desirable in operating the furnace to use part coke which, fed to the walls, burns more slowly than charcoal and makes the tuyere-zone hotter and gives a more liquid slag.

**Quantity of Fuel.**—This varies according to the nature of the charge, and generally is from 10 to 15 per cent. Charges that contain sulphur and make matte need less fuel than oxidized ores. Only sufficient is used to give adequate reduction and a hot slag; and the metallurgist is guided by these requirements in adding the fuel.

**Pulverized Coal.**—This is now being used to supplement the coke fed with the charge, being injected at the tuyeres of the blast-furnace, and burned as it meets the glowing charge. It is being used not only for copper but for silver-lead furnaces.

In smelting ores high in zinc, this, liberated by the fuel and flux, soon coats the descending coke with a white coating of zinc oxide, so that it burns with difficulty; the temperature falls, the slag becomes pasty and works poorly, and accretions form, so it is evident that the more fuel that can be added at the tuyeres the better the furnace should run. It also suggests the smelting of such ores in the reverberatory rather than in the blast-furnace.

#### CALCULATION OF A LEAD BLAST-FURNACE CHARGE

When sulphur-bearing, oxidized, or silicious ore is used, we have to consider not only the sulphur, silica, and other constituents of the ore, but also the products of the furnace that remove the constituents.

Ore (galena for example) containing less than 10 to 12 per cent sulphur generally is smelted without roasting. It is cheaper to do this, for by roasting, the sulphur of the ore is reduced to but 3 to 4 per cent. Many ores within the above limit are leady ores, and difficult to roast because of the

fusible nature; but the matte that they produce is easy to roast for the elimination of sulphur.

Ore intended for roasting may be simple, consisting of iron sulphide, or complex as shown by the following analysis of a roasted ore:  $\text{SiO}_2$ , 10 per cent; Fe and Mn, 27 per cent; CaO, MgO, and BaO, 2 per cent; Zn, 8.8 per cent; Cu, 0.4 per cent; S, 6 per cent; Pb, 35 per cent, and Ag, 50 oz. per ton. The base in the roasted ore was present as sulphide in the raw ore.

The so-called oxidized ores consist of the carbonate of lead with a gangue of iron oxide, limestone, dolomite, and silica. Such ores though called oxidized, often contain a little sulphur, as sulphide (galena or pyrite) or as sulphate.

Silicious ores are added to charges, in spite of the large excess of silica, because the gold and silver are present in quantity to pay to recover. The lead of the charge takes the gold and silver contained in such ore, while the silicious gangue is fluxed into a barren slag and sent to waste.

Both iron ore and limestone are added to the charge for fluxing the silica, making a slag of a predetermined composition or type. If the fluxes contain gold or silver the metals can be recovered, since they go into the base-bullion or work-lead. Without gold or silver they are called barren or "dead" fluxes. Ore carrying an excess of iron or lime over silica (called iron or lime excess) is in the same category, since the excess is useful for fluxing, and is credited in purchasing ores. Thus, ores containing 10 per cent  $\text{SiO}_2$  and 40 per cent Fe are said to carry 30 per cent iron excess.

Not all the slag that issues from the furnace is clean. At the spout where the matte flows, and in the shell lining the cavity of the fore-hearth, slag, containing drops of lead and matte, is found. When a slag-pot is emptied at the edge of the dump, there remains a shell or coating of solidified slag. This shell, half an inch thick, is found to contain drops of matte that did not entirely settle in the fore-hearth. This is particularly true when the fore-hearth has formed a thick lining and soon must be replaced by another. All this slag having value, and called "foul slag," is an acceptable addition to the charge because of the fusibility, and the coarse condition, permitting free passage of the air of the blast.

**Computation of the Charge.**—To determine the amount of the fluxes (iron ore and limestone) to add to the charge, to give a slag of a desired composition, it is necessary to know the weight of the ores to be used, and the results of analysis of the ore, fluxes and fuel, and also the composition of the slag and matte that are to be produced.

When a charge, thus calculated, has been put on the furnace and, after several hours, has come down, that is, has come into the melting zone, so that the slag of it begins to flow from the furnace, then a sample can be

taken, analyzed and the result of the analysis known in two or three hours. If this result shows variation from the desired slag, the charge-composition may be suitably altered to correct it. However, before making any changes, we must note that the slag is hot and well reduced.

For a charge to contain sintered ore, of size suited to automatic or mechanical charging, the following is an excellent example: Of this charge some 70 per cent is sintered material of lead. To this has been added of silicious ores, *A* and *B*. 350 lb. Bag-house fume is a product burned at

## BLAST-FURNACE CHARGE NO. 2

	WEIGHT.		Pb.		SiO <sub>2</sub> .		Fe(Mn).		CaO.		S.	
	Wet.	Dry.	Per Cent.	Lb.	Per Cent.	Lb.	Per Cent.	Lb.	Per Cent.	Lb.	Per Cent.	Lb.
Sinter.....	3450	....	24.0	828	20.5	707	25.0	862	5.4	117	4.4	151
Silicious ore A.....	250	....	2.0	7	55.0	137	14.0	49	...	...	13.0	13
Silicious ore B.....	100	....	2.5	3	50.0	50	16.0	16	...	...	6.2	6
Bag-house fume.....	100	....	58.0	58	1.0	1	1.0	1	2.0	2	...	...
Iron ore.....	200	....	3.0	6	11.0	22	41.0	82	9.0	18	...	...
Limestone.....	800	....	...	...	2.8	22	0.5	4	51.0	408	1.0	7
Coke.....	700	....	...	...	5.0	35	2.0	14	0.5	3	...	...
Slag (shells, etc.).....	500	....	...	...	...	...	...	...	...	...	...	...
Weight of charge....	4900			902		974		1028		548		177

Fe for matte 168

SiO<sub>2</sub> slag = 974

7860 S in slag = 40

FeO + MnO in slag = 1107

123 S volatilized = 53 93

CaO in slag = 548

9 S in matte = 84

2629 = 84 per cent of slag

1107

Fe for matte = 168

Slag - SiO<sub>2</sub> = 31 per cent

Total slag = 3130 lb.

FeO + MnO = 35.5

 $\frac{84}{0.11} = 380$  matte;  $\frac{380}{4900} = 7.7$  matte fall.

CaO = 17.5

Matte, Pb = 15.8 per cent; Fe = 45 per cent; Cu, 7.8 per cent; S = 22.5 per cent; Zn = 6.0 per cent.

the bag-house into a coherent product. To these is added iron ore and limestone to form a slag to contain SiO<sub>2</sub>, 31 per cent; FeO (and MnO); 35.5 per cent; CaO, 17.5 per cent. There is 8 per cent or so of zinc on the charge, and the slag composition corresponds most closely to the recalculated, zinc-bearing charge, given under "zinc." The slag used is higher in silica, and not so clean as the type-slag; on the other hand it runs with less furnace trouble. Not counting the coke or the slag, the charge is 4900 lb. in which the fuel is 14.3 per cent. The slag (3130 lb.) carries 1.5 per cent or 40 lb. of sulphur. Of the sulphur 30 per cent or 53 lb. is volatilized, and this leaves 84 lb. to form matte. It will be seen that the ratio of sulphur to iron gives a factor of 2, so that 168 lb. of iron is needed for the matte, leaving 860 lb. of iron (equivalent to 1107 lb. of FeO) to enter the slag. Since the matte contains 22 per cent of sulphur the 84 lb. present in it should give us 380 lb., equal to a matte-fall of 7.7 per cent only.



## CHAPTER XXXVII

### PRODUCTS OF THE BLAST-FURNACE

#### FLUE-DUST

A blast-furnace, 44 by 154 in., takes at least 6000 cu. ft. of air per minute when in full operation. The escaping gases, of an average temperature of  $150^{\circ}$  C., have expanded to 8000 cu. ft., and have a velocity, while rising through the charge, of from 5 to 10 ft. per second. When with a closed-top furnace the side doors are opened, additional air is drawn in and particles of 20-mesh size may be carried into the down-take and the long main flue leading to the tall stack which produces the draft. This main flue, which is common to all the blast-furnaces of the plant, is of large cross-section, for the purpose of settling and collecting the particles called "flue-dust." The collected dust, after suitable preparation either by sintering or by briquetting under pressure, can be returned as part of the blast-furnace charge. It commonly amounts to 0.5 to 0.8 per cent by weight of the charge, but with a sinter charge it should be even lower than this. These figures refer to what is caught in the flue. Where a bag-house is used, its saving should be added.

Some of the lead and silver and much of the sulphur, zinc, and arsenic of the charge is volatilized. This, in part, adheres to the cool surface of the flue. Eventually it flakes off and falls to the bottom, and is there recovered. Flue-dust is therefore composed of (1) dust carried along by the flue and (2) lead fume, containing the other volatile metals, condensed on the cool surface of the flue.

When a bag-house is not used, not all the material is recovered; the finest part may escape. An analysis of flue-dust made at the Pueblo Smelting Works, Colo., shows PbO, 37.6 per cent; ZnO, 53 per cent; Fe<sub>2</sub>O<sub>3</sub>, 25 per cent; Al<sub>2</sub>O<sub>3</sub>, 1.3 per cent; CaO (from the limestone), 5.3 per cent; SiO<sub>2</sub>, 8.9 per cent; S, 2.5 per cent; SO<sub>3</sub>, 1.6 per cent; H<sub>2</sub>O, CO<sub>2</sub> and C (from the coke), 11.2 per cent. When arsenic is present, part condenses in the flue, but much of it escapes, and is thus happily got rid of.

The carrying power of the moving gases varies as the square of the velocity, or directly as the draft pressure, therefore to settle out as much flue-dust as possible the main flue should have a large sectional area, or better yet, if the bag-house is not used, a dust-chamber should be provided.

Flues have been made of sheet-steel, but the metal corrodes under the action of the sulphuric acid and sulphates that are in the flue-dust, so that they last about ten years; brick therefore remains the favorite material for such construction. The bottom of brick flues is frequently a series of steel hoppers. Since these are continually covered by the flue-dust, they are protected from the fumes, and last a long time. A flue, rectangular in cross-section, may have brick walls, and top, and a hopper bottom set at such a height as to leave room beneath for a car running on a track at the ground level. The car can be set under any hopper, and to avoid escaping dust, the contents may be drawn into the car through a canvas sleeve fitted over the spout.

### THE BAG-HOUSE

**The Bag-house.**—Fig. 265 is a transverse section of a bag-house 140

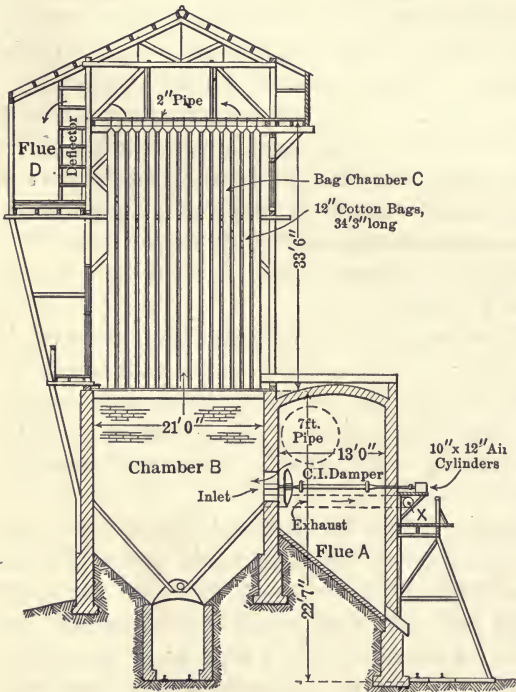

FIG. 265.—Bag-house.

ft. long by 24 ft. wide, as used for the recovery of flue-dust and lead fume, filtering the blast-furnace gases or fumes through cotton or woolen "bags" that leave them colorless. It is of a size to take the gases from six furnaces, equal to 60,000 cu. ft. per minute.

From the main furnace flue the gases are drawn through a 12-ft pipe called "the trail," by a No. 14 suction-fan which delivers them under pressure through a 7-foot pipe to flue A of the bag-house. Just before entering the fan, at the top of the flue, there is fed in a small and regular supply of finely ground quicklime to neutralize the small amount of  $H_2SO_3$  in the gases, which,

if allowed to remain, would speedily corrode the bags.

The bag-house, 140 ft. long, consists of a chamber "B" and a bag chamber "A," and is divided by transverse partitions into five chambers

or bays. Each bay has its own inlet and its own exhaust pipe both controlled by disk-valves, and an exhaust pipe, branching into the **pipe X**, which leads to the trail. As shown by the arrows the gases pass by the inlet into the **chamber "B"** enter the bags, inflating them, and filtering through the interstices of the fabric, escape through the **flue "D"** to the main stack (not shown) 210 ft. high. In the course of eight hours the bags are getting clogged by adherent flue-dust and this should be shaken off. By adjusting the two disk valves, above mentioned, any bag is by-passed, the bags of it are collapsed and the flue dust that has accumulated on them is loosened and falls down into the **chamber "B"** of that bay. The bags are shaken several times at five-minute intervals to give the dust time to fall down. Once in several days a side door of the bay is opened and a man entering takes hold of and gives the bags a more thorough shaking, the better to clean them. The dust sliding down the steeply inclined bottom of the bay is carried by a helical screw as in Fig. 267 to a discharge opening under the division wall of the bay. The "thimble floor" of the **bag chamber "C"** is of  $\frac{3}{4}$ -in. sheet steel, pierced with holes for thimbles, Fig. 266, these being 11 in. in diameter by 10 in. high, there being 240 per bay, or 1200 in all. The bags are about 13 in. in diameter and are 42 ft. long, wired at the bottom to the thimbles and, by means of wires, closed and suspended from 2-in. pipes at the top.

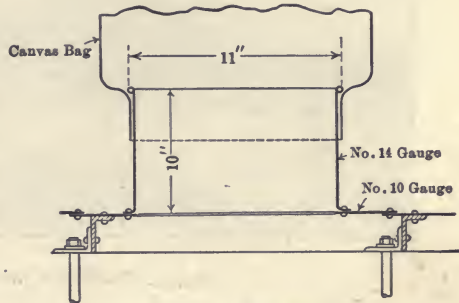

FIG. 266.—Detail of Bag-house Thimble.

**Treatment of the Flue-dust.**—The dust contains 60 per cent of lead, and is extremely fine. When 2 ft. in depth or so it is ignited, and once started, combustion proceeds, causing the dust to become sintered together, and in a condition favorable for feeding into the blast-furnace. The burned dust contains oxides and sulphates of the metals, viz., Pb, 60 to 70 per cent; Zn, 3 per cent; Fe, 0.5 per cent; As, 1.3 per cent, and Ag, 4.02 oz. per ton. Since the flue-dust is resmelted and the arsenic volatilizes, it tends to increase in the bag-house product; bismuth accumulates in the same way.

### BRIQUETTING FLUE-DUST

Flue-dust can be wet down and fed back to the blast-furnace. If fed a little at a time, it is simply carried again into the flue, but while wet, in occasional large charges, it may be fed so that most of it is carried down and smelted. The effective way is to make it into briquettes with milk-of-

lime as a binder. Fig. 267 represents a plant containing a White briquetting-press for making briquettes composed of flue-dust and milk-of-lime to which is added fine roasted ore. At the right in the figure, shown to be on a high platform, is a pile of quicklime. This is fed, together with water, into the lime-mixer, a trough divided transversely by a partition. One compartment is shown as containing the lime being mixed to a thin paste, while the other is now empty. The paste is drawn from either compart-

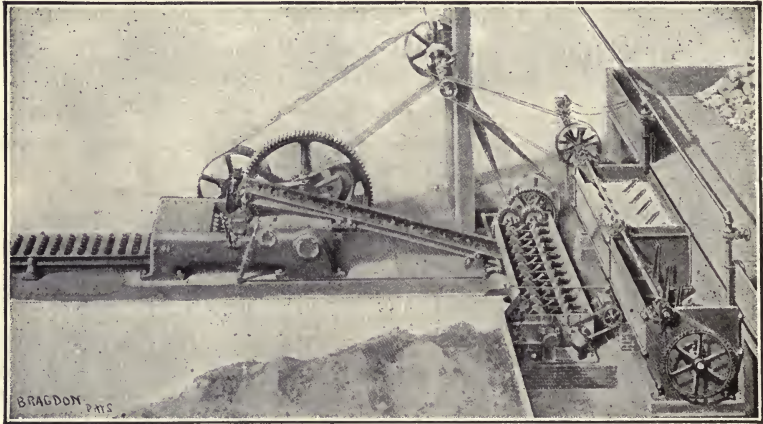

FIG. 267.—White Briquetting Press.



FIG. 268.—Horizontal Pug-mill.

ment to a horizontal double-shaft pug-mill. Each shaft is provided with mixing-blades. Flue-dust from the pile at the front of the lower platform is shoveled into the pug-mill and thoroughly mixed with the milk-of-lime by the revolving blades of the pug-mill which, being set at an angle, propel it to the discharge-opening immediately over a troughed conveying-belt. It drops into the hopper of a six-mold briquetting-press where it is made into briquettes that drop upon a flat conveying-belt delivering them to a pile. The briquettes may be used at the blast-furnace freshly made, but the usual plan is to dry them, as clay-bricks are dried.

Fig. 268 illustrates the internal construction, the spiral screw at one end of the shaft acting to speedily discharge the mixed material.

At times the briquetting is omitted, and the pug-mill mixture is wheeled to a drying-floor, or is distributed evenly upon one of the ore-beds. By the time the bed is used the mixture has set and becomes a hard mass capable of withstanding handling without being broken.

### LEAD-COPPER MATTE

The lead-smelting charge generally contains copper, and the copper accumulates in the matte. Since matte is roasted and returned to the blast-furnace, the content in copper gradually increases. When increased to 12 per cent, the copper matte is again roasted and treated in a separate blast-furnace, with silicious ore and oxidized copper ore, to produce a matte of 40 per cent copper, called "shipping-matte" because it often is shipped to a copper works to be treated for copper. This operation is called "concentrating."

### COMPARISON OF MATTE-TREATMENT METHODS

It has been urged against the treatment of low-grade matte that from each ton treated in concentrating it there is produced a ton of slag, and half a ton of lead-zinc fume both of which have to be retreated in the blast-furnace. But in the case of shipping matte, 3 tons of low-grade matte having been made into 1 of shipping grade, the consequent slag per ton of matte is but half a ton and the percentage of lead is proportionately lower.

The average composition of shipping matte may be thus given:

Pb, 26.9 per cent; Cu, 43.1 per cent; Ni and Co, 0.4 per cent;  $\text{SiO}_2$ , 0.3 per cent; Fe, 8 per cent; Zn, 2.5 per cent; S, 15.5 per cent; As, 1.7 per cent; Sb, 0.76 per cent; showing the complex nature of such matte, and how it takes up every impurity.

A satisfactory way of treating matte, where it is wished to produce a more finished product, is to crush it to a 4-mesh size and to roast it. It is next sent to a blast-furnace and again smelted with silicious and oxidized ores of high grade in copper. There results a matte of 65 per cent Cu and a certain quantity of "bottoms," the result of the separation of copper from the matte. The bottoms are charged into a reverberatory furnace through side-doors, and the coarse-broken matte is put on top. The doors are closed, and the charge is fired with an oxidizing flame, as in the Welsh process of "roasting." The charge having melted, a reaction of the cuprous oxide on the cuprous sulphide takes place, as described in the Welsh process of making blister-copper, see page 389, and the charge

becomes reduced to an impure copper containing arsenic, bismuth, and antimony, as well as the gold and silver that were contained in the matte. The copper is then poled to reduce the cuprous oxide, and ladled into anode-molds. The anodes are sent to an electrolytic copper refinery for treatment.

#### THE CONVERTING OF LEADY MATTE

One smelting works in the United States, the Tooele plant of the International S. & R. Co., has one department for the smelting of silver lead ores, another for the reverberatory smelting and converting of copper ores. It is therefore easily possible to treat the matte from the silver-lead furnaces in the converter as follows:

The matte is tapped from the blast-furnace fore-hearth into 10-ton pots and at the converter department is poured into similar pots standing in a pit. The final portion is held back to be poured into a shallow cast-iron pan together with some lead that has separated out in the bottom of the pan. When cold enough the crust of matte is lifted off, leaving the lead, still molten, behind. The main body of the matte in the 10-ton pot is transferred by crane and poured into the converter. At the beginning of the blow copious fumes are evolved which are drawn by a suction-fan to a bag-house. Special care must be taken that these fumes do not get too hot so as to set the bags afire. Pyrometers connected to signal lights indicate when this may happen and the converter man may then turn off the blast until the temperature becomes normal again. The quantity of fume, of both lead and zinc, diminishes as the blow proceeds, the smaller quantity of zinc fume uniting itself to any  $\text{SO}_3$  present to form zinc sulphate and so preventing acid corrosion of the bags. The bulk of the fume is lead, being about 65 per cent of the total. This fume, collecting at the bottom of the lower chamber of the bag-house is set afire from time to time, forming a slightly sintered product to return to the blast-furnace.

The converter is blown without addition of silica, thus forming a slag high in magnetite, this magnetite forming a basic lining that is permanent. The slag itself is basic. The contents of the ladle go to a granulator, where it is poured, the stream of slag being hit by a flat jet of water which granulates it. The product sinks into a deep hopper filled with water, out of which the slag is raised by a bucket-elevator. Added to the roaster charge, it forms an acceptable item of the sinter charge because of its excess of iron.

In a typical instance (per ton of blister copper produced), there is yielded in the flues and at the bag-house 0.368 ton of fume, yielding 0.221 ton of lead. An analysis of the fume showed Pb, 52.5 per cent; Cu trace; Zn, 3 per cent; S, 5.4 per cent; As, 14.2 per cent; Sb, 1.6 per cent; Fe, trace; Ag, 10 oz. per ton. This indicates that copper is not

volatile, while arsenic is quite so. The fume, after burning, is sent to the blast-furnace to recover the lead.

Returning to the matte, now freed from lead and zinc, it is added to the copper converter charge, the whole being blown to blister copper.

#### SELLING PRICE OF MATTE

Gold is paid for at \$19 per ounce, silver at 95 per cent of the New York quotation, copper price to be that of electrolytic at New York quotation. Lead over 5 per cent is charged for at 30 cents per unit, zinc over 7 per cent at 20 cents per unit.

## CHAPTER XXXVIII

### PRODUCTION OF LEAD ORES AND PRICES

#### COSTS OF LEAD ORES

To illustrate the method of calculating the actual cost of treating an ore, as in the Colorado or Utah silver-lead smelting practice, we take the case of a so-called neutral ore ( $\text{SiO}_2$  equal to Fe). The ore is assumed to be oxidized, to contain less than 5 per cent sulphur, and at least 10 per cent lead. It is to be treated at a works having an output of 400 tons of charge daily.

The cost of treating a ton of charge, and of treating a ton of the ore including the flux, is as follows:

Costs per Ton.	Charge.	Ore.
Labor.....	1.76	2.46
Coke (12.6 per cent of charge at \$12.60 per ton).....	1.60	2.24
Power costs.....	0.14	0.19
Interest, replacements and repairs.....	0.52	0.73
Delays due to accidents, strikes, etc., 5 per cent.....	0.37	0.52
General expense, assaying and management.....	0.40	0.56
Depreciation 10 per cent on \$2,000,000 investment of plant....	0.04	0.06
Limestone (0.3 ton at \$2).....		0.60
Iron ore (0.1 ton at \$8).....		0.80
	<b>\$4.83</b>	<b>\$8.76</b>

The figures in the second column are obtained by multiplying the total weight of the charge, 1.4 tons, by the cost of each item per ton of material and then adding the cost of the flux. This corresponds to the figure above obtained, and may be stated again as follows:

1.4 tons of material (1 ton ore, 0.3 ton limestone, and 0.1 ton of iron ore) at \$4.83	
per ton of charge for smelting.....	\$6.86
Cost of fluxes, 0.3 ton of limestone at \$2.00.....	0.60
Cost of fluxes, 0.1 ton of iron ore at \$8.00.....	0.80
	<b>\$8.16</b>

In case the ore contains sulphur in quantity to require roasting, \$2 should be added. For sulphur over 5 per cent and up to 10 per cent add



30 cents per unit to cover the expense of iron ore for disposing of the extra sulphur, and roasting the matte made by it.

**Distribution.**—The costs of production per ton of charge smelted have been thus divided: Labor 23 per cent; coke, 40 per cent; coal, 5 per cent; limestone for coke ash, 5 per cent; maintenance and repairs, 5 per cent; delays due to accidents, strikes, etc., 5 per cent; flue dust recovery, 2 per cent; administration, 7 per cent.

#### ORE PRICES; MISSISSIPPI VALLEY LEAD SMELTING WORKS

Non-argentiferous lead concentrates are bought at a quoted rate based upon an 80 per cent lead content as determined by wet assay, with a deduction of 50 cents per unit for all below and an addition of 50 cents for all over 80 per cent.

#### ORE PRICES; COLORADO AND UTAH SILVER-LEAD SMELTERIES

**Silver-lead and Dry Ores.**—The price per ton, dry weight, delivered at the smelting works, depends upon the value of the contents of the ore as determined by fire assay, and based upon the New York price of the metals. From these values must be deducted the charge for treatment or working charge and a reasonable profit. The working charge (W. C.) varies with the lead contents, the insoluble residue (approximately the silica), the iron, the sulphur, zinc, and speiss (iron arsenide) present in the ore.

A central custom silver-lead smeltery buys and combines for smelting a variety of ores to its profit; and smelts, not only argentiferous lead ores, but lead-free or dry ones. This it can do if it has enough lead-bearing ore on the charge to insure the extraction of the precious metals from the dry ores also being smelted.

**The Metal Values.**—These are commonly paid for as follows: **Gold** at \$19 per ounce, **Silver** at 95 per cent of its New York value less a further deduction in Utah of 3.5 cents per ounce to cover the freight charge now made upon base-bullion that contains it, but no such charge is made upon silver in Colorado ores. The 5 per cent deduction made in the silver price is intended to cover that lost in smelting.

**Lead.**—Based upon a quotation of 6 cents per pound a deduction of 10 per cent is made to cover the smelting loss and in Utah a further deduction of \$35 per ton of lead to cover freight and refining loss. This is based upon a charge of \$17 per ton of lead for freight and a further deduction of \$18 per ton for refining.

**Treatment Rate or Working Charge.**—The base-price for smelting ores is \$2.50 per ton with lead at 6 cents per pound; if the value of lead exceeds this, then 50 cents per unit is added to the treatment rate, while, when

lead falls below 6 cents, a corresponding 50 cents a unit is taken from that rate.<sup>6</sup> No distinction is now made between oxidized and sulphide ores. At present the furnace charge is two-thirds or more sinter, and in this has been put the fines out of all ores, such fines coming from the custom of crushing when sampling. Since the cost per ton of ore furnaced, and the cost per ton of materials put through is accurately known, as well as the cost of roasting and refining, it has been thought best to make the base price for smelting equal to this actual cost plus a reasonable profit and to seldom make finer distinctions. This runs much the same day by day, and the month's profit, in normal operation, approaches the known figure. When lead ores are scarce the ore buyer will make concessions to procure them. In Colorado a different rule holds and in the schedule for dry oxidized ores the treatment charges vary from \$7.50 to \$9.50 per ton between gross values of from \$8 to \$20, that is these charges increase with the value of the ore.

**Debits or Penalties.**—A charge is made of 10 cents per unit for all insoluble matter. Speiss over 5 per cent is charged at 20 cents per unit. All zinc over 10 per cent is charged at 30 cents per unit. All sulphur is charged at 25 cents a unit, but not to exceed a maximum of \$3 per ton.

#### PROFITS PER TON

We will now compute the price f. o. b. at the works for a Utah ore of the composition, Insol., 40 per cent; Fe, 10 per cent; CaO, 5 per cent; Pb, 20 per cent; Cu, 0.3 per cent; Zn, 8 per cent; S, 5 per cent; Ag, 18 oz. and Au 0.10 oz. per ton.

#### Credits.

Metal values Au 0.10 oz. at \$19.....	\$1.90	
Ag 18 oz. at \$1.10 per oz. 95 per cent of this less 3¼ cents.....	18.18	
Pb 20 per cent or 400 lb. less 10 per cent less 1.75 cents with lead at at 6 cents per pound.....	15.30	
		<hr/>
Metal values.....	\$35.38	
Fe credit 10 per cent at 6 cents.....	.60	
		<hr/>
Total credits.....	\$34.78	

#### Debits.

Treatment. Base charge.....	\$2.50	
Insoluble 40 per cent at 10 cents.....	4.00	
Zinc 5 per cent over allowance at 30 cents.....	1.50	
		<hr/>
Total debits.....	\$8.00	\$8.00
		<hr/>
Net value of the dry ore.....		\$26.78

The realization per ton will be

Gold, 100 per cent of 0.10 oz. at \$20.56 per ounce.....	\$2.06
Silver, 98 per cent of 18 oz. at \$1.10 per ounce.....	19.40
Lead, 92 per cent of 400 lb. at 6 cents per pound.....	22.08
<hr/>	
Total metal values.....	\$43.54
Net cost per ton f.o.b. at the works.....	26.78
Treatment.....	6.00
Freight at \$17, refining at \$12 on 0.184 ton base bullion.....	5.34
Selling the product.....	0.32
Interest on metals in process, three months at 6 per cent.....	0.53
<hr/>	
Total costs.....	\$38.97
Profits per ton to pay for capital investment to balance.....	4.57
<hr/>	
Total realization.....	\$43.54

Since analysis is based on the dry ton the moisture must be deducted from the gross weight to determine the weight dry. No charge is made, for sampling except in lots of a few tons.

#### VARIATION IN COSTS DUE TO OUTPUT, ETC.

**Comments on Costs.**—Where operations proceed smoothly where slag losses are no greater than given for good smelting, where by the bag-house and the electrostatic treater the metal losses are low, where gold and copper in small amounts are not paid for, and where the metals are skillfully sold, profits may be as high as above calculated. On the other hand, if iron ore and limestone must be purchased for fluxing, if the metal market is a falling one, if it is not possible to get the best combination of ores for profitable smelting, if the works are running at part capacity, these profits will dwindle. The money to carry a stock of ores and supplies, and for freight advances should be valued at 6 per cent per annum.

To treat a silicious ore of 50 per cent silica, provided the iron ore and limestone must be purchased, is expensive, since with 1 ton of ore one must use 1.5 tons of fluxes and smelt 2.5 tons of materials of the charge, the estimated cost being \$21 per ton. The actual charge for treatment is about half this and even the extra charge of  $3\frac{1}{2}$  cents per ounce of the silver does not compensate. In general there is an excess of iron for fluxing which comes from iron sulphides and iron ores. It must also be remembered that a ton of such silicious ore will produce 1.75 tons of slag, which slag carries off silver and lead. The term "displacement" refers to that condition where much silicious ore is smelted, so that for 100 tons smelted 40 tons would be ore, while if the ore is neutral of 100 tons of charge 72.5 tons would carry the profit.

The price may be modified according to the needs of the works. Thus, if lead ores are much needed they may be bought even at a loss while to compensate the more plentiful ores may be bought at a low price.

## CHAPTER XXXIX

### REFINING OF LEAD AND BASE-BULLION

Primary lead, or that produced by smelteries, may be divided into three kinds on the market, viz.: Soft lead, which comes from non-argentiferous ores; desilverized lead produced from base-bullion; antimonial lead, a by-product of the Parkes process. Soft lead from the ore-hearth is commonly remelted and poled to remove impurities. Desilverized lead may be divided into common lead suited to making pipe, sheet lead, shot, and lead alloys. A softer grade is called corroding lead for making white lead. Antimonial lead as a base for type metal and bearing-metal contains 15 to 20 per cent antimony.

#### REFINING BASE-BULLION

**Sampling and Handling.**—The practice at large silver-lead smelting works is now to remelt all base-bullion from the blast-furnace. Sometimes the lead is taken in molten condition to the remelting kettle from the blast-furnace. When melted in the remelting kettle it is carefully skimmed, and as in lead refining, the cleaned lead is molded into bars. The skimming or dross, containing copper and other impurity, is returned to the blast-furnace. The copper there enters the matte and the lead again goes to the base-bullion. While the lead is being molded samples are taken from the kettle at intervals, and from the samples the assay-results are obtained. The bars for a 40-ton carload, 800 in number, are stamped with the number of the lot, and are carefully weighed, twenty at a time. Careful assays are made of each lot, both by the shipper and by the refiner.

At smaller plants the punch sample is taken as described in the chapter on sampling. The results are exact.

**Characteristics of Base-bullion.**—Lead containing silver, commonly called base-bullion, is refined by the Pattinson or by the Parkes process. Commonly the Parkes process is used. The object in either process is to effect the separation of the silver and gold from the lead.

To get a clear idea of the principles of refining base-bullion (or work-lead as it is called in Europe) we first must know the composition. An especially base quality is represented by the following analysis:

	Per Cent.	Per Cent.
Lead.....		96.59
Impurities: Cu.....	0.82	
As.....	0.38	
Sb.....	0.71	
Fe.....	0.02	
S.....	0.14	
		<hr/> 2.67
Precious metals: Ag (322 oz. per ton).....	1.07	
Au (0.20 oz. per ton).....	0.0007	
		<hr/> 1.07
		<hr/> <hr/> 99.73

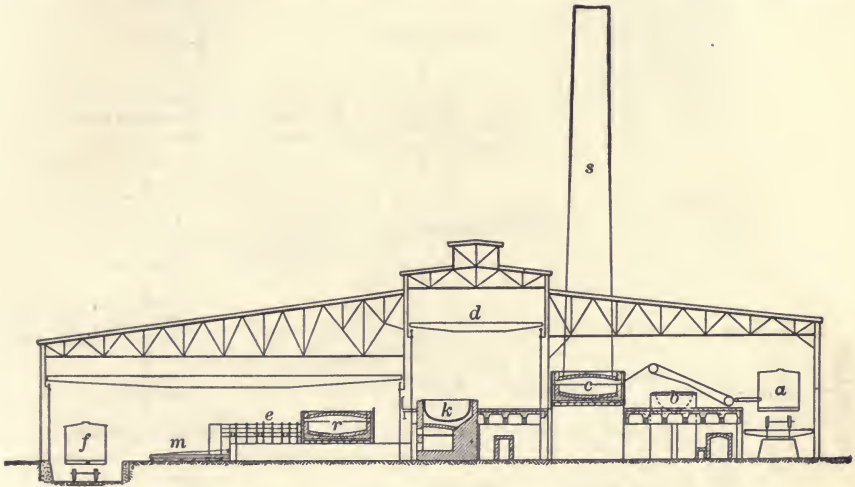

FIG. 269.—Lead-refinery Building (cross-section).

It is seen that base-bullion is principally lead. The problem is to soften the lead by removing the impurities, and then to separate the gold and silver from the purified or softened lead. In studying the process the student should refer to Figs. 280 and 269.

THE REFINERY

In Fig. 269 we have a cross-section of the refinery building showing the course of the base-bullion through it as further elucidated in the flow-sheet Fig. 270.

The bullion, in bars or ingots of 100 lb., pass by an inclined elevator to the softening furnace *S*, whence the softened metal goes to the zincing kettle *K*. The silver and gold are here removed and the lead yet containing some zinc passes on to another reverberatory furnace, where the

zinc is burned off and the residual lead, now soft, is molded into bars or ingots (see Fig. 276), for the market.

Fig. 270 is a flow-sheet of the process from the receiving of the base bullion to the production of the market lead and silver-gold or doré bars, the latter to be parted for the production of gold and silver.

### SOFTENING BASE-BULLION

**The Softening Furnace.**—Softening is performed in a water-jacketed reverberatory furnace, Fig. 271. The rectangular hearth of the furnace, 7 by 14 ft. in size, is surrounded by a sheet-steel double water-jacket, shown in section at (a) in the sectional elevation (c). The jacket assists

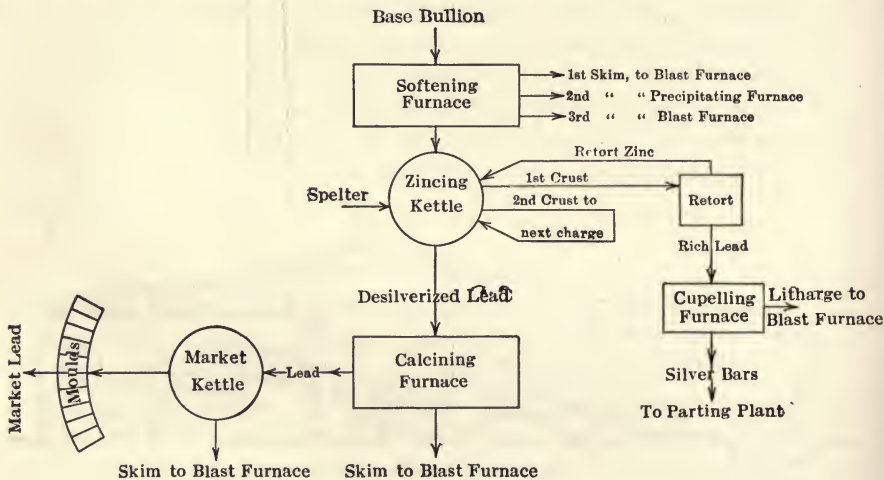

FIG. 270.—Lead-refining by the Parkes Process.

in resisting the action of the molten litharge formed from the lead in the operation. Within the water-jackets the hearth and walls are a dense aluminous brick, and at the slag line, where the corrosive action of the litharge is intense, bauxite brick of 98 per cent  $\text{Al}_2\text{O}_3$  are used. The furnace is heated by the firebox, having a grate 4 by 5 ft. in dimensions, so that a high temperature can be attained in the furnace. The letters *c, c* indicate the rear working doors and *b, b, b* the front doors in which the base-bullion is charged. At the front of the furnace the tap-hole *e* is provided, through which the lead is tapped when the charge is finished. The furnace communicates to a stack 50 ft. high by a flue at the front end.

**Operation.**—The work is done in two stages. In the first stage at a low temperature, the copper is removed. In the second, at a high temperature, the arsenic and antimony are expelled, after which there is left only the softened lead containing the precious metals.

The base-bullion, in charges of 30 tons, is placed in the furnace by means of a long-handled paddle or "peel" having a blade 2 ft. long by 6 in. wide. The bars are laid one at a time upon this and placed as desired in the furnace, being piled in a heap on the hearth. The doors are closed and the bars are gradually melted down, the dross contained in the bullion rising to the top. When melted the heat is maintained slightly above the melting-point, but not higher. In about two hours the dross that has risen to the top is carefully skimmed, by means of a long-handled perforated

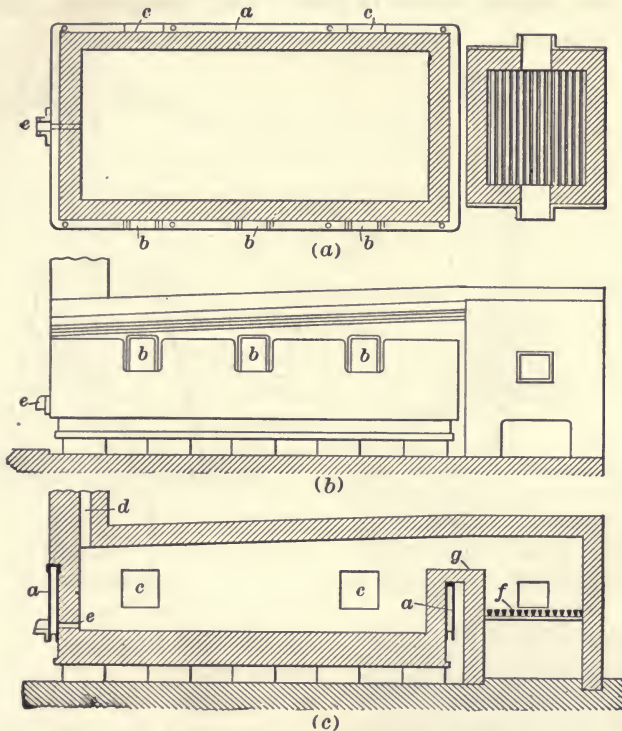

FIG. 271.—Softening Furnace (Parkes process).

skimmer, and removed through the door to a wheelbarrow placed for it. The dross, residue, or skimming, called the "copper skim," consists of a drossy lead containing the iron, sulphur, and (especially important) most of the copper of the base-bullion. The removal of these completes the first stage of the process.\* The liquated dross thus skimmed, which

\* It should be here noted that where the smelting plant and refinery are in one, the blast-furnace lead is treated as described under "Sampling and Handling." There results a product which, when charged into the softening furnace, can omit the first stage and the lead is treated to the second stage or obtaining the "antimony skim" only.

may amount to 5 per cent of the charge or 1.5 tons, consists of Pb, 62.4 per cent; Cu, 17.97 per cent; Ag, 0.17 per cent (49 oz. per ton); As, 2.32 per cent; Sb, 0.98 per cent; Fe, 0.43 per cent; S, 4 per cent; and O, 1.87 per cent. Slag, ash, and hearth material also are contained and must be reckoned in.

The heat of the molten bath is now raised to a bright red ( $600^{\circ}$  to  $650^{\circ}$  C.) and the flame, made oxidizing by the admission of an excess of air through the thin fire, sweeps over the surface. Litharge forms, and the antimony and arsenic oxidize and enter the litharge slag. The litharge

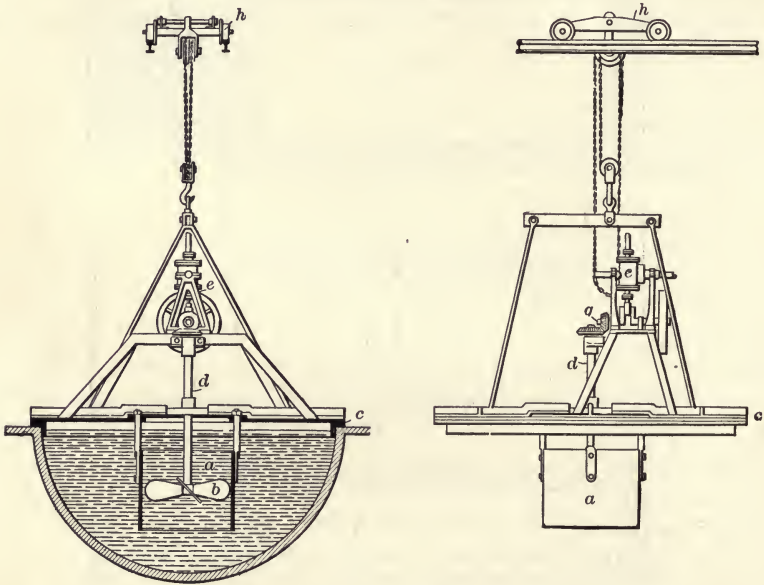

FIG. 272.—Howard Mixer.

at this temperature has a corrosive action upon the brick lining, hence the need of a water-jacketed furnace. This stage of the process lasts twelve hours, until a sample of the lead taken from the furnace and placed in a mold and skimmed, shows by the appearance that it is free from arsenic and antimony. Before the antimony is removed the surface of the molten lead will "work," or show oily drops moving upon it. A similar phenomenon is seen in the first stage of cupelling base-bullion high in antimony and arsenic. As the softening proceeds the drops become fewer and smaller, and finally a coating is seen to dull the surface of the hot molten lead, indicating the completion of the softening. For impure base-bullion this stage is of more than twelve hours' duration, and the thick layer of litharge formed retards further oxidation. It is best then to draw the fire



and to cool the charge, to allow the litharge slag on the top to solidify above the liquid lead beneath. The slag is skimmed with a long-handled perforated skimmer (compare with Fig. 275), and the charge is fired again if necessary until the impurities are removed. The "antimony skim" consists of the antimonate and arsenate of the lead with a large proportion of litharge. It is in fact an impure litharge containing 15 to 20 per cent antimony.

The softened lead to be treated by the Pattinson (see page 510), or the Parkes process for the removal of the contained gold and silver, is now tapped into the desilverizing kettle, 8 ft. diameter and capable of holding 30 tons of lead.

### THE PARKES PROCESS

**Operation.**—The softened lead from the softening-furnace is tapped into a hemispherical cast-iron kettle, shown in Fig. 272, which holds 30 tons or more of lead or the full charge from the softener. The kettle is set in brickwork, and is heated from a firebox below. In modern practice kettles are made large and are 10 ft. diameter and 2 ft. 10 in. deep, holding 60 to 65 tons.

The lead from the softening-furnace flows along a cast-iron trough to the kettle. In so doing a litharge dross, called "kettle dross," forms, and collects on the surface of the metal, and is skimmed off.

The principle of the separation of silver from lead depends on the affinity of silver for zinc, which is greater than for lead. Upon adding and thoroughly mixing in a small amount of zinc it takes up most of the silver. Zinc has a greater affinity than lead, not only for silver, but for gold and copper. When the molten bath is allowed to stand a while, the zinc, being lighter, separates and rises to the surface. At a temperature below the melting-point of zinc, but above that of lead, a crust forms that can be skimmed off. Thus the silver is concentrated in a small bulk of metal, and is later separated from the rich metal by further treatment.

The molten bath is heated to an incipient red heat, well above the melting-point of zinc, and cakes or ingots of spelter equal to about 1.2 per cent of the weight, or 720 lb., are added. The quantity required varies with the richness of the base-bullion in silver. The added zinc quickly melts.

Desilverizing machinery is now much used. The most approved



FIG. 273.—Skimming Base-bullion.

machine is the Howard, used both for mixing and skimming. Fig. 272 represents, in section and elevation, the kettle and the apparatus used for intimately mixing the molten zinc with the lead. The machine is brought to the kettle by an overhead crawl *h* and is lowered into it by a chain-block hoist. When lowered into position as shown in Fig. 272, the screw pro-

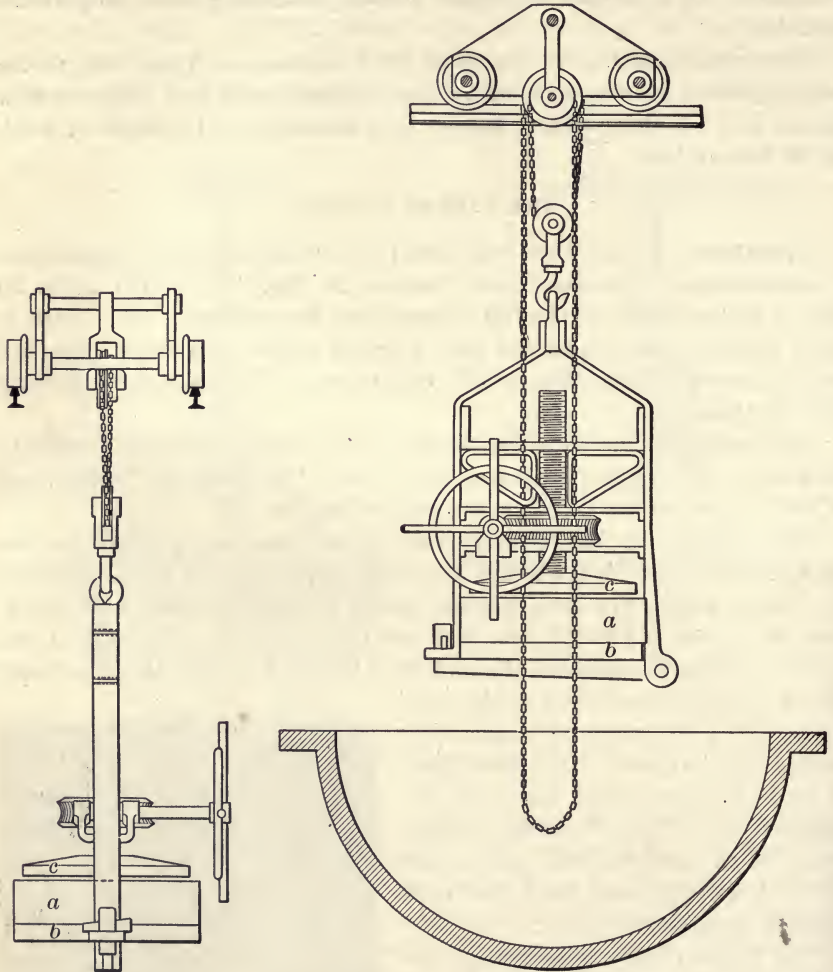

FIG. 274.—Howard Press.

PELLER *b* is set in motion by a steam-driven mechanism so as to produce a downward flow of molten lead in the sheet-iron cylinder *a*. The cylinder has neither top nor bottom, and being submerged in the lead, a circulation is started, the lead flowing in over the top of the cylinder. Thus a thorough mixing of the content of the kettle is assured. In a few minutes

the engine is reversed, and the flow is made upward over the edge of the cylinder, then downward to the bottom. The mixing is continued about eleven minutes, after which time the stirring apparatus is bodily hoisted and moved to one side. Several kettles can be thus served by one mixer.

The content of the kettle is now allowed to cool two hours or more. The light zinc rises to the top and carries the silver, gold, and copper with it. Finally when the temperature falls below the melting-point, a half-fused, mushy crust or layer forms upon the lead. The crust consists of 65 per cent Pb; 10 per cent Ag and Au; 3 per cent Cu; and 22 to 24 per cent Zn.

Fig. 274 is an elevation of the Howard press by which the zinc crust is removed from the lead. Another elevation shows also a section of the cast-iron pot into which the press is about to be lowered. In principle the machine is like a cheese-press. The apparatus is lowered into the lead until the top edge of the cylinder *a* is but slightly above the surface. The plunger or follower *c* is raised, and the zinc-crust, as it is skimmed from the surface, is put in it by means of the perforated skimmer, Fig. 275.



FIG. 275.—Skimmer.

The press thus expedites the skimming. While one man is skimming and putting the skimming into the press, another assists by pushing the crust to one place with a wooden rabble. When full, the press is raised and the surplus lead begins to run out of the half-inch holes in the hinged bottom *b*. The plunger *c* is brought down, squeezing out more of the lead, and leaves the remaining, mushy, half-fluid mass nearly free from lead, of the composition given above. The press is now run to one side over a floor paved with cast-iron plates, the hinged bottom *b* is dropped by releasing the catch, and the zinc-crust is pushed out by continuing the downward movement of the plunger. The crust falls upon the cast-iron floor-plate, and while soft is readily broken with hammers into lumps the size of the fist. Meanwhile the hinged bottom is closed, and the press returned to the kettle and is opened to receive more skimming. These operations continue until the surface of the lead is well skimmed and take in all about twelve hours. The crust amounts to 3000 lb. and contains 90 per cent of the silver originally in the softened base-bullion, resulting in a concentration of twenty into one.

**Dezincing Furnace.**—This first “zincing” removes all the gold and copper for which zinc has a great affinity. It does not remove all the silver,

and the operation must be repeated once or twice more before the silver content is diminished to the fraction of an ounce per ton beyond which it does not pay to go. Of the 1.8 per cent zinc needed, first is added  $\frac{2}{3}$  of the zinc or 1.2 per cent, then  $\frac{1}{4}$ , or 0.45 per cent, and finally the remaining  $\frac{1}{12}$ , or 0.15 per cent; or 900, 270, and 90 lb. respectively.

The desilverized lead remaining in the kettle after the last skimming retains 0.6 to 0.7 per cent zinc and traces of arsenic and antimony, all of which must be removed before the lead is suitable for market. This is done by siphoning or tapping the metal from the kettle into a reverberatory furnace similar in construction to the softening furnace. Here the charge is brought up to a bright-red heat, the zinc is volatilized and burned off, and litharge forms as a slag upon the surface of the lead. The operation



FIG. 276.—Molding Market Lead.

takes six hours, and is complete when the zinc has been expelled, as shown by taking a sample of lead in a mold and observing the appearance of the surface as the metal solidifies. The furnace is allowed to cool until the litharge-slag is solid and can be skimmed.

**Molding.**—Finally the lead is tapped into a market-kettle similar to the desilverizing kettle. This is the reservoir from which it is drawn to be cast into molds. The molds, fifty in number, standing in a semicircle as shown in Fig. 276, hold 100 lb. of lead each, and are conveniently mounted on two wheels by which, when full and cool, they are transferred to the adjoining floor. There the lead is tilted out and the molds at once returned to the semicircle to be used again. The lead is withdrawn from the kettle by means of a siphon. It descends into a small cast-iron pot, into which is screwed the  $2\frac{1}{2}$ -in. pipe that delivers it to the fifty molds, the pipe being quickly moved from mold to mold as filled, without interrupting the flow.

At the end of each round the flow is interrupted only to carry back the end of the pipe to the first mold of the series, which meanwhile has been emptied and replaced. The 100-lb. pigs, or bars, are the desilverized lead of commerce.

Dry steam may be blown into the molten lead in the kettle to refine it. It is introduced by means of a pipe inserted deep beneath the surface. The constant agitation produced by the steam brings the metal in contact with the air and oxidizes it and the remaining impurity. It is softer than ordinary desilverized lead, and is easily corroded by the acetic acid used in making white lead. It is accordingly called "corroding lead."

#### TREATMENT OF THE RICH LEAD

**Retorting.**—Referring to the diagram (Fig. 270), we see what becomes of the crust or skimming that results from the first zincing. The material is in lumps, containing 22 to 24 per cent zinc. It is charged with charcoal breeze, into bottle-shaped retorts *f*, Fig. 277, each holding 1200 lb. zinc-crust. The figure represents at (*a*) a sectional elevation through the retort, at (*b*) a transverse section, and at (*c*) an elevation of a Faber du Faur tilting retort-furnace. The retort rests upon a narrow arch, and carries a grate upon which rests a coke fire that fills the furnace and covers the retort *f*. The products of combustion escape by an outlet-port at the back to a stack of good draft. The coke is fed through a hole in the roof of the furnace, and is poked down, and kept in vigorous combustion, so that a yellow heat (1000° C.) is attained. A condenser, made by cutting off the end of an old retort (as shown at (*c*), Fig. 277), collects the zinc vapors distilling from the charge, the condensed zinc being drawn into mold *sz* through a 1-in. hole, bored through the bottom edge of the condenser. When distillation is complete, the condenser and the supporting truck are removed, the furnace is tilted or revolved by means of a lever on the trunnions, and the remaining "rich-lead" is poured into molds like those used for molding market-lead. The rich lead still retains zinc, copper, and impurities, taken into the crust at the first zincing.

**Cupelling.**—To obtain the silver (and gold) from the alloy, the English cupelling-furnace, Fig. 278, is used. The principle of the action is much like that of cupellation in assaying, except the litharge here not only saturates the cupel, but flows from it as fast as formed. Fig. 278 shows the firebox *b* where a long-flaming coal is burned, the products of combustion passing to the chimney. The flame plays over the hearth called a "test," a large cupel rammed tight within a test ring, shown mounted on the carriage. The test is lowered by the jack-screws, removed on the carriage, and another is put into the bottom opening of the hearth,

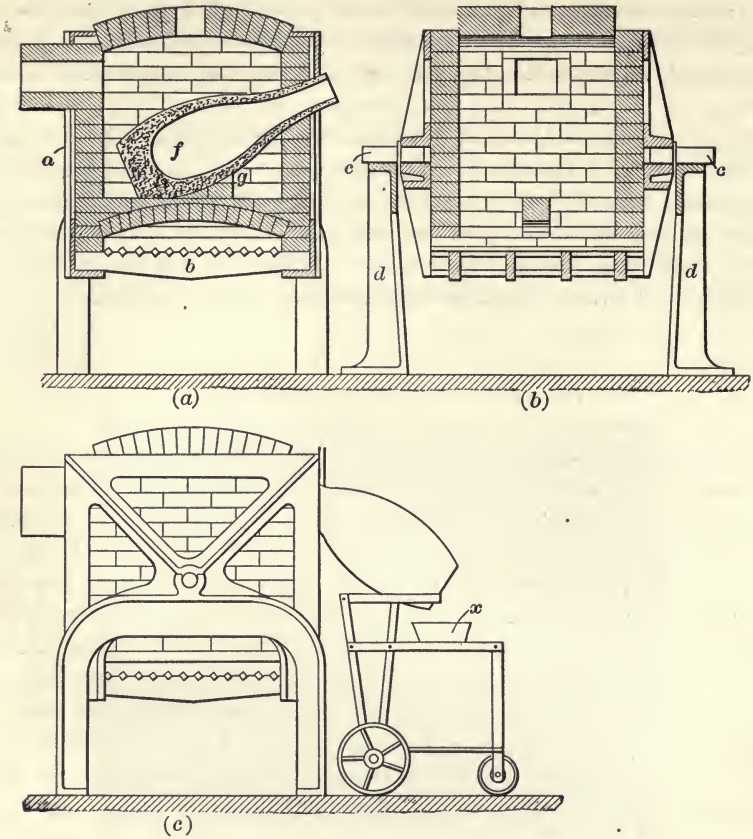

FIG. 277.—Faber du Faur Retort.

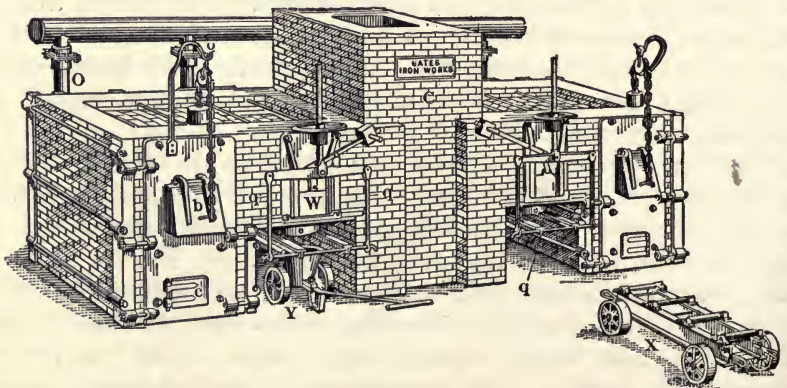

FIG. 278—Perspective View of English Cupelling Furnaces.

when the first is consumed. The test is hollowed like a cupel, to hold a shallow bath of molten lead 3 in. deep. Fig. 279 shows two views of the test and the supporting truck, including a view of an inverted truck and test. In the furnace, Fig. 278, is seen the overhead pipe, branching to the ash-pit, to supply under-grate blast, and to an opening at the back of the furnace where a tuyere is inserted, by which a stream of air is brought to play upon the surface of the molten red-hot bath of rich lead. The air oxidizes the lead to litharge. Other impurities are oxidized and enter the litharge-slag and are carried away with it. The molten litharge, as it forms, escapes by a shallow groove or channel in the top of the front edge of the cupel or test. A door *w* can be lifted to inspect the operation, or to cut the channel as needed. At the rear are provided two ports of a size to permit inserting two bars of rich lead that

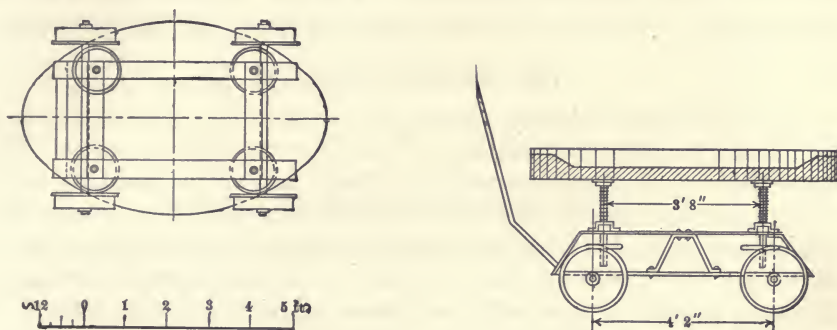

FIG. 279.—Carriage and Test for English Cupelling Furnace.

are pushed in as fast as the cupellation proceeds. The ends of the bars melt and supply the lead. The litharge stream is the size of a lead-pencil, and falls into a small slag-pot beneath. The lead is fed at the rate of 1 to 2 tons daily until the bath has become rich in silver, when the feeding of the lead must be stopped. Oxidation then is continued, cutting the channel deep to allow the remaining litharge to flow out, and finally the mirror-like bath of silver appears. The fire must keep the temperature above the melting point of the silver. At the last, a shovelful of bone-ash is thrown on the bath to absorb the remaining trace of litharge as it forms on the surface. This is skimmed, and the silver is then ready to be ladled out or tapped, commonly into the cast-iron molds, each holding 1000 oz. silver. This is then subjected to the acid-parting operation to be described later.

The copper-skimming, which is the first obtained from the softening furnace, is returned to the blast-furnace where the sulphur of the charge combines with the copper and removes it as matte. The rest of the skimming, mostly lead, containing silver and gold, is reduced to base-bullion.

The third skimming of the softening-furnace, if any, is returned to the blast-furnace, since it contains but little antimony.

The second softening skimming or antimony-skim, containing 15 to 25 per cent antimony, goes to a small reverberatory furnace, 8 by 12 ft. hearth dimensions and 10 in. deep, built like a softening-furnace and called a precipitating-furnace. Here it is melted, with a reducing flame into a slag. Charcoal is added, and stirred, to reduce or precipitate part of the lead of the slag. The lead, falling to the bottom of the bath, carries down the silver of the slag. When the reaction is complete, the supernatant slag is tapped into slag-pots, and the lead is tapped into a kettle at a lower level and molded into bars. This precipitated lead-bullion is returned to the softening-furnace to be softened and desilverized. The antimonial slag, containing about 6 oz. silver per ton, when accumulated, is smelted in a small blast-furnace to reduce it to antimonial lead of 20 per cent Sb, which is sold to the type founders. The slag is rejected.

#### THE PATTINSON PROCESS

When a kettle containing molten lead is allowed to cool slowly as it approaches solidification, crystals of lead low in silver separate. The metal that remains liquid contains the larger part of the precious metal. The crystals are removed with a perforated ladle, melted in another kettle, and allowed to cool. Once more crystals separate that are low in silver, the mother liquor becoming high in silver. If the liquid portion first mentioned be transferred to a kettle and likewise heated and then allowed to cool, the same segregation of the silver into the liquid part continues. We can accordingly arrange a series of kettles containing, at one end low-grade lead, and at the other high-grade, all from one product. A series of this kind, as illustrated by practice at Eureka, Nev., gave the assays quoted in the table below.

Another crystallization would reduce the silver of the market lead to half the value given. The rich lead could be directly cupelled in an English cupelling-furnace, or better, treated by the Parkes process to get rich silver-zinc crust for retorting and cupelling. The process has been modified recently by Tredennick, who raises each kettle by hydraulic power above the adjoining one so that the mother liquor drains from one kettle to the next through a strainer, the lead being cooled near the solidification temperature by introducing steam upon the surface. The cost of operating has been greatly decreased in this way. The chief advantage of the Pattison process over the Parkes is that it gives a product free from bismuth. In the Parkes process the bismuth follows the lead. Bismuth is injurious in lead that is to be corroded to make white lead, and it may be necessary to employ the Pattinson process for making a corroding lead from bismuth-bearing ores.



Kettle	Market Lead Ounces Ag per Ton.
No. 1.....	1.25
No. 2.....	2.5
No. 2.....	5.0
No. 4.....	9.0
No. 5.....	18.0
No. 6.....	30.0
No. 7.....	50.0
No. 8.....	75.0
No. 9.....	100.0
No. 10.....	150.0
No. 11*.....	450.0

\* Rich Lead.

**COST OF REFINING BASE-BULLION**

The actual cost of refining base-bullion is as follows:

Prime or flat-cost, of softening and refining.....	\$5.00 to	\$6.00
General expense.....	3.00 to	3.00
Loss in metals and incidental expenses.....	1.70 to	3.00
Total.....	\$9.70 to	\$12.00

**SELLING PRICE OF BASE-BULLION**

**Base-bullion.**—A small works may sell this product to an Eastern refinery as follows:

Gold is paid for at \$20.40 per ounce. Silver at 99 per cent of New York quotation, sixty days after date of sampling at the refinery. Lead is paid for at 99 per cent of the New York quotation, thirty days after same date of sampling.

Refining cost, \$12 per ton. An advance will be given up to 90 per cent of the net value with a charge of 6 per cent for said advance.

**THE BETTS PROCESS FOR THE ELECTROLYTIC REFINING OF LEAD**

The principle of this process depends upon the solubility of lead in an acid solution of lead fluosilicate, which is used as an electrolyte. The solution is formed by diluting hydrofluoric acid containing 35 per cent HF with an equal volume of water and saturating with powdered quartz according to the reaction:

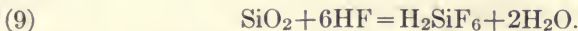

In the hydrofluosilic acid lead is dissolved. The solution contains 7 to 10 per cent lead, and 8 to 12 per cent of fluosilicic acid (H<sub>2</sub>S; F<sub>6</sub>), the free acid varying from 3 to 5 per cent lead. To obtain a solid deposit on the cathode glue is added to the extent of 0.1 per cent.

The anodes are plates of the base-bullion to be refined, cast  $1\frac{1}{2}$  in. thick, resembling ordinary copper anodes.

The cathode-sheets that receive the deposited lead are "stripping plates," obtained as in the case with copper cathodes. They are made by depositing lead upon steel cathode-plates, prepared for use by cleaning, coating with copper, lightly lead-plating them in the tanks, and greasing with paraffin. On them is deposited the lead, and when the coating is of the desired thickness the steel cathodes are removed from the bath, and the lead coating or sheets are stripped off for use as cathode. Another method consists in casting the cathodes in the form of thin sheets.

The anodes and cathodes are placed  $1\frac{3}{4}$  in. apart in the tank. As in copper refining, the anodes are in multiple, and the tanks in series. The current enters the anodes, passes through the electrolyte to the cathodes, dissolves the lead from the anodes and deposits it upon the cathodes.

The fall of potential between anode and cathode is 0.45 volt, and the current strength is 15 to 18 amperes per square foot. One ampere deposits  $3\frac{1}{4}$  oz. lead per twenty-four hours following the ratio of the atomic weights of copper and lead which is 63.6 to 207.

In the process the impurities remain as an adherent coating on the anode, and consist of the copper, bismuth, arsenic, gold, and silver. The zinc, iron, cobalt, and nickel dissolve in the electrolyte.

The cathode (containing the starting sheet) is melted and cast into bars; the anode mud recovered from the anode and collected at the bottom of the tank is refined to recover the precious metals. When about three-fourths corroded the anode is removed.

As compared with ordinary refined lead, electrolytically refined lead is pure, being practically free from bismuth, even when much is present in the base-bullion, and it must be remembered that bismuth is harmful to "corroding lead."

The residue or anode-slime, averaging 8000 oz. or more of silver and gold per ton, is treated by boiling it with sulphuric acid, using a steam pipe inserted in the solution to boil and agitate it with free access of air. The washed residue is melted in a small basic-lined reverberatory furnace, the copper is removed by using niter as a flux, and the antimony by the addition of soda. The doré bars finally obtained are parted in the usual way with sulphuric acid.

The process is used at East Chicago and Trail, B. C. At Omaha it is confined to the refining of base bullion containing 1.5 per cent bismuth.

## SMELTERY AND REFINERY FOR SILVER-LEAD ORES

We show in Fig. 280 a general view of a company plant for the treatment of their own ores and base-bullion.

Referring to Fig. 280 a double track at the right (in this case the West



Fig. 280.—Plan of Silver-lead Smelting and Refining Works.

side) brings in coke and ore, the first to the coke storage and the second to the ore storage bins at the extreme left. Here the coarse ore is taken out to be sent to the blast-furnace building, and the fines go to the Wedge

roasters and the Dwight-Lloyd sinter plant. The base-bullion from the blast-furnace adjoining goes to the lead refinery, giving two products, the market lead to the lead storage warehouse and doré bars to be parted at the gold and silver refinery. The blast-furnace flue, parallel to the blast-furnace building, turns at right angles, forming the "trail" to the fan-house where the fume is driven through the bag-house and finally to the 15-foot by 200-foot Custodis stack. Powdered coal is used in the refinery and the Dwight-Lloyd sinter plant.

PART VII

ZINC



## CHAPTER XL

### ZINC AND ITS ORES

#### PROPERTIES OF ZINC

Zinc is a bluish-white metal of specific gravity 6.9 to 7.2, according to the way it has been cast and cooled. The rolled metal has a specific gravity of about 7.25. Zinc melts at  $419^{\circ}$  C. and boils at  $950^{\circ}$  C. with a characteristic brilliant bluish-green flame. The commercial metal becomes malleable and ductile if heated to  $100^{\circ}$  to  $150^{\circ}$  C. and when cooled from this can be rolled. At  $205^{\circ}$  C. it again becomes brittle, and may be pulverized in an iron mortar. Zinc has a tensile strength of but 18,700 to 22,200 lb. per sq. in. when in sheets or wire. When it passes from the cold solid to the molten condition it increases in volume and on again cooling contracts but slightly. Carbon dioxide readily oxidizes zinc vapor with the production of carbon monoxide and zinc oxide.

To the metallurgist its value in the recovery of the precious metals in the Parkes process and its usefulness in cyanidation largely appeals.

#### ZINC ORES

The principal ores of zinc are blende and calamine. In New Jersey occur deposits of franklinite,  $\text{ZnOFe}_2\text{O}_3$ . The zinc minerals seldom occur pure; besides the earthy gangue, and sulphides of iron, lead and copper, blende as marmatite or black-jack contains iron so combined chemically that it cannot be separated by ore-dressing methods.

Blende, or sphalerite ( $\text{ZnS}$ ), when of a yellow color as in the ore of the Joplin district in Missouri, is called rosin-blende. When dark in color, due to chemically contained iron as in the ore of the Rocky Mountain States, it is called black-jack. It is from blende concentrate that most of the spelter of commerce is extracted. It needs roasting before it can be retorted or smelted for extracting the zinc.

**Calamine** is a term applied commercially both to the carbonate (smithsonite) and to the hydrous silicate of zinc. It is an oxidized or sulphur-free ore that needs no preliminary roasting before smelting. On being heated in the retort, the  $\text{CO}_2$  of the carbonate is expelled, leaving zinc oxide.

**Willemite**, the anhydrous silicate occurring with franklinite in New

Jersey, mixed with coal, is decomposed at the high temperature of the retort, yielding zinc.

It is generally found advantageous to calcine calamine for the purpose of driving off  $\text{CO}_2$  and water, which are undesirable in retorting because of their oxidizing action on zinc-vapor. However, the preliminary calcination is often omitted, but when performed, it is done in kilns much like those in which lime is burned.



## CHAPTER XLI

### ROASTING ZINC ORES

#### REDUCTION OF ORES OF ZINC

In outline, the metallurgy of zinc consists in grinding the ore (generally blende) and roasting to convert into zinc oxide, then charging the roasted ore, intimately mixed with fine coal, into horizontal, cylindrical, clay retorts, heated to a white heat, where the zinc, reduced by the coal, volatilizes, and the vapor, entering the cool, tapering, clay extension of the retort (called the condenser), condenses there. As it accumulates it is tapped into a ladle from time to time, skimmed, and cast in molds. When distillation is complete the condenser is removed and the content of the retort taken out and generally thrown away. The cycle of operations takes twenty-four hours.

#### ROASTING BLENDE

The aim is to dead-roast the ore, generally to 1 per cent sulphur or less. For every 1 per cent sulphur remaining in the roasted ore, 2 per cent zinc is held back in the retort-residue after distillation.

The ore is ground to about 6-mesh size, then slowly and carefully roasted with frequent stirring, finishing the roast at a high temperature to decompose the zinc sulphate formed at the lower temperature. The ore is generally in the form of concentrate, still containing a little gangue, galena, and pyrite. To remove the final 1 per cent of sulphur would require a long time and would not be commercially profitable. The ore is accordingly considered to be finished when it contains no more than that amount of sulphur.

#### CHEMISTRY OF ROASTING ZINC ORES

We have, in the roasting of blende, the following reactions:

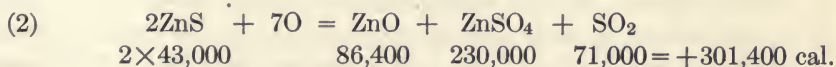
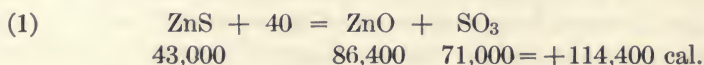

Thus in an oxidizing flame, blende is roasted to oxide and sulphate, both reactions being exothermic. As indicated in the reactions given in the chapter on Roasting, pyrite or chalcopyrite assists in the reactions. At a cherry-red heat the zinc sulphate is decomposed into basic sulphate ( $3\text{ZnO}$ ,  $\text{ZnSO}_4$ ) thus:



The basic sulphate, exposed to a bright-red heat for a time, reacts thus:



Finally zinc oxide is obtained and the sulphuric anhydride is eliminated.

When limestone or calcite is present it is converted in large part to sulphate. Galena also roasts to a sulphate, and tends to envelop particles of blende, and to prevent their roasting. Much of the blende from Leadville, Colo., and other Western States, contains silver, and it consequently often pays to treat the retort-residues after the zinc has been removed.

There is a loss of silver in roasting that may be given at 10 to 15 per cent and also a loss of zinc as dust and volatilization at the final high temperature that may be reckoned at 2 per cent or more.

In roasting zinc sulphides, and especially flotation concentrates, better results in retorting are attained by finishing the roast without an excess of air. Thus roasted, the product sinters and becomes more porous, and the sulphur left in the ore is less harmful.

#### ROASTING FURNACES

The roasting of blende has been performed in hand-rabbled reverberatory furnaces as well as in a great variety of mechanical furnaces. These are described in the chapter on Roasting. The latter are gradually supplanting the former because of the saving of labor. It should be noted, however, that the wear is great on mechanical furnaces that have ironwork exposed to the heat because of the high final heat needed in blende-roasting and consequently the types of furnace have been preferred where the rabble is exposed but a short time to the action of the fire, and where iron parts are not exposed or can be water-cooled.

Thus, the Brown horseshoe furnace, where the rabble is drawn through a circular hearth, then allowed to cool, or the Wetthey furnace, where the rabble is exposed to the fire but half of the time and the moving iron parts are outside the furnace, have been successfully used in blende-roasting. Of the recent types, the Hegeler furnace has proved most successful for the above reasons. It is a multiple-hearth furnace closed by swinging sheet-iron doors at the ends, and stirred by rabbles drawn quickly through the furnace by means of rake rods, so that the parts are outside the furnace

most of the time and no iron parts, except the end swinging doors, are affected by the fire. The hearths being superimposed make a compact furnace, and the radiation is greatly lessened, so that there is economy of fuel.

#### THE WEDGE MECHANICAL BLENDE-ROASTING FURNACE

This, one of the most successful of the blende roasters where it is desired to save the sulphur fumes for sulphurous acid, is shown in Fig. 281.

It is commonly used for an oxidizing roast, the gases carrying about  $2\frac{1}{2}$  per cent sulphur, but for use in making sulphuric acid the gas should carry 6 to 7 per cent of sulphur. This is thus accomplished: The blende carrying about 25 per cent of sulphur is self-roasting, the sulphur escaping at the desired strength. Below the fifth hearth, however, when no more than 8 per cent sulphur remains, it needs a fire to roast it. The floor of the fifth hearth is thin and between it and the roof of the sixth hearth is a muffle space where the flame from the firebox at the left enters and is down-drafted. That is, the flame passes through drop-holes, then successively through the sixth and seventh hearths to a side-flue leading to the chimney, and in its progress roasting the ore from 8 per cent down to 1 or 2 per cent, the degree needed for properly roasted ore. In the thickness of the side walls is a drop-hole or passage downward debouching into No. 6 hearth. Ore pushed into this drop-hole fills it with a talus at the outlet which is swept away by the rabble of No. 6 hearth. Thus the ore passes down by a sealed opening while the fire gases cannot escape upward, To mingle with the strong sulphur fumes produced above.

#### THE HEGELER FURNACE

Fig. 282 gives a transverse section, a longitudinal elevation and section and a plan of the furnace, of 75 ft. effective length, and built double. Referring to one side there are seven roasting-hearth each marked *B*, three fire-hearth *A*, and a hearth *C*, for preheating the air for the roasting hearth. Thus the three lower roasting-hearth *B*, are heated by the fire-hearth, constituting muffles, so that the fire-gases do not mingle with the roaster gas. In operation, the furnace being at full heat, the ore, to the amount of one charge is dropped from the hopper *D* upon the upper or No. 1 hearth. By the action of a rake of the width of the hearth, introduced through the end door at that end, it is pushed along and spread out upon the just-emptied hearth. The next time the rake is passed through the ore is worked to the opposite end of No. 1 hearth and through the opening *E*, to the second hearth *B*. Another rake propels it through *B*, and so progressively through the remaining hearths until, at the lowest one, it discharges through a side-opening into a waiting ore car. The path of



the fire-gases is in an opposite direction, the producer or natural gas being admitted to the lowest hearth *A*, at one end, and traveling to the other, being partly burned by the admission of air at side-ports. The gas then by a by-pass at the side goes to the hearth *A*, there to be further burned, and the combustion is finished on the third or upper fire-hearth *A*. At the end of this the gases pass into a flue of their own, and thence to the chimney. Air for roasting is admitted, partly in the lower hearth *B*, partly in the two hearths above it, and taking a course opposite to that of the ore in its descent, leaves the top of the furnace at the opening *F*, into the flue *G*.

It will be observed that the furnace is built double, so that when

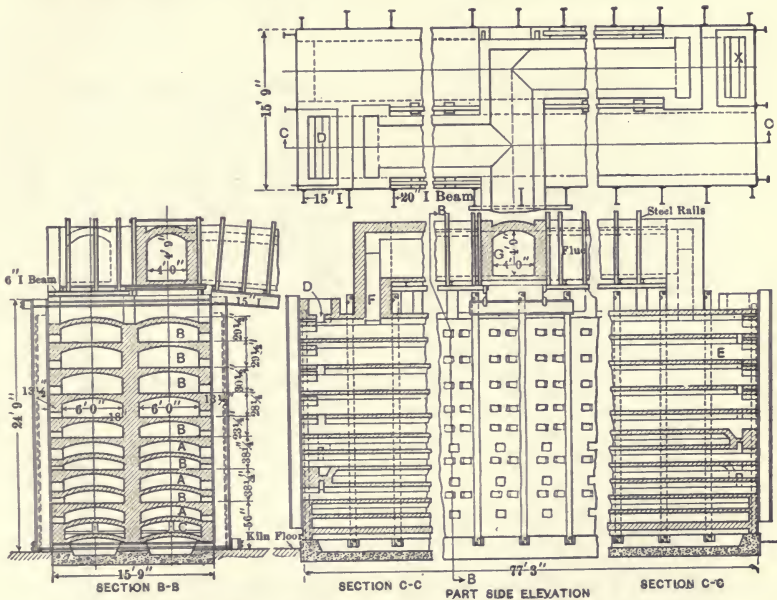

FIG. 283.—Hegeler Roasting Furnace.

ore is admitted at *D*, it is also admitted at *X* on the opposite end, and the same rake works both hearths in succession. The rakes or other moving parts do not remain constantly in the furnace, but a rod is passed through from one end, hooks on to the rake and pulls it back with it.

The furnace is used in this country where it is necessary to convert the sulphur gases into sulphuric acid, but on account of the high labor and maintenance costs, is rarely used where acid is not made. The capacity of the furnace is about 45 tons per day, with a coal consumption of 25 to 35 per cent of coal dependent on conditions. The furnace is also sometimes built with regenerative chambers for the fire gas, whereby the fuel consumption is reduced where the high price of fuel makes this imperative.

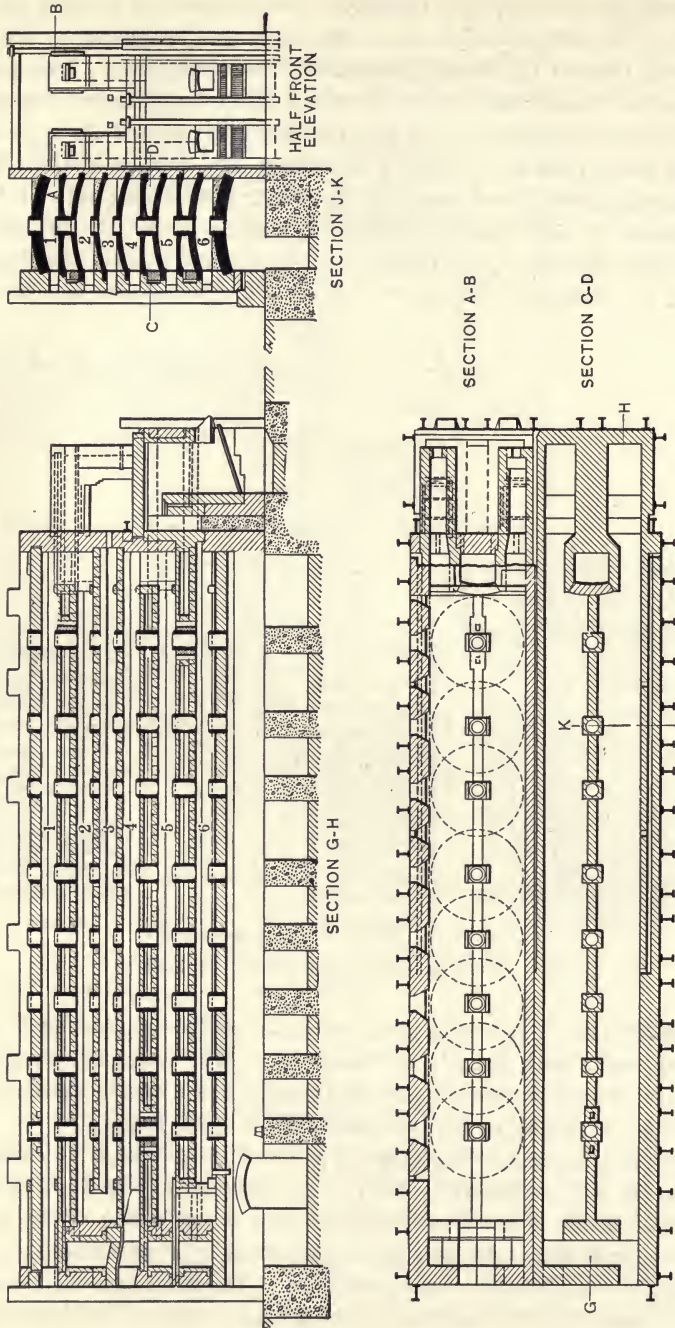

Fig. 284.—The Merton Roasting Furnace.

## VARIOUS FURNACES

Other furnaces used for the roasting of blende where acid is not made from the waste gases, are the Zellweiger and the Ropp, both of them straight line single hearth furnaces of the Brown-O'Hara type. In European practice the Merton and the Ridge furnaces are somewhat generally adapted for blende roasting, although on account of cheaper labor, hand roasters are somewhat common there.

## THE MERTON FURNACE

This is a muffled furnace, having six muffles, where the ore is roasted, and between the floor of one and the roof of the next a space transversed by the fire-gases. Referring to the longitudinal section, Fig. 384, the ore, delivered by a feeder (not shown) at the left end, falls upon the No. 1 hearth, and by means of eight rabblers is handed along to the other end where it drops upon No. 6 hearth and escapes by a drop-hole into a car standing upon a track below. It will be seen that No. 3 hearth is muffled neither above nor below. The fumes from the three top-hearths go to the sulphuric plant, the fire-gases entering the muffled spaces between hearths 4 and 5 and between 5 and 6 are down-drafted to the chimney, while the muffle gases between 1 and 2 go direct to the stack. In this way the ore is soon heated to ignition, and later, on 5 and 6 is strongly heated to give a low sulphur product. It will be noticed that the muffle roofs are so low that the gases traveling over the hearth continually sweep along the escaping  $\text{SO}_2$  gas. On hearth No. 6 there is no muffle below so that the ore becomes cooler and in so doing heats the entering air.

## THE RIDGE FURNACE

Fig. 285 shows three sections—one a central longitudinal, one transverse, through *B, B*, and one as a plan at *B, B*, cutting through hearth No. 3. The upper, the drying and preheating hearth, is open to the air, and the roasting of the ore is done on hearths Nos. 1, 2, and 3, passing thence to the cooling hearth. Below hearth No. 3 are flues for fire-gases and for fresh air, which pass away by a separate flue. In this way hearth No. 3 is maintained at a high temperature, being a muffle hearth. After the furnace has been heated to a high temperature at starting, the blende is self-burning, air for the purpose being admitted by the proper side-ports as shown on the plan. The gas evolved from the burning, and containing  $6\frac{1}{2}$  to  $8\frac{1}{2}$  per cent  $\text{SO}_2$  (free from fire gases) passes by the round gas flues, and through a suction fan, to the sulphuric-acid plant. The direction of flow of this gas is contrary to the movement of the ore. There are four vertical hollow shafts carrying rabble arms furnished with rabblers or blades

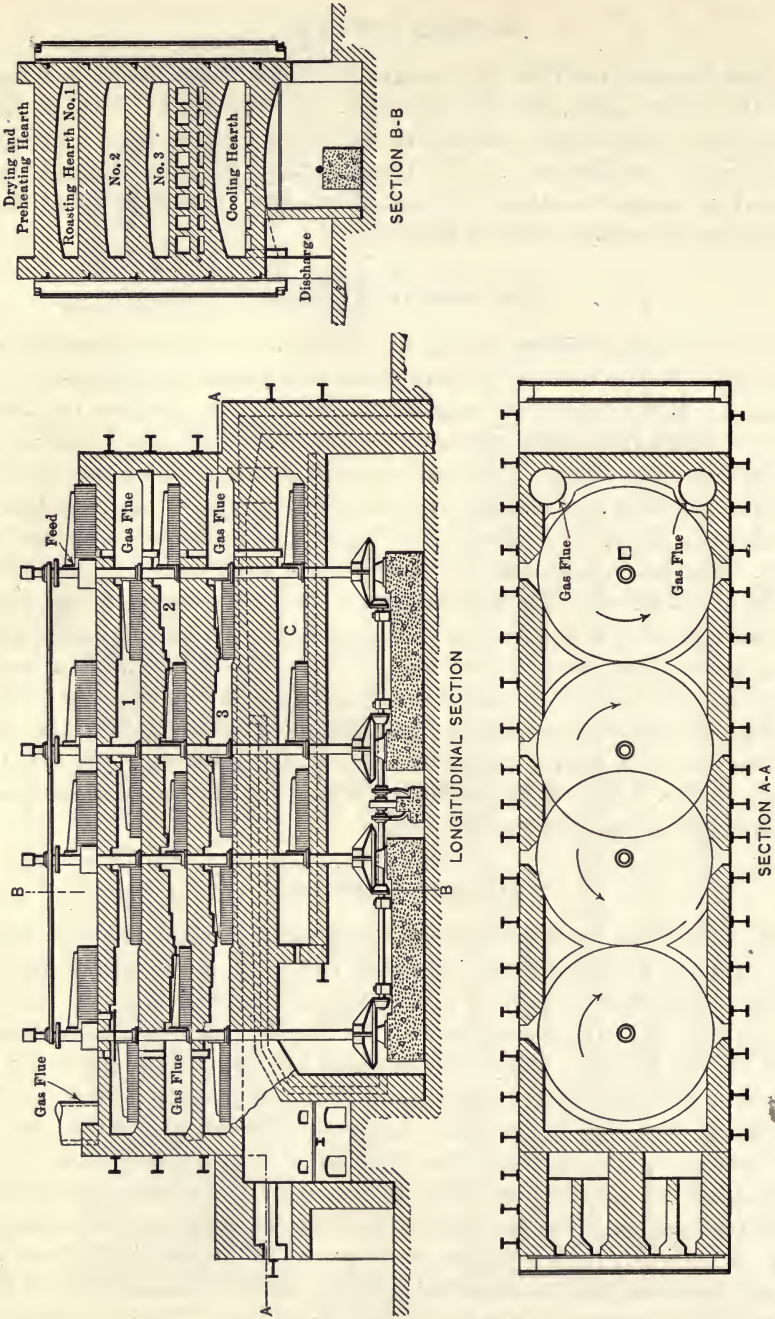

FIG. 285.—Ridge Blende-roasting Furnace.



set at an angle. The shafts being in motion, ore from the feed is swept along by the rabblers the length of the drying and preheating hearth. It falls through the open drop-hole at the firebox end of the furnace to roasting hearth No. 1, thence along the hearth to the drop-hole delivering to hearth No. 2 and so on to hearth No. 3 and to the cooling hearth. The discharge is at the side of the hearth and outside the brick wall which protects the gearing from dust and heat.

### SULPHURIC ACID

This is a by-product of zinc roasting. The sulphur dioxide fumes arising from blende roasting are increasingly used for the manufacture of sulphuric acid. This is done not only because of the profit arising from this manufacture, but because escape of these fumes into the atmosphere results in damage to health and to vegetation, so that such disposal of fumes has been restricted by legislation. Most blende is free from arsenic, and the fume arising from its roasting makes a superior acid as compared with that made from pyrites. Due to this freedom from arsenic the contact process for making acid is much in use in the United States, though the older chamber process is employed, especially for the Western blendes carrying iron and lead. One may note in connection that it has been found to be an advantage to roast the blende in one establishment near the zinc mines and the sulphuric acid market, and to smelt the roasted product at another works where fuel, clay, and skilled labor are best found. To roast blende to the best advantage the operation should be carried on in a multiple-hearth muffle-furnace where one can be sure of a regular supply of sulphur dioxide, free from the combustion gases, and of suitable grade. The objection to hand-roasting is production of an irregular gas due to uneven firing and stirring, whereas in the mechanical furnace such conditions do not exist. Again, in a muffle furnace the fuel gases are kept separate from the sulphur fume arising from the roasting ore, and these may be maintained at the grade of from  $6\frac{1}{2}$  to  $8\frac{1}{2}$  per cent sulphur as best suited for acid making. In 1920 the average price of  $60^\circ$  Baumé acid was \$14 to \$18 per ton.

## CHAPTER XLII

### SMELTING ZINC ORES

#### THE SMELTING OR DISTILLATION OF ROASTED ZINC ORES

The recovery of zinc from the ore consists in distillation of the roasted ore in refractory clay retorts after intimately mixing it with 40 to 60 per cent of its weight of fine coal. The whole is brought to a white heat, which is maintained during an entire day.

#### Reactions that Occur in Retorting Roasted Zinc Ore.

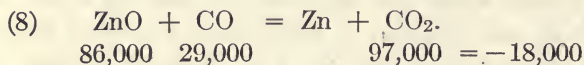
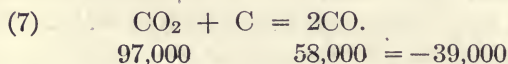
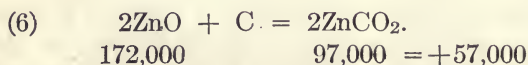
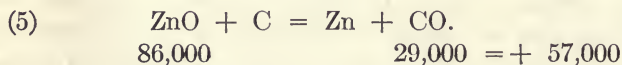

Before ore and coal are charged into the hot retort the mixture is moistened for convenience in charging, the water being promptly driven off by the heat. The light hydrocarbons of the coal come away next; then the iron oxide is reduced to protoxide and part of it to a porous iron or iron sponge. The final reaction (6) is the reduction of the zinc oxide of the ore by the carbon to metallic zinc. The reaction commences at 1060° C., but practically a temperature of 1300° C. is reached.

It is to be noted that the reduction point of zinc oxide is considerably above the boiling-point of zinc so that metal so reduced in the retort is immediately carried off with the other products of reduction into the cooler condenser. Should the temperature of this condenser rise higher than the boiling-point (*circa* 975° C.) the zinc will of course fail to condense, and should it fall below the melting-point (*circa* 418° C.) the metal will be condensed as powder, known generally as blue powder. This later characteristic is taken advantage of in the manufacture of zinc powder or blue

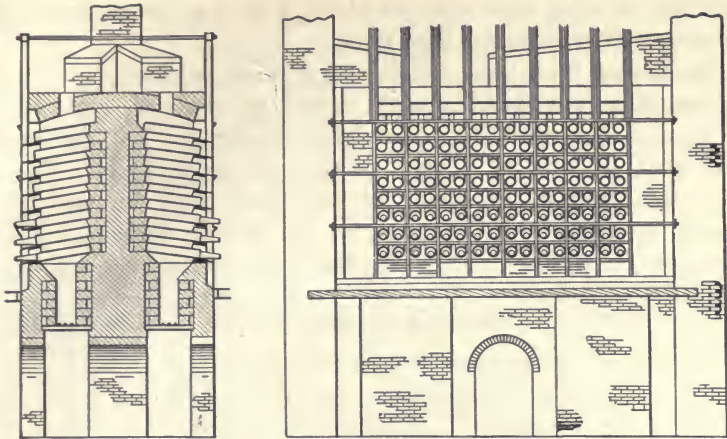

FIG. 286.—Zinc-smelting Furnace.

powder—now so much used in the reduction of gold from cyanide solutions—by using iron condensers maintained at a sufficiently low temperature. The condensers employed for spelter are truncated hollow cones of fireclay, which fit just inside the mouth of the retort. These are generally made

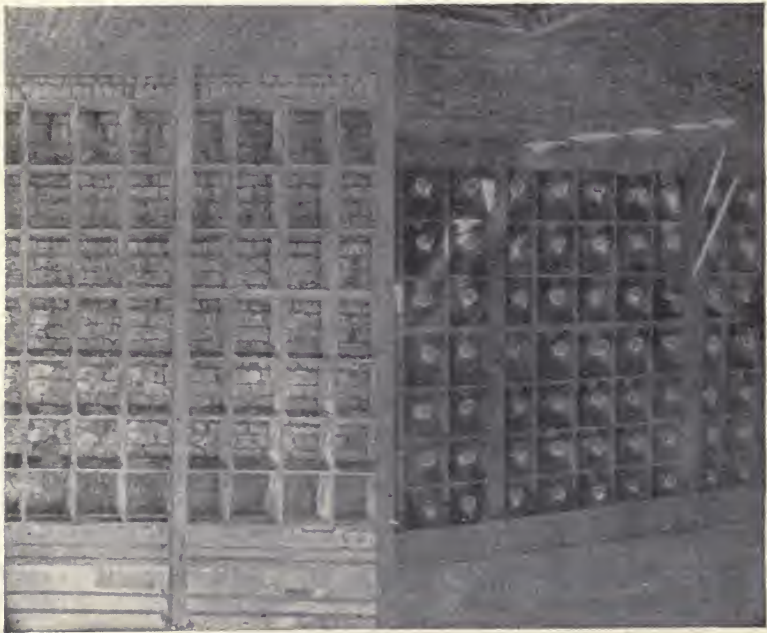

FIG. 287.—Old Furnace of Belgium Type.

about 18–24 in. long and taper to about 4 in. outside diameter at the smaller end, with walls about  $\frac{3}{4}$  in. thick.

In the United States the Belgian style retort is chiefly used. These retorts are plain cylindrical vessels, closed at one end, and are made 48 to 54 in. long, and 11 in. outside diameter. The thickness of the side walls is 1 to  $1\frac{1}{4}$  in. and of the end about  $1\frac{1}{2}$  in. The older style of zinc furnace designed for the direct use of coal as fuel, and known generally in this country as the Belgian furnace, is shown in

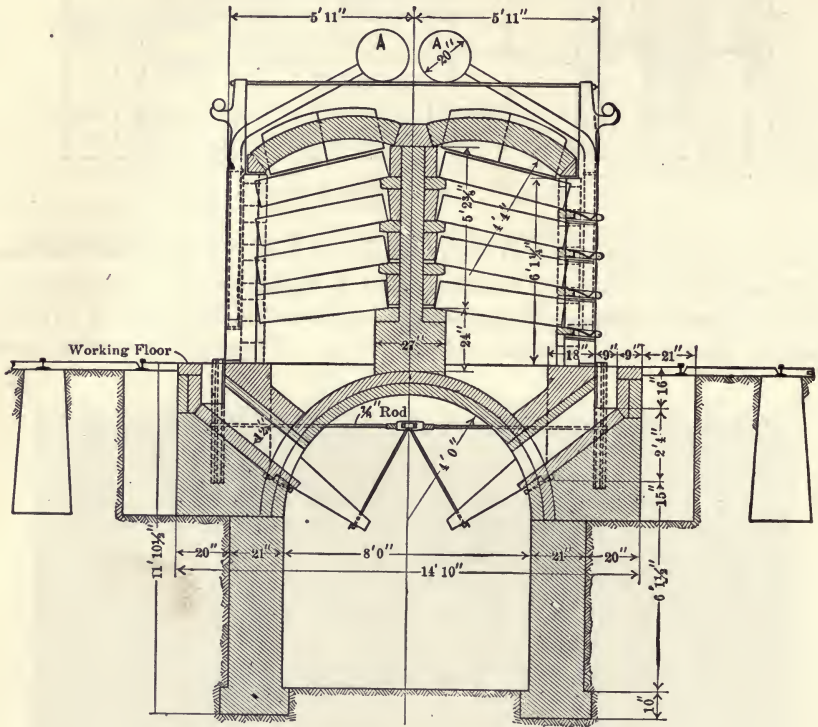

FIG. 288.—Section of Zinc-smelting Furnace (gas-fired).

cross-section in elevation in Fig. 286. Fig. 287 also shows two photographic views of this same type of furnace. On account of their high labor cost in operating these furnaces are rarely used to-day. Instead the larger and lower furnace shown in cross-section Fig. 288 and in front elevation Fig. 289 is more generally employed both for the use of natural gas and for producer gas as fuel. The furnaces are built with any number of retorts, generally 288 to 336 to a side where four retorts high. It is common where producer gas is used as fuel to build them five and even six rows high, in which case the furnaces are made 400 retorts and 432 retorts

to a side. Where producer gas is employed fuel producers are located on the end of the furnace, and all the gas is allowed to enter at that end. Air is supplied at intervals, by blowers or fans, through the pipes *A* shown on top of the furnace and distributed through the smaller pipes *B* to the front at each section. The gases pass out through stacks located at the end opposite to the producers.

Where natural gas is used for fuel, no producer is of course employed,

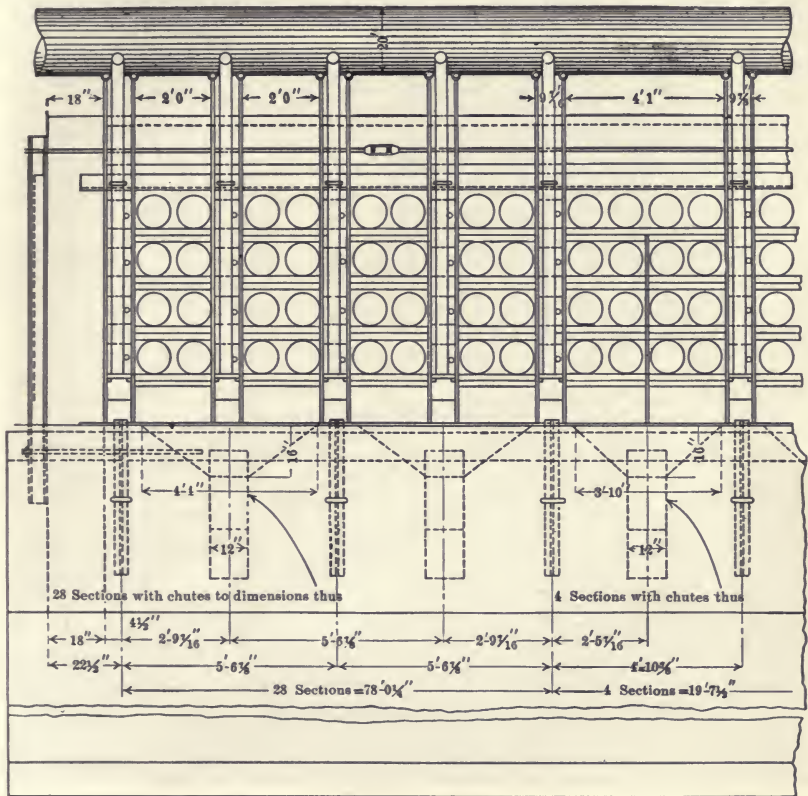

FIG. 289.—Front View of Smelting Furnace (gas-fired).

and that end of the furnace is closed up. The gas is admitted at intervals along the furnace with the air, and the products of combustion pass out the stack on one end of the furnace.

Both these styles of furnace are extremely wasteful of fuel, as the products of combustion leave the furnace at the full temperature of the last retorts. Sometimes waste heat steam boilers are located behind the furnaces in order to recover this extra heat in a useful form, but as the amount of power required around a zinc plant is comparatively small, only

a portion of the waste is so recovered. For that reason and because of the increasing cost of coal, regenerative furnaces are coming into increasing use. In these furnaces the waste heat of the outgoing gases is employed to heat brick checkers, which in turn give up this stored heat to the incoming air and gas. In that way a saving of fully 60 per cent of the coal consumed is made, although at the cost of increased labor to some extent.

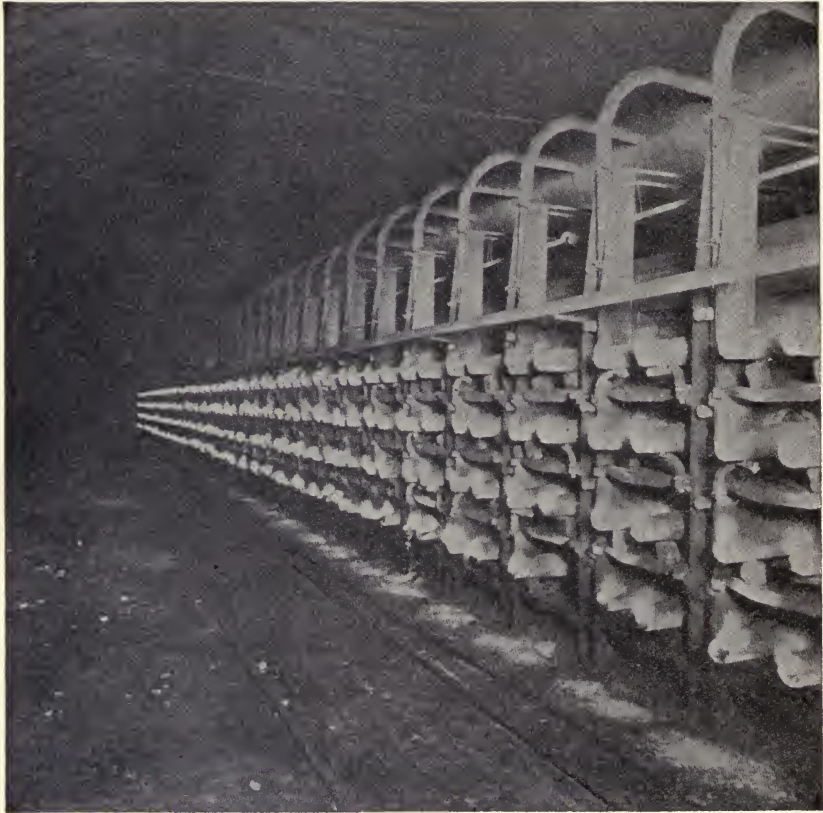

FIG. 290.—Smelting Furnace in Operation.

One of these regenerative or Siemens' type furnaces is shown in cross-section in Fig. 291, and Fig. 292 also gives in outline the general method of admission of gas and air through the regenerative chambers into the laboratory of the furnace, and their movement through the other chambers and flues to the stack. Periodical reversals of the gas and air take place at intervals of half to one hour by means of the valves shown, whereby the checkerwork-filled chambers are alternately heated, and again give up their heat to the incoming gases.

There are various designs of these furnaces, but nearly all work on the reversing principle as above outlined.

Fig. 293 shows in detail a zinc-retort in place in the furnace. It is

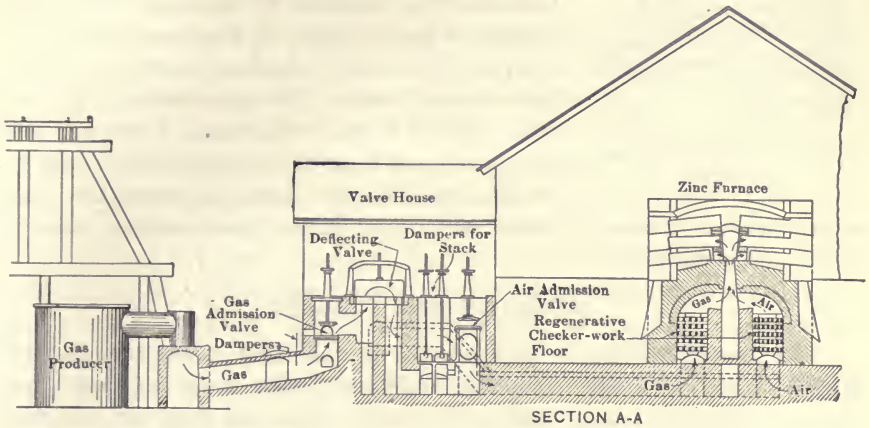

FIG. 291 — Cross-section of Zinc-smelting Plant.

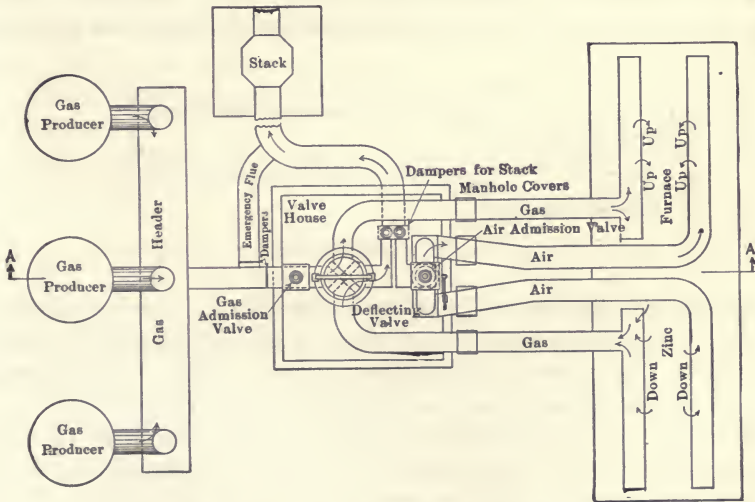

FIG. 292.—Plan of Zinc-smelting Plant.

made of fireclay, 4 ft. long by 8.5 in. diameter and with walls 1.25 in. thick. In the figure *a* is the retort, which rests on a ledge on the rear wall of the furnace and extends just through the thin ( $4\frac{1}{2}$ -in.) front wall. The wall is held by buck-staves *c* which carry the tiles upon which the retorts rest.

The whole is firmly bound together with tie-rods. When the retort has been charged, the clay condenser *b* is set in place, in which the zinc vapor issuing from the retort is to condense. As seen in the front view, the space between two buck-staves is divided by shelves which form "pigeon-holes," each of which contains two retorts. The retorts having been set in place, the opening around them is bricked up with pieces of brick and with clay. When a retort becomes cracked or otherwise useless, it can be readily removed by breaking away the temporary wall, and another retort can be set in the place without disturbing the adjacent retorts.

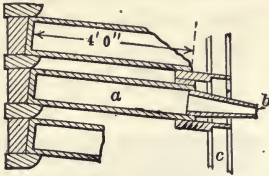

FIG. 293.—Zinc-smelting Retorts.

temporary wall, and another retort can be set in the place without disturbing the adjacent retorts.

#### OPERATING THE FURNACE

The roasted blende, or oxidized ore, or a mixture of the two, is thoroughly mixed with fine coal, and moistened with water so that when thrown into the retorts it will pack closely. The coal used for reduction is generally a low volatile, low sulphur coal, preferably anthracite. In the western field various coals are used for this purpose. Sometimes anthracite is used alone, sometimes what is known as "dead coal," a non-coking weathered coal found near the surface in Kansas; and sometimes



FIG. 294.—Charge-scoop.

crushed coke or coke braize is employed with either, or even a mixture of all three. The amount employed is generally between 40 and 60 per cent, dependent on the character and grade of the ore. This fuel is always used crushed not coarser than 1 in., but generally as fine as  $\frac{1}{2}$  in. at least.

The amount of ore charged per retort is usually about 60 lb. with a proper quantity of fuel. The amount of charge for a furnace is placed in one or more cars on the tracks shown in front of the furnace, Fig. 288 and Fig. 289, and is shoveled directly by means of the scoop, Fig. 294, into the retort. After filling the retort an iron rod  $\frac{1}{2}$ -in. thick is run along the top of the charge next the retort to provide for a vent for the moisture and gases of the charge.

As the retorts are filled the condensers are set in place resting on supports on the plates in front of the furnace. The condenser is then luted



or loamed around the joint with the retort by a finely ground and dampened mixture of coal and field loam; hence the term "loaming." The open end is loosely filled with a handful of a mixture of coal and charge or waste material, in such a way as to prevent the flowing out of the zinc, yet permit the escape of the reduction gases.

After the ore is charged the heat of the furnace is gradually raised so as to drive off, first the water added to moisten the charge, then the volatile matter of the coal, and the carbonic acid, if any in the ore. Finally after about two or three hours it is raised to the heat of reduction of the zinc.

The penetration of the heat from the outside of the retort, to the inside of the charge being progressive, of course these periods of the process necessarily overlap each other, so that before the center of the charge is fully dried out the gases are coming off that part of the charge in contact with the walls; and before these latter are completely expelled metallic zinc is being given off. This causes a dilution of the zinc vapor in the earlier stages so that then the condensation of the metal is incomplete, and much blue powder is formed as well as zinc vapor lost. From this period the temperature of the furnaces outside the retorts is maintained at not less than  $1200^{\circ}\text{C.}$ , increasing to  $1400^{\circ}\text{C.}$  towards the finish of the operation.

After the charge has been in the furnace for ten or twelve hours there is generally sufficient metal in the furnace for first metal draining. The metal drawer brings underneath the outlet of the condenser a cast-iron ladle swinging on a crane, and by means of a special tool breaks out the stuffing of material in the mouth of the condenser. Part of the metal runs out, and the balance, with more or less oxide, blue powder and portions of the charge which are carried out, is scraped into the ladle by the same tool. This tool is a cast-iron button about 2 in. diameter riveted on the end of  $\frac{5}{16}$ -in. iron handle. The metal is poured from the ladle into cast-iron molds. The resulting slabs are about 12 by 18 by  $1\frac{1}{2}$  in. and weigh about 60 lb. each. After the metal is drawn the condensers are closely stuffed as before, and the operation continues without interruption. At the end of about eight hours more the furnace is drawn, and again at the end of about four hours, when the operation is finished.

The condensers are then chiseled loose from the retorts and moved to one side. The loose unworked charge and oxide around the mouth of the retorts are scraped out, and the furnace plates and floor are thoroughly cleaned up. The cleanings, together with the oxides, skimmings, etc., made during the process are put aside to be charged again, and the furnace is ready for cleaning out.

The covers of the openings in front of the furnace are now removed, and the operatives scrape out the residues. These residues flow through the openings into the cellar below, where generally cars are ready to receive them. Sometimes other methods are used to remove the bulk of the res-

idues from the retorts, but scrapers, or bumpers, so called, have to be employed for a final cleaning. The castings and floor in front of the furnace are now swept clean of the spent residues, the covers of the cellar holes are replaced and the furnace is ready to recharge. The operation from this point is as described above.

After the furnace is cleaned out any broken or corroded retorts are readily discovered and are removed. This is done, and they are replaced by new retorts which have been brought up to red heat in a kiln for that purpose, and without being cooled down are pushed into place in the hot furnace. When the retorts are in place they are closed into the furnace by a fireclay partition which fits closely around the mouth and closes the opening to the furnace so as to retain the fire.

The heat of the furnace is allowed to fall slightly during the time of charging and changing broken retorts, but at no time during the campaign, which may last five to seven years, is the furnace allowed to cool off.

#### MANUFACTURE OF RETORTS AND CONDENSERS

Retorts to withstand the high temperature and corrosive action of the charge are made of the most compact and durable material. The material consists of a mixture of "chamotte," "grog," or "cement," of burned fireclay, firebrick, or tile free from slag. It is ground to about 6-mesh size and mixed with an approximately equal amount of raw fireclay. The mixing is done in a pug-mill, using water to form a stiff mud, which is allowed to stand some time covered with wet sacking to season and to develop the plasticity. It is again put through the pug-mill, and finally made into retorts in a hydraulic retort-making machine under the pressure of about 3000 lb. per square inch. A machine of this kind makes twenty retorts or more per hour.

The success of the retorting operation depends upon the durability of the retorts, and for this reason a careful selection of the clay is the first necessity. With one or two exceptions, all the zinc smelters in the United States use a fireclay found in large quantities in the Mississippi Valley, chiefly at or near St. Louis. It is probable that the good results obtained with retorts made from this clay are partly the result of a familiarity and knowledge of its qualities for the purpose, as the attempts made to use other clays of apparently superior physical and chemical properties, have for the most part resulted in failure. The analysis of this clay, generally known as "Cheltenham" clay, is about as follows, on an air-dried sample:

	Per Cent.
Al <sub>2</sub> O <sub>3</sub> .....	30-33
SiO <sub>2</sub> .....	50-45
Bases.....	4-5

and loss on ignition, including water and organic matter about 15 per cent.

**Condensers.**—Condensers are made of less refractory clay than retorts. They are not subjected to high temperature, but must withstand much handling and severe treatment. They last eight to twelve days, and cost 3 to 4 cents each.

**Drying the Retorts.**—The finished retorts as they are removed from the machine are placed in vaults or compartments holding 500–1000 retorts, according to size of works. These vaults are provided with steam coils beneath the floor, for heating and drying. In general the temperature of the vault is kept low during the first week or more, to allow slow evaporation of the added water, then is gradually raised during successive periods until the retort is thoroughly freed from moisture. The period of seasoning may hardly be less than four weeks, and may better be prolonged for at least twelve weeks. It is considered better that it should be a slow operation, but requirements in this respect differ with different clays.

**Annealing.**—After the retorts are thoroughly seasoned and dried they are available for use in the furnaces as required. Each day the number of retorts experience has shown to be required are placed in a small furnace or “temper-kiln” cold, and the heat gradually raised so that first the combined water is removed and later the heat of the kiln is brought up to full redness. About twenty-four hours is usually required for this purpose, and at the proper time, as required in the operation of the furnace, these retorts are taken while still red hot and placed in position in the smelting furnace.

#### LOSS IN THE PROCESS

The losses in smelting of zinc occur, as may be expected, in every process to which the ore is subjected.

In blende-roasting there is a mechanical loss from spilling of ore, and from flue dust, and a metallurgical loss of zinc in the form of fume due to the volatilization of zinc.

In smelting the roasted blende or carbonate silicate or oxide, there are again mechanical losses in spilling and dust, but the more serious losses are those of the metallurgical process itself. These may be summed up as: (1) Infiltration of zinc through the retort and absorption of zinc by the retort itself; (2) loss in fume from the condenser due to uncondensed zinc; (3) fume or zinc vapor remaining in the retort at the conclusion of the process; (4) zinc remaining in the residuum after removal from the retort.

In the roasting of blende the losses will amount to at least 1 per cent and will average 2. In the case of fine ore, dust losses may increase this proportionally.

In retorting roasted blende which averages 40 per cent zinc before roasting, the losses will average 16 per cent; where the zinc tenor is as

high as 50 per cent the loss will approximate 13 per cent and when 60 per cent material is handled the average loss will approximate 10 to 11 per cent. Based on the original unroasted material, the total of all losses will be approximately for 40 per cent material 18 per cent, 50 per cent will be 15 per cent, and 60 per cent about 12 to 13 per cent. Special conditions and special characteristics of ores will of course modify these figures.

In smelting carbonate and silicate ores, which average lower in zinc content, the per cent of loss will be less. These ores for the most part have zinc contents of 30 to 40 per cent and the zinc loss will be from 12 per cent for the better grades to  $17\frac{1}{2}$  or even 20 per cent for the poorer.

#### COST OF SMELTING

The cost of the smelting of blende of course varies much with different localities. The large natural gas fields found in the Kansas-Oklahoma territory enabled cheap operations to be carried on at points so situated with respect to the most important zinc deposits of the country that the freight charges on the ore to the works and on the metal to the point of consumption, were reduced to a minimum. The costs in that field, therefore, have been and are to-day exceedingly favorable, considering the character of the operation. Exclusive of gas cost these charges in 1912 are about as follows:

	Per Ton Blende.	
Unloading, crushing, drying, and sampling.....		\$0.35
Roasting, labor and repairs.....		0.50
Smelting.		
	Per Ton Roasted.	
Labor, direct.....		\$4.00
Reduction fuel.....		1.80
Retorts, condensers, etc.....		0.60
Repairs, maintenance, power, etc.....		0.75
Charging, etc.....		0.35
General labor.....		0.20
Superintendance, office expenses, etc.....		0.75
		\$8.45
Roasting loss 13 per cent..... =	1.10	7.35
Total, exclusive of gas.....		\$8.20

The cost of gas varies with the conditions surrounding the plant. In the early days of any gas field the cost is apparently very low, but increases rapidly with the exhaustion of neighboring fields. Probably a fair average cost of gas per ton of blende for both roasting and smelting would be \$2 to \$2.25 per ton. This added to the other costs makes the total cost average from \$10.25 to \$10.50 per ton for the whole operation.

In the coal fields the cost of fuel is higher, but owing to the location

generally chosen for these plants using coal for fuel, there is a good market for sulphuric acid at such points, and the manufacture of acid as a by-product reduces this cost to a point generally much below the cost at natural gas-using plants.

#### PRICE OF ZINC ORES AND SMELTERS IN 1919

Mississippi Valley ores are bought as at Joplin, Mo., at a quoted price, on a basis of 60 per cent zinc contents. As this varies up or down, \$1 per unit is added or subtracted from the base price. Calomine is bought on a 40 per cent basis. We may quote for a certain blende \$47, and for calamine \$30 per short ton.

**Western Zinc Ores.**—On a 40 per cent basis we may have, for example, \$20 per ton paid for a calamine ore or \$13.50 for a sulphide. A variation of \$1 per ton per unit is made up or down. Besides this 65 per cent of the zinc contents is added or subtracted as the market price of zinc rises or falls.

Iron over 2 per cent is penalized at \$1.50 a unit; arsenic or fluorine are not permitted. The gold and silver may be paid for at 65 per cent of their market value. The above figures are based on zinc at 8 cents per pound.

**Zinc.**—Quotations in the United States in 1919 are given in cents per pound, thus: 4.60 cents, St. Louis; 4.75 to 4.80 cents, New York. The London market is quoted at 9.15 shillings for good ordinaries (ordinary brands) and 20 shillings for specials (the purer zinc). St. Louis is near the zinc-producing district of Kansas, Missouri, and Illinois, and hence has a lower price for spelter than New York.

**The European Price of Zinc Ores.**—The value of a zinc ore depends upon its content in zinc and the absence of objectionable impurities, such as iron, manganese and lime, which form fusible slags, and increase the corrosion of the retorts, or of lead, cadmium, arsenic and antimony, which contaminate the spelter and so lower its market value.

For many years large quantities of zinc ores have been sent to Antwerp, Belgium, and to Swansea, Wales, from Sardinia, Algeria, and Spain, and of late from Colorado, via the Gulf ports of Galveston and New Orleans.

Based on ores of 46 per cent zinc and upward the price of the ore, with costs, insurance and freight paid, was the London price less 8 units and 95 per cent of the assay value, and less a returning or treatment-charge of perhaps £33 per ton.

## CHAPTER XLIII

### ZINC REFINING

Refining is for the purpose of converting low-grade spelter into grades suitable for high-grade brass. For such grades from 5 to 15 cents per pound over prime Western spelter was paid during the Great War.

#### GRADES OF ZINC

Electrolytic spelter of 99.9 to 99.95 per cent is the purest made. Aside from this the great bulk of spelter made by distillation, and called virgin spelter, has been divided into four grades, as follows:

Grade.	Pb, Per Cent.	Fe, Per Cent.	Cd, Per Cent.
A. High.....	0.07	0.03	0.05
B. Intermediate.....	0.20	0.03	0.50
C. Brass special.....	0.75	0.04	0.75
D. Prime Western.....	1.50	0.08	

In distillation lead is volatilized and carried over into the spelter. For the grade "brass special" the lead in the ore should be below 1 per cent. Iron makes less trouble, and may occur in ores up to 10 to 12 per cent. Cadmium is even more easily distilled than zinc and so first-draw zinc contains the most of it. It is not considered to be detrimental in small proportions.

**Redistilling.**—To prepare for this the ordinary ore-smelting furnace has its lower row of retorts removed and the butts of the upper rows are placed upon the shelves of the next lower row. This gives the retort an inclination of 8 to 10 in. in its length and permits it to hold a bath of molten spelter. Since in redistilling a lower temperature (950° C.) can be carried than in smelting, the flue checkers are opened and the combustion gas is burned under natural draft. There results a thin flame, a more uniform heat and better operating conditions. The condenser used may be an ordinary one, having a dam block in half the larger end; or again a hand-made cone condenser may be preferred. This smaller end, 7 in. diameter with a tile dam, is luted into the retort, while the larger end, 10 in. diameter

is closed with a fireclay plate with tap-hole openings, top and bottom. These openings are stuffed up during distillation. The low-grade spelter which is to be refined is cast into sticks 20 in. long by  $1\frac{1}{2}$  in. square. Four or five of these make a charge for one retort, these being charged immediately after each drawing. The sticks are inserted by the top opening. This is stuffed, and in five or ten minutes the sticks are melted and in process of distillation. Drawing is done every six hours. To do this the top opening is spied or pricked open, in order to relieve the internal gas pressure, the scratcher is inserted in the bottom hole and the contained metal and blue powder drawn into the ladle. The redistilled spelter is cast into plates and taken to a reverberatory equalizing furnace for recasting into plates of uniform high-grade spelter.

As the bath of metal in the retort becomes enriched in lead and iron it must be removed. This is done by omitting the charge for say, twenty-four hours on one section of nine retorts, and the next day taking down the condenser of this section and scraping out the metal called "bottoms," using a large scraper. In case of a leaky retort all is removed and the retort at once replaced. The leady bottoms drawn into a ladle are cast into plates and taken to a remelting furnace where any excess zinc is separated. The lead, tapped from this furnace and carrying 1 to 2 per cent zinc, is sold to lead refineries. The blue powder, skimmings, etc., from the redistilling, remelting and equalizing furnaces are returned to the ore furnaces for resmelting. All scrap metal is sent to the remelting furnace to be recast into sticks of recharging. Five men operate the two furnaces of the block.

To refine spelter, a furnace resembling that shown in Fig. 241 is used, but the reverberatory firebox is in two parts, and provision is made to charge the spelter close to the bridge. It holds 30 tons of spelter when full, and in it 10 tons can be refined in twenty-four hours. The metals separate into layers. At the bottom is the lead; the iron forms with the zinc and part of the lead, a difficultly fusible alloy that floats on the lead, and uppermost is the stratum of pure zinc. By means of an iron rod inserted into the bath, layers are distinguished, the zinc being soft, the iron-lead-zinc alloy (called "hard zinc") being mushy, and the molten lead at the bottom soft. The underlying lead is removed weekly. A cylinder or pipe closed at the lower end is sunk below the lead layer. The plug is then knocked out and the lead, rising in the cylinder, is ladled into molds. The zinc of the top layer is ladled out daily into molds, and it retains 1 to 1.25 per cent lead. The hard zinc layer is removed when opportunity offers. To do this the zinc is ladled out first, the lead is next removed, and finally the mushy mass of ferruginous metal is removed with ladles perforated so that the lead drains off. This hard zinc is sold for the manufacture of Delta or Sterro-metal.

### THE DE SAULLES REDISTILLATION METHOD

A furnace is used like one side of an ordinary furnace block. The retorts are inclined 7 in. in their length and extend 4 to 5 in. through the back wall. At the top of the protruding back is an opening for charging the retort with molten spelter. At the bottom is a small tap-hole for removal of the leady bottoms. Both openings are tightly closed with clay except when charging or tapping. There is an ordinary condenser properly clayed to the retort. Each retort-distilling furnace of, say, 200 retorts, is served by a 25-ton remelting furnace and a 25-ton equalizing furnace.

Low-grade spelter for redistillation consists of second or third-draw metal, and contains 1.5 to 3.0 per cent lead, 0.03 to 1.0 per cent iron and 0.03 to 0.07 cadmium. The redistilled spelter will average 0.10 per cent lead, 0.01 per cent iron and 0.04 per cent cadmium, a better grade than "intermediate," as given in the table.

### REFINING SPELTER WITHOUT REDISTILLATION

The principle of this method consists in remelting low-grade spelter in a reverberatory furnace with a reducing flame, and letting the molten bath stand until the metal separates into layers according to the specific gravity of the different metals, the lower part of the bath consisting of a leady zinc and the upper part of spelter nearly free from lead. The lower layer is then tapped, or removed otherwise. The separation or refining must be done at a temperature near the melting-point of zinc, since the higher the temperature the more persistently does the zinc retain lead. Under the most favorable circumstances the lead content of the spelter is reduced to 1 to 1.25 per cent.

### ELECTROLYTIC ZINC

Due to the demand for a pure metal for the making of cartridge brass during the great war, electrolytic zinc was held at a premium of 2 or 3 cents per pound over the then high price of other grades. This gave a great impetus to developing a successful electrolytic method for its manufacture.

The process consists briefly in roasting the ore, dissolving in dilute sulphuric acid, filtering the solution, precipitating the other bases by means of zinc-dust, filtering to obtain a solution containing zinc only, and precipitating this in metallic form by electrolysis.

**Roasting of Zinc Sulphide to Oxide and Sulphate.**—Zinc sulphate can be formed through any one of the following reactions:



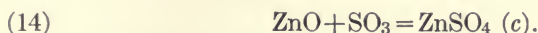
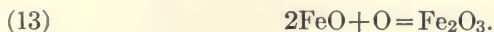
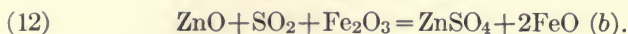
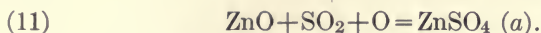
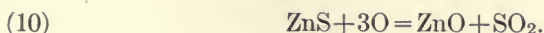

There is considerable evidence that the first reaction is responsible for most of the sulphate formed. The only gaseous reagent is oxygen and there are no gaseous reaction products, therefore, the oxygen concentration alone should mainly determine the amount of sulphate formed. Reactions (11) and (12) involve two gaseous reagents, so that the amount of sulphate formed will be determined mainly by the product of the concentrations of oxygen and sulphur dioxide.

The ore, of 30-mesh size, is a blende concentrate of 25 per cent sulphur. It is roasted in a Wedge roaster, being given a close oxidizing roast that brings it down to 2 per cent sulphur, yielding a product of zinc oxide and sulphate. This, after cooling, is stored in feed-bins, whence it is drawn off into agitating vats. Here it is treated for twenty-four hours with dilute sulphuric acid. The acid dissolves the zinc oxide and small amounts of copper and cadmium also present. The pulp is now passed over a classifier which removes the sand, the slime then going to an Oliver filter. Both the sand and the slime are stored and are sold at a profit to the smelter as containing silver and gold and a little lead.

There remains the clear solution, which is passed to another agitator. Here it is treated to a small addition of granulated zinc made in the melting house from zinc produced by electrolysis. After a prolonged treatment, in which the zinc dust precipitates all the other bases, the product is pumped through a closed Sweetland filter, where the zinc-dust and the bases are removed, leaving a clear solution containing zinc only. This solution is stored in vats and is drawn off as needed to the electrolytic tanks of the tank-house, arranged and operated precisely like the tank-house of copper refining. Each tank contains eighteen anodes and nineteen cathodes, the current being in parallel with a tank-resistance of 0.4 volt. The anodes are of lead, 21 by 36 in., while the cathodes are of aluminum 24 by 36 in.

When the zinc has been deposited to the depth of  $\frac{1}{8}$  in. on the cathodes these are removed from the tank, washed, and the zinc is stripped. This is melted in a reverberatory furnace, and melted into commercial plates,  $10 \times 16 \times 2$  in. A small portion of the molten metal is granulated, it being placed in a small reservoir whence it runs in a stream the size of a knitting needle so as to be caught by a horizontal air jet. This blows it to powder and it is caught within a sheet steel bin or chamber.



PART VIII  
PLANT, EQUIPMENT AND THEIR COSTS



## CHAPTER XLIV

### LOCATION, EQUIPMENT AND ERECTION

#### LOCATION OF WORKS

A mine has practical value only when permanence is reasonably assured. Then, a single unit of a mill may be erected where the process that has been chosen may be perfected; after that other units can be added.

**Mines Works.**—If a mining company builds a mill for the treatment of its own ore, it is usual, to save freight or hauling expense, to place the plant as close to the mine as the securing of a suitable site and water-supply permits. In case of a smelting works where flux and fuel is to be brought in and a heavy product shipped, then, in addition to a good site and water supply, nearness to a railroad is to be considered.

**Custom Works.**—This can judiciously buy ores from neighboring mines, but needs a site convenient to the chief source of supply and to the coke and fuel that it must use. For such a plant a point should be chosen where several railroads give rise to competition in freight rates and where labor is abundant. Low freight rates, abundant labor, and low money rates combine in locating a custom works.

**Iron and Steel Plants.**—Thus iron and steel manufacture has centered about Pittsburg, Pa., because coke, coal, and natural gas are abundant, and because a good market is found there for the products. On the other hand, the iron smelter at Pittsburg must pay for freight from mine to furnace, \$2.25 per ton, and must carry a large supply of ore to last through the winter months when navigation is closed. The United States Steel Corporation, the largest manufacturer of iron and steel in the world, has erected a plant near the iron ranges at Duluth, Minn., for reasons shown below.

**Effect of Water Carriage.**—Vessels carrying iron ore to Lake Erie ports can return with cargoes of coke or coal to supply the Duluth furnaces, which then have a local market for their pig-iron, and do not need to "stock up" with a winter's supply of fuel. Figuring roughly that  $2\frac{1}{2}$  tons coal, made into coke and into producer-gas, is required to make a ton of steel, there is a slight advantage, as to fuel, in making coke in by-product ovens at Duluth, Minn., and using gas-engines which utilize the blast-furnace gases to the best advantage. Nearly two tons of iron ore must be sent to Eastern furnaces to produce this one ton of steel.

**Zinc Works.**—It is seen from the cost of producing zinc, that 3.5 tons of coal are needed per ton of ore. Thus it is cheaper to convey ore to fuel, than coal to the mine where ore is produced. Near Joplin, Mo., there is ore and also fuel; we expect, therefore, to find the zinc-smelting works working there to the best advantage. The region is made more favorable by the fact that natural gas is to be had there.

**Silver-lead Works.**—With respect to silver-lead works using lead as a collector of other metals, the favored places have been found to be railroad centers, such as Denver, Pueblo, and Salt Lake. From 12 to 15 per cent coke is used in the charge in smelting, so that nearness to coal-fields is not the all-important condition. On the other hand, ores are available there in proportion favorable to combining profitably with one another. The lead of one ore and the iron of another, being combined, serve the requirements of smelting.

The silver-lead and copper custom smelters carry a supply to last from two to four weeks, but at a mines works provision is needed but for one to two days' running.

**Mills.**—In treating ore by milling and cyaniding, the amount of fuel and other supplies required is small, and hence the natural place for the work is near the mine that produces the ore, provided the extraction, or recovery of the precious metals, is high. When, however, the ore is refractory and the recovery is low, it pays to ship the ore to smelting works that guarantee a high extraction.

#### NATURE OF THE SITE TO BE CHOSEN

Both side-hill and flat sites are chosen. For the side-hill or terraced site, much used for mills, the ore is arranged to advance or flow by gravity from one operation to the next, using elevators less than on a level site. Since ore and mill or smelter products are so readily moved by cars and industrial locomotives which easily reach the higher levels of the works, certain objections, when material was man-handled, can be said to fall away. On the other hand the flat site has these advantages: (1) The first cost of the works is less, since heavy grading and retaining walls are not needed. (2) In the side-hill works the different parts of the plant must be placed in a definite and constrained order to obtain the needed fall, whereas on the flat site one can expand in any direction, that is, the parts that have to be far apart on the inclined site, can be placed close together on a flat one. A building on a flat site can be better ventilated than one crowded against the slope. On a flat site elevators are more numerous, but they are also convenient for delivering just where you want and at a low cost per ton.

Iron and steel plants, the largest in the world, are constructed on level ground. The ore is unloaded direct from vessels to the stock pile, using

grab-buckets holding 5 to 10 tons each. If transported in cars, the cars are loaded in a similar manner. The custom is to use hopper-bottom cars, from which the ore drops into the charging bins, and thence by charge-cars is conveyed to the furnace-skip. By the skip it is hoisted 100 ft. to the furnace-top. Many recent silver-lead smelting plants occupy level sites, but the dumping ground for slag is at a lower level.

For iron works little attention is paid to the location of the slag-dump. There is no hesitation in sending the slag, if necessary, a mile away by locomotive to be dumped.

On the other hand at copper and lead smelting works the designer likes to have at least two levels. At the largest copper reduction plant in the world, at Anaconda, the side-hill site has been chosen. Metallurgical mills are very commonly on steep side-hills.

**Mill-sites.**—On the unclaimed mineral lands of the Western United States, title is secured from the general Government for a mill-site for reduction works, five acres in extent, either in connection with a mining claim (on a theory that each lode claim is entitled to a mill-site) or as a site for an independent or custom reduction plant. A reduction company, operating a mill, must dispose of the tailing it produces, and of the water discharged, not encroaching upon the property of other people, and it is responsible for all damages. A company must not let tailing that, at a reasonable cost, can be impounded, flow into a stream, nor run into waters where liable to interfere with navigation. The right or custom of dumping on the valueless land of lower mining claims is general, except that the practice must do no damage to the property of owners below.

A reduction company can take up lands for a ditch or flume from unappropriated public land, and the claim cannot be interfered with by later locators; but the owner of such a ditch or flume is responsible for damage arising from breaks or overflows.

The same rule holds with respect to roads and trails. In Colorado, mining claims are subject to the right-of-way of parties hauling ore over them, but in other States the location gives exclusive control, except that a water, electric, or railroad company can take it under the law of eminent domain by giving a fair compensation for it.

**Damage from Smoke.**—The smoke from the smelting works, especially those treating sulphide ore in quantity, delivers into the atmosphere many tons of sulphur-fume daily, as well as fine flue-dust carried out of the stack by the draft. This diffuses through the atmosphere and is carried by the wind to trees and the crops of the land. If not diluted, it blights vegetation, and naturally the farmers organize to secure damages, or to close the works. The question of what to do to avoid the difficulties is a serious one, and to-day when pyrite smelting and extensive roasting of sulphide ores is carried on, the trouble can not be altogether overcome. Thus far

the solution has consisted in locating the works in places where there is little vegetation to be damaged, or in discharging the fume into the atmosphere from high stacks. It may be said that the latter expedient lessens but does not altogether obviate the difficulties. The metallurgist must therefore give serious consideration to the matter, otherwise, after erecting and starting the operation of a plant, he may find that he is compelled to close it, to the ruin of the entire enterprise. At the Washoe Works, Anaconda, Mont., the smoke from the furnaces is treated under the Cottrell system for the removal of all dust and fume, so removing this cause of complaint.

**Final Consideration.**—Preliminary to building a plant and operating a works, an investigation is made of the process, the requirements of the plant, and all limiting conditions. It includes, besides the general matters outlined above, the questions of supplies, markets, railroad facilities, freight rates, sufficient and suitable labor not liable to strikes, and reliable civil conditions unaffected by revolutions or oppression by the government under which the plant must operate.

Next comes the organization of the operating company and financing of the enterprise, or obtaining capital to build and operate the plant until it pays the operating costs.

Often the promoters, besides owning the mine for which the reduction works are built, have acquired the necessary real estate and the rights that go with it. Provisions should be made for access by railroads, for the necessary trackage, and for the common roads to the plant. Not only must water and power be provided, but right-of-way for securing them. If fluxes are needed, then the proper quarries or deposits must be found.

#### CONSTRUCTION OF PLANT

**Construction.**—Before beginning construction, plans should be fully worked out by competent engineers. Cost estimates are made in detail, good materials are accumulated, and the labor-force is properly organized. In the design of the plant, provision for duplicate parts is made, so that in case of breakdown no interruption of operation occurs.

On beginning construction, the hydraulic works, where needed, are put under skilled supervision. This includes the building of dams, reservoirs, the water-power plant, and the transmission line. For a long-distance power-transmission line there may have to be sub-stations and a distributing system.

Money must be provided for the salaries of officers of the company that are to receive pay during the period of construction, and all money expended must be accounted for, and cost-records kept by a skilled accountant. The money needed for legal expenses, general expense, traveling expense, and all expenses incurred during construction must be included.



## CHAPTER XLV

### ACCESSORY EQUIPMENT OF PLANTS

**Equipment.**—This includes the machinery, furnace-tools, and appliances used in operating, but excludes land, buildings, and trackage. Labor-saving machinery, when reliable, effects a saving in costs, but it is remembered that this saving must not sacrifice the efficiency of operation. The question “how much” often arises, and we may even come to the conclusion that it is not desirable (considering the cost of installation) to put in the labor-saving appliance.

#### INTERMITTENT HANDLING OF MATERIALS

For handling on one level, 100 tons or less of material daily, especially where the ore is to be distributed to various places, one or two-wheeled buggies, or barrows, Fig. 295, on a good floor, have been found to be economical, elastic, and low in first cost. For small quantities the metallurgist is not led into installing machinery, for he finds in practice that it effects no saving. For large quantities barrows or buggies may be used, or hand-propelled tram-cars, as in mining. For still larger quantities, power propelled cars are used, that can be handled also on up-grades and sent from level to level.

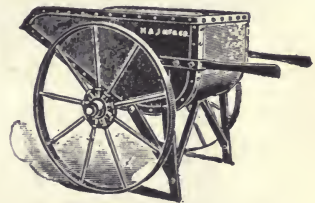

FIG. 295.—Charging Buggy.

The advantage of this method of handling is that loads can be sent over trestles, above bins, can be raised on elevators, and where they have suitable wheels, can be run over floors or even upon the ground.

#### INDUSTRIAL LOCOMOTIVES

These may be operated by steam, by electricity or by compressed air.

**The Steam Locomotive.**—Fig. 296 is a view of one of these suited to the handling of industrial cars.

**The Electric Locomotive.**—We show in Fig. 210 an electric trolley system, suited to the handling of slag and matte on the dump, and indeed for cars also. Fig. 298 is an electrically operated charge car, and one is

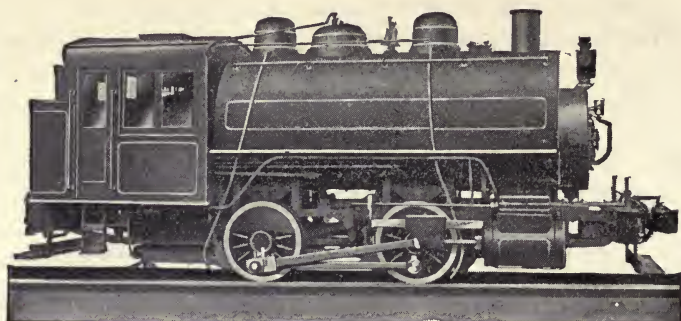

FIG. 296.—Steam Locomotive.



FIG. 297.—Gasoline Locomotive.



FIG. 298.—Electric Storage  
Battery Locomotive.

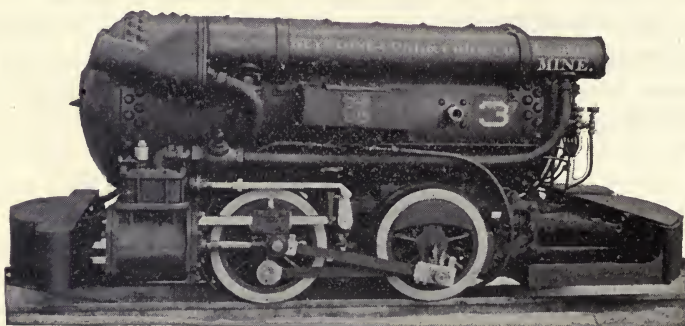

FIG. 299.—Compressed Air Locomotive.

used at the iron blast-furnace, Fig. 154, where it is in fact a moving weigh-scales, so that the items of the charge are weighed by it.

**The Gasoline Locomotive.**—These are made of sizes up to 20 tons and of any desired gauge. Fig. 297 is an example of one of them.

The electric storage battery locomotive, Fig. 298, is a view of such a locomotive. It should be observed that with it there is no need of a trolley line, and that the machine will traverse the entire yard trackage.

**Compressed-air Locomotives.**—Air compressed at 800 lb. per square inch is drawn off from an air-pipe line at a convenient point through a valve and hose into the air tank of the locomotive. The supply will run the machine for several short trips before it must be replenished. At the Washoe plant of the Anaconda Mining Company thousands of tons are thus handled daily, and indeed the plant is an admirable example of how a side-hill site becomes effective when locomotives are used. Fig. 299 shows one.

#### INDUSTRIAL CARS AND HOISTS

For the transport of material about the works a variety of cars are used as shown below.

**The Rocker-side Dump Car.**—The Fig. 300 is a view of one of these

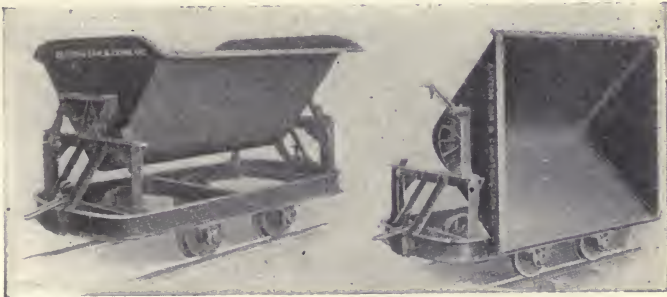

FIG. 300.—Side-dump Car.

locked ready for a load, also in dumping position. It delivers outside the track either to a dump or into an ore bin.

These may be provided with a brake, may be built with a scale for weighing the contents of the car, or may be power-driven, being provided with an electric motor. Some again have rubber-tired wheels for operation about the plant without the use of tracks.

**Hopper Cars.**—These (see Fig. 301) are used for transferring calcine from a roasting furnace to the hoppers of a reverberatory furnace or of coal to the coal hoppers. The bottom opening has a drop door for the discharge of its contents.

**Transfer Cars.**—This is useful for shifting a charging machine from one side to other of a furnace, or of a charging vat (see Fig. 302). The machine is loaded upon it from one line of track and the transfer car takes it over to the other and parallel track.

**Side-discharge Car.**—The rocker dump-car discharges to one side, the side discharge car Fig. 303, at both sides and beyond the track. It is

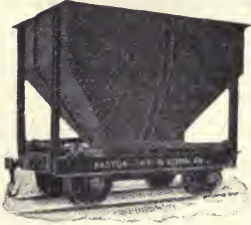

FIG. 301.—Hopper Car.



FIG. 302.—Transfer Car.

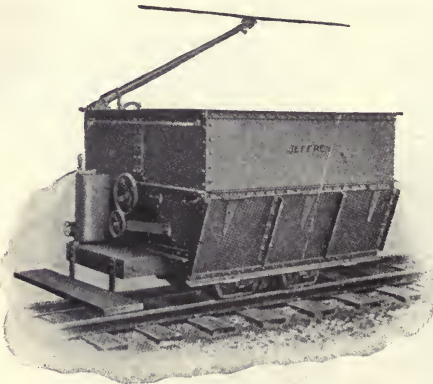

FIG. 303.—Side-discharge Car.

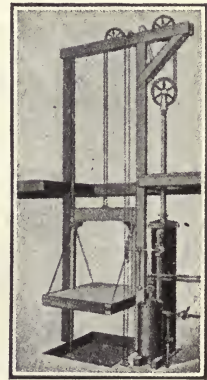

FIG. 304.—Double-gear Platform Hoist.

well suited for large loads emptying from an overhead track into bins below. The one here shown is motor driven.

**Hoists.**—Of these, the commonest about reduction works is the platform elevator, Fig. 304, which takes buggies, wheelbarrows, or tram-cars from floor to floor. It may have a platform of a size (6 by 6 ft.) to receive two cars or wheelbarrows at a time, and it raises a one-ton load 60 ft. per minute. They are often run in balance, but it is better to have two independent counterweighted platforms. Necessarily, time is lost in loading and unloading, so that the estimate of the capacity is 25 tons hourly.

**Skip Car** (Fig. 305).—This is used for hoisting material by a steep incline-track for charging to a furnace. One is shown as part of the equipment of an iron blast-furnace, Figs. 153 and 154. It has a bale for attachment of the hoisting rope.

The capacity of the skip is 2 to 5 tons of ore or half the quantity of coke, and the skips are run in balance. It takes thirty-four seconds actual time for raising, dumping, and returning the skip to pit; but the total time including the waits is four minutes, this furnishing the supply to a furnace producing 350 to 500 tons of pig iron daily from a total burden of 1150 to 1650 tons.

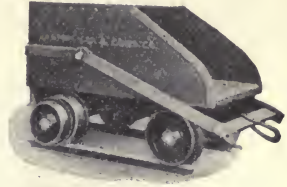

FIG. 305.—Skip Car.

### GRABS AND EXCAVATORS

**Grabs.**—In large establishments hoisting rigs are used that are provided with large clam-shell buckets or grabs. They take 5 to 10 tons of ore at a time, and are used for unloading vessels, and for transferring ore

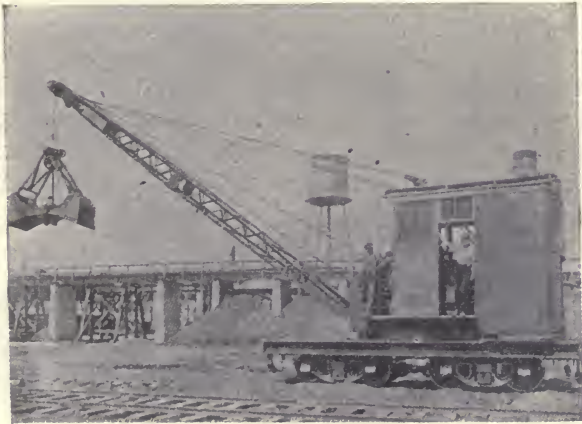

FIG. 306.—Track-crane and Grab-bucket.

to stock-piles for storage, or to the furnace storage-bins, as desired. It is noticed that the movable frames or bridges are made heavy to carry the large loads safely.

Telpherage refers to the transport by a monorail about a plant, and wherever such a rail can be run there material can be transported. We

give the details of a telfer for the transfer of matte pots from the furnaces to the yard.

**The Traveling Crane.**—Fig. 308 gives in elevation a traveling crane as commonly used. It is for handling ladles and converts as described

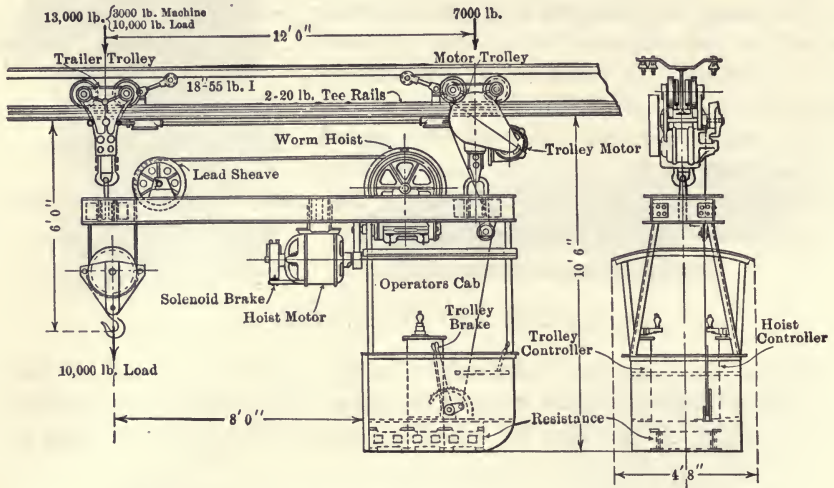

FIG. 307.—Telfer.

under copper-converting and for Bessemer and open-hearth practice. For handling materials inside a building it is coming into general use. It is operated by electricity, and moves in any direction, horizontally or vertically, over the floor of the building commanded by it,

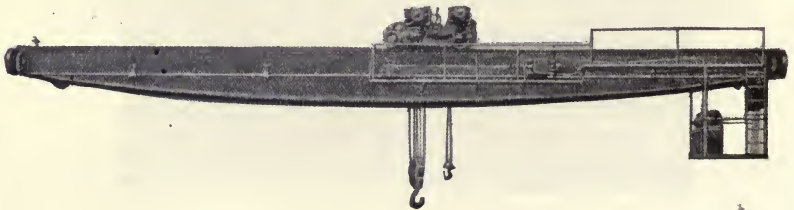

FIG. 308.—Traveling Crane.

and it avoids obstacles on the floor. Provided with large mushroom-shaped electro-magnets, it is now used to unload pig iron or handle steel sheets weighing a ton or more, and by using magnets no time is lost as in older methods in passing chains around objects to be lifted.

## CONTINUOUS HANDLING OF MATERIALS

Machines of this kind carry a distributed load, so that the sub-structure upon which they rest is light compared with one upon which the load is concentrated as in a car. They deliver material continuously, and no time

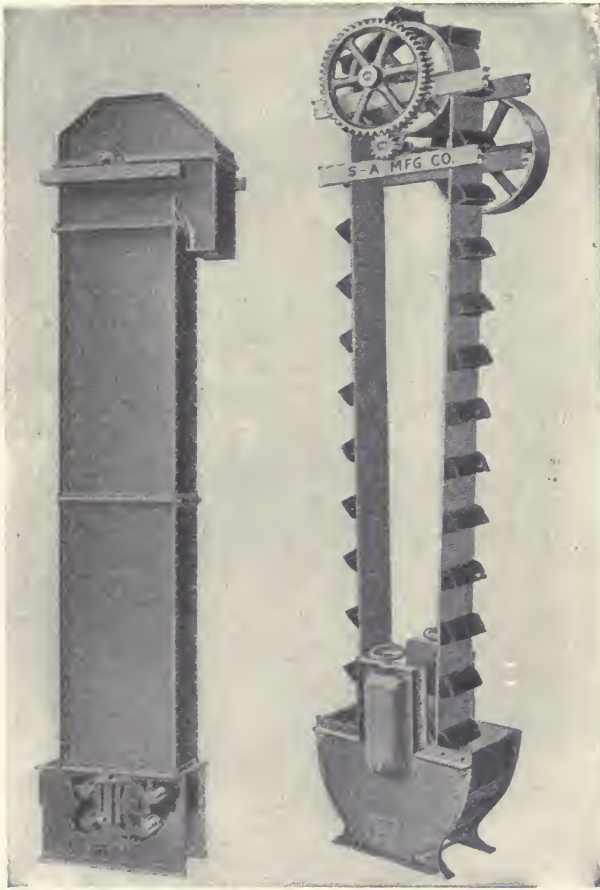

FIG. 309.—Belt-elevators.

is lost in loading and unloading. Intermittent conveying, on the contrary, if we increase the load of the skip or bucket, becomes slow and awkward, whereas in the continuous conveyor it is possible to increase the capacity by widening the conveyor and providing the correspondingly increased feed.

We divide continuous machines into elevators, conveyors, and conveyor-elevators.

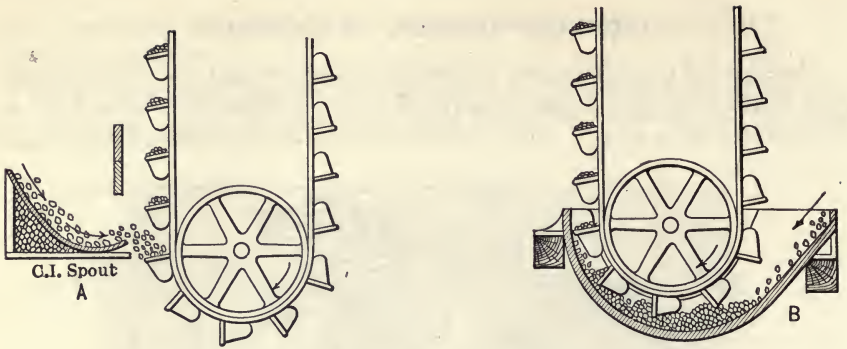

FIG. 310.—Methods of Feeding Elevators.

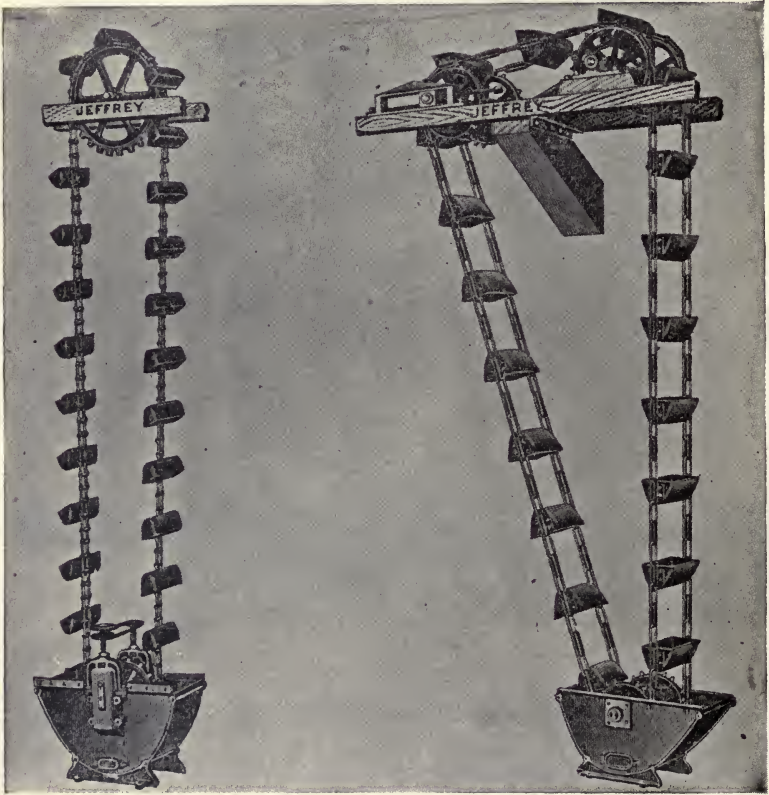

FIG. 311.—Single-strand End-less-chain Elevator.

FIG. 312.—Double-strand End-less-chain Elevator.



**Elevators** are used for vertical or nearly vertical lifting. The belt elevator, Fig. 309, is of this type, and consists of an endless belt having sheet-steel buckets, attached by flat-headed elevator-bolts at 18-in. intervals. To allow for the stretching of the belt, the lower pulley shaft is car-

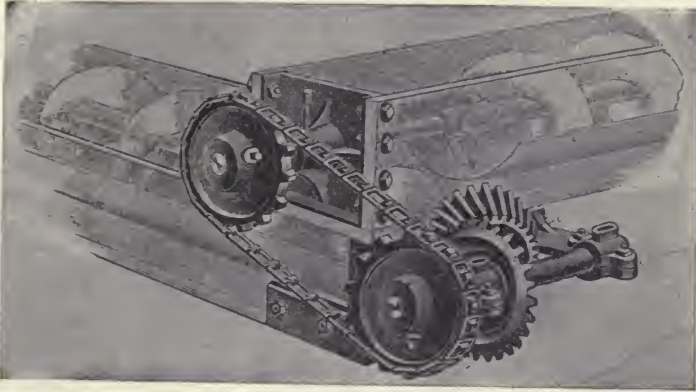

FIG. 313.—Screw-conveyor (quarter turn).



FIG. 314.—Discharge at Head of Conveyor.

ried in take-up boxes, by which the shaft can be raised or lowered. The lower pulley is enclosed in a boot, the ore delivering into the buckets at the rising side at the left. Ore not caught by the buckets falls into the boot and is there scooped out by buckets, and is delivered to the discharge spout by centrifugal action as the buckets pass over the top pulley.

Fig. 311 represents a single-strand endless-chain elevator. The

chain is carried by head and foot sprocket-wheels with sprockets spaced to take links of the chain. In this case the "take-up" of the single-strand elevator is carried at the boot; for the double-strand one it is at the movable upper shaft in the left. The ore spills into a chute between the two upper



FIG. 315.—Movable Tripper Discharging.

pulleys, and in this way the elevator can run at the low velocity suited to the type.

**The Worm or Screw-conveyor.**—This is convenient for delivering crushed ore or pulverized coal short distances, and it thoroughly mixes the ore conveyed. Fig. 313 represents a screw-conveyor delivering ore from the trough along which it has been conveyed, into another at right angles. The ore drops from the first to the second, and is conveyed by the screw

in the second, shown at the left. The bottom of the trough is lined with smooth sheet-steel bent to conform to the worm or screw. A screw-conveyor is shown in Fig. 268. The disadvantages of this type of conveyor are, that much power is needed, and that the ore grinds on the conveyor, resulting in wear.

**Belt-conveyors** are used for the horizontal transfer of materials, and can be modified easily to carry up an incline. Of all conveyors, the belt-conveyor is most widely used. To give it capacity, it is troughed by running on pulleys that raise the edges of the belt forming a shallow trough (see Fig. 315. The simplest form is an endless belt running over end-pulleys, the load being fed at one end, delivering into a chute or into a bin at the other. The conveyor carries a load not only on a level, but on as steep as  $24^\circ$  incline. The capacity is large and the conveyors are simple and durable. A 12-in. belt, traveling at the rate of 150 to 350 ft. per minute, delivers 10 to 35 tons per hour. A 24-in. belt, traveling at the extreme

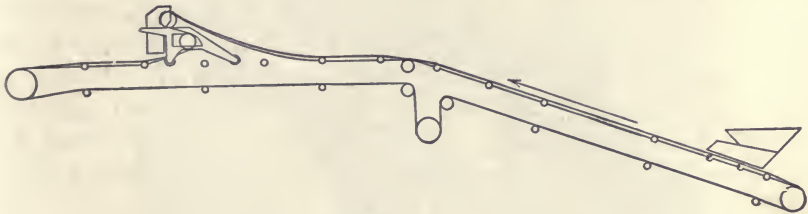

FIG. 316.—Incline to Level with Movable Tripper.

velocity of 600 ft. per minute, has a capacity of 250 tons per hour of crushed ore, and requires 6 H.P. per 100-ft. length, the power needed varying with the length of the belt. When the ore ascends an incline we add the power for lifting the load. Fig. 314 shows a belt in action delivering its load over the head pulley into an ore bin.

**The Movable Tripper.**—It is desired at times to deliver the ore into bins situated at different points along the belt. This is accomplished by using the movable tripper shown in Fig. 315, which also shows the belt loaded with ore. To discharge the ore the belt goes around the upper pulley, as shown, then around a second one just below, and continues the course to the front end-pulley. The ore shoots from the belt into spouts, that deliver on either side of the track upon which the tripper moves into one of the bins below. The tripper can be moved on its track and set to deliver to any desired bin.

At Fig. 316 we show a typical installation, in which a feed hopper at the right delivers to an inclined belt that changes to a level one, the horizontal part having the movable tripper. Beneath the belt is an idler pulley by whose vertical movement the slack of the belt is taken up.

**Endless-chain Conveyors.**—These are much used, since they convey ore not only on a level, but vertically if necessary. Being entirely of metal, they successfully convey hot materials.

Fig. 317 represents an endless-chain conveyor, consisting of a series of plates or "flights," attached to a double endless-chain carried at each end by sprocket-wheels like the double endless-chain elevator, Fig. 312. The ore, drawn from any desired storage-bin as shown in the figure, is pushed up an incline by the moving flights in a fixed steel-lined trough, and is taken by a double-strand endless-chain elevator to a floor above. If desired, slides may be provided in the bottom of the trough. When the slide is opened, the ore drops into the desired bin beneath.

Sometimes, in place of flights, a continuous series of buckets or trays is

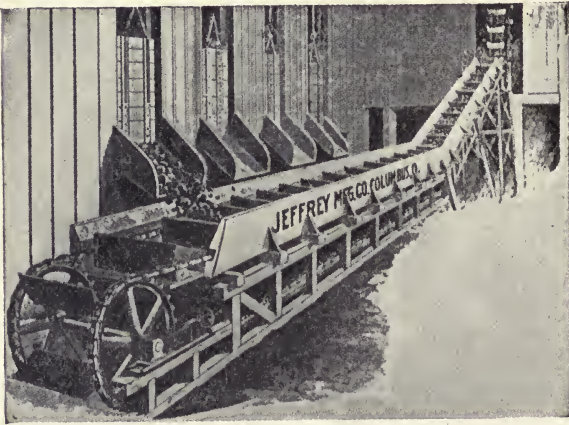

FIG. 317.—Endless-chain Conveyor.

used. These overlap so that the ore cannot drop between them. They operate upon the principle of the Heyl and Pattison pig-casting machine, Fig. 162. Indeed, chain conveyors lend themselves to a great variety of applications, as the examination of a catalogue of elevating and conveying apparatus will show. The chief drawback to them is that they have numerous joints to wear, and that the troughs, flights, or buckets are subjected to serious wear. They must run slower than the belt-conveyor.

In Fig. 74 (elevation) the Edwards roasting-furnace, we have an example of a swinging push-conveyor. The flights are bladed and so hinged from the vibrating carrying-beam as to swing over the ore in the conveying trough on the backward motion, but to push the ore along when moving forward. As is seen, the bottom of the trough is provided with slides to deliver the ore where it is needed.

## CHAPTER XLVI

### ORE STORAGE AND SUPPLY

#### PROVISION FOR SUPPLY

Ore may be stored upon the ground or a floor, sometimes fenced in to form a ground bin. Often for convenience in discharging into a car or conveyor a bin may be set high enough to discharge into a car or upon a conveying belt. Bins may be large enough to give a day's supply or less, and are then called "feed bins"; or there may be a row or series of them for the storage of various materials needed in the milling or smelting operations, and enough for a number of days. At the large iron works, receiving ore from the lower Lake ports, it is necessary to carry a winter's supply piled upon the ground. Such supply for the furnace is picked up by grabs and transferred to feed-bins. At the custom copper and silver-lead smelting works of the Western United States a supply is intended to last from two to six weeks and this locks up much capital while the ore is in process of treatment. Even at smelting plants, treating their own ores, it pays to use from large ore beds which have been so stored as to be quite regular in composition. Mills aim to have in their feed-bins enough to carry them on overnight, the coarse crushing being done on the day shift only, or in case of a breakdown, at the supply end.

**Ore Bins or Pockets.**—These may be flat-bottomed or inclined-bottom bins and may be made of wood or of steel. When they are flat the discharge point is at the bottom and side of the bins, then when discharged about half of the contents, forming a natural slope, remains. When the bottom slopes three ways to the side chute most of the ore runs out. This kind of bin is shown in Figs. 15A, 40, 45 and 98. Sometimes the bottom slopes four ways, forming an inverted pyramid. Then, the slopes being steeper, the discharge is better. At times the bin may be of steel, tall cylinders on end with a side-opening at the bottom, and the ore forming its natural slope.

#### FEEDERS

**Feeders.**—There are feeders of many types calculated to give a speedy delivery as into cars or upon a conveyor; or a regular or even supply to a furnace, to a crushing machine or to a vat: They include:

**Ore Bin Gates.**—The chute of this gate, Fig. 318, is a continuation of the sloping bottom of the bin. In operation the attendant opens the gate according to the supply he needs, whether to quickly fill a car or to supply a crusher. He must watch for a sudden rush of ore, or, when this hangs up, he uses a bar to loosen the ore and to make it run. Often there are men stationed above who poke down the ore in case the bin is to be completely emptied.

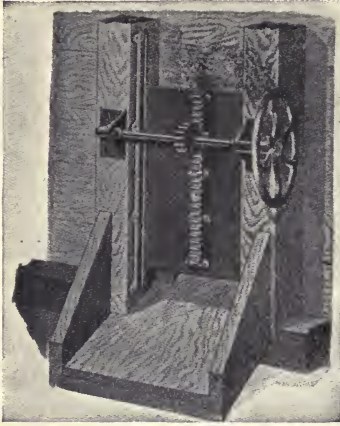

FIG. 318.—Single Rack Gate.

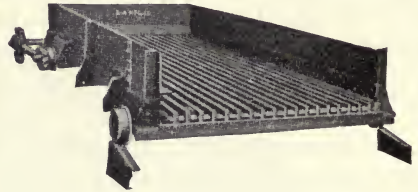

FIG. 319.—Combination Shaking-screen and Feeder.

Fig. 134, at *a*, is shown a grizzly, Fig. 54, to remove the fines while the lump ore is crushed. A better separation and a regular feed is obtained by substituting for this the eccentric driven screen feeder, Fig. 319.

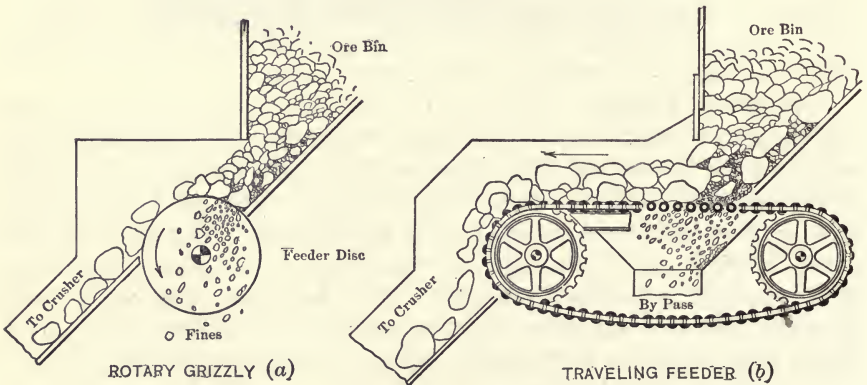

FIG. 320.—Moving Feeders.

**Rotary Feeder.**—In Fig. 320 (*a*) is shown a side elevation of a feeder disk in which as in the shaking screen there is a separation into fine and coarse, the latter passing on to the coarse crusher, while the

fine drops between the slowly revolving disks. It uses a minimum of space horizontally.

**Traveling Apron Feeder.**—This, as shown in Fig. 320 (b), takes a mixed feed whose amount is regulated by a slide at the front of the bin-opening. It effects the same separation of the ore according to fineness. The fine ore is caught in a by-pass chute, which carries it to clear the lower chain. Often a tight apron-feeder is used, delivering all to a car, a conveyor, or to a crusher. Where the ore is fine, or wet or sticky, or contains large lumps, making it liable to bridge or hang up, then steeper slopes than the usual  $45^\circ$  to one side of the bin are preferred. Thus a bin of wood may have an inverted pyramid bottom, or in a steel bin a hopper of inverted conical form. This brings its discharge at a middle point of the ore column, and so gives a surer run of the ore. To take this discharge the feeder is well adapted. The bottom opening can be lengthened out

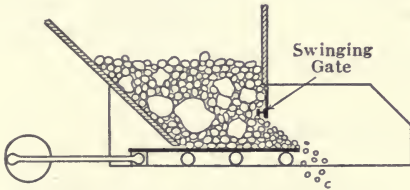

FIG. 321.—Reciprocating Plate-feeder.

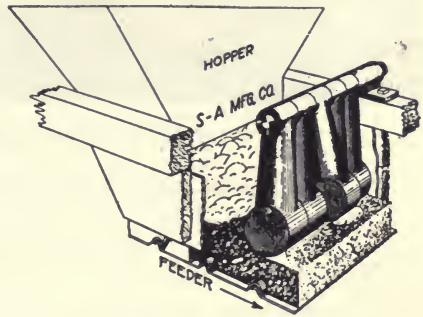

FIG. 322.—Hammer Feeder.

liberally above the apron. It is also well suited to coarsely crushed ore, especially for tall, narrow feed-hoppers that need a well-assured feed. Such hoppers used as roasters and receiving a wet sticky concentrate such as is produced in flotation, are especially liable to hang up. We may note that this type of feeder cuts down head room to a minimum.

**Reciprocating Plate Feeder.**—This is given in Fig. 321. It receives a quick reciprocating motion from an eccentric and delivers through a wide front opening, the flow being regulated by swing hammers, Fig. 322, set to allow the passage of any large lump then to fall back in place again. Thus large lumps cannot jam the opening.

**Removal of Waste Wood and Tramp-iron from the Feed.**—In mining the ore chips, wedges, and wood fragments, as well as nails, chains, nuts, and bolts, called tramp iron, are to be found in the ore and provision must be made to eliminate these objects as speedily as possible, especially the iron, which, if large enough, may stall or break the crushing machines that follow.

In sampling ore the attendant, as already stated, regulates the flow of ore from the feed bins. At the same time he removes the waste wood and tramp iron. The former is less dangerous to the coarse crushing machines, so that but  $\frac{1}{3}$  or  $\frac{1}{10}$  of the whole is passed on for finer crushing.

Fig. 323 shows how the iron is removed. The ore is carried from the feed bins by conveying belt to deliver to the feed hopper of the crushing machine. The head pulley of the conveyor is magnetized and attracting the iron removes it from the ore stream to drop from it as the belt conveys it from the mag-

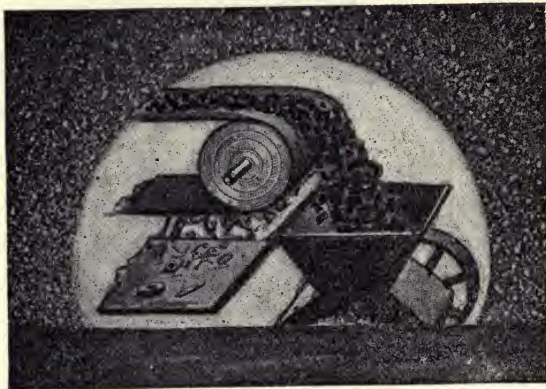

FIG. 323.—Ding's Magnetized Pulley.

netic field. The wood that passes through the machines is ground small and at the first settling box floats on the water to be removed by hand from time to time.

#### PUMPS AND ELEVATORS

For conveying concentrate containing from 6 to 10 per cent moisture, belt and push conveyors are used, while for elevating purposes belt-bucket elevators are common. Elevators are a source of trouble, and if possible should be avoided.

A variety of different pumps is on the market for elevating pulp, but those that are really good are few. Machines used for this purpose are the Frenier spiral, centrifugal, three-throw plunger, air-lift, bucket-elevator, and tailing-wheel.

The Frenier is satisfactory for low lifts up to 8 to 10 ft.

A three-throw plunger pump will give trouble with sandy material. The valves cut out quickly and the packing requires renewing often. Air-lifts are simple, but require large quantities of air for ordinary lifts of 8 to 10 ft.

The old tailing-wheel gives the least trouble of all. It is reliable and the cost of repairs is low. The one objection against it is the high first cost to install.

For moving sand a well-designed centrifugal pump with white cast-iron liners, easily accessible for replacing worn-out parts, will give good satisfaction; the Byron-Jackson pump is an example.



For the movement of sand and slime pulps, water and solutions, both low- and high-pressure pumps are used. For pressure filters and high lifts the three-throw plunger pump is much employed and the centrifugal pump for large volume.

**The Centrifugal Pump.**—Fig. 325 is a view of this type of pump, taking

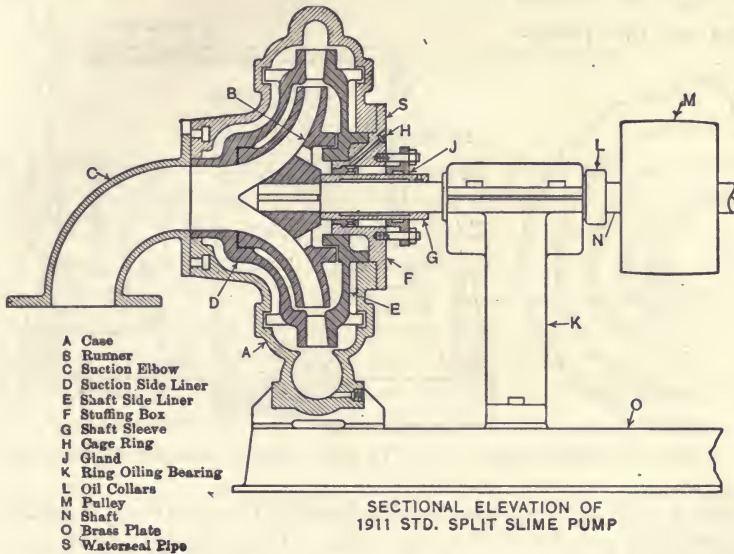

FIG. 324.—Centrifugal Pump. (Section.)

its suction at the front and delivering to the down-turned discharge pipe at the right end. Having no valves it works well for pumping sand or slime pumps. Fig. 324 shows its internal construction. The rapidly revolving impeller throws the water to the exterior of the casing, forcing it out of the casing, when it escapes to the down-turned discharge exit.

**Solution Pumps.**—Centrifugal, three-throw plunger, and air-lift pumps are in common use for elevating solutions.

Centrifugals are probably used more than any other for elevating to heights of 10 and up to 50 ft. They require considerable attention owing to their high speed.

A three-throw plunger will pump solution to a height of 100 ft. or more. They require little attention, and are economical in every way. I prefer them to centrifugal pumps.

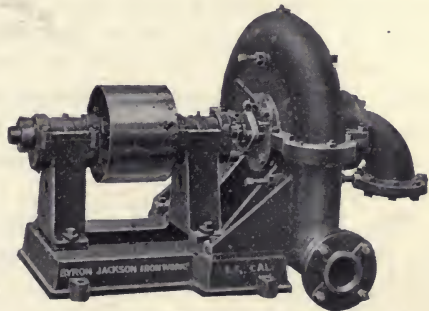

FIG. 325.—Jackson Centrifugal Pump.

The air-lift is suitable for lifts not exceeding 10 ft., and is particularly useful about a plant using the counter-current decantation process where the lift would not exceed 2 to 3½ ft.

**The Frenier No. 1 Sand Pump.**—Fig. 326 shows a section of the pump.

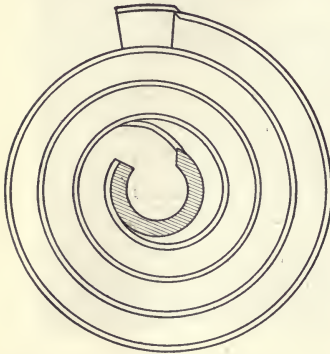

FIG. 326.—Section of Frenier Pump.

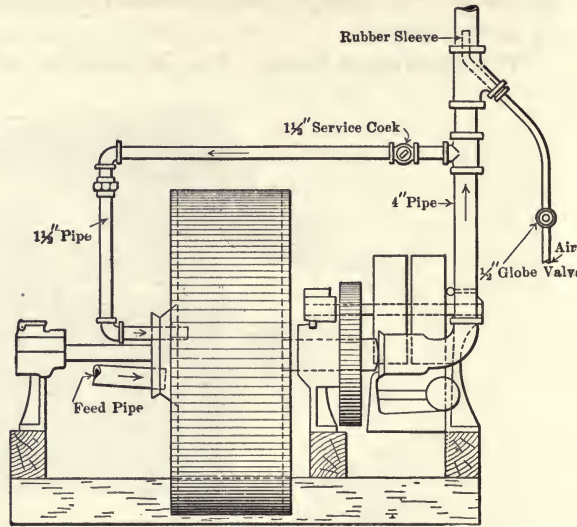

FIG. 327.—Frenier Pump Arrangement.

The trunk or body of the pump, 44 in. diameter, mounted on a horizontal shaft, constitutes a spiral rectangular tube. There are no valves, but the sand and water scooped up at each revolution of the spiral and by the hydrostatic head created by the revolution flows to the center of the pump, and discharges under pressure up the discharge pipe at the right. The spiral passage with an opening 2½ by 6 in. and at 20 R.P.M. will lift 3000 gal. per hour to the height of 14 ft. Due to its simplicity and ease of repair this pump is much liked. Where it is desired to increase the height of delivery this may be done by introducing an air jet into the discharge pipe as shown in Fig. 327.

**The Three-throw Plunger Pump.**—

The plunger acts on the down stroke only to press out the pulp or the solution, and the grit cannot get past it to cut the cylinder. Having three cylinders there are three even impulses per revolution. An air chamber at the discharge side as seen in the figure also tends to equalize the flow, Fig. 328.

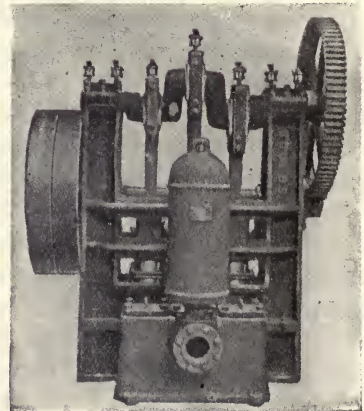

FIG. 328.—Triplex High-pressure Pump.

## CHAPTER XLVII

### COST OF PLANT AND EQUIPMENT

#### COST OF PLANT

Based upon figures of 1913 to 1915, when prices were comparatively stable, we give data that may serve to indicate the costs of metallurgical plants. We may safely calculate, however, that the costs in 1920 will be double these, but that, when the present abnormal labor costs again return to the older figures, then plant costs will be correspondingly decreased.\*

In earlier times, when not so much was done automatically, when wood instead of steel buildings prevailed, and where bedding was done on floors instead of in overhead bins, the cost would have been half that just given. There are drawbacks to much permanent construction in which, where changes are to be made (and this is often what should be done), such changes are expensive as compared with those in lighter construction.

The first step in such construction is to obtain the services of a competent constructing engineer experienced in the planning and building of the kind of works contemplated. Such service is particularly valuable in the avoiding of expensive alterations, and may amount to 3 to 5 per cent of the total costs. It is so much easier to make changes in the plans than to later correct them in the works themselves. The desire "to make the dirt fly" should be overcome.

Having matured the plans in detail and made estimates of costs, based upon the unit costs as below given, one can obtain bids from manufacturers of machinery and dealers in supplies and is then in position to proceed with actual construction.

To this end unloading facilities should be provided, a good road and if possible the railroad tracks brought to the site of the works. Ample room should be provided for lumber and for piling it so as to show just where it is to go. Also suitable storerooms and workshops for the use of the mechanics are to be built. Roomy framing plots and handy places

\* It was thought that, as after the Civil War of 1861 to 1865, prices would go down in the course of two years, but we must recollect that to-day European nations are too short of capital and too exhausted by the recent strife to be able to dump goods upon our shores in large quantity, so in the United States labor-demand bids fair to keep up. When prices of labor and supplies go down then we may expect an increase in mining.

for the storage of machinery and its protection against damage and rust are also to be arranged for. A supply of water must be available and often one may get a supply of electricity for power and lighting also.

The labor supply must be studied and provision made for the comfort and efficiency of the men. Without such consideration the building of a mill in an out-of-the-way place would prove disastrous to an enterprise.

**Preliminary Work.**—The cost of all this preliminary work will amount to 5 to 10 per cent of the total and may be estimated on the ground.

**For concrete work** a quarry may have to be opened and a bed of suitable sand may be available. Indeed it may be prudent to file upon a claim covering their location.

On page 547 we have already discussed the nature of the site to be chosen and the rights to which the company is entitled in filing upon ground for a proposed mill or smelter site in connection with a mine.

**Carpenter work** with a picked-up local crew will average \$28 to \$31 per thousand for framing and erecting, \$19 per thousand board feet for siding and roofing, \$2.50 a thousand shingles for shingling, and \$1.25 per square of 100 sq. ft. for putting on corrugated iron. The nails needed in erecting would be 18 to 21 lb. per 1000 board feet, in putting on siding and laying 2-in. flooring; while for 1-in. flooring 28 to 32 lb. per 1000 board feet is needed.

**Minor Items are Important.**—Thus considerable lumber is needed for forms and for staging. The building should be painted, fire protection and heating arranged for, office and laboratory equipment bought.

**Alterations.**—Upon a completed mill it may be necessary to make alterations and this, as experience shows, may amount to 5 to 15 per cent of the total costs.

**Winter work** in the Northern United States or in the mountains may add as much as 33 per cent to the total labor costs even in a mild winter, and in cold snowy weather such costs may rise to 50 per cent. Concrete work often costs 35 per cent more, as complete arrangements must be made for heating and protecting against the frost until after the preliminary set, after which freezing need not affect it.

**Expense of Rebuilding Old Works.**—As in a new mill, the costs can be rather accurately figured, but the amount of hardware and lumber that can be used again is often misleading. The costs of the carpenter work and of the reassembled machinery will generally be twice that of a new plant.

**Underestimates.**—These are due to guess-work, lack of good organization, omissions and changes in plans, neglect of preliminary work, too much reliance placed on general figures, and inefficiency of labor due to unfavorable conditions. Also must be mentioned the danger of strikes, bad weather delays, and failure of railroads or supply houses to supply material as needed.

**Machinery Prices.**—A reputable machinery house will give valuable information, and no matter how confident the constructing engineer he should give careful attention to it. They are willing to go into details with him. They do not drop their responsibility when their machinery is delivered and are always desirous of protecting themselves in this way.

Untried innovations, especially by a small plant, should be avoided. Let it be tried out by a larger operating company and, if it is fully proved there, it can be put in.

If the plans of the works are carried out, a good organization maintained and efficient labor obtained and kept, then the figures for construction will be found a little higher than actual costs.

### COSTS OF METALLURGICAL PLANTS

The following table gives the daily capacity and the total cost of a variety of plants based on figures of 1913 and before. Costs are now (1920) easily double these:

Character of Plant.	Capacity in Twenty-four Hours.	Cost.
Iron blast-furnace . . . . .	300 tons pig iron . . . . .	\$ 650,000
Acid Bessemer with four remelting cupolas and hot metal mixer . . . . .	2000 tons of steel . . . . .	900,000
Acid open-hearth; ten 50-ton furnaces	1000 tons of steel . . . . .	1,500,000
Basic open hearth; ten 50-ton furnaces	1000 tons of steel . . . . .	1,650,000
Copper smelting and converting . . . . .	1000 tons of ore smelted to 100 tons of 45 per cent matte and this converted to blister copper . . . . .	1,250,000
Silver-lead smelting . . . . .	500 tons mixed lead over to base-bullion . . . . .	250,000
Refinery for base-bullion . . . . .	100 tons base-bullion, refined by the Parkes process . . . . .	250,000
Refinery for doré bars . . . . .	30,000 oz. . . . .	20,000
Refinery (electrolytic) . . . . .	100 tons copper from blister-copper to wire bars . . . . .	500,000
Zinc smeltery . . . . .	100 tons of blende (not making sulphuric acid) . . . . .	375,000
Gold mill (amalgamation) . . . . .	100 tons of ore . . . . .	50,000
Gold mill (cyaniding) . . . . .	100 tons of ore . . . . .	100,000
Copper blast-furnace works . . . . .	900 tons (no roasters) . . . . .	560,000
Copper blast-furnace works with converter plant . . . . .	1200 tons . . . . .	984,000
Copper blast-furnaces and converting (Washoe Works, Anaconda) . . . . .	8330 tons . . . . .	10,680,000

## UNIT CONSTRUCTION COSTS IN 1914

These are the most useful to the engineer, since, having made plans of a plant or of any proposed building, he can use these units in making his estimates of costs. These data, found also in engineering hand books, are carefully set forth for a smelting plant in an elaborate paper by E. Horton Jones, Trans. A. I. M. E., XLIX, 3. These figures, quite applicable to the Clifton, Ariz., district in 1914 would need to be doubled to conform to our present 50-cent dollars, and should be modified by any accessible recent costs. At that time common labor cost \$2 and skilled labor \$4 per day, as compared with something like double that now. It is to be noted, that the figures below given for unit-costs, are averages.

The works cost, completed, \$2,105,020.17. Out of this has to be reckoned \$100,649.88 for engineering and \$140,277.72 for indirect expense, including all necessary for clearing and preparing the site and its approaches, working equipment, personal injuries, railroad transportation to employees, etc. This left \$1,864,092.47 for the work that would show upon the completion of the plant. The engineering cost was then 5.4 per cent of this, indirect expense 7.53 per cent, a total of 12.93 per cent to be added to the construction costs.

The following is a recapitulation of all costs, with its list of buildings, all equipped:

No.	Name of Account.	Total.	No.	Name of Account.	Total.
7100	Engineering expense...	\$100,649.88	8625	Roaster dust chamber flue.....	\$12,859.10
7300	Yard tracks and industrial system.....	156,326.43	8700	Boiler and blacksmith shop.....	21,449.23
7400	Receiving bins.....	44,185.06	8714	Machine and carpenter shop.....	27,356.27
7700	Crushing plant.....	9,268.62	8800	General office.....	1,394.95
7800	Sampling plant.....	34,108.74	8809	Warehouse.....	13,602.71
7900	Bedding plant and bunker bins.....	150,939.05	8819	Laboratory.....	6,144.02
8100	Roasting plant.....	136,734.87	8840	Sample room.....	2,826.11
8120	Roaster dust chamber	49,664.76	8900	Miscellaneous acc'ts	37,186.48
8300	Reverberatory plant...	328,945.02	8999	Indirect expense....	140,277.72
8400	Converter plant.....	216,033.37	9000	Power-plant.....	434,703.15
8420	Converter dust chamber	27,813.58	9060	Oil supply sump and pump house.....	40,611.88
8500	Conveying system....	45,411.15			
8600	Chimney.....	45,471.34			
8610	Reverberatory flue....	13,453.70			
8620	Converter flue.....	7,602.88		Total cost.....	\$2,105,020.07

**The Unit Cost for Concrete Foundations.**—The average for all foundation work would be \$3.37 for labor and \$5.48 for materials, a total of \$8.85

per cubic yard, in place. For reinforced foundations this is much more expensive, the labor cost being \$5.84 and the materials \$7.66, or a total of \$13.50 per cubic yard in place.

**Unit Costs for Concrete Floors.**—These are laid like a sidewalk 5 to 6 ft. square, 4 to 5 in. thick and with a finished top. They are reckoned at a cost per square foot as follows:

Plain concrete floors—\$0.08 for labor and \$0.13 for materials or a total of \$0.21 per square foot. Reinforced concrete floors—\$0.18 for labor and \$0.23 for material, or in all \$0.42 per square foot. These are formed, reinforced, and finished.

**Unit Cost for Excavation.**—This depends on its nature, as below given:

For shallow excavation, using wheelbarrows and slips or scrapers, and with a "haul," or distance to move the materials less than 100 ft., the cost averaged \$0.81 per cubic yard reckoned in place. When the haul was greater than 100 ft., needing carts, this cost rose to \$0.95. Where the ground was solid, needing some blasting, even with less than a 100-ft. haul, the cost was taken \$0.84 to \$0.93. Like the preceding when the ground was hard, and the haul (using carts, etc.) over 100 ft. the cost became \$0.89 to \$1.00 per cubic yard.

Averaging all the unit costs for excavation we find it to be \$0.79 per cubic yard.

**Unit Cost for Electric Lighting.**—This is based upon the cost for wiring, and the material for each drop or light used. It is averaged at \$4.84 for the labor, \$5.85 for the materials, or a total of \$10.69 per drop.

**Unit Costs for the Erection of Machinery.**—The total cost of the machinery is made up of its cost f.o.b. at the factory, plus freight to its destination, plus the cost of unloading and erecting. This may be computed at so much per hundred-weight. The manufacturers will quote weights and prices at the factory, the freight rates may be obtained from the railroad schedules, and the erection costs are as here presented. It is useful to reckon prices per hundred-weight from the machinery costs as collated, according to the nature of the machinery. The freight costs vary with the classification.

The unit costs, both of the value delivered at the plant, and for erection, vary with their nature.

Group 1 refers to engine machinery that needs to be placed, cleaned, adjusted, and lined up. The cost of the machines delivered at the plant is \$12.67 per hundred-weight or 12.67 cents per pound. Add to this \$0.92 for unloading and erecting, and we have a total cost for the machines in place \$13.59 per hundred-weight.

Group 2 is similar to Group 1, but not so heavy and takes proportionately more labor to put in working order. The cost delivered is \$8.53, and for erecting \$1.50, a total of \$10.03 per hundred-weight.

Group 3 is heavy machinery needing little labor in erecting. The machinery delivered cost \$1.04, and for erecting \$0.68, making a total of \$12.72 per hundred-weight installed.

Group 4. This resembles Group 3, except that it is electrical. Its cost at the works is \$12.67, for erection \$1.63, or in all \$14.30 per hundred-weight.

In all these cases the erection cost is made up of labor and the needed small supplies, as cotton waste, oil, small tools, etc.

**Unit Cost of Masonry.**—This is given for a retaining wall at \$6.19 per cubic yard.

**Unit Costs for Painting.**—For painting concrete the labor will average \$0.08 and the paint \$0.12, or a total of \$0.20 per square yard for two coats of paint. For painting iron, the corresponding items would be for labor \$0.10 and for materials \$0.15, or in all \$0.25 per square yard for two coats. Woodwork is cheaper, being but \$0.10 per yard in two coats, while painting sash and doors is expensive, being \$0.96 per sash, one door being reckoned as two sashes, and all being three-coat work.

**Unit Costs of Roofing.**—When the roofing consists of 1-in. sheathing covered with asbestos, but not painted, the cost was per square of 100 sq. ft., for labor \$4.06, and for materials \$12.40, or in all \$16.46 laid. Much of the roofing was of 2-in. stuff with asbestos covering, taking a total cost of \$26.08 per square. The costs vary greatly according to the kind of roofing needed.

**Unit Costs of Shafting, Pulleys and Belting.**—The basis is per linear foot of shafting equipped with its average of pulleys and belting. According to the building in which it is used it varies from \$22.76 in the sampling plant, to as little as \$7.98 per foot in the blacksmith shop.

**Unit Costs for Structural Steel.**—This has reference to the steel used in the construction of trestles, buildings, etc. Like machinery, it includes the cost laid down at the works, plus the cost of erection. It is a pretty uniform figure and will average \$87.13 per ton or 4.356 cents per pound.

**Unit Costs for Ventilators, Windows and Doors, Woodwork and Wooden Floors.**—Ventilators cost on an average \$95.67 each, erected; windows and doors were reckoned at \$0.81 per square foot. Woodwork cost \$52.55 per 1000 sq. ft. board measure, while the wood floors cost \$0.21 per square foot erected.

**Unit Costs for Labor.**—Upon these, as shown above, other costs depend and it might be well for a rough approximation to vary the costs here shown on the basis of the labor-cost. Thus, with the cost of labor doubled, we may expect that supplies have correspondingly increased, and so that the above estimates are to be doubled. The proper way is, however, to readjust the labor costs as given, by the new figures, for labor, and ascertain freshly the cost for supplies and equipment.



**Wage Scale.**—This was in September, 1913, at Clifton, Ariz., for common labor \$2, for skilled labor \$4 per day of eight hours. We may note that of late, due to increasing wages, and the scarcity of labor, men have become less efficient.

### COMPOSITE COSTS

These are convenient figures for arriving at an approximate idea of the cost of a building, either empty or equipped, based upon its area or cubic contents or of its machinery and equipment, according to its capacity.

The cost of buildings varies from as little as \$1.51 for the roasting plant, to as much as \$3.62 for the crushing plant per square foot of floor area. In reference to cubic contents the cost varies from \$0.11 to \$0.22 per cubic foot for the respective buildings just quoted.

When it comes to the cost of these buildings with all their machinery or equipment in place, the figures are increased according to the cost of that equipment. Thus the roasting plant comes to \$4.76 and the crushing plant to \$5.62 per square foot of floor area, while, for cubic contents, the former is reckoned at \$0.33 and the latter \$0.34 per cubic foot, showing how expensive relatively is the equipment of the roaster-plant.

The feed-bins and the bedding-floors (using the Messiter System) cost \$0.66 per cubic foot of capacity, the heavy receiving-bins come to \$3.34 for the same unit.

Conveyors will cost from \$19.02 to \$32.58 per ton of hourly capacity, this including the cost of the steel supporting structure. If we were reckoning a conveyor according to its cost per linear foot, erected, this would be \$34.47 per foot.

Dust-chambers are \$0.30 on an average per cubic foot, the flues \$0.45.

A useful figure is, that the cost for power-house installation (including the boilers), would be \$55.32 per indicated horsepower, while, if the boiler plant is not included, this drops to \$37.40 for the same unit.

Again, the cost per ton of output in twenty-four hours for the reverberatories is \$43.47 per ton.

The cost per roaster, complete with its installation, is \$17,091.86, and, with its building and flues and dust-chambers, this figure rises to \$24,097.34.

The railroad trackage cost \$4.64 per running foot, being \$2.71 for labor and \$1.94 for materials.

**Raw-material Prices.**—In Mr. Jones' paper a table of such supplies is given f.o.b. Clifton, during 1913, and to this the student is referred.

The author is of the opinion that a careful study of this paper, including its illustrated details and descriptions, would constitute a great aid in an engineering education.

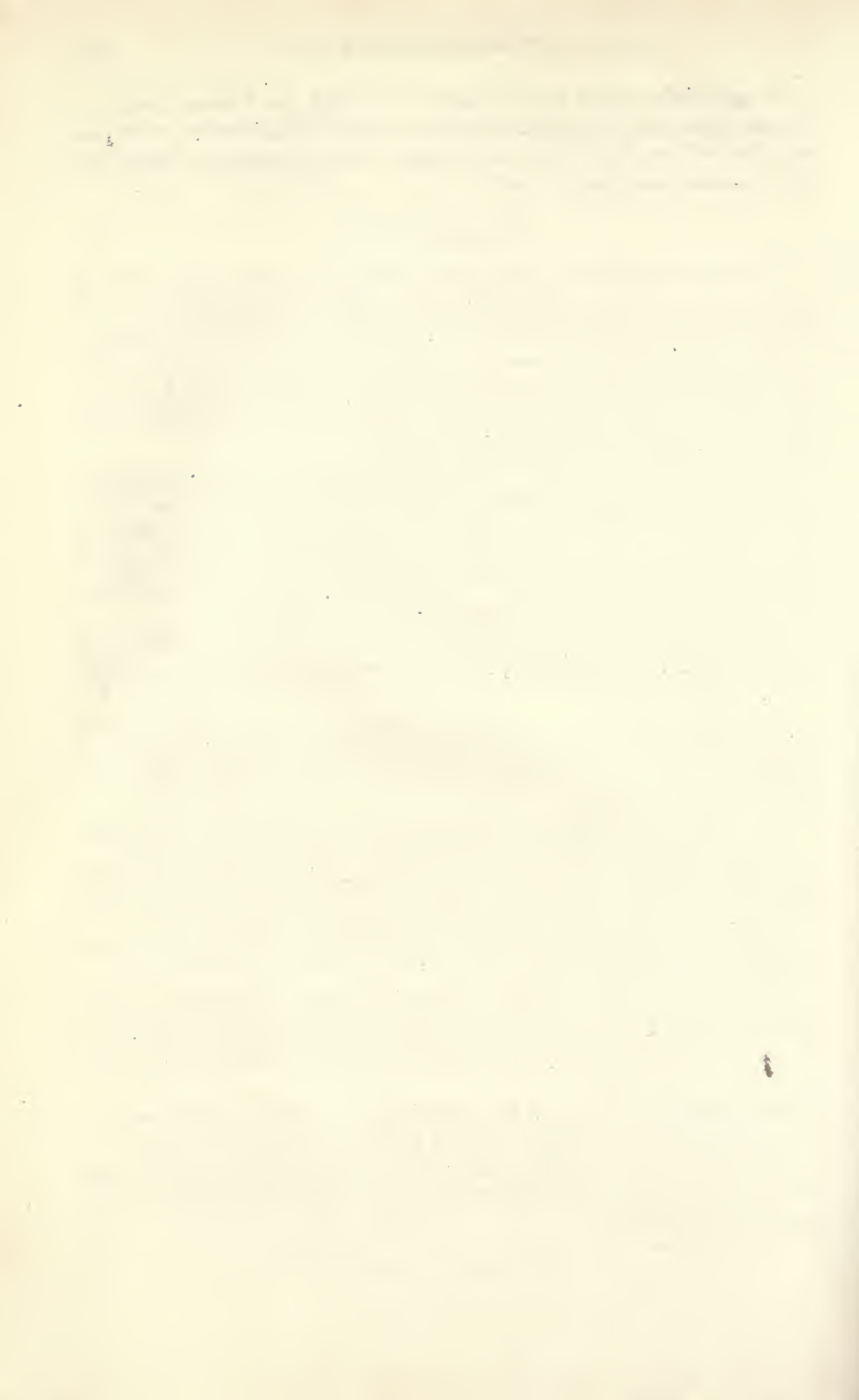

**PART IX**  
**THE BUSINESS OF METALLURGY**



## CHAPTER XLVIII

### THE GENERAL ECONOMIC SITUATION

#### DISTRIBUTION OF WEALTH

So far as the United States, in its internal economic condition is concerned, we may say:

The fixed wealth of the United States in 1916 was about \$260,000,000,000, whereof about \$30,000,000,000 was in stocks of goods and all the rest in real estate, railways, etc. The population of the country was about 102,500,000 souls, of whom about 41,000,000, men and women, were workers, about 14,000,000 of them being farmers. The total national produce was about \$1,200,000,000 tons of goods, worth about \$45,000,000,000 to \$50,000,000,000. Out of that produce a group aggregating a little more than 400,000, who received incomes in excess of \$3000 and paid income taxes, got about \$7,900,000,000. Less than one-half of that was derived from investments and more than one-half came from the personal efforts of this class. Persons enjoying incomes of less than \$3000 received about 44 per cent of the dividends paid by corporations and a much larger proportion, perhaps 75 per cent of the government, state, municipal and corporate interest payments. There remained from \$23,000,000,000 to \$28,000,000,000 to be divided among 27,000,000 non-agricultural workers, who received an average of somewhere between \$855 and \$1040 each. Among the great classes of workers there is a wide difference in earnings. The farm hand in 1916 averaged about \$400, the factory worker \$675, the steam railway man \$886, and the metal miner \$1250. Some classes probably averaged higher wages than the metal miner.

A satisfactory economic system can be based only on natural human impulses, and of these the most fundamental is self-interest. Increased production is at the present moment the most pressing national need, but it will become effective only when for every man increased production becomes the talisman by which his paper wages can be turned to gold.

#### ECONOMICS OF ENGINEERING

The mining engineer, entering upon the practice of his profession, may confine himself to the technique of mine-operating, while the ore, delivered from underground, is then taken in charge by the metallurgical engineer,

whose business it is to win the metals from it. The young engineer, entering metallurgical practice, takes subordinate work, such as drafting or assaying or testing, which gives him thorough knowledge of certain branches of the work that he is to take up later in operating. On the other hand, the duties of metallurgical practice may be early assigned to either the draftsman or assayer, so that they may be compelled to think along the lines of actual practice. We find, as a matter of fact, that men actively operating, are thinking much of those duties, are studying and discussing them, often relegating to the background the economic considerations later liable to come up; hence the discussion given on the following pages to these aspects of metallurgical engineering.

**The Economic Situation in the United States as Related to the Production of Metals.**—The prosperity of custom works reflects that of mining and profits in them fall away in dull times, since their charges must be reasonable in order to get the ores. With the mines plants it is different and their prosperity is tied up with that of the mine. Milling or smelting the ore is but one item in mines operation.

The value of a metal is fixed by the cost of production at the "marginal class of mines," that is those mines that just pay their way. If the price of the metal goes up, leaner mines may become marginal, while the first ones cited come into the profitable class. If the price of the metal drops the marginal mine must close down.

### THE LABOR SITUATION

As the country has opened up so has the mining industry, and the demand for labor has been met in part by European immigration. This has of late practically ceased so that workingmen are acutely needed; and wages have doubled. Organized labor has taken advantage of this to make demands under pretense of needing a "living wage," that is money enough to meet the necessities, but also many of the luxuries of life. Often the strikers have not cared whether they worked or not; a holiday would well suit them. As a result, capital, whose rewards depend upon uninterrupted operation, has lost seriously, and the marginal mines are having to shut down, thus again cutting down the supply to custom plants.

**Unions and Non-union Labor.**—Two methods are in use in industrial plants, viz., the open shop and the unionized shop. In the case of the open shop the method of individual bargaining prevails; in the second, that of collective bargaining, that is, the agreement for wages, hours, and treatment, are made by the officers, or by a committee on behalf of the men, who belong to a labor union. In the second method it is expected that none but union men are to be employed.

The union shop with its working force is controlled by the labor union.

Workingmen who treat individually, lacking the backing of a union, may be taken advantage of by the employer, who offers them a low wage or treats them in an arbitrary way, and such men wish the support of the union. The union declares the equality of all their men, says that the fast workman shall do no more than the slow one, because the fast man compels the slower one to work to exhaustion; that, if output is increased, then demand will cease and the workman will be out of a job.

The worst feature of a union is, however, its tyrannical power, that it makes its demands on the penalty of a strike to enforce them, that the power to call a strike is entrusted to intermediary officers, when it is notorious that such positions have been sometimes gained by cajolery, bribery, and the methods of ward politicians. In such cases strikes have been called when but a small fraction of the working force has desired them. In a unionized works men who are employed in special work may be unrepresented in committee. There may be a dozen or more of such specialized positions enjoying compensation dependent on their skill. There will always be an incentive on the part of the committee man to favor his own job, or his own friends, and on the other hand the works manager may be only too willing to back the committee man if he sees it is to his advantage. Such methods produce discontent, and eventually a strike. Even men who receive the highest pay may be so affected. It is suggested that these highly paid men might be paid even more in order to keep them quiet, but there will come a time when this is more than the union as a whole will stand, since the action of the committee is not final. The signature of the company bears with it responsibility, but the signatures of the committee do not. The union is not incorporated; it has no tangible assets, it is irresponsible. It cannot bind an individual to work, and if there is a good demand for labor he may seek it elsewhere. If indeed the union wishes to aid some other it may go out on a sympathetic strike, due to no fault of the responsible company.

Where large bodies of skilled men of one trade join in a union, that is different, but for a works having varying pay according to the skill of the workman the union is bound to be inequitable. The total unionized labor in the United States is 3,000,000 out of 35,000,000 people engaged in gainful occupations; it constitutes a body one-twelfth of all the workers, holding up production if striking, and raising the cost of living to all the rest, and especially the many income receivers, who, due to their thrift, have invested in these very companies. Thus a man who has thought to provide for his retirement in old age, or to insure on behalf of his loved ones, is compelled to labor on, or to live a constricted existence.

The labor union also makes the tyrannical demand that non-union men shall not work with union men, that the shop shall be a "closed" one, even that goods made by non-union men shall not be delivered to a

union shop. Many modern strikes are based on these ideas, and the strikers are prepared to carry them out with picketing or even with deadly violence.

The union disapproves of labor-saving machines, unless the profits arising from their use are distributed among all the men, its reason being that it fears production will outrun demand and so the workmen will have nothing to do. A sufficient reason why such machines are not contrary to the interest of the workmen lies in that fact that formerly, when such work was done by hand, a skilled man had to be physically superior and by middle life, despite his skilled knowledge, had to take inferior work. With the introduction of the machine he could retain his employment, indeed earn more than when he laboriously worked. It was of mutual advantage to retain the services of such an experienced and trusted man.

### ARBITRATION

This implies the settlement of disputes between employer and employee. By enactment of law it may be compulsory or advisory. By private agreement an arbitration committee depends on its power of persuasion, or the willingness of both sides to submit. In this, public opinion may come in as a factor, especially if its interests are directly involved. In so-called compulsory arbitration one can hardly see how a works can be compelled to operate at a loss except by confiscation, nor how a man, or even many of them, can be compelled to work if they do not wish to; they are pecuniarily irresponsible. To be sure, as has often been done, when the employer has submitted, it has been possible for him to raise his prices to meet the increased labor-cost, and so pass them on to the ultimate consumer. Arbitrating committees may be appointed to adjust grievances, but a better way is that each man who feels he has been ill-treated should have access to the works-manager or superintendent, the ultimate judge. In this way favoritism or nepotism may soon become unknown, and injustice checked in its beginning. Investigation shows in general that the man's statements are correct, and a fair and equitable arrangement should be made. In these cases it is well that the matter be discussed in private and that, for psychological reasons, the complainant in discussing it should sit down.

Where work is abundant and jobs waiting, men become arbitrary, notional and unreasoning, since they feel they can compel. When times are dull and work hard to find, they will take what they can get; the employer may then become arbitrary. We give herewith the periods of panics and their causes which can be used in guiding future action on the part, at least, of the employer.



## FINANCIAL CRISES IN THE UNITED STATES

First.....	1819
Second.....	1837
Third.....	1857
Fourth.....	1873
Fifth.....	1885
Sixth.....	1893
Seventh.....	1907
Eighth—severe decline in business.....	1913
Ninth ?.....	1927 or 1926

## ASSOCIATION OF EMPLOYERS

We have mentioned the shortcomings of the workingman; the question arises: What is the employer to do? His best plan is to imitate the methods of the union. Association: This is all-important. Thus the mining industry, the smelting industry, the milling industry should unite to:

(1) Form a union to which all should liberally contribute, probably small and large alike.

(2) Appoint an executive committee to establish a propaganda based upon exact and statistical information. These data should be accessible to writers who can make good use of them and these writers should be properly compensated. There should be statisticians who have power to enter into the matters of costs and prices, also men skilled in deducing conclusions from them. Income-receiving men of limited means should be hired to preach this propaganda, and carefully instructed. Where the situation is fitting the officials of the companies should speak at meetings and elsewhere. The association should use the lockout judiciously and should carefully prepare for the shut-down.

Finally, even as the union man will strike and starve to gain his ends, so must the company do, confident that by lockouts a permanent improvement can be made. Where one or two out of many shut down, it is but fair they should draw compensation from the general fund.

## CHAPTER XLIX

### ORGANIZATION AND OPERATING

#### ORGANIZATION OF A METALLURGICAL COMPANY

Metallurgical operations on a commercial scale require, generally, the organization of a company, or if the company is already organized, the establishment of a department to provide the additional function.

Where a metallurgical company is to be organized, the promoters or organizers obtain a charter, or articles of incorporation, from the State in which they desire to incorporate. They next hold a meeting at which they receive the property that is to be taken over by the company, adopt a set of by-laws for the guidance of the company, and elect the directors that are to manage the affairs. The directors proceed to the election of the corporate officers of the company from their number. The officers of a small company are the president, the vice-president, the secretary and the treasurer. The directors may appoint from their number a managing director, or they appoint a manager from the outside to have charge of the affairs of the company.

#### THE ADMINISTRATIVE DEPARTMENT

In outlining the organization of a company undertaking metallurgical works, the manager should be guided by the following rules:

He should see that a supreme authority is provided over all action to be taken, and should carefully and fully outline the authority and responsibility of each position, making the duties of each conform to the capability of the party holding it. To do this, he must avoid making any person subordinate to two or more, should place the authority and responsibility together; should distribute the work and the duties not to overburden nor to underload; and should arrange the positions so that promotion can come from them. While the manager gives his chief attention to the commercial or business affairs of the company, he generally appoints a superintendent to attend to the technical affairs of the plant.

The industrial organization, under charge of a manager, would include (1) The operating department; (2) the accounting department, and (3) the purchasing and selling and supply department.

(1) **The operating department** has to do with all that pertains to the reduction or manufacture of the ore into metal (the winning of the metal from ore) or to refining metals to bring them into marketable form, and has control of the operating forces, consisting of the foremen (and men under them), the repair force (consisting of mechanics and their helpers, who keep the plant in repair and put in the needed improvements), and the laboratory or assay-office force.

(2) **The accounting department** attends to the accounting, pay-roll, cost-keeping, and the distribution of costs.

(3) **The purchasing, selling and supply department** attends to the purchase of ore, fuel, fluxes, and the chemical and other supplies. It sells the products of the works. By-products, in process of farther treatment, are not included.

### THE OPERATING DEPARTMENT

We discuss the qualifications of those in charge, the management of the working force, their welfare, efficiency, and their payment.

**Duties of the Superintendent.**—The superintendent not only must be informed as to the actual technical operations, but he must know how to organize his force. He should be able to handle men effectively through tact, discretion, and firmness. He should be strict but just; able to encourage as well as to drive. He is often the metallurgist and constructing engineer as well as the superintendent; and has the direct management, with the aid of his assistants and foremen, of the furnaces and the metallurgical machinery.

When things go wrong he may be called on at any hour to correct them; if a furnace is in bad condition, or a machine out of order, he is responsible. When all is going smoothly his duties may be light, but when troubles come, or the company is losing money, his work is hard. If he fails in adjusting difficulties, no excuse is accepted; he must succeed or resign. Much of his success depends on his subordinates, and first in importance among them the foremen.

General orders, applying to different departments, should be issued in multiple so that each foreman affected shall have a copy, thus avoiding delay or misunderstanding.

The work of supervision and control, that is, for the superintendent, his assistants, the foremen, the testing and laboratory force, and for the office men is paid monthly.

The men chosen to take charge of the different departments should be chosen according to their qualifications for that particular work, essential qualities being intelligence and reliability. Lower-grade labor is used for plain, hard, routine work, the better labor where judgment is necessary. Common or unskilled labor is liable to make blunders; however, when

trained, if faithful, it becomes reliable. The saving made by the employment of cheap men for operating costly machines is offset by the loss of time, or by actual disaster.

**Duties of Foreman.**—A foreman is often one who has been advanced from a lower position in the same works, or he may have been selected from another establishment. With a view to efficiency it is well in selecting a foreman to find out from former employers how he gets on with his men, whether he finds fault with them, whether he has been threatened by them. Though he may lead off or show them how things are best performed, in general, he has enough to do in seeing that the work is well planned, and that the working force are busy. He has not only to note the execution of the work, but to plan ahead, to be sure that everything is provided for, and is at hand when needed. In much of such work he need not drive as in routine work.

**Testing or Research Work.**—This department needs a head, not only capable of carefully making tests, but also of drawing useful deductions from them. Thus, a test may consist in determining which of two or more methods will be the most effective or economical. For example, one may wish to learn what coke (taking account of its price) would cost the least per ton of charge, or which of several methods of admitting air to one or other of the hearths of a MacDougall roaster will give the best roast.

The chemist and assayer are called on for the results of the analysis of by-products of the works, of the ores purchased, and of the products sold. He must produce with promptness results that control operations. In the case of ores bought, and of products sold, accuracy is fundamental. Certain supplies like oils and chemicals may have to be analyzed by him.

**Repair Force.**—The repair force, consisting of the master-mechanic and skilled men under him, not only have to make repairs, but have new construction to attend to, generally under supervision of the superintendent, who may, where the works require, employ a constructing engineer and draftsmen. It is a good rule, in case of a breakdown, or other similar emergency, that this work have precedence, and other work be dropped to expedite it. A plant might easily be losing a dollar per minute during such a period.

**Workmen.**—The laborers at a smelting plant are largely unskilled. These are called outside men or "roustabouts." They do the work needing pick and shovel, such as unloading cars, handling the products of the works, carrying materials, etc. Skilled laborers, or men working in shifts of eight hours daily, and called inside men, receive higher pay per day than common laborers, the pay varying according to the particular position held. These men are responsible for the successful performance of the duties assigned to them.

## RULES OF WORK

For keeping discipline, and to prevent slackness, certain rules, the result of long experience, have been laid down. These are:

The men must be promptly at work and must work full time.

Inside men must be on hand the entire time of their shift, and must eat their luncheon as they can spare the time, while not neglecting their duties. Charge-wheelers must keep up the supply, but may rest at intervals as they wish. They are not called on to do other work, except sweeping up their own places before going off shift. The inside man can leave when relieved by his partner, but must wait for the partner until relieved. If the latter fails to appear the foreman provides another man, who then holds the place, the absent man losing it, unless he has a good excuse, or if sick, he is expected to notify the foreman who provides a man for the place. When the absent man desires to return to work, he must notify the foreman one shift in advance, so that the substitute is not put out of a shift for which he has come prepared.

When men are sick on shift, if not too seriously, they should be held, if possible to the end of the shift. It is impressed on them that it is detrimental to the work for them to leave, and that it is difficult at such short notice to get a substitute.

Men must obey orders, and disobedience can only be followed by discharge, otherwise discipline is weakened.

Let the foreman be strict but just. It helps in discipline to let out a poor man occasionally, and if this is seldom done one may suspect that the foreman is not strict enough.

Do not entrust men to do routine work without supervision and inspection, they may do it wrong or become careless if they realize they are not watched.

In smelting or milling, operations are carried on by a crew who work together, each being responsible for his assigned duty. All are directed by the foreman, who sees that operations are regular. All this crew are inside men, and a fresh crew replaces the preceding one.

## PLANT-OPERATION

**Efficiency of Men.**—In smelting, mechanical appliances are increasingly in use, demanding a greater investment of capital, thus reducing the labor per ton of ore treated. This makes a man's work less strenuous, and yet better paid. Both these advantages make a man more anxious to retain his job, and so he is more dependable. In a large works the labor needed per ton of ore is less than in a small one. Steam-power needs more attendance than water-power, and is on the whole more expensive.

In starting a plant into operation, a list of places and occupations of the men is prepared, so that men who are chosen may be quickly assigned to their positions. These men should be questioned and carefully chosen. When a new works is about to start, skilled men often apply, and they may be willing to do common labor pending the starting of the works, and in this way be held until their services are needed.

**Care of Men.**—Provision is made for the care of the men in case of sickness. A charge of \$1 per month is often made against every man, and this entitles him to medical attendance and care at the hospital in case of accident. If a man works five days in any month, the \$1 is deducted from his pay for hospital dues.

### MORALE OF INSIDE MEN

An efficient mill or smelter man is proud of his work, and to encourage this the plant should be kept clean and orderly on all shifts, even though this adds to the expenses. He should have training in repairing his machines and not have, at least for minor repairs, to wait for the repair gang.

Where those in charge are out of sympathy with their men, and hold aloof from them, it conduces to a larger turnover, that is to men leaving and others in their places having to be broken into the work, involving losses in so doing. Where possible, and it generally is, the foreman should notify the superintendent of his intention to discharge a man, thus preventing its depending on impulse or dislike.

A man should be fitted to his work, and if he fails to do well, he may be shifted to another duty, better suited to his capacity or tastes, rather than that he should be let out. Of late, for a large works, an employment-specialist tests applicants to determine not only their fitness but also the kind of job at which they can do their best. A well-trained man should be encouraged to stay. The practice permitting frequent overtime is unsound, since it tends to excite by the prospect of overtime pay, but is, in the long run, exhausting.

It is well to get in the way of talking over works-methods or improvements with the men; it adds to their efficiency and interest in their work and men suggesting improvements should be rewarded in some way. The mill man's interest is increased by his receiving training on the repair gang, then he can make minor repairs himself.

Contentment is increased by fair wages, bonuses, comfortable and attractive surroundings, yearly vacation, sick pay, and medical attention. Quarters should be arranged for married men, and for single ones bunk houses, where they can sleep undisturbed when off shift. If, however, money is freely spent for these purposes there is a fear that the men may

think the company is rich, so why not strike for higher wages. There is such a thing as being too conciliatory. Even where the company can afford it they should rather wait for the men to ask for the improvements, though these may be put in on the basis of increased resultant efficiency and for the reason that it is the custom in other plants. The men reason thus: These improvements cost much money; we do not value many of them, so why not pay their cost directly to us as wages.

Sunday closing is recognized in principle as giving rest and a change in the total life of entire plant force. To interrupt weekly plant operations and to bring back regularity of operation on Monday may involve serious expenses and loss in extraction. Moreover, that men put in this idle time in a manner detrimental to their efficiency is another argument used. Still, the endeavor in any plant is to cut out operations that can be deferred until Monday, such as the work of most of the office force.

#### MODES OF PAYMENT

Daily wages and frequent payments—especially in dealing with laboring men of the primitive races. Monthly payments interfere with the steady operation of the works, because at the time of the monthly payment the men are disposed to “lay-off” to spend their money. To overcome the difficulty two methods have been tried. One is that of daily payments, by which a man, who spends his money when he gets it, has only sufficient to supply his daily wants and those of his family, and none remaining for drunkenness or gambling. The other system is to pay a wage to which is added a premium that increases with the time worked. It is paid at the end of the month if the man works through the month, but otherwise not. This tends to keep him steadily at work.

Also careful attention must be paid to the exactness of the payroll, otherwise dissatisfaction may result, with desertion at a critical time, so that the works suffer from labor shortage. This difficulty is now overcome by the use of indicator clocks by which the time of entry and exit is punched on the employee's card, giving an unerring record that he can reckon up for himself at the end of the month.

**Piece Work.**—This is the payment prevalent in steel works where the men are paid according to quantity. The great difficulty is to establish the rate which shall be fair for both sides. If the employer sees that the man is making inordinate profits, due to his speeding up, he may cut the rate, to the dissatisfaction or even the loss of the man. The method becomes complicated where several men work together, since some of them are more efficient than the rest. A subcontract, however, may be given one man who hires his assistants. In practice, in certain steel works, wages have increased 50 per cent to 60 per cent and production doubled.

**Daily Wages and Premium.**—To aid in this, the plan of progressive payments has been instituted, i.e., increased payments for tons in excess of normal output. At the Vieille Montagne zinc works several systems of payment are adopted, but the mill and smelter men get, in addition to a fixed wage, a premium calculated on output, and another premium for unusual energy. In some cases the men who fire the furnace-blocks get a premium based on the time their furnace lasts without repair. In other cases the retort man gets a premium for all over the calculated percentage of zinc yielded. Two-thirds the premium is paid monthly, the rest is retained to be paid at the end of the year, but only if the man has worked regularly throughout the year. At an English iron works puddlers are paid by the ton with a premium for the full number of shifts during the week.

**Profit Sharing.**—The system of participation in profits on the part of the men is both deceptive and dangerous. It is possible to admit officials, foremen, and specially skilled workmen to participation, but workmen in general are not fitted for the change. Everything goes well as long as the works are carried along at a profit, but in bad times discontent soon breaks out. The system is not favored by the workmen themselves. They are perfectly willing to share in the profits, but they object to responsibility for loss, or to even stand for the creation of a reserve fund to cover possible future losses. They cannot await better times, nor can they work their turn at a loss in order to retain their places. Besides this, profits appear too remote, and they cannot understand the relation that exists between the work and the annual profit.

Three methods of profit-sharing have been devised. (1) The workman gets a share in the annual cash bonus; (2) This bonus is kept back for a specified period and paid him together with the accumulated interest; (3) At the Vieille Montagne works the one-third portion that comes to the steady worker at the end of the year is thus distributed, viz., a portion of it is at once given him, the rest invested on his behalf. The system here has prevented strikes.

George W. Perkins, a well-known financier, proposes as a correct profit-sharing plan the following:

(1) That the business shall first of all earn operating expenses, depreciation (a serious item for a mine plant which is a wasting asset) and a fair return of 4 per cent or more according to the stability of the venture on the capital invested.

(2) That all profits above this should be shared on a percentage basis. Thus for a silver-lead plant the labor cost is given at 25 per cent.

(3) That the share of capital should be carried to surplus, the share of labor should be distributed to them as a security (bond or stock), of the company. The employees' share of the profits to be allotted on the basis



of their pay and that each employee should be required to hold his security for from three to five years.

### CAPITAL REQUIREMENTS

This includes not only capital investment and the funds to meet future obligations, but also the **working or quick capital** called the **liquid assets**, this latter being that needed to operate the plant. It includes the funds needed for purchase of ore, flux, fuels, and supplies, to pay wages and salaries, and to meet incidental working expenses. This includes product bought and in process of treatment. Often it takes thirty to sixty days to get returns on finished products. It often happens that the buying company or a bank will advance money to the seller on his product while awaiting the returns.

**Capital Involved.**—We have shown that a custom plant needs larger capital to carry a stock of ores and other supplies, but with a works plant the ore is apt to be but a short time to process, and so, especially when it ships a finished product, can pay its way with little trouble. Capital we understand to mean, not only that invested in plant, but that needed to carry a stock of ore, of supplies as well as to pay wages as they come due. Capital when invested in mines-plants rightly expects a large return on the investment, because of the risk involved, that the property may not prove up as expected. For we must remember that not only must dividends be large, but there must be the return of the original investment. When a mine ceases operation its plant and equipment are but little better than scrap.

It has been the fashion to complain that capital is in the hands of a few greedy rich men. In truth, however, mining stock is well diffused throughout the community and much of it has little value, or in other words the investment has not proved to be profitable. The chance of making large profits has enticed many into such investments and it has been said with truth that as much money is dropped in these ventures as has been taken out of them.

**The Costs of Production.**—These may be divided into prime costs, general costs and administration costs. Or we may divide them into working costs and overhead costs. Prime costs are those which vary according to the tonnage put through and which cease if the works shut down. They are also called flat, actual, or direct costs. They are made up of labor, motive power, fuel, material, supplies and repairs. Under material is classed what is used over and over again in specific operations, but which is gradually consumed as zinc in the Parkes process or the tank acid in electrolytic copper refining. Supplies include tools and other incidentals obtained from the general storeroom. Repairs include not only the labor, but the parts needed to replace those worn out.

**General Costs.**—These include taking care of the items of interest, cartages, lighting, foremen, watchmen, miscellaneous labor, sampling, the assay and chemical laboratory, testing, etc.

**Administration cost** takes in salaries, office expenses, law expenses, advertising, traveling expenses, purchasing, shipping, selling, taxes, rents, etc.

#### THE ACCOUNTING DEPARTMENT

The Council of the Institution of Mining and Metallurgy (British) unanimously adopted a uniform system of accounts, the outline of which will be followed as it relates to metallurgical works.

These accounts, while serving for guidance in the distribution of expenditure and the collection of revenue, must also show the profit or loss or the financial condition of the undertaking and should supply the management with the data necessary to check the efficiency of the administration and to point out how useless expenses may be cut down or revenue increased.

**Capital Expenditure.**—Before the producing stage of the works is reached, all expenditures should be charged to capital account under the following heads: (1) Lands; (2) Machinery and Plant; (3) Buildings; (4) Surface works as reservoirs, water service, railways, sidings, roads, power line.

After the plant is producing all other expenditure should be carried to "general expenditure account," to be distributed proportionately over the remaining heads of expenditure, but remembering to deduct any revenue that may have been received. Also, if additional property is purchased, or additional buildings, machinery, plant, or surface works put up, intended to increase production, improve recovery or decrease costs, then these items should be added to capital expenditure and they should bear the share of administration or general charges. If any machinery, plant, or buildings should be entirely superseded or replaced, their cost should be taken from capital expenditure and be charged to profit and loss. In case the item is small it may be charged in full, if large, then by installments spread over a judicious period.

**Temporary or Distribution Accounts.**—To distribute costs as evenly as possible it is well to open temporary accounts in order to spread the cost of considerable items of machinery or plant replacement, or payments which occur annually or less often over the monthly costs.

**Valuations.**—Bullion, concentrates or other marketable products ready for shipment should show as assets on the balance sheet and should be credited to Revenue Account at net valuation after deducting all realization or marketing expenses. Unfinished products, still in process, should be reckoned at cost, provided such cost is less than market value.

**Depreciation.**—This may be considered as it affects capital expendi-

ture, as already given. Systematic depreciation is theoretically correct. It is the amount charged annually to the profit and loss account, according to the conservatively estimated life of each item. The equipment of a mill or smelter plant may depreciate, for example at the rate of 10 per cent per annum upon the original capital, the buildings at the rate of 5 per cent. Thus, even if kept in repair, the equipment will, at the end of ten years, have value equivalent to scrap and may be practically obsolete. Depreciation may be divided as follows:

**Maintenance**, referring to the wear and tear on equipment and buildings. It varies with different classes of equipment, accidents due to deterioration, etc.

**Replacement**.—Caused by wear which cannot be repaired without replacement of the worn-out parts. The equipment will therefore fall below its original value.

**Obsolete**.—Due to new types of improved equipment which are necessary for rapid economical production. The old machine can only be scrapped and has no value except as old iron.

**Neglect**.—Even if properly maintained, the equipment, due to neglect, may fall below its actual market or working value.

**Inadequate**.—Machines may become too small to be of service. They often render co-operating equipment of no use, since they are inadequate to serve it. Such machines have a value if sold to those whose operations need them.

**Repair and Maintenance Costs**.—Suitable provision should be gradually made out of income for new buildings and equipment. It accumulates a fund for new plant and, at the same time, reduces assets to something like their true value.

**Costs**.—These may be divided into: **Flat or prime costs**, otherwise specified as ore treatment or reduction charges, and second, **General expense or fixed charges**, which take in administration and general charges, realization charges, taxes, and royalties.

To obtain a just idea of costs, where mine and mill are in one, we should really segregate the costs of mining, concentrating, and reduction. The costs we discuss, however, are the metallurgical ones and it is expected that they should be used in connection with the related ones.

**Ore Treatment or Reduction Charges**.—This should include all costs from the time the ore is delivered at the plant until the bullion, metal, or marketable product is obtained, and may be divided to suit circumstances. In it should come (1) power, (2) stores, (3) sampling, (4) assaying, (5) maintenance and repairs, (6) salaries and payroll. Maintenance and repairs should be segregated either on the basis of the shop expenses or according to the labor employed in each department.

## ADMINISTRATION AND GENERAL CHARGES

These include (1) consulting engineer and general manager's fees, (2) office staff, (3) stationery, postage and telegrams, (4) medical and sanitary expenses, (5) traveling expenses, (6) fire insurance, (7) employers' liability insurance, (8) hauling, (9) bank charges, (10) auditors' fees, (11) legal expense. (Legal expense includes questions relating to the right-of-way for ditches, flumes, roads, and electric power line (see page 549). The company must be defended against those farmers who claim alleged damage done by smoke. Contracts for the purchase of ore and supplies and the sale of products, as well as for railroad freight and for railroad facilities should be legally drawn up. The question of royalties and labor and supply contracts are settled by legal advice. (Labor disturbances also need to be legally handled.) (12) Directors' fees, (14) foreign agency expense, (15) interest on loans and bonds.

**Realization Charges.**—(1) Hauling, (2) freight, (3) shipping charges, agency, and commission, (4) sea freight, insurance, etc., (5) buying and selling expense, (6) advertising.

**Rents, Taxes and Royalties.**—These include (1) rents on buildings, etc., (2) tax on profits, both regular and excess, (3) public taxes, (4) royalties.

**Reports.**—The annual report of the manager should show: (1) The quantity of ore treated in tons with the value per ton, the relative values of recovery per ton in each department; (2) a detailed summary of working costs subdivided to correspond with the main headings and subheading of the cost sheets; (3) a short tabulated statement of the nature of and expenditure upon new plant and equipment, showing sales of old plant, if any.

Statements as to the quantities and values of supplies, fuel, fluxes, ores, and products on hand should be certified by responsible officials, countersigned by the manager. The taking of an independent inventory is advisable from time to time.

**Cost Accounts** are kept for the purpose of determining accurately the cost of ore treatment, so as to have a basis for treatment charge; to judge how well operations are proceeding, and to supply data for plant efficiency.

## TYPICAL OPERATING DEPARTMENT

**Silver-lead or Copper Smelting Works.**—This may comprise the following responsible men under charge of the superintendent:

Clerk and metallurgical bookkeeper; testing engineers in control of the physical and chemical laboratory of the research work and the testing; engineers and mechanics who have charge of the power plant and of

machine repairs; foremen to attend to the sampling, to the yard or outside work, to the roasters, to the sintering machines, if any; and to the blast-furnaces.

**Gold Stamp Mill Producing Concentrate.**—The force may include foremen, mill engineers and repair force, amalgamators, feeders and laborers.

The foreman has general supervision of the mill and looks after the handling, cleaning, and retorting of all amalgam collected. The amalgamators dress the chuck-blocks and plates, and keep them in good condition. They set tappets, regulate the water-supply, and make renewals. The feeders attend to the uniform feeding of the batteries, and assist the amalgamators in renewals and at the clean-up. A good feeder is a valuable man about a mill. The vannermen attend to the vanners, or concentrating tables. They must be men with experience, and commonly should first serve at the vanner as "sulphide-pullers." The crusher-men feed the crushers with the mine-ore as it comes to the mill. Oilers oil the machinery. Sulphide-pullers remove the concentrate or sulphide from the vanner boxes, and store it for shipment. Engineers run the power-plant, and have charge of the firemen. Firemen fire the boilers and remove the ashes. Coal-passers wheel in coal from the coal-pile to the boilers.

On repairs there are carpenters, with laborers to help them. In repairs on the vanners there is a special vannerman to assist.

**Forty-stamp Silver Mill.**—The inside labor may be given as 6 panmen, 3 helpers, and 15 tankmen on eight-hour shifts.

**100-ton Cyanide Plant Treating Concentrates.**—This would include the superintendent and his assistant; the accountant and the chemist; the foremen for each shift at the mill and for each shift of the refinery; also the foremen in charge of repairs; in the mill the solution, filter and pachuca men; in the refinery the refinery men; finally, under the repair boss, his repairmen, repair helpers and the common labor (often called roustabouts).

#### THE PURCHASING AND SELLING DEPARTMENT

This attends to the purchase and delivery to the works of ores, fuel, fluxes, and general supplies for repairs and renewals. It may also attend to the sale of the products of the works.

**The Purchase of Fuel and Fluxes.**—In Utah coke may be quoted at \$12.60 per ton, f.o.b. at the works, at Pittsburg \$5. Attention should be paid to its contents in moisture, to its proportion of fines, and to its analysis, and especially to the amount and constitution of its ash. So much does it vary in this regard that the buyer should be well informed in regard to the various makes of coke offered for purchase, and not depend on the price alone.

**Western coal** may be quoted at \$5.50 per ton for run-of-mine. For certain work slack-coal is quite suited. The favorable qualities are low ash, and the production of a long flame in the reverberatory furnace, a quality not so important for the boiler.

**Limestone.**—The price may be given at \$2 per ton at Utah works. For fluxing it should be low in silica. It should not be friable nor contain much fine.

**Iron Ore.**—Eight dollars per ton at the works on a basis of 47 per cent iron excess. An allowance or charge of 20 cents up or down is made from this figure.

**The Purchase of Supplies.**—These consist of iron and steel, castings, tools, pipe and fittings, oil and waste, brick, clay, quicklime, and chemicals. The list price of most of these are given in the catalogues of supply houses and discounts from the list are given. It is well to obtain competitive bids for furnishing these; for those things to be obtained on short notice, the buyer can, by arrangement, obtain the usual discounts. These supplies are kept in a storeroom, and should be issued by the supply department only on a written order from the foreman, or other responsible person who needs them. In this way it is known where they are to be distributed on the cost sheets. An account is kept of all supplies received and issued, so that, from it, can be learned how much and when to order such material, to maintain the stock. It is detrimental to the business to so run out of supplies as to cause delays.

Much knowledge is required in the purchase of supplies. The rule is to buy when prices are low, or on a rising market, but only in small quantities on a falling market, and to obtain the best discounts, taking care, however, to avoid the purchase of inferior goods.

# CHAPTER L

## PROFITS AND COSTS

### PROFITS

Profits from the operation of a metallurgical plant, whether a mines plant or a custom plant which has to buy its ores, may be defined as the difference between the total costs and the returns on the metal product sales. How varied are these costs is well shown in their enumeration under head of "Accounting," page 592. Profits may be increased by full opera-

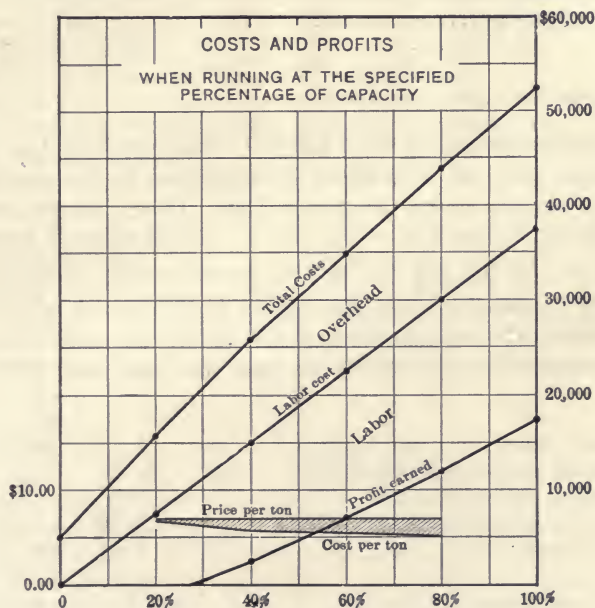

FIG. 330.—Costs and Profits.

tion, by better extraction or recovery from the ore, by economy of treatment due to methods permitting a saving of labor, supplies, or fuel, and by faster running by which output is increased.

The above graphic table shows how profits increase as the plant reaches its full capacity; it also shows that, in this particular case, profits

cease at 25 per cent of capacity and again that the profits per ton increase as full capacity is approached.

#### CUSTOM SMELTERIES

The profits of a custom silver-lead smelting works are obtained by subtracting from the money realized by the sale of metals recovered, the total costs for treatment, freight, refining, interest charges and selling costs.

**Milling Ores.**—In milling the calculation remains the same whether the ore is highly silicious or not.

The following figures represent the profits of a company owning a mine, the Robinson company, on the Rand, South Africa:

Gold recovered at the stamps.....	\$20.50	
Gold recovered by cyaniding.....	5.70	
		8.20
Total recovery.....		\$26.20
Cost of mining.....	\$6.55	
Cost of milling.....	0.98	
Cost of cyaniding.....	0.97	
		8.50
Net profits per ton.....		\$17.70

**Cœur d'Alene District.**—Out of 336,630 tons of ore mined at the Bunker Hill & Sullivan mine in 1906 there were shipped to the smelting works 86,640 tons of concentrate or one ton in 3.84. This averaged 45.8 per cent Pb and 18.78 oz. Ag per ton. The ore, as mined, assayed 13.32 per cent Pb and 5.89 oz. Ag per ton, the loss by concentration being estimated at 10.43 per cent Pb and 17.06 per cent Ag, or 11.96 per cent of the combined product. Taking the average prices at 4.6 cents per pound for the lead and 60 cents per ounce for the silver, we find the costs and profits per ton as below:

Assay value.....		\$15.78
Mining, milling and construction.....	\$2.43	
Freight, treatment.....	3.71	
Smelter deductions.....	3.08	
Mill losses.....	1.89	11.11
		11.11
Average Profit.....		\$4.37



## INDEX

### A

Accessories of the blast-furnace, 298  
— — — — (copper), 367  
Accounting department, 592  
Accounts, cost, 594  
—, distribution, 592  
Acid, Bessemer process, 321  
— -lined converter, 322, 323  
— — operation, 322  
—, open-hearth process, 333  
— parting of silver-gold bullion, 278  
— refractories, 31, 32  
— treatment of zinc-box precipitate, 183  
Action of machine in crushing, 50  
Administration and general charges, 594  
— department, 584  
Agglomeration of fine ores, 286  
Agitation of slime, 157, 160  
— treatment, 161  
Agitators, combined pneumatic and  
mechanical, 160  
—, data of, 187  
—, mechanical, 159  
—, pneumatic, 158  
Air, combustion in, 76  
Ajo process, 432  
— —, flow-sheet, 433  
— —, leaching tanks for, 435  
Akins classifier, 69, 70  
Alabama pig iron, 315  
Alaska Treadwell mill, 215, 216  
— — —, (tube-mill circuit), 215  
Alkaline earths, action of in slags, 482  
Allen cone classifier, 69, 70  
Alloy steel, 347  
All sliming cyanidation, 157  
Alumina in slags, 482  
Aluminum dust, precipitation by, 261  
Amalgam, safe, 241  
—, treatment of, 241

Amalgamation and concentration mill, 245 —  
— — — of silver ores, 234, 244  
— of gold ores, 123  
— — — —, (plate), 123  
— (patio process), 249  
American filtering machine, 170  
— ore hearth, 464  
Ammonia leaching, 438  
Anodes and cathodes, 451  
— — —, handling, 453  
—, sampling, 49  
Anthracites, 12  
Antimony gold ores, 145  
— in silver-lead smelting, 483  
Arbitration, 582  
Argall roasting furnace, 97  
Arsenic in silver-lead smelting, 483  
Arsenical gold ores, 145  
Artificial fuels, 11  
Association of employers, 583  
Augustin process of silver milling, 250  
Automatic or machine sampling, 42

### B

Bag house, 488  
Ball mill, 56  
— —, Hardinge, 57  
— — in closed circuit, 56  
— —, path of travel in, 56  
— —, proportions and efficiency, 56  
— or tube-mill drive, 63  
Bar screens or grizzly, 66  
Barrell chlorination, 137  
— —, plant for, 141  
Base bullion, costs of refining, 511  
— — furnace, 501  
— — refining, 498  
— — sampling, 48  
— — —, punch, 48, 498  
— —, selling price of, 511

- Base bullion, skimming of, 503  
 — — softening, 500  
 — — metal ores, 4  
 Bases, action of in slags, 481  
 Basic Bessemer process, 326  
 — copper converter lining, 402  
 — iron, 313  
 — open-hearth charge calculation, 335, 336  
 — —, chemistry of, 337  
 — — operation, 336  
 — — process, 334  
 — refractories, 37  
 Battery, stamp, 125  
 —, ten-stamp, 127  
 Bedding lead ores, 467, 469  
 — ores, 40  
 — system, Messiter, 361  
 Beehive coke, 319  
 Belgium zinc-smelting furnace, 529  
 Belmont Milling Co. flow sheet, 266  
 — — — mill, 265  
 — — — refinery, 268  
 Belt conveyor, 559  
 Betts process, 511  
 Bessemer pig, 315  
 — — process (acid), 321  
 — — — (basic), 326  
 Black copper smelting, 359  
 Blanket or canvas tube, 114  
 Blake crusher, 51, 52  
 Blast, dry air, 305  
 — or pot roasting of ores, 110, 286  
 — roasting of galena, 110  
 — — pot, 111  
 Blast-furnace, 72, 287, 289, 290, 291, 292, 298, 305  
 — accessories, 367  
 — burdening, 310  
 — combustion, 76, 305  
 — conditions (copper), 369  
 — copper matting, 369  
 — heat-balance, 309  
 —, iron and accessories, 298  
 —, —, operation of, 300, 302  
 — irregularities, 302  
 —, open and closed top, 475  
 — operation, 371  
 — plant for copper ores, 355, 356, 369  
 — — for iron, 287, 288  
 —, showing temperatures, 305  
 —, silver-lead, 471, 472, 473  
 —, —, products of, 487  
 Blast, smelting and converting plant, 406, 407, 408  
 —, — of copper slag, 357  
 —, — — — sulphides, 360, 369  
 —, — — precipitate, 188, 262  
 — tap jacket, 474  
 — tuyere, 274  
 — *vs.* reverberatory, 385  
 Blende, roasting of, 519  
 Blister copper refining, 442  
 Blower, positive blast, 368, 369  
 Blowing engine, 299  
 — — silver-lead blast-furnace, 476  
 — — the iron blast-furnace, 301  
 Bone ash, 37  
 Bosh and molds, 8  
 Boss process of silver milling, 243  
 Bottoms, treatment of, 389  
 Box, zinc or extractor, 181  
 Braun disk grinder, 42, 44  
 Brick kiln, 33  
 — making, 33, 35  
 — mold, 35  
 — repressing machine, 36  
 Bricks, 32  
 —, silica, 32  
 Briquetting flue dust, 489  
 — ores, 287  
 Bromo-cyanide process, 149  
 Brown agitating tank, 158  
 — iron ores, 285  
 — -O'Hara roasting furnace, 97  
 Brunton's quartering shovel, 42  
 — roasting furnace, 107, 108  
 Belt elevators, 557  
 Bins and pockets, 563  
 Bitumite, 12  
 Buchart concentrating table, 115  
 Buggy, charging, 551  
 Burdening the iron blast-furnace, 310  
 Business of metallurgy, 578  
 Butte-Duluth mill, 431  
 — process, 430  
 Butter's vacuum-leaf filter, 168  
 — filter frame, 169  
 By-product coke, 20, 21, 22  
 — — plant, 22

## C

- Calcination, 88  
 Calculations of charge in pyritic smelting, 381

- Calculations of charge in reverberatory smelting, 397  
 — — — — silver-lead smelting, 484  
 — — of mill tonnage, 223  
 Caldecott diaphragm cone, 69  
 Callow flotation machine, 117  
 Calorimeter, Mahler bomb, 80  
 Calorimetry, 85  
 Canvas table, 114  
 Capacity of roasting furnace, 109  
 Capital expenditure, 592  
 — involved, 591  
 — requirements, 591  
 Carbon brick, 38  
 — in pig iron, 316  
 Carbonate iron ores, 285  
 Carriage and test, English cupelling furnace, 509  
 Cars, hopper, 554  
 —, industrial, 553  
 —, side-dump, 553, 554  
 —, transfer, 554  
 Casting copper, 8  
 — gold, 7  
 — iron and steel, 8  
 — lead, 8  
 — machine, endless mold, 414, 445  
 — —, Walker, 447  
 — silver, 7  
 — zinc, 9  
 Castings, steel, 346  
 Cast iron, 318  
 — — mold, 318  
 Centrifugal belt, 507  
 Chamotte, 35  
 Characteristics of lead ores, 461  
 — — silver ores, 231  
 Chimneys or stacks, 78  
 Charcoal, 16  
 —, by-product, 17  
 — in silver-lead smelting, 484  
 —, pig iron, 315  
 Charge calculation for the iron blast-furnace, 310  
 — — acid open-hearth process, 333  
 — — basic open-hearth process, 339  
 — — blast-furnace matte smelting, 375, 381  
 — — iron blast-furnace, 312  
 — — reverberatory smelting, 397, 398  
 —, reverberatory copper furnace, 393  
 — scoop, zinc smelting, 534  
 Charges, administration and general, 594  
 —, realization, 594  
 Charging buggy, 551  
 — iron blast-furnace, 294  
 — lead ores, 567  
 — machine, copper, 446  
 — —, open: hearth, 333  
 Chemical reactions of the basic open-hearth process, 337  
 — — — — copper converter, 404  
 — — — — iron blast-furnace, 479  
 — — in the silver-lead blast-furnace, 479  
 Chemistry of roasting, 89, 92  
 — — the cyanide process, 146, 264  
 Chilian mill, 60  
 Chloridizing blast roasting, 249  
 — roaster, MacDougall, 428  
 — —, Wedge, 424  
 — roasting, 88  
 — — of silver ores, 246  
 — — — — —, remarks on, 248  
 Chlorination barrel, 137, 138, 139  
 — mill, Goldfield, 136  
 — of concentrates, 135  
 — — copper ores, 422  
 — — gold ores, 135  
 —, ores suited to, 135  
 — or Plattner process, 133  
 —, precipitation plant for, 141  
 Chromite or chrome iron ore, 34  
 City Deep mill, 191  
 Clarifying solutions, 176  
 Classification and definition of ore, 3  
 — of iron ores, 283  
 — — metallurgical operations, 5  
 — — natural solid fuels, 13  
 — — pig iron, 314  
 Classifier, 68  
 —, Akins, 69, 70  
 —, Allen cone, 69, 70  
 —, Caldecott diaphragm cone, 69  
 —, Dorr, 56, 69, 71  
 Classifying, 66, 68  
 — gold mill concentrates, 213  
 — of gold ores for milling, 122  
 Clayey gold ore, cyaniding, 189  
 Cleaning iron furnace gases, 295  
 Clean-up, 129  
 — of zinc boxes, 182  
 — pan, 128, 129  
 Coal-fired reverberatory furnace, 391  
 Coals for roasting, 14

- Coals in the United States, composition of, 13
- Coarse grinding, 55  
— or primary crushing, 51, 265
- Cobalt milling practice, 274
- Coke, 18  
— ash, 18  
—, costs of making, 23  
—, beehive, 19  
—, composition of, 18  
— in silver-lead smelting, 483  
— oven, by-product, 20, 22  
— plant, by-product, 22  
— pusher and leveler, 22
- Colorado lead ores, price of, 483, 495
- Combined mechanical and pneumatic agitators, 160
- Combustion, 75  
— in air, 76  
— — the blast-furnace, 76, 77  
— of fuel, 81  
—, principles of, 75  
—, temperature of, 79, 82
- Comminution of ore, 62
- Comparative agitator data, 187
- Composite costs, 575
- Composition of copper matte, 372
- Compressed-air locomotive, 552, 553
- Concentrate, chlorination of, 135  
—, sampling of, 45  
— treatment at Goldfield Cons. mill, 218
- Concentrating table, Burchart, 115  
— —, Wilfley, 115
- Concentration, 114, 265  
— in stamp milling, 131  
— prior to cyaniding, 143
- Concrete floors, unit costs, 573  
— foundation, unit costs, 572
- Condensers for zinc smelting, 536
- Conical mold, 8
- Coning and quartering, 41
- Consolidated Langlaaghte mill, 193
- Construction of plant, 550  
—, unit costs of, 572  
—, winter work, 570
- Continuous counter-current decantation, 166, 168  
— grinding pan, 237  
— handling of materials, 557  
— thickener, Dorr, 163
- Conversion of white metal, 405
- Converter, acid-lined, 323  
— and mixer building, 326, 341  
—, copper, Smith-Pierce, 401, 403  
—, — (upright type), 401  
—, —, treater for, 413  
—, electrolytically operated, 323  
— lining, copper, 402  
— — (steel), 322
- Converting copper matte, 400, 403, 405  
— leady matte, 492
- Conveying, 365
- Conveyor, belt, 559  
—, discharge, 559  
—, endless chain, 561  
—, incline to level, 561  
—, screw, 559  
— tripper, 561
- Copper and copper ore prices, 457  
— -bearing gold ores, 145  
— blast-furnace conditions, 369, 371  
— — plant, 355  
— — smelting of oxidized ores, 355  
— — — — slags, 357  
— casting, 9  
— — machine, 414, 445, 447  
— charging machine, 446  
— converter, 400  
— converting, losses in, 405  
— electrolytic tank, 450  
— extraction from its ores, 352  
— furnace slags, 374  
— in silver-lead smelting, 483  
— leaching, Ajo process, 432  
— —, ammonia process, 438  
— —, Butte-Duluth process, 430  
— —, Henderson process, 423  
— —, Laist process, 426  
— — plant, 440  
— —, Rio Tinto process, 418  
— —, Shannon process, 421  
— —, sulphuric acid, 429  
— matte, 373  
— —, composition of, 374  
— — converter, 400, 401, 402, 403  
— —, converting, 400  
— matting blast-furnace, 363, 364, 369, 370  
— — —, jackets for, 365  
— — — operation, 371, 373  
—, native, 352  
— ores and their treatment, 351, 417  
— —, characteristics of, 351

- Copper ores, hydrometallurgy of, 354  
 —, pyrite smelting, 354  
 —, smelting for matte, 353  
 —, properties of, 353  
 — refining, 442, 449  
 —, costs of operation, 455  
 —, electrolytic, 449  
 — furnace, 443  
 — reverberatory smelting, 387  
 Costs accounts, 594  
 — and profits, 597  
 —, composite, 575  
 —, general, 592  
 —, kinds of, 593  
 — in zinc smelting, 538  
 — of administration, 592  
 — agitation, 187  
 — concentration in milling, 132  
 — construction, unit, 572  
 — copper furnace plant, 414, 415  
 — refinery, 455  
 — operation, 455  
 — cyaniding on the Rand, 155  
 — silver-bearing concentrate, 277  
 — dissolution by slime agitation, 186  
 — filtration or decantation, 187  
 — lead ores, 494  
 — making coke, 23  
 — metallurgical plants, 571  
 — Homestake plant, 156, 198  
 — operating copper works, 414, 416  
 — plant and equipment, 569  
 — production, 571  
 — of pig iron, 348  
 — steel, 348  
 — Rand cyaniding plants, 156  
 — rebuilding, 570  
 — refining base-bullion, 511  
 — roasting, 109  
 — sampling, 45  
 — silver ores, 280  
 — slime plants, 186  
 — treatment, Belmont-Tonopah mill, 227  
 — Homestake mill, 227  
 — Modderfontein mill, 227  
 — United Eastern mill, 211  
 Cottrell treater, 409, 413  
 Counter-current agitation, 165  
 Cowper hot-blast stove, 297  
 Crane ladle, 406  
 —, track (and grab bucket), 555  
 Crane, traveling, 556  
 Crowe vacuum process, 177  
 Crusher, Blake, 51, 53  
 —, gyratory, 52, 53  
 —, Symons, 61, 62  
 Crushing, action of machines in, 50  
 — and screening, dry, 64  
 — — —, —, flow sheet for, 64  
 —, coarse or primary, 51  
 —, fine, 55  
 —, grinding, screening and classifying, 50  
 — ores, 40  
 —, principles of, 50  
 — rolls, 58, 59  
 Cupelling furnace, 508  
 — rich lead, 507  
 — silver precipitate, 262  
 Current flow, electromagnetic, Walker multiple system, 451  
 —, testing, 454  
 Custom smelters, 598  
 Cupola furnace, 73, 77  
 —, combustion in, 77  
 Cyanide process, 133  
 —, chemistry of, 146  
 — solution, strength of, 146  
 Cyaniding concentrator, 221  
 —, double treatment in, 113  
 — free milling ores, 189  
 — mixed silver ores, 268  
 —, outline of process, 143  
 —, sand leaching in, 151  
 —, silver-bearing concentrates, 277  
 — silver ores, principles of, 256, 264  
 —, systems of, 150, 223  
 Cylinder drier, 100
- D
- Daily wages and premium, 590  
 Decantation in cyaniding, 157  
 —, continuous counter-current, 165  
 —, costs of, 187  
 —, intermittent, 168  
 Definition of metallurgical thermochemistry, 84  
 — straight or simple ores, 3  
 Definitions and classification of ores, 3  
 Dehne filter press, 171  
 Deister concentrating table, 115  
 Department, administration, 584  
 — operating, 585

Department, purchasing and selling, 595  
 Depreciation, 592  
 Desilverizing base-bullion, 276  
 Desulphurizing process at Nipissing, 276  
 Dezincing furnace, 505  
 Ding's magnetized pulley, 566  
 Dip samples, 46  
 Direct process of reverberatory smelting, 390  
 Disks of Symons crusher, 62  
 Disposal of pig iron at iron blast-furnace, 304  
 — — slag at copper furnace, 384  
 — — — iron blast-furnace, 303  
 Distillation of zinc, 540  
 — of zinc ores, 528  
 Distribution accounts, 592  
 — of wealth, 579  
 Dolomite, 37, 482  
 Dorr agitator, 160  
 — bowl classifier, 69, 71  
 — classifier, 56  
 — continuous thickener, 163, 164  
 — — —, showing slime zones, 164  
 Double strand elevator, 558  
 — treatment in cyaniding, 158  
 Dressing the zinc boxes, 184  
 — the plates of the stamp battery, 128  
 Dry air blast, 305  
 — crushing and screening, 64  
 — — — — flow sheet, 65  
 — silver milling (Reese River process), 249  
 Dryer, cylinder, 100  
 Drying and refining the gold precipitate, 184  
 — — — — — at United Eastern plant, 185  
 — — — — silver precipitate, 261  
 Duties of foreman, 586  
 — — superintendent, 585  
 Duplex and electric furnace plant, 341, 342  
 — process of steel making, 340  
 Dwight-Lloyd sinter roasting machine, 110, 112

## E

Economic situation, 579  
 — — in the United States as related to metals, 580  
 Economics of engineering, 579  
 Edwards roasting furnace, 97, 100

Efficiency of men, 587  
 Electric furnace and control panel, 349  
 — — — duplexing plant, 341  
 — — building, 344  
 — — for steel making, 342, 344  
 — — smelting of silver precipitate, 262  
 — — showing lining and bottom connection, 344  
 — lighting, unit costs of, 573  
 — locomotive, 551, 552  
 — steel making, 342  
 — transformer and substation equipment, 344  
 — trolley removing slag, 384  
 Electrically operated converter, 323  
 Electrolyte, circulation of, 454  
 — copper, 451  
 Electrolytic copper refinery, 449  
 — — refining, 449  
 — parting of silver and gold bullion, 279  
 — refining of lead, 511  
 — tank, 450  
 — zinc, 542  
 — — process, 542  
 Electrostatic Cottrell treater, 409, 410  
 — recovery of smelter dust, 410  
 Elements, heat of formation of, 87  
 Elevators, 566  
 —, belt, 557  
 —, feeding, 558  
 —, single and double strand, 558  
 Elimination of impurities (copper converting), 405  
 Employers, association of, 583  
 Endless-chain conveyor, 561, 562  
 — -mold casting machine, 445  
 Engineering, economics of, 579  
 English cupelling furnace, 508  
 Equipment, obsolete, 593  
 — of plants, 551  
 Excavators, 555  
 Expenditure of capital, 592  
 Extraction of copper as chloride, 422  
 — — — by leaching, 418  
 — — — — smelting, 353  
 — — — from ores, 352, 353, 418  
 Extraction of gold with solvents, 133, 134  
 — — silver from ores, 231

## F

Faber du Faur retorting furnace, 508  
 — — — tilting furnace, 263, 508

- Feed, removal of wood and tramp iron  
from, 565
- Feeders, ore, 563
- , —, and shaking screen, 564
- , —, hammer, 565
- , —, moving, 564
- , —, reciprocating, 565
- , —, rotary, 564
- , —, traveling, 564
- Filter, American continuous suction, 170,  
171
- frame, Butters, 169
- , Oliver, continuous suction, 170
- press, Dehne, 171, 172, 173
- , —, Kelly, 171, 172
- , —, Sweetland, 173
- slime treatment, 157
- Filters, general remarks on, 175
- Filtration, 166
- , costs of, 187
- , vacuum, 168
- Financial crises in the United States, 583
- Fine ores, agglomeration of, 286
- Finishing the sample, 45
- Fireclay, firebrick and tile, 34
- Flame temperature, 80
- Flotation, 116
- machine, Callow, 116
- , —, Janney, 116
- , —, Minerals Separation, 116
- Flowsheet of Alaska-Treadwell mill, 216
- — Hollinger mill, 216
- — Tom Reed mill, 208
- — Waihi Grand Junction mill, 271
- Flue dust, briquetting, 489
- , —, treatment of, 489
- Fluorspar for slags, 482
- Fore-hearth or settler, portable, 366, 367
- — —, stationary, 368
- Foreman, duties of, 586
- Foundry pig, 315
- Fractional selection, 41
- Free milling ores, milling of, 189
- Frenier pump, 568
- — installation, 568
- Frue Vanner, 115
- Fuels, 11
- and fluxes, purchase of, 595
- , artificial, 11
- , combustion, 81
- in silver-lead smelting, 483
- — the open-hearth furnace, 332
- Fuels, natural, 11
- , oil or petroleum, 15
- Furnace and stoves iron, 298
- , blast, 72, 287, 298
- , cupola, 73
- , hand reverberatory, 74, 96
- , mechanically operated (roasting), 97
- , natural draft, 76
- , reverberatory, 73, 74, 96
- , revolving roasting, 97
- shaft, 72
- , softening, 501
- , Wedge roasting, 424
- , wind, 72, 77
- zinc smelting, 529, 530, 531, 532

## G

- Galena ores, 461
- Ganister, refractory, 32
- Gas cleaning at the iron blast-furnace, 295
- , natural, 15
- , producer, 23
- , — plant, 25, 26, 27
- Gases, metals and physical constants, 6
- , specific, heat of, 80
- Gasoline locomotive, 552, 553
- Gate for ore bin, 564
- General arrangement of gold stamp mill,  
130
- — — an iron blast-furnace plant, 312,  
313
- economic situation, 579
- remarks on filters, 175
- Genesis of natural fuels, table of, 11
- Gjiers calcining kiln, 286
- Gold, amalgam retorting, 129
- and silver, valuation of, 122
- bars or ingots, sampling, 48
- casting, 7
- mill concentrates, treatment of, 213
- , —, the City Deep, 191
- , —, — Victorious, 190
- milling practice, 189
- ores, amalgamation of, 123
- — and classification for milling, 121
- , —, antimony, 145
- , —, arsenical, 145
- , —, chlorination of, 135
- , —, copper-bearing, 145
- , —, graphite, 145
- , —, hydrometallurgy of, 133
- , —, occurrence of, 121, 133

Gold ores, prices, 227  
 — —, pyritic, 145  
 — —, silicious, 145  
 — —, smelting, 226  
 — —, talcose or clayey, 145  
 — —, tellurides, 145  
 — —, physical properties of, 121  
 — refining, 280  
 — tellurides, 121  
 Golden Cycle flow sheet, 201  
 — — mill, 201  
 Goldfield chlorination mill, 136  
 — Consolidated mill, concentrate treatment at, 218  
 Grab-bucket and track crane, 555  
 Grabs and excavators, 555  
 Grading ores, 5  
 — pig iron, 315  
 Graphite, 13, 15, 34  
 — -bearing gold ores, 223  
 Great Falls copper converter, 401  
 Grinding and classifying on the Rand, 192  
 —, coarse, 55  
 — pan, continuous, 237  
 Grizzly, 66  
 Gyrotory crusher, 52, 53, 54

H

Hammer feeder, 465  
 Hand reverberatory furnace, 74  
 — sampling, 41  
 Handling of materials, continuous, 557  
 Hardinge conical ball mill, 57  
 Heap roasting, 92  
 — — of matte, 94  
 Hearth and bosh, iron blast-furnace, 292  
 Heat balance of the blast-furnace, 309  
 — evolved in roasting, 87  
 Heats of formation of the elements, 86  
 — — — — —, table of, 86, 87  
 Hegeler roasting furnace, 97, 521, 523  
 Hematite, 283  
 Henderson process, 423  
 Hendryx agitator, 160  
 Heyl & Paterson pig-casting machine, 304  
 High-grade Nipissing mill, 243  
 Hoists, industrial, 553, 554  
 Holbeck powdered coal system, 30  
 Hollinger mill, 205  
 — — flow sheet, 206  
 Homestake mill (cyanide), 195  
 — — sand plant, 195, 196

Homestake mill slime plant, 197  
 — — — treatment costs, 198  
 — plant (cyanide), cost of, 156, 198  
 Hopper cars, 554  
 Horizontal copper converter, 400  
 — — —, Pierce-Smith type, 403  
 Hot blast stove, 295, 297  
 — metal mixer, 321, 322  
 — solutions in cyaniding, 144  
 Howard mixer, 502  
 — press, 504  
 Hughes gas producer plant, 25  
 Hydrometallurgy of copper ores, 354, 417  
 — — gold ores, 133  
 — — silver ores, 250  
 Hyposulphite lixiviating of silver ores  
 (Von Paterra process), 254

## I

Impact screen, 66, 67  
 Impurities, elimination of in copper converting, 409  
 — in metals, 5  
 Inadequate equipment, 593  
 Incline conveyor, 561  
 Indicating pyrometer, 83  
 Industrial cars and hoists, 553  
 — locomotives, 551  
 Influences of elements on pig iron, 316  
 Ingot copper, section of bar, 49  
 — mold, 324  
 Inside men, morale of, 588  
 Intermediate crushing, 55  
 Intermittent decantation, 168  
 — handling of materials, 551  
 International Smelting Co., reverberatory  
 smelting and converting plant,  
 413  
 — — —, roaster plant, 411, 412  
 Iron and steel, 281  
 — — — casting, 8  
 Iron blast-furnace, 287, 289, 290, 291, 292,  
 305  
 — — and accessories, 298  
 — —, burdening, 310  
 — — charge sheet, 312  
 — — charging, 294  
 — —, chemical reactions of, 306, 307  
 — —, detailed section, 291, 305  
 — — plant, 287, 288, 289, 295  
 — —, showing temperatures, 305  
 — — with automatic charging, 290



Iron ore, action of in slags, 481  
 — — and its smelting, 283  
 — —, classification and occurrence, 283  
 — —, prices of, 347  
 — — roasting, 285  
 Irregularities of blast-furnace operation,  
 302

## J

Jackson centrifugal pump, 567  
 Janney flotation machine, 117  
 Jones sampler, 42

## K

Kalgoorlie district, 203  
 Kelly filter press, 171  
 Kennicott plant for ammonia leaching, 440  
 Kiln roasting, 86, 286  
 Koppers by-product coke oven, 22

## L

Labor situation, 580  
 —, union and non-union, 580  
 —, unit costs for, 594  
 Ladle cars, 367  
 — crane for copper, 406  
 —, worm-gear, bottom-tapped, 324  
 Laist process, 426  
 — — mill, 425, 427  
 Lake copper refining, 444  
 Large copper matting blast-furnace, 369  
 Leaching (copper), Ajo process, 432  
 — —, ammonia process, 438  
 — —, Butte-Duluth process, 430  
 — — ores, 417  
 — plant, Henderson process, 423  
 — —, Laist process, 425, 426, 427  
 — the sands in cyaniding, 153  
 — vats in cyaniding, 151  
 Lead, blast-furnace, 471, 472, 473, 475  
 —, —, charge, 484  
 —, casting, 9  
 — copper matte, 491  
 — — —, treatment of, 491  
 — ores, carbonates, 462  
 — —, classes of, 461  
 — —, costs of smelting, 494  
 — —, oxidized, 462  
 — —, penalties on, 496  
 — —, prices, 495  
 — —, properties of, 461

Lead ores, receiving, sampling, and bed-  
 ding, 467  
 — —, treatment of charge, 495  
 —, properties of, 461  
 — refinery, 499  
 Liberty Bell mill, 199, 200  
 Limestone for slags, 482  
 Lining of copper converter, 402  
 Location of plants, 547  
 Locomotives, industrial, 551  
 Long-hearth reverberatory roaster, 95, 96  
 Loomis-Pettibone gas apparatus, 27  
 Losses in copper converting, 406  
 — — zinc smelting, 537

## M

McArthur-Forrest process, 133  
 MacDougall roasting furnace, 101, 102,  
 104  
 Machine or automatic sampling, 42  
 Machinery, costs of creation, 573  
 — prices, 571  
 Magnesite, 37  
 Magnetite, 284  
 Magnetized pulley for removal of tramp  
 iron, 566  
 Mahler bomb calorimeter, 80  
 Main systems of filtering, 168  
 Maintenance and repairs, 593  
 Making of steel, 320  
 Malleable iron pig, 315  
 Manganese, action of in slags, 482  
 — in pig iron, 316  
 Manufacture of steel, 320  
 — — wrought iron by puddling, 318  
 Market lead, molding, 506  
 Martin sampling machine, 47  
 Materials in intermittent handling, 551  
 Matte (copper), 373  
 —, heap roasting of, 94  
 —, leady copper, 491  
 —, — — converting, 492  
 —, roasting, 108  
 —, selling price of, 492  
 — smelting charge, 375, 381  
 — — (concentration), 383  
 — — of copper ores, 354, 360, 371  
 Mechanical agitators, 159  
 — open-hearth charging, 333  
 — roasting furnaces, 97  
 Melting and refining Lake copper, 444  
 Men, care of, 588

Men, efficiency of, 587  
 Merrill filter press, 174  
 — — — frame, 174  
 — — — installation, 173  
 — — — plate, 174  
 — precipitation apparatus, 178  
 — — process, 178  
 Mercury fed to the stamp battery, 126  
 Merton roasting furnace, 97, 525, 526  
 Messiter bedding system, 361  
 Metallurgical furnaces, 72  
 — operations, classifications of, 5  
 — thermo-chemistry, 84  
 — —, classification of, 84  
 — —, units of measurement, 84  
 Metals and gases, physical constants for, 6  
 —, impurities in, 5  
 —, molding and casting, 7  
 Methods of treatment, 4  
 Mexican amalgamation process, 249  
 Mill amalgamation and concentration, 245  
 —, Belmont, 265  
 —, Chilian, 60  
 —, Consolidated Langlaaghte Co., 193  
 —, Golden Eagle, 201  
 —, Hollinger, 205  
 — iron, 314  
 —, Liberty Bell, 199, 200  
 —, Nipissing Co.'s low-grade, 274  
 — — high-grade, 243  
 —, Oroyo Brownhill, 204  
 — samples, 46  
 — sites, 549  
 —, stamp, 55  
 —, Tom Reed, 207  
 —, tube, 64  
 —, United Eastern, 209  
 —, Victor, 202  
 —, Waiki Grand Junction, 270  
 —, — — — flow-sheet, 271  
 —, Wasp No. 2, 187  
 Milling, dry silver, 249  
 — gold ores in solutions, 133  
 — ores, 598  
 — practice at Cobalt, 274  
 Mills, typical silver, 265  
 Minerals Separation flotation machine,  
 116  
 Mixed gas producer, 24  
 — ores, definition of, 3  
 Mixer, hot metal, 321, 322, 341  
 Mixing pan, 324

Modes of payment, 589  
 Moisture samples, 40  
 Mold, cast-iron, 8  
 Molding and casting metals, 7  
 Multiple-hearth furnace, 101

## N

Native copper, 351  
 — gold, 121  
 Natural draft furnace, 76  
 — fuels, 11  
 — —, genesis of, 11  
 — gas, 15  
 — solid fuels, 12  
 — — —, classification of, 12  
 Neglect of equipment, 593  
 Neutral refractories, 31  
 Newnam ore hearth, 465  
 Nipissing Co.'s low-grade mill, 274  
 — — mill, flow-sheet of, 275  
 — — wet desulphurizing process, 276  
 — mill, high-grade, 243  
 Nodulizing iron ores, 286

## O

Obsolete equipment, 593  
 Occurrence of gold ores, 115  
 — — iron ores, 283  
 Oil flotation, 116  
 Oliver continuous filter, 170  
 Open and closed-top blast-furnace, 475  
 Open-hearth furnace, 327, 328, 329, 330  
 — — building, 338, 339  
 — —, charging, 333  
 — —, — machine, 333  
 — — fuels, 332  
 — —, reversing valves for, 331  
 — —, steel-making in, 326  
 — —, tilting, 332  
 — —, with water-cooled devices, 329  
 — process (acid), 333  
 — —, (basic), 334  
 — —, (basic), operation, 336  
 — —, calculation, 336  
 — —, chemistry of, 337  
 — —, recarburization in, 337  
 Operating department, 585  
 — —, cyanide plant, 595  
 — —, forty-stamp mill, 595  
 — —, gold stamp mill, 595  
 — —, silver lead or copper smelting, 594  
 — —, typical, 594

Operation and organization, 584  
 — of basic converter, 403  
 — — copper blast furnace, 371  
 — — plant, 587  
 — — silver lead blast-furnace, 476  
 — — the acid-lined converter, 322  
 — — — iron blast-furnace, 300  
 — — zinc smelting furnace, 434  
 Ore bins and pockets, 563  
 — feeders, 563  
 — gate, 564  
 — hearth, 464  
 — storage and supply, 563  
 — treatment, 593  
 Ores and metals, 3  
 —, base metal, 4  
 —, copper, 351  
 —, definitions of, 4  
 —, gold, occurrence of, 121  
 —, grading of, 5  
 —, mixed, 3  
 —, preparation of, 39  
 —, receiving, 40  
 —, storing, 46  
 —, straight or simple, 3  
 Organization and operating, 584  
 Oroyo-Brownhill mill, 204  
 Outline of process of cyaniding, 143  
 Overstrom concentrating table, 115  
 Oxides and carbonates of copper, 352  
 Oxidizing roasting, 88  
 Oxland roasting furnace, 97

## P

Pachuca tank, 158  
 Painting, unit costs for, 574  
 Pan, clean-up, 129  
 Parkes process, 503  
 Parting silver and gold bullion, 278, 279  
 Path of travel of ore particles, 56  
 Patio process of silver amalgamation, 249  
 Pattison process, 510  
 Payment, modes of, 589  
 Penalties on lead ores, 496  
 Petroleum or fuel oil, 15  
 Phosphorus in pig iron, 316  
 Physical properties of gold, 121  
 Piece work, 589  
 Pig casting machine, 304  
 Pig iron, 314  
 — —, classification of, 314  
 — —, costs of production, 348

Pig iron disposal, 304  
 — — grading, 315  
 — —, influence of elements on, 316  
 — — prices, 347  
 — — sampling, 49  
 — —, smelting for, 287  
 Pittsburg pig iron, 315  
 Plan of furnaces and stoves, iron, 298  
 — — United Eastern mill, 210  
 Plant for duplex and electric furnace, 341  
 — — zinc smelting, 533  
 — operation, 587  
 Plants, construction of, 550  
 —, equipment and their costs, 546  
 —, location, 547  
 —, metallurgical, costs of, 571  
 —, sites, 548, 549  
 Plate amalgamation of good ores, 123  
 —, dressing, 128  
 Plattner process, 133  
 Plumbago, 34  
 — crucibles, 8  
 Pneumatic agitators, 158  
 Portable fore-hearth or settler, 366  
 Positive pressure blower, 368, 369  
 Pouring ladle, 324  
 — slag, 373  
 Power needed in crushing, 50  
 Practice in roll crushing, 50  
 Precipitate, blast-furnace smelting of, 188  
 —, gold, 184  
 Precipitation by aluminum dust, 261  
 — of gold from solutions, 177  
 — — silver from cyanide solutions, 257  
 Preliminary construction work, 570  
 Premium and daily wages, 590  
 Preparation of ores, 39  
 Pressure filtration, 108, 171  
 Prices of iron ores, 347  
 — — lead-silver ores, 494, 495  
 — — machinery, 571  
 — — pig iron, 347  
 — — raw materials, 575  
 — — silver and silver ores, 280  
 — — steel, 347, 348  
 — — zinc ores, 539  
 Principles of combustion, 75  
 — — crushing, 50  
 — — sampling, 39, 46  
 — — the hydrometallurgy of copper, 417  
 — — — — — silver, 250  
 — — thermo-chemistry, 84

- Principles relating to the refining of metals, 5
- Producer gas, 23
- , costs, 28
- , mixed, 24
- , plant, 25
- , simple, 23
- Production and costs, 591
- — prices of lead-silver ores, 494
- Products of silver-lead blast furnace, 487
- Profit-sharing, 590
- Profits and costs, 595
- of treatment of silver-lead ores, 496
- Properties of copper, 363
- — lead and its ores, 461
- Proportions and efficiency of ball mill, 56
- Puddling furnace, 319
- process, 318
- —, reactions in, 319
- Pug mill, 490
- Pulp sampler, 47, 48
- Pulverized coal, 29
- — distributing system, 30
- — -fired reverberatory furnace, 392
- — in silver-lead smelting, 484
- Pumps, Frenier sand, 568
- , high-pressure triplex, 568
- , three-throw, 567
- Purchase of fuel and fluxes, 595
- Purchasing and selling department, 595
- Pyrite gold ores, 145
- smelting, calculation of charge, 381
- — of copper ores, 354, 377, 379, 383
- —, section of furnace, 379
- Pyrometer, indicating, 83
- Q
- Quartering an ore in sampling, 41
- and coning, 41
- shovel, Brunton's, 42
- R
- Rand cyaniding costs, 155
- plants, costs of, 156
- practice, steel tanks for, 194
- Raw material prices, 575
- Raymond roller-mill, 29
- Reactions in copper reverberatory smelting, 397
- — puddling process, 319
- — pyrite matte smelting, 378
- Reactions in sinter roasting, 113
- Realization charge, 594
- Rebuilding, cost of, 570
- Recarburization in open hearths, 337
- Receiving ores, 40
- , sampling and bedding lead ores, 467
- Reciprocating feed, 465
- Reclaiming machine, Robbins-Messiter, 362
- Recovery of smelter dusts, 410
- — sulphuric acid, 527
- Reduction charges, 593
- Reese River dry process of milling, 249
- Refinery, lead, 499, 513
- , Santa Gertrudis, 260
- Refining furnace for copper, 443
- in a cupelling furnace, 184
- lead and base bullion, 498
- of copper, 442
- — metals, principles relating to, 5
- silver precipitate, 259, 261
- with potassium bichromate, 184
- zinc, 540, 542
- Refractories, 31, 38
- , acid, 31, 32
- , basic, 31
- , neutral, 31
- Refractory materials, properties of, 131
- Regenerating plant (copper refining), 453
- Regular operation of the iron blast-furnace, 302
- Rents, taxes and royalties, 594
- Repair and maintenance costs, 593
- force, 586
- Replacements, 592
- Reports, 594
- Repressing machine, brick, 36
- Requirements of capital, 591
- Research work, 586
- Retort and furnace for silver mill, 242
- manufacture, 536
- Retorting furnace, Faber du Faur, 508
- gold amalgam, 129
- Retorts for zinc smelting, 535
- Reverberatory copper smelting, methods of, 385, 387, 390, 397
- — —, Welsh process, 387, 388, 389
- furnace, 73, 74, 327, 387
- Reverberatory furnace, open-hearth, 327
- roaster, long hearth, 95, 96
- smelting and converting plant, 412, 413
- —, direct process, 390

- Reverberatory smelting furnace, 387  
 ———, charge, calculations, 398  
 ———, coal-fired, 391  
 ———, method of charging, 392  
 ———, oil-fired, 394, 395  
 ———, pulverized-coal fired, 392  
 ———, smelting reactions, 397  
 — vs. blast-furnace smelting, 388  
 Reversing valves, open-hearth furnace, 331  
 Revolving eccentric gas-producer plant, 26, 27  
 — screen or trommel, 68  
 Rich lead, 507  
 —, cupelling, 507  
 —, treatment of, 507  
 Ridge roasting furnace, 525, 526  
 Rio Tinto process, 418  
 Rules of works, 587  
 Run-of-mine ore, size of, 50  
 Russell process for silver ores, 254  
 Roaster plant, 106  
 Roasting, 88  
 —, blast or pot-, 110  
 — blende, 519  
 —, chemistry of, 89  
 —, chloridizing, 88  
 —, coal for, 18  
 —, cost of, 109  
 — furnace, Argall, 97  
 —, blende-, 521, 522  
 —, Brown horseshoe, 98  
 —, Brown-O'Hara, 97  
 —, Brunton, 107, 108  
 —, cylinder, 98  
 —, Edwards, 97, 100  
 —, Hegeler, 97, 521, 523  
 —, long-hearth reverberatory, 95, 96  
 —, MacDougall, 101, 104  
 —, Merton, 97, 524, 525  
 —, Oxland, 97  
 —, Pierce turret, 98  
 —, Ropp, 97  
 —, Wedge, 103, 105, 106  
 —, Wethey, 97  
 —, White-Howell, 97, 99  
 — furnaces, capacity of, 109  
 —, heap, 92  
 —, —, chemistry of, 92  
 —, heat evolved in, 87  
 — in kilns, 88, 285  
 — — the Welsh process, 389  
 Roasting iron ores, 285  
 —, losses in, 108  
 — of matte, 92  
 — ores in pulverized condition, 94  
 —, oxidizing, 88  
 —, sinter, 88  
 —, sulphatizing, 88  
 —, triple, 113  
 — zinc ores, 519  
 — — —, chemistry of, 519  
 Robbins-Messiter reclaiming machine, 362  
 Roller mill, Raymond, 29  
 Rolls, crushing, 58, 59  
 Roofing, unit costs of, 574  
 Ropp roasting furnace, 97  
 Rotary feeder, 464
- S
- Sample finishing, 45  
 — grinding mill, 42  
 — mill, 46  
 —, moisture, 41  
 Sampler, Jones, 42  
 —, pulp, 47  
 —, tailings, 46  
 —, Vezin, 43  
 Sampling concentrates, tailings and ore pulps, 45  
 — copper ingots and anodes, 49  
 —, cost of, 45  
 —, hand, 41  
 — iron ores, 46  
 — lead ores, 467  
 — machine, Martin, 47  
 — metals, 48  
 — mill, 43, 44  
 — ores, 40, 265  
 — — containing metallics, 45  
 — pig iron, 49  
 —, principles of, 39, 46  
 —, split shovel, 41  
 Sand leaching in cyaniding, 151  
 —, treatment costs, 198  
 — plant, Homestake, 147  
 — pump, Frenier, 568  
 —, refractory, 32  
 San Francisco silver mill, 266  
 Santa Gertrudis refinery, 260  
 Schedule for copper and copper-ore prices, 467  
 Screen impact, 66

- Screen, revolving, or trommel, 68  
 —, sizes, 51  
 — tension, 67  
 Screening, 66  
 Screw conveyor, 559, 560  
 Scrubbers for stoves and boilers, 296  
 Section of bar or ingot copper, 49  
 Selling department, 595  
 Semet-Solvay by-product coke oven, 21  
 Separation of slime from solutions, 166  
 Settler, eight-foot, 240  
 — or fore-hearth, portable, 366  
 — — —, stationary, 368  
 Shaft furnace, 12  
 Shafting, pulleys, and belting, unit costs for, 574  
 Shaking screen and feeder, 564  
 Shannon Copper Co. process, 421  
 Sharing profits, 590  
 Side-discharge car, 554  
 — -dump car, 553  
 Silica brick, 32  
 Silicates of copper, 352  
 Silicious gold ores, 145  
 Silicon in pig iron, 316  
 Silver bars or ingots, sampling, 48  
 — casting, 7  
 —, distribution of in a bar of base bullion, 49  
 — extraction from ores, 232  
 — -gold bullion parting, 278, 279  
 — ores, prices of, 280  
 — -lead bag-house, 488  
 — — blast-furnace, 471, 472, 473, 477  
 — — —, chemical reactions in, 479  
 — — — smelting, 467  
 — — — and refinery, 513  
 — — — plants, location of, 548  
 — — —, pulverized coal for, 484  
 — — —, slags for, 480  
 — — ores, profits of treatment, 496  
 — — works, 468, 471  
 — milling, Boss process, 242  
 — — by Augustin process, 250  
 — — — hydrometallurgical processes, 250  
 — — — Ziervogel process, 251  
 — —, dry, 249  
 — —, wet, 235  
 — mills, retort and furnace for, 242  
 — —, typical, 265  
 — — with tank settling, 236  
 — ores and treatment, 231, 232
- Silver ores, amalgamation and concentration, 244  
 — —, characteristics of, 231  
 — —, chloridizing roasting of, 246  
 — —, cyanidation of, 256, 268  
 — —, hyposulphite process, 254  
 — —, Russell process, 254  
 — precipitate, drying and refining, 261, 263  
 — —, melting in tilting furnace, 262  
 — —, smelting of, 262  
 —, precipitation of, from solutions, 257  
 — refining furnace, Faber du Faur, 263  
 — — —, Monarch-Rockwell, 263  
 — — —, Steel-Harvey, 263  
 Simple ores, definition of, 3  
 Single-strand elevator, 558  
 Sinter building, 470  
 — charge, 470  
 — roasting, 88, 110  
 — — machine, 110  
 — —, reactions, 113  
 Sintering ores, 470  
 Situation, general economic, 579  
 Sizes of screens, 51  
 Sizing tests on sand residue, 154  
 Skimmer, base bullion, 505  
 Skip car, 555  
 Slag pot, side-dumping, 478  
 — —, two-wheeled, 367  
 Slags, 480  
 —, actions of bases in, 481  
 —, ladle and locomotive at iron furnace, 303  
 — or cinder disposal at iron furnace, 303  
 —, pouring (copper blast-furnace plant), 373  
 Slime agitation, 157  
 — cake, partly removed from filter, 170  
 — plants, costs, Homestake, 198  
 — —, — of, 186, 198  
 —, refinery, 452  
 —, separation from solution, 166  
 — treatment by filter, 157  
 Sliming, all, 157  
 Smelteries, custom, 598  
 Smelting by the Welsh process, 388  
 — copper ores, 353  
 — for pig iron, 287  
 — — — —, outline of process, 287  
 — on the ore hearth, 463  
 — of copper slag, 357

- Smelting of gold ores, 226  
 — — lead ore, 463  
 — — silver-lead ores, 467  
 — plant for copper ores, 355, 356  
 — silver precipitate, 262  
 — to black copper at Union Miniere du Haut Katanga, 357  
 — vs. cyaniding gold ores, 226  
 — works (silver-lead), 468, 471, 513  
 — zinc ores, 519, 528  
 Smith-Pierce copper converter, 401, 403  
 Smoke damage, 549  
 Solution, costs of by slime agitation, 186  
 Solutions, clarifying of, 176  
 —, precipitation of gold from, 177  
 Sorting or pickling ore, 265  
 Specific heat of gases, 80  
 Split-shovel sampling, 41  
 Stage grinding, 50  
 Stamp battery, 125  
 Stamp mill, 55, 124  
 — —, using amalgamation and concentration, 245  
 — — with plate amalgamation, 124  
 — milling, concentration in, 131  
 Stamping, 265  
 Starting sheets, 452  
 — the copper blast-furnace, 371  
 Steam locomotive, 551, 552  
 Steel, alloy, 347  
 — castings, 346  
 —, costs of production, 348  
 — leaching vat, 152, 192  
 — making, 320  
 — —, by the acid Bessemer process, 321  
 — —, — — duplex process, 340  
 — — in the open-hearth furnace, 326  
 — prices, 347, 348  
 — rails, 345  
 —, structural, 346  
 —, tool, 346  
 —, wrought iron and, 318, 345  
 —, varieties of, 345  
 Storing ores, 40  
 Stove, hot-blast, 295, 296, 298  
 —, scrubbers for, 296  
 Straight ores, definition of, 3  
 Strength of cyanide solutions, 147  
 Structural steel, unit costs for, 574  
 Sulphide copper ores, blast-furnace smelting of, 360, 377  
 Sulphides of copper, 351  
 Sulphitizing roasting, 88  
 Sulphur in pig iron, 317  
 Sulphuric acid leaching, 420  
 — — —, Ajo process, 432  
 — — —, Butte-Duluth process, 430  
 — — recovery, 527  
 Superintendent, duties of, 585  
 Supplies, purchase of, 596  
 Sweetland filter press, 172  
 Symons disk crusher, 61  
 Systems of cyanidation, 150
- T
- Tailing, samplers, 46  
 Talcose gold ores, 145  
 Tank, Brown, 58  
 —, electrolytic, 450  
 —, Pachuca, 58  
 Tap-jacket, blast furnace, 474  
 Taxes, 594  
 Telluride gold ores, 145  
 — ores, treatment of, 199  
 Telpher mono-rail transport, 555, 556  
 Temperature of combustion, 79, 82  
 — — flame, 80  
 Temporary or distribution accounts, 592  
 Tension screen, 67  
 Ten-stamp battery, 127  
 Test for English cupelling furnace, 509  
 Testing or research, 586  
 Thermo-chemistry, metallurgical, 84  
 Thickening, 167  
 Thimble for bag house, 485  
 Three-throw plunger pump, 567  
 Tile, 34  
 Tilting furnace, 8, 414  
 — — for copper, 414  
 — —, melting in, 262  
 — —, Monarch-Rockwell, 263  
 — —, open-hearth, 332  
 — —, Steel-Harvey, 263  
 Tom Reed mill, 207  
 Tonnage in mills, calculations for, 223  
 Tool steel, 345  
 Tramp iron, removal of, 465  
 Transformer and substation equipment, 344  
 Traveling crane, 556  
 Traveling feeder, 464  
 Traversing bridge, iron smelting, 287  
 Treatment by agitation, 161  
 — costs of lead ores, 495

Treatment, methods of, 4  
 — of amalgam, 241  
 — — bottoms, Welsh process, 389  
 — — copper ores, 351  
 — — flue dust, 489  
 — — gold-mill concentrates, 213  
 — — rich lead, 507  
 — — silver ores, 232  
 — — — precipitate, 259  
 — — tailings for acid or ammonia leaching, 223  
 — — telluride ores, 199  
 — or reduction charges, 593  
 Trent agitator, 160  
 Triple roasting, 113  
 Triplex high-pressure pump, 568  
 Tripper for conveyor, 560, 561  
 Trommel or revolving screen, 68  
 Tube mill, 64  
 — — circuit, Alaska-Treadwell mill, 215  
 — — liners, 63  
 — — milling, 265  
 — or ball-mill drive, 63  
 Tuyere, blast-furnace, 474  
 Two-wheeled slag pot, 367  
 Typical gold mills, practice, 189  
 — silver mills, 265

## U

Underestimates in building, 570  
 Union and non-union labor, 580  
 — Miniere du Haut Katanga, smelting at, 359  
 Unit construction costs, 572  
 — costs for concrete foundations, 572  
 — — — erection of machinery, 573  
 — — — electric lighting, 573  
 — — — excavation, 573  
 — — — floors, 573  
 — — — labor, 574  
 — — — masonry, 574  
 — — — painting, 574  
 — — — roofing, 574  
 — — — shafting, pulleys, and belting, 574  
 — — — structural steel, 574  
 — — — ventilating windows, doors and floors, 574  
 United Eastern mill, 570  
 United Eastern Mill, costs of, 211  
 — — — flow-sheet, 211  
 — — — plan, 210

Units of measurement in thermo-chemistry, 84  
 Upright copper converter, 401  
 Utah lead ores, prices of, 495

## V

Vacuum filtration, 168  
 — -leaf filter, Butters, 168  
 — process, 177  
 Valuation, 592  
 — of gold and silver, 122  
 Variations of costs of treatment of silver-lead ores, 497  
 Various treatments and calculations, 223  
 Vats for cyaniding, description of, 152, 194  
 —, steel leaching, 154, 194  
 —, —, for double treatment of cyaniding, 154  
 —, wooden leaching, 152  
 Ventilators, windows and doors, unit costs of, 574  
 Vezin sampler, 43  
 Victor plant, Portland Gold Mining Co., 202  
 Victorious gold mill, 190  
 Von Patera process, 254

## W

Wage scale, 575  
 Waihi Grand Junction mill, 270  
 — — — —, flow sheet, 271  
 Walker casting machine, 447  
 — multiple system of current flow, 451  
 Wall-type indicating pyrometer, 83  
 Wasp No. 2 mill, 189  
 Waste wood and tramp iron removal, 465  
 Water jackets for copper blast-furnace, 365  
 Wealth, distribution of, 579  
 Wedge blende roasting furnace, 522  
 — chloridizing furnace, 424  
 — roasting furnace, 522  
 Welsh process of reverberatory smelting, 387  
 Wet desulphurizing process, 276  
 Wethey roasting furnace, 97  
 Wet silver mill, 236  
 — — milling with tank settling, 235  
 White briquetting press, 490  
 White-Howell roasting furnace, 97  
 — metal, conversion of copper, 405



Wilfley concentrating table, 114, 115  
Wind furnace, 72, 77  
Winter work in construction, 570  
Wood, 14  
Working costs of lead ores, 495  
Workmen, 586  
Works, rules of, 587  
Worm or screw conveyor, 560

## Z

Ziervogel process of extracting silver, 251  
Zinc boxes, clean-up, 182  
— —, — and treatment of precipitate, 258  
— coating, 10  
— distilling, 540  
—, grades of, 540  
— in slags, 482  
— ores, 517

Zinc ores, reduction of, 519  
— —, roasting, 519  
— —, —, chemistry of, 519  
— or extractor box, 181, 182  
— prices of, 539  
—, properties of, 517  
— refining, 540  
— roasting furnaces, 520  
— smelting furnace, operation of, 534  
— — furnaces, 529  
— — —, Belgium type, 529  
— — —, regenerative type, 532  
— —, costs of, 538  
— —, losses in, 537  
— — plant, 533  
— —, prices of, 539  
— — retorts, 534, 536  
Zones of the blast-furnace, 300

















YC 68413

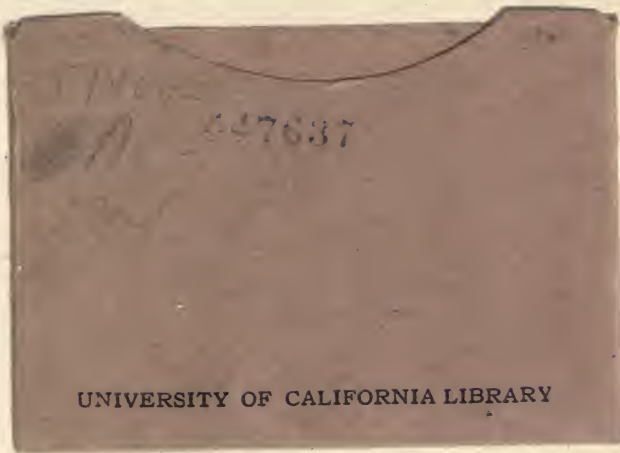

UNIVERSITY OF CALIFORNIA LIBRARY

