

THE
BIBLE AND NATURE
VERSUS
COPERNICUS

Library of the Theological Seminary,

PRINCETON, N. J.

Presented by *President Patton*

BS 650 .M54 1901
Miller, Samuel, 1842-
The Bible and nature versus
Copernicus



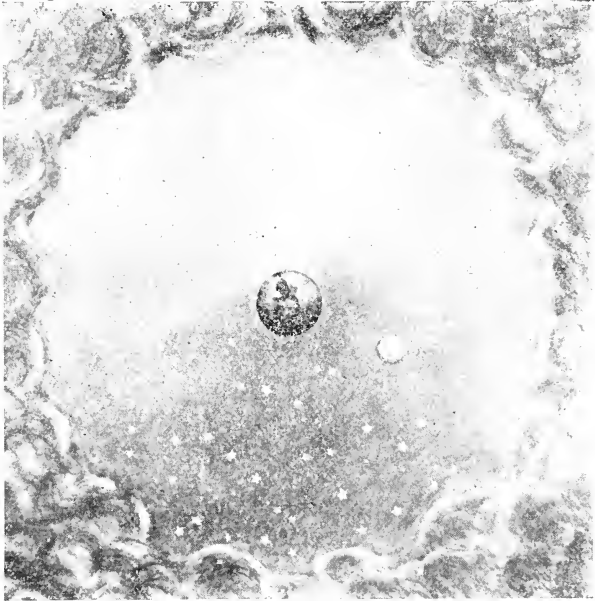

THE UNIVERSE.

(According to Genesis.)

*The Earth surrounded by the Firmament
containing the Sun Moon and Stars.*

*The Vapors beyond the
Firmament.*

THE
BIBLE AND NATURE
VERSUS
COPERNICUS.

A SERIES OF LECTURES IN DEFENSE
OF SACRED TRUTHS DISCREDITED
BY MODERN SCIENCE.

BY SAMUEL MILLER.

PREFACED BY
REMINISCENCES & REVERIES
Of the Author.

ILLUSTRATED.

1901.

COPYRIGHTED.
1901,
By Samuel Miller.

CONTENTS.

<i>INTRODUCTION</i> :—Motive for, and Object of the Work.	(page 5—13
<i>MOTTO</i> , “ <i>Non Nobis Solum.</i> ”	14
<i>CHAPTER I.</i> Reminiscences.	15
My Ancestors.	15
Personal Peculiarities.	19
“Perpetual Motion.”	23
First Astronomical Calculation.	26
“Taking the Sun’s Altitude.”	27
First Effort at Self-conquest.	28
The Dawn of Hope.	30
My First Great Sorrow.	31
Standing by the “Old Flag.”	34
Facing the Enemy’s Guns.	36
An Unpleasant Situation.	38
The Charms of Solitude.	40
Adrift in a Strange Port.	42
Asleep on Guard.	43
<i>CHAPTER II.</i> Reveries.	47
The Champion.	48
A Dream of the Age.	54

A Retrospection.	56
Deacon Prohi's Son "Will."	58
" <i>Cuba Libre.</i> "	61
"Placed on File."	64
The Nation's Hope.	66
Blind Justice.	72
A Reverie.	75
<i>CHAPTER III. Reveries.</i>	77
Our Savior's Baptism.	77
Mother, Home, Heaven.	80
In Charity.	82
"Suffer Little Children—"	84
The Modern Samaritan.	86
The Rescue, and the Saved.	89
Lazarus the Beggar.	91
The Lamp Still Burns.	94
<i>CHAPTER IV. Life on the Farm.</i>	97
A Perilous Incident.	100
Entering the Lecture Field.	103
Fortune still Coy.	106
Truth of Humble Origin.	111
In the Night Watches.	113
<i>CHAPTER V. "Higher Criticism."</i>	117
Author Criticises a Higher Critic.	118
The Doctor's Reply.	122

CONTENTS.

iii

The Author's Response.	125
The Doctor's Ultimatum.	128
The Author's Finale.	132
Why Disturb Existing Conditions?	137

LECTURES.

<i>CHAP. VI.</i> The Bible <i>vs</i> Copernicus.	141
The Flood.	146
The Sun Stands Still.	151
The Sun Turns Back.	156
God's Estimate of Our World.	162
Man's Estimate of Our World,	165
Cannot be Pleasing to God.	167
The Witness of the Spirit.	168
Our Chief Defense.	170
Physical Apparatus.	180
<i>CHAP. VII.</i> Nature <i>vs</i> Copernicus.	181
The Refraction of Light.	182
Counter Refraction.	184
The Lunar Eclipse.	189
Celestial Distances.	196
A Transit of Venus.	198
The Sun Spot Paradox.	207
<i>CHAP. VIII.</i> Nature <i>vs</i> Copernicus.	217
Equation of Time.	217

The Aberration of Light.	222
Stellar Parallax.	229
Kepler's Second Law.	235
Its Fallacy Shown by Diagram.	242
A New System Outlined.	245
Universal Gravitation.	248
Conclusion.	254
<i>CHAP. IX.</i> Introduction to Lecture,	257
"How the Poor may become Rich."	258
A Great First Cause.	264
Man's Free Moral Agency.	265
Eternal Life the Free Gift of God.	276
Christian Conversion a Reality.	280
A Word to the Young.	284
<i>CHAP. X.</i> Religious Faith.	287
Is the Soul <i>Absolutely</i> Immortal?	290
An Intermediate State.	296
Immortality.	302
Author's Creed.	303

INTRODUCTION.



ANTICIPATING that an excuse, if not a direct apology will be deemed in order for my radical departure from established lines of thought, I will endeavor to make such *explanation* as may partake, in part, of the nature of both; hoping my fellow men may not judge all unkindly my motives, if they cannot commend my work.

Early in life, through hopeful conversion to the Christian religion, I became deeply impressed—yea, fully assured, that the Bible is *true*. But as I grew more conversant with current lore, I found that some branches of physical science—more particularly that of Astronomy—were widely at variance with portions of Scripture, and that, in consequence, the two paths of knowledge

diverged, and the deeper men delved in the mines of scientific research, the more skeptical they became of scriptural truth.

This gave rise to the thought, which later became a life purpose, of an investigation of this important matter; believing that if fairly and intelligently pursued, in the fear of God, and with an eye single to his service, it would lead to results which would tend to establish his WORD more perfectly in the hearts of men.

Realizing at the outset that wealth is power, and that, from a worldly standpoint, little could be accomplished without worldly means, I entered the field of invention, which my love for mathematics and mechanics and the liberal spirit of our patent laws, made specially attractive; hoping in a few years to gain such a competence as would enable me exhaustively to investigate the subject nearest my heart, and give the results to the people from the rostrum, without compensation or reward, in such attractive form as would command, both their attendance and attention.

I would invest my theme with paintings worthy the pencil of a Raphael or a Titian; with music that might have charmed Arion and his retinue; with intricate mechanism, whose movements would reveal more fully and correctly the wondrous workings of the universe; and render intelligible and effective the whole with that persuasive eloquence to which, in the exuberance of my zeal and young manhood's strength, I believed I was able to attain.

Confining myself strictly to the practical and the useful, many inventions followed my efforts in this chosen field, some of which are in use to-day. For some of the more important ones letters patent were issued, and desirable business connections consummated for their introduction and sale; and at times hope beat high, and the prize seemed within my reach—only to recede again however, or like Dead Sea apples, turn to ashes in my grasp.

In the meantime the small patrimony with which I began had nearly vanished, gray hairs suggested emphatically the flight of

time, and the unwelcome conviction asserted itself, that if I would do this work for the Master, I must be content to pursue it in a more humble way; and consoled by the fact which history records, that nearly all great truths have come to the surface through privation and difficulties, I gave up the unequal struggle for wealth, and addressed myself directly to the task I had assumed, with the limited resources I could command.

It is needless to speak of the years of unrequited toil,—of the hopes, the doubts, the fears; and later, the glad signs of the coming dawn; sufficient for me to say, that my work had at last reached that stage of development, in which I thought best to give it to the public; and embodying the results obtained in a series of three lectures, the important points of which I made ready to illustrate and demonstrate by the assistance of carefully prepared charts and physical apparatus, I came to New York City, with money earned by hard manual labor rented an elegant hall in a Christian institution, and besides newspaper advertising, mailed

over one hundred special invitations to the learned professions and the press to attend my lectures on, "The Bible and Nature, versus Copernicus."

None but reporters came to hear me however, and that their account of my work was not over-assuring to the public, is indicated by the following extracts from a full column article which appeared in one of the leading daily journals of the City:

(From N. Y. Tribune, Dec. 18, 1896.)

"The last of a course of two lectures on 'The Bible and Nature versus Copernicus,' was delivered last evening by Sam'l Miller, in the Assembly Hall of the 'United Charities Building,' East 22d, St. The first of these was delivered on Wednesday evening and was reported in yesterday's Tribune.

———"No one came except a Tribune reporter and two others; yet he gave the lecture from beginning to end, just as he had intended.

"Last night's attendance was a repetition of the first; and when a Tribune reporter

entered the hall, rows of empty seats greeted him. Mr. Miller was in the side room, and came out a moment later. —

———*“There was nothing about him to denote the crank or fanatic. He glanced at his watch, and seeing that it was past the time for beginning his discourse, he took the platform, — entered upon the subject of ‘Nature versus Copernicus,’ and talked at, and for the benefit of his listeners, with a manner which was at all times earnest, calm, and sincere. If blasted hopes and heartrending disappointment bore hard upon him, he never showed it — the whole situation was certainly unique, &c.—*

———*“The lecture was interesting too, in its way, — Mr. Miller showed that he knew Astronomy, both as it is, and as he thought it ought to be; &c. &c.”*

Failing to gain an intelligent hearing in New York, I returned to my home, and in January following delivered two of my lectures before fair sized audiences in the city

of Utica, N.Y., but failed to elicit any response from those versed in the science on which they treat.

I also essayed to promote my work in various directions by correspondence; but failing everywhere, I was reluctantly led to conclude that the age I lived in had already, with its phenomenal precocity, absorbed all the knowledge it could assimilate; and if I would have my work survive this period of intellectual exaltation, I must reduce it to book form, to await the calmer judgment of those whose steadier flight may yet disclose to them the truth of the lesson I would teach—that man's wisdom is fallible, and that with God only, is perfect knowledge.

When difficulties have environed and defeat has saddened, I have turned for fresh hope and inspiration to the following words on the "True Reformer," written years ago by the late Charles A. Dana :

"The true reformer should never despair. Let him remember that error alone can fail, and that the truth he is serving can only be

obscured for a season. Does the world scorn him and mock at him, as one by one his cherished hopes are frustrated, and the labor of years seems fruitless? Heed it not, noble heart! Thy exceeding love for them that thus despise thee, is not wasted; not vain thy yearning to bless them that answer thee with sneers!

“It is not for the day thou workst, but for the ages; fear not that the ages shall lose the harvest of thy deeds. Commit thyself to the Providence that guides all things; faint not if thy bare and weary feet are torn by brambles; over the path that with thy life thou beatest out, Humanity will come hereafter in triumph and in joy!”

Desirous of raising my work above that purely negative effort whose object is but to question antisciptural theories, I have concluded to supplement the scientific portion with an evangelistic discourse, addressed more particularly to the toiling millions with whom I have always been identified,

and to whom my heart goes out in warmest sympathy; indicating in plainest terms how they, though lacking in this world's transient possessions, may gain the true Heavenly riches, and in peace and happiness enjoy them — Forever!

While next to God's own providential aid and guidance, my thanks are due to my wife and daughter and two sons, who have so patiently borne with me through these years of unremunerative toil, and by their kindly forbearance have assisted me in making this production possible, yet I would dedicate it to *future* generations; trusting that, "As pictures owe their mellow hues to time," so the flight of years may soften those sharp lines of contemporary intolerance, which would relegate to the shades the results of my life effort to demonstrate that between Nature and the Bible there is no conflict.

“NON NOBIS SOLUM.”

“*Love thyself last — cherish those hearts
that hate thee;*

*Corruption wins not more than honesty:
Still in thy right hand carry gentle peace,
To silence envious tongues. Be just and
fear not:*

*Let all the ends thou aim’st at, be thy
Country’s,*

*Thy God’s, and Truth’s; then if thou
fall’st, O Cromwell!*

Thou fall’st a blessed martyr!”

Shakspeare.

REMINISCENCES AND REVERIES.

CHAPTER I.

NATURALLY they who in the coming years may take up this volume, will wish to know more than is disclosed by the treatment of the subject proper, of the man who preferred to brook scholastic disfavor in his day, that the truth might be declared; hence my decision to attempt such a brief account of my personal affairs, and my earlier connection with this work, as may not justly expose me to the charge of egotism, and yet satisfy the reader of the future.

MY ANCESTORS.

A few years before the Anglo-American war of 1775—83, a young wedded couple of Holland Dutch descent, but American born,

purchased a considerable tract of land, and hewed out for themselves a rude home in the primeval forest, at a point situated in the present rural township of Columbia, in the county of Herkimer, and state of New York U. S. A., seven miles north of the famous watering place and pleasant summer resort of Richfield Springs.

That couple was Henry and Eva Miller, my grandparents on the paternal side. Possessing an abundance of hope and vigor, they had the satisfaction of seeing the little clearing around their home grow larger each year, as the forest retreated before the stalwart husband's ax, while the wife invested their humble dwelling with those simple home charms which, where contentment is, transform the hut into a palace.

In this silvan retreat children were born, to augment both the happiness and the care of my worthy ancestors; other settlements were springing up around them, the few natives, or Indians in the vicinity continued friendly, and they looked forward to a life of peace and prosperity.

But in the midst of this tranquility, there was borne to them on the eastern breeze the clarion notes of war, heralding an open rupture at last, of the strained relations long existing between the colonies and the mother country; and fleet-mounted couriers came darting through the settlements, calling the sturdy yeomanry to haste to their country's defense.

Gathering his little flock around him, and consigning them to the care of a kind and trusted Heavenly Father, my grandsire took down from its resting-place over the rude mantle, his trusty rifle, and only waiting to secure his ammunition and a few rations, set out for the appointed rendezvous, to follow his country's banner through that long and unequal, but successful contest, recorded in history as the American Revolution.

My grandmother remained at home with her little ones many months after her husband's departure, caring for their embryo farm and little home, which had become so dear to them; but the conflict was steadily pressing farther westward into the interior,

and when, one beautiful autumn day a well known scout came dashing through the settlement on his foam-flecked steed, warning the people of the approach of a hostile body, she hastily gathered up a few necessary garments, seized a kettle of hasty pudding just ready for their noonday meal, and with a small pail of milk and a few rude pieces of table-ware, took her two children and set out, through the woods, for the friendly shelter of Fort Herkimer, seven miles away; which they safely reached by nightfall, halting only a sufficient time along the way, in a sequestered ravine, to partake of their frugal meal.

At the close of the war this family was reunited, and returning to their home, took up the thread of life anew. More cleared acres were added to those already improved, more comforts and conveniences to the little home, and more members to the household; my father having been the youngest of the family.

After the death of my grandfather, his lauded estate was divided among his several

sons; my father, John H. Miller, receiving the homestead, and assuming the care of my grandmother and a crippled uncle.

My mother was a Widrick — a niece of Gen. Geo. Widrick, who saw service in the war of 1812—14, and I was their youngest child; the date of my birth being recorded in the old family Bible as Feb. 20. 1842.

My parents began their wedded life in the old home, but in due course of time they erected the more modern frame structure in which I was born, and in which I later did much of the work treated on in this volume.

I had one brother and two sisters who, like my parents, were good, sensible people of a practical turn of mind, affiliating with conditions surrounding them, and respected by all who knew them.

PERSONAL PECULIARITIES.

I was emphatically the odd sheep of the flock, and my earliest recollection recalls a fondness for Mechanics — I would leave my playmates any time to watch a carpenter or

blacksmith work at his trade. I also evinced a taste and aptness for cutting profiles, or silhouettes out of paper with a scissors, and in drawing with chalk or pencil.

When sent to school I learned rapidly, and soon gained favor with my teachers, though I was not a favorite with the school. There was always a tendency to misconstruction of my kindest impulses and purest motives; and that tendency has followed me through life, causing me sadness and regret.

I early acquired a fondness for mathematics, which, during that stage when every boy must play at "circus," was turned to account by the lads employing me to survey and stake out for them their imaginary pavilion and arena. I would go out with my line and stakes, and pursue the work with a pleasure that lasted till my task was completed, but ended where their fun began,—the enterprise possessed, for me, no further interest.

That love for mathematics increased with my school years, and I soon fell to encountering and pursuing some of the most difficult

problems with a tenacity of purpose which usually reached a successful solution, and gave me a reputation for never giving up a problem.

As a boy I was impulsive — easily moved to sympathy by the wail of distress from any living creature, and just about as easily moved to anger, on provocation. Respecting my own personal interests, I have ever been what the world is pleased to call, improvident; hoping and desiring, it is true, to be in comfortable worldly circumstances some day, yet never reaching that period when I was willing to ignore a brother's need or interests, that I might add to my worldly possessions; and only desiring and seeking wealth for promoting the object I had in view.

One day when yet a small boy, my mother said to me in a tone, not so much of reproach as of prophecy: "You will never be rich, Sam!" The expression was prompted by my giving a traveling mendicant all the pennies I had — the savings of many days.

How true that prophecy; yet how hard

for the average man of the world to understand that, for myself, I have no regrets.

I always had a keen relish for the humorous side of life, and when a boy, there was ample scope for observing the ludicrous, in the vicinity of my home. We had a half dozen or more regular "rounders" in that section, who visited the farmers periodically for sampling the cider always found on tap in those days. Each one of those thirsty gentlemen was a distinct *character*, abounding in eccentricities peculiar to himself; but among them there was one of such marked individuality as to claim more than a passing notice here:

Perce Jackson, in his cups, was to my boyish fancy the funniest man I ever saw; and no matter how sternly I would be cautioned against the impropriety of laughing at his folly, when Perce turned his facial battery on me, one twinge of the muscles he knew so well how to work effectively, would render that caution void and inoperative for the time being.

Several years ago, during an idle day my

thoughts recurred to this man, and I made him the hero of a little sketch in rhyme, as will be found in the next chapter, under the title of, "A Retrospection."

PERPETUAL MOTION.

When in my fourteenth year, an older schoolmate explained to me, in a general way, the subject of "Perpetual Motion," of which he had been reading. I became interested at once, and later gave the matter a good deal of thought; the result being, that when I was sixteen, I turned my hand for the first time to invention, by undertaking to produce a perpetual motion machine, after a plan which I conceived and reduced to drawing, which was plausible enough to arouse the interest and enthusiasm of those who were privileged to examine it.

But I early learned what all must sooner or later learn, who take up this fascinating study—that action and reaction are always equal, and in opposite directions; and that gravity acts just as forcibly on an ascending

body, as on a descending one; while no body can exert a greater force in descending from a given point, than is required to raise it to that point again, no matter by what route it travels.

A little later my mind was incidentally turned to the subject which afterward became my life study. It was my privilege to observe an important, though not quite total eclipse of the sun; and as I saw that well defined, circular shadow sweep over the sun's disc, I fell to meditating on the cause of the strange phenomenon. I had learned nothing of astronomy up to that time, but that dark, curved or circular,—*something*, passing between me and the sun, impressed me as being some other heavenly body which, I correctly theorized, might be the moon.

Soon feeling confident that I had discovered the cause of this phenomenon, I began to extend my inquiries, and having a fair general knowledge of geography—the location and significance of the equator and the

tropics, lines of latitude and longitude, with reference to the location of my home, &c, I conceived the bold project of attempting what I learned in after years, is the most important problem in astronomical science — that of calculating the distance of the sun from earth; technically called “Finding the solar parallax.”

I had learned that at the time of the equinoxes — on the 21st. day of March, and on the 23d. day of September, the sun is directly over the equator, and on consulting the map, I found that my home, (from which my observations would be made,) was nearly on the 43d. parallel of north latitude. I reasoned that whatever angle the sun’s rays made, at high noon on those days, with a line perpendicular to my point of observation, if that angular line were continued till it cut a line drawn upward, perpendicular to the earth at the equator, the point of intersection of the two lines, would represent the sun’s place; whose distance from earth could be accurately determined, by taking the known diameter of the earth for our

measuring unit. This plan is illustrated by the diagram below, which I will describe as follows:

The circle represents the earth, the line E, the equator, and A my place of observa-

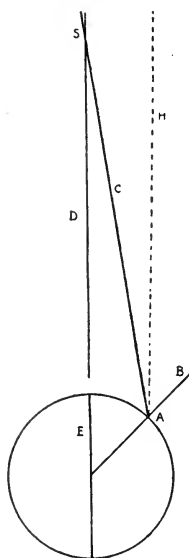

tion in lat. 43° north, while S indicates the point where the line C, (representing the sun's rays,) intersects the earth-perpendicular line D, which point locates the sun; and A, B, C, is the angle which the sun-rays make with the line B, which is perpendicular to my place of observation.

Taking this as the basis of calculation, it is evident that the distance from earth to S, would be as many times the earth's diameter (7926 miles) as its diameter is contained in

that distance.

After this plan had been carefully considered, diagrammed, and settled upon, I confidently awaited the 23d. of September,

earnestly hoping it might be a clear day, and conditions favorable for me to gather data for making this positive mathematical calculation of a quantity which, I had been led to believe, had in the past been computed by very uncertain methods.

TAKING THE SUN'S ALTITUDE.

The eventful day came at last, and everything seemed to favor the momentous undertaking. The sky was without a cloud, and to my great satisfaction, the family all went to town that day, except my crippled uncle, who sat in his great easy chair, no doubt wondering what strange freak the boy was pursuing again, while I made my elaborate preparations for "taking the sun's altitude" when it should reach its meridian height, as its rays came in over the window-sill and rested on the floor of the living-room which we occupied.

My observation was duly made, and satisfactory results obtained, which I very soon applied to the diagram that had previously

been prepared;—but, strangest of strange results!—the angular line c, instead of tending toward the line D, as in the preceding diagram, actually ran just about parallel with, or possibly a little divergent to D, as shown by the dotted line, H.

What could be the meaning of this? Had I not observed, calculated, and diagrammed correctly? This was a poser, and somewhat of a damper to me for a time; but the next year I began the study of Physics, and soon learned the prime cause of my discomfiture, when I came to the subject of “Refraction of light,” which I make one of the leading topics in my lectures.

FIRST EFFORT AT SELF-CONQUEST

As I look back over those early years, I can now see that I was regarded by my acquaintances, as not a bad—in fact, as quite an exemplary youth. I manifested to them no conspicuously bad habits, had early been taught to respect, and treat with kindness the aged and infirm, attended church and

Sunday school, was fairly attentive to my studies and duties, — and, at any rate, was above public censure.

But I, myself, came to know that I was desperately wicked. I knew that there surged within my rebellious heart a hot torrent of evil thoughts and passions, which sometimes found vent in violent acts, but oftener in violent and profane words; and the conviction gained with me that I must strive for something better—but where would the work of reformation begin?

My first effort was, to cease all profanity; and to those who are still slaves to this utterly useless, foolish, and deplorably sinful habit, I wish to say that I found its conquest so decidedly easy, that from the very hour I first made the decision, I had put it under my feet *forever!*

I firmly believe that God's good angels specially help the man or woman who soberly and solemnly decides never again to speak irreverently the names of the Father and the Son. And when once emancipated, how thoroughly futile, inelegant, and uncalled

for the needless jargon sounds. It certainly is something easy not to do.

THE DAWN OF HOPE.

The good work so auspiciously begun, was later continued with a serious consideration of my relations to a Supreme Being, and I fell to studying attentively the words of promise and instruction contained in the Scriptures, with the result that, ere long, I found that peace and hope which our Savior promises all who dilligently seek him; and though my life service has fallen far,—far short of what it should have been, from so bright and hopeful a beginning, yet that early experience has influenced my whole subsequent career; and who is able to say that the poor effort I have put forth in the cause of divine truth, though spurned by the “higher critics,” and regarded with a stolid suspicion by the “old school” theologians, may not win for me a humble place in the bright throng of the redeemed? since our Heavenly Father regards not more highly

the wonderful achievements of men,—of which he stands in no need,—than he does the pure motive and the worthy, though unsuccessful effort to do him service.

MY FIRST GREAT SORROW.

As clouds sometimes obscure for a season the bright face of the sun, and give a sombre cast to the cheerful landscape, so in the following year the bright beam of hope that shone across my path, was shaded by my first and greatest sorrow.

I had an only brother, three years older than myself who, except when I was away at school, had been my constant companion through all my boyhood years; and I loved that brother with all the strength of an ardent, impulsive nature. He was the direct opposite of me in all that makes humanity lovable. Instead of the reserved, sensitive, non-magnetic, his was the warm, friendly, social nature, that made and held everyone his friends. His tastes were purely practical and domestic, while I was ever reaching

out into the untried and unknown, and getting myself—*misunderstood!*

But he understood,—and believed in me; and when my father decided to give me a liberal education, he generously consented to shouldering the extra duties my absence would impose, and always encouraged my efforts, and manifested the deepest interest in my advancement.

But one cheerless winter night, when the cold winds moaned among the leafless trees, the landscape was robed in its winding-sheet of snow, and the ice-fetters clasped the rippling streams in their frozen embrace, that generous heart ceased to beat,—that manly form was touched by the cold finger of—Death! and a gloom more chilling than the winds that moaned his sad requiem, fell on the happy home of my youth.

Other bereavements have followed, till I alone am left, of that home circle; and each has brought its poignant grief and left its sad memory; my parents and uncle departing in the ripe fullness of years, and both my sisters in the prime of matronly woman-

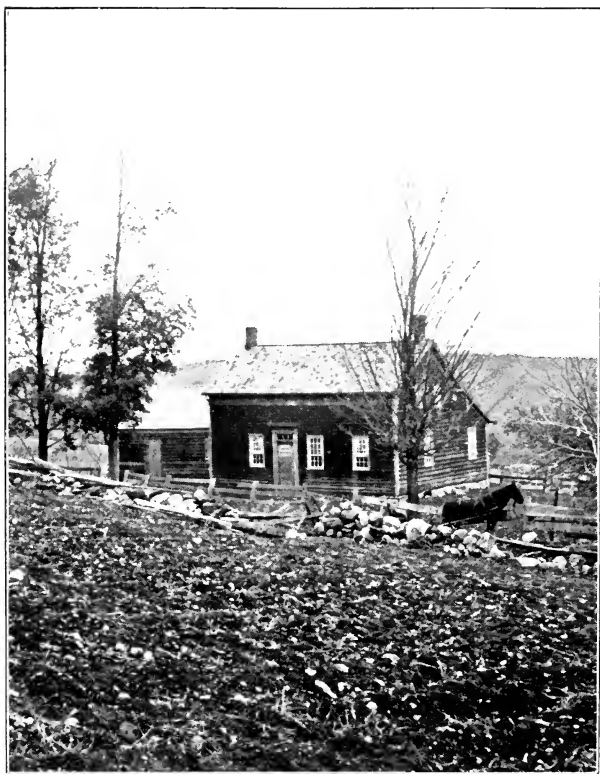

THE OLD HOMESTEAD.

hood; but that earlier bereavement, when the Dark Angel, for the first time invaded the home, has left an impression which time is feeble to efface.

Long years have flown since then—the snows of many winters have rested on his grave, and their pallid hue is imparted to my once dark locks; but that memory is still green, and sometimes I try to picture how it might be, had he been spared to see this day:

The old homestead, now so dreary and neglected, improved and modernized, might still be the center of a happy social and family circle, dispensing its hospitality as of yore; the fields be smiling under generous culture, and a warm welcome awaiting my occasional return to the only place I ever called—HOME!

But it was not so to be,—and can we say that it would be better thus? Can we say that he is not happier, or that the rugged path I am treading, may not yet lead to the fulfillment of my destiny?

STANDING BY THE OLD FLAG.

When twenty one years of age, I began teaching, and during my first summer vacation I officiated as clerk at the famous summer resort hotel, "The Spring House," at Richfield Springs, N.Y.

Those were stirring days—our civil war of 1861—65 was at its height then—brother striving against brother with an energy and desperation that boded final desolation to our fair land.

The battle of Gettysburg, with its fearful carnage, was fought early in July, bringing the conflict far north; the famous New York riot quickly followed, and strong men's faces blanched, at the prospect of the widespread ruin. For weeks following, the Old Flag seemed to hang limp at the mast—to almost trail in the dust.

At this time of my country's sorest need, I came to New York City, and enlisted as a common sailor in the United States Navy,

and was soon put aboard a battle-ship, and sent down on the Wilmington blockade, off the coast of North Carolina.

Here is where would properly come in the record of heroic deeds and glorious achievements; but unfortunately, the limited opportunities for distinguishing myself, and the lack of a fertile imagination, will make this part of my history only plain reading.

I went through the usual routine aboard a man-o'-war of washing down decks, drilling at the guns, also standing an occasional mast-head look-out, and my regular night-watch and look-out on deck. This list was diversified with partaking of the regular ship's fare three times a day, and sleeping in a hammock a few hours at night.

But the monotonous life aboard ship was relieved occasionally by sighting a strange sail, when our vessel, which was a fast one, would give chase and overhaul the stranger.

This would cause the greatest excitement and activity among our crew, who would be ordered to their respective posts as we drew near, ready for action if the craft appeared

formidable, and could not give a good report of herself; which however they usually succeeded in doing, with us, though sometimes not without considerable parleying.

FACING THE ENEMY'S GUNS.

Another occasion for change in our treadmill existence would come when our brethren, the enemy, would send out one of their "blockade runners," or clandestine supply boats, under cover of the guns of Ft. Fisher and their shore batteries, just before night-fall, for the purpose of decoying us within range of their heavier guns, and I presume also to get their vessel started on its way to escape through the picket-line of our fleet, during the darkness of the night.

We would, at such times, draw up within fairly effective range and open fire, which would be promptly responded to by the fort and batteries, the shot and shell flying fast, and sometimes unpleasantly close; our ship in the meantime working her guns as rapidly as possible, and occasionally shifting her

position, to spoil the enemy's range; which tactics fortunately kept us from harm, but another vessel of our fleet—the "Iron Age," was destroyed, by a shell being fired into her magazine.

The firing would be kept up till darkness set in, when we would retire to our station in the picket-line extending across the channel; there to watch in silence and darkness for the unlucky craft that should have the temerity to cross our path.

In those engagements, I am now happy to say, I do not know that I was ever instrumental in killing, or in assisting to kill a single man, though our vessel gave a good account of herself during my term of service aboard of her; and had every craft of equal capacity in the service of the Government done equally well, the war would have ended two years sooner than it did; as, besides other minor services, we captured one large blockade runner, laden with a valuable cargo of general and military supplies, which we duly turned over to the Government and received certificates for "prize money."

AN UNPLEASANT SITUATION.

We took the crew of the prize aboard our own vessel, and assigned them the forward part of the berth deck; stretching a rope across for a dividing line, and beyond keeping a marine guard or two at this line, and serving them with rations, paying but little attention to our prisoners, till one night one of our marines, a fine young fellow, whose hammock swung next to mine, was taken violently sick, and in spite of all the ship's surgeon could do for him, he grew steadily worse, till finally two other surgeons of the fleet were summoned, and a council of doctors was held.

From the ominous, non-committal demeanor of the doctors, I gained the impression that they had discovered something serious, if not alarming; and when night came, and the men were asleep in their hammocks, I called the colored doctor's nurse (a Georgia plantation man) to me, and asked:

“Ben! what's the matter with this man—

what do the doctors say of him?"

With a furtive, sweeping glance at the sleepers in their hammocks, which displayed his white eyeballs in the dim light of the ship's lantern, and with his great chest heaving as if he had been running a race, he came up close to my ear and whispered loud enough to be heard on the gun deck:

"Well, I doan' s'pose I's 'lowed to tell you de truf, Sah! but I specs he's done got de *small-pox!*"

Great guns! Here had I been lying two nights beside a man having the small-pox!

But how did the poor fellow take the disease? Then it ocured to me that one of our prisoners had appeared indisposed, and was lying down nearly all the time he had been aboard, and it was later found that from him the infection came.

Rigid measures were taken the next day to prevent the spread of the disease, by vaccinating all hands; and as we were getting short of coal, we ran up to Beaufort, N. C., our regular coaling station, where our ship was quarantined, after sending our patient,

myself who had been specially exposed, and two others, to Hammond General Hospital, in Beaufort.

THE CHARMS OF SOLITUDE.

Our sick man was sent out to the "pest house," and I was placed in a vacant ward of the hospital, considerably removed from the other inmates, to await developments.

I have seen some dark, and some lonely hours since that time, and the outlook has been dreary and unpromising, but never before or since have I been so brought face to face with the *awfulness of desolation*, that environed me those nine days of isolation and uncertainty.

The only sounds that came to my ear were the dull, monotonous beat of the sea waves, and the occasional crowing of one solitary rooster, whose existence near a military post could only be accounted for on the theory suggested by his "Hark from the tombs" style of crowing—he had grown so old and thin that the boys had no use for him.

The visual prospect was no more cheering than that presented to the ear. From my window stretched the murky waters of the harbor, with some shipping at the farther side, and the low walls of Fort Macon beyond; the remaining landscape consisting of stretches of yellow sand, with a dull, leaden sky overhead and, a general cast of gloom. Could outlook be more cheerless?

Yet, strange to say, in the midst of these disheartening circumstances I never yielded to despair. I confidently expected to have the terrible disease to which I had been so thoroughly exposed, but I as confidently believed that I should pull safely through, and I was even able to picture to my mind's eye the scarred and changed appearance I would present to my family and friends, on my return to them again.

The fateful day was drawing near—but that God in whom I trusted heard the prayers for strength and help which ascended to him from that lonely room, and he answered them in his own good way, which is always better than ours—his hand turned aside the

scourge which human science decreed must fall,—when the tenth day of my seclusion arrived, a careful examination disclosed no symptoms of the malady, and, thank Heaven! I was saved, and once more free!

ADRIFT IN A STRANGE PORT.

Our ship had in the meantime transferred her prisoners, been released from quarantine and was on her way down to the fleet; leaving me in the quaint old town of Beaufort a few weeks, till she came again for coal. The young marine recovered in time to go aboard with me, on her return.

While in Beaufort, I mingled much with the people, and gained a most favorable impression of our Southern brethren. I found both the white and the colored people kind, courteous, and generous to a fault; with no disposition to refer to “our little unpleasantness” during friendly intercourse.

Among others, I formed the acquaintance of a Mr. Barry, a native of Charleston, S.C. who was one of the kindest, as well as one

of the most entertaining men I ever met. He had been in the service of our merchant-marine in some capacity or other for several years, and had visited many of the principal ports of the world; and possessing fine conversational and descriptive talent, I never tired of hearing him talk of the beautiful places he had seen, and the varied and pleasing adventures he had met with.

But I am dwelling too long on this part of my experience; the theme seemed very circumscribed when I began, but memory calls up events which might fill a volume. I will close however, by narrating one more event which appeared to me so impressive, that if my description can do it even meager justice I trust the reader will not deem the time taken for its perusal wholly lost.

ASLEEP ON GUARD.

When the young marine and myself went aboard ship again, we were at once assigned to our respective places, though he was far from strong yet; and one night, after our

vessel had again taken her place in the fleet the officer of the watch found the poor fellow asleep at his post. Poor tired, debilitated nature had given out at last, and lapsed into a repose which was a crime, *punishable with death!*

Oh! that duty and discipline should ever demand so stern retributive action against men, when the heart is right, the motive pure, the spirit willing, and only the poor overtasked flesh fails!

But such is the approved, and apparently necessary operation of our poor human laws,—that invalid youth was placed in irons and cast into the ship's prison, (called, in ship's parlance, "The Brig,") to live on bread and water till his cause should be adjudicated.

* * * * *

Ten days had already flown, and a beautiful Sabbath morning dawned on the world, bright and pure as an angel's dream. The men, arrayed in their "Sunday best," were formed in a hollow square on the quarter deck, for dress review; after which, the

impressive Sunday service was read,—and then the prisoner, wan and worn, and with the deep scars from that dread disease disfiguring his once handsome features, was brought from his gloomy cell and placed in our midst, to receive that public sentence which should be a salutary lesson to all.

The enormity of the offence, and the direful results which might have ensued, were impressively recited by our,—really kind-hearted executive officer,—and then, mid a hush like the stillness of the grave, in faltering tones he pronounced the terrible—*death penalty!*

And what of the prisoner? Calm and serene he stood there, with eyes a little elevated, as though looking away, through the fleecy white clouds and the bright sunshine, to the beautiful Haven of Rest beyond. No stolid indifference was manifest, no defiant bravado; but a calm and holy resignation, such as can come only from a brave heart fortified by an unwavering trust in God.

Pausing a moment, to give the fateful words their full import and influence, our

“Executive” once more broke the silence, by proceeding to review the extenuating circumstances connected with the young man’s offence, and then, with a magnanimity that endeared him to us all, and which might with profit be emulated by others who are in authority, he assumed that divine prerogative which subordinates justice to mercy, and granted the youth—*a free and unconditional pardon!*

CHAPTER II.

WHEN but a youth, I developed a love for poetry, and passed many pleasant hours in reading selections from Cowper, Goldsmith, Byron, Young, Longfellow, Bryant, Willis, and others; likewise the complete works of Milton, which had a peculiar charm for me after I became familiar with his style of expression.

The study of such grand productions naturally awakened a desire for imitation; but with the exception of a very few quite early effusions, I made no attempt at versification till later in life; when during an occasional respite, if some subject of special interest came up, I fell to scribbling in verse for the lack of something better to do.

Those productions with one or two exceptions, were not published; and to relieve the dryness of what may be, to some, a prosy

volume, and also with the hope that an occasional reader may be interested or amused thereby, I have selected a few of them on a variety of subjects, with which to make up a brief chapter or two.

THE CHAMPION.

In days of yore, a line of kings
Long ruled their land so wise and just,
That peace and plenty smiled on all;
And toilers brave reposed the trust
That want and strife would vex no more,
The brethren of their humble lot;
But love and justice e'er would reign,
And war and intrigue be forgot.

They forged the sword of carnage to
The plowshare's rude, but useful shape,
And spears they turned to pruning hooks,
To dress the olive and the grape.
The wheel turned daily in the mill,
The loom gave forth its noisy clang,
And Youth was gay and Age was cheered,
And maidens at their light tasks sang.

But can the Foe of Humankind,
View undismayed, such calm repose?
He who in Eden wrought the deed,
That brought us death, and all our woes?
With cunning vile and intrigue bold,
And nothing fearful to offend,
He seeks out those aspiring ones,
Who scorn not to betray a friend.

“Dost see the treasure being heaped
Into the storehouse of your Sire?
What though you fare as well as he?
This wealth is yours, if ye aspire!
Go tell the tale to fickle men,
That howe'er blest their peaceful days,
Still *better* times than they have seen,
Await their turn to Wisdom's ways!”

The word passed out, unrest was sown
Throughout the borders of that land;—
“Give us a change!” they stoutly cry:
And tumult rose on every hand.
The ruler who, with scepter mild,
Had guided them with tender care,
Was soon dethroned, and quick they gave
The “Prince of Promises” the chair.

* * * Wherefore these idle men,
 With downcast eye and clouded brow?
 Whence comes this wail of want and woe?
 Why in the furrow rusts the plow?
 Where's flown the spindle's lively whirr,
 The sound of wheel and forge and loom?
 A "*Change*" has come! the sun has set!
 And murmurs greet the gathering gloom!

From out the surging crowd there speaks
 A voice, by want and wait made bold:
 "My brethren, we have been deceived!
 By promise false we have been sold!
 Rise! rise! and in your might cast off
 These chains which bind us to our lot!
 We'll walk this earth again, *free men!*
 And live to see these wrongs forgot!"

"Hear treason! treason!" minions shout,
 To their new ruler on his throne:
 "Away to prison with the dog,
 We'll crush dissension as it's sown!"—
 The sun seeks shelter from a cloud,
 The song-bird's note of joy is sealed;
 All Nature mourns this son of toil,
 As hirelings drag him from the field. * *

* * * Morn on the tourney-field—we see
The troops of peasants gathering in ;
With bated breath of him they speak,
Who expiates this day his sin. —
The sin of voicing that whereof
The heart, long full, was overstrained :
But hush! the heralds wind a blast—
They come!—the Monarch and his train!

In pompous state he takes his seat,
His knights arrayed on either hand :
“Bring forth the dog!” he hoarsely shouts,
“Who dared breathe treason to his band!
Let’s see if he, who late so brave,
Would make his vaunting language good,
When face to face, he’s called before
These of our knightly brotherhood!

“How now, vile knave! hast aught to say
Against thy sentence, ere the while?
Stand forth and face this goodly sword!
Thy blood its blade will soon defile!
Ah ha! dost falter, grov’ling cur?
Still wouldst thou with thy voice pollute
The presence of our royalty,
And seek our edict to refute?”

“Nay, Sire! this only would I crave,—
Thou knowest the laws of chivalry;
They give unto the one condemned
The right to choose a champion, free!
Grant me this freedom, an I fail,
I’ll ask not further at thy hand!”
“It’s granted, churl! go seek your knight!
Hah! who dare face one of our clan?”

Apart, there stand a group of knights,
Not of the Monarch’s royal train;
And in their midst a white plume waves,
Which spot the prisoner seeks to gain.
Arrived there, he devoutly kneels
Before him of the waving plume,
And prays that he will save him from
The fate of his impending doom.

The knight bends low, he lifts him up,
And bids him be of better cheer;
And nothing daunted, goes to stand
Before this judge and king austere.
“Most worthy Sire! enough I’ve seen
Of tourney tilt and battle strife,
To crave me not unduly this;
But this is for a brother’s life!

- “This gauntlet therefore I cast down,
Low at my Monarch’s royal feet!
Who takes it up, of goodly fame,
I’ll hold myself prepared to meet!
With lance, or sword, or battle-ax,
Will I engage him in the fight —
A brother’s weal my holy cause,
My battle cry, ‘God and the right!’ ”
- “But why select this gray-haired knight,
Thou Prisoner?” quoth the royal king:
“Though firm his step and keen his eye,
Yet younger knights would likely bring
More willing service to thy cause.
Not that we fear his trenchant blade;
But fain would know the impulse hid,
On which thy worthy choice was made.”
- “Canst thou, O Sire! recall the strife
Which gave to thee thy present throne?
This knight stood up, unheeded then,
And made this noble precept known:
‘The toiler is ill-paid,’ said he,
‘And wages are unjust reduced,
When daily wants are not supplied,
And wherewith to instruct the youth;

“ ‘With something for old age, besides
Stern want and bitter, scalding tears!’
That precept in my ears hath rung,
Through this repentant term of years.
And now I breathe once more of hope,
And trust to see my just cause won,
By him whom I with joy salute,
And hail, MY DAUNTLESS CHAMPION !”

The following article, written in 1889, suggesting the development of Electrical Science up to that date, is in imitation of Bryant's poem, "The Dream," with a few lines borrowed from the same, for which I hereby make acknowledgment.

A DREAM OF THE AGE.

I had a dream—a strange, wild dream!
Thus said a voice at early light:
I've slept so long, its shadows seem
To linger in my waking sight.

A dear one stood on a foreign strand,
While broad Old Ocean rolled between;
She pressed a button with her hand,
And click click click, went some machine.

Forth from the caverns of the sea,
A message prompt and speedy came;
And lo! it was addressed to *me!*
And bore the distant sender's name!

“Halloo! halloo!” this next I heard,
In notes that quavered high and higher:
“List now, and try to catch each word;
I'm talking to you—*through a wire!*”

The chattering converse at length done,
The waning day had closed in night:
I moved my hand—when, *like the sun!*
Flashed forth a dazzling sea of light!

New objects strange the light reveals:
A man a waxen roll did take,—
He placed it mid a group of wheels,
And lo! the moving wonder—*spake!*

As rapt I stood, past seemed to float
A phantom, steamless, steedless train;

No clattering hoofs the pavement smote,
No driver held the guiding rein.

What means this visitation, pray?
Expound to me the lesson now!
'Twas thus I heard the dreamer say,
And bade him clear his clouded brow :

“Your dream is realized to-day.
Such scenes now pass in quick repeat;
And visions stranger yet than they,
May haunt your next Van Winkle sleep.”

A RETROSPECTION.

As memory turns to scan life's way,
A shadow quaint comes up,
Of one I knew in boyhood's day,
Who loved too well the cup.

Sad story 'tis for me to tell,
But 'neath that battered “tile,”
Reposed a wit, I know full well
Could have made a bishop smile :

A mind that with a proper bent
To win itself a name,
Might to its day and age have lent,
A Well-earned meed of fame.

But love of glass and maudlin wit,
Perverted sad the course,
Of him who oft would make a hit,
Which showed his latent force.

One day, across the fields he strode,
Unto the nearest inn,
With jug in hand, to get the "load,"
So precious then to him.

Returning, he with "caishnul quaff,"
His arid frame regales;
But soon, alack! across his path,
There loomed a fence of rails.

Sedate he clambered up the side,
And swung his *burden* o'er,
But, (vain attempt the truth to hide,)
His strength could do no more.

As stands a moment, the proud oak,
When severed at the trunk,

Then sinks before the woodman's stroke,
 So dropped our hero—*drunk!*

For slipping from his weakening hold,
 His counterpoise, the jug,
 Both jug and man, (it must be told,)
 To earth came with a thud.

Soon gathering up his prostrate form,
 And peering through the fence,
 He spied the jug, with stopper gone,
 And th' liquor flowing thence.

As the "gud gud gud," of gurgling flood,
 Fell doleful on his ear,
 "Ah yes!" sighed he, "I know ye're '*gud,*'
But I dropped over here!"

DEACON PROHI'S SON, "WILL."

In all the country, scarce you'd find
 A young man, who in heart and mind,
 And all that graces humankind,
 Excelled the Deacon's son.

The hand he gave was warm and strong,
His laugh was like the wood-bird's song,
He cheered with wit the social throng,
His friendship was sincere.

But lurking in his veins, there lay
A thirst that sometimes comes, they say,
In some hereditary way,
From ancestors remote.

And frequent did he trip, forsooth,
When scarcely yet more than a youth;
But always gave his word of truth,
Each trip should be the last.

His mother, fearing for her child,
No longer by fond hope beguiled,
Implored her spouse in accents mild,
Some check to interpose.

“What! I make *terms!*” the Deacon cried,
“With this accursed thing, spreading wide?
Ne'er will *I* seek to stem the tide,
By *compromise* with sin!

“Nay! let the wrathful torrent roar!
Let earth run red with human gore!

Till, like at Ornan's threshing-floor,
God says, '*Stay* now thine hand!' "

The stern old deacon had his way;
The mother ceased not once to pray,
But never, never came the day,
When poor Will said, "'Tis enough."

The daisies wave now o'er his tomb—
His heart-crushed mother followed soon—
The Deacon walks his lonely room
And sighs, "Too late! too late!"

"Could I but then, as now, have seen
This Hydra-headed dragon lean,
I'd have known it could not e'er have been,
To crush with one fell stroke!"

"Had I my saint-wife's bidding done,
And lopped these heads off, one by one,
I might have kept our noble son
Out of a drunkard's grave!"

"But now, alas! it is too late;
They await me at the Pearly Gate;
May God forgive my great mistake,
And take us to His rest!"

“*CUBA LIBRE.*”

(1896.)

Aurora greets the billowy sea!
The King of Day, now risen, darts his rays
Across the waves, and near our tropic line,
Like a rare diamond set mid lesser gems,
Discloses there a green and fertile isle—
Fair queen of the far-famed Antillean group
Whose orange groves, by the zephyrs fann'd
That steal across Caribbe's southern sea,
Yield their rich fruitage to our open marts;
While saccharine sweets in bountiful stores,
And rare exotics greet our shores.

Four centuries are flown since first arose
To ken of questant navigator bold,
The headlands of this fair retreat. The heel
Of despot since has deep and deeper tracked
Its virgin, and its highly cultured soil,
And laid a tribute, onerous to bear;
But with resources natural, yet rare—
Delightful climate, swift productiveness,
And ease of access to the world around,

It has however to a factor grown
In the commercial world, exceeding far
The area of its circumscribed domain:
And if oppression has at times evoked
The plaint of people smarting under wrong,
These islanders, in most part, yet have been
A happy and contented band of men.

But in this closing century, what strides
Hath Freedom made, and victories secured!
Our goddess fair of Liberty hath flung
Her banner to the breeze, to float, undimmed
Now, o'er the soil once by the bondman trod:
The inspiration from its folds goes out—
Is wafted o'er the intervening waves,
And touches this fair isle—pervades its air,
And is breathed in by people long oppressed.
At last the long-restrained, decisive shout
Of "*Cuba libre! Cuba libre!*" swells
Again, until resistance armed and fierce,
Confronts with bristling steel the cry * * *
And lo! the shout is changed to wail of woe!

Where late the happy song was heard,
Th' inspiring thrum of harp and mandolin,
Timing the feet of merry dancers, 'neath

The palm trees' shade, while Age surveyed
With kind emotions, youthful pastimes gay,
There now are raging all the horrors dire
Of savage and exterminating war,
Waged by a cruel and relentless foe,
Whose blinded zeal no age or sex doth know.

Mid such unequal and inhuman strife,
This little band bears bravely up, yet looks
With hope to us, the nearest hand to aid—
Exemplar too, of that for which they strive.
Shall Cuba seek in vain the help that came
So grateful and so timely to our cause
When erst this nation, later grown so great,
Trod the same path, trembling for its fate?

I counsel no rash breach of treaty made,
Nor rupture of the general law that guides
Great nations in their intercourse benign;
Yet would I advocate obedience to
That higher law humane, by God impressed
In living letters on each Christian heart;
And, grateful for the grand, historic past,
Would, by such memories as Bunker Hill
And Valley Forge, and noble La Fayette,
Adjure the Nation's counselors to heed,

Sure gets that prize!
 You'll get *nil* for what you've *done*, Sir!
 For the spoils are not thus won, Sir!—
 Bet that windy caucus bumster
 Gets there, if *he* tries!"

Yet I fain my faith would save,
 Spotless and pure,
 In the leaders of the brave,
 Firm to endure.
 Nor rash deem ungrateful those who,
 Called to honor from the "Boys in Blue,"
 Yet owe much to those comrades true,
 Who made their calling sure.

THE NATION'S HOPE.

(1897.)

Our Heavenly Father, in His love
 For all His children, small and great,
 With sun and rain doth bless the soil,
 And bounteous crops always await
 The gleaners, when the harvest comes.
 Yet is His just and equal plan,

Perverted sad by selfish men ;
Who, reaping where they have not sown,
Despoiling others of their own,
And "Cornering" the products grown,
Bring want and woe to many homes.

The farmer, like the busy bee,
Through all the sultry summer heat,
Goes forth the sweets to gather in,
That in the winter he may eat,
In peace, the product of his toil.
But restful in the sheltering hive,
Resolved by others' sweat to thrive,
The moth-worm lies in silken nest,
And seizing for himself, the best,
Leaves little for that day of rest,
Well earned by him who tills the soil.

The workingman, with dinner-pail,
Goes to his task on Monday morn—
Toils all the week, and at its close,
Lays down his wage, bereft and shorn
Of every cent, for rent and bread.
Meanwhile, rich members of the "Trust"
Now paying wages so unjust,
Desire more work done in a day,

And seek to yet reduce the pay
Of those, who thus are moved to say,
“How shall our little ones be fed !”

These ills, which now so sore distress
Our body-politic, we're told,
May soon be cured; and 't might be best
Some of the plans to here unfold,
Proposed by men of high estate.
A famous “after-dinner” sage—
A man who says *he* works for wage,
And though with millions laid in store,
Yet shrewd directs vast millions more,
And who with mirth is bubbling o'er,
Facetiously did thus dilate :

“What if the few now own the Earth?
Yet is there always ample room
For enterprising men with brains,
In that expanse this side the moon,
Known as the region of the air.
And for the man who first perfects
An air-ship, free from all defects,—
Since there's no right of way to buy,”
(They'll give us that—up in the sky,)
“I sure can see no reason why

There is not left a prospect rare !”

This to a press reporter shrewd,
Who next inquired the reason true,
Why times were so extremely hard:
Our sage replied, “ ’Tis wholly thro’
Over-production—that’s the cause !”
Strange cause indeed, when analyzed—
And the reporter looked surprised,
That men should pine for daily bread,
And wife and children scant be fed,
Because *too bounteous* the spread—
This is *perversion* of God’s laws !

But now a strong assurance comes,
That all these ills will soon be healed :
For millionaires are being installed
In national councils, and will wield
Marked influence o’er the public fate.
Men who a great success have made
Of their affairs—in stocks, or trade,
And who are thus best fitted to
The work they are engaged to do,
Of helping this great nation through,
And steering safe the Ship of State.

Devoutly thankful, yet in doubt,
I would, for information, ask—
Wherein consists the great success
That fits these doctors for the task
Of treating our congested case?
Is't that they've practiced in the school
That's founded on the Golden Rule?
Or have they only gathered in,
And to that rule indifferent been,
And thus promoted the great sin
They're now expected to efface?

Two other cures are advertised,
Known as Protection, and Free Trade:
But these are "Chestnuts"—only used
When sturdy effort is to be made,
To *guy* the people for their votes.
The remedy which now appears
Most sought for in these later years,
Is something that will safe inflate
Our currency, and thus create
A surplus that will help to break
This "Corner" on our treasury notes.

But would not then these financiers,
Like cormorants in search of prey,

Swoop down upon the workingman,
And soon this surplus bear away,
And turn the keys on't, ás before?
How would I then this case amend?
What certain remedy commend,
That would a healthy tone impart,
Brisk circulation once more start,
And thus relieve the Nation's heart,
And bring contentment, as of yore?

A precept sure the Master gave —

He that was born in Bethlehem :

*“As ye would have men do to you,
So do ye, even unto them !”*

This do, and all these ills will flee.

Let Christian grace rule every heart,
And truth and justice have their part;
Let men regard each other's good,
And walking as His followers should,
Build up a Christian brotherhood

For time, and for eternity,—

'Tis this alone, can make us FREE !

An early friend, who was a magistrate, and a most agreeable and entertaining man, once told a good story of a remarkable legal decision made by another judicial dignitary, which I took a fancy, one day, to reduce to rhythm, as follows, under the title of—

BLIND JUSTICE.

The scales of Justice are, in most,
 So nicely poised, that one
 Could scarce a cause present, to boast
 That *neither* side had won.

Still less might happen to be weighed
 A case where *both* sides win;
 For costs accrue, which must be paid,—
 Some one must—“place the tin.”

But that such puzzlers may arise,
 An instance I append;
 And that this land the wit supplies
 To meet them,—please attend:

An old Dutch justice tried, one day,
 A suit for trespass, which,

In point of precedent, they say,
Was thought exceeding rich.

The evidence was the winning kind,
On *both* sides, it was said ;
But yet, what fixed the judge's mind,
Was what the lawyers plead.

As one his client's cause espoused,
In tones of thunder, which
The shades of Blackstone nigh aroused,
And still arose in pitch,—

The old judge listened, till there shone
Conviction on his face ;
Then firmly said, in under tone,
“De blaintiff win de case !”

But soon in ringing tones, was made,
On the opposing side,
A plea which judgment quickly stayed,
And turned the legal tide :

For as the counsel mounted up,
And yet essayed to climb,
The judge said, (and the table struck,)
“De 'fendant win dis time !”

But when a joint appeal was brought,
And both for verdict plead,
The old man rose, with wisdom fraught,
And this is what he said :

“De blaintiff an’ defendant, dey
Haf, bot’ dem, win de case !
De constable de cost muhst bay,
Or go to jail ten dayss !”

The following article was offered to one of the chief literary journals of Boston, but the editor said that as his paper had a large sale among people who might not feel as I did, on the subject treated, he thought best not to publish it.

I replied : “Call my production crude, inferior, anything you please; but do not leave me to infer that the leading literary journal of Old Boston, the birthplace of American Liberty, the home of the grand old champions of Human Freedom, would consider it *impolitic* to publish a pen-picture, if well

drawn, of that great transformation scene, wherein the shackles of four million bondmen fall, at touch of the sainted Lincoln."

A REVERIE.

I hold a picture in my hand,—
An artist's dream, yet real :
The central figure posed, as 'twere,
By touch of hands to heal.
Majestic is the lofty brow,
Though furrowed deep with care ;
And something, as of high resolve,
Is plainly written there.

Strong is the love for all mankind
Depicted on the face ;
Yet sense, as well, of duty stern,
'Tis easy there to trace.
While thoughts politic, of the weal
Of country, have their part ;
And over all, a tenderness,—
True tenderness of heart.

Beside the tall, commanding form,
On either hand, there kneels

A dusky figure, as in prayer,
 And joining their appeals.
Their wrists secure and firm are bound
 With chain and iron band ;
And on each suppliant's crispy head,
 Is laid a gentle hand.

My thoughts turn backward, as I gaze,
 To those dark days of strife,
When Fratricide recked little, that
 It smote a brother's life.
And hanging o'er the tented field,
 The promised bow I see,
Whose hues betokened liberty,
 In the "Year of Jubilee."

A transformation slowly steals
 O'er the picture in my hands;
I see those chains assunder fall,
 And from the wrists, the bands.
And all around the central head,
 A halo bright, is bent,
And in its radiance, Lo! I see,
 OUR MARTYRED PRESIDENT !

CHAPTER III.

OUR SAVIOR'S BAPTISM.

St. Matthew, Chapt. iii.

In far Judea's wilderness,
Where flows the Jordan to its sea,
A plain man in a plainer dress,
Bespoke most wondrous things to be.
"Repent ye!" was his stern command—
"Messiah's kingdom is at hand!
Prepare a way, make His path straight!"
'Twas of this man Esaias spake.

That plainly man, of saintly voice,
The multitudes unto him drew;
To listen, was their willing choice—
Old prophecies were coming true.
For was not this the voice of one
Who in God's promised time should come?
He who the tidings glad should bring—
God's herald of the coming King?

“Repent and be baptized—prepare !
For after me, there cometh One
Whose shoes I may not worthy bear;
And who, when He in pow’r doth come,
Will purge His floor, and gather in
His precious wheat into God’s bin,
But will the chaff with fire destroy !”—
Thus spake this Heavenly envoy.

“With water I indeed baptize,
But He that cometh after me,
The Holy Ghost—Heaven’s richest prize,
In baptism will bestow on thee !”
And all Jerusalem went out,
And Jordan’s region, round about,—
The Pharisee and Sadducee
E’en sought the coming wrath to flee.

A hush fell on the waiting throng,
A potent influence filled the air,
The birds had ceased their choral song,
Expectant hearts were quivering there;
Yet none knew why, till from the press,
A manly form of sweet address
The herald sought, to meekly crave
The baptism he the people gave.

“O Son of God ! why comest thou
To be this day baptized of me ?
More fitting far, that I should bow
To earth, and be baptized of Thee !”—
“ ’Tis He—Messiah ! He is come !”
In thrilling whispers breathed each one ;
And hearts, awe-stricken, bent in prayer :
The gates of Heaven had opened there.

But Christ replied—for it was He ;
“Nay, suffer it to be so now !
Since in this way fulfilled may be
All righteousness, therefore I bow !”
And Jordan gained new honor that day,
Though He’d no sins to wash away ;
Hence sacred is that stream to those
Who in His promises repose.

But if amazed at first, the throng,
What wonder filled them as they gazed :
The birds of air brake forth in song,
And as all eyes to Heaven were raised,
Behold ! its gates were swung ajar,
And swift descending, like a star,
A spotless dove of purest white,
Came darting down a beam of light.

As panting on His breast it lay,
While from the water He withdrew,
They heard a voice from Heaven say,
“This is My Son, beloved and true!
In Him I am well pleased!”—and then
There rose one solemn, deep AMEN!—
That hour the Son of Righteousness
Went forth the waiting World to bless.

MOTHER, HOME, HEAVEN.

In beatific strains, these three
Might well engage the minstrelsy,
Of all this mundane sphere.
Inert that heart, and cold indeed,
Whose pulse, responsive, gives no heed,
These sacred words to hear.

My Mother! how that holy name,
Across the chasm of sin and shame,
Which I have placed between;
Comes to me on the morning air,
And through the sultry noonday glare,
And in my midnight dream.

The world has cast adrift her boy,
His heart is hard, and there's no joy
 That thrills his callous breast;
But messages of love still come
From Mother, in the dear old home,
 Inviting to its rest.

To rest at Home! Ah, can it be,
That 'neath the dear Old Family Tree,
 I'll sit again—forgiven?
And kneeling by my mother's side,
Relinquishing my stubborn pride,
 Start out anew, for Heaven?

That land of endless peace and joy,
Where streams of bliss without alloy,
 Flow ever to the blest;
Where souls from sin find a release,
The wicked from all troubling cease,
 The weary are at rest.

Away! false pride and sin, away!
No more unto your blighting sway,
 Yield I, a devotee!
But guided by a mother's hand,
At home, I'll seek that Better Land—
 I make my choice, THESE THREE!

IN CHARITY.

St. John, Chapt. viii.

A lithe and graceful form, in comely robe,
With golden tresses that now half concealed
A face, tho' weak, yet very fair and sad,
Where shame o'er innocence exultant rode
On blushes hot, that tears could not efface;
Her sin, a yielding to the tempter's voice.
Her shrewd accusers, with a purpose hid,
Had led her, sorrowing, on that lovely morn,
Unto The Temple, where the Savior taught,
That from His kindly lips they might report
A verdict adverse to the Jewish law.

As teaching, on His words the people hung,
And glad received the bread of life He brake,
Those wily Pharisees their captive brought,
And placed her in the midst. — "O Master!
This frail one now before Thee, we accuse
Of conduct, whereof Moses' sacred law
Decrees the guilty culprit must be stoned:
What sayest Thou?" — He saw th'intent,
And bending o'er, with finger listless wrote

Upon the earth, as if He heard them not.
Persisting still for answer, He looked up,
And with a calm indifference to them spake :
“He that is sinless now among you all,
Let him be first to cast at her a stone !”—
And then He wrote again upon the sand.

What accusations smote those crafty hearts :
What memories of the recreant past arose.
How in their souls His words burned deep ;
And though His eyes to earth were turned,
Yet how they felt Him read each sinful life,
And closely scan the failing each would hide.
With self-accusing, they in turn went out,—
The eldest first, and thus on to the last ;
And Jesus, left alone, rose up and saw
The woman standing in the open space.
The tearful eye, the contrite sigh and moan,
His kindly heart with deepest pity moved ;
And looking back upon her past, He saw
The tempter strong assail the weaker will,
And thus—and thus, she fell.

In calm, benignant tone, the Savior spake :
“O Woman ! whence are thine accusers fled ?
Hath no man condemned thee ?”—

“Nay Lord, no man!” she passively replied.
 “Neither do I condemn thee! Go thy way,
 and sin no more!”

“SUFFER LITTLE CHILDREN—”

St. Mark, Chapt. x.

Why trouble ye the Master now?
 Can ye not see that on His brow
 There rests a look of wan distress,—
 That He is faint with weariness?

Why bring the little ones to-day?
 Far better leave them at their play;
 With joyous health their faces glow—
 Those ruddy forms no *suffering* know!

But see ye not the blind and lame,
 The palsied who for healing came,
 The sick ones moaning their distress?
 These all now on the Master press.

And would ye add unto His task,
 By pressing forward, but to ask
 A blessing on those little heads,
 On whom your love *its* blessing sheds?

'Twas thus the kind disciples spake,
And stayed, for their dear Master's sake,
The mothers, who with pious zeal
Came at the Savior's feet to kneel.

He heard, and as that careworn face
To look of tenderest love gave place,
With open arms, in thrilling voice,
He bade those mother's hearts rejoice :

“O suffer ye the little ones !
Forbid them not, but let them come !
Of such is Heaven's kingdom fair !
No other gems of earth, so rare !

“Except your hearts like theirs become,
Ye cannot, when life's work is done,
Join in the anthems of the blest,
In that Eternal Land of Rest !”

And in His loving arms, were laid
The cherub boy, and tiny babe ;
And gently on each little head,
A blessing, from His lips, was shed.

THE MODERN SAMARITAN.

(Adapted from Luke, x.)

A certain man went down to York—
Perhaps to see the busy town—
Perhaps he went in search of work :
But certain 'tis, he ran aground,
Among the thieves of York.

At midnight hour they gave him beer,
Envenomed with vile "knockout drops;"
They beat him to his death, quite near,
Then robbed him of his purse and watch,
And threw him in the street.

The sun, next morning, rose less clear,
And looked in pity on the scene,
While Nature stooped to drop a tear
O'er him, who all his life had been
An honest workingman.

A deacon of a church up-town,
Came rolling by, in th' morning gray—

He saw the man, and with a frown,
Quick reined his steed across the way,
And passed, on the other side.

A learned "D. D." came next along —
A man who from the sacred desk,
Essays to prove by logic strong,
That God's own Book is not the best
That could have been produced:

He saw the bruised and prostrate form,
Yet raised no kindly hand to aid;
But turned away with look of scorn,
And passing by, contemptuous said,
"It is the work of Rum!"

Next came a coal man, with his cart,
Whose face the grime of labor bore;
Yet 'neath whose coat, there beat a heart
As warm as human breast e'er wore —
He paused, to view the scene.

That kindly heart, a fellow man —
A stranger saw, in deep distress:
A father, whose dear ones, e'en then,
Might waiting be for his caress,
When he should safe return.

With tender care that son of toil
Knelt by the prostrate stranger's side,
And tho' he lacked the "wine and oil,"
Yet in his unskilled way, he tried
To bind the wounds disclosed.

With careful hand, he placed him in
His humble cab, and drove away;
That in his own home, he might win
Him back to life again, that day,
And spare him to his friends.

Which now, was neighbor—of the three,
To him that fell among the thieves?
Sure he that mercy showed, must be
The man who in your heart receives
The verdict—one day prized!

That day, when at His just decrees,
Men from before His face shall flee:—
*"For inasmuch as not to these,
Ye likewise did it not to Me,—
DEPART! I KNOW YOU NOT!"*

THE RESCUE, AND THE SAVED.

Night's shadows rest upon the deep,
The earth is wrapt in sleep profound ;
While angel bands their vigils keep,
The watchman walks his lonely round.

A lurid light attracts his gaze—
“Sure that is not the waning moon !”
Still brighter grows the humid haze—
“Has morning dawn arrived so soon ?”

'Tis Fire ! *Fire!* Some home's on fire !
Call the brave laddies for the fight !
Its flames are leaping high and higher—
Quick lads ! a home's in flames to-night !

The fight is on—the swish and hum,
The hiss of steam, and shouts of men,
Proclaim the conflict has begun—
But hear that cry—again ! again !

It breaks upon the midnight air,
In thrilling tones, and accents wild—

“My child is up that burning stair !
Oh save ! oh, save my darling child !”

“I’ll go ! I’ll go !” a brave lad cries :
“Boys, keep a stream lightly on me !”—
With eager haste, aloft he hies,
The flame-imprisoned child to free.

Oh dread suspense !—But look— up there !
The child, wrapt snugly from all harm,
Is borne adown that blazing stair,
And safely laid in its mother’s arms.

A shout goes up, but the “Well done !”
Thrills not the hero’s failing ear ;
The burned and dying form sinks down,
While angels bend, these words to hear :

“Mother!— Savior!— coming !— com —”
And flown to Him by whom ’twas given,
A hero-soul—its life work done,
Has joined th’ angelic hosts of Heaven.

LAZARUS THE BEGGAR.

St. Luke, Chapt. xvi.

'Twas noon—a summer day.
The balmy air, with fragrant odors filled,
Moved lazily, and thro' the graceful palms
Soft sighed to murmur of the crystal fount,
Where birds of colors gay the pinion laved,
Disporting in the rainbow-tinted spray;
And ever and anon, with voice refreshed,
Ascended to the leafy bowers o'erhead,
To warble forth their notes of joyful praise.
While from within the stately palace walls,
In dulcet strains, the notes of lute and harp
Stole on the ear; and din of hurrying feet,
And clink of wares, and odors of choice fare,
Bespoke the rich man at his midday feast.

Two massive columns stood,
Superb in marbles graced by sculptor's art,
Like sentinels, on either side, to guard
The entrance to this passing fair domain;
And cedars from historic Lebanon's groves,
Lent a rich shading to th'enchanted scene.

While all within of lavish bounty spake,
The beggar Lazarus, hungered, lay outside,
Desiring to be fed of th' crumbs that fell
Beside the rich man's board. But all in vain;
And only canine strays their pity showed,
As at the gate he breathed his plaint.

That night the beggar died—
Or what we all call death, his pulses stilled.
But Lazarus woke in Paradise. And there,
With early vigor health and hope renewed—
No pangs of hunger gnawing at his heart,
No spurning of the haughty rich man's foot,
He breathed th' inspiring air that flows
O'er æther plains with healing on its wings;
And basking in elysian fields, bestrown
With beauties rare, unto the earth unknown,
His thirst allayed at limpid fountains pure;
While noble men sincere, and women true,
The hand of fellowship most cordial gave:
And one of royal mien—e'en Abraham,
Became his bosom friend.

Secure, with goods laid up for many years,
In pompous ease the rich man sat, composed;
Nor deemed that aught could mar his peace,

Within those palace walls. O vain conceit !
One day the angel Death, a shaft let fly,
And thro' the walls, it pierced his iron heart;
And sinking down, he died, as dies the least,
The lowest thing on earth, at God's decree.
But in the realms of pain his soul awoke ;
And seeing Lazarus from afar, implored
His royal friend to send him to his aid,
That he might soothe his woes.

But Abraham replied ;
"Remember, Son! that in thy lifetime thou,
Ungrateful all thy bounties didst receive,
While unto him whose services ye crave,
Came only evil. He is happy now,
While thou, reciprocal, his pains dost bear.
Besides, unlike as in our former sphere,
A bound impassible is strictly set
Betwixt the good and ill; so that none may
To thee go hence, or thou come thence."

Imploring still, the rich man further spake:
"A warning to my brothers yet on earth
I fain would send, lest they come also here!
Oh, grant some child of light may bear
A message to them there!" In tender tone

God's saint replied, "They have the books
Of Moses and the Prophets for their guide;
Scarce would they heed one from the dead,
If not the warnings that the Prophets gave"
— — — And thus the colloquy was closed.

The following lines were suggested by the reply of Hon. James G. Blaine, candidate for President of the United States of America, in 1884, to the inquiry as to whether or not he was a Catholic.

THE LAMP STILL BURNS.

*What sought they thus afar?
Bright jewels of the mine?
The wealth of seas? the spoils of war?
They sought a faith's pure shrine.
Aye! call it holy ground—
The soil where first they trod;
And stainless left what there they found,
Freedom to worship God!*

Mrs. Hemans.

And has that sacred trust
 Been guarded faithfully,
And saved from time's decay and dust,
 By the sons born of the Free?
Or has the flight of years,
 And bitter war of creeds,
Despoiled the temple, laid in tears,
 And reared by noblest deeds?

Has that intolerance dire,
 From which they fled before,
Quenched out the sacred beacon-fire,
 Left bright on Plymouth's shore?
Or burns there yet upon
 Columbia's holy shrine,
That Lamp of Hope, hailed by men from
 The lands of every clime?

Three centuries—almost,
 Have flown, since first was heard,
Along that stern and rock-bound coast,
 Those hymns the echoes stirred;
But that the lamp still burns,—
 The hope of the distressed,
Who toward its radiance gladly turn,
 From every land oppressed;

Recall the words of him—
Columbia's gifted son;
Whose fame, which time can never dim,
Is *more* than victory won.
Whose faith in things divine,
Draws not the narrow bound,
But looks the works of grace to find
Wherever church is found :

“A Presbyterian staid,
My sire, of the olden line ;
My mother's vows were daily paid
At the Holy Virgin's shrine.
In the church paternal, learned
I first from out the Word;
And later, to that fold I turned,
To worship there, the Lord.

“Yet not for all there be
In the Presidential name,
(Though given a thousand-fold to me,)
Of honor, wealth, and fame,
Would I offences give,
Or rash that faith deride,
By which my mother sweetly lived,
In which she peaceful died.”

CHAPTER IV.

LIFE ON THE FARM.

WHEN I returned from the war, I took up teaching again for a time, but my parents were getting old, and I was needed at home; and, in keeping with a vow I made when recovering from a serious sickness, while in my country's service, I responded to the call of filial duty.

During those days of convalescence aboard ship, I fell to meditating on the disappointments and heart-aches I had caused my parents, and that even then they were sitting lonely in the old home, mourning for one son dead, and the other far away, mid scenes of strife that might never give him back to them again; and I then made the vow, that whatever my tastes and aspirations, if I ever reached home again, I would remain with them through their declining years.

That vow was faithfully kept. I duly assumed the management of the farm, at the same time continuing my scientific studies, which I am in truth compelled to say, sometimes received more attention than the growing crops. But under my father's direction, and profiting by his advice, I made a living for us—and that was all.

Soon after deciding to settle down, I married a young lady from Albany, N. Y.—Miss. H. Alida Bradt; a granddaughter of Gen. Garrett Sager, who was a prominent man of his day, and a large landholder in the Hudson Valley.

She was willing to share with me, "Life on the farm," and we soon found ourselves members of a very pleasant set of young married people, with whom we enjoyed many happy social events, which are still bright places in our memory.

We indulged in parties, picnics drives, sails on the beautiful Canadarago Lake; and having early learned to play the organ, and also to read vocal music fairly well, I was chosen for many years to serve as chorister,

or leader of the musical part of our church service; and our weekly meetings for choir practice were always pleasant occasions.

Thus life ran smoothly with us, it being only diversified by my struggles and disappointments in the field of invention, to which reference is made in the introductory pages of this volume, and an occasional discovery or triumph in the physical investigation I was pursuing. So there is little to relate of interest to the reader, till we come to the important event which broke up this period of calm, and enlisted me more actively in the cause to which I have given the best thought and effort of the best years of my life.

Both of my parents and my uncle were dead, and my promise to remain on the farm no longer held me; yet still I tarried in the old home, which was endeared to me by so many ties, old and new. But a swift stroke of Providence changed my course, which approaches so nearly to the miraculous, that I will recount the circumstance for the benefit of those who no longer believe that God is able to work miracles; forgetting that

their own bodies, with their various capabilities, are more wonderful works of his hand, than those recorded events of Sacred History which they seek to discredit.

A PERILOUS INCIDENT.

The event of which I write, came about, in this wise:—My eldest son, then twelve years old, and myself, seated on a high load of farm produce, were coming down quite a steep declivity in the highway, at the foot of which was a broad and stony water-channel, spanned by a wooden bridge. In making this descent, something about the wagon gave away, and the load came against the horses, a young and spirited pair, and with an uncontrollable frenzy, they dashed at full speed down the hill.

On reaching the bridge the load came in contact with the side railing, which stopped the wagon instantly, freeing the horses, who continued their flight, and firing me, as from a catapult, diagonally over the railing of the bridge, and on an inclined curve across the

channel, against the base of the opposite bridge-pier, full forty feet from my elevated place on the load.

I was taken up insensible, and apparently *crushed*; and though found to be still living, yet the physicians who were called, considering the nature and extent of my injuries, and the fearful force with which I was projected across the chasm against the stone pier, could not see how, in the name of Science, my life could be spared.

But a healing power whose potency is no less to-day, than when it enforced the command, "Lazarus, come forth!" blessed the human agencies employed for my recovery, and to the surprise of all, I was restored to health and strength again; and but for a broken limb, which took a little more time to mend, I might within three weeks from the time of the accident, have mingled once more with my fellow men.

But the learned skeptic, employing the Irishman's logic, will remind me that it is not the distance nor force of the fall that inflicts the harm, but the mode and conditions

of alighting; and that I doubtless struck the soft side of the pier, which spared me from fatal, though not from severe injuries; which view of the circumstance would seem to divest it of its remarkable features.

Assuming that the modern logician would dispose thus readily of the matter, in so far as it pertains to myself, I will now give him something a little harder:—My son shared my elevated seat with me when the terrible shock came, and what became of him?

Driven by the same impulse, he naturally went in the same direction as myself, but came a little short of the bridge-pier against which I landed, and fell among the rocks and bowlders which covered the bottom of the nearly dried up water-course;—*and from that fearful plunge he came forth as unscathed as though he had simply fallen from his bed into an air pillow;—not even a scratch, or rent, or a button off!*

The physician who attended me, and a score of other reputable people who are living at this writing, will readily testify to the truth of the statement I have made; and yet

the language of approved wisdom in the present age is, that all results are brought about by the undeviating operation of natural laws—that like causes produce like effects, and that God cannot, or will not, at any time interpose a special providence.

This incident virtually brought about the change in my affairs which I had been contemplating, but lacked the decision to make. I sold a portion of the farm, retaining the homestead part, and at the age of forty, I removed to a neighboring village, and gave my whole time to the work of my choice.

ENTERING THE LECTURE FIELD.

The subject of Electricity had, within the few years previous received quite an impetus, through the practical development of, and remarkable results obtained from the telephone and the electric light. Other discoveries quickly followed, which a previous smattering of the science in general, enabled me to appreciate, and I soon fell to keeping abreast with the times, by carefully reading

and studying the leading electrical journals of the day.

I became so impressed with the need of a more general diffusion of knowledge on this important subject, that I was soon preparing a lecture, which treated in a plain, non-technical way on both its theoretical and its practical phases, which was completed in due course of time, and called, "Electricity, theoretical and applied."

I decided to go before the public with this lecture, for the reason that I believed in so doing I would be imparting useful information, and might also gain such experience, and perhaps financial return, as would assist me in the preparation and presentation of the more important work on which I had been so long engaged.

I purchased a fine stereopticon for illustrating, of the famous makers, J.W. Queen & Co. of Philadelphia; securing at no little trouble and expense a set of views specially prepared to assist in clearly presenting my subject, and thus equipped, I launched this enterprise with zeal for its success.

But my audiences, though always select, were never large, and I soon found that this lecture, like my present astronomical series, was considerably ahead of the times—the people yet regarded electricity as something so subtle and mysterious, that it would be utterly useless for them to listen to any dissertation on it, much less try to comprehend it; and when, after illustrating and explaining the wonderful results already attained, I would soar to untried fields, by predicting its application to the street car, and to the workshop, and suggesting that waterfalls, river currents, &c. would yet be harnessed to generate electric currents for transmitting their wasted power to distant and more desirable points, they just knowingly said, “The man is an enthusiast, a visionary, a crank!” and they gave me almost as wide a berth as the wise men of to-day are giving me on the subject discussed in subsequent chapters of this volume.

But those predictions have all been realized—those wonderful results are with us to-day; and thanks to the ingenuity, skill,

and enterprise displayed by mankind, when once their prejudice is overcome, and their interest aroused, they came sooner than even I had hoped or predicted.

And yet the work in this popular branch of human achievement goes on, while the votaries of a still grander science are resting inertly on a theory whose tenets lack the support of true physical demonstration, and are antagonistic to the words of Holy Writ.

FORTUNE STILL COY.

My early estimate of the importance of acquiring worldly means to assist me in promoting my work was still entertained, and learning, through the electric journals, that the public was already becoming interested in the problem of operating railways by electricity, I entered the promising field of invention thus thrown open, and early in the contest evolved an electric railway system, and applied for letters patent, which were however refused at first, on account of some technical error in the application.

But several months afterward I received a communication from a gentleman in New York, informing me that he was one of the examiners in the electrical division of the U. S. Patent Office, at the time my application was taken up and disposed of; that he had since resigned his position, and appreciating the importance of my invention, and its just claims to recognition, if such claims were properly presented, he desired to make a business proposal for reopening the case, and prosecuting my claims to a successful issue, for an interest in the patent, when it should be granted.

The gentleman's business standing being found satisfactory, I accepted his offer, and he in due time succeeded in obtaining letters patent, which embodied a good strong set of claims; and being so early in the field, we naturally hoped for a bountiful return when the reaping time should come.

But as capital always moves cautiously in the direction of innovations, little headway was made with electric railroading for several years; and in the meantime a man

in Philadelphia set up a counter claim to priority of invention, and actually had an interference case declared between his application and my existing patent, then over two years old.

We defended the case before the Commissioner of Patents, by presenting a clear and concise statement of duly attested facts; but our opponent, aided by a voluble tongue, a lively imagination, and an elastic conscience, won the case, and Justice once more showed that she was blind.

Electric railways by this time began to assume practical form, and considerable attention was being given to necessary details. Prominently among others, a comparatively noiseless and anti-friction gearing for transmitting the power from the motor shaft to the car axle, was sought for. I devised and constructed a gear to meet these demands, which I embodied in a working model of my earlier railway system, and came to N. York with it, calling first at the office of the leading electrical journal of America, if not of the world, at that time.

The proprietors of this journal commended, and seemed well pleased with my work; and on learning that I wished to exhibit it to the various electric companies in the city which were becoming interested in electric railway systems, they kindly gave me a general letter of introduction, which gained me a cordial reception wherever I went; and after considering the matter for a few days, they became so impressed with the value of my invention, that they offered to get it patented and introduce it to the public through the medium of their journal, for a one-third share; which offer I accepted.

I returned to my home in most excellent spirits, feeling that a satisfactory solution of the financial part of the problem was well nigh assured. My invention had been seen, examined, and warmly commended by the various companies I visited, and I received such kind courtesy at their hands, that naturally I felt very much encouraged. And when the publishers of the foremost electric journal of the day decided, after a careful examination as to its utility and originality,

to interest themselves in it, I could not but feel that my visit to the metropolis had been a highly successful, as well as a pleasant one.

I was living in the city of Utica, N. Y. at the time, and in a few days after reaching home I received a neatly drawn up form of application for letters patent, which I duly executed and returned to the gentlemen, and they sent it at once to the Patent Office.

The season was the early Spring-time, and the pleasant days sped swiftly by, with hope on their wings. April melted into May, that month of verdure into the "Month of Roses," and when the balmy air was filled with the mellow sunlight, the perfume of flowers, and glad notes of song-birds, with which my heart was in happy tune, a message came one day, which tinged this bright prospect with the leaden hues of December.

The communication was from the Patent Office, and inclosed reference-drawings and description of an earlier device slumbering on the record, which though lacking those practical essentials to success contained in

mine, was yet enough like it in principle, to lead to the rejection of my application—and another bubble was pierced.

TRUTH, OF HUMBLE ORIGIN.

Not disposed however, to relinquish the struggle, I renewed a correspondence with a manufacturing firm in a neighboring city with reference to another invention of mine, and at their invitation to visit them, set out again, with strong hope of making a satisfactory business arrangement. But failing in this also, I returned to my home, there to find verified the old adage, that disappointments and troubles never come singly—my youngest son, a lad of ten years, had lain in a semi-conscious state for several hours, and the physician who was promptly called, pronounced him dangerously sick.

Swift transition for me, indeed! So lately basking in the sunshine of a calm, confident and happy hope! So soon sitting bowed and broken amid its ruins!

Summoning all my remaining energy, I

quickly rallied from this three-fold blow, and with parental solicitude turned to the rescue of my boy; and tho' the Dark Angel at times hovered very near, yet his life was spared, and aided by the skilled and faithful physician, we slowly nursed him back to health and strength again.

Then I held a council of war (one member present) for reviewing the situation. In the first place, a glance in the mirror revealed the fact that I was growing old; and view the matter as I would, I could not deny myself the concession that, with the talents and opportunities given me, I had made a fairly good fight for the worldly means which I deemed so essential for the preparation and successful presentation of the important scientific work I was pursuing.

Then came to me the recollection of an article I once had read, in which the author cited historic facts to show that nearly all important truths have come to the surface through great difficulties and humble agencies; and I there decided to give up the fight for worldly pelf, and pursue my work with

such aid as God might be pleased, from time to time, to give me.

Finding my ready money all exhausted, and no way open for me to earn a living in the city, we turned back to the farm again, and by working early and late for three long years, we succeeded in saving a little means besides making a comfortable living.

During this time I also prepared much of the subject-matter for my series of lectures, and began the construction of physical apparatus for illustrating and demonstrating the truths I wished to declare.

But desiring better facilities for promoting this latter branch of my work, I again removed to town and sought employment as a mechanic, being fairly skillful with tools. But my efforts were unsuccessful for many weeks; employment in the busy towns being denied me with a persistency bordering on malignity, as I, despondent, sometimes felt.

IN THE NIGHT WATCHES.

After a long time I succeeded however, in securing the position of night watchman in

a manufactory; and then I took up my work again, in connection with my regular duties, with a zeal and energy that knew no abatement. With the exception of two or three hours' steady work in the evening, and as much time in the morning, I was required but to make my hourly rounds of inspection, which would take little more than one third of the hour, and the remainder was devoted to working diligently at the vise or bench, by the dim light of a lantern, on my prospective set of physical apparatus.

The night's work ended, I would repair to my home, and after a few hours of sleep, give the remainder of the day to the work in hand; never remitting my efforts, till after many weeks I believed I had enough of my earnings laid by, to enable me to complete my preparations, and present the result of my researches to the people in a clear and comprehensive way.

I then gave due notice to my employers, and gave up the position, to give my whole time to the work. But I found there was still much to do, and when my savings were

running low again, to my great surprise and relief, a neighboring manufactory sent me word one day that there was a place awaiting me in their establishment. This came most opportunely, and was regarded by me as a special providence, for which I offered sincere thanks.

I entered at once on my new duties, which were mechanical day work this time, and for eight months, sick or well, I stood at my post, and never lost an hour when the works were running. Then, having saved up some more money, I asked for leave of absence, and putting the finishing touches to my set of charts and physical apparatus, I came to New York City to present the results of my life work in the defence of scriptural truth, to what I believed to be the representative people of the most enlightened, most tolerant, and most thoroughly Christian age of the world's history.

The result of my visit has already been made known in the introductory part of this work,—and is it strange I came away feeling, in the bitterness of my disappointment,

that the dark pall of bigotry which cast its gloom over the Middle Ages, was as a fleecy summer cloudlet, compared with what I ran against on that occasion?

Why! in those early days, men with new ideas were always accorded a *hearing*, even though they might be adjudged worthy of imprisonment or death directly after. But in this boasted age of advanced thought and cultured courtesy, I was condemned without an intelligent hearing.

CHAPTER V.

THE "HIGHER CRITICISM."

UP TO the time of delivering my lectures in New York, I had gained no adequate conception of the extent of the so-called "higher criticism"—I did not know that, except in a few notable instances, it had invaded the sacred desk; and believed it was confined in most part to the learned agnostics of the day, and that the Christian church would welcome as a valuable accessory an intelligent scientific effort, directed against those traducers of the Bible; and of 125 personal invitations issued, about one half were sent to clergymen in that part of the city where my unattended lectures were given.

Nearly a month later I however gained the audience of an association of clergymen in the city of Utica N. Y., and gave them an abridgment of my two astronomical lectures

entitled, "Nature versus Copernicus." And while most of those college-bred men manifested a deep—some of them an intense interest in my discourse, and tendered me a vote of thanks at its close, yet I never heard that any word of commendation was given to the public, other than the brief comment of the daily press; and several months later one of Utica's clergy delivered a Sunday afternoon discourse before the Y.M.C.A. of that city, in which he essayed the scientific demolition of one of those grand miracles of the Old Testament, which I make a strong point of in my first lecture, "The Bible vs. Copernicus."

I criticised the gentleman's untenable position in the following newspaper article, and the animus of the higher criticism may be inferred, I think, from his declaration of principles, in the controversy which ensued, as given *verbatim*, in this connection :

Editor Utica Daily Press :

I learned, through a yesterday's Utica paper, that one of your esteemed townsmen

delivered a lecture in Association Hall Sunday afternoon, 4th inst. on Joshua commanding the sun and moon to stand still—and my Bible says they obeyed him; but the report makes the reverend gentleman say that this was only so in appearance—that what God really did was to so increase the density of the atmosphere that its greatly increased refractive powers kept the sun apparently elevated far above its true position in the heavens, and what seemed to ordinary minds a miracle, was really only the result of natural laws.

With all due deference to the learned gentleman's opinion, but with greater deference to, and reverence for the Old Book, than for any man's opinion, I will briefly review this explanation of what the Christian world has always regarded as one of the grandest miracles of the Bible.

The text of this event, found in the Book of Joshua, 10th chapt. 12th and 13th verses, says that in obedience to Joshua's command "The sun stood still in the midst of the heavens, and hasted not to go down for

about a whole day." Scientific authorities agree that, in its ordinary state, the maximum of refraction of our atmosphere (which is at the horizon,) is about 35' of arc, or a little more than one-half a degree. Now, if we admit that according to the Bible record, the sun appeared to the Gibeonites to stand still, or remain in one place "about a whole day," but really did not slack in its course, it would, in 12 hours after Joshua's command was given, either by its own motion, or the earth's rotation, or both, have been on the opposite side of the earth, and the refraction necessary to make it still appear over Gibeon, would have been 180° , which would virtually be turning the sun's rays back on themselves.

But if we take the position that the Bible is mistaken about the sun's appearing to "stand still," and that its progress only appeared retarded, then if we assume that it really made its usual progress throughout the day, and that one half of this was turned back by refraction, we would still have 90° of refraction.

Since however, we have broken away from the scriptural text, let us be still more liberal in our speculations, and assume that the sun apparently fell behind by refraction only one-fourth of its regular 12 hours' progress on that eventful day; this would yet require an atmosphere having a refractive power of 45° , which would be 77 times greater than the maximum of refraction of our atmosphere in its natural state; (which is $35'$) and much greater than that of any gaseous, or even liquid medium known to Science.

If it were possible to produce an atmosphere of sufficient density to cause such a refraction, all living creatures and inanimate objects not firmly rooted to the earth would float upward like a loose cork in the bottom of the sea, and far more disastrous results to mankind would be likely to ensue, than by the temporary halt of either earth or sun, or both, when restrained by the guiding hand of Omnipotence.

S. M.

July 6, '97.

THE DOCTOR'S REPLY.

Editor Utica Daily Press:

The report of my lecture was so indefinite and misleading, that I expected some one would take issue with statements there made. Reporters often fail to grasp the truth, as uttered, and a partial statement does not do justice to the speaker, even when it does not misrepresent him.

Mr. Miller evidently believes that the earth was arrested in its motion on its axis, and that in place of the sun standing still, in appearance, it did actually do so, and that this miracle lasted through a whole day, and on this basis he does a wonderful amount of philosophizing.

Parties who pin their faith to a literal understanding of our English translation of the Bible, often get into a fearful muddle. Mr. Miller regards our translation, we suppose, as a divinely inspired one, without errors or mistakes. With those who so regard it, we can have no argument; their faith, or

superstition is so immense that nothing can meet it. Only one thing is possible, to allow them to think as they please, and comfort themselves with their ignorance. The men who once believed that the world was flat and did not move, were the only wise men on earth, according to their own estimation, and the faith of the times in which they lived. The trouble of Mr. Miller and many others arises from their misunderstanding of the clause in the 13th verse of the 10th chapter of Joshua, where it reads: "So the sun stood still in the midst of heaven, and hasted not to go down, about a whole day." The sentence "About a whole day," should be rendered, though the day was whole, or finished, or ended. The idea of the sentence is, the sun did not go down, although the day was finished.

At a certain time of the month the sun is about to set; on the opposite side of the horizon the moon is just rising; this was the condition when Joshua desired that the sun should not set, until his enemies were thoroughly defeated, and the sun hasted not to

go down, though the day was whole, or finished. The time of the added light is nowhere given in the narrative, and is simply an assumption of parties who misunderstand the whole affair. The trouble is not with the Bible, but with a wrong interpretation of it. Ten minutes, or half an hour at the longest, was all the time required. It certainly did not take Joshua a whole day to defeat his already panic-stricken foes; they were just beginning their flight, and Joshua wanted to clinch his victory by following them and making their defeat absolute, and about 15 or 20 minutes—or half an hour at the longest—was ample time for all this.

Mr. Miller has been raising a fearful ghost, in order to have the pleasure of pounding it. Two days of daylight together, according to his theory, would indeed have been a stupendous miracle; but the Almighty never by miracle, or otherwise, did such a foolish thing as to give two days in one for the accommodation of a few strugglers in Palestine, at the peril of the whole solar system. He simply, by refraction,

lengthened one day 15 or 20 minutes, to exhibit his care for his chosen people of Israel. He never resorts to extraordinary means when simple measures will answer a great deal better. The object of the lecture was to show that by the simple law of refraction the whole matter could be accomplished without disturbing anything whatever, and this was done by charts and a demonstration by experiment, which, we think, was satisfactory to all present.

July 7, '97.

THE AUTHOR'S RESPONSE.

Editor Utica Daily Press:

Sincerely begging pardon in advance for presuming to differ with a distinguished clergyman and scientist on biblical and scientific points, yet as a firm believer in the truth and inspiration of the Bible, I feel that it would be a dereliction of duty, to pass unanswered the reverend gentleman's article on "Joshua and the Sun," in this morning's "Press."

A few years ago a congress of the most devout and cultured men to be found in all Christendom, assembled for a revision of the Bible; into which, it was believed by many, some errors had crept, through imperfect translation. This committee was composed of the profoundest antiquarians, historians, linguists and theologians, chosen from different creeds and countries; and when their labors were completed without discovering any material errors, a grateful hallelujah went up from all Christian lands, that the "Old Book" stood justified, and that the stronghold of skepticism, (claims of faulty translation,) was forever fallen.

But in the article which lies before me, the printer has it that a portion of the 10th chapter of Joshua does not read aright, — that it should read thus and so; — when I take up to-morrow morning's Press, I hope I may see notice of an erratum, signed by the man who set the article up.

This article also reads that the sun, instead of standing still, obedient to Joshua's command, was simply retarded, or delayed

in its setting, perhaps a half hour; possibly only 15 minutes. If we read carefully that portion of the 10th chapt. of Joshua running from the 15th, to the 28th verse, we find that from the time Joshua commanded the sun to stand still, to the "going down of the sun," the following events transpired :

Joshua and Israel returned to their camp at Gilgal—it took all of the preceding night to march up to Gibeon, (see Joshua, 10 : 9,) and they doubtless took as much, or more time in returning. They pursued their enemies with great slaughter, till the remnant took refuge within their fenced cities. It was told to Joshua that the five kings of the Amorites were hidden in a cave at Makkedah, and he ordered the mouth of the cave closed, and a guard set;—afterward he ordered the cave opened and the kings bro't before him. Joshua then commanded the captains of Israel to draw near and place their feet upon those kings' necks. This order obeyed, he addressed his people, assuring them that thus should the Lord do to all their enemies; and Joshua smote those

kings and slew them, and hanged them on five trees; all this before "the going down of the sun that Joshua commanded." Was that only a common day, or is the Old Book correct in saying, "There was no day like that, before it, or after it?"

As I represented in yesterday's communication, the maximum of refraction of our atmosphere is a little more than one-half a degree; which is equivalent to a little more than two minutes of time. Then if, as the gentleman surmises, the sun might apparently have been delayed only 15 minutes in setting, it would yet have required a refraction seven times greater than the maximum to produce such an appearance.

July 8, '97.

S. M.

THE DOCTOR'S ULTIMATUM.

Editor Utica Daily Press:

If Mr. Miller so chooses, I am perfectly willing that he should believe that the sun stood still for 12 hours, or 24, or any period that will satisfy him. There are some who

believe that he has stood still ever since. But Mr. Miller will please excuse me from believing the absurdity that the Almighty ever ran two days into one. The old woman said it made no difference to her whether the whale swallowed Jonah, or Jonah swallowed the whale; if the Bible said he swallowed the whale, she would believe it just the same.

Mr. Miller is willing only to accept a whole day for the standing still of the sun, because he thinks the Bible says so, when in fact the Bible says no such thing. It is only the error of his wrong interpretation. It says the sun did not hasten to go down, although the day was finished, made whole or perfected.

Again, how long Joshua remained in the camp at Gilgal, after his return from the slaughter of his foes, the narrative does not say; but probably long enough to rest his wearied soldiers, who had been marching the night previous and fighting all the next day. The time may have been a day or even several days, before the transactions in the

16th, and following verses took place; but Mr. Miller huddles all these things into the brief time the sun stood still; work sufficient for several days at least.

In all history periods of time are very imperfectly given, and in this case certainly so. It was not in human endurance for any men to stand such a strain as Mr. Miller would put on the soldiers of Joshua, — it would demand a miracle in each individual person.

Let us remark that the 15th verse he refers to is omitted in several manuscripts; the Septuagint omits it altogether, the Anglo-Saxon and the ancient Hexapla versions have it not, and it is no doubt a simple gloss by some late transcriber. The 20th and 21st verses are much out of place, and are meaningless where they stand; and the whole chapter has been very much mixed up by transcribers; and that “learned congress” of distinguished clergymen, who met to revise the Bible, to which Mr. Miller refers, had neither the ability nor courage to do anything with it, and simply left it in its

glorious obscurity, as something they knew nothing about. It serves however, one good purpose; it shows how much some persons can believe.

This whole matter, as we stated in the beginning of our lecture at the Y. M. C. A., was not one of ability on the part of the Almighty, but one of methods. How did the Creator accomplish the work, by miracle or by using the ordinary laws of matter? We think he used the general laws, and did everything without in any measure disturbing the earth or the sun. Any other theory calling for difficulties without end, and those who defend, or attempt to defend the Bible on other grounds, simply hurt, in place of helping their cause. As we stated in our first article, we can have no argument with those who cling to old and absurd methods of interpretation. Such "Bible scholars" must simply die out. They cannot be instructed or converted. Mr. Miller will please excuse us from any further consideration of this subject at present.

July 10, '97.

THE AUTHOR'S FINALE.

Editor Utica Daily Press:

Noticing in this morning's Press that the learned divine calls a halt, and since we have thus far only been playing with pebbles along the shore, kindly permit us, in conclusion, to take one hasty glance toward the broad ocean of scientific truth which, as yet so imperfectly explored, lies spread out before us.

Respecting this scriptural narrative of Joshua and the sun, it has been doubtfully regarded by scientists indorsing the Copernican theory of the universe, for the reason that the sun being considered already at rest (relatively to the earth's orbital movement,) it must therefore appear to us to travel around the earth wholly on account of the earth's rotation on its axis. Then the sun appearing to stand still on Gibeon, could only have been caused by the earth ceasing to rotate; which it is claimed, would not only have had a disorganizing effect on

the whole solar system, but would have been highly disastrous to everything on the earth's surface.

We are taught that the earth has two motions,—its diurnal rotation on its axis, and its annual revolution around the sun. Now, if the earth's progress in its orbit were dependent on its rotation—that is, if it rolled along in its orbit like a car wheel on a railroad track, when it ceased rotating its orbital motion would also cease, and the whole system be more or less disturbed.

But we find that its orbital motion is far more rapid than its rotary motion, and consequently independent of it; the earth moving in its orbit about 63 times faster than it would if it simply rolled along like a ball on a plane surface. Then, to stop its rotation on its axis, would not necessarily disturb its orbital movement, and would not therefore disturb the order of the system to which it belongs.

But would not everything on the earth's surface fly off at a tangent into space? No, for this reason: The resultant of these two

motions of the earth, as affecting any object on its surface, (the orbital motion so largely predominating) would deviate so little, comparatively, from the orbital line, that if the earth simply ceased to rotate on its axis, the slight change from resultant to orbital motion alone, would hardly be felt by its inhabitants, since the absolute movement of any given portion of the earth's surface (except at the poles) is never quite uniform through the twenty-four hours; its rotary movement being direct, and added to the orbital motion at night, or when on the opposite side from the sun, and retrograde, and subtracted from the orbital motion during the day, or when turned toward the sun.

If however, we take the position that the astronomical plan outlined in the first chapter of Genesis, which would appear to place the earth in the centre, is the correct one, and that the regular succession of day and night is produced by the reciprocal motion of the earth simply rotating on its axis in one direction, while the sun moon and stars revolve slowly around it in the opposite di-

rection, it could make but little difference to the other bodies of the system whether the earth rotated on its axis or not ; since, being permanently located at the centre, its attractive influence would in either case always be the same. And to cause the sun to stand comparatively still on Gibeon, it would only have been necessary, as in the preceding figure, to gradually retard the earth's rotation till it ceased turning on its axis ; which might have been accomplished inside of one hour without disturbing the lightest leaf on any tree ; as objects, even at the equator, only move by the earth's rotation, 1,040 miles an hour, or about 26 times as fast as an ordinary mail train, which can be stopped without jolt or jar in one minute.

Pursuing this line of thought, it may yet be found, on a fuller and freer investigation, that true science is in perfect harmony with those portions of the Bible which the higher critics would stamp as improbable and untrue ; thereby unintentionally, yet no less certainly, leading men to doubt the whole.

July 12, '97.

S. M.

I made several more efforts to get my lectures before intelligent audiences, but failed to secure any satisfactory engagement, and most earnestly desiring to give the results of my work to the public, I prepared a series of short articles, treating in concise language on the physical facts I was ready to illustrate and discuss.

These I offered, first to astronomers and scientists, for examination; but they all declined to receive them, and one of our Government astronomers declared plainly that he would not take time to read any article differing with the theory of Copernicus.

I next tried the publishers; but they had so many beautiful works of sentiment and fiction on hand, awaiting publication, that they could not for a moment consider a work devoted to unpopular, though undeniable scientific truths, ranged in defense of that "Word" which is the hope of the world.

The newspapers and periodicals were next applied to; but they were too deeply engrossed with the affairs of the present, to

waste any thought on an effort to correct the errors of the past, and establish on a firmer basis the hope of the future.

It will therefore be seen that both my lectures and my writings have thus far met with a very frigid reception; having been *avoided*, not only by the scientists, and the self-styled "higher critics" of the Bible, but by the "old school" theologians as well; the latter of whom, though believing the Bible, are yet content to let theology and science drift along in their wonted channels, regardless of the encroachment the one is making on the other; passively raising the question, "What need of disturbing their present relations?"

To such interrogation I would reply, that man, dreading annihilation and panting for immortality, fondly hopes, when the rough journey of this life is ended, that he may live again, in a higher and happier sphere. The Bible alone gives promise of, and is his only guide to such a sphere—destroy its authenticity, and with nothing else to follow, that hope perishes.

This Bible outlines, in a general way, the great plan of the universe; but in the 16th century Nicolaus Copernicus, a German scientist, physician, and divine, disregarding the scriptural plan, formulated a new and entirely different one, which was published in 1543, but was however for many years rejected by the Christian world, who believed the Scriptures true.

But in 1609 Johann Kepler, an eminent German mathematician, who enjoyed the confidence of the people, published an indorsement of the theory of Copernicus, with some new theoretical laws of motion, which would appear to sustain it,—and the first decisive step was thus taken toward elevating the science of man above the inspired Word of God.

And what is the result? To-day the Old Book is being ruthlessly assailed on every hand. Men, in their vain-wisdom, would tear line after line and precept after precept from its pages, and leave the grim shadow of doubt hanging over what remains. We are told the story of Jonah is a myth, that

Moses did not write the Pentateuch, and that the miracles of the Bible in general, including the miraculous birth of our Lord and Savior, are simply tales of fiction.

Yet many of these wise critics profess to believe in, and love that Savior who, while on earth, is recorded as constantly referring to, quoting from, and indorsing the Scriptures. And the more they ignore his indorsement, the more they multiply the emblems of his crucifixion in their sanctuaries. This latter, may however be appropriate.

And what are we to receive in return for that which they would take from us? Only the morbid satisfaction of feeling that some of our fellow men possess the extraordinary ability plausibly to argue that this Book of promise and of hope abounds in fiction, and is therefore unreliable.

Such teaching must needs tend toward the gruesome conclusion of those morbidly wise men who esteem the present all there is of life, the scriptural Heaven a phantasm, eternal happiness an idle dream; leaving the dear ones gone before, whom we have

fondly hoped and prayed to meet again, to molder in the damp earth, to which we, ere long, must be consigned.

Is it not time then, that we retrace our steps, to see if that first step was well taken? Let us calmly, and without prejudice consider this question in the following chapters; keeping ever in mind the important lesson gained from human experience, that theory is one thing, and practical demonstration sometimes quite another.

*“It cannot be; each hope, each fear,
That lights the eye, or clouds the brow,
Proclaims there is a happier sphere
Than this bleak world that holds us now.
There is a voice which sorrow hears,
When heavy weighs life’s galling chain;
'Tis Heaven that whispers—Dry thy tears,
The pure in heart shall meet again.”*

LECTURES.

CHAPTER VI.

LECTURE I.—THE BIBLE vs. COPERNICUS.

WITH firm convictions of the right, fortified by God's Holy Word and his revealed Book of Nature, yet feeling keenly my own inability to battle with the learned of earth backed by the lore of centuries, with whom I have taken issue, I find myself shrinking from the weighty task which I have set me. And that I must know my testimony may be rejected, and myself contemned, weighs my courage down, as with a leaden pall.

But moved by a sense of duty, and a hope that the thoughts expressed may find a responsive chord in some heart, and prove a germ of truth, which may become a power in the coming years for winning men back to their primal faith in God, with awe and

humility I enter—dissentingly, the temples hallowed by the illustrious dead, and cherished by the profound living. But with God's Word for my guide, and his wondrous works for my justification, why then should I falter, though men may frown?

While mankind have been moving down through the ages, and human wisdom has been advancing, methinks our Heavenly Father, with displeasure, sees the growing tendency of men, as they delve deeper and deeper in the mines of human knowledge, to misconstrue, combat, or even to reject the teachings of his sacred volume. But while skepticism assails and science ignores, the soul redeemed, with eye of faith can pierce the mazes men have wrought, and trace in each inspired page the authorship divine.

Where the Christian who, in the first raptures of his new-born existence, that has not felt all doubts and seeming inconsistencies vanish, and a deep conviction pervading his inmost being, that the Bible is true? Who the dying saint, just launching out from the shores of time, and gazing through

death's portals toward the New Jerusalem, that has ever renounced his faith in it?

Thanks be to God, the Bible is true! All nature breathes it! Angel voices hymn it! The dying witness to it!—and we will trust our all upon it. O, we love to believe the Old Book true; it is the anchor of our faith, the day-star of our earthly existence; on its precious promises hang all our hopes of Heaven. Without it we would be indeed, like a lost ship on an unknown sea, without chart or compass, drifting, it knows not whither; or like a shipwrecked mariner on a desert isle, with vision bounded and obscured by the black clouds of chaotic night hanging o'er his head, and the black waters of despair breaking at his feet.

Accepting it then as true, and from God, lest we err in its perusal, let us keep in constant recollection its last solemn warning, and the possible breadth of its application: “And if any man shall take away from the words of the book of this prophecy, God shall take away his part, out of the Book of Life.” *Revelation, 22 : 19.*

.

Reverently, prayerfully, let us then open at the beginning, and accept what we may find. As the first chapter of Genesis is familiar to all, we will refrain from a general reading, inviting your attention more particularly to the 16th and 17th verses, which read as follows:

“And God made two great lights; the greater light to rule the day, and the lesser light to rule the night: he made the stars also. — And God set them in the firmament of the heaven to give light upon the earth.”

To give light upon the earth! Can this be true? Why, the proud science of Astronomy teaches us that this greater light, the sun, is the centre of a system, around which the earth, with other planets, revolves; the earth being simply a planetary attendant of the sun, and more than a million times its inferior in size. But this first chapter of Genesis appears plainly to imply that the earth is the centre, and that sun, moon and stars, were created especially to serve the earth, and set in a firmament enveloping it.

True to my convictions, and my faith in God's Word, I shall assume that the Bible is correct, and shall undertake to show, by this series of lectures, that Science *may be wrong*.

The 7th verse of the chapter reads, "And God made the firmament, and divided the waters which were under the firmament, from the waters which were above the firmament; and it was so."

What do we find in support of this revelation? The divine psalmist, exhorting men to praise God, says in the 148th psalm,— "Praise Him ye heavens of heavens, and ye waters that be above the heavens!" Again he says, in the 24th psalm,— "The earth is the Lord's, and the fullness thereof; the world and they that dwell therein: for he hath founded it *upon the seas*, and established it *upon the floods*." And again in the 29th psalm,— "The Lord sitteth upon the flood, etc."

These few passages, and others which could be cited, tend to show that whatever men in modern times may think of — "The

waters beyond the heavens," David accepted the revelation in its most literal sense.

THE FLOOD.

And why should not that revelation be so accepted? We read in the 7th chapter of Genesis, that after Noah and his family had entered the ark, "the fountains of the Great Deep were broken up, and the windows of heaven were opened," causing it to rain on the earth till the mountains were covered.

Now, whence came this great deluge of waters,—from within, or from without the firmament? Could the rains caused by nature's regular process of evaporation and condensation of the water already on the earth, have produced such an overwhelming result? In a word, could the world have been drowned with its own waters?

Could the water which was on the earth before the flood, not only have extended its bounds over the whole earth, but actually have swollen its own volume, and raised its own surface many feet above the earth, till

the mountains were covered? Surely not by any natural process!

Clearly then, the material for this great inundation must have come from without the firmament—shall we say from “the waters beyond the heavens;” which may be the Great Deep, referred to in the chapter:—presumably not reposing there in liquid form, nor yet perhaps in vapor as dense as floats in clouds above the earth; yet *water*, nevertheless.

This conclusion also finds support in the words found in the 37th chapter of the Book of Job; the 6th verse reading thus: “For He saith to the snow, Be thou on the earth; likewise to the small rain, and to the great rain of His strength.”

It will be noticed that a marked distinction is here made between God’s small, or ordinary rain, and the “great rain of his strength,”—such as was necessary to submerge the world.

But how was the earth again relieved of this aggregation of waters? We read in the 8th chapter of Genesis that God caused a

wind to pass over the earth, and the waters *assuaged*. Please to note that expression, "And the waters assuaged." The fountains of the deep and the windows of heaven were also stopped, and the rain from heaven was restrained; and the waters returned from off the earth continually, till the end of one hundred and fifty days, the waters were abated.

The waters "assuaged," and the waters were "abated;"—both these terms implying that the waters were *lessened*, but not all removed; and leaving us to infer that while a portion may have floated back in vapor to whence it came, yet part was left to increase permanently the waters of the earth.

While I have no desire to urge this theory on the popular mind, yet there appears to be some scriptural foundation for believing that the earth's surface was formerly represented by a much smaller proportion of water than at present, from the fact that in the Scriptures, the gatherings of water on the earth, *before* the Flood, are only spoken of as Seas; but *afterward*, as the Great and

Wide Sea, The Deep, etc.—terms implying a vast whole; and not like the term, Seas, implying smaller divisions of water.

The truth however, which I wish to impress here is,—that in the first chapter of Genesis, the earth is made the first, the principal, and the central object in creation; while sun moon and stars were hung in a firmament surrounding it, to be subservient to it; and that the history of the Deluge, when carefully considered, directly confirms that revelation.

That this plan of creation was also the one understood and accepted by patriarchs and prophets, who appear to have enjoyed more direct intercourse with God than men in modern times, is clearly shown by their frequent expressions in the Old Testament. Of the fixedness, or non-wandering state of the earth, David says, in the 33d psalm:

“Let all the earth fear the Lord; let all the inhabitants of the world stand in awe of him: for he spake, and it was done, he commanded, and it stood fast.”

And again, in the 104th psalm, he says:

“Who laid the foundations of the earth, that it should not be removed forever?”

Job also, it seems, held the same views. In chapter 26. of the Book of Job, he says:

“He stretcheth out the North over the empty place, and hangeth the earth upon nothing.”

While passages of a like import abound throughout the Old Testament, yet with a careful study of the Scriptures, I fail to find a single sentence even remotely implying that the earth travels millions and millions of miles annually, in an orbit around the sun. But to the movement of the sun itself, we find many references; and I crave your indulgence while I quote a few extracts:

“And it shall come to pass in that day, saith the Lord, that I will cause the sun to go down at noon, and I will darken the earth in the clear day.” *Amos, 8 : 9.*

“The sun also riseth, and the sun goeth down; and hasteth to his place where he arose.” *Ecc. 1 : 5.*

“Their line is gone out through all the earth, and their words to the end of the

world. In them hath he set a tabernacle for the sun, which is as a bridegroom coming out of his chamber, and rejoiceth as a strong man to run a race. His going forth is from the end of the heaven, and his circuit unto the ends of it; and there is nothing hid from the heat thereof." *Psalms, 19:4,5,6.*

This is indeed strong language. No one could desire more positive declarations as to the belief of those inspired men in the sun's circuitous movement. But leaving now the expressions quoted, for your consideration, we will again give our attention to some of the memorable events recorded in Sacred History, which have claimed the interest of the student and philosopher in all ages.

In the 10th chapter of the Book of Joshua we find record of a most wonderful instance of God's care of his chosen people, Israel, which is also in direct support of Moses' history of the creation.

THE SUN STANDS STILL.

Moses was dead. After leading forth his people from bondage, and through many

perils, to the borders of the Promised Land, he was called—*up higher*: and Joshua, a man of force and valor, yet devout and God-fearing, was chosen leader of Israel. Enjoying divine favor and help, he carried ruin and defeat into the camp of his enemies, and hostile cities were either scattered like chaff before him, or forced to capitulate.

Of the latter, was the proud and populous city of Gibeon. The king of Jerusalem, (it was then a city of the Amorites,) fearing this important acquisition to Israel's standard, consummated an alliance with the cities of Jarmuth, Lachish, Eglon, and Hebron, for Gibeon's conquest.

Marching against the doomed city with all the panoply of war, calmly confident of superior strength, they deliberately pitched their camp, and prepared for battle.

The men of Gibeon promptly dispatched swift messengers to Joshua, encamped at Gilgal, saying: "Slack not thy hand from thy servants! Come up unto us quickly and save us and help us, for all the kings of the Amorites that dwell in the mountains, are

gathered together against us!" (*6th verse.*)

It was the hour of slumber. But quick the trumpet's call *To arms!* aroused the sleeping host; the line of march was taken up, and 'neath the silent stars, Israel went forth again—to victory! For did not the Lord say to Joshua on that midnight march, "Fear them not, for I have delivered them into thine hand; there shall not a man of them stand before thee."

Gray morning dawned in the east. As its first beams kissed the battlements of Gibeon, the reveille was heard in the allies' camp, and the silence of repose soon gave place to the hum and bustle of activity and preparation,—the eventful day had begun.

The marshalled hosts encompassed that fair city, whose spires now glittered in the morning sun. The trumpet's call to *charge* was taken up along the line, and like an avalanche they hurled themselves against its walls. Fiercly the battle raged—higher climbed the sun—and as the day advanced, anxious watchers on the towers strained their gaze toward Gilgal, in quest of the

summoned relief. At length, above the din of battle, rang the glad shout, They come! they come! Israel's host advances!

Like a thunderbolt from a clear sky, that valiant band fell on the heathen host: shout answered shout, steel clanged to steel, while fell the foe on every hand. Soon the tide of battle turned—the besiegers were routed, and Israel was in victorious pursuit of the vanquished legions.

And now, behold the power of God, and his care of his people!—great hailstones were rained down on the flying foe, so that they who fell beneath them, were more than they who perished by the sword. In the midst of the fearful carnage, Joshua stood forth and gave his memorable command, to the end that the day might be prolonged, so that the enemy's destruction could be made complete. These were his words:

“In the sight of Israel, Sun, stand thou still on Gibeon! And thou, Moon, in the valley of Ajalon!”

Was that command honored? The two verses following it in the chapter, tell us

that it was;— they read thus : “So the sun stood still, and the moon stayed, till the people had avenged themselves on their enemies. Is not this written in the Book of Jasher? ‘So the sun stood still in the midst of heaven, and hasted not to go down about a whole day. And there was no day like that, before it or after it, that the Lord hearkened unto the voice of a man ; for the Lord fought for Israel.’ ”

O, sublime and awe-inspiring spectacle ! The Sun ! which through thousands and thousands of successive journeyings, had never swerved from its appointed course in the heavens—had never before forgotten its fixed periods of rising and setting ; whose progress across the celestial arch had ever been marked by a constancy and steadiness surpassing all other movement, *that day*—stood still over Gibeon !

The humble peasant turned again and again to his hour-glass, shaded his eyes and gazed at the sun ; the man of wealth anxiously consulted the astrologer, who eagerly scanned the record, in a vain search for a

precedent;—meanwhile time sped on, but not the sun.

As the hours went by, blanched faces peered from lowly cottages and princely palaces. Had God's purpose changed? Should the bright orb of day henceforth dart down his fierce rays on the parched landscape, evermore, without intermission or change? Should morning mists, and evening dews, and night's repose never more refresh the earth? Let us turn to the chapter :

We read that after Israel's people had avenged themselves on their enemies, and the kings of the allied cities had been led from their hiding-place and executed, then resuming its majestic course—slow descending to the western gates, mid the gold and crimson, and all the glorious blendings of an Oriental setting,—the sun went down. Could he who had power thus to command, have known naught of that system which obeyed his behest?

THE SUN TURNS BACK.

Passing over a period of more than seven

hundred years of the world's history, we come to another event, very similar, in the conclusions it offers, to the one just noticed; though differing widely, both in detail and in general characteristics. You will find it recorded in the 20th chapter of 2d. Kings, also in the 38th chapter of Isaiah. The two records agreeing substantially, while each serves to elucidate and confirm the other.

Jerusalem had already been for several centuries in Israel's possession, and had become its chief city and seat of government. The wicked and idolatrous reign of Ahaz, king of Judah, was ended by his death, and Prince Hezekiah, an upright, pious young man of twenty five, ascended his deceased father's throne.

Though all the other tribes of Israel were later given over to their common enemy, the Assyrians, for their idolatrous practices, and though Judah was also resting under God's displeasure for the same offence, yet thro' the wise counsels of this noble young king, the remnant of Israel was spared.

Devoutly fearing, and intent on himself

and people honoring and serving the true God, he caused all the accessories to false worship to be destroyed; even to the brazen serpent which Moses had made for Israel centuries before. And God's wrath was turned aside, and Judah once more restored to favor.

Prospering in their civil and domestic affairs, they were also successful in repelling invasions of their foes by force of arms, but their humane and pious king preferred the gentle arts of peace; and when, in the fourteenth year of his reign, the Assyrians came up and seized some of the outlying cities of Judah, Hezekiah, instead of resorting to violence, purchased their release by a ransom of fabulous amount.

But Assyria's king was not content. He knew full well that yet there reigned within Jerusalem's walls a king who despised and rejected the heathen rites and practices of Assyria, and who taught his people to honor and serve one high and ever-living God; and in defiance of that god, King Sennacherib sent a mighty host against the Holy City,

under the leadership of able advocates, who sought first by specious argument; finally by threat and bombast, to draw Hezekiah and his people from their allegiance to the Most High.

In this dilemma, Hezekiah went up to the Temple, and laid his case before the Lord; praying for deliverance from his enemies.—And now behold again the power of a prayer hearing, and a prayer answering God:

“And it came to pass that night, that the angel of the Lord went out and smote in the camp of the Assyrians, one hundred four score and five thousand; and when arose the morning, behold they were all dead.”

Thus, substantially, reads the 35th verse of the 19th chapter of 2d. Kings.—A most wonderful intercession of Divine Providence! One hundred and eighty five thousand slain in one night, in direct answer to Hezekiah's prayer for deliverance.

This sketch may seem a digression; but I have presented it for the purpose of introducing King Hezekiah in his true character, and to show what wonders the Lord was

ready to perform in answer to his petitions; that we may be better prepared to accept the miracle which was wrought later, by his request, and which we will now proceed to consider:

Some time after, was the King sick with a grievous boil; and the prophet Isaiah, son of Amoz, came and said to him: "Hezekiah! thus saith the Lord! 'Set thine house in order, for thou shalt die, and not live.'"

What a message was this to a man of only thirty nine years;—just entering his prime, and in the height of his glory and usefulness. The King of Judah! revered and beloved by his subjects, and invincible, through divine favor, in the presence of his foes. His future a dream of peace, rose-tinted with bright anticipations. Was it strange that the king wept?

Oh! how the stricken heart must quiver and recoil at such a summons! How must the poor dazed intellect roam the confines of human possibilities, seeking an outlet! and oh! the agony, the horror! when at last baffled and bewildered, the despairing cry

is wrung out, lost! lost! Was it thus with King Hezekiah? O, no! Scarcely had the first tremor of human weakness ceased to rack his frame, ere he sought his accustomed refuge, prayer to God. With streaming eyes and averted face, he prayed:

“Remember now Oh Lord, I beseech thee, how I have walked before thee in truth and with a perfect heart, and have done that which was good in thy sight!” and he may have added: And now, Oh Lord, with my work all unfinished, I am called hence! Oh grant me yet a few more years, that I may bring thee a few more harvest sheaves, in recompense of all thy mercies!

Was that prayer answered? Why, before the prophet had reached the inner court of the palace, on his way from the sick chamber, the Lord commanded him, by the spirit; “Go tell Hezekiah, thus saith the Lord—the God of David, thy father: I have heard thy prayer, I have seen thy tears; behold I will add unto thy days fifteen years. And this shall be the sign unto thee that the Lord will do this thing that he hath spoken:—

“Behold, I will bring again the shadow of the degrees which is gone down in the sun-dial of Ahaz, ten degrees backward!”

Was this to be simply an optical illusion? A turning back of the shadow only, independent and irrespective of the true position of the sun? Evidently not—we paused in our Bible quoting, at the middle of the 8th verse of the 38th chapter of Isaiah;—the remainder of the verse reads thus: “So the SUN, returned ten degrees, by which degrees it was gone down.”

Believer of the Sacred Scriptures! how do you reconcile these two events with the teachings of Copernicus? I confess I have tried, honestly, and without prejudice—and have *failed!*

GOD'S ESTIMATE OF OUR WORLD.

Let us turn aside here for a few moments to consider what estimate our Heavenly Father places on this world of ours, and why he regards mankind with so much of favor:

We read in Genesis, that after creating the heavens and the earth, God created the

living creatures which inhabit earth, air, and sea. And while among this vast multitude were found the strength and massiveness of the leviathan, the noble usefulness of the horse and ox, the swiftness of the eagle, the cunning of the serpent, yet among them all, there was found no responsible, reasoning head. All were guided by a God-given instinct, which though wonderful, of itself, is as far removed from a God-given intelligence, as the east is from the west.

Then, as the crowning and finishing work of creation, God said, "Let us make man in our image, after our likeness." Thus we read that he created man in his own image; "In the image of God created he him; male and female, created he them. And God blessed them, and God said unto them: 'Be fruitful and multiply, and replenish the earth, and subdue it; and have dominion over the fish of the sea, and over the fowl of the air, and over every living thing that moveth on the earth.'"

Oh! the fearful weight of responsibility resting on him, who in the light of this

revelation, presumes to reverse the real order of events, by teaching us that man was developed on an ascending scale, or evolved from the beast; rather than admit the truth of the Bible—that he originally came forth from the hand of his Creator, reflecting the beauty and grace and symmetry of the Divine Model: and that by his own wickedness and folly he has evolved the other way, till some copies have descended to the level of the beast.

But we are grateful that enough of the divine likeness still exists among men, to remind us of the great honor God conferred on this world and its people, in bestowing it. And as we meet the graceful form, the finely chiseled features, the expressive eye; or better still, the bright intellect and the noble heart, we cannot but feel that they reflect, in some degree, their Great Original.

Important indeed, must this world be in the sight of Him who honored it thus highly; and who has made it the object of his fatherly care—favoring it often, in its early history, with his divine presence, counseling

and guiding mankind;—as we read in the 33d chapter of Exodus, “And God spake to Moses face to face, as a man speaketh to his friend.”

MAN'S ESTIMATE OF OUR WORLD.

As affording a most decided contrast, let us now briefly examine man's estimate of the world we live in.—In the first place, he calls the earth, sun, moon, and all the stars we behold in the heavens, taken collectively, “Our Universe;” though he says—perhaps correctly—that there are other universes besides ours.

This cluster called Our Universe, besides the earth and other planets, consists of millions of stars; our sun, he says, being one of those stars; and though appearing much larger than the others, yet this is only on account of its comparative nearness to us; we being taught that of the few stars men have taken the time to measure, several are many times greater than the sun; yet they give the sun a diameter of 866,000 miles, or 109 times that of the earth's; which would

make the sun's volume more than a million times greater than the earth's.

As illustrations in the text-books and in the lecture-room usually fail to give anything like a correct idea of this enormous difference in magnitudes, we will now give a scaled perspective of those bodies, based on present estimates:—

We will let the disc *S*, (see plate of apparatus at close of this chapter), represent the sun. It is exactly nine feet one inch, or 109 inches in diameter; then the little dark dot *E*, on its face, which is 1 inch in diameter, will represent the earth.

Here we have man's estimate of the relative magnitude and importance of this, our globe.—Such a sun created to give light on such an earth? Why! it would—comparing small things with great—be like setting all of Greater New York on fire to light the statue of “Liberty” in the harbor. Oh! may we not pause and reflect? Let us seek for more light (*and a little less sun*), before we longer persist in our wholesale depreciation of so grand a work of God.

When our renowned American sculptor, Hiram Powers, had given the last finishing touch to his great master-piece, the "Greek Slave," and withdrew the screen to admit his admiring friends, had they passed indifferently by his crowning effort, and fallen to admiring some insignificant plaster cast in his studio, oh! how would the talented artist's heart have sunk in his bosom, for lack of that appreciation which he strove so hard to merit:—

Our Heavenly Father has given to man this great and beautiful world, filled with untold wonders and blessings, for his habitation and home. Like a spoiled child, he turns from its beauties to contemplate its auxiliaries, the stars; and to magnify them in his imagination, into proportions deeply disparaging to this world of ours; thereby confounding a portion of God's Word, and leading the children of men to doubt. Can God be pleased?

But says the freethinker, "I don't know about this Moses' history of the Creation! Many profound men of the present day tell

us that some portions of the Old Testament, particularly its first books, are not too well authenticated!" We will produce the testimony of two witnesses, to break up this stronghold of skepticism and then we will rest this side of our cause:

THE WITNESS OF THE SPIRIT.

First, we will call the real Christian; the immortal being who has experienced that mystic transformation which was explained to Nicodemus of old:

Don't you remember how, before that important event of your life, you regarded the Bible as a book of enigmas, and perhaps of contradictions, and in great part beyond the scope of your comprehension; while adverse criticisms and charges of faulty translations seemed to you, just and tenable?

Don't you remember how demonstrations of physical science appeared to your mind, fairly and substantially to disprove many of those passages which men must receive, if at all, on their simple faith?

But there came a time in your history,

which comes once to every man and woman, when you were impressed with a deep sense of your obligation to that Supreme Author of your being whom we call God; and with a desire to gain his pardon and favor.

Unlike many of your fellow beings, you entertained that angel visitor, and after due repentance, earnest seeking, and a humble compliance with the conditions laid down in God's Word, the burden was rolled from off your soul, and the glad light of the Gospel shone in—"As the wind bloweth where it listeth, and thou hearest the sound thereof, but canst not tell whence it cometh, and whither it goeth." O, blissful transition! O, foretaste of Heaven!

Don't you remember, when a child at school, you pondered vainly some difficult problem, which seemed entirely made up of puzzles and contradictions, till your teacher came along, with gentle touch, a kind word of encouragement, changing a figure here and there,—when lo! the solution burst on your glad vision, just as the wind bloweth where it listeth? "O, yes!" you then said,

“I can see it all now — so plain and beautiful, so consistent and true! Strange I could not see it before!”

In like manner, when God’s hand was stretched down to you, and the beautiful Heaven seemed just a little overhead, did not all doubts and perplexities vanish? And as his finger traced the sacred lines in review for you, from the last page of Revelation, back to the first page of Genesis, did not a sweet harmony run through it all, and a deep consciousness take possession of you that the Bible throughout—from beginning to end—was glorious, consistent, all true? A consciousness that surpassed belief, and that was more than simple faith;—it was KNOWLEDGE!

OUR CHIEF DEFENSE.

One more, our principal witness and chief defense, and then we shall deem cultured criticism, from a biblical standpoint, fully answered. Would you know who this important witness, and whence he comes?—Then give me your attention:

Nineteen hundred years ago the just past Christmas-tide (1897), away among the hills of Judea, overlooking the city of Bethlehem, shepherds were watching their flocks by night. All nature was hushed in repose; no sound came up on the bracing night air from the city below. Suddenly a bright light, of most dazzling whiteness, shone round about them, and they were sore afraid. Looking upward to discover its source, they beheld an angel, who spake unto them these words:

“Fear not, for behold I bring you good tidings of great joy, which shall be to all people; for unto you is born this day in the city of David, a Savior, which is Christ the Lord.” And suddenly there was with the angel a multitude of the Heavenly host, praising God, and saying: “Glory to God in the highest, and on earth peace—good will toward men.”

That night, lying in a manger within a grotto or cavern used for sheltering domestic animals, because there was not room for her in the inn, a modest and beautiful virgin maiden was delivered of a male child:—

The shepherds left their flocks and came down to Bethlehem, to verify the strange message. Wise men of the East, looking for Him whose coming was foretold by God's prophets centuries before, and discovering the star which should herald his advent, came on to Jerusalem to worship him. But there learning that Bethlehem was to be the city of his birth, they turned their footsteps thitherward, and the star went before them till it came and stood over where the young child was. That star, at least, behaving thus, could not have been millions and millions of miles from earth, could it?

That child grew in stature and wisdom, and in due time developed into the most remarkable man whose footsteps ever pressed this world of ours. History, both sacred and profane, bears record to his wondrous works and matchless grace. Even his enemies could not deny his miraculous powers, and we Christians, who have *felt* his power to save,—we *know* that he was the Messiah which was to come—the Christ, the only begotten Son of God. Let us judge from

his own words of his competence as a witness in this case:—

In that beautifully pathetic prayer to the Father, recorded in the 17th chapter of St. John, in the 5th verse he says: “And now, O Father! glorify thou me with thine own self;—with the glory which I had with thee before the world was!” In the 24th verse of the same chapter he says: “For thou lovedst me before the foundation of the world.” In the 8th chapter of St. John, 58th verse, he also says, in reply to a question of the Jews: “Verily verily I say unto you; before Abraham was, I am!” Thus dating back his personality over a period, not only covering all, but even preceding the events found recorded in Sacred History.

Of his remarkable familiarity with the Scriptures, we will judge, first from the admission of his enemies; who, while he was teaching, or expounding the Scriptures in the Temple,—“Marvelled! saying, how knoweth this man letters, —having never learned!” *St. John*, 7 : 15. and next from the words of his friends, the two disciples

whom he accompanied when on their way to Emmaus; and though at first unrecognized by them, yet conversed in such a spirit that they were moved later to exclaim: "Did not our hearts burn within us, while he talked with us by the way, and while he opened to us the Scriptures!" *St. Luke, 24 : 32.*

And now, what says this most competent witness of these same Scriptures, the Old Testament? In St. Matthew, 5 : 17, he says "Think not I am come to destroy the law or the prophets; I am not come to destroy, but to fulfill." In St. John, 5 : 39, he says again, "Search the Scriptures; for in them ye think ye have eternal life: and they are they which testify of me." And again in St. John, 17 : 17,— "Sanctify them through thy truth; thy Word is truth."

In confirmation of these declarations, we would call your attention to the constancy with which he refers to, and quotes from the Old Testament from beginning to close; always agreeing, substantially, controverting or rejecting—*Never!* You will, I trust bear with me while I give a few examples:

Adverting to the very beginning of creation, he says, in reply to a question of the Pharisees, concerning divorcement: "Have ye not *read*, that He who made them at the *beginning*, made them male and female, and said, etc. *St. Matthew, 19 : 4, 5.*

He refers to that first deed of violence, recorded away back in the 4th chapter of Genesis, while foretelling the fate of the scribes and Pharisees; these are his words, found in Matthew, 23 : 35. "That upon you may come all the righteous blood shed upon the earth; from the blood of *righteous Abel*, unto the blood of Zacharias, son of Barachias, whom ye slew between the temple and the altar."

Again in Matthew, 24 : 38, he refers to the Flood in these words: "For as in the days that were before the Flood, they were eating and drinking, marrying and giving in marriage, until the day that Noe entered into the ark."

Of Moses and his writings in general, he says in John, 5 : 46, 47. "For had ye believed Moses, ye would have believed me, for

he wrote of me; but if ye believe not his writings, how shall ye believe my words."

Nor does he reject that strange narration in Genesis concerning Lot's wife, which the men of modern times have found so hard to believe; but appears to give it full credence by commending the lesson it affords to those who shall witness his second appearing. He refers to it in these words: "In that day he which shall be upon the housetop, and his stuff in the house, let him not come down to take it away; and he that is in the field, let him likewise not return back. *Remember Lot's wife!*" *St. Luke, 17 : 31, 32.*

And so far from discarding the story of Jonah, which modern savants contend must necessarily be a myth, he employs it to symbolize the most memorable event of all history — his burial and glorious resurrection. These are his words, found in Matt. 12 : 40. "For as Jonas was three days and three nights in the whale's belly, so shall the Son of man be three days and three nights in the heart of the earth!" and by these words and their context implying, that as Jonas

was delivered living from the whale, even so should the Son of God arise living from the tomb. And thus I might go on and on, to prove his entire familiarity and perfect accord with the Old Testament, from beginning to end, but time hastens and I forbear.

Touching the importance given the earth in God's universe, he says: "For God so loved the world that he gave his only begotten Son, that whosoever believeth in him should not perish, but have everlasting life." *St. John, 3 : 16.* And as indicating his own knowledge that sun moon and stars are attendants of the earth, he speaks of them in connection with his second coming, in this wise: "Immediately after the tribulation of those days shall the sun be darkened, and the moon shall not give her light, and the stars shall fall from heaven, and the powers of the heavens shall be shaken."

St. Matthew, 24 : 29.

And now, in conclusion, wherefore was Christ's mission? Was it to redeem only a diminutive and insignificant planet, attendant on a sun more than a million times its

superior in size, and yet that sun but a star of lesser magnitude? Or was it to redeem a grand and spacious world, teeming with the wonders and beauties and blessings of God's creation, and peopled with beings created in his own image, and but a little lower than the angels?

God's ways are perfect. The means he employs are always commensurate with the importance of the object. He sent on that mission of redemption—not one of earth's saints; not one of the Heavenly cherubim; not one of the seraphim. He sent his only begotten SON.

And what the duties of that mission? To recline on flowery beds of ease, while spicy zephyrs fanned his brow, and soft æolian strains, in dulcet numbers gently breathed a world's submissive adulation? Or was it to mount the conqueror's chariot and roll triumphant through Earth's empires, aweing and subduing by the majesty of his Immaculate Presence?

No! no! none of these! His lot was cast among the poor and lowly; he came to his

own, and his own received him not. Cruel hatred and stubborn unbelief opposed him everywhere; and after giving to mankind the highest proofs of his divinity, inculcating the noblest lessons of true charity and Godlike virtue, and establishing a Christian ministry, later commissioned to evangelize and bless and save—the World!—He was seized by his enemies, and crucified!

The sun was darkened! The earth quaked! The vail of the Temple was rent in twain—He yielded up the ghost: the sacrifice was complete.

And that great sacrifice—was it for a comparative speck in God's universe, such as man assumes this world to be?

PHYSICAL APPARATUS.

The apparatus illustrated on the opposite page, besides various other appliances, not shown, were designed, constructed, and employed by the author, to demonstrate, step by step, the deductions submitted in the two following lectures; and their successful operation is explained by the assistance of diagrams introduced at the proper places throughout the lectures.

The large disc, *S*, with the small dot, *E*, on its face, is the one already referred to on page 166, to show comparative size of sun and earth.—*A*, is a large mounted scroll of diagrams, moving mechanically, as desired, from the upper, to the lower roller.

B, illustrates mechanically the Sun Spot Paradox explained in Lecture II.—*C*, is the Equation of Time device,—*D*, the Aberration of Light,—and *F*, the apparatus for testing Kepler's Second Law of Motion, in Lecture III.

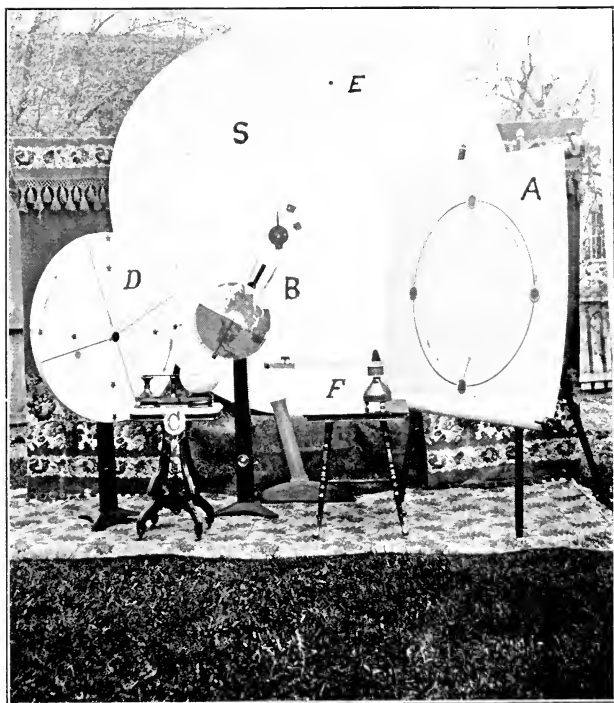

PHYSICAL APPARATUS.

CHAPTER VII.

LECTURE II.—NATURE *vs.* COPERNICUS.

WE MAY perhaps at some time have seen a beautiful edifice, whose superstructure was correct, both in outline and detail;—magnificent in proportions, artistic in design, gorgeous in decoration, admired by all beholders; the pride of its architect and builders;—yet resting on an unsound base: rendering it desirable, for the public good, that its instability be known of men.

May the honored dead, and their living representatives, forgive my presumption in concluding that such is the noble monument of thought and observation and calculation, which we are about to examine; and which has been built, block added to block, by men whose genius and culture would sink in ignominy and despair my poor dwarfed, meager attainments. But remembering it is for

the Master, I must press forward ; waiting for justification, if must needs be, till that time when we shall know, even as we are known; and when our spiritual eyes may be able to discern the pure motive often lying beneath the halting, unsuccessful, or perchance mistaken deed.

Maintaining that the foundation of such a structure should be God and his revealed Word, with the operations of Nature, correctly observed, as material for the building of the superstruction, we will now proceed to investigate as to the solidity of the corner blocks on which men have builded this tower to the skies.

THE REFRACTION OF LIGHT.

If we hold a straight rod in the water obliquely, we observe that the part below the surface appears to be bent upward; but knowing, from the firmness of the rod, that this is not really so, we are led to discover that the rays of light passing through the two media of air and water, are bent downward at the water line. This, we all under-

stand is called the Refraction of Light; and takes place whenever light passes from a rarer to a denser medium, and *vice versa*; the degree of refraction depending on the obliqueness of the rays, and the difference in density of the media.

In considering the light-refracting properties of our atmosphere, we might treat it as consisting of an infinite number of strata, each lower stratum a trifle denser than the one above it; which would have the effect (as it really does have) of bending rays of light passing obliquely through it, into that infinite number of angles which constitute a curve; the curvature or refraction being greatest at the horizon, and decreasing rapidly toward the zenith, where it disappears altogether. So great an obstacle has this proven to correct observation of the heavens that Sir. Geo. Airy, England's Astronomer Royal, termed it The bane of astronomers; and in my simplicity I shall go still farther, by calling it the vail which God has drawn between the known, and the unknown and unknowable.

To obviate this bar to direct vision, eminent observers and mathematicians have formulated tables of these refractions, as they present themselves to us at the earth's surface, which are doubtless true records of the observations made, though they are subject to variation in different localities, and different states of the atmosphere. But they do not appear to estimate the contingency that atmospheric refraction may not be greatest at the immediate surface, over a large portion of the earth; since in all but the colder regions, the lower portion of the air becomes warmed and attenuated by the radiated and reflected heat it receives from the earth, to the extent of perhaps reducing the deflections of light coming to it from the cooler air above by a counter refraction, as shown by the line *c*, in *Fig. 1.* (opposite page), in which figure *E* represents a hemisphere of the earth, *a a*, the surrounding atmosphere, the closer lines representing the denser portions. *N* and *S* indicate the polar regions, locating the equatorial belt vertically at the centre; while *m* and *n*

represent stars, each sending a beam of light (*c* and *d*) to the earth.

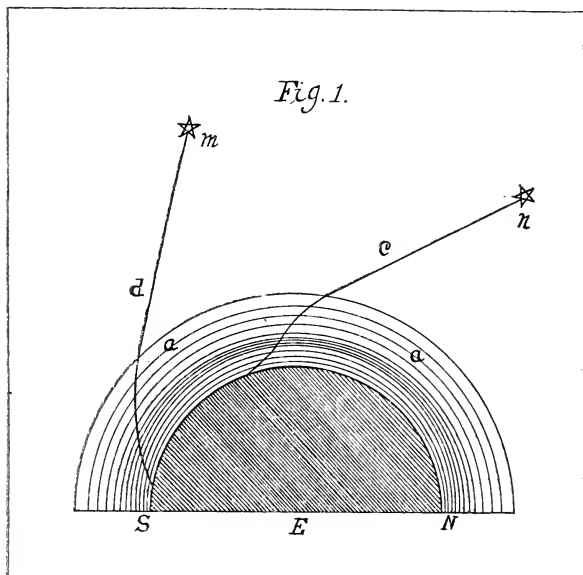

COUNTER REFRACTION.

In support of this theory, we find that the air is always more bracing in elevated regions than in the valleys. Aeronauts and mountain scalers also tell us that at no great height above the common level of the

earth, even in the tropics, the air is cold; and we know that some of the higher mountains there, are capped with ice and snow, while the heat in the valleys, and on the plains, is withering in its intensity.

The effect of such a condition must be to so rarefy the lower portion of the air, as to produce this counter refraction. And as we behold objects in the direction in which the rays of light emanating from them, present themselves to our eyes, we naturally lose the effect of that greater refraction in the more elevated regions of the air, which aeronauts inform us is so great that the earth beneath them, instead of appearing like a globe, as it really is, actually looks like a huge bowl; the horizon appearing lifted up on all sides of them.

But as refraction is observed to be so great in the polar regions, we must conclude that this greater refraction comes to earth there, and that it may also be intensified by the denser, frost-laden air which it encounters at the earth's surface, as indicated by the line, *d*, in *Fig. 1*,—preceding page.

In refutation of such a theory, it may be argued that there is the same gradual fall of barometer when ascending elevations in the tropics that there is in higher latitudes, indicating the same steady change in density; and right here permit me to draw the line between barometric pressure and true atmospheric density:—

If we fill a rubber bag slackly with air in a cold room, and closing it tightly, bring it into a heated apartment, in a short time the confined air, becoming heated, will distend the bag to double or more its former volume, and will hold it distended after it is removed to the cold room again, till it loses its increased temperature; thereby clearly demonstrating that, with the atmospheric density reduced one half, or more, by the aid of heat, the barometric pressure remains the same.

If then, refraction is such an inconstant and uncertain quantity, can we anywhere obtain a reliable geometrical parallax of a heavenly body? I doubt not however, that there is a region of the air, though it is not

accessible for making observations, where refraction is far more constant than at the earth's surface, and may also be far greater than we have estimated; and that is the region just above the clouds; where, relieved of the earth's radiated and reflected heat, atmospheric temperature and density must be nearly uniform, at equal altitudes, all around the earth.

It may however be suggested that in the region referred to, the atmospheric density may be less than one half what it is at the earth's surface; and I would reply that this does not affect my theory; for so long as the air nearest to the earth becomes sufficiently rarefied by heat to cause a counter refraction in receiving the rays of light from the cooler air directly above it, we are unable to correctly estimate the refraction of that upper region; which, as I have said, may far exceed present estimates; since refraction is caused, not so much by the greater abstract density of media, but chiefly by the difference in density.

Let us take, for example, the two media

of air and water, which differ in density as about 1,000 to 1 only, yet they give results far exceeding the refractions observed in our lower atmosphere. So might not those refractions just above the clouds give similar results? For assuming that the atmospheric density there is but one fifth what it is at the earth's surface, Dr. Crookes tells us of exhausting air in a receiver to a millionth part of its common density; and is it likely that man, by mechanical means, could produce greater attenuation than always exists in the outer stratum of our atmosphere? Yet the figures quoted would give a difference in density between the air of that upper region and the outer stratum, not only of 1,000 to 1, as with air and water, but of 200,000 to 1, or 200 times greater.

I have observed however, that astronomers, in treating on the subject of the Lunar Eclipse, appear to consider our whole atmosphere as being the region of cloudland, but the best authorities I have been priveleged to consult on that point, place the highest cloud formations almost entirely within six

miles of the earth, while beyond, the air is clear and cold, and offers little resistance to rays of light, except that of refraction.

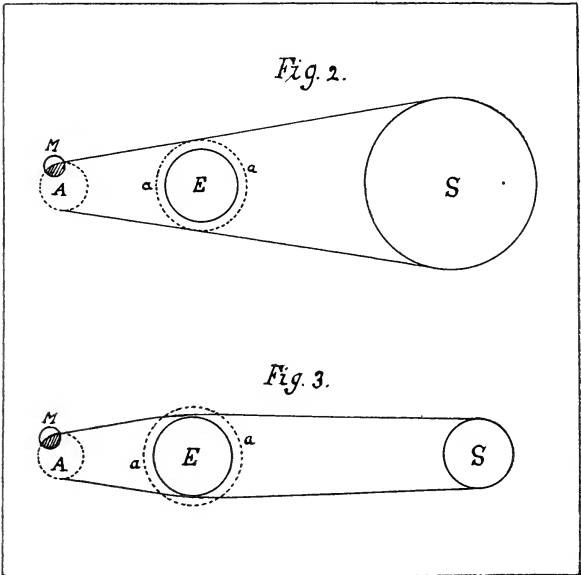

THE LUNAR ECLIPSE.

They also tell us that the umbra, or dark shadow of the earth on the moon, indicated by *A*, in *Fig. 2*,—*S* representing the sun, *E* the earth, *a a* its enveloping atmosphere,

and M the moon, partially eclipsed;—they tell us that this umbra, A , is outlined or circumscribed by those direct rays of the sun which pass the earth above, or outside of its atmosphere, or at least so far above the earth's surface, that they suffer no sensible refraction; while those rays passing through our atmosphere are refracted, or bent inward by it, and cast on the umbra; giving to the eclipsed moon a faint illumination, *except* when the atmosphere is *cloudy*, when these rays are intercepted, and the moon is left in total darkness; and that the umbra is therefore much larger than the moon's disc—sometimes as many as 5,950 miles in diameter, and never less than about 5,650 miles.

This is the language, in substance, of an eminent author of astronomical works, and I presume it fairly expresses the Copernican view of the subject; while the breadth of umbra given is doubtless, relatively to the moon's estimated diameter, correct.

The height of our atmosphere appears to be variously estimated from 40 to 80 miles;

though an eminent English astronomer says in one of his text-books, "There is evidence to show that we have an atmosphere of some kind at a height of from 400 to 500 miles above the earth." Also an eminent American astronomer has said, "It is evident that our atmosphere extends upward more than 100 miles, while we have no certain knowledge that it does not extend out into space indefinitely."

Now, we find by computation, that this breadth of the earth's shadow in a Lunar eclipse, to which we have referred, is calculated from the direct rays of the sun, (as is shown in *Fig. 2.*) passing the earth just 50 miles above, or outside of its solid surface; and whether they pass through the upper and thinner portions of our atmosphere, or just skirt its outer edges, the effect would be the same on all other rays from the sun passing below these, or nearer to the earth. Let us as briefly as possible consider what that effect would be:

Our atmosphere being free from clouds, and offering little resistance to rays of light

beyond a height of six miles above the earth, and diminishing in density as it extends upward with a constancy due to natural laws, it is evident that the next course of rays coming from the sun, inside the direct ones, would be refracted slightly inward in passing through the attenuated outer portions of our atmosphere; the next course a little more, and our atmosphere increasing still in density toward the earth, the next course still more, and so on; the result being that a large percentage of those rays would, at time of central eclipse, be focused on the face of the moon.

But whence then, comes the dark shadow we are accustomed to see pass over the moon in a Lunar eclipse? Where among those refracted rays would its line of demarkation fall? Is it not plain that there would be no definite shadow—only a light, penumbral shade, of perhaps unequal density?

And how would ever be cast the totally black shadow, which has on rare occasions obscured the moon by total darkness? since the clouds, extending upward in any event,

less than one sixth the highth of our atmosphere, at least five sixths of it must always remain clear for the rays of the sun to pass through it, and thus be focused, in part at least, on the moon?

But since the moon is at times eclipsed by this fairly well defined, and more rarely by this totally black shadow, I am convinced that both are outlined, not by the direct, but by the refracted rays of the sun passing *through* our atmosphere.

This would indicate greatly reduced dimensions and distances from earth of those two important bodies, the sun and moon, and might be illustrated as in *Fig. 3*, page 190, in which *S* represents the sun sending its rays to the moon *M*, through the atmosphere *a a*, of the earth *E*, which they traverse as obliquely as possible, and therefore receive the maximum of refraction, both in their entrance and exit.

As clouds are always floating somewhere in our lower atmosphere, and have a decided tendency to gather at the horizon which the earth presents to the sun, as we see at its

rising and setting; and as rays of sunlight just grazing this horizon must travel many miles of cloudland of the height ascertained, I feel assured that comparatively few of the sun's rays ever make their way across this cloud-belt, and that the umbra of a Lunar eclipse is outlined wholly by those rays of sunlight passing through that region of the air before referred to, just above the clouds; where the uniform atmospheric temperature and density tend to give them that uniform refraction on all sides of the earth, which is necessary to faithfully describe its circular shadow on the moon; while those rays only which make their way *through* the cloud-belt, at remote parts of the earth, where the low temperature favors atmospheric density at the surface, are refracted enough more than those passing above the clouds, to cast their diminished light on the umbra.

[Note.]—The Lunar Eclipse of the evening of Dec. 16, 1899, was observed by me, and viewed through a small telescope, presented a beautiful appearance. The sky was with-

out a cloud, the eclipse was nearly total, the shadow at greatest obscuration being of a copper tinge, deepening toward the centre.

When the shadow was leaving the moon, and about one third of its disc was uncovered, the view was especially distinct and satisfactory; the shadow appearing, relatively to the uncovered portion of the moon, of a dark copper color, with its edge though a little jagged, yet very clearly defined; the appearance forcibly suggesting the passage of the sun's rays over banks of clouds, and thus most decidedly supporting my former views on that subject.

CELESTIAL DISTANCES.

In determining celestial distances, the distance of sun from earth has received the most attention, as it supplies the basis, or astronomical unit, for calculating nearly all other celestial measurements.

Of the many ingenious methods employed from time to time for finding the solar parallax, those which gave results incompatible with the theory of Copernicus, have been

entirely discarded; while such as gave results fairly accordant with that theory, and also with each other, have been accredited with various degrees of reliability.

These are mostly based on the assumption that the Copernican Theory is correct; the gravitational methods, now in favor with astronomers, further assuming the correct application of the law of gravity to the workings of the planetary system. The physical method also assumes that light travels with the same velocity through interplanetary space, as in a vacuum.

While I am wholly incompetent, and also disinclined to criticise the physical experiments pertaining to this latter method, yet I would suggest that the rays of light from Jupiter's satellites may pass through a far lighter æther in coming to earth, when that planet is in opposition, than when it is in conjunction; as it is evident the rays must, in the latter case, pass through that region surrounding the sun, containing the zodiacal light; which, whatever it may be, interposes a *something* which those rays must

then pass through, which they do not have to pass through when the planet is in opposition. And might not those inequalities in the eclipse periods of Jupiter's satellites be largely due to the light-retarding influence of a denser medium, or might they not be easily accounted for by some other system than that of Copernicus, without resort to the Equation of Light?

My estimate of the methods first named, will be apparent when we later take up the subject of Universal Gravitation; while the geometrical methods are all subject to what we have said, and may say further respecting the uncertainties of refraction. One of these methods however impressed me as being so nearly independent of the refraction of the earth's atmosphere, as to claim my most earnest thought—I refer to that based on a Transit of Venus.

While this method may not rank highest with modern astronomers, yet it appeared to me at first to establish, independently of any system, such an immense distance for the sun from earth, as to place beyond all

doubt the correctness of the Copernican theory. But it recurred to me that Venus is accredited with having a highly refractive atmosphere, through which those rays of sunlight must pass which outline her dark disc on the face of the sun during a transit; and might not this condition cause complications which have not as yet been properly estimated? Let us as briefly as may be, examine this question:—

In *Fig. 4*, (next page,) *E* represents the earth, *S* the sun, and the small dark disc *c*, Venus in central transit. By the aid of this diagram we will now consider the capacity of Venus' atmosphere for refracting rays of sunlight passing through it.

Those rays passing through its outer and thinner portions would naturally be refracted least, while refraction would gradually increase centreward, or toward the planet.

The same effect would thus be produced as if the rays were passing through a lens having a cross section of the peculiar form represented by *a a*, in *Fig. 4*, which is there substituted for the planet's atmosphere.

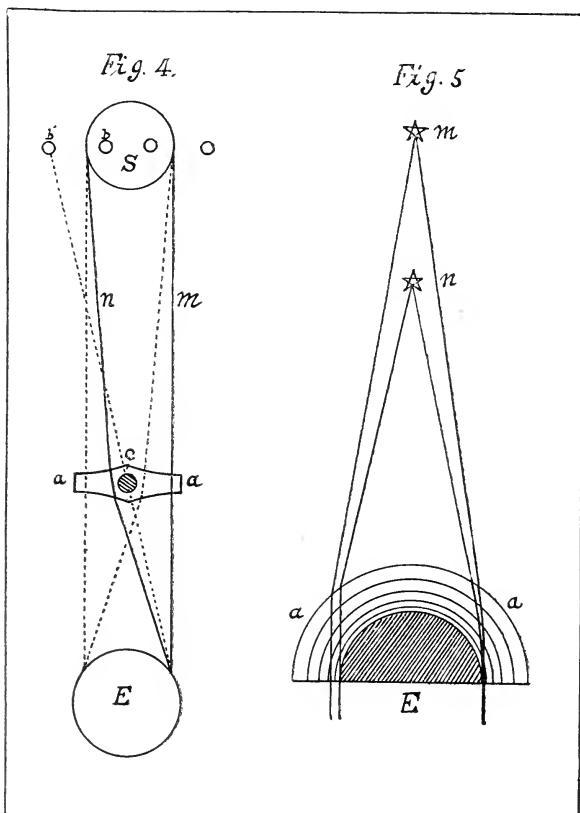

A TRANSIT OF VENUS.

Then, referring to the diagram, it is evident that the ray m , in passing from sun to earth will suffer little or no refraction from the lens, since it passes through its nearly plane outer edge; but the ray n , passing as shown, through a highly refractive part of the lens, will be turned from its course and brought to a focus with the ray m , at the earth's surface.

Observers at this right hand earth station would then see the sun in the direction of the angle of vision described by m and n as they approach the earth, and slightly enlarged, as it really appears during a transit of Venus, while the planet would appear on its disc, as at b , instead of at b' , where it would appear, relatively to the sun, if it were visible and there were no refraction; while observers at the opposite station, as shown by the dotted lines, would witness the same result in reversed order, thereby greatly reducing the true parallax. This might also explain the cause of that drawn out internal contact called "the black drop" observed during a Transit of Venus.

But it will doubtless be objected that the atmosphere of Venus has no such extent as this diagram would appear to give it; but as is evidenced by the narrow, bright belt which is seen to encircle the planet when entering on a transit, the height of its atmosphere must be many times less than its own diameter. I would answer by suggesting that this luminous, or visible belt is only the misty, or vapor-charged portion of the planet's atmosphere, while the invisible, or clear air beyond it, thins out gradually into the æther of space.

Let us again, by the aid of *Fig. 5*, (page 200) consider what obstacle the atmosphere of our globe interposes to gaining a true parallax of a heavenly body:—

In this diagram, *E* represents a hemisphere of the earth, with its atmosphere *a a*, while *m* and *n* represent stars sending rays of light to the earth. Now, if we consider this atmosphere, *a a*, as a lens of an equal density throughout, a little knowledge of the science of optics will tell us that these rays could enter the lens at points where

they might be refracted parallel to, though a little removed from each other, as shown at the left of the figure; but if the two rays entered the lens a little closer together, so that they came to a focus at the earth, then they would no longer be refracted parallel, and we would get a parallax.

But as our atmosphere is not of uniform density, and does not refract rays of light thus, but in curved lines, as shown at the right of the figure, is it not equally clear that these rays could be brought together *on the same plane* at the earth's surface by atmospheric refraction, as is there shown? And as we behold objects in the direction of those portions of rays reaching our eyes, no parallax would be obtained; and I believe this to constitute the chief bar to gaining a parallax of a heavenly body by observing it from opposite sides of the earth.

And would not this also assist Venus' atmosphere in still further reducing the sun's parallax toward that narrow limit observed during a transit of Venus, aside from other possible causes, whose existence and effects

are not so apparent? These diagrams are necessarily very much intensified, for the sake of plainer illustration, but I respectfully commend the principles they represent to a careful consideration.

But the immensity of stellar space is contended for, from the fact that the so-called fixed stars, observed through a telescope, appear smaller than when viewed with the unaided eye; and the larger the telescope used, the smaller do they appear. Yet the use of the telescope brings to view myriads of stars which the eye could not discover. Astronomers tell us that this is on account of their immense distances from us.

Is this sound logic? Can we conceive of anything being so distant, that to bring it hundreds of times nearer to us, (as the large telescopes do, optically,) it will appear, not many times larger, but really smaller than it did before? Pardon my stupidity, Men of Science! but I have not been able to receive this theory.

The only conclusion I have been able to arrive at is, that the light from those more

distant orbs, in passing through the æther of space and our adjacent atmosphere, has already, on reaching us, suffered so much from reflection and refraction, that all but its brightest and most direct rays have become, in a manner polarized, and are extinguished by further deflection in a telescope; and the more powerful the instrument, the greater the reduction.

That optical science is not yet mastered, is evident from the trustworthy report of a party of gentlemen making investigations a few years ago in a certain branch of optics, and who discovered—or rather reaffirmed a former discovery—that a ship at sea whose topsails only are visible to the unaided eye, above the horizon, may be brought fully in view by the use of the telescope.

This report was however, I think, pretty generally discredited by the scientists; and while I have made no special observations in that direction, yet I am inclined to accept it, from the fact that when serving in my country's navy, whenever during a "mast-head lookout" I reported a sail just barely

visible to my unaided eye above the horizon, the officer of the watch, though 60 feet below me, would level his glass in the direction indicated, and soon respond, "I see it!"

But how could this be possible? I have made no careful study of the subject, but the first thought occurring to me was, that visible objects emit rays of light differing in refrangibility, which are refracted in different degrees in passing through an atmosphere of unequal density; the more direct ones only being able to form an image of a distant object on the retina of the unaided eye; while those which are refracted much more, may yet be collected by the use of the telescope in sufficient numbers to convey to the *assisted* eye the image of an object that is really below the horizon.

Be this as it may, the discovery referred to leads me to believe that we have much to learn yet in the science of Optics.

But leaving now the subject of refraction of light, we will proceed to consider some of the peculiarities of that great fountain of light, the sun itself.

THE SUN SPOT PARADOX.

The theory appears to be still accepted that the central mass of the sun is a smaller body inside the luminous shell which we see, and which is known as the photosphere, or light-giving sphere of the sun. This photosphere appears to consist of highly incandescent vapors, in which there are at times dark depressions, observable by the aid of the telescope, commonly called sun spots; which, moving as they do across the sun's disc, have enabled astronomers to not only discover, by close and continued observation, that the sun turns around, but to estimate the time and direction of its rotation, with the inclination of its axis.

In astronomical text-books we frequently see a diagram, as in *Fig. 6*, (next page) for indicating the direction of these spots on the sun's disc at different periods of the year; the straight lines and arrows showing their course in June and December, and the curved lines the same in September and March, as seen from the earth.

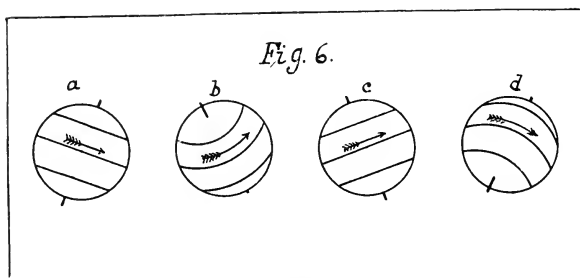

The text-books however, usually have the axis of *b* and *d*, vertical in perspective. I discovered that this was an error; but as an eminent American astronomer used that form of illustration in one of his text-books, I corresponded with the gentleman concerning the matter; and after due consideration he admitted the error by further explaining that, at the periods of the year indicated, the paths of the sun spots, as seen from the earth, do not, and could not appear thus; but in a manner indicating the inclination of the sun's axis, relatively to the earth's axis, as in *b* and *d*, in the figure.

This, in a Copernican system, would indicate that the sun's axis is inclined nearly in the direction of the equinoctial points; the

apparently side view *a* presenting itself to us in June, the other side view *c*, when we get directly on the opposite side in December; the partially end view *b* nearly at the September equinox, and *d* in March.

☉ The first impression I received from this figure and its accompanying explanation in the text-book was, that it gave substantial proof of the earth indeed traveling around the sun; for how could the sun present these different phases, except it were viewed from different points of observation?

But as I pursued the subject further, I found by experiment that if the earth were at the centre, and the sun revolving around it in the earth's supposed annual orbit, the sun's axis meanwhile being constantly inclined in the direction of some fixed point in the heavens, the course of the sun spots, as seen from the earth at the four periods indicated, would appear as shown in the figure; and that in this case Earth around Sun, and Sun around Earth, are reciprocal, or interchangeable terms.

These sun spots however, do not appear

to move with a uniform velocity; but contra to what might be expected, those farthest from the sun's equator, and therefore having the lesser circumference to travel, appear to us to take the greater time in going around it—apparently about 27 days; while those nearest its equator, and having the greater circumference to travel, appear to go round it in about 25 days.

As the light, floating, vaporous photosphere would be likely to remain quiescent, except as it is carried along by friction with the rotating inner mass of the sun, the natural tendency would be, for those portions to fall behind which have the larger circuit to travel; but as a matter of fact, this order appears to us, *reversed*.

Now, if the sun really is the centre of our planetary system, and is, relatively to the earth's orbital motion, at rest, except as it turns on its axis, then viewed at the great distance lying between us and the sun, these sun spots must certainly go around the sun in the order in which they appear to us to move,—that is, those nearest to its equator

going around it in the shortest time: which however astronomers concede is the opposite of what might be expected, being entirely inconsistent with natural results.

Experimenting with a view to ascertaining if this paradoxical behavior of the sun spots (from a Copernican standpoint) would not harmonize with natural results in some other system, I finally produced an apparatus which gives very interesting results. It is designated by the letter B, in group of physical apparatus, page 180; and its primary parts outlined in the diagram, *Fig. 7*, next page, which I will describe as follows:

The two circular areas, *E* and *S*, represent respectively the earth and the sun. The axis of the earth disc, *E*, has its bearings in the standard, *A*, and is driven by a crank secured to it. The arm, *B*, to which the sun disc, *S*, is pivoted, is connected by gearing with the earth-axis, so that when the earth disc is rotated in one direction, the sun disc is carried slowly around it in the opposite direction, describing the orbit shown by the dotted circle in the figure.

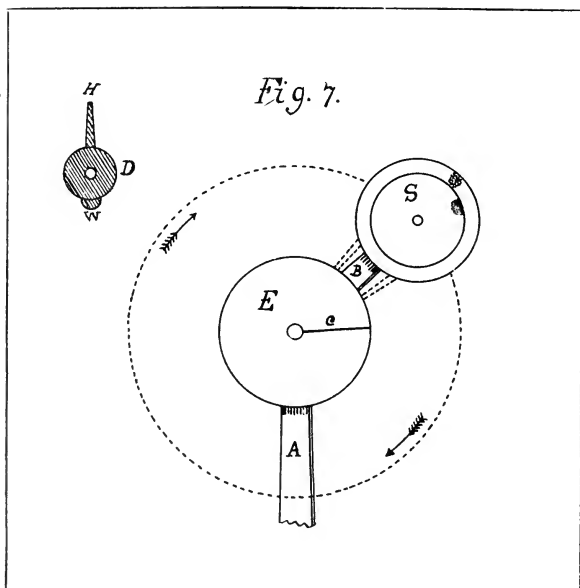

SUN SPOT APPARATUS.

In illustrating with this apparatus, the earth disc *E*, is caused to turn on its axis from west to east, or counter-clockwise, one complete rotation in time representing 25 hours and 49 minutes, while the sun disc *S* revolves in the opposite direction, as shown by the arrows, in a fraction over 14 days ;

or in such time as to come into conjunction with the earth-point of observation (the radial line c ,) every 24 hours. The days are indicated by a bell, which is struck at each of these conjunctions.

The sun figure S , is composed of two separate discs, one smaller than the other, and each bearing a sun spot on its margin, as is shown. These discs are rotated independently, but in the same direction, on the sun axis, by means of separate belt connections with the central shaft, or earth axis; the outer, or equatorial sun spot appearing from c to go round the sun in the opposite direction to its orbital motion, in 25 days; while the inner spot takes 27 days.

In demonstrating this, both sun spots are brought opposite to, or in conjunction with the semi-meridian c , and the apparatus set in motion, while the bell calls off the days. In just the periods above indicated, these spots will respectively appear to go around the sun figure, by coming to conjunction again with the earth meridian, c .

But this only gives the *apparent* periods

of revolution of the sun spots, as seen from the earth, while the sun is always changing its position, relatively to the earth, in moving around it. The question now arises,—What are the *absolute* periods of these sun spots; or in what time do they absolutely go around the sun?

We can determine this by reducing the central mass of the sun to a state of rest—that is, deprive it absolutely of all rotation, and then note how the sun spots will move relatively to it. We will accomplish our purpose by loosely pivoting the small dark disc D , (at left of figure) to the sun's axis, to represent its central portion. It carries a pointer H , and a weight W on the opposite side, which by the force of gravity will keep it always in the same position—that is, absolutely without rotation, the pointer always being directed upward.

If we now turn the apparatus in the same direction as before, starting with both sun spots exactly at the pointer, and note how they move relatively to it, with no reference to the earth whatever, we will discover that

they not only go round the sun (relatively to the pointer) in the opposite direction to the one they appeared to move in before, as seen from the earth, but that the inner spot will now complete its circuit first, by coming to conjunction with the pointer again in just 29 days, while the outer, or equatorial spot falls behind, and will not come to conjunction with the pointer under three days more; making its absolute period 32 days, while that of the inner spot is but 29 days.

This result, it will be seen, completely obliterates the Copernican paradox; as the sun spots now move in the order we might expect them to move, thereby accounting in a natural way for that mysterious factor in the sun's rotation, its apparent Equatorial Acceleration.

Men of Science! is there not a deep significance in this? Here we have one of the most remarkable phenomena (viewed in the light of Copernicus,)—a condition utterly irreconcilable with his theory, under natural laws, which yet gives evidence, through a fair and positive mechanical demonstration,

of being in natural and perfect harmony with that cosmic system outlined in the Sacred Scriptures.—A system that obeyed the command of a Joshua, and gave heed to the pathetic prayer of a Hezekiah; whose wondrous workings were pondered and extolled by the philosophic Job, and whose praises sung by the poetic David.—A system that survived the wisdom of a Solomon, and was mirrored in the prophetic vision of Ezekiel. Shall a few words soberly and considerately spoken in its defense, be denied a sober and considerate hearing?

CHAPTER VIII.

LECTURE III.—NATURE vs. COPERNICUS.

IN observing the movements of the heavenly bodies, many inequalities have been discovered from time to time,—some of but slight significance, but among them one of that important body, the sun, early became conspicuous, which is of such a magnitude that the Copernican school have given it much attention in the past, and after long-continued and patient measuring and modifying, trimming and adjusting, they have adapted their theory to fit it very well, and now employ it as one of the strong pillars of its support. I refer to that inequality treated on in astronomical works under title of,

EQUATION OF TIME.

When I first took up this subject, failing to be a good enough mathematician to quite

understand the Copernican solution of the problem, I fell to doubting its correctness; and to settle the matter, I constructed an apparatus (indicated by *C*, in group of apparatus, page 180) for mechanically testing the same, in which the earth is represented by a globe adapted to move around the sun-centre in the earth's supposed annual orbit, complying faithfully with Kepler's law of "equal areas in equal times," and all other conditions of the Copernican theory.

When my device was completed, I confidently expected that it would disclose to me an error; but in this I was disappointed, for as I carefully moved the globe through its orbit, the indicator traced on its surface with strict fidelity those devious transverse paths indicated by the heavy double looped line at the centre of *Fig. 8*, (the next page), which paths mark those variations of the sun throughout the year from the meridian of mean, or clock time, (the horizontal line *S N*,) which are recorded in our almanacs in the column, 'Sun fast,' and 'Sun slow.'

As it traced this looped circuit, which I

had drawn from tables in the Ephemeris, and knew to be correct, I stood in silent awe contemplating the wonderful accuracy and surpassing genius of the master minds who had elaborated the system.

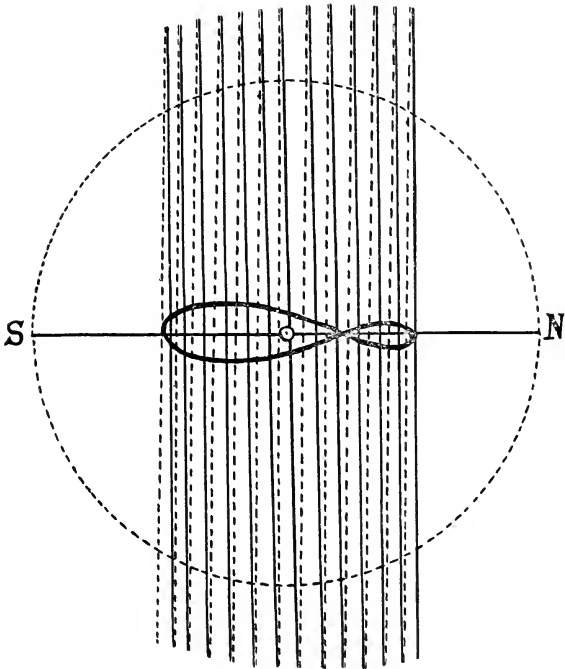

Fig. 8.—SPIRAL ORBIT OF SUN.

So the result of my first experiment with the apparatus only gave me the small satisfaction of having made a mechanical success of my work, while its real object appeared defeated. But I did not rest well under defeat; and on carefully reviewing the matter I found that I could so transpose its primary parts as to have the earth in the centre and the sun going round it in the earth's orbit; and that by strict compliance with all the conditions of the first experiment, precisely the same results would be obtained; and that in this case also, as in that of the sun spot problem, Earth around Sun, and Sun around Earth, are reciprocal terms.

But how would I reconcile the apparent annual revolution of the sun with that semi-monthly revolution indicated by the device for illustrating the sun spot paradox?

In *Fig. 8*, we assume the earth to lie at the centre of the outlying dotted circle, its axis being in line with *S N*; while the solid vertical lines represent the circuits of the sun's spiral orbit in revolving from east to west around the earth, in a little more than

14 days, and in moving also from north to south, or from solstice to solstice; the dotted lines showing the same in returning. It will be observed that the circuits of this spiral orbit are broader over the northern, than over the southern hemisphere, thereby producing Aphelion and Perihelion.

I have found that a movement like this would cause the sun, as seen from the earth, to appear perfectly to describe that inclined annual orbit on the plane of the ecliptic, now called the earth's orbit, by the stars revolving around the earth in the same direction as the sun, (from east to west,) but enough faster to gain one complete revolution on the sun in a year; which would give the sun the appearance of moving eastward among the stars.

It is a remarkable coincidence, that the areas described on either side of the equator by the looped circuit of sun variations, (see *Fig. 8*,) bear an almost perfect inverse proportion to the land areas in the hemispheres of the earth over which they respectively extend; yet it may have no significance.

But astronomers tell us they have one direct and conclusive proof that the earth moves around the sun,—not the sun around the earth. And though they admit that it is the only *direct* proof they have, yet from its infallibility, they esteem it all-sufficient. This strong tower of their defence is called,

THE ABERRATION OF LIGHT.

Standard astronomical text-books define Aberration substantially as follows :

It was long since observed that the so-called fixed stars have each an apparently independent, small, annual movement; those in the ecliptic appearing to oscillate a little backward and forward, those near the poles of the ecliptic apparently describing small circles, while at intermediate places they describe ellipses, more or less drawn out.

Certainly it would have been absurd to conclude that all the stars really have these separate movements, but the appearances having been duly verified, astronomers soon began to inquire for the cause.

The discovery having already been made

that light takes a definite time in coming from a celestial body to the earth, the theory was advanced and adopted, that since the earth also moved round the sun at the rate of nearly 66,000 miles an hour, these two causes, operating together, produced those apparent movements we have described.

The natural, or at least superficial deduction likely to be drawn from such a theory would be, that as light emanating from a celestial body takes some time to reach the rapidly moving earth, we would get ahead of the star, and would have to look back to see it; but we are told that the reverse is the case—*we look ahead to see the star.*

Astronomers, in formulating their theory to meet this condition, compare descending rays of light to drops of falling rain; and a favorite illustration with them is, that if in running through the rain we hold upright a tube resembling the tube of a telescope, but open at the ends, those rain-drops entering the top of the tube will not fall through it, but owing to our rapid forward movement, the rear side of the tube will have been

carried ahead sufficiently to catch the drops in their descent, and in order to have them fall through the tube, we must lean it ahead as we would carry an umbrella when moving rapidly in the rain. Then for the rain, substitute light, and the earth's movement for your own, they say, and you have what we term Aberration.

This is plausible, but is it correct reasoning? In the first place, what analogy is there between rain-drops and rays of light? Are they not simply little globules of water, without continuity or linear dimension? But light comes to us in continuous rays,—no section of a ray so short but that it has a linear dimension and determinate direction, of which the eye takes cognizance.

We will now use a kind of mechanical diagram for studying a beam of light having those characteristics which science ascribes to it.—In *Fig. 9*, the line *A* represents the earth's orbit; *E* a portion of the earth, and *B* a star sending a beam of rays to earth; while *C* represents one of those huge reflecting telescopes, used for exploring the

heavens. It is inclined in the direction the earth moves, for aberration, and is ready to observe the star *B*, in passing.

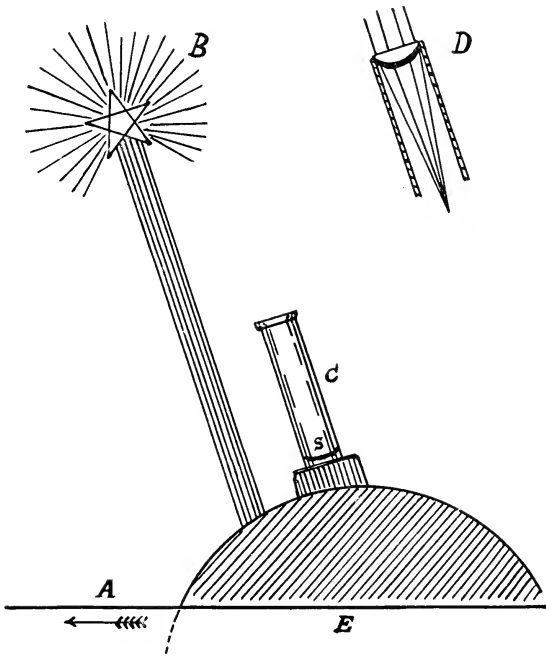

Fig. 9. — ABERRATION.

Now if we consider this beam of rays as being stationary, like their source, the star,

(relatively to the earth's orbital motion,) then as the telescope moves along with the earth, it cuts through these stationary rays, and immediately they descend into the tube *without any change of direction whatever*, and precisely as if the earth had stopped after carrying the telescope directly beneath them,—*except*, that as the earth moves in its orbit with about the one ten-thousandth part of the velocity of light, a telescope like Lord Rosse's, with a tube 7 feet in diameter and 52 feet long, would be carried ahead one sixteenth of an inch while the rays were descending from the top, to the bottom of the tube, and a little less than one thirteen-hundredth part of them would theoretically be cut off from the speculum *S* below, by the front of the tube.—Theoretically I say, but not really so; for since the speculum is but 6 feet in diameter, it necessarily has a margin of 6 inches around the inside of the seven foot tube.

Is not this a truthful presentation of the case? But wherein exists then the obstacle to direct vision—where does the aberration

come in? Do we not see the star by its direct rays falling on the speculum, and therefore see it just where it is?

But it may be suggested that I have used the reflecting telescope in illustrating, because it suits my purpose best; and as this important question deserves to be treated fairly, we will also consider what results a "Refractor" would give :

Assuming that the tube of our refracting telescope is pointed in the exact direction of a ray of light coming from a distant star, and that this ray passes through the centre of its object-glass, if the telescope were at rest, the ray would pass down the tube, directly to the centre of the eye-piece below. But as the eye-piece and object-glass are both carried ahead by the earth's motion, the ray would fall slightly behind the centre of the eye-piece—unless we inclined our telescope a little in the direction of its motion.

Ah! the novice will triumphantly say, I thought so! But the man of science will at once see that we have only been considering the results due to a piece of plain glass for

an objective, with no refractive power whatever. Let us now exchange this for a more correct form of objective—a plano-convex lens. (See sectional cut *D* in *Fig. 9.*)

This objective has the power to refract all rays of light falling perpendicularly anywhere on its plane outer surface, practically to the centre of the eye-piece, at the other end of the tube, and a ray passing through this objective, would as before, on account of the advance of the earth in its orbit, pass a little toward the rearward edge of the objective in descending the tube; but unlike when it passed through the plain glass, it would now, as shown by its four positions at *D*, in the figure, be refracted, or turned forward precisely the distance that the eye-piece and objective were carried ahead; or in short, it would be focused on the centre of the eye-piece at whatever part of the lens the ray passed through; clearly requiring no forward inclination of the tube to convey it to the eye of the observer.

This theory of aberration however gains its chief support from yet another branch of

astronomical research, which appears to be in harmony with it, and it is the proud boast of the Copernican school that they could not be made to agree in any other system than their own. This important coadjutor, is—

STELLAR PARALLAX.

Measuring the parallax of a star, we are told is the most delicate, and it seems to us, the most indefinite operation in practical astronomy. Of the two principal methods employed, that called the *absolute*, is found to be so sensitive to temperature effects,—unequal refractions, varying expansions of instruments, etc.—as to rather give to the other, or *differential* method the preference. This latter method however, as its name implies, only gives comparative results, and is devoid of that precision which alone can satisfy the unbiased practical mind.

But what more particularly interests us at this point is, in what way does it fortify the theory of aberration?—In *Fig. 10*, (next page) the large circle represents the earth's orbit, with the sun near its centre, while

the small circles represent the earth at the four quarters of its annual circuit. Each earth figure carries a huge telescope, for observing a distant star lying overhead, in the direction of the dotted line $c c$.

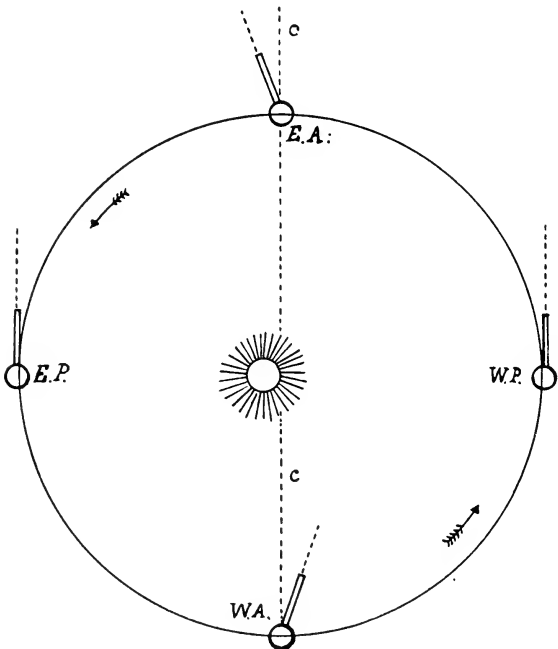

Fig. 10.—ABERRATION & PARALLAX.

Now, if aberration and parallax came together, it would be easy to dispose of the former, by calling the visible displacements all parallax; but we find that they really do come just 90° apart; and since it is clear that a parallax of that star, in the direction of $c c$, could only be gained from the two outlying points, $E. P.$ and $W. P.$, the intermediate places, $E. A.$ and $W. A.$ must necessarily be the aberration points, or points of maximum aberration; and while at $E. P.$ and $W. P.$ we theoretically incline our telescope less than $1''$ of arc for observing the greatest stellar parallax, we have it inclined at $E. A.$ and $W. A.$ $20''$ for aberration.

Is not this, after all, overwhelming proof of the correctness of aberration, as well as of the Copernican theory? Or is there some other system under which these conditions could be made to harmonize? This was the hardest problem that I ever encountered,—and when the solution was finally reached, it appeared about the simplest. I will now endeavor to give the result obtained, by the aid of the diagram, *Fig. 11.*—next page.

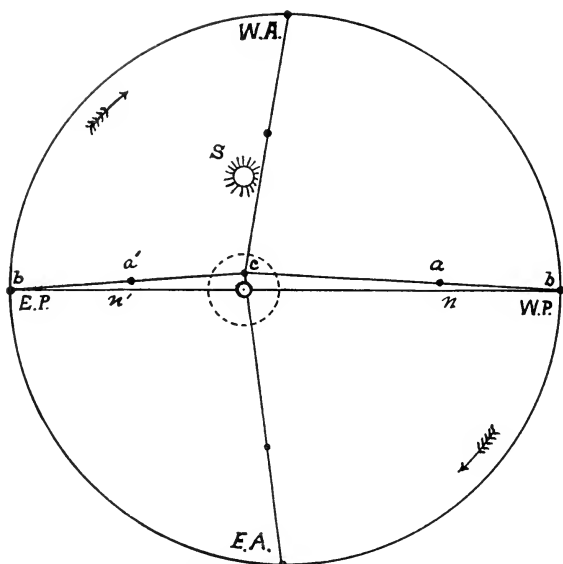

Fig. 11.—ABERRATION & PARALLAX.

In this figure, the disc described by the large circle represents the starry sphere; all the stars revolving independently (except as they attract each other) in slightly elliptical orbits, around one common eccentric point, indicated by c ,—the earth-axis, represented by the small dark circle, lying a little outside of that point, while the dotted

circle represents the earth's circumference. The lines radiating from the earth-axis extend in the directions of what we will, for convenience in illustrating, call the maximum points of eastern and western parallax, marked *E. P.* and *W. P.*, and eastern and western aberration—*E. A.* and *W. A.* The small dots on, and at the termini of the lines running from *c*, represent stars, for observing aberration and parallax.

Now, if the sun *S*, and the stars revolve in the direction of the arrows around the earth, the stars moving enough faster than the sun to gain one complete revolution on it in a year, thus giving it the appearance of moving eastward among the stars, in six months the star *a*, for example, which now appears a little to the left, or easterly from the earth-perpendicular line *n* (as seen from the earth) would gain a half revolution on the sun, and relatively to earth and sun, appear at *a'*, or a little to the right, or west of the earth-perpendicular line *n'*, thereby giving us a parallax of that star; while of the star *b*, that is still on the perpendicular

line, no parallax would be obtained; or we would say, it has no parallax.

In three months' time, and again in nine months we would have both stars on the radial lines leading from earth-centre to *E.A.* and *W.A.*, respectively. But these lines, though touching the outer circle at just 90° from the lines *n*, *n'*, are not like them, perpendicular to the earth; but owing to the slight eccentricity of the centre *c*, of stellar revolution, and of the earth, they are a little inclined, so that we get an eastern aberration of both stars in the direction of *E.A.* and a western aberration of the same in the direction of *W.A.*

It may however be suggested that while such a plan would produce those apparent oscillating movements of stars in the ecliptic, yet it would not produce that apparent circular motion of those stars near the poles of the ecliptic.

While it might be difficult to refute such a criticism on paper, yet I have anticipated it by so constructing the physical apparatus made for illustrating this plan, (indicated

by *D*, in group of apparatus, page 180,—from which the diagram in *Fig. II*, is taken) that a star can be moved on one of the radial cords, to the pole of the ecliptic, and a small circle placed over it, so connected with the apparatus as to move concentric to the earth, like a fixture on its surface, while the star moves *eccentric* to it, as before; then on revolving both around the earth-centre, the star is seen to move around the small circle; while at intermediate places it will describe that compromise between a circle and an oscillation—an ellipse; thereby fully demonstrating that those apparent motions of the stars called aberration, which it has taken such an abstruse course of reasoning to account for by the theory of Copernicus, might be produced by the natural and harmonious operation of universal and direct revolution, in another system.

KEPLER'S SECOND LAW.

We have thus far only been examining some of the chief supports of the system of Copernicus. Let us now briefly consider

the stability of that fundamental law upon which the whole structure rests, and without which it has no foundation.

Successive observations having satisfied astronomers that the earth (on the Copernican theory) moves slowest in its orbit round the sun when farthest from the centre of force, and *vice versa*, and that order of its motion being in opposition to the familiar law of centrifugal force which regulates the movement of all revolving bodies, it became necessary to either relinquish the theory of Copernicus, or discover some new law for its justification.

Out of this dilemma was evolved Kepler's second law of planetary motion—"The radius vector of each planet describes equal areas in equal times:"—which in connection with Newton's law of gravitation, would impart perfect equilibrium to a revolving body in any part of its orbit, however near to, or remote from the centre of force.

Then, as the natural tendency of *moving* bodies, when all lateral forces are balanced, is to move in a straight line, how could the

orbital motion be preserved, or the integrity of such a system be maintained?

The Copernican school soon discovered this discrepancy, but having become thoroughly committed to the theory, they soon set to fortifying its weak point; and with a sagacity which challenges our admiration, inserted what they are pleased to call the "Newtonian constant;" which appears superficially, to fill the breach; though what philosophical relation it bears to either the law of Kepler or of Newton, or to what it owes its existence, except that it was needed to bolster up the Copernican theory, I have been unable to determine.

But even this expedient, though theoretically available, does not bear the test of practical demonstration, as is shown by the experiment I will now describe:

Believing that this law of Kepler's was unable to sustain itself by a true mechanical demonstration, I designed and constructed an apparatus for plainly and fairly testing the important question.

The two essential features in a device of

this kind would naturally be, a method of giving a revolving body that unequal motion in its eccentric orbit, which would cause its radius vector to describe "equal areas in equal times," and another of giving it a tendency toward the centre of force, inversely proportionate to the square of the distance from the centre.

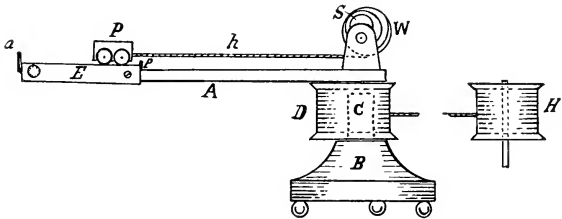

Fig. 12.—APPARATUS.

The device with which this interesting experiment was made, is outlined in *Fig. 12*, and also appears at *F*, in group of apparatus, (page 180). It embodies, in addition to the features named, a mode of bringing into use the so-called "Newtonian constant." It is so constructed as to cause the revolving car, or planet *P*, to describe an orbit, relatively to the centre of force (if obedient to

the law of Kepler) which would be the exact copy in miniature of the orbit of Mars, relatively to the sun.

In the figure, B represents a base, from which rises vertically the pivot C (in dotted outline). Turning freely on this pivot, is a flanged or spool-shaped *eccentric* pulley D , to which the horizontal arm A is rigidly secured which carries the revolving body P . The arm A is set in motion by means of a cord wound around the eccentric pulley D and drawn from it by winding on the other pulley H , which is driven by some steady power; the pulley D being of the proper eccentricity and ellipticity to give the radius vector, or arm A , its proper motion for describing equal areas in equal times while it is being so driven.

The planet P is in the form of a car, its wheels having perfect anti-friction bearings and concave rims, running on a pair of knife edge rails E . The car body is fitted with a shot receptacle, by which its weight may be varied. It is drawn centreward by the cord h winding on the eccentric pulley W ,

to which a rotary force is given by a coiled spring S ; the pulley W being regulated by stops to turn just half way round; one half of its circumference exactly equaling the difference between perihelion and aphelion, or the least and greatest distances of the planet P from the centre.

The tension of the coiled spring S , and the eccentricity of the pulley W are so adjusted that a spring weighing scale attached to the car P , and drawn outward, will register a centreward attraction, which is inversely as the square of the distance from the centre.

While the arm A is strictly level, yet the rails E are adjustable for grade, and when they are also level, the car P , when made to revolve around the pivot C , is only affected by the two conditions—its unequal propulsion in its orbit, and the centreward traction of the cord h . But by slightly elevating the outer end of the rails E , we also give the car a *gravity* tendency toward the centre, which is uniform from end to end of the rails. This supplies what is called the

“Newtonian constant;” which is increased or diminished, as the rails are more or less inclined.

I made many careful experiments with this apparatus, both with the rails E level, and with them variously inclined; but they all gave practically the same results—when the orbital motion of P was just sufficient to start it from the perihelion stop p , in the fastest portion of its orbit, it would roll out toward the aphelion stop a , but return to p again on or before reaching the slowest, or the aphelion portion of its orbit, and remain there till it neared the fastest, or perihelion portion of its orbit again; and when the orbital motion was slightly increased to gain better results, it would roll out to a , and remain there; manifesting a disposition to leave the system, but for the restraint of the cord h , and stop a ; thus clearly demonstrating that Kepler’s second law furnishes another instance in which theory and practice do not join hands.

The fallacy of this law may however be illustrated without resort to the mechanical

experiment which we have described, by the use of the following diagram:

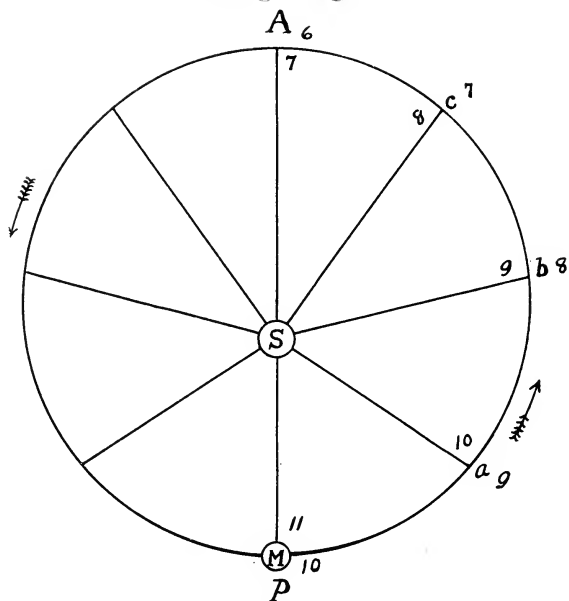

Fig. 13.—KEPLER'S LAW.

In this figure, *S* represents the sun, or centre of force, and *M* a planet at the perihelion point of its orbit, revolving around *S* in the direction of the arrows—its radius vector describing equal areas in equal times.

As the central attraction must necessarily be a little stronger than the tangential tendency of a revolving body, to keep it in its orbit, we will (referring to the diagram) let 10 represent the centrifugal force of the planet M , gained from its orbital velocity, at P ; and 11 the combined focal attraction due to the “Newtonian constant” and the general law of gravitation, (assuming the Newtonian constant to be 1.)

At a , with the velocity of the planet and the focal attraction diminished, let 9 represent the centrifugal, and 9 plus 1,—or 10, the centripetal force affecting it; at b , let 8 and 9 represent the two forces; at c , 7 : 8, and at A , 6 : 7.

The planet has, at A , reached its lowest velocity, and from this point on toward P again (according to Kepler) its orbital motion, and therefore the centrifugal force will gradually increase, and the centripetal force also reassert itself.

From P to A , the influence of the two opposite forces on the planet was steadily diminishing; but through the assistance of

the Newtonian constant, that of the centripetal force weakened less than the other—as 7 : 6 exceeds 11 : 10; yet with this advantage it has only in part been able to restrain the planet from flying off in a tangent, since its radius vector has steadily lengthened.

But from *A* to *P* again, the conditions are reversed; the centrifugal force steadily increasing, while the centripetal force will increase in a smaller ratio (falling from 7 : 6 at *A*, to 11 : 10 at *P*.) How then could the latter, with its power, relatively to the centrifugal force, *weakening*, draw the planet back to perihelion, or *shorten* its radius vector, when it was unable to restrain the same from *lengthening*, on its way from *P* to *A*, where the conditions were reversed, wholly to its advantage?

The truth of the matter is, that at *P* the centripetal force is not sufficiently strong, relatively to the centrifugal, to keep the radius vector of the planet from lengthening; but by the aid of the Newtonian constant it becomes so at *A*, from which point, if the orbital motion continue the same as at *A*—

no greater, no less—the planet will continue in a circle, without any change in its radius vector; but if the orbital motion be increased at *A*, then the centrifugal force will also increase, and carry the planet still farther from the centre; since the focal attraction on the planet can only be increased—*by first bringing it nearer to, the centre of force.*

A NEW SYSTEM OUTLINED.

Though I have been freely criticising our present accepted astronomical system, yet it is neither my purpose nor desire to advocate a new one; as I am far from being fully assured that it is the Divine pleasure to reveal to our finite minds, except in a general way, the great plan of the Universe. But lest it should be said of me—He seeks only to demolish and destroy where he could not plan to build,—I will suggest the outline of a plan by which the apparent movements of the heavenly bodies might all be produced, not only in harmony with natural laws, but also with the revealed Word of God.

In such a plan, I would have the earth

practically at the centre, as indicated by *E* in *Fig. 14*, rotating on its axis (from w to e) in 25 hours 49 min. 10 sec ; the moon *M* revolving around the earth in the opposite direction to the earth's rotation, (or from e to w) in her sidereal period of 27.32 days ; the

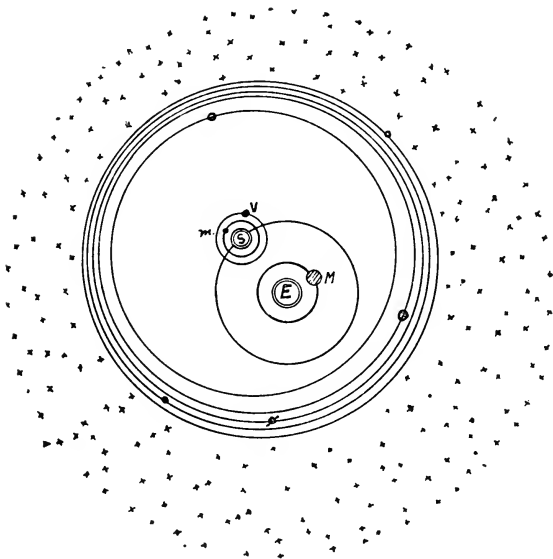

Fig. 14.—A NEW SYSTEM.

sun *S* going around the earth in the same direction as the moon, in 14.19 days ; moving

spirally from solstice to solstice and return, with its circuits a little broader over the northern, than they are over the southern hemisphere, for aphelion and perihelion, as shown in *Fig. 8*, page 219.

I would have Mercury *m*, and Venus *V*, revolve round the sun, as shown, and travel with it, as satellites of that body, in its circuits round the earth; the superior planets, as is shown by their orbits, moving slowly (from E to W) around the sun as a secondary centre in their synodical periods, while traveling round the earth with the sun, and like that body, moving spirally from north to south and return, in their sidereal periods; the stars revolving around the whole in orbits a little eccentric to the earth-centre, in the same direction as the sun, but enough faster to gain one revolution on the sun in a year; which would be a complete revolution in 13.66 days.

This would produce the apparent movements of the celestial bodies in their proper order and periods, and account for aberration, equation of time, and that apparent

equatorial acceleration of the sun, in the manner already explained; but how would I reconcile such a plan with the established law of gravitation?

I would reply—Not by seeking to change that law, so far as it pertains to things terrestrial, (of which portion only we are able to take practical account) but by amplifying and extending the demonstrable portion of that law, to embrace the universe.

UNIVERSAL GRAVITATION.

Respecting the application of this law of gravity to our habitable globe, we have been taught that those portions of the earth the nearest to its centre, are the least attracted centreward, while the attraction increases directly with the distance from the centre, being therefore theoretically greatest at the earth's surface.

Now, is this the result of Cohesion, or is the law of gravity, in this case, modified by that force? Presumably not, since we are taught that cohesion acts only at insensible distances. If then, it is the result of gravi-

tation, pure and simple, would not the *order* of attraction be the same, if the earth were divided into millions of small bodies — separated by space, but collectively retaining the globular form? And may not the millions of visible bodies, together with that boundless infinity of invisible ones which constitute our universe,—though separated by space, yet united by the strong bonds of their mutual attractions—be drawn in the same *order* toward a common centre, yet retained in their places by the centrifugal force evolved by their orbital velocities?—The moon (nearest the centre of the system) revolving slowest, being the least attracted; while velocity and attraction increase steadily as they move out from the centre,—the stars revolving most rapidly, being most attracted.

This would be in perfect harmony with that natural, familiar, and easily demonstrated law of centrifugal force, that the orbit of a revolving body is expanded by increasing its velocity, and contracted by decreasing it. It is also evident that the farther a

body gyrated from the centre, the more it would be restrained from leaving such a system, and the nearer one drew to the centre, the less it would be attracted toward it; both of these conditions operating against a change in the original distribution of bodies throughout the universe, while the failure of Kepler's second law to sustain itself in a fair and carefully conducted physical test, demonstrates that directly opposite and disorganizing conditions exist in the theory of Copernicus.

But it may be argued that a planet like Jupiter or Saturn, for example, with its satellites revolving around it, in direction from W to E, those with largest orbits revolving slowest, is a visible presentation and justification of that theory, and discloses God's plan of operating world systems.

To such an argument I would reply, that the satellites of a planet, in the Copernican plan, or in the one I have suggested, have two motions—their lesser, or secondary revolution round the planet, and their greater, or primary revolution *with* the planet round

the centre of the system. Now, in the plan outlined in *Fig. 14*, those planets revolve *absolutely* round the earth, and also around the sun, from E to W; and their satellites, in revolving round them from W to E, would be affected by that more rapid primary motion round the earth, as follows :

Those satellites revolving farthest from their planets, or having the largest orbits, would, in keeping with my theory, have the slowest primary motion around the earth, when nearest to earth, and the most rapid when in the opposite, or most distant part of their secondary orbits around the planet; and the secondary motion of the satellite—from W to E around the planet—would be in the same direction as the primary motion when it is nearest to earth and moving the slowest around it, which tends to retard its secondary progress, and therefore prolong its period; and this secondary motion would again be retarded on the opposite, or farther side of the planet, as it would there be counteracted by the increased primary motion, which it would then be moving against; this

would still further prolong its period. It is evident that on this principle, the nearer a satellite revolved to its planet the less those retardations would be, and in consequence, the shorter its period.

This would account for the perplexingly short period of Phobos,—inner satellite of Mars; and might also throw some light on the eccentric behavior of the satellites of Uranus and Neptune.

But wherein exists the chief difference between the two theories which promise the same apparent results? Manifestly in this: Instead of esteeming our universe as being at rest, except as a few bodies of the Solar system move in their orbits, and the stars, by their scarcely perceptible so-called proper motions, move chaotically, “like bees in a swarm,” as the Copernican text-books express it, I would ascribe to it, as a universal *whole*, the action of rotation—as in action only there is life—the stars in their respective orbits differing sufficiently in motion to produce their apparent “proper motions,” while the lesser velocities of sun, moon, and

planets, give those bodies the appearance of traveling eastward among the stars.

The plan I have suggested would also correct that glaring inconsistency of the Copernican theory which would give to those planets observed to have the slowest *rotation*, the most rapid motion in their orbits: For example, Mars is observed to take 24 hours 37 minutes, in turning on its axis, but is given an orbital velocity of about 15 miles per second; while Jupiter rotates in a little more than one third of that time, (9 hours 55 minutes) but is given an orbital motion of less than 8 miles per second. This greater rotary motion would however harmonize perfectly with the increased orbital velocity of bodies farther from the universal centre, in the plan outlined.

Of most importance however, is the consideration that such a plan, by puncturing the root, might tend to check the growth of that false sentiment which would arrogate to modern man the superior wisdom, ability and privilege of supplanting the records of Divine revelation with the records of human

achievement, and set at naught the inspired words of those devout men who in the purity and simplicity of an exalted faith—through Nature's works, communed with Nature's God; nor deemed it necessary to attempt the *elaboration* of an astronomical system whose well defined outlines no sacrilegious hand might e'er disturb.

But as I have said, I have no intention of advocating a different system, either new or old; for in the light of the discoveries I have made, and deductions I have drawn—and by the memory of an early experience, when a Voice Beatific spake Peace! from out the shadows, I have been led up to the conclusion that it is unsafe to advocate any theory, or formulate any system of human knowledge which is not found, after the *fullest* and *fairest* investigation, to be in perfect harmony with both God's Word and works; and while memory lives, and reason retains its throne, the recollection of that early experience when the mind's eye was quickened into gazing retrospectively through God's Word, as along a panorama, from Patmos

even back to Chaos, to see all alleged inconsistencies vanish, all apparent differences reconciled, and the Star of Truth shining resplendent over all,—that recollection will prompt me to maintain that where Science and the Bible clash, there Science must give way; and though Man, with his God-given powers has achieved wonders, and is still progressing, yet we should ever remember that, as in the material world the stream cannot rise above its source, so in the grander realm of thought, human knowledge cannot, and must not assume to rise above the Source of all knowledge.

And while to man much to know is given, yet as God's thoughts are not our thoughts, neither our ways his ways;—for as the heavens are higher than the earth, so God's ways being higher than our ways, and his thoughts than our thoughts, there must of necessity be some knowledge which is peculiarly and exclusively his; and to which we may not hope to attain, till that time when standing in the light of his presence, we shall be more like him, for we shall see him

as he is. And I feel that I can offer no more fitting conclusion to this discourse than that impressive stanza from Derzhaven's Ode to the Deity, which thus beautifully embodies this sentiment :

*“In its sublime research, Philosophy
May measure out the ocean deep, may count
The sands, or solar rays; but God, for thee
There is no weight nor measure! none
can mount
Up to Thy mysteries! Reason's brightest
spark,
Tho' kindled by Thy light, would vainly try
To trace Thy counsels, infinite and dark;
And thought is lost ere it can soar so high,
Even like past moments in Eternity!”*

CHAPTER IX.

WHILE preparing the foregoing lectures, the impression gained with me that a work in defense of the Bible would be imperfect and unfinished, which did not also make a practical application of its teachings to the needs of mankind; and when I went forth to give the results of my labors to the world from the lecture platform, I took with me the following discourse, hoping my scientific lectures might receive that financial support which would enable me to present it from the same platform, without fee or collection, or desire for any personal advantage.

I hoped in this way to reach many people who would come to a public hall, but could not be induced to enter either a fashionable church, or a charity chapel. The results of my effort are already known to the reader. —The lecture follows:—

(*Free Lecture.*)

HOW THE POOR MAY BECOME RICH.

In these days of cultured skepticism when Infidelity proclaims its tenets in our public halls, and is applauded to the echo for its bold attacks on our Christian faith, it behooves us who are followers of the Master, each to do what he or she can, to stem that tidal wave whose dark wake is strewn with physical, mental, moral and spiritual suicide and death.

It may however appear highly presumptuous for a plain workingman to announce a lecture in this wealthy and prosperous city, whose object is to benefit the poor; but I am credibly advised that there is one poor man like myself residing somewhere in this town, and I appear in the interest of that man,—I have given him a special invitation to be present, and I think he is with us on this occasion.

I trust therefore you will pardon me if I keep my promise with him, by pointing out

the way by which he may also become rich. I feel the more constrained to pursue this course, because in the house of the Master I am so poorly serving, there is more joy over one poor man who *becomes* rich, than there is over ninety and nine other men, who are already rich enough.

While I am indicating the way by which he may gain a clear title and a lasting tenure of a beautiful mansion in a delightful country, I shall also be answering, definitely and unequivocally, that question of vital import which Col. Robt. Ingersoll has been asking all up and down the land, for two hundred dollars, and upward, a night; while his vague and futile efforts at answering the same himself, have received that generous applause which usually crowns a triumphant success.

[Note.]—reference is made to Ingersoll's lecture, "What must we do to be saved." He was living then, and I expected to meet him, and answer his question.—

As this answer concerns us all, I hope to retain your attention while I unfold to my

fellow workingman the grandeur of the inheritance which may be his; and that its beauty and desirableness may be enhanced by contrast, let us first, my friend, briefly survey your past life, present condition, and your present hope of the future :

You started out in life's fair morning, with the hope and health and strength of youth. How beautiful the world looked, and how easy seemed the battle of life. Kind friends greeted you everywhere; encouraging words and smiles cheered your walk by day, and sweet sleep with pleasant dreams, renewed your strength by night.

How your young heart beat with lofty aspirations—you would mount the ladder of Fame, and would stand up in noble defence of the rights of your people and your country; or you would gather liberally of the wealth which lay at your feet, and bestow it on the less fortunate with that bounteous hand which would cause men to bless your life, and cherish your memory. Your strong right hand, unclouded brain, and evenly pulsating heart—appeared to you, to hold the

key to your destiny, and if you failed—the fault would be your own.

Time sped, the conflict deepened. Life's poetry was merging into prose—its idealism into stern reality. With clenched hand and flashing eye and girded purpose, you met the condition, and struggled nobly for the mastery. The tide of fortune ebbed and flowed, while time moved on with relentless tread.

At length misfortune came—a trusted friend proved false, a business enterprise unsound;—anxious days, sleepless nights, sickness followed; and when you rose from that couch of pain, the world for you had lost much of its freshness, and your heart much of its hopefulness; but the thought of loved ones dependent on you called you again to the post of duty, and with strength impaired, and hopes modified by defeat, you entered once more life's great struggle.

Brighter days came, and hope revived: but alas! how fleeting. One morn a cheery voice which had made music in your home, was stifled by throes of pain. A few days

of suffering—of mortal agony, and the pure spirit was wafted upward, while the beautiful form was laid from your sight, beneath the cold clods of the valley, and your hand was again unnerved for the conflict.

Thus on and on, life's tide has ebbed and flowed,—each successive circle narrowing a little, till you have been brought down to the hard lot of unremitting toil for your daily bread; hoping for nothing now, but that the work may hold out, and the frugal pay continue, that you may keep the hungry wolf from the door.

Meanwhile time goes on. The form is less erect, the step shorter, the hand less steady; while the eye is growing dim, and tell-tale locks of silver lead your thrifty employer to ponder if your place could not soon be better filled by younger help.

And what then? A place by your children's fireside? Perhaps a nook in the home for the stranger. A few months or years of weary waiting,—then a simple burial service, a narrow grave,—and all that is mortal of your once happy self, will be hid from

earth, *forever!* And is this the end? *Is* this the end?

O no! O no! Look up! look up! "Behold I bring you good tidings of great joy, which shall be to all people! For unto you is born in the city of David, a Savior, who is Christ the Lord!" And what message brings this Savior to you?

"Blessed are the poor in spirit, for theirs is the Kingdom of Heaven.

"Blessed are they that mourn, for they shall be comforted.

"Blessed are the pure in heart, for they shall see God.

"In my Father's house are many mansions: if it were not so I would have told you. I go to prepare a place for you."

But methinks I hear this toiler say, What is all this to me? Have I not lived to see Vice prosper, and Virtue go threadbare—to see the wicked and unscrupulous rolling in wealth and luxury and ease, while the honest and deserving and the God-fearing were ground beneath the iron heel of Poverty?

This has led me to doubt God's direct interference in the affairs of men, and to attribute all results to that unrelenting law whose operations culminate in the survival, not exactly of the fittest, but of the strongest and most crafty.

Believing that as the bonds of the toiling millions are tightening, this sentiment is also growing, you will pardon me if I begin at the root of this subject :

In the first place, reason and observation and experience, all teach us that nothing exists or takes place without a cause; and the existence of a Great First Cause, I think no sensible person will attempt to deny: and whether, in the language of the freethinker, we choose to call that Cause—Nature, or whether, in the language of the Scriptures, we say—God! does not in the least affect his personality; but what most directly concerns *us* is, What relation exists between us and that Great Cause, and how are we affected by such relation?

In the vegetable and in the animal kingdoms, everything does indeed appear to be

governed by some general and immutable law. The tender shoot springs from the seed, takes root, develops into the tree, puts forth its leaves, flowers and fruit; and the eagle builds his nest, and the wild beast his lair, the same as centuries on centuries ago; no progress, no improvement.

But with man all this is changed. Born into the world the most helpless of all creatures, he matures into a being endowed with those higher attributes of inventive and creative power which so emphatically distinguish him from all else created; and which under favoring conditions rise to a grandeur of achievement, bearing unmistakably the imprint of divine preferment.

Is it strange then, that this distinctive and superior being should have been made the recipient of God's special consideration and care? But the question may be raised, Why then did he leave man free to fall into temptation and sin, whereby came death, and all our woes? I will try to answer that anticipated question by the use of a homely, though I think, pertinent illustration:

We will suppose you have a beautiful horse—far more beautiful and intelligent than any you have ever before possessed or cared for; so intelligent, in fact, that you decide on giving him a few extra points in horse culture. You attach a long cord to his bridle and start him toward the street, saying, Now sir! when I call Halt! you are to stop. And when I say, Return! then you must turn, and come back to me.

When the horse reaches the street, you draw firmly on the cord, call Halt!—and the horse stops, because he does not feel at liberty to do any other way. You say, Return! and begin to reel in the cord hand over hand, and he comes back to you, for the same reason. You repeat the lesson several times—always with the same result, of course.

Well now, you are not very much elated over that animal's behavior,—he has only done for you what you compelled him to do; but finally you strip off the bridle, and send him out free. As he again nears the street, you call, Halt! and (anxious moment) the horse *stops!* You say, Return! and pirou-

etting gracefully, he hastens back to you. O, how the glad smiles illumine your countenance, and how heartily you caress that noble animal, who has honored you by his obedience, though free to transgress.

The inspired poet, Milton, expresses this sentiment in loftier phrase in his "Paradise Lost," where he assumes God to say:

"I made him (man) just and right,
Sufficient to have stood, though free to fall.
Such I created all the ethereal Powers
And Spirits, both them who stood, and
 them who failed;
Freely they stood who stood, or freely fell.
Not free, what proof could they have given
Of true allegiance, constant faith, or love,
Where only that they needs *must* do appear-
Not what they would? What praise [ed,
 could they receive,
What pleasure I, from such obedience paid;
When will and reason (reason also is choice)
Useless and vain, of freedom both despoiled,
Made passive both, had served *necessity*,
Not *Me*?"

Milton.

Thus the poet very reasonably raises the question, What satisfaction, what recompense would it have been to God, to endow man with these higher attributes, and then place him in leading-strings, by which he would be compelled to serve Him; instead of leaving him free, that he might honor and glorify God, by serving Him of his own volition? "For verily I say unto you, that joy shall be in Heaven over one sinner that repenteth, (or comes back to God of his own free will,) more than over ninety and nine just persons who need no repentance."

With this brief argument in support of the doctrine of man's free moral agency and consequent fall, we will now proceed to consider the reasonable requirements and the efficacy of the Gospel plan of redemption:

The Scriptures inform us that as men multiplied on the face of the earth, through an evil influence they became disobedient to the extent that God repented of ever having created man, and that he determined to cut off the whole human race; but finding one righteous family, he mercifully spared them

from the angry Flood, and when the waters abated, Noah and his family went out from the Ark, to re-establish man's dominion on the earth.

It would seem that the descendants of such goodly stock, which had been so miraculously saved from the general ruin, ought to have been able to walk in the paths of rectitude and holiness; but it appears however, that as their numbers again increased, many wandered from their allegiance and became as heathen and outcast to the Lord, while the descendants of faithful Abraham became his chosen people.

Of the wanderings of this chosen race and God's dealings with them, it is not our purpose now to speak, more than to remind you that throughout the whole record there runs a sentiment indicating that God had not forgotten the remnant of mankind, and that he would in his own good time declare a general amnesty to all the human race, as is evinced by the frequent references which his prophets make to a Messiah, who when *He* came, would deliver those in bondage.

And how nearly are the ways of our wisest and best men fashioned after this course. Many will recollect that at the close of our Civil War (1861—65) only a portion of those who had borne arms against the Governm't were pardoned, while the instigators, leaders, and worst offenders were denied all the rights of citizenship.

But as time passed, and passions cooled, and wounds healed, our statesmen relented, and it was resolved to send out a general amnesty proclamation; that whoever would might come and take the oath of allegiance and receive pardon.

And now, in what form and after what manner came the bearer of that other and earlier proclamation from On High? Not as the Jews expected He would come—with pomp and power; which have everywhere and in all ages been the accompaniments of wrong and oppression; but he came just as God's prophets foretold, centuries before, that he would come,—as a man of sorrows, and acquainted with grief; as the Lamb of God to be offered for our transgressions; as

the meek and lowly Jesus,—with passions human enough and sensibilities keen enough and sympathies deep enough,—and power great enough, to understand and pity and forgive all our sins—if we wish to be, and will seek to be forgiven.

But what are the proofs of his divinity? When he came up from his baptism in the River Jordan, Behold! the heavens parted, and the Spirit of God was seen descending upon him like a dove; and Lo! a voice from Heaven was heard saying, “This is my beloved Son, in whom I am well pleased!”

At his command the lame walk, the blind receive their sight, the lepers are healed, the *dead are raised!* He calms the wild waves, and walks upon the sea: later he bursts the bars of the tomb, and is seen by competent witnesses ascending bodily up to Heaven. And we who have been touched by his healing power—we *know* that he was Messiah who was to come. And this was his proclamation to mankind:

“For God so loved the world that he gave his only begotten Son, that whosoever be-

lieveth in him should not perish, but have everlasting life." *St. John, 3 : 16.*

"I am the resurrection and the life: he that believeth in me, though he were dead, yet shall he live; and whosoever *liveth* and believeth in me, *shall never die.*" *John, 11.*

"I am the way and the truth and the life: no man cometh unto the Father, but by me." *St. John, 14 : 6.*

Since on the promises contained in this message hangs our only hope of Heaven, let us give it a calm and dispassionate consideration, to see if that hope is well founded :

First, the proclamation is not made to any particular race, creed, or class; but to all mankind: for it distinctly, emphatically, and repeatedly uses the word, Whosoever; which in our language means anybody. But why does it not say *everybody*? Because my friend, there is one condition embodied in it; —not the taking of an oath of allegiance, as in man's proclamation, but simple belief in the Savior — "Whosoever believeth in him shall not perish, but have everlasting life."

But you may say, I believe in the Savior,

—that is, I believe there was such a person, and I never raised the question but that he performed the miracles ascribed to him, or that he was the Son of God.

I would ask, Have you ever felt a deep conviction—a conviction akin to knowledge itself—that God has, for Christ's sake forgiven you all your sins? If not, perhaps then you have only believed *of* the Savior, and not *in* him, as the condition requires; for there is a most decided difference between the two ways of believing.

To illustrate this, suppose you were suffering from some disease which baffled the skill of your family physician, and he would advise you to employ a skilled specialist in a neighboring city. Well now! you would believe *of* that other physician—that there was such a person, because you had been so credibly informed of him; and you would not dispute the medical skill your physician ascribed to him; but you would not believe *in* him fully, would you, till he had cured *you*? Then you would believe in him with all the fervor of a grateful heart.

And how would you be cured; by simply believing that there was such a physician, and that he did cure cases similar to yours? Or by going to him, and asking him to exercise his professional skill in your behalf?

This is just what you must do to acquire that belief in the Savior which will give you a passport to eternal life and happiness beyond the grave—you must come to him and be morally and spiritually healed!

Then why not come—his invitation is so cordial and assuring? He says “Come unto me, all ye that labor and are heavy laden, and I will give you rest. Ask, and it shall be given you; seek, and ye shall find; knock and it shall be opened unto you.”

But why come to Christ? Why not carry our petitions direct to the Father? Because Christ, the divine representative of the Father distinctly says: “I am the way and the truth and the life: *no man cometh unto the Father, but by Me!*”

And how much is the human heart like this, after all! We will suppose you had a son who disobediently wandered away from

you, and became so lost and sunken in moral depravity and shame, that in your deep disappointment and sorrowful resentment, you disowned and disinherited him: but as the years roll by, and the first sharp pangs of your great grief become softened into a sad memory, your parental heart yearns for that boy, who has never been out of your mind for a single day; and you resolve to send a friend out after him.

In due time your messenger reaches the boy, and informs him that you desire his return with the messenger, that you may forgive, and restore him to family and friends. But suppose that boy should reply, No Sir! I'll not go with *you*; if Father wants to forgive me, he must come to me himself!

Whose fault would it be if that insolent and wicked son remained outside the family fold forever? Or whose fault would it be if a condemned criminal perished, who on being assured of a full pardon if he would but petition the Governor of his state, replied—No Sir! I'll ask pardon of no one but the highest official in the land—the President

himself! And, my friends, whose fault will it be if we likewise perish, if we persist in rejecting this natural, reasonable, and easy condition of our redemption?

But some one may truthfully say, I have always tried to do right—have been honest, industrious, peaceable and charitable; and I think my daily walk will compare favorably with that of a great many Christians with whom I am acquainted!

My friend! your course is certainly worthy of the highest praise; and I believe that somehow and somewhere in God's just providence, you will surely receive your reward. But how could a few years—ten, twenty, forty, or even eighty years of good conduct on your part, *purchase and pay for* millions and millions without end of years of eternal life and peace and rest and joy? Why! that would be a very unequal business transaction, would it not?

No, my friends! eternal life cannot be earned or purchased; but it is just what the Gospel declares it to be—the Free Gift of God, to every one that believeth.

If it were not so, what hope would the aged who had renounced their sins have of *earning* it, as compared with those who set out for the prize in the morning of life?

The Savior very clearly illustrates this in his parable of the laborers in the vineyard; in which you will recollect that those who began at the eleventh hour, were rewarded the same as those who had borne the burden and heat of the day.

And now, are we ready for the question: What is the first step—what must I do, or how must I begin, to attain to that belief which leads to life eternal?

My friends! I trust you will pardon me if I give you my own experience on this point of inquiry, because when I speak of that, I know whereof I affirm; and it cannot then be said of me, that I am dependent on the testimony of others:

When in my twentieth year, in possession of a fair education for my years, with some knowledge of the Bible, and with encouraging worldly prospects, I became impressed with a sense of my duty to God, and with a

desire to gain his pardon and favor. It was not in time of a revival, or of any special religious interest in the locality where I resided, so my frame of mind could not be attributed to excitement or urgent appeal; but in the calm and quiet of my own peaceful boyhood home, I confronted the great problem—"What must I do to be saved?"

I began with earnestly and attentively reading the New Testament; the readings being later accompanied by prayer—though always to the Father, without reference to the Son. Not that I denied Christ's personality nor his divine mission—No! I believed *of* the Savior and what was recorded of him, just as I believed of George Washington or Benjamin Franklin; and I honestly thought that really constituted all the belief in the Savior required.

Each day I grew more earnest in my devotions and scriptural readings, each day more sad and abstracted; for no light yet penetrated the overhanging darkness—all was heaviness and gloom. This continued for two or three weeks, till one Sabbath day

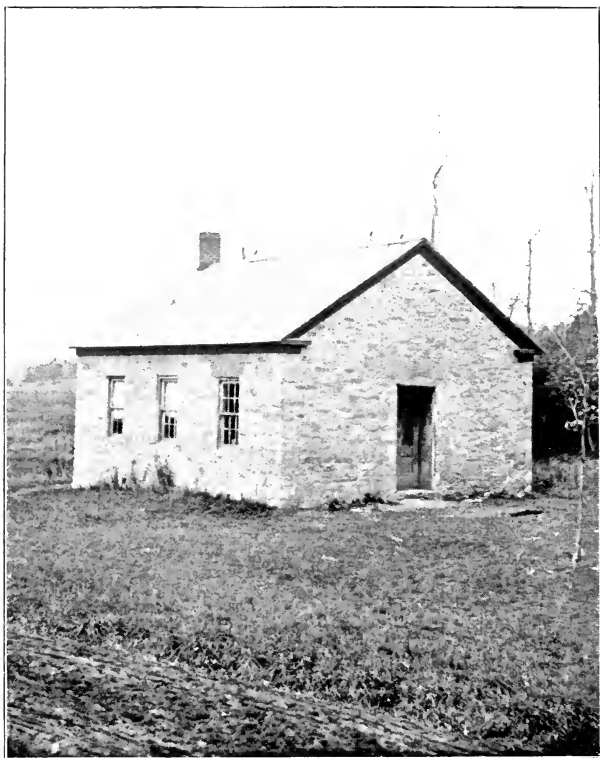

THE LITTLE DISTRICT SCHOOL-HOUSE.

I went to religious services in our little district school-house, up among the green hills of Central New York.

The officiating clergyman was not one of the high-cultured pulpit orators of the day; he indulged in no grand flights of eloquence nor fine figures of rhetoric—his sentences may not all have been grammatical; but he knew the “Old, Old Story!” He had sat at the feet of Jesus, and had learned of him! And as he earnestly portrayed Christ’s personality, divine mission, and present attitude, standing at the right hand of God, making intercession for us as our mediator, advocate, and Great High Priest, and that through him must our petitions to the Father be made,—as he pictured this, a new conception of Christ’s character and office dawned on me; and on reaching home I at once retired to my room, and on bended knee fervently prayed God, *for Christ’s sake*, to forgive my sins.

And then the glad light came—right then and there, just as the Savior told Nicodemus that it would come—“As the wind bloweth

where it listeth, and thou hearest the sound thereof, but canst not tell whence it cometh and whither it goeth, so is every one that is born of the Spirit." And in this age of free thought, liberal Christianity, and trying to get to Heaven by climbing up some other way, I wish to place myself on record as saying that Christian conversion, as defined in the New Testament, is a glorious *reality*, and if you would gain the high and beautiful Heaven, do not rest till you have experienced it, whether in the church, or out!

As I arose from prayer on that eventful Sabbath day, I knew just as well that I was forgiven, and had passed from darkness to light, as the glad prisoner knows that he is free, when with the Governor's pardon in his hand, he steps forth from his gloomy cell into God's free air and sunlight; but being of a somewhat retiring and bashful temperament, I reasoned to myself,—Now I have this "Pearl of great price," I can hide it in my bosom, and the world and my young associates need not know what God has done for me.—You see the work was not quite



OUR UNION CHURCH.

completed yet; but as I continued in prayer through the week, gradually that reserve gave way, and before the week was ended I was ready and willing and *anxious* to confess Christ before the world, though all the world should forsake me. And this I did on the following Sabbath in our union church, triumphantly and without fear, in the presence of a large congregation.

And in the days immediately following, I experienced a sense of calm security and restfulness and light-heartedness which I had never felt before. O, I could laugh then! The gloom was all dispelled, and the beautiful Heaven seemed just a little overhead; while the difficult passages of the Bible all seemed cleared up, and a consistency and a harmony ran through the whole, which the discord of sectarian strife and the teachings of the 'higher criticism' have never yet been able to disturb. And though I have since, at times, wandered far, far from the path in which I first set out, and have said and done many foolish and wicked things, yet thro' all these years God has not forsaken me,

and I truly feel that I am one more example of his patience and long-suffering with them that believe.

And now, my friends! will you accept the riches of God's grace on these liberal and easy terms? If you are timid and bashful, as I was, and have a dread of arising to express your determination in public, be not in the least discouraged; but in the retirement of your own homes carefully study the Scriptures—read attentively the words of promise and instruction uttered by our Savior, as found recorded in the first four books of the New Testament, and pray to your Heavenly Father! asking all things in the name of the Savior, who stands ready to intercede for you.

Be earnest and persevering, and the glorious light will surely come; and you will have courage and confidence then—you will not shrink from coming to the church or to the prayer-meeting and confessing Christ before men, as he reasonably requires; that he may also confess you before his Father in Heaven. And though worldly prosperity

may not directly follow, yet God will give you Christian fortitude to bear those ills of life which are common to all.

You will not dread to grow old then; but each trace of advancing years, each monitor of life's waning day, will be to you a mark of progress toward your Heavenly heritage; and if sorrow and affliction come, you will be sustained by the reflection that Christ said to his own beloved disciples, "For in the world ye shall have tribulation, but be of good cheer—I have overcome the world." *St. John, 16 : 33.* And that he also said, "He that shall endure unto the end, the same shall be saved!" *Matt. 24 : 13.*

O, Christian soldier and cross-bearer!—mid the tumult of daily life, the assaults of skepticism, the clash of creeds,—the fall of dynasties and the wreck of worlds!—keep your eye ever on this bright beacon-light,—“He that shall endure unto the end, the same shall be saved!”

And from what shall we be saved? From all further poverty and toil, sickness sorrow and death; for there shall be no more death

there! From the snubs and extortions and overreachings of the proud and selfish and avaricious, for they will not be there;—no more cold winter's storms nor sultry summer's heat, but one perpetual Spring-time of life and light, peace and plenty, health and rest and joy;—reunion with the dear ones, and communion with the truly good and great from every Age and Clime, in a *World without end*—FOREVER!

I had purposed ending here, but one more thought is suggested by attendant circumstances, which unexpressed, would leave my effort altogether incomplete:—My words have thus far been addressed more particularly to the mature, the middle-aged, and to those well advanced in life; but I see before me many of the young, the hopeful and the happy—those to whom life still seems, as it were, an unwritten poem, and the future a blissful dream.

Far be it from me to willingly say aught that would in the slightest measure detract from the innocent pleasures of Youth, but as the firm friend of, and sympathizer with

the young, I would commend to each of you, my young friends! those words of approved wisdom—"Remember now thy Creator, in the days of thy youth:", assuring you there is no worthy ambition but that a true Christian faith elevates and ennobles, no proper pleasure but that it purifies and enhances, no life but that it beautifies and blesses,—*no death* but that it may divest of its gloom, and transform the passage across the dark waters into a triumphal entry through the Gate Beautiful, to the Beautiful Beyond.

And while we have full assurance that God will in no wise reject the truly contrite heart, even though that heart contain but the dregs of a wasted and a misspent life, yet O! how like sweet incense must rise to the Throne of Grace the offering of one of these young and joyous hearts, to whom the world offers so much, yet willing to forsake all, if need be, for the higher, happier, and better Christ-life.

Then pardon me if I urge upon you the importance of attending to this matter while the heart is still tender and susceptible, and

ere the evil days come, when in bitterness and sorrow despondently you say, "I have no pleasure in them!" And that the God of grace and peace and love may be with you always, and bless your lives and guide your footsteps, and at last bring you into his Heavenly Rest, is the sincere prayer of your humble servant.

CHAPTER X.

RELIGIOUS FAITH.

As I have been disposed to examine and consider and decide for myself, in pursuing those sciences pertaining to the *material*, so I have held myself equally independent in studying and interpreting that Revelation which treats of things *spiritual*.

While believing implicitly in the truth and inspiration of the Bible, yet my understanding of some portions of it may differ quite materially from that of many people whose faith in the Old Book is nevertheless as perfect as mine could possibly be; and it was, until recently, my determination never to give my peculiar religious views to the public, lest they might tend to unsettle the faith of any who have accepted some worthy established creed.

But since coming in contact with the so-

called "higher criticism," the question has very forcibly presented itself to my mind, if the extreme views of the Orthodox faith respecting everlasting punishment etc., may not have incited this Bible revolt, which we are told numbers in its ranks so many who have been sealed and sanctified for its defense. Hence my decision to undertake an honest and unbiased discussion of those vital principles which give form to the Christian faith; admitting however, that I believe we may without prejudice differ in minor particulars, and that it may not have been the Divine plan to have all men interpret the Scriptures strictly alike.

If, for instance, the Bible had been written so plainly, and every proposition made so transparent that a single reading would satisfy, and convey the same impressions to every reader, men would soon have laid it aside, as being of no farther use to them, and it would long ago have become an obsolete and forgotten book. But it is wisely so constituted that each new reading discovers new and interesting truths; and while true

believers accept in common its fundamental precepts, they may yet differ sufficiently in the lesser matters of faith to maintain that friendly controversy which keeps it always before the people.

It is estimated that the active life of the average book is no more than ten years, and that but very few survive a century; yet to this divinely wise feature of their composition is perhaps due the survival of the Holy Scriptures through all the years of history, whose steady flight has witnessed the birth triumph and decay of the grandest works of art, literature and science; the rise and fall of empires,—while the glorious onward march of the Gospel of Peace has encircled the Globe.

Up to the time of my conversion to Christianity, my religious training had been purely Orthodox, and I had never for a moment questioned the correctness of its teachings respecting the absolute immortality of the soul—that for weal or woe the soul of man shall live on and on, through the countless ages of eternity. But with the new light

and interest gained from that conversion, I studied the Scriptures, not for the purpose of fortifying any preconceived opinions of my own, nor any accepted creed,—I sought for Truth! and the truth only.

And now, at the risk of being charged with heresy, I must confess that I found no words in the Old Testament or the New, declaring, or directly implying that the soul of man is *absolutely* immortal.

Though we find abundant promise that they who have accepted the Gospel conditions of man's redemption, and manifest the same in their daily walk, are heirs of Heaven and a blest immortality, yet all passages referring to future punishment, if properly analyzed, tend to show that the unrepentant wicked, *with a few exceptions*, shall finally die: "For the wages of sin is death."

This is also evinced in the words of our Savior—"For God so loved the world that he gave his only begotten Son, that whosoever believeth in him should not *perish*, but have everlasting life." *John, 3 : 16.* These words plainly imply that the unbelieving

shall perish: and we find that the definition of the word, perish, is to die, to decay; and not to live in torment.

But I am aware that the Bible contains several other passages which are commonly interpreted as being declarations of eternal punishment to the wicked. I will not undertake to review them all, but will take up a few of those which appear most positive and forcible in expression:

In the 9th chapter of Mark's Gospel we find several times repeated the often quoted words, "Where their worm dieth not, and the fire is not quenched!" which passage is by many supposed to imply that the fire and the condemned soul, both exist forever; the one always tormenting the other.

But if we analyze this sentence, we will see at once that the two words, worm and fire, are simply a repetition of terms, both meaning that which destroys; fire being referred to throughout the Bible, and at all times recognized as the great destructive element, and the term, worm, being used in the same scriptural sense. For example, in

the book of Joel, 2:25—"And I will restore to you the years that the locust hath eaten, the canker-worm and the caterpillar, and the palmer-worm, my great army which I have sent among you." And again in Job, 19:26—"And though after my skin, worms destroy this body, yet in my flesh shall I see God!"

The book of Revelation also contains some forcible expressions of this character; conspicuously among these being Rev. 14:11—"And the smoke of their torment ascendeth up for ever and ever: and they *have* no rest day nor night who worship the beast and his image, and whosoever receiveth the mark of his name."

This passage, strong and conclusive as it may at first appear, and is by many regarded, does not say that the unfortunate ones referred to *continue* in torment; it says that the *smoke* of their torment—of the firey medium of their destruction, ascends forever; and this for a reason considered later.

The latter clause of the passage quoted does however appear to imply a *continued*

unrest; but as the verb employed in it has the form of the present tense ('they *have* no rest, etc.')

and not of the future tense (they *shall* have no rest,) the language would appear to refer rather to this present state, as it is quite unlike the form of expression used in Rev. 20:10, which, in referring to an endless future, employs the verb, *Shall be!*

But lest this should not be conclusive, let us briefly examine two more passages which appear the strongest in their denunciation of sinners of anything found in the Bible. In Matt. 25:41, we find these words: "Then shall he also say unto them on the left hand, Depart from me ye cursed, into everlasting fire prepared for the Devil and his angels." Also in 2d. Thess. 1:9. "Who shall be punished with everlasting destruction, from the presence of the Lord, and from the glory of his power."

The first of these quotations, positive as it may sound, does not imply eternal torture to the accursed in general, unless the word *prepared* refers to *them*, as many carelessly construe it; but if we examine the passage

in connection with others in the Bible which have a reference to it, we will find that the word *prepared* refers to the fire, and not to the condemned, and it might properly read thus—Depart ye cursed into that fire *which is prepared* for the Devil and his angels.

This conclusion is sustained by the words of the second quotation, in which the everlasting fire is called “everlasting destruction;” and the lost souls who have a part in it must necessarily be destroyed; which, as repeatedly declared in the 20th. and 21st. chapt. of Rev. “Is the second death.”

The words of our Savior, as recorded in Matt. 10:28, also clearly imply that the soul of man is not *absolutely* immortal, and that Hell is the appointed place for the destruction of lost souls: the passage reads thus—“Fear not them that kill the body, but cannot kill the soul; but rather fear him who is able to destroy both soul and body in Hell.”

But why then is that place of destruction made everlasting, if after the final day of judgment, the condemned are destroyed? A few pages back, I referred to some excep-

tions apparently made, in which the second death brings no relief. Those exceptions are clearly indicated by the words found in Rev. 20:10—"And the Devil that deceived them was cast into the lake of fire and brimstone, where the beast and the false prophet are, and shall be tormented day and night, for ever and ever."

In Rev. 19:19,20,21, though a different figure of expression is used, yet it not only confirms the foregoing quotation, but plainly marks the distinction made between those arch offenders and the rank and file of sinners. It reads thus :

"And I saw the beast and the kings of the earth, and their armies gathered together to make war against Him that sat on the horse, and against His army.

"And the beast was taken, and with him the false prophet that wrought miracles before him, with which he deceived them that had received the mark of the beast, and them that worshiped his image. These both were cast *alive* into a lake of fire burning with brimstone.

“And the remnant were *slain* with the sword of Him that sat upon the horse, which sword proceeded out of His mouth; and all the fowls were filled with their flesh.”

AN INTERMEDIATE STATE.

That there is an intermediate state, in which the souls of mankind have either a conscious, or an unconscious existence, from the time of departing this earthly life, till the final resurrection, is clearly indicated by many passages of Scripture, while none seem to plainly refute it.

When the thief on the cross spake in the Savior's defense, and prayed for his remembrance when he should come into his kingdom, our Savior graciously replied, “to-day shalt thou be with me in *Paradise!*” *Luke 23 : 43.* But we read in the first chapter of the book of Acts, that it was forty days before Christ ascended to Heaven; therefore the Paradise he referred to could not have been the high Heaven wherein the Father and his holy angels dwell.

We also read in Acts, 2 : 34—“For David

is not ascended into the Heavens:" and in John, 3:13, Christ himself says, "And no man hath ascended up to Heaven, but he that came down from Heaven, even the Son of man which is in Heaven." And again in 1st. Cor. 15:20, St. Paul says, "But now is Christ risen from the dead, and become the *first fruits* of them that slept."

These passages, and several others of a like character, imply that up to the time of the Savior's advent no man had yet ascended to the high Heaven; and that until the final resurrection, which will be heralded by his second coming, none will so ascend, is manifested by the Savior's own words in Matthew, 16:27—"For the Son of man will come in the glory of his Father, with the angels; and *then* he shall reward every man according to his works."

Also in St. John, 5:28,29—"Marvel not at this, for the hour is coming, in the which all that are in their graves shall hear his voice, and shall come forth; they that have done good, unto the resurrection of life; and they that have done evil, unto the resurrec-

tion of damnation." (that is, shall be raised or resurrected to meet condemnatory judgment). Likewise in Thess. 4:16, Paul says, "For the Lord himself shall descend from Heaven with a shout, with the voice of the archangel, and with the trump of God; and the dead in Christ shall rise first."

As many ages have already passed since Christ's departure from this earth, and we know not how many more may ensue before his second coming, when all shall rise and appear before the judgment bar of God, a consideration of how that period of existence is employed by those who have departed this life, is a study of particular interest.

Many expressions throughout the Bible would lead us to infer that the departed may repose in that unconscious state called *sleep* till the resurrection morn, since that term is freely employed in the Scriptures to describe their changed existence. And while that may be true of the majority, yet the inspired teacher Paul, though appearing to hold this view, in part, as is shown by his words in 1st. Cor. 15:51, yet makes a most

decided exception. The passage reads thus : “Behold, I show you a mystery: we shall not *all* sleep, but we shall all be changed.” These words appear to imply plainly, that while many *will* sleep, yet others will not.

This exception is in perfect accord with the Savior’s words recorded in John, 11 : 26, which read, “And whosoever liveth and believeth in me, shall never die !”

I interpret this clause as meaning that they who believe in the Savior in this life, and manifest their faith by their works, will at once, on leaving the earthly sphere, enter into a conscious and blessed intermediate state; or in the language of the Savior, shall never die. This I believe to be the First Resurrection, spoken of in Revelation, 20 : 6, —“Blessed and holy is he that hath part in the first resurrection: on such, the second death hath no power.”

But does the exception apply only to the Lord’s redeemed? There is introduced into the 16th chap. of Luke’s Gospel a narrative from the Savior’s own lips, which appears emphasized by standing alone; apparently

having no connection with the preceding portion of the chapter; and whether given as a parable, or as a historic fact, men have been unable to decide. But as it came from the lips of One who never spake an idle word, and whose every expression was fraught with a purpose, we must conclude that it was given for our instruction.

In this narrative, the miserable and emaciated beggar, Lazarus, is represented as lying at the rich man's gate, and desiring to be fed with the crumbs which fell from his table: that in time the beggar died, and was carried by the angels into Abraham's bosom.

The rich man also died, and was buried; and in Hell he lifted up his eyes, being in torment; and seeing Abraham afar off and Lazarus in his bosom, he implored Father Abraham to send Lazarus to relieve him in his torment.

But Abraham replied, "Son! remember that thou in thy lifetime receivedst thy good things, and likewise Lazarus evil things; but now he is comforted, and thou art tor-

mented. And besides all this, between us and you there is a great gulf fixed, so that they who would pass from hence to you, cannot; neither can they pass to us that would come from thence."

The inference drawn from this picture is that, aside from the conditions already considered in the intermediate state, it may also be the place where the wrongs of this world are in a measure righted; and that they who have known extreme poverty and suffering here, as well as they who, by inflicting such suffering on others, have been enabled to fare sumptuously, shall each of them receive his proper reward; while the two, in their changed conditions, are separated by a gulf more exclusive and impassable than the social barrier which separates them here.

This inference finds further support in the words of our Savior, as recorded in the 6th chap. of St. Luke, the 21st verse reading thus: "Blessed are ye that hunger now; for ye shall be filled. Blessed are ye that weep now; for ye shall laugh." The 24th verse also reading—"But woe unto you that are

rich! for ye have received your consolation.”

Several passages of Scripture however confirm my belief that the latter quotation refers only to those rich people who lead selfish and ungodly lives, and not to the noble few who are faithful stewards of God's bounty.

IMMORTALITY.

Of the second, and final death of the unbelieving, after the general resurrection and great judgment day, and the everlasting punishment of Satan and the false prophets that deceived the people, enough has already been said, I trust, to make plain my opinion on those important questions.

But when I come to write of the unspeakable glory and happiness of the eternal life awaiting those who will be found worthy to enter the pearly gates of the New Jerusalem, I feel that pen and brain are inadequate to discuss the glowing descriptions of the inspired writers. And I can only conceive that it will be the complete gratifying and satisfying of that constant longing for some-

thing better and higher and nobler, which is an inseparable part of the normal earthly life: and the thought that it will be *forever* should render light and insignificant all the sacrifice to gain it which we are called upon to make in this life, whose duration, as compared with eternity, is as a single drop to the great Ocean.

In conclusion then, I most reverently commend to every unbeliever the words of promise and hope uttered by our Savior, "He that believeth in me hath everlasting life.", and to every believer, his words of comfort and encouragement, "He that shall endure unto the end, the same *shall be saved!*"

From the foregoing discussion of religious faith, I deduce the following, which is—

MY ACCEPTED CREED.

I believe in God the Father, Creator of Heaven and Earth; in Christ the Savior, in his divine origin, and in his power and willingness to forgive and save all who diligently seek him: also in the Holy Spirit,

which the Lord sendeth to those whom he receiveth.

I believe in an intermediate state wherein all souls wait, either unconsciously, or in some degree of happiness or unhappiness, the General Resurrection: that in the great Judgment Day the conscious existence of unbelievers will finally end, which is the Second Death: but that Satan and the false prophets will live under God's displeasure forever.

I believe that they whose names are found written in the Book of Life will then be received into a blest Immortality, and a home in the Beautiful Heaven wherein the Father dwells; there to live in peace and happiness forever.

APOLOGIES.

In the earlier pages of this volume I spoke of my failure in gaining recognition from the publishers, and in consequence the query will arise as to how I finally got into print.

If the volume were a better production of the book-maker's art, that query would remain unanswered by me. But as it is, I feel that I owe not only an explanation, but an apology to the reader, as well, for the imperfections apparent to the critical eye.

Lacking the necessary means, and being persistently denied the opportunity to earn means sufficient to get my work published, I finally resolved to turn printer myself; and securing a small \$18. press and three fonts of type, I began without any instruction, or previous knowledge of the printer's trade.

Though by continued effort I in time acquired a degree of skill at the case and the press, yet owing to my inexperience and my vision being a little impaired by too close application, I find on review that some faults exist—that besides imperfect press work, there are errors typographical, and perhaps grammatical and orthographical, as well as errors of taste and judgment in arranging matter; and for all these I most humbly and sincerely apologize.

But for the sentiments expressed, I have no apology to offer. They have been carefully weighed and considered, and are the result of years of observation, study, and investigation, founded on an unmistakable Christian conversion, and I am willing to be judged by them.

Though the signs of the times, and the history of past efforts in the cause of Truth tell me that I shall hardly hear the grateful “Well done” in this world for the effort I have made, and though I have no great and buoyant hope of hearing it in the world to come, yet I shall live hoping, and die hoping



MY PRINTING HOUSE.

that when the greater works of men are being reviewed, and Heaven's arches ring with the glad praises of those who have been more liberally endowed and favorably circumstanced, then He in whom I have believed, and whose cause of Truth I have tried to serve, will offer this apology for me:—"He hath done what he could."

THE END.

Pravica, Theological Seminary, Springfield, Library



1 1012 01007 6216