

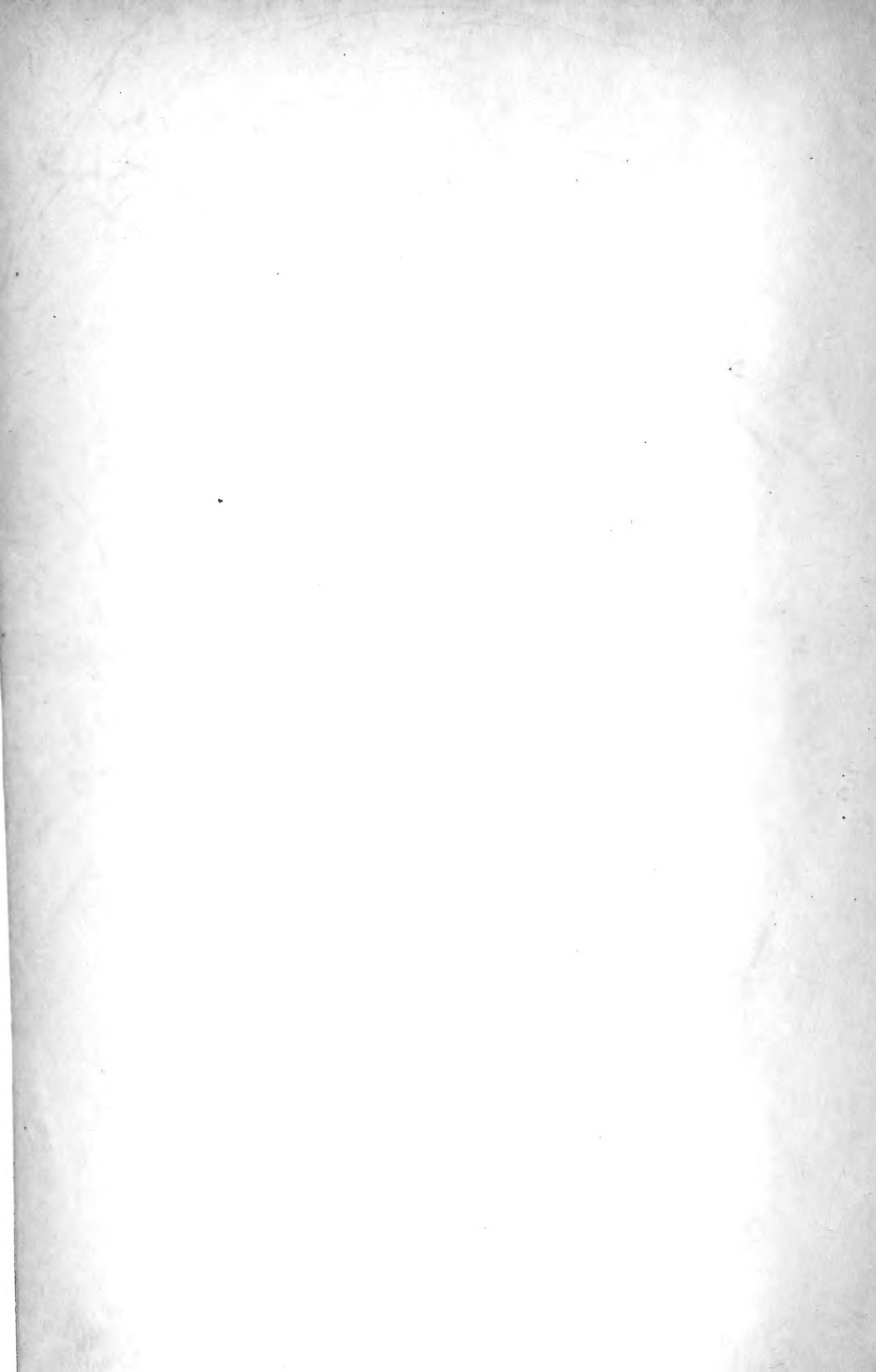

Digitized by the Internet Archive
in 2009 with funding from
Ontario Council of University Libraries





THE
BIO-CHEMICAL JOURNAL

EDITED BY

BENJAMIN MOORE, M.A., D.Sc., F.R.S.

AND

EDWARD WHITLEY, M.A.

VOLUME VI

1912

122846
3/5/13.

COPYRIGHT

BIO-CHEMICAL DEPARTMENT, JOHNSTON LABORATORIES
UNIVERSITY OF LIVERPOOL

QP
501
B47
v. 6
cop. 4

CONTENTS OF VOLUME VI

	PAGE
The Carbohydrates of the foliage Leaf of the Snowdrop (<i>Galanthus nivalis</i> , L.), and their bearing on the first Sugar of Photosynthesis. By John Parkin, M.A., F.L.S.	1
On Deamidization. By Gertrude D. Bostock, B.Sc., M.B., Ch.B., Carnegie Scholar	48
Note on the Estimation of Potassium in Urine. By H. H. Green, B.Sc.	69
On the Freezing Point of the Unhaemolysed Corpuscles during Haemolysis of Blood, and on the effects of Evaporation on the Resistance of Erythrocytes to Haemolysis. By U. N. Brahmachari, M.A., M.D., Ph.D.	76
A Contribution to the Study of the Protein Metabolism of the Foetus. The Distribution of Nitrogen in the Maternal Urine and in the Foetal Fluids throughout Pregnancy. By Dorothy E. Lindsay, B.Sc., Carnegie Scholar	79
A Preliminary Study of the Bio-Chemical Relations of Various Lipoid Substances in the Liver. By Frederick P. Wilson, M.Sc., M.D., Beit Memorial Research Fellow	100
The Action of Selenium Salts on the Red Blood Corpuscles. By Charles O. Jones, M.D., M.Sc., M.R.C.S.	106
Direct Measurement of the Osmotic Pressure of Casein in Alkaline Solution. Experimental Proof that apparent impermeability of a Membrane to Ions is not due to the Properties of the Membrane but to the Colloid contained within the Membrane. By Benjamin Moore, Herbert E. Roaf and T. Arthur Webster, University of Liverpool	110
The Sodium Phosphate Standards of Acidity. By E. B. R. Prideaux	122
Note on the Synonymy and Histological Characters of East London Boxwood (<i>Gonioma Kamassi</i> , E. Mey.). By R. J. Harvey Gibson, M.A., F.L.S., Professor of Botany in the University of Liverpool	127
Cryoscopic Determinations of the Osmotic Pressure of the Blood and Body Fluids of some Australian Animals. By Judah Leon Jonah, D.Sc., M.B., B.S.	130
On the Influence Exercised by certain Acids on the Inversion of Saccharose by Sucrease. By Frederick Stoward, D.Sc.	131
The Physiological Action of Indolethylamine. By P. P. Laidlaw	141
The Effects of Caffeine upon the Germination and Growth of Seeds. By Fred Ransom, M.D., Beit Research Fellow	151
The Effects of Caffeine upon the Germination and Growth of Seeds. (Second communication). By Fred Ransome, M.D., Beit Research Fellow	156
Cell Stimulation by means of Prolonged Ingestion of Alkaline Salts. By The Jessup Committee	162
The Proteins of Rice. By S. Kajiura	171
Some Further Experiments on the Physiology of the Allyl Compounds. By E. Wace Carlier, M.D., F.R.S.E.	182
The Influence of Protoplasmic Poisons on 'Reductase.' By D. Fraser Harris, M.D., D.Sc., Professor of Physiology and Histology in the Dalhousie University, Halifax, N.S.	200
Note on Hydrolysis of Vegetable Oils by Emulsion of <i>Ricinus Communis</i> . By David Sommerville, B.A., M.D., M.R.C.P., Lecturer in Public Health, King's College, University of London	203
A Clinical Method of Estimating the Amount of Calcium in the Urine, and other Physiological Fluids. By W. Blair Bell, B.S., M.D. (Lond.), Assistant Gynaecological Surgeon, Royal Infirmary, Liverpool	205
Observations on the Secretion and Composition of Human Bile. By J. A. Menzies, M.D., Edinburgh	210
Notes on some New Substitutes for the Galenical Preparations of Digitalis. By Douglas Cow, M.D.	219
The Anti-neuritic Bases of Vegetable Origin in Relationship to Beri-Beri, with a Method of Isolation of Torulin the Anti-Neuritic base of Yeast. By E. S. Edie, W. H. Evans, B. Moore, G. C. E. Simpson and T. A. Webster	234
The Creatin Content of Muscle in Malignant Disease and other Pathological Conditions. By R. A. Chisolm, M.A., D.M., M.R.C.P., Greville Research Student	243
On the Nature of Animal Lactase. By Marjory Stephenson	250

CONTENTS

	PAGE
The Nutrition and Metabolism of Marine Animals in Relationship to (a) Dissolved Organic Matter and (b) Particulate Organic Matter of Sea-Water. By Benjamin Moore, M.A., D.Sc., F.R.S., Edward S. Edie, M.A., Edward Whitley, M.A., and W. J. Dakin, D.Sc.	255
The Effects of Atmospheres enriched with Oxygen upon Living Organisms, (a) Effects upon Micro-Organisms, (b) Effects upon Mammals experimentally inoculated with Tuberculosis, (c) Effects upon the Lungs of Animals, or Oxygen Pneumonia. By Alfred Adams, M.B., Ch.B. (Liverpool)	297
Observations on Electro-Osmosis. By J. O. Wakelin Barratt and A. B. Harris	315
The Phosphatides of the Kidney. By Hugh MacLean	333
On the Purification of Phosphatides. By Hugh MacLean	355
On the Relations of Phenol and Meta-Cresol to Proteins. A Contribution to our knowledge of the Mechanism of Disinfection. By E. A. Cooper, B.Sc., Beit Memorial Fellow, Lister Institute of Preventive Medicine	362
The Distribution of Nitrogen in Autolysis, with special reference to Deamination. By Gertrude D. Bostock, B.Sc., M.B., Ch.B., Carnegie Scholar	388
The Effects of Purine derivatives and other Organic Compounds on Growth and Cell-Division in Plants. By N. G. S. Coppin, M.Sc.	416
On Glycolysis in Blood. By G. Spencer Melvin, M.D.	422
The Reduction of Ferric Chloride by Surviving Organs. By David Frazer Harris, M.D., D.Sc., and Henry Jermain Maude Creighton, M.A., M.Sc., D.Sc.	429
The Action of Opium Alkaloids. By F. W. Watkyn-Thomas, B.A., Trinity College	433
The Detection of Aceto-Acetic Acid by Sodium Nitroprusside and Ammonia. By Victor John Harding and Robert Fulford Ruttan	445
The Fatty Acids of Butter. By Ida Smedley, Beit Memorial Research Fellow	451

THE CARBOHYDRATES OF THE FOLIAGE LEAF OF THE SNOWDROP (*GALANTHUS NIVALIS*, L.), AND THEIR BEARING ON THE FIRST SUGAR OF PHOTOSYNTHESIS¹

By JOHN PARKIN, M.A., F.L.S., *Trinity College, Cambridge.*

(Received May 30th, 1911)

CONTENTS

Introduction	1
Analytical Procedure	4
Experiments and Results	22
Summary of Results	39
General Discussion	40

INTRODUCTION

Since the publication of Brown and Morris's important memoir entitled 'A Contribution to the Chemistry and Physiology of Foliage Leaves',² no extensive researches by chemical methods have apparently been carried out on the carbohydrates, which arise in the green leaf as the result of photosynthesis. With the exception of the fairly recent work of Strakosch,³ which will receive attention later, little has been done either in the way of confirming or refuting the results obtained and the conclusions drawn by Brown and Morris from their study of the sugars of the foliage leaf.

The investigations about to be described were commenced with the primary purpose of testing Brown and Morris's novel view, namely, that cane sugar is the first carbohydrate to be synthesised in carbon-assimilation.

The plant used for their experiments was *Tropaeolum majus*, the common nasturtium of our gardens. It forms starch plentifully in its leaves. The carbohydrates they recognised and attempted to estimate quantitatively were five in number, viz.:—glucose (dextrose), fructose (levulose), sucrose (cane sugar), maltose, and starch. From analyses made of leaves picked at various times of the day and under diverse

1. A brief account of this work, as far as it had then progressed, was given before the Botanical Section of the British Association, Dublin Meeting, 1908. (See, for abstract, the Annual Report for that year, p. 907).

2. Brown and Morris, *Journ. Chemical Soc.*, LXIII, p. 604, 1893.

3. Strakosch, 'Sitz. K. Akad. d. Wissen., Wien,' *Math.-Nat. Cl.*, CXVI Bd., II. VI, Ab. I, p. 855, 1907.

conditions, they came to the somewhat unexpected conclusion that sucrose is the first of the five carbohydrates to appear in photosynthesis. The others they derive from it as follows:—The starch arises directly from the cane sugar. They consider that when the latter exceeds a certain concentration, the excess is condensed to starch, thus relieving the osmotic pressure of the cell-sap. The glucose and fructose come also directly from part of the sucrose through inversion. The maltose proceeds from the starch through the dissolution of the latter by the action of the leaf-diastase. Further, finding that in their analyses the fructose was invariably in greater quantity than the glucose, they put forward the view that the latter is more readily consumed in respiration.

In the discussion,¹ which followed the reading of this paper before the Chemical Society, the President of the year, Professor H. E. Armstrong, suggested in his comments the likelihood of the cane sugar arising directly from the maltose, thus opposing the view of its being the first carbohydrate of photosynthesis. Such a criticism appeared then justifiable, especially since Brown and Morris themselves had shown three years earlier² that the barley embryo is capable of changing maltose into sucrose.

From the time of Sachs several plants, chiefly Monocotyledons, have been known, which never under natural conditions form starch in their green tissue (mesophyll). The idea struck the writer that such a type of leaf would be a profitable one upon which to experiment on the lines of Brown and Morris's work. Without starch, maltose would most likely be absent from such a leaf; consequently any sucrose found to be present could not have this sugar for its origin. The analysis would also be simplified, as in all probability there would only be three instead of four sugars for estimation, viz.:—sucrose, glucose and fructose.

The Snowdrop (*Galanthus nivalis*) was chosen, partly as a pleasanter subject with which to work than the Onion (*Allium cepa*), the best known of the non-starch forming Monocotyledons, and partly because some years previously³ the writer had made an extensive microchemical study of the distribution of starch and inulin in this plant. In no case was starch ever to be recognised in the mesophyll of the leaf, nor could it be induced

1. Brown and Morris, *loc. cit.*, p. 677.

2. Brown and Morris, 'Researches on the Germination of some of the Gramineae,' *Journ. Chemical Soc.*, LVII, pp. 513-520, 1890.

3. Parkin, 'Contributions to our knowledge of the Formation, Storage and Depletion of Carbohydrates in Monocotyledons,' *Phil. Trans. Roy. Soc., London, Ser. B.*, Vol. CXCI, pp. 40, 49, 53, 58, 61 and 66, 1899.

to form here by feeding with sugar solutions. My trials on this point did not meet with the success obtained apparently by Boehm,¹ who mentions the Snowdrop, among others, as capable of producing starch in its mesophyll, when the leaf is supplied with sugar solution.

Starch, however, occurs in the guard cells of the stomata, but the quantity is too small to be taken into account in chemical analysis. The bulb contains starch and inulin in abundance, but neither of these carbohydrates ever appears, in the author's experience, under natural conditions in the mesophyll of the leaf.

Thus by using a plant like the Snowdrop, the investigation of the carbohydrates of the foliage leaf becomes simplified. There are no products of starch dissolution to complicate the issue. The sugars found to be present, viz. :—sucrose, glucose and fructose, must in all probability be closely connected with the photosynthetic process. The main problem seems to centre round the origin of the cane sugar in the leaf. Does its formation precede that of the hexoses, or is the opposite the case? The results set forth in this paper favour the former idea, viz., that sucrose is the first sugar to appear in quantity in a free state in photosynthesis, and that the two hexoses, glucose and fructose, arise from it by inversion.

This research has been in progress for the last five or six years. As the leaf material can only be collected at one period of the year, chiefly in the months of March and April, the work has necessarily been somewhat protracted. The results obtained from the leaves collected one spring naturally suggest the work to be carried out when more material is at hand. This, however, cannot be obtained till the following spring, as the Snowdrop is not a plant which can be induced to produce leaves at any time of the year; and even if it could, it might not be advisable to use leaves grown under artificial conditions.

Though the author is fully aware that this investigation is by no means complete, other lines, both for purposes of verification and attack, suggesting themselves, yet the research appears to have progressed sufficiently far under present methods to warrant publication, and invite criticism. Further repetition on the same lines seems hardly necessary. Then again, opportunities for this class of practical work may cease in the near future, so that it is well to publish the results and draw the conclusions, while the experimental details are fresh in the memory.

Even though the results may be proved wrong in some respects, or

1. Boehm, 'Ueber Stärkebildung aus Zucker,' *Bot. Zeit.*, XLI, p. 49, 1883.

the interpretation put upon them unacceptable, yet I shall feel repaid if they arouse interest in this somewhat neglected branch of physiological botany.

Throughout the practical work I have had the valued and cheerful assistance of my friend Lieut.-Col. Dixon, M.A., Trinity College, Cambridge, to whom I wish to express my best thanks. As far as the experimental part of this research goes, our names might well appear jointly in the title, but he has not seen his way to consent to this, as he considers himself not competent to judge of the botanical aspect of this investigation, and thus could not hold himself responsible for the conclusions drawn or views expressed.

My thanks are also specially due to Mr. J. H. Millar, B.Sc., F.I.C., for much helpful correspondence in regard to methods for sugar estimations, particularly respecting those requiring the use of yeasts.

To Professor T. B. Wood, we are much indebted for kindly allowing us the use of the saccharimeter belonging to his department, the Cambridge School of Agriculture.

The analytical work has been carried out wholly in the Chemical Laboratory of the University of Cambridge, and we desire to express our thanks to the former and present Professors of this Department for the privilege of working there, and for the opportunity it afforded us of employing liquid air in some of our experiments.

ANALYTICAL PROCEDURE

It will be necessary to deal at considerable length with the details of the general method which has been followed in this investigation for the estimation of the sugars in the Snowdrop leaf. This branch of physiological chemistry is as yet in the tentative stage. Every step requires close study and checking, in order that some degree of accuracy may be attained. No great advance, except with respect to the introduction of discriminating yeasts, has been made since the publication of Brown and Morris's work.¹ The method they used, in the light of work since carried out on pure sugar mixtures, is open to some objections. Being aware of these sources of error we have endeavoured either to overcome them or to allow for them, hoping that this research may thereby gain in reliability, though we are quite prepared for the possibility of further sources of error being brought to light in the quantitative estimations of sugars in plant extracts.

1. *Loc. cit.*, p. 663, 1893.

Analytical work of this nature is at the best slow. Our object has been to dispense with operations which we deemed to be unnecessary refinements with respect to the degree of accuracy at present obtainable in this line of investigation. At the same time our main purpose has been to carry out the analyses of the leaf extracts as uniformly as possible, so that the relative value of the results may be as great as possible.

In a research of this kind a large number of analyses with a moderate degree of accuracy seems preferable to a few with many precautions. In the latter case, on account of the small number of experiments, the effort to eliminate small errors may allow large ones to be passed over unobserved, whereas in the former, though slight variations may continually be arising, yet, owing to the number of analyses, large errors can hardly escape detection. Our conclusions are drawn from wide differences in sugar contents. Small fluctuations do not affect the generalisations. Differences in grams of sugar, and not fractions of a gram, per 100 grams of dry leaf, form our basis for drawing conclusions.

Drying the Leaves. This research has been conducted in the main with air-dried material. The leaves were desiccated quickly at a temperature sufficiently low to prevent browning or discoloration. They were then reduced to a powder for extraction.

In the process of drying, changes may take place in the sugars present in the leaf, altering their relative proportions. The cane sugar, for example, may undergo some inversion either through enzymic action or the acidity of the cell-sap. The effect, if appreciable, will be to increase the reducing sugars at the expense of the sucrose. This possibility has been put to the test in the following way.

Experiments with Liquid Air. A batch of fresh leaves was divided into two equal portions by weight. From one part the sugars were extracted at once, and from the other after drying. In order to reduce fresh leaves to a pulp for extraction, and at the same time to prevent any enzymic action taking place, recourse was had to liquid air. The leaves were immersed in this reagent, then withdrawn, and while frozen and brittle, were quickly ground up and the whole mass at once thrown into hot water to kill the enzymes, a few drops of ammonia being added to neutralise any acidity which might have an invertive action. The sugars so extracted were in much the same proportions, as in the control extracts made from the dried leaves.

The above fears then appear somewhat groundless. The air-dried

material may be assumed to retain the sugars in somewhat the same proportions as in the fresh leaf.

Details of two such comparative analyses are given below. The leaves were picked at two different periods of the spring—for the first experiment on March 11th, and for the second on April 30th. The amounts of the sugars are calculated for 100 grams of dry leaf.

	Fresh leaf. (Ground up by means of liquid air)		Dried leaf. Control	
	Experiment I	Experiment II	Experiment I	Experiment II
	Sucrose	12·84	10·46	12·74
Hexoses (reducing sugars)	5·94	12·87	5·67	12·38
Total sugar	18·78	23·33	18·41	22·8
Ratio of sucrose to hexose...	1 : 0·46	1 : 1·23	1 : 0·44	1 : 1·19

In both cases, instead of the proportion of hexose to sucrose being greater in the air-dried (control) material than in the freshly extracted leaf, it is slightly less.

The drying, then, has not resulted in any appreciable inversion of the cane sugar.

It is to be noticed, also, that the total sugar extracted from the fresh leaves in both instances is rather greater than from the dried leaves. That is to say, the extraction is most likely more complete from the fresh pulp; the relative proportions of the two classes of sugars, however, remain very nearly the same.

For each separate analysis five grams of the leaf powder were taken, corresponding to about 150 fresh Snowdrop leaves.¹ As the analyses were carried out in duplicate, double this number of leaves were required. For a comparative experiment, such, for example, as the comparison of early morning with late afternoon leaves, fully 600 were needed; and to allow for a margin of safety and the possibility of having to repeat one or more of the analyses, 1,000 leaves are not too many.

Thus a research of this kind entails the growing of a considerable area of the plants and the manipulation of a large bulk of fresh material.

For the most part the Snowdrops were grown, and the leaves collected and dried at my home near Carlisle, in Cumberland. Through the kind-

1. The number required not only varies with individual differences in the size—a minor matter—but also with the season, as the leaves continue to grow throughout the spring by basal growth. Fewer would be required, e.g., late in April than at the beginning of March to make up 5 grams of dry material.

ness of Mr. Lynch, the Curator, a plot of Snowdrops was grown in the Cambridge Botanic Gardens for my use; but the bulbs do not seem to grow so well there, so I had to rely chiefly on my Cumberland stock. Colonel Dixon also collected and dried leaves for me at St. Bees, which came in useful for preliminary and general purposes.

The Snowdrop leaf-powder is hygroscopic, like all organic air-dried material. In order to obtain absolute dryness in a hygroscopic substance, recourse must be had to desiccation in an atmosphere devoid of moisture. This research hardly warrants the employment of this refinement, but in order to have the powdered leaf samples of approximately the same degree of dryness, exactly half a gram of each sample at the time it was being used for analysis was taken and placed in a steam oven for six hours, cooled in a desiccator, and then weighed. The equivalent of the loss of weight (10-20 milligrams) suffered by the half gram is then to be deducted from the amount of air-dried leaf powder taken for extraction. Experiments on this point showed that after six hours' heating in the steam oven, most of the moisture had left the half gram of leaf powder, i.e., the loss of weight on further heating was very small.

In future work of this kind the above operation might perhaps be dispensed with, especially if the powdered leaf sample be kept for some time in a desiccator before being weighed for extraction.

Extraction. Moderately strong alcohol is commonly used for dissolving out sugars from dried and ground up plant tissues. Brown and Morris¹ in their investigation of the sugars of *Tropaeolum* leaves employed 80-85 per cent. alcohol.

The use of spirit for dissolving out the sugars necessitates the extraction of the leaf-powder previously with ether or some such solvent to remove the chlorophyll. Then further, after obtaining the alcoholic extract, the spirit has to be distilled off, in order to obtain the sugars in aqueous solution for analysis. Hence this mode of sugar extraction is somewhat tedious.

As no starch occurs in the Snowdrop leaf, the feasibility of directly dissolving out the sugars from the leaf-powders by distilled water presented itself. Both cold and hot water were tried, and the former method was finally adopted as the solvent. Thus the necessity of removing the chlorophyll was dispensed with, as this is insoluble in water, and hence the time taken over the extraction was considerably shortened.

1. Brown and Morris, p. 662, 1893.

The method of procedure was as follows:—The five grams of powdered leaf taken were well shaken and allowed to soak some time in a flask with 50 c.c. of distilled water. The extract was then filtered into a 100 c.c. flask. The residue was afterwards washed into the original vessel, well shaken and again filtered into the 100 c.c. flask. This operation was repeated twice more, but these filtrates were first concentrated down on the water bath before being added to the measured flask, otherwise the volume of the aqueous extract would have greatly exceeded 100 c.c. Thus the sample of leaf-powder taken was extracted four times with cold water, and by this means most of the sugar was obtained in solution. The aqueous extract thus procured is rich brown in colour, too deep for reading in the polarimeter; and so to remove the pigment, as well as any tannin or glucoside present, basic lead acetate solution had to be added. Five cubic centimetres of this reagent were always used. Upon filtering, a clear faintly yellow extract was obtained, containing the sugars.

The removal of the sugars by means of a water Soxhlet apparatus was tried, but abandoned in favour of cold water extraction, as less sugar was dissolved out by the former method, and some of the sucrose appeared to have undergone inversion, even though precautions were taken to neutralise any acidity. The Soxhlet extraction was continued for 8-9 hours. Below are the results of two comparative experiments on different leaf samples.

Mode of extraction			Sucrose	Hexoses	Total sugar in 100 grams dry leaf	Ratio of sucrose to hexoses
I.	Cold water	9.29	16.35	25.64	1 : 1.8
	Water Soxhlet...	7.08	17.86	24.94	1 : 2.5
II.	Cold Water	6.17	13.72	19.89	1 : 2.2
	Water Soxhlet...	5.04	14.32	19.36	1 : 2.8

Not only has the Soxhlet water extraction been less complete than the cold water one, but also the sucrose is considerably less in amount, with a corresponding increase in the reducing sugars; thus this somewhat drastic method of extraction is to be avoided, as it conduces to sucrose inversion.

To what extent are the sugars removed by the cold water method of extraction? This point has been submitted to investigation. Though the removal of the total sugar is not quite completed by the four successive extractions, as judged by the amount of cupric reduction, yet for the purpose of this research it may be deemed near enough. The continua-

tion of the extraction beyond the fourth time would result in a little more sugar and also greater accuracy, but an inconvenient volume of liquid for concentration would be obtained, and the whole operation would be difficult to carry out in a single day.

Details of two estimations on different leaf samples are given below, showing separately in each successive extraction, after inversion, the total amount of copper reduced.

		Copper in grams.				Copper in grams.	
		I	II			I	II
1st extraction	...	0.9815	0.7105	5th extraction	...	0.0333	0.0342
2nd	..	0.7035	0.5915	6th	..	0.0180	0.0112
3rd	..	0.2800	0.2425	7th	..	0.0034	0.0014
4th	..	0.1053	0.097	8th	..	0.0014	0.0007
Total for the first		-----	-----	Total for the second four		-----	-----
four extractions		2.0703	1.6415	extractions		0.0561	0.0475
		-----	-----			-----	-----

Thus the first two extractions remove two-thirds to three-quarters of the total sugar. After the fourth extraction only about one-fortieth of the sugar originally present remains in the residue, viz.: the amount corresponding to about 0.05 grams of copper, i.e., roughly speaking, 0.025 grams of hexose sugar. Hence we may consider that in the cold water method of extraction adopted, about this amount of sugar is left in the residue of the original 5 grams of leaf taken. For 100 grams this will be equivalent to 0.5 gram of sugar, and so to be nearer the absolute percentage of total sugars in 100 grams of dry leaf, about half a gram should perhaps be added to the figures given in this paper.

Does any of the cane sugar undergo inversion during the cold water extraction? As the leaf material was dried finally in a steam oven, it might be expected that the enzymes present would all be destroyed and that none of the sucrose would be inverted during extraction with cold water, provided micro-organisms were prevented from growing. This, however, we have found by experiment to be hardly the case. An extract made with cold water when compared with a control carried out with boiling water shows a slightly lower percentage of sucrose and a correspondingly higher one of hexose. The longer the cold water extraction takes, the greater the difference becomes. The following are some of the results obtained on this point:—

COLD AND HOT WATER EXTRACTIONS COMPARED

Experiment	Sucrose	Hexose	Total sugar	Sucrose difference
I. Cold	9.25	10.97	20.22	0.52
Hot	9.77	10.45		
II. Cold	15.72	9.04	24.76	0.35
Hot	15.37	9.39		

COMPARISON OF USUAL COLD WATER EXTRACTION WITH ONES LEFT LONGER

Experiment	Sucrose	Hexose	Total sugar	Sucrose difference
I. Usual	14.79	5.35	20.14	0.97
Allowed to soak extra 24 hours ...	13.82	6.32		
II. Usual	15.30	10.68	25.98	1.12
Extra 24 hours	14.18	11.80		
III. Usual	4.53	9.45	13.98	0.84
Extra 24 hours	3.69	10.29		
IV. Usual	8.43	9.53	17.96	2.72 or
Extra 3 days	5.71	12.25		0.9 per 24 hrs.

The amount of inversion which has taken place through prolonged soaking comes out very similarly in the above four experiments, viz., about 0.9 grams for twenty-four hours.

The diminution in the sucrose and corresponding increase in the hexoses was equally observable whether the extraction was made with or without the addition of an antiseptic, it seems, therefore, due to surviving invertase in the dried leaf material. It is a recognised fact that enzymes in a dry state can resist a higher temperature than when moist.

To prevent the above error arising, the obvious course would have been the substitution of hot water extraction for cold, thus destroying any active enzyme present. There is, unfortunately, a drawback to this procedure. Once the leaf material is treated with hot water, then the decoction ceases to filter easily, and the whole extraction becomes difficult and tedious. The cold water method has, therefore, been adhered to, though aware of the error arising through the inversion of a little of the sucrose, which amounts approximately to 0.5 gram per 100 grams of dry leaf. In the leaf analysis given, the cane sugar should be, therefore, increased by about half a gram and the hexoses correspondingly diminished.

The effect of basic lead acetate. The cold water extract, though clear, is of too deep a colour for its angle of rotation to be read in the polarimeter, consequently a decolourising agent has to be employed. Both animal charcoal and basic lead acetate remove the colour. The latter has been generally used in our analyses, but experiments for comparison have also been made with the former. Basic lead acetate has the advantage over animal charcoal of removing tannin and allied matters which reduce Fehling's solution. Now basic lead acetate is a somewhat disturbing factor to introduce into a sugar mixture, but unfortunately it can hardly be dispensed with, as no adequate substitute could be found. A number of experiments have been made to test its influence on the sugar estimations, and to find out the possible errors it introduces.

As already pointed out, 5 c.c. of the standard basic lead acetate solution has, as a rule, been added to each aqueous extract made from the five grams of leaf, the whole volume being then accurately made up to 100 c.c. By a series of tests it has been found that this quantity of the reagent just suffices to remove all matter from the extract capable of being precipitated by basic lead acetate. A further addition of the lead solution causes no more precipitate to come down.

The extract is then filtered to remove the lead precipitate, and its angle of rotation at once read in the polarimeter, and its cupric reducing power estimated, without going to the trouble of removing any excess of lead that may remain in solution. The removal of the lead by sulphuretted hydrogen is a somewhat lengthy process, and the presence of this slight amount has no appreciable effect on the rotation or the cupric reduction, as the experiments described below will show.

Now it is well known that basic lead acetate affects the rotation of fructose, forming a compound with it, which has a less rotation than this sugar itself.

We have ascertained the effect on the rotation and cupric reduction of adding 5 c.c. of our standard basic lead acetate solution to one per cent. solutions of the three sugars—sucrose, glucose and fructose, respectively. The only immediate appreciable effect is a lessening of the rotation in the case of fructose and to some extent of glucose, as the following figures show:—

		Without		With basic lead acetate	
		Rotation	Copper in grams	Rotation	Copper
Glucose	...	+ 3.10	1.828	+ 2.47	1.822
Fructose	...	— 5.53	1.857	— 2.46	1.844
Sucrose	...	+ 3.82	—	+ 3.98	—

A slight decrease in the cupric reducing power of the 'leaded' sugar solutions (glucose and fructose) is also noticeable.

The next point to be investigated was to see if the addition of tannin to the sugar solutions and its removal by basic lead acetate altered the percentages of the carbohydrates. Tannin was added to the one per cent. solutions of the sugars just to the extent that it was all carried down in the precipitate, caused by the addition of 5 c.c. of the standard basic lead acetate solution. Any excess of lead was not removed. The rotation and cupric reducing power were found to correspond very closely, so that neither the lead precipitation nor the slight amount of lead salt left in the solution altered the percentage composition of the separate sugar solutions. Below is shown the close agreement in the figures:—

					Tannin added and then precipitated by 5 c.c. basic lead acetate	Control in distilled water
SucroseRotation	+ 3.76	+ 3.77
		Copper after inversion	2.011	2.011
GlucoseRotation	+ 2.74	+ 2.75
		Copper	1.742	1.757
FructoseRotation	— 4.75	— 4.75
		Copper	1.709	1.737

A similar experiment carried out with a mixture of the three sugars showed little difference between the one containing tannin and the control. The mixture consisted *approximately* of 0.5 grams of sucrose, 0.2 glucose, and 0.25 fructose—total 0.95 grams of mixed sugars in 100 c.c. The results obtained are set forth below:—

				Tannin added and precipitated by 5 c.c. basic lead acetate	Control in distilled water
Sucrose	0.487	0.489
Glucose	0.204	0.201
Fructose	0.244	0.244
Total sugar				0.935	0.934

Thus the two estimations are in very close agreement. The addition of tannin and its removal from solution by the necessary amount of basic lead solution has hardly affected the composition of the sugar mixture; and further, the slight amount of lead left in the filtrate after the removal of the tannin-lead precipitate has had no influence on the estimation.

It thus appears that if the basic lead acetate solution is not added in great excess, but only in sufficient amount to precipitate tannin and allied matters, it has no appreciable effect on the sugar estimations, even

when no attempt is made to remove any lead remaining by sulphuretted hydrogen. Let us see if this is borne out by comparing a leaf extract which has been treated with sulphuretted hydrogen to remove the lead with one which has not.

	Excess of lead removed by sulphuretted hydrogen	Lead not removed
Sucrose	10.29	10.56
Glucose	3.88	3.79
Fructose	4.44	4.80
Total sugar from 100 grams of dry leaf	18.61	19.15

By the extra operations required through treatment with sulphuretted hydrogen, the total sugar has undergone some reduction, but the relative proportions of the sugars remain much the same.

A number of trials have been made to see if the addition of 5 c.c. of the basic lead acetate solution per 100 c.c. of distilled water has any effect on the slight spontaneous reduction shown by Fehling's solution. By careful manipulation to make the comparisons as parallel as possible, the data show that the lead solution has a slightly lowering effect on the cupric reduction, the mean difference being 0.5 milligram. This small amount will be negligible in the sugar estimations of the leaf extracts, as much less lead will be left in the saccharine solutions.

The aqueous leaf extract reduces Fehling's reagent considerably more before treatment with basic lead acetate than after.

The following table taken from four experiments demonstrates this difference:—

AMOUNT OF COPPER REDUCED BY THE EXTRACTS MADE FROM 5 GRAMS OF FOUR DIFFERENT LEAF SAMPLES

	Before treatment with basic lead acetate	After treatment with 5 c.c. basic lead acetate	Difference
I.	1.374	1.295	0.169
II.	0.926	0.718	0.208
III.	0.820	0.656	0.164
IV.	0.734	0.509	0.225

The effect of basic lead acetate is, however, without influence on the amount of sucrose estimated by Clerget's acid method.

AMOUNT OF SUCROSE FOUND IN 5 GRAMS OF DRY LEAF

	Without lead	With lead	Difference
I.	0.629	0.628	0.001
IV.	0.576	0.569	0.007

The sucrose in the 'leaded' extracts is in both cases slightly less, due perhaps to a slight retention of sugar by the lead precipitate.

The analysis of the extract after filtering off the basic lead acetate precipitate. For the estimation of the three sugars—sucrose, glucose and fructose, in the leaf extracts, the cupric-reducing power and angle of rotation before and after inversion have provided the data, checked and supplemented by yeast methods.

Fehling's reagent has been employed throughout for the copper estimations under the uniform conditions laid down by Brown and Morris.¹ The cuprous oxide produced by the sugar was collected in a Soxhlet tube plugged with asbestos, and reduced to copper by heating in a current of hydrogen, and weighed as such. These estimations were always made in duplicate, and a maximum difference of two milligrams allowed. With extra care the duplicates can without great difficulty be brought to agree within the milligram, but for the sake of speed, as well as for the general degree of accuracy of this work, a difference of two milligrams seemed permissible.

For the calculation of the amount of the three sugars from the weight of copper reduced, the table prepared by Brown and Morris has been employed.² A different factor has thus been used for fructose than for glucose.

For the estimation of the sucrose, inversion by means of hydrochloric acid under Clerget conditions³ has been the method followed, being quicker than by using the invertase of yeast. These two ways were, however, compared, and found to agree closely.

	Clerget	Yeast
I. Rotation... ..	2.28	2.3
Copper	1.882	1.879
II. Rotation... ..	2.16	2.1
III. Rotation... ..	1.04	1.06
Copper	1.7	1.69

Thus the two methods give practically the same data, and it may be assumed that treatment with hydrochloric acid under Clerget conditions results merely in the inversion of the cane sugar, and further, that the fructose is unaffected by the hydrolysis. Therefore the loss of rotation

1. Brown, Morris and Miller, *Journ. Chem. Soc.*, LXXI, pp. 95 and 278, 1897.

2. Brown, Morris and Miller, *ibid.*, p. 281.

3. To 50 c.c. of the sugar solution 5 c.c. of concentrated hydrochloric acid are added, and the whole heated on the water bath to 68° C. for fifteen minutes.

and the increase in cupric reduction can be considered as being wholly due to the inversion of the sucrose.

The analyses have been conducted on the assumption that the only sugars present in the leaf extracts are sucrose, glucose and fructose. The data obtained have invariably worked out correctly on this assumption, which could hardly have been the case if appreciable quantities of other sugars or soluble carbohydrates or additional substances capable of reducing Fehling's reagent or of rotating the plane of polarised light were present. But, naturally, we have not been content without additional investigations supporting this assumption.

Experiments with Yeast. A series of experiments with ordinary brewer's yeast have been carried out on the aqueous extracts of the Snowdrop leaves.

On submitting an extract, which has been precipitated with basic lead acetate and which has had the excess of lead removed, to yeast fermentation, the rotation and cupric-reducing power become negligible quantities. Hence it is to be inferred that these two properties possessed by the extract before fermentation are due to the presence of fermentable sugars only. No extraneous bodies capable of rotating the plane of polarised light or of reducing Fehling's solution to any appreciable extent appear to be present. We have, therefore, to deal solely with plastic sugars and presumably glucose, fructose and sucrose.

An estimation of the different sugars in a mixed solution can be made by taking the specific gravity and opticity before and after fermentation, coupled with inversion by means of invertase. Such yeast methods can be employed solely for sugar estimations, but the extracts require to have a total strength of sugar at least five times that possessed by the aqueous solution made from 5 grams of dry Snowdrop leaf. Hence for continuous work on these lines a much greater quantity of material would be required than was at our disposal. The yeast method, however, has been used as a check on the copper one, and has given concordant results, thus confirming the view that the three sugars—glucose, fructose and sucrose—are alone present in the extracts.

Experiment I.—

	Total percentage of sugar in 100 grams of dry leaf		
By yeast and specific gravity	21.52
By copper method	21.71

Experiment II.—

	Yeast method decolourised by animal charcoal	Copper method
Sucrose	11.4	12.2
Glucose	3.33	3.33
Fructose	4.67	4.0
Total sugar in 100 grams dry leaf	19.4	19.53

Results obtained after decoloration with animal charcoal. As already mentioned the aqueous extract of Snowdrop leaves is of too dark a colour to allow its angle of rotation to be read at all clearly in the saccharimeter. Basic lead acetate, in addition to precipitating tannin matters, removes the colour. Besides this reagent animal charcoal will also abstract the pigment. On boiling with this substance nearly all the colour is absorbed, leaving the solution almost colourless.

Unfortunately animal charcoal also removes some of the sugar. Its absorbent capacity for saccharine matter has first to be satisfied before it can be used in quantitative work. Hence it is a tedious substance to employ in estimations.

We have tested the absorptive capacity of animal charcoal for the three sugars, glucose, fructose and sucrose, separately, using the charcoal at the rate of 10 grams for every 100 c.c. of the one per cent. sugar solutions.

The sugar solution was first boiled with the requisite amount of charcoal, filtered, and its rotation taken when cool. Another quantity of the sugar solution was then boiled with the same charcoal, filtered and rotated, and the operation was repeated twice more, with the same charcoal.

The angle of rotation of each sugar solution after the first treatment was considerably less than before, showing that some sugar had been absorbed by the animal charcoal.

	Rotation of sugar solution previous to treatment	after first treatment with animal charcoal
Glucose	+ 2.84	+ 2.36
Fructose	— 4.88	— 4.01
Sucrose	+ 3.8	+ 2.59

After the second treatment the charcoal is about satisfied as regards the two hexose sugars respectively, but not quite for the sucrose. This latter sugar seems to be absorbed somewhat more greedily than the former two. Thus in abstracting colour from a solution of a mixture of these three sugars, the animal charcoal must be boiled successively with two

separate portions of the sugar solution, and these must be rejected. The third portion after decolourising with the same charcoal may be regarded as unaltered in respect to its sugar percentages.

This is borne out by our experiments with the Snowdrop leaf extract—the same charcoal, 5 grams being used consecutively with six different portions (50 c.c. each) of the original leaf extract.

	Grams of copper reduced per 100 c.c.			Rotation
Before Treatment	0.883	too dark to read
1st	„	...	not taken	+ 0.88
2nd	„	...	0.753	+ 1.05
3rd	„	...	0.865	+ 1.5
4th	„	...	0.883	+ 1.45
5th	„	...	0.900	+ 1.55
6th	„	...	0.879	+ 1.34

The rotation is practically constant after the third treatment, and the cupric reduction nearly so too. An interesting point also is the fact that the amount of copper reduced after decoloration (provided the animal charcoal has previously been satisfied as regards its capacity for absorbing sugar) is the same as that in the original coloured extract, showing that no substances which reduce Fehling's reagent have been abstracted with the colouring matter. As regards the opticity it is impossible to state, as before decoloration the rotation could not be read with any accuracy.

Analysis of the Extract after decoloration with animal charcoal

In the first place, as might be expected, estimations of cane sugar in the original coloured extract and in a portion of the same extract decolourised by 'satisfied' charcoal agree closely, as revealed by the increase in cupric reducing power brought about either by Clerget's method of inversion or by invertase. Also the quantity of sucrose agrees fairly closely with the amount found in the extract treated in the usual way with basic lead acetate and hydrolysed by Clerget's method.

Coloured extract gave	0.567 grams sucrose	} From 5 grams dry leaf
Decolourised extract gave	0.574 „	
Treated with basic lead acetate in the usual way gave	0.555 „	

Some of the decolourised extract was treated with yeast, and after fermentation its cupric reduction taken. The weight of copper obtained amounted to 0.126 grams per 100 c.c. of extract, i.e., per 5 grams of dry leaf. Before fermentation this came to 0.883 grams of copper. The

difference, 0.757 grams, represents the weight of copper due to fermentable sugars.

Not only has the decolourised extract after fermentation still considerable cupric reducing power as shown above, but also a slight levorotation. Particular attention has been paid to this latter point, and there seems little doubt that the leaf extract, when untreated with basic lead acetate, has after fermentation a slight left-handed rotation, due probably to the substance or substances which cause the residual cupric reduction. An experiment carried out very carefully afforded the following result:—

	Before fermentation	After fermentation
Rotation in the 200 mm. tube	... + 1.3	... - 0.2

Thus we have gleaned the following experimental facts:—

	Extract decolourised by 'satisfied' animal charcoal	Extract treated with the requisite amount of the basic lead acetate solution
After yeast fermentation	... Some cupric reduction Slight levo-rotation	... No cupric reduction No rotation

Hence before fermentation in the case of decoloration with animal charcoal a small part of the cupric reduction is due to other causes than fermentable sugars, and the rotation is in a small measure likewise influenced. Whereas in the case of colour-removal by basic lead acetate all the cupric reduction and rotation may be taken as arising from fermentable sugars alone (presumably from glucose, fructose and sucrose).

When the fermented 'unleaded' extract is boiled for some time with a little mineral acid, the cupric reduction is clearly raised, indicating the presence of a glucoside. Further investigation on this point has not, however, been pursued.

The cupric reducing power of sucrose in the presence of hexoses

Sucrose alone has no reducing power on Fehling's reagent, but if a little hexose sugar be present, then it does reduce slightly. The cuprous oxide produced is greater than can be accounted for by the hexose solely. This, then, is a disturbing influence which must be taken into account when using Fehling for the estimation of sugar mixtures containing sucrose.

We have tested various mixtures of the three sugars, glucose, fructose and sucrose, to see what influence the various proportions of cane sugar may have on the cupric reducing power, and we can confirm previous

work in finding that the increase due to sucrose is very small, unless it be present in a preponderating ratio. Our leaf-analyses strengthen this conclusion also, since the amount of sucrose calculated from the increase of copper due to inversion was found to differ little from the sucrose obtained from the loss of rotation after inversion. Our results, however, show with very few exceptions, that the cane sugar calculated from the loss of rotation is slightly greater than that obtained from the increase in copper—a result to be expected.

The error arising from the slight cupric reducing power of the sucrose can be easily avoided by first estimating the sucrose from the loss of rotation through hydrolysis. The amount of copper reduced by this quantity of sucrose on inversion can then be calculated and deducted from the total copper obtained after hydrolysis, the remainder will represent the copper due to the glucose and fructose jointly. The rotation exerted by the sucrose present in the extract before hydrolysis, can be calculated and deducted from the original rotation of the extract. Two equations can then be formed, one from the copper and the other from the opticity. By solving these the separate amounts of glucose and fructose can be ascertained.

Below is given, by way of illustration, a typical example of how the percentages of sugars in a leaf-analysis are calculated.

Data obtained from an examination of the extract prepared from 5 grams of dried leaf.

- (1) Angle of rotation before inversion in 200 mm. tube at 19° C.
= +1.37 divisions.
- (2) Angle of rotation after inversion in 200 mm. tube at 19° C.
= -1.84 divisions.
- (3) Total copper reduced after inversion = 2.302 grams.

From (1) and (2) we obtain the total fall in the rotation due to the inversion of the sucrose. This comes to -3.21 divisions, which is equivalent to 0.6331 grams of sucrose. [In the polarimeter used it was calculated that a 1 per cent. solution of this sugar loses -5.07 divisions at 19° C.]

Thus we find that 5 grams of this leaf sample contain 0.6331 grams of cane sugar.

Further data can now be obtained for calculating the respective amounts of glucose and fructose.

- (i.) 0.6331 grams of sucrose will give a rotation of +2.44 divisions.

Therefore the rotation due to glucose and fructose jointly originally present in the extract = $+1.37 - 2.44 = -1.07$ divisions.

(ii.) 0.6331 grams of sucrose when inverted will reduce 1.283 grams of copper.

Therefore the cupric reduction due to the glucose and fructose = $2.302 - 1.283 = 1.019$ grams of copper.

From (i.) and (ii.) two equations can be framed, the solution of which will give the separate quantities of glucose and fructose originally present.

Let x = glucose.

y = fructose.

Then (1) $3.03x - 5.34y = -1.07$ (from the rotation).

(2) $2.011x + 1.842y = 1.019$ (from the cupric reduction).

The constants used in the first equation are the angles of rotation given respectively by one per cent. solutions of these sugars in the 200 mm. tube at the temperature observed.

Those used in the second are the grams of copper reduced by one gram respectively of these sugars under the conditions observed, the constants being calculated from Brown, Morris and Miller's Table¹.

From the two equations we obtain respectively 0.2128 and 0.3209 grams of glucose and fructose.

Therefore we arrive at the following analysis of the sugar-mixture in the 5 grams of leaf taken—

Sucrose	=	0.6331 grams.
Glucose	=	0.2128 "
Fructose	=	0.3209 "
Total sugar	=	<u>1.1668</u> "

Multiply by twenty and we get the quantities in 100 grams of this sample of dried leaf, the manner in which results are stated in this paper.

Sucrose	=	12.662 grams.
Glucose	=	4.256 "
Fructose	=	6.418 "
Total sugar	=	<u>23.336</u> "

The duplicate analysis gave the following percentages:

Sucrose	=	12.618 grams.
Glucose	=	4.498 "
Fructose	=	6.508 "
Total sugar	=	<u>23.624</u> "

The mean of these two analyses gives the final result.

1. *Journ. Chem. Soc.*, LXXI, p. 281, 1897.

Evidence from the Osazone. The aqueous extract of the Snowdrop leaf on heating with phenyl hydrazine and acetic acid produces an abundance of yellow crystals characteristic of glucosazone. A further deposit of crystals suggesting those of maltosazone were never obtained on further heating and allowing the liquid afterwards to stand for some time.

The whole of the osazone resulting from representative samples of the leaf material was put together and the melting point and percentage of nitrogen of the mixture ascertained. The melting point was taken after re-crystallising the osazone from pyridine according to the method described by Tutin¹. This came out between 216-217°, the same figure practically as he obtained for glucosazone.

The percentage of nitrogen found in this mixed sample of osazone was 15.7, which agrees very closely with the theoretical number, 15.64, required for glucosazone. If an appreciable quantity of maltosazone had been present in it, then the nitrogen would have been lower, for it contains only 10.77 per cent. of this element.

No evidence of maltose could therefore be obtained by this means, nor of other sugars such as mannose or galactose. The osazone resulting is in agreement with what might be expected from an extract containing only the sugars glucose, fructose and sucrose.

A Summary of Errors likely to occur in the Leaf-analyses

- (1) The total sugar estimated is probably a little low—approximately about 0.5 per cent—owing to incomplete extraction.
- (2) The figures for the cane sugar err rather on the low side on account of some slight inversion during the process of extraction. The amounts found in the various analyses of the leaf should perhaps be raised by nearly 0.5 per cent. and a proportional quantity deducted from the total hexose sugar.
- (3) The fructose is probably somewhat underestimated owing to the action of the basic lead acetate on this sugar, though precautions were taken to avoid this as far as possible.

Fortunately the errors likely to arise in the estimations would not favour but rather oppose the main conclusions arrived at in this paper.

1. *Proc. Chem. Soc.*, Vol. XXIII, p. 250, 1907.

EXPERIMENTS AND RESULTS

Having dealt at some length with the methods employed for the estimation of the sugars in the foliage leaf of the Snowdrop, we now turn to their application and to the results thereby gained. These are set forth under six headings. Under each are given the character of the experiment and the results of the analyses, concluding with remarks.

I. *The Quantity of Sugar in the Leaf is Considerable.*

Twenty to thirty per cent. of the weight of the dried leaf consists of sugar. The amount varies naturally according to the time of day the leaves are picked for analysis. Allowing 80 per cent. for moisture, an average quantity, the fresh leaf will therefore contain 4 to 6 per cent. of mixed sugars.

Brown and Morris's figures¹ for sugars in the leaves of *Tropaeolum* vary from about 10 to 14 per cent. in the dry material, just about half the quantity. Even on adding the starch, which is absent, as we have seen, in the Snowdrop leaf, the total carbohydrate-content of the *Tropaeolum* leaf is considerably less than that of the Snowdrop, being in round numbers 14 to 18 per cent.

It is fortunate that the Snowdrop leaf is so rich in sugar, as it has allowed us to select five instead of ten grams (the amount taken by Brown and Morris) for each analysis—a great saving of material and so of labour.

The abundance of sugar may partly be explained by the fact that the Snowdrop is a spring plant, performing its assimilation when nights are cold, which will retard translocation and thus tend to carbohydrate accumulation in the leaf. The ratio, therefore, of the rate of photosynthesis to that of translocation is probably greater in a plant like the Snowdrop than in a summer-growing one like *Tropaeolum*; and so the carbohydrate formed in assimilation will tend to accumulate in the leaf more in the one than in the other.

Further, a bulbous plant like the Snowdrop has little available tissue other than the mesophyll for temporarily storing the carbohydrate produced in carbon assimilation, hence its leaf will be apt to contain a higher percentage than that found in a plant with a considerable extent of stem.

Whatever reasons may be adduced, the Snowdrop leaf contains a surprising amount of sugar under ordinary conditions.

1. Brown and Morris, *loc. cit.*, pp. 669 and 671.

II. *The amount of Sugar increases from above downwards in a Single Leaf, and at the same time the ratio of the Sucrose to the Hexoses diminishes.*

By comparing the amount of sugar in the upper green parts of the leaves with that in the lower green parts, it soon became evident that care must be taken to pluck the same relative length of leaf, in order that the results may be strictly comparable.

The foliage leaves of bulbous Monocotyledons commence to assimilate in their apical portions long before they attain their full length. As soon as the uppermost part of the Snowdrop leaf has emerged from the basal protective sheath, it is in a state of maturity and doubtless capable of full functional activity provided the external conditions are favourable. The upper green assimilating part of the leaf is continually being added to by basal growth. From personal observation the leaves of the Snowdrop continue to grow in length till nearly the close of their functional period, the increment of growth in a given time gradually decreasing as the spring advances. The increase in length ceases about the third week in April,¹ and early in May the leaves begin to turn yellow and then gradually die away. Thus most of the carbon assimilation in the case of the Snowdrop occurs in the months of March and April.

The Snowdrop plant is a simple or rather simplified structure. Disregarding the floral part, it consists of an outer sheath enclosing two foliage leaves, joined to a short axis bearing below a tangle of rootlets. The upper part of the sheath remains membraneous and is protective in function; the lower part acts as a storage organ and forms the outermost fleshy scale of the 'resting' bulb. Each foliage leaf is sharply divided morphologically into two regions, a basal sheathing part functioning as an organ of storage and an upper assimilating and conducting part—the foliage leaf proper. After the plant has died down, the basal parts of the leaves persist as the middle and inner fleshy scales of the bulb. The leaf proper is further physiologically divided into two regions, an upper and a lower, through the embrace of the external sheath. The upper membraneous part of this covers the lower part of the foliage leaf and prevents this portion turning green. The leaf thus consists of an upper green part and a lower colourless part, in addition to its sheathing base (the immature bulb scale). The accompanying diagrams will help to explain the morphology of the plant, as it bears upon this research.

1. From observations made in the vicinity of Carlisle.

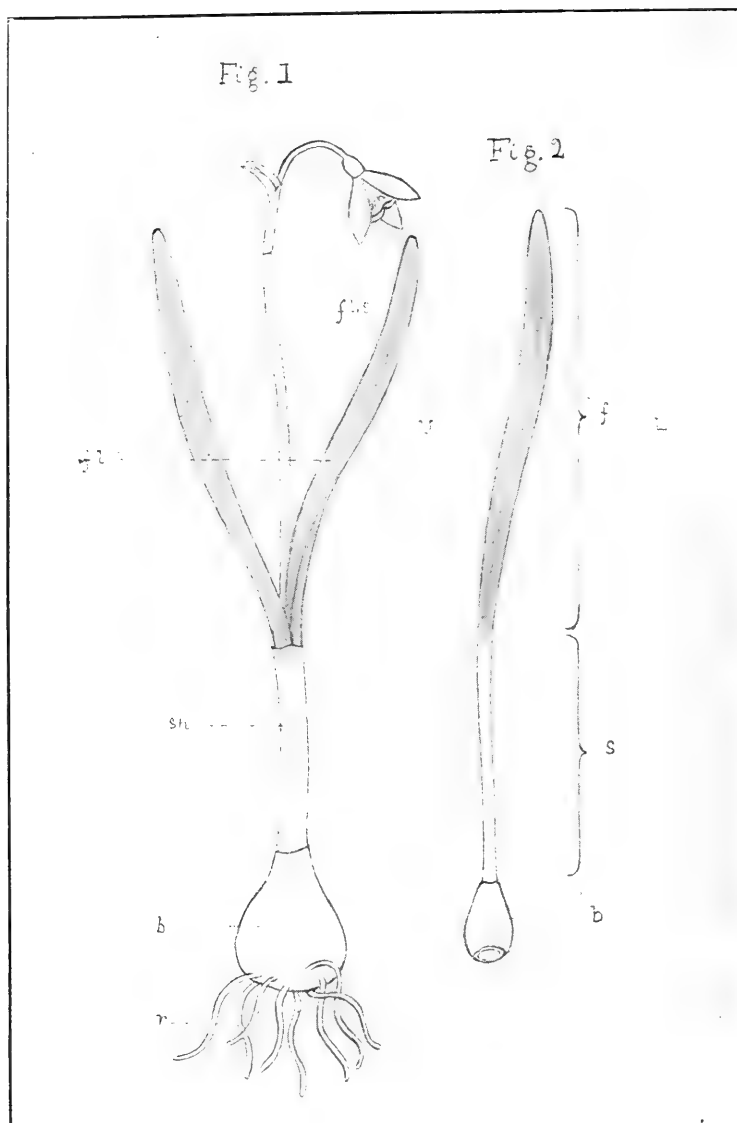

DIAGRAM TO EXPLAIN THE MORPHOLOGY OF THE SNOWDROP PLANT
AS IT AFFECTS THIS PAPER.

FIG. 1. A single plant (somewhat reduced in size):—*f.l.*, the two foliage leaves (shaded). *sh.* protective sheath covering the lower parts ("stalks") of the foliage leaves. *b.*, bulb. *r.*, rootlets. *fl.s.*, flower stalk terminating in the solitary flower.

FIG. 2. A complete leaf detached from the plant:—The upper shaded portion (*f*) represents the green part (the foliage leaf proper): the middle narrow unshaded portion (*s*) the colourless stalk part, which in the intact plant is covered by the protective sheath: the basal portion (*b*) one of the new (immature) bulb-scales, which gradually become filled with starch and inulin, elaborated from the sugar formed in the chlorophyll cells. The line, *U—L*, arbitrarily separates the foliar part into an upper and lower portion. Leaves were so divided for the analyses in this section of the paper. Otherwise, as a rule, the whole of the green part of the leaf was taken for analytical purposes.

The sugars, therefore, formed in the upper green part of the leaf through photosynthesis, will have to travel through the colourless region enclosed by the protective sheath, then across the meristematic zone into the young bulb-scale, to be transformed there into starch and inulin—the two reserve carbohydrates of the 'resting' bulb.

The colourless part of the leaf enclosed by the membranous, external covering is very rich in sugar—30 to 40 per cent. of its dry weight consisting of such. It evidently functions as a temporary storing place for the sugars formed above in the green part through photosynthesis. The sugar is most likely produced in the green tissue at a quicker rate than it can be stored away as starch and inulin in the cells of the growing bulb-scale, and so accumulates in the non-functional, colourless cells.

In this paper the sugar contents of this lower colourless part of the leaf will not be considered further. Attention will be focussed only on the sugars of the green part, that is the portion of the leaf which appears above the protective sheath.

The leaves for this series of experiments were first cut from the plants just above the protective sheath, and then each one was divided either at its middle or two-thirds of the way up or otherwise, according to the analytical comparison desired.

The sugar was always more abundant in the lower than the upper regions. The difference, however, was by no means uniform, and seemed to depend on whether the plants used for the experiment were growing in close clumps or separately. The difference was more marked in the former than in the latter.

The following are the details of these experiments:—

GROWING IN CLOSE CLUMPS

	Portion of leaf taken		Total sugar	Ratio of sucrose to hexose	Date and time of picking
Experiment I.	Upper two-thirds	...	25.95	1:0.6	Mar. 30, 1905
	Lower "	...	28.72	1:1.1	5.30 p.m.
Experiment II.	Upper two-thirds	...	21.98	1:1.05	Mar. 31, 1905
	Lower "	...	26.48	1:1.38	7.30 a.m.
Experiment III.	Upper halves	...	22.48	1:1.39	Mar. 31, 1905
	Lower "	...	30.59	1:4.0	3.30 p.m.

GROWING SEPARATELY

Experiment I.	Upper halves	22.93	1:0.57	April 11, 1906
	Lower "	24.46	1:0.6	7 p.m.
Experiment II.	Upper halves	19.26	1:0.5	April 12, 1907
	Lower "	21.40	1:0.75	noon
Experiment III.	Upper halves	24.03	1:0.65	Mar. 30, 1910
	Lower "	24.36	1:0.82	2.30 p.m.

In the above six experiments the total sugar, which is calculated for 100 grams of dry leaf material, is invariably greater in the lower part of the foliage leaves as compared with the upper; but this difference is very much greater in the leaves taken from plants growing thickly together than in those growing separately. In the one case the mean difference of the three analyses works out to 5.13 grams, and in the other to 1.33 grams.

Secondly, it is to be noted that in every case the proportion of hexose sugar (glucose and fructose) to sucrose is greater in the lower portions of the leaves; and similarly this difference in the ratio is much more marked in the leaves taken from close clumps than in those from plants growing separately, the mean differences being respectively 1.15 and 0.15.

The leaves of Snowdrops growing in clumps tend to shade one another. The upper portions may be fairly well illuminated, but the lower green parts of many will be much in the shade, and so capable of performing little assimilation. It will be otherwise in plants growing separately. The light will be able to reach in the main the whole length of the green part of the leaf, and so the full extent will share in the assimilation. The results of the analyses rather suggest that if the leaves were similarly illuminated for their whole length, the disparity in sugar contents between the upper and lower parts would disappear. Special care was taken in No. III of the second series of experiments to gather only leaves well exposed to the light for their full length, and the figures show a very close approximation between the two different halves. Further research on the point would seem desirable.

It looks as if the lower green part of the leaf when obscured functions somewhat as a storage-tissue accumulating a larger amount of sugar than it would otherwise have done if exposed to good light and assimilating on its own account. An actively assimilating chlorophyll cell perhaps resists a high percentage of sugar arising within it. The act of assimilating may be antagonistic to that of storing.

For most of the investigations, therefore, the full length of the green leaf has been taken from plants grown in special plots. The bulbs were placed about two inches apart, so as to keep the individual leaves from shading each other for the most part; consequently the whole length of the green part of the leaf was fairly well exposed to the light.

III. *The proportion of Sucrose to Hexose Sugar decreases as the season advances.*

If, for example, a batch of leaves be taken about the beginning of March and compared with a similar quantity plucked at the commencement of April, then, judging from the results here obtained, it will be found that the *proportion* of sucrose to the hexoses (glucose and fructose) will be considerably greater in the first set of leaves than it is in the second. That is to say, there is in the dried leaf material more cane sugar in proportion to reducing sugar during the early part of the season than later. Thus it seems that as the spring advances the hexose sugars increase at the expense of the sucrose. A comparison, of course, must be made between leaves picked about the same period of the day. Leaves gathered in the morning must not, for instance, be compared with those taken in the afternoon; for if this be done, then the effect of photosynthesis will mask the seasonal change occurring in the ratio of these two classes of sugars.

The following analyses supply the data upon which the above deduction is based:—

Date and time of plucking	Maximum shade temperature, in degrees Fahrenheit	In 100 grams. dry leaf.	
		Sucrose, grams.	Hexose, grams.
February 16, 1906, 3 p.m.	48.9	19.8	3.56
February 26, 1907, 4—5 p.m.	45	15.07	2.53
March 7, 1906, 3.30—4 p.m.	66.9	14.55	5.69
March 30, 1905, 5—6 p.m.	49.6	15.5	11.4
April 5, 1906, 4—4.30 p.m.	60	14.64	11.17
April 5, 1907, 4—4.30 p.m.	58	14.64	11.61
April 24, 1905, 4—4.30 p.m.	51	14.84	17.29
May 4, 1905, 3—3.30 p.m.	53	10.3	12.78

From the above table the following approximate ratios are obtained for the two classes of sugars. The sucrose in each case is represented by unity and the hexose calculated in proportion to this.

	1905	1906	1907
February 16th	—	1:0.2	—
February 26th	—	—	1:0.2
March 7th	—	1:0.4	—
March 30th	1:0.7	—	—
April 4th	—	1:0.8	1:0.8
April 24th	1:1.2	—	—
May 4th	1:1.2	—	—

It is thus seen that the proportion of the two hexose sugars in the foliage leaf gradually rises from February to May, when the leaves begin

to change and wither. With respect to leaves taken in the late afternoon, in February the hexose only represents a sixth of the total sugar; in early March rather less than a third; in late March and the beginning of April nearly a half; and towards the end of the assimilating season more than a half.

Another striking instance of this feature in the ratios of the two classes of sugars is afforded by a couple of analyses carried out in the spring of last year. The leaves for this comparison were picked in the morning about 10 o'clock—one set on March 11th and the other on April 30th, thus seven weeks apart.

	10 a.m., March 11th	10 a.m., April 30th
Sucrose	12.74 grams.	10.42 grams.
Hexose	5.67 ..	12.38 ..
Ratio	1:0.44	1:1.19

Thus early in the season the quantity of cane sugar present in the leaves was more than double that of the reducing sugars; whereas seven weeks later the two types of sugars approximate closely in quantity.

These two analyses are especially interesting, as the leaves were primarily collected for another purpose, viz., the comparison of the sugars in air-dried leaves with those killed by immersion in liquid air. On glancing back to page 6 it will be seen that both the quantities and ratios of the two kinds of sugars, sucrose and hexose, were nearly the same in the two parallel cases. The liquid air method of preparing the extracts for analysis was so carried out that there was no time for any appreciable invertive action taking place. Consequently it seems very unlikely that the gradual rise noticed in the above analyses in the proportion of hexose sugars as the spring advances is due to any variation in the action of the invertase during the extraction of the leaf powder. The analytical results, then, in all probability represent fairly closely the actual proportions of the two kinds of sugars occurring in the living leaf at the various dates of examination. Thus this gradual proportional increase in the hexose sugars as the season advances appears a fact requiring consideration and, if possible, an explanation.

The mean daily temperature between February and May gradually rises, and so a possible explanation may be sought here. A higher temperature would favour greater enzymic action. More cane sugar might therefore be inverted, and so the reducing sugars would tend to increase at the expense of the sucrose.

However, the seasonal variation observed in the relative proportions of the two classes of sugars can hardly be due to the direct effect of temperature. For example, the maximum shade temperature, as shown in the Table, on March 7th was 66.9° F.,¹ while on March 30th it was only 49.6° F., yet the proportion of hexose to sucrose in the first case is much lower than in the second. Again on April 4th the maximum shade temperature was 60° F., while on April 24th it was only 51° F., yet this disparity in temperature has not influenced the seasonal change in the ratios of the sugars. Further the analyses of February 16th and April 24th, when the maximum shade temperatures were fairly similar, viz., 48.9° F. and 51° F. respectively, show the proportions of the sugars very different.

In some previous work on the carbohydrates of Monocotyledons² certain observations suggested the probability that, as the leaf increases in age, the starch in the mesophyll diminishes. Now sucrose, as a rule, favours the formation of starch in the chloroplasts more than any other sugar. If its percentage falls, then starch will most likely appear less readily and in smaller quantity. Consequently the reason why starch-forming Monocotyledons produce less of this carbohydrate in their foliage leaves, as the season advances, may be due to a general disposition on the part of such leaves as they grow older to accumulate less sucrose and more reducing sugar; at any rate, the behaviour of the Snowdrop leaf in this respect suggests this explanation.

IV. *During any single day of the spring the percentage of hexose sugars in the leaf remains fairly constant, no matter what hour out of the twenty-four the leaves may be examined. The sucrose, on the other hand, fluctuates greatly. It increases during the day and diminishes during the night. Further, leaves detached and insolated contain decidedly more sucrose than their controls.*

The above deduction must not be confused with preceding one. Here we are dealing with the daily variations in the *percentage* of the two classes of sugars; not with the seasonal change in the *relative proportions* observed in leaves taken at different dates throughout the spring, and at the same period of the day in each case. The experiments leading to the above generalization arrange themselves under four sub-headings.

1. This was an exceptionally warm day for the time of the year.

2. Parkin, *loc. cit.*, p. 46.

1. *The comparison of leaves picked in the early morning with those gathered in the late afternoon.*

This series of experiments will show the increase in the total sugar in the leaf due to a certain number of hours of photosynthesis, and also reveal what kind of sugar is especially affected. For the sake of brevity the glucose and fructose are put together as hexose. The ratio of these two sugars to one another is dealt with in a separate section of this paper. The results are stated in grams of sugar per 100 grams of dry leaf—the mode adopted throughout this paper.

Experiment I. March 7th, 1906. Cambridge.

Maximum shade temperature 66·9° F., and minimum temperature previous night 43° F.

	9 a.m.	3.30 p.m.
Sucrose	11·22	14·65
Hexose	6·35	5·48
Total sugar ...	<u>17·57</u>	<u>20·13</u>

Remarks. The sucrose has increased during the 6½ hours of sunlight by about 3·4 grams, while the hexose shows somewhat of a decrease.

This was an exceptionally warm day for the time of year. The total increase in sugar is not as marked as in the two following experiments. Perhaps the temperature, or rather strength of sunlight, retarded assimilation in such a cold-season plant as the Snowdrop; or the small increase may be explained on the grounds that increased temperature favours translocation and so less temporary storing of the sugar formed in photosynthesis.

Experiment II.—April 5th, 1907. Carlisle.

Maximum shade temperature 58° F.

	9 a.m.	4.30 p.m.
Sucrose	9·80	14·65
Hexose	12·38	11·61
Total sugar ...	<u>22·18</u>	<u>26·26</u>

Remarks. The total increase in sugar is here about 4 grams, and is due solely to the sucrose, the hexose having decreased somewhat.

Experiment III.—April 8th, 1908. Carlisle.

Maximum shade temperature 58° F., and minimum temperature previous night 32° F.

	8.15 a.m.	4.15 p.m.
Sucrose	8·88	12·92
Hexose	9·4	10·74
Total sugar ...	<u>18·28</u>	<u>23·66</u>

Remarks. The total increase is nearly $5\frac{1}{2}$ grams, and most of it is due to cane sugar.

The leaves for the above three experiments were picked on fine days, which might be considered favourable for photosynthesis. A considerable increase in the total sugar is noticeable.

The following experiment shows the lack of sugar-increase in leaves gathered on an exceptionally cold day for the time of year:—

Experiment IV.—April 26th, 1908. Carlisle.

COMPARISON OF MORNING AND AFTERNOON LEAVES PICKED ON A COLD SPRING DAY
 Maximum shade temperature 46° F., and minimum temperature previous night 32° F.

	8.30 a.m.	4.30 p.m.
Sucrose	9.74	10.10
Hexose	11.61	11.94
Total sugar ...	<u>21.35</u>	<u>22.04</u>

Remarks. The increase is here very small, only 0.7 of a gram. The temperature has most likely been too low for much assimilation. The sucrose has augmented slightly more than the hexose.

Experiment V.—A fifth investigation was carried out to see the effect on the sugar contents of a day's illumination on leaves of plants kept previously in the dark for four days.

The plants were uncovered and exposed to the light at 8.30 a.m., April 12th, 1908; part of the leaves being taken then and dried, and the rest at 4.30 p.m. after 8 hours' illumination. The day was a favourable one for assimilation, the temperature being about normal for the time of the year.

	8.30 a.m.	4.30 p.m.
Sucrose	5.09	12.55
Hexose	2.77	3.61
Total sugar ...	<u>7.86</u>	<u>16.16</u>

Remarks. This is an interesting experiment. It shows in the first place the great fall in the percentage of sugar in the leaf, as might be expected from four days' obscurity. The effect of darkening on the diminution of the sugar is, however, referred to in detail in a special section of this paper. Eight hours of sunlight has caused a great increase in sugar, over 8 grams, and most of this is due to sucrose.

This experiment seems to be strongly in favour of the view that sucrose arises in the leaf before free hexose sugar, such as glucose. If the sucrose results from condensation of hexose in order to lower the osmotic pressure, it would be rather expected in the foregoing experiment that the hexose would be increased more than the sucrose by the exposure of the leaves to light, as the total sugar percentage in the leaves is so low and presumably also the osmotic pressure; but the reverse is seen to be the case.

2. *The sugars in leaves picked in the evening compared with those gathered the following morning.*

This investigation gives some indication of the quantity of sugar which passes out of the green leaf towards the bulb during the night. The total loss of sugar sustained can, however, hardly be due solely to translocation. The respiration of the leaf will consume a small amount most likely.

Experiment I. April 2nd and 3rd, 1905. Carlisle.

The upper halves only of the leaves were used in this experiment. One batch was gathered at 4.30 p.m. and the other at 8 a.m., the next morning. The plants in this instance were not covered, so there might be a little assimilation proceeding after 4.30 p.m., and also before 8 a.m. The minimum temperature during the night was 32.9° F., and the maximum shade temperature the previous day 52.6° F.

		4.30 p.m.	8 a.m. next morning
Sucrose	14.01	10.36
Hexose	10.76	10.45
Total sugar	<u>24.77</u>	<u>20.81</u>

Remarks. The sugar has diminished by about 4 grams, and this is due almost wholly to the loss in the sucrose. The hexose has remained nearly constant.

Experiment II. March 30th and 31st, 1905. Carlisle.

PLANTS NOT COVERED

Maximum shade temperature 49.5° F., and minimum temperature 38° F.

		5.30 p.m.	8 a.m. next morning
Sucrose	15.46	10.84
Hexose	11.41	12.64
Total sugar	<u>26.87</u>	<u>23.48</u>

Remarks. The sugar has diminished during the night by 3.4 grams, and this is due solely to a fall in the sucrose, the hexose having increased somewhat.

Experiment III. March 7th and 8th, 1906. Cambridge.

The plants were covered, when the first lot of leaves were gathered from them, in the late afternoon, and kept in darkness till the time the second batch of leaves were taken the following morning; thus no assimilation could take place in the interval, even if the light and temperature were sufficient.

Maximum shade temperature 66.9° F., and minimum temperature during the night 43° F.

		4 p.m.	9.30 a.m. next morning
Sucrose	14.65	9.64
Hexose	5.48	5.67
Total sugar	<u>20.13</u>	<u>15.31</u>

Remarks. Over 5 grams of sugar have disappeared, due solely to a reduction in the sucrose. The hexose has remained almost constant in amount. The conditions were distinctly favourable for the translocation of sugar.

Experiment IV.—April 5th and 6th, 1907. Carlisle.

The plants were covered when the late afternoon batch of leaves were taken and kept in darkness till noon the following day—a longer period. Hence a greater loss of sugar might be expected, which was the case.

Maximum shade temperature previous day, 58° F.; minimum temperature during the night, 39° F.; maximum shade temperature following day, 52° F.

			4.30 p.m.	Noon next day
Sucrose	14.65	7.80
Hexose	13.66	13.29
Total sugar	<u>28.31</u>	<u>21.09</u>

Remarks. The sucrose has been nearly halved, while the hexose has kept about constant. The total decrease is over 7 grams in 17½ hours of darkness.

3. *The comparison of sugar contents of leaves detached from the plants with those attached, both being kept in the dark overnight.*

This investigation is supplementary to the foregoing. An indication will thus be given as to what amount of sugar disappears from the leaf otherwise than by translocation. In the late afternoon or early evening a batch of leaves was cut from a plot of plants and their ends placed in water. These detached leaves were put alongside of the remainder of the plants with their leaves intact, and the whole covered till some hour the following morning, when both sets of leaves were taken and dried for analysis. Also at the time when the frame was covered the previous evening, a batch of leaves was picked and dried at once.

Experiment I.—March 7th and 8th, 1906. Cambridge.

Minimum temperature in the frame during the night, 46° F.

			4 p.m., March 7th	9.30 a.m., March 8th	
				Attached	Detached leaves
Sucrose	14.65	9.64	12.51
Hexose	5.48	5.67	5.65
Total sugar	<u>20.13</u>	<u>15.31</u>	<u>18.16</u>

Remarks. The percentage of hexose has practically remained constant in the three sets of leaves. The fluctuation, as usual, is in the amount of sucrose. This has diminished by 5 grams in the attached

leaves, and by 2 grams in the detached. The difference, 3 grams, must be due to translocation. Whether as much as 2 grams of sucrose has been consumed in respiratory processes or not, cannot be definitely asserted. At any rate, this amount has disappeared. Some may have diffused into the water from the cut ends of the leaves, but any loss in this way must be very small. The injury due to severance of the leaf from the plant may lead to pathological complications so that more sugar may be consumed than normally would be utilised in metabolic activity, hence we cannot conclude for certain that in this experiment the 3 out of the 5 grams of sucrose which have disappeared from the attached leaves during $17\frac{1}{2}$ hours of darkness are due to translocation, and the remainder, 2 grams, to consumption in respiration.

Experiment II.—April 5th and 6th, 1907. Carlisle.

Minimum temperature in the frame during the night, 39° F.

The plants and the detached leaves were kept covered till noon.

	6:30 p.m., April 5th	Noon, April 6th	
		Attached	Detached
Sucrose	14.65	7.80	12.12
Hexose	13.66	13.29	13.39
Total sugar ...	<u>28.31</u>	<u>21.09</u>	<u>25.51</u>

Remarks. The hexose, as in the previous experiment, has kept remarkably constant throughout. The extra $2\frac{1}{2}$ hours of darkness has resulted in the additional loss of 2 grams of sucrose. Of course the two experiments are not strictly comparable, as both the time of year and temperature differ. The detached leaves have lost much less sugar than the attached ones, and the relative proportions of the losses in the two sets of leaves are much the same for the two experiments.

4. *The comparison of sugar contents in leaves detached and insulated with those left attached to the plants.*

The leaves were severed from the plants in the morning and their cut ends placed in water contained in a large flat tray. The individual leaves were both kept free from one another, and in a position approximating to the vertical by means of a device formed of wire netting. The tray containing the severed leaves was placed alongside of the control plants. Thus care was taken to submit the two sets of leaves to similar conditions of illumination and temperature.

The object of this experiment was to see to what extent the sugar

accumulated in the leaf when translocation was prevented, and which sugar was most affected.

Experiment I.—April 5th, 1906. Carlisle.

Maximum shade temperature, 60° F.; a fairly bright day, but hardly any direct sunshine.

Leaves were cut from the plants at 9.30 a.m. Both sets of leaves were taken and dried at 4.30 p.m.

	Attached	Detached leaves
Sucrose	15.83	19.02
Hexose	9.65	8.85
Total Sugar ...	25.48	27.87

Remarks. Owing to the translocation of the carbohydrates formed in assimilation being stopped by detaching the leaves from the plants, the total sugar has increased by about 2.4 grams, and this increment is wholly due to the sucrose, the hexose having diminished by 0.8 gram.

Experiment II.—April 5th, 1907. Carlisle.

Maximum shade temperature, 58° F. Sunny morning and dull afternoon.

Leaves treated as for Experiment I.

	Attached	Detached leaves
Sucrose	14.65	20.42
Hexose	11.66	10.5
Total sugar ...	26.31	30.92

Remarks. These results correspond with those of Experiment I, except that the total increase in sugar due to prevention of translocation is considerably greater—nearly twice as much. The sucrose, as usual, is the sugar chiefly affected.

Experiment III.—April 21st, 1910. Carlisle.

Maximum shade temperature, 56° F.; minimum temperature previous night, 45° F. Fairly bright, windy day.

Leaves treated as in the two foregoing experiments. Insolated 9-9.30 a.m., cut 4-4.20 p.m.

	Attached	Detached
Sucrose	18.73	20.66
Hexose	7.78	7.41
Total sugar ...	26.51	28.07

Remarks. The differences are here less marked than in the two foregoing experiments, but of the same nature. Detachment has caused an increase in total sugar of about 1½ grams, wholly due to sucrose, the hexoses having slightly diminished. The windy day, with direct sunshine, may have been less favourable for assimilation in the detached leaves, as these are apt to flag somewhat under such conditions.

V. *The fructose, as a rule, is in excess of the glucose.*

In the great majority of the analyses, not only have the amounts of sucrose and hexose been estimated separately, but also those of the two sugars composing the latter, viz., the glucose and fructose.

With very few exceptions the fructose has been found to be present in greater quantity than the glucose. In these exceptions the two sugars were in nearly equal proportions, the difference being slightly in favour of the glucose. We are inclined to trace these deviations to errors in analysis, arising most likely from using an excess of basic lead acetate. It has already been pointed out (p. 11) that this reagent is a dangerous one to use, without proper precautions, with sugars, and especially with fructose. If the presence of this acetate does affect the sugars, then the fructose will be influenced much more and come out relatively lower in the calculations than the other two. The tendency in our mode of estimation, as already shown (p. 21), is for the fructose to be lower in proportion than it actually should be, hence the value of the above deduction—viz., that the fructose is in excess of the glucose—is enhanced.

Out of fifty-two duplicate leaf analyses made, forty-seven had the fructose in excess of the glucose, and only seven the reverse. Representing fructose as unity, in the former cases the ratio varied from 1:0·4 to 1:0·76, and in the latter from 1:1·01 to 1:1·06. The average ratio for the whole number of the analyses was 1:0·76. This compares very favourably with the ratio 1:0·7, obtained for fructose and glucose in a miscellaneous sample¹ of leaf, in which the sugars were estimated in such a way as to dispense with the use of basic lead acetate.

The calculation of the separate amounts of glucose and fructose depend chiefly upon one observation, viz., the optical angle of rotation. A slight error in the reading of this will affect the results considerably; consequently it might hardly be expected that any further conclusion, beyond the bare fact of the excess of one hexose sugar over the other, could be reached.

However, the results do suggest the following two probabilities, viz., that the proportion of fructose to glucose tends to rise during the night, i.e., when photosynthesis is in abeyance; and secondly, that this ratio appears to increase from above downwards in the leaf, the excess of

1. This quantity of dried leaf material was accumulated by putting together the small portions that remained from all the other samples of leaves used. Hence its analysis gives a good indication of the average ratio of the sugars.

fructose being especially noticeable in the lowest (colourless) part of the leaf. These two tentative conclusions practically resolve themselves into one, viz., that, as the total hexose (reducing) sugar increases in proportion to the sucrose, so does the fructose rise in ratio to the glucose.

On the assumption that the two hexoses arise from the inversion of part of the sucrose, it would seem that the glucose disappears in some fashion at a quicker rate than the fructose.

The preponderance of fructose over glucose in the Snowdrop leaf is a condition somewhat similar to what Brown and Morris¹ discovered in the case of the leaf of *Tropaeolum*. In their researches on this plant they found the fructose, as a rule,² in much greater abundance than the glucose. In fact, in leaves gathered after several hours of sunshine, no glucose at all could be recognised, though fructose was present in considerable amount.

These authors account for the difference in the amounts of these two hexoses by considering that 'dextrose is more readily put under contribution for the respiratory processes of the cell than is levulose.'³

Further discussion on this point is reserved for the concluding section of this paper.

VI. *Leaves darkened for some days still contain a moderate quantity of sugar. The percentage falls rapidly during the first forty-eight of obscurity and then remains nearly constant.*

The experiments to be described under this heading were begun with the purpose of seeing to what extent the green leaf could be depleted of its sugar by prolonged darkening. Is there a limit to the reduction, or does the percentage of sugar fall to nearly zero? And further, how are the relative proportions of the individual sugars affected?

This part of the research is the least satisfactory and complete. The results obtained for different years are not as concordant as one would have liked. This defect may be partly attributed to the imperfect exclusion of light in the first two experiments. Greater precautions were taken later to have the plot containing the plants completely darkened.

The chief feature shown by these darkening experiments is that the sugar depletion rapidly reaches a point at which it stops; the percentage

1. Brown and Morris, *loc. cit.*, pp. 669 and 671, 1893.

2. On page 666 of their memoir an analysis is given showing dextrose in excess of the levulose. This is an exception to the other estimations they record.

3. Brown and Morris, *loc. cit.*, p. 672.

then remains nearly constant, though the darkening may be continued for some time.

For the four experiments the time of year in each instance was very similar. The full length of the green part of the leaf was taken, except in the case of Experiment II, in which only the upper three-quarters of the length was gathered. The leaves appeared to the outward eye quite fresh and green, even after two weeks in obscurity.

Experiment I.—Plants darkened at 6 p.m., April 6th, 1906.

Time of plucking of leaves for analysis	Sucrose	Hexose	Total sugar in 100 grams of dry leaf
At the time of darkening ...	15.83	9.65	25.48
After 24 hours	8.13	9.83	17.96
After 48 hours	6.39	7.76	14.15
After 4 days	4.79	9.15	13.94
After one week	3.41	11.39	14.80

Remarks. The total percentage of sugar has fallen in two days from about 25.5 to 14. On further darkening for another two days, the sugar-contents of the leaf hardly show any additional diminution, and after a full week of obscurity the percentage has, in fact, risen slightly instead of fallen. The hexose during the period that the total sugar remains nearly constant, i.e., from the second day onwards, appears to rise in quantity at the expense of the sucrose. This latter, then, would seem to undergo considerable inversion during prolonged darkness.

Experiment II.—Plants darkened on April 5th, 1907.

Time of plucking of leaves	Sucrose	Hexose	Total sugar in 100 grams of dry leaf
At the time of darkening ...	14.65	11.66	26.31
After eleven days	2.27	9.54	11.81
After two weeks	5.05	6.54	11.59

Remarks. This experiment was tried with the view of seeing what effect darkening beyond one week (the limit in Experiment I) would have on the sugar-contents. The percentage, instead of remaining about 14, has dropped below 12, and apparently stays nearly constant at this lower figure, even though the darkening be continued for a fortnight. The relative proportions of the sucrose and hexose have, however, changed considerably, but in the opposite direction to what took place in the first experiment.

The two experiments are only in agreement in the fact that the sugar percentage falls to a certain point and then remains constant.

At this stage it was observed that the method of darkening the plants was somewhat imperfect. Here and there it seemed possible that

light sufficient for photosynthesis might have penetrated. Hence for the next two experiments precautions were taken to ensure complete darkness. This has resulted in the percentage of sugar dropping considerably lower.

Experiment III.—Plants darkened at 5 p.m., April 8th, 1908.

Time of plucking of leaves	Sucrose	Hexose	Total sugar in 100 grams of dry leaf
At the time of darkening ...	12.92	10.74	23.66
After 3½ days	5.09	3.35	8.44

Remarks. The total percentage of sugar has dropped from over 23 grams to below 8 grams during the darkening period.

Experiment IV.—Plants darkened at 8 a.m., April 11th, 1910.

In this instance a sample of the leaves was not taken for analysis at the time of covering, but presumably the amount of sugar then would be somewhere near 20 per cent.

Time of plucking of leaves	Sucrose	Hexose	Total sugar in 100 grams of dry leaf
After 3½ days darkening ...	3.66	5.54	9.2

Remarks. The fall in total sugar for the same period of darkening as in Experiment III is not so great, but the difference between the two analyses comes almost within the limit of experimental error. The ratio, however, between the sucrose and hexose is the reverse of what it is in the preceding experiment.

SUMMARY OF RESULTS

1. Only three carbohydrates appear to be present in recognisable quantities in the Snowdrop leaf, viz., the sugars sucrose (cane sugar), glucose (dextrose), and fructose (levulose). Starch is always absent, except for a small amount in the guard cells of the stomata, nor has inulin been found, though both these polysaccharides are stored plentifully in the bulb-scales. Maltose has been searched for, but in vain.

(2) The quantity of total sugars in the leaf is considerable—20 to 30 per cent. of the dry weight, as a rule, in leaves actively assimilating.

(3) The amount of sugar increases from above downwards in a single leaf, and at the same time the ratio of the sucrose to the hexoses (glucose and fructose) diminishes. These differences are much more marked in leaves taken from plants growing in close clumps than in those from plants growing separately.

(4) The *proportion* of sucrose to the hexoses decreases as the season advances. That is to say, there is in the leaf more cane sugar in proportion to reducing sugar during the early part of the season than

later. Thus it seems that as the spring advances the hexose sugars increase at the expense of the sucrose. The comparisons were naturally made between leaves gathered about the same period of the day.

(5) During any single day of the spring the *percentage* of hexose sugars in the leaf remains fairly constant, no matter at what hour out of the twenty-four the leaves may be examined. That of the sucrose, on the other hand, fluctuates greatly. It increases during the day and diminishes during the night. Further, leaves detached and insolated contain decidedly more sucrose than their controls, but the quantity of hexose sugar remains much the same.

(6) The fructose, as a rule, is in excess of the glucose, irrespective of the period of the spring or time of day the leaves are picked for analysis. The results further suggest that, as the total hexose sugar increases in proportion to the sucrose, so does the fructose rise in ratio to the glucose.

(7) Leaves darkened for some days still contain a moderate quantity of sugar. The percentage falls rapidly during the first forty-eight hours of obscurity, and then remains fairly constant.

GENERAL DISCUSSION

Our knowledge of the carbohydrates of foliage leaves dates from the year 1862, when Sachs published the first of his classical memoirs on the significance of starch in carbon-assimilation. By his many and beautiful researches, covering a period of twenty years, he proved beyond doubt that the appearance of starch in the chloroplast is the direct outcome of the fixation of carbon under the influence of sunlight. This carbohydrate was therefore regarded by Sachs as 'the first visible product of assimilation,' though at the same time he was quite open to the view that the formation of sugar preceded that of starch. He, however, considered that all the carbohydrate synthesised in the leaf passed through the starch stage. Respecting the disappearance of the starch from the leaf he was strongly of the opinion that it was conducted away in the form of sugar.

The connection between starch and sugar received considerable attention from Schimper, who, in his paper of 1885,¹ held that starch is not only converted into sugar (glucose) for the purpose of translocation, but that it also arises in assimilation from this sugar. According to

1. Schimper, *Bot. Zeit.*, p. 738, 1885.

Schimper's work, then, glucose rather than starch should be looked upon as the first recognisable product of photosynthesis.

Taking into account the formaldehyde hypothesis of Baeyer advanced in 1870, a general theory of carbohydrate synthesis in the green leaf could now be framed. The carbonic acid (CH_2O_3) is reduced by the light and chlorophyll to formaldehyde (CH_2O) with the evolution of oxygen. The aldehyde as soon as formed is polymerised to glucose ($\text{C}_6\text{H}_{12}\text{O}_6$); this sugar is then condensed to starch, and temporarily stored as such in the chloroplasts. The starch, when required to be moved from the leaf, is re-converted into glucose, and travels in this form. Some such theory of carbohydrate photosynthesis may be said to have been the general one held up to the year 1893.

Practically no attempt had been made to discriminate between glucose (dextrose) and fructose (levulose). Maltose, a sugar then known in connection with the germination of the barley grain, had not even been suggested as a possible leaf-carbohydrate. Even cane-sugar had received scant attention, and its presence in the leaf had not been taken into serious account with regard to photosynthesis. It was looked upon more as a reserve than as a circulating carbohydrate.

A fact known at this period, namely, that several Monocotyledons never under ordinary conditions form starch in their foliage leaves, may be regarded as a feature not wholly in accordance with the above simple theory of carbohydrate assimilation. Arthur Meyer,¹ paying especial attention to such plants, comes to the conclusion that the reason why such leaves fail to form starch is not due to a too rapid translocation. He favours (erroneously, as it would appear now) the view that the synthesised carbohydrate is stored in a different form, and cites *Yucca filamentosa* as a probable case in point. Sinistrin (inulin) he discovered in its leaf, and this he considers may be in place of starch. By estimating the amounts of soluble carbohydrates, he discloses also the interesting fact that the leaves of non-starch formers contain much more sugar than those which normally produce starch.

Meyer's work, though distinctly valuable and suggestive, just failed to advance the subject of carbohydrate assimilation a real step beyond Sachs. This was reserved for Brown and Morris. Their work published in 1893² marks the commencement of the second stage in our knowledge of the carbohydrates of foliage leaves.

1. Meyer, *Bot. Zeit.*, Nos. 27-32, 1885,

2. Brown and Morris, *loc. cit.*

In their study of the *Tropaeolum* leaf, they show strong reasons for rejecting Sachs' supposition that all the carbohydrate formed in photosynthesis passes through the starch stage. It is only the excess of sugar produced that is so transformed and temporarily stored. Further, they prove beyond doubt that the leaf starch is dissolved in a somewhat similar fashion as in the germinating barley grain. The enzyme, diastase, acts upon it and converts it into maltose. Thus this sugar is demonstrated in the foliage leaf for the first time.

But their most novel conclusion is with respect to the cane-sugar. This they found more abundantly present than even starch, and the fluctuations in its amount suggested strongly to them that it is the first sugar to be formed in carbon-assimilation. The presence of the two hexoses are more readily accounted for as the products of the hydrolysis of some of the cane sugar than as originally preceding the sucrose. Since levulose was, as a rule, in greater abundance than the dextrose, the authors conclude that the latter contributes more readily to the respiratory needs of the leaf.

The general theory respecting the carbohydrates of the foliage leaf to be deduced from their experiments and conclusions thus differs considerably from, and is more complicated than, that resulting from the work of Sachs and his immediate successors.

At this point it may be well to bring into line the results of the work on the Snowdrop leaf described in this paper. Only three carbohydrates (sugars), viz., sucrose, glucose and fructose, require consideration. Starch is absent, and so is its hydrolytic product maltose. From the analyses the main daily fluctuation is shown to occur in the amount of the cane sugar, the quantity of the hexoses remaining remarkably constant, both under natural and experimental conditions. Even in leaves previously depleted largely of their sugars through remaining in darkness, the glucose or total hexose is not increased by exposure to sunlight, the augmentation occurring almost solely in the sucrose.

Thus our analyses suggest strongly that sucrose is the first recognisable sugar to appear in the Snowdrop, and that the two hexoses arise from it through inversion. Our results further support those of Brown and Morris in the fact that the quantity of the fructose is almost invariably in excess of that of the glucose, pointing to the latter sugar contributing more readily to the needs of the leaf.

Let us now turn to the consideration of a piece of research which

supports the older view that glucose (hexose) is the first sugar to arise in photosynthesis. Strakosch¹ in 1907 published an important paper on the carbohydrates of the sugar-beet leaf, employing a new microchemical method for sugar identification based on the production of osazones in the tissues. By this means of localisation dextrose was found to be the only sugar recognisable in the mesophyll, levulose and sucrose appearing first in the lateral veins of the lamina and increasing in the midrib and petiole. These results were confirmed by direct estimations of the sugars in extracts made from the mesophyll (ground tissue) and the veins of the leaf-lamina, respectively.

Strakosch considers, then, that dextrose is the first sugar to arise in photosynthesis. It travels from the mesophyll to the small veins, and a part is there transformed into levulose. The two hexoses then combine to produce sucrose, and the carbohydrate in this form travels to the root to be stored. In leaves previously darkened and then exposed to sunlight, the formation of starch in the chloroplasts commences later than the increase in the sucrose. Maltose seems only to have been detected in the petiole.

A striking point of agreement in this research with the work on the Snowdrop is the constancy observed in the amount of the hexose sugar. There was no appreciable diminution in its quantity during prolonged darkening, and no increase during many hours of illumination. The author, however, has noticed a slight diminution in the hexose, with a corresponding increase in the sucrose, on the first exposure of a darkened leaf to light. He concludes, therefore, that the transformation of hexose into sucrose is dependent upon light, and ceases when the leaf is darkened.

Though Strakosch's theory regarding the sequence of sugars apparently fits the facts, yet his interpretation fails to carry complete conviction. The rapid rise of sucrose in the leaf on its first exposure to light suggests its very early appearance in photosynthesis. Then sucrose, as a rule, seems to immediately precede, that is, gives rise to starch in plant tissues, but here in the chloroplasts of the beet leaf, according to Strakosch's results, it would appear that glucose was the precursor of starch, as cane-sugar was not discovered in the mesophyll.

Robertson, Irvine and Dobson,² in a paper published in 1909 on the

1. Strakosch, *Sitz. K. Akad. d. Wissen. Math.-Nat. Cl.*, Bd. CXVI, p. 855, 1907.
2. *Bio-Chemical Journal*, IV, p. 258, 1909.

sucroclastic enzymes in *Beta vulgaris*, favour the view of Strakosch in regarding both the formation of glucose and fructose as preceding that of the sucrose in the leaf. These two hexoses they consider are condensed to cane-sugar by enzymic means either through the reversible action of the invertase or by a special enzyme.

The problem affecting the first sugar to arise in a free state in photosynthesis thus centres around the origin of the sucrose in the foliage leaf.

Three different views may be presented. The first, that glucose appears primarily. Part of this is converted into fructose; then the two hexoses are condensed to cane sugar. This theory harmonises with the formaldehyde hypothesis. A weak point is the transformation of glucose into fructose. This can be brought about *in vitro* by the action of weak alkali, but then mannose appears also. There is no evidence that this third hexose occurs in the foliage leaf.

The second view, viz., that the cane sugar is derived from the maltose, and so indirectly from the leaf starch, is ruled out of court by the fact that the Snowdrop leaf contains neither starch nor maltose, and yet holds an abundance of sucrose.

The third view, first advanced by Brown and Morris, states that sucrose is the first sugar to arise in photosynthesis, and that the two hexoses, glucose and fructose, as well as the starch, are derived from it. The results with the Snowdrop leaf seem more in accordance with this theory, though at the same time they cannot be considered wholly at variance with the view first put forward.

Granting that sucrose is the first sugar to arise in the free state, how, it may be asked, is this to be reconciled with the aldehyde hypothesis? In the first place this theory still awaits complete proof. As crudely put, the hypothesis may be incorrect. Free formaldehyde, as well as free hexose directly polymerised from it, may never occur normally in the chloroplast. The photosynthetical process connected with the reduction of the carbonic acid may be more complicated than has generally been supposed. The carbohydrates resulting from it may none of them be truly up-grade products. The earliest to appear in the free state may be split off from some complex molecule, and might quite easily be sucrose in many, if not most, of the higher plants.

There is much evidence to show that this sugar is very widely if not universally distributed in the Flowering Plants.¹ It occurs also in

1. Schulze and Frankfurt, *Zeitschrift für physiol. Chemie*, XX, p. 511, 1895, and XXVII, p. 267, 1899; Bourquelot, *J. Pharm. et Chimie*, Sér. 6, XVIII, p. 241, 1903.

the Vascular Cryptogams,¹ but has been less studied in these. Its presence in the Mosses has been asserted. As yet it has not been recognised in the Algae. It is apparently absent in the Fungi, its place being taken most likely by the disaccharide sugar, trehalose.

Though it can function as a reserve carbohydrate, yet there are considerable grounds for believing that it is largely the form in which sugar travels in the tissues. The plant apparently converts indirectly its reserve carbohydrate into this form of sugar for purposes of circulation. This has been observed in several germinating seeds, tubers and bulbs. Though in each case the sugar immediately arising from the stored carbohydrate through enzymic action is different from sucrose, yet on its way to the growing parts of the seedling or young sprout it seems to have been transformed into sucrose, as this latter sugar now appears. To give a few instances. Brown and Morris² showed that the maltose arising from the starch in the endosperm of the sprouting barley grain becomes changed into cane-sugar on its passage into the growing embryo. Further, excised embryos nourished with a solution of maltose accumulate not this sugar but sucrose. Grüss³ has shown, in addition, that such embryos, when fed with glucose, can change this sugar into sucrose. This author⁴ has also found that in the germination of the date palm seed, the mannose and galactose resulting from the reserve cellulose appear as cane-sugar in the embryo. Schultze and Frankfurt⁵ find sucrose quickly following the dissolution (i) of starch in the germinating seed of *Vicia sativa*, (ii) of galactan in that of the lupine, and (iii) of oil in those of *Helianthus* and *Ricinus*. Also in the sprouting potato, where the carbohydrate is stored as starch, sucrose soon makes its appearance. We have found, likewise, in the bulb-scales of the growing Snowdrop, sucrose the most abundant of the sugars instead of maltose and fructose, which might have been expected from the nature of the reserve materials, starch and inulin. As far as the writer is aware, in no case has it been definitely shown that the sucrose arises directly from the hydrolysis of any reserve carbohydrate. It thus bears an analogy to asparagine in nitrogenous metabolism. This amide is of common occurrence in the higher plants, and is probably the form in

1. Anderssen, *Zeitsch. f. physiol. Chemie*, XXIX, p. 423, 1900.

2. Brown and Morris, *J. Chem. Soc.*, LVII, p. 458, 1890.

3. Grüss, *Ber. deut. Bot. Ges.*, XVI, p. 17, 1898.

4. Grüss, *Ber. deut. Bot. Ges.*, XX, p. 36, 1902.

5. Schultze and Frankfurt, *loc. cit.*

which nitrogen largely travels; yet in germinating seeds, on a parallel with cane-sugar, it does not appear directly as a result of protein hydrolysis, but arises somewhat later in an indirect fashion.¹ It may thus be regarded as the ultimate product of protein dissolution, just as sucrose is in the hydrolysis of reserve carbohydrates.

Sucrose has been found in many cases to be the sugar of most nutritive value to the plant. It is also the one which in most cases favours starch deposition. It can therefore be regarded as the precursor of starch.

Its special physical and chemical properties are also of interest. It is very soluble, and readily crystallises—more so than the other sugars occurring in plants. It is very easily hydrolysed by acids and by invertase. It shares with trehalose alone among the disaccharides in having no reducing properties. Maltose, lactose, etc., do reduce, and so may be said to have the aldehyde group in their molecule functional.

Sucrose may thus have been selected by the higher plants as the chief circulating sugar, partly on account of its non-reducing properties and soluble (mobile) nature, and partly on account of the ease with which it can be hydrolysed into its two components, glucose and fructose. These hexoses may, as a rule, play distinct parts in metabolism—the glucose more readily lending itself to the respiratory needs, and the fructose to constructive work, such as the building up of the plant's framework.² It is also within the bounds of probability that cane-sugar itself may take a direct part in the formation of cell-walls. Just as it appears able to be condensed to starch without previous inversion, so it may be transformed directly to cellulose in the construction of cell-walls. Fenton's work³ is interesting in this connection. He has shown that various kinds of cellulose respond markedly to a special ketose test; and thus concludes that this substance may contain one or more groups identical with that present in fructose.

To sum up, sucrose then seems to be of paramount importance to the higher plants. It probably functions largely as a circulating sugar, travelling as such to the growing regions, to be there partly inverted to supply hexose sugar for respiration. To draw a rough analogy, it may be

1. Brown, H. T., *Trans. Guinness Research Laboratory*, Vol. I, pt. 2, p. 296, 1906; Schulze, *Landw. Jahrb.*, XXXV, p. 621, 1906; Scurti and Parrozzani, *Gazzetta*, XXXVIII, i, p. 216, 1908; Wassilieff, *Ber. deut. Bot. Ges.*, XXVIa, p. 454, 1909.

2. See Lindet's recent paper, *C.R. Acad. Sc. Paris*, CLII, p. 775, 1911.

3. Fenton and Gostling, *J. Chem. Soc.*, LXXIX, p. 361, 1901. See also Cross and Bevan, *J. Chem. Soc.*, LXXIX, p. 366, 1901.

likened to the sovereign in our currency. This coin can circulate over the whole world, and at any time or place be changed for local purposes, so sucrose in the plant may be able to travel anywhere in the tissues, and is perhaps continually being called upon to change itself into hexose sugar for local needs.

Is sucrose, then, not intimately bound up with the photosynthetical process? If this sugar be of so much importance to the flowering plant, has not the chloroplast devised a means of rapidly forming it without the previous production of glucose and fructose in quantity? Much further investigation with this possibility in view seems desirable.

ON DEAMIDIZATION*

By GERTRUDE D. BOSTOCK, B.Sc., M.B., CH.B., *Carnegie Scholar*,*From the Laboratory of Physiology, University of Glasgow**Communicated by Dr. E. P. Cathcart**(Received May 22nd, 1911)*

PRELIMINARY.

When we consider the fate of ingested protein in the organism, we find that its cleavage products, consisting of polypeptides and amino acids, are present in the intestine as the result of digestion. In the course of absorption we lose sight of them, nor have attempts to find them in the blood proved very successful, though it must be remembered that Howell¹ claims, by the use of the most modern methods, to have demonstrated their presence. When the nitrogen of ingested protein again appears, it is almost wholly in the form of urea in the urine. The reappearance of the ingested nitrogen does not necessarily imply the complete metabolism of the protein itself. Indeed, Voit has shown that the nitrogen of the protein is rapidly excreted, while the metabolism of the nitrogen free moiety, as estimated by the CO₂ output, is spread over many hours. As a yielder of energy, nitrogen cannot be regarded as being of much importance. The dynamic value of an amino acid is only slightly lessened by the removal of the amino group. Further, the organism has great difficulty in storing nitrogen; an increased intake of nitrogen leads only to a temporary retention, and nitrogenous equilibrium is quickly re-established.

In attempting to establish nitrogenous equilibrium by feeding dogs with the minimum amount of protein, Michaud² emphasised the importance of the chemical composition of the protein as indicated by the relative amounts of the various amino acids it contains. He found that the protein minimum was lowest when the composition of the protein fed corresponded most closely with that of the animal's own tissues, proving apparently that only appropriate 'Bausteine' were used in

*In all that follows the term deamidization is used to express the fact that ammonia makes its appearance as a result of the action of living tissue on an amino acid or the amide of such an amino acid; strictly speaking the latter is a deamidization and the former a desamination.

building up the living flesh. In the conditions of his experiments the protein was manifestly all needed for synthesis. In the well-fed animal, however, protein is probably used largely for purely dynamic purposes, and in this case deamidization may well play an important part in protein metabolism.

Whatever the immediate precursors of urea may be, it has been abundantly proved that ammonia is converted into urea in the liver. The ammonia liberated from the amino acids produced in the course of digestion will share a like fate, leaving the non-nitrogenous remainder available for the energy demands of the organism.

Investigation of the literature in this field has shown that there is much indirect evidence available in support of this deamidization theory.

Abderhalden and Terruchi³ found that subcutaneous injection of the dipeptides, glycyl-glycin and alanyl-alanin in dogs led to a large increase in the excretion of urea in the urine. Stollte⁴ injected amino acids into the blood stream of rabbits, and found that glycocoll and leucin were practically all excreted as urea. Asparagin, glutaminic acid and alanin were partly excreted as urea and partly as unchanged monamino acid.

Salaskin⁵ perfused the liver with blood to which amino acids had been added, and found that glycocoll, leucin and asparagin could be largely recovered from the blood as urea or an amide-like body. Various observers have carried out feeding experiments on animals with aromatic amino acids, and have succeeded in isolating the deamidized aromatic acid from the urine. Flatow⁶ found in rabbits that *o.* tyrosin was converted into *o.* oxyphenyl acetic acid, and *m.* tyrosin was converted into *m.* oxyphenylpyruvic acid. Chlorphenylalanin also appeared abundantly in the urine as chlorphenylpyruvic acid. Friedmann⁷ fed dogs with *p.* chlorphenylalanin, which, after conversion into *p.* chlorphenylacetic acid, paired with glycocoll, and reappeared in the urine as chlorphenaceturic acid. Finally, Neubauer and Fischer⁸ perfused a dog's liver with phenylamino acetic acid, and found that phenylglyoxylic acid had taken its place in the blood at the end of the experiment.

In alcaptonuria interesting evidence is also obtained of a deamidization occurring in the side chain of the aromatic amino acids. Tyrosin and phenylalanin are both excreted in the urine as homogentisinic acid, or 1, 4 dioxypyrenylacetic acid, the presence of the aromatic nucleus in this condition apparently interfering with a further oxidation of the side-chain. It is interesting to note that there has been a loss of one

carbon atom in the side chain in addition to that of the amino group. Abderhalden⁹ fed alcaptonuric patients with polypeptides containing tyrosin and phenylalanin, and found an increase in homogentisinic acid corresponding in amount to the aromatic amino acid present in the polypeptides. Neubauer and Falta¹⁰ found that phenylalanin in alcaptonuria was first converted into phenyl α lactic acid.

Further evidence in favour of deamidization of amino acids is found in the capacity of the liver to form acetone and diacetic acid on perfusion with certain amino acids.

As regards direct *in vitro* evidence, there is not much available. Experiments which have been carried out have consisted as a rule of digesting tissue to which amino acids have been added. Jacoby¹¹, experimenting with autolytic enzymes, found an increase in ammonia on digesting glycocoll with liver extract. During the course of autolysis he found that a loosening of the tightly-bound nitrogen of the amino acids occurred, with a resulting increase in amide nitrogen (urea?).

Loewi¹² on repeating Jacoby's work also found that glycocoll added to an alcohol liver extract was converted into a urea-like body. He concluded that amino acids were readily attacked by ferments, and gave rise to bodies containing loosely bound nitrogen which were closely related to urea.

Gonnermann¹³ incubated certain amides—formamide, acetamide and succinamide—with liver and kidney emulsions, and found that saponification occurred, the free acid being liberated. The organs sometimes differed in their action, e.g., acetamide and succinamide are split by liver, but not by kidney. Lastly, Lang¹⁴ claimed that deamidization occurred in most of the organs and tissues of the body, and Furth and Friedmann¹⁵ carried out a few experiments to investigate the extent of asparagin splitting by organ ferments. They used Lang's method, and found that liver, spleen, muscle, kidney, lung, brain and intestinal mucous membrane all split amide nitrogen from asparagin in autolytic experiments. The intestinal mucosa evinced the greatest activity.

Lang's (*loc. cit.*) work was received practically without criticism, owing no doubt to the fact that it fitted in admirably with many known facts in the metabolism of protein, such as the rapid appearance in the form of urea of the nitrogen of protein or amino acid, when introduced by mouth into the organism. In view of the importance of such a link in the downward metabolism of the amino acids, it seemed well worth while to repeat and extend some of Lang's work, especially as his claim that

the process is carried on to a significant extent in intermediate protein metabolism, is based on rather slender evidence.

To test the capacity of the tissues to liberate ammonia from amino acids *in vitro* he carried out a large number of experiments with various organ emulsions, incubating them at 38-40° C. for longer or shorter intervals with certain amino acids and other bodies containing the amide group. The organs examined were liver, pancreas, spleen, kidney, testis, adrenal, lymph gland and muscle tissue. Glycocoll, tyrosin, aspartic acid, asparagin, cystin, leucin, phenylalanin, acetamide, glutamin, glycosamin, urea and uric acid were the substances investigated. Lang's more important results were as follows:—

The total amide nitrogen of asparagin and glutamin was split off by all the organs; a small portion of the amino nitrogen as well was apparently liberated by the liver.

Glycocoll was split to a less extent by kidney, liver, testis and adrenal, and abundantly by pancreas and intestine.

He further noted that fresh aseptic tissue was more active than tissue incubated under antiseptic precautions, e.g., the fresh intestinal mucous membrane of a dog split an amount of glycocoll in one to two hours, equal to that split in twelve days by the incubated mucous membrane incubated in presence of an antiseptic.

The figures quoted from Lang in the following table (Table I) are concerned only with liver and intestine, as those are the organs which have been used in the present series of experiments.

It is largely on the value obtained for the ammonia liberated from glycocoll in Test 21 that Lang bases his claim for the importance of deamidization in intermediate proteid metabolism, i.e., in one and a half hours as much ammonia is liberated in the aseptic test as is liberated at the end of twelve days' incubation in presence of an antiseptic.

PRESENT INVESTIGATION

I. *Liver*

The first question to be answered was as to what extent deamidization could be demonstrated in an organ emulsion to which an amino acid or an amide of an amino acid had been added.

The method followed in carrying out the present series of experiments closely resembles that used by Lang. The organ, unless obtained from

an animal killed in the laboratory, was brought as quickly as possible from the slaughter-house (*circa* half an hour) and was immediately minced finely by a mincing machine.

A number of tests each weighing 50 grams were then weighed into a series of glass-stoppered jars; 100 c.c. of 0.9 per cent. sodium chloride solution was added to each test, with 2 c.c. toluol. To every test, save those serving as controls, an addition of 0.3 to 1 gram of an amino acid or amide was made. All the tests were well shaken, and after being overlaid with toluol were incubated at 38° C. for periods varying from days to weeks, and even months.

To ensure antiseptis, Lang used a shaking machine; this was frequently omitted by me, as Meltzer¹⁶ has stated that enzymes could be destroyed by continued shaking. The tests were shaken by hand for five to fifteen minutes, when the shaking machine was omitted, and were then overlaid with toluol and incubated as usual.

At the end of the incubation period the tests were acidified with acetic acid, and after the addition of 40 c.c. of a 5 per cent. tannic acid solution they were heated, with continual stirring, until coagulation occurred. On cooling, the precipitate and fluid were made up to 400 or 500 c.c.; half of the filtrate for this was taken for the estimation of the ammonia, which was carried out *in vacuo* at a temperature of 38-40° C. Lang used magnesia for driving off the ammonia, but Kruger and Reich¹⁷ point out that magnesia causes a gradual liberation of ammonia from certain nitrogenous bodies. Grafe's¹⁸ recommendation was therefore adopted, and a mixture of sodium carbonate and sodium chloride was substituted for the magnesium oxide.

A number of tests prepared according to this method were incubated in the presence of an antiseptic (toluol) for periods varying from a few days to three or four months. Liver was the organ first investigated, as previous work, such as that of Salaskin, Stolte, and others, had shown that the liver was the site of some kind of deamidization. The amino acids used were glycocoll, leucin, alanin, and the amide asparagin. A glance at the table below (Table II) will show that in every case ammonia has been liberated from asparagin in fair amount, but in the case of glycocoll the liberation has been much less marked, and in some cases has even been absent.

The next question was how far the antiseptic used inhibited the action of the deamidizing enzyme; in other words, in a fresh organ emulsion incubated for several hours without an antiseptic, is the amount

TABLE II

	Days incubated	CONTROL		ASPARAGIN		GLYCOCOLL	
		Mg. NH ₃ N in 50 g.	Mg. NH ₃ N in 50 g.	Mg. NH ₃ N split from Asp.	Mg. NH ₃ N split from Asp.	Mg. NH ₃ N split from Glyc.	Percentage of T.N. of Glyc.
1. Ox Liver 50 g. ...	5½	24	39	15	32.1	—	—
2. Sheep Liver 50 g. ...	11	25	49	24	25	27	14.6
...	19	48	—	—	—	8	4.3
6. Dog Liver 50 g. ...	9	28	—	—	—	8	4.3
...	21	24	—	—	—	—	—
7. Foetal Sheep Liver 50 g. ...	7	30	66	36	87.1	3	3.2
...	17	29	—	—	—	—	—
5. Foetal Dog Liver 50 g. ...	6½	25	42	17	36.4	—	—
16. Human Foetal Liver 50 g. ...	12	22	29	7	25	—	—
19. Human Liver 50 g. ...	12	37	—	—	—	—	—
...	Months	—	—	—	—	—	—
25. Ox Liver 50 g. ...	3½	60.4	72.8	12.4	44.3	3	5.3
" 50 g. ...	3½	56	—	—	—	—	—
...	Days	—	—	—	—	—	—
17. Rabbit Liver 30 g. ...	13	14.3	21.6	7.3	20	0	—
12. Sheep (Gut + Liver) 50 g. ...	7	26	48	22	78	26	—
" Gut 50 g. ...	7	21	38	17	60.7	23	3.5
" 50 g. ...	19	29	49.9	20.9	74.7	29	—
" Liver 50 g. ...	9	35	52	17	60.7	37	3.5
15. Ox Liver 50 g. ...	66	26.3	51.5	25.2	90.3	—	—

of ammonia liberated from added amino acids greater or less than in an antiseptic test incubated for days instead of hours? Lang laid very great stress on the rapidity of deamidization in the 'aseptic' tests; he was satisfied that bacterial action could be disregarded if proper aseptic precautions were observed, and if the incubation period were not prolonged ($1\frac{1}{2}$ to $2\frac{1}{2}$ hours). It may be remarked that there is no record of any cultures being taken to test the success of his precautions. As the result of these series of tests with the fresh organ incubated aseptically, Lang maintains that the deamidizing enzyme is retarded in its action by toluol, and that deamidization in the tissues of the organism is much more extensive than a consideration of the amount of liberated ammonia in the antiseptic experiments would indicate.

Some tests were prepared in the usual way, but without the addition of any antiseptic; the results are tabulated below in Tables III and IV. The instruments and vessels were sterilized, and the tests were incubated from $1\frac{1}{2}$ to 5 hours; they were not shaken continuously for reasons given above. In the serial tests (No. 3, Table III), in which the first tests were incubated for $1\frac{1}{2}$ hours, and the others for $3\frac{1}{2}$ hours, an addition of toluol was made to the latter at the end of incubation, as it was impossible to work up all tests on the same day at the end of incubation.

These tests (*b* and *c*) were kept at laboratory temperature (7° C. to 14° C.) until they could be dealt with. As a result it was found that not only did the ammonia liberated increase in the latter tests, but the ammonia in the controls increased also; evidently autolytic and deamidizing processes were still active at a temperature much lower than 38° C., and in the presence of an antiseptic. In No. 6, Table III, the same thing is evident, although in this case the tests were placed in the refrigerator immediately after incubation. In order to stop further ferment action the tests in all subsequent experiments were always heated immediately after incubation till the protein was coagulated.

TABLE III

	Hours incubated	CONTROL		ASPARAGIN		Percentage of T.N. of Asp.
		Mg. NH_3N in 50 g.	Mg. NH_3N in 50 g.	NH_3N split from Asp.		
3. 6.5.10 Ox Liver 50g. (a)	$1\frac{1}{2}$	3.6	5.2	1.6	3.4	
7.5.10 " (b)	$3\frac{1}{2}$	12	19	7	15	
9.5.10 " (c)	$3\frac{1}{2}$	21	40	19	47.2	
4. 13.5.10 Dog Liver (a)	3	14	15	1	1	
15.5.10 " (b)	3	14	20	6	6.4	
6. 28.5.10 Dog Liver (a)	$4\frac{1}{2}$	15	16	1	2	
30.5.10 " (b)	$4\frac{1}{2}$	16	21	5	10.7	
33.5.10 " (c)	$4\frac{1}{2}$	30	49	19	38.5	

A comparison of Lang's table (Table I, Experiments 20, 21 and 22, with Experiments 3, 4 and 6, Table III) shows that Lang obtained higher values for the liberated ammonia than I was able to get. As he used defibrinated blood in these 'aseptic' tests, it was thought that the absence of this in my experiments might explain the lower figures obtained.

In Experiments 11 and 15, Table IV, an addition of 50 c.c. defibrinated blood to each test in 11, and of 25 c.c. in 15, was made.

These tests incubated with defibrinated blood do show on the whole a more active deamidization, probably because of a closer relation to vital conditions. In most of the subsequent experiments, therefore, an addition of 25 c.c. defibrinated blood was made to each test.

Part played by Bacteria. As gelatine cultures taken from the 'aseptic' tests at the end of incubation invariably gave positive results, it was of the greatest importance to ascertain the possible part played by bacteria in deamidization. It has been proved that a liberation of ammonia does occur when putrefaction organisms are incubated with amino acids. In a recent publication, Brasch¹⁹ showed that the *B. putrificus* deamidizes glycocoll and alanin, yielding acetic and propionic acid in their place, respectively. In the more complex amino acid, aspartic acid, formic, propionic and succinic acid appeared, and not merely the products of a simple deamidization.

It might be urged that the presence of an antiseptic in the tests is sufficient to prevent bacterial action. Gelatine stab cultures were made in Experiments 12, 16, 17 and 19, Table II, with negative result, but it must be remembered that a negative culture does not prove the absence of bacteria.

The simplest way of investigating the part played by bacteria in the deamidization of asparagin in an organ emulsion is to compare the amount of ammonia liberated at the end of incubation in a test containing both enzyme and bacteria with the amount liberated in a test containing bacteria only. The absence of the enzyme in the latter case can be assured by heating the tests to 100° C. Subsequent inoculation provides the bacteria.

In accordance with this, in Experiments 21, 22, 23 and 24, Table V, a series of tests, A, B, C and D, each consisting of 50 grams liver tissue, were prepared in the usual way. A and C were used as controls, no addition of any kind being made. To B, 0.3 gram of asparagin was added; C and D were immediately boiled to destroy the enzyme, and were then

TABLE IV

Hours incubation	CONTROL Mg. NH ₃ N in 50 g.	ASPARAGIN		GLYCOCOLL		LEUCIN		ALANIN	
		Mg. NH ₃ N in 50 g.	Percentage of T.N. of Asp.	Mg. NH ₃ N split from Asp.	Mg. NH ₃ N split from Glyc.	Percentage of T.N. of Glyc.	Mg. NH ₃ N split from Leucin	Percentage of T.N. of Leucin	Mg. NH ₃ N split from Alanin
9. Rabbit liver	12	16	8.5	4	—	—	—	—	—
10. Ox liver	10	18	17.1	8	—	—	—	—	—
11. Ox liver + 50 c.c. defib. blood	15	25	21.4	10	16	1	—	—	—
15. Ox liver	19	32	27.8	13	19	0	—	—	—
25 c.c. defib. blood	11.3	18	11.9	6.7	13.7	2.4	—	—	—
26. Ox liver	12.6	22.54	17.7	9.94	14.1	1.5	—	—	—
27. Ox liver	15.9	22.6	11.9	6.7	—	—	—	—	—
38. Ox liver + lactic acid	17.8	—	—	—	18.2	0.4	—	—	—
	18.8	26.6	14.1	7.8	—	—	20	air bubbled through tests 1.2 3.7	—
33. Sheep liver	22.8	26.4	6.5	3.6	—	—	—	—	—
34. " " "	12	15.5	6.2	3.5	—	—	1.4	2	6.2
40. Young dog liver	18.6	—	—	—	—	—	—	—	18.2
41. " " "	14.2	—	—	—	—	—	—	—	14
43. " " "	13.9	19.54	10	5.64	—	—	—	—	—
47. Ox liver	16.98	—	—	—	17.37	0.39	—	—	—
48. Ox liver	11.7	—	—	—	12.7	1	—	—	—
	13.4	20.6	4.9	7.2	15.6	2.2	15.6	2.2	6.8

N.B.—The tests in 48 were shaken continuously during incubation; the values obtained for the liberated ammonia are not greater than some of those found in tests incubated in the usual way.

allowed to cool; A and B were incubated three hours. From each test 2 c.c. fluid were removed for the inoculation of C and D. A and B were then immediately worked up in the usual way.

After inoculation, C and D were incubated for $1\frac{1}{2}$ hours to give the bacteria a start; 0.3 gram asparagin was then added to D, and a further incubation of three hours followed, at the end of which time the tests were worked up.

Here there is evidence of a deamidization of asparagin due to bacterial action alone, the largest amount of ammonia liberated being 2 mgm. in Experiment 22; the smallest amount set free, 0.2 mgm., is found in Experiment 24. On the other hand, the combined action of enzyme and bacteria liberated 6 mgm. ammonia nitrogen in 23, but only 1.7 mgm. in 24.

Possibly the conditions were made too favourable for the bacteria in 22, they had $1\frac{3}{4}$ hours' incubation before the addition of asparagin was made. As a matter of fact, in Experiments 20 and 24, gelatine cultures taken from each test at the end of incubation showed colonies on the third day in the case of the C and D tests and not until the fifth day in that of the A and B tests.

In Experiments 23 and 24, two additional tests, E and F, were prepared. They were treated in exactly the same way as C and D, with this exception, that they were not heated to 100° C., i.e., they were allowed to stand at laboratory temperature, and were inoculated at the same time and in the same way as C and D, the result being that they contained active enzyme *plus* a double dose of bacteria. The addition of asparagin to F was made immediately before incubation—E served as a control. Positive and abundant gelatine growths were obtained from each test of the four series at the end of this incubation period.

The results of these experiments show that the bacteria present are only responsible for a minor part of the ammonia liberated from asparagin.

In connection with bacterial deamidization, it is interesting to note that when two gelatine cultures of three days' growth (obtained at the end of incubation from the control and asparagin test, respectively, in Experiment 15, Table IV) were each incubated for two hours with 0.15 gram asparagin; 3.8 mgm. ammonia nitrogen were liberated from the first, and 3.6 mgm. from the second culture. Unfortunately the absence of a third culture as a control, to which no addition of asparagin had been made, leaves it uncertain whether the whole of the ammonia nitrogen

liberated came from the asparagin. The technique was the same as in the case of an organ emulsion.

TABLE V

	Hours incubation	CONTROL		ASPARAGIN	
		Mg. NH ₃ N in 50 g.	Mg. NH ₃ N in 50 g.	Mg. NH ₃ N split from Asp.	Percentage of T.N. of Asp. liberated
21. Sheep liver, 50 g., Enzyme intact, A and B	3	8.4	13.7	5.3	18.9
Bacteria only present, Enzyme destroyed, C and D	3½	9.5	10.6	1.1	3.8
24. Sheep liver, Enzyme intact, A and B	3	15.8	17.9	2.1	7.5
Bacteria present, Enzyme destroyed, C and D	3	11.2	11.4	0.2	0.7
Bacteria present, Enzyme intact, E and F	3	14.8	16.5	1.7	6
22. Ox liver, Enzyme intact, A and B	3	11.7	14.8	3.1	11
" " destroyed, C and D	3	10	12	2	7
23. Ox liver, Enzyme intact, A and B	3	9.9	15.9	6	21.4
" " destroyed, C and D	3	10.9	12.3	1.4	5
" " intact, E and F	3	15.2	18.9	3.7	13.2

In view of the facts shown in Table V, bacterial deamidization has been ignored in the subsequent investigations, which have been almost entirely carried out with fresh organ emulsion incubated without the presence of any antiseptic for two to four hours. The results detailed in Table IV obtained in this manner are, in my opinion, of greater value in considering intravital metabolic processes than those obtained from antiseptic organ emulsions at the end of one or more weeks.

Other Factors

Oxygen Supply. It was thought that a better supply of oxygen to the tissues might increase deamidization activity, and in tests 26 and 28 (Table IV) air was bubbled through the emulsion during incubation (the air leaving the digest flask was passed then through decinormal acid to collect any ammonia liberated). No appreciable increase of deamidization was observed.

Presence of Lactic Acid. In view of the results of Schryver,²⁰ who demonstrated, when working on the autolysis of the liver, that there was an increase of rapidity of breakdown (increased activity of ferment) if the tests were acidified with lactic acid, Experiment 38, Table IV was carried out using the usual methods except that the tests were acidified to the extent of 0.1 per cent. with lactic acid. There was no increased deamidization.

Optical Activity. As Abderhalden²¹ found that organ extracts and pancreatic juice only liberated from certain racemic polypeptides the optically active amino acids which occur naturally in protein, the question of optical activity had to be considered. In this connection it is interesting to note that the expressed juice of liver, placenta and kidney, according to Bergell and Brugsch,²² can cleave dl leucinamid and dl alanyl-alanin into the active components. They find that this is not due to autolytic activity, for the fresher the juice the more active is the cleavage.

The material I used was an abiuret pancreatic digest, very kindly given to me by Dr. Cathcart. As a considerable amount of ammonia was present in this digest, it was neutralised with acetic acid and to obviate the necessity of making an ammonia estimation in it, an amount of this digest, containing 0.296 gram nitrogen (Kjeldahl), was added to Test 39 (Table VI) *before* digestion, and an equal amount to the control test *at the end* of incubation. The result obtained showed but a very small increase of ammonia.

A second experiment (46) was carried out with a freshly prepared casein digest, which had been digested with pancreatin for a month. Before use the digest was precipitated by means of phosphotungstic acid, the excess of the precipitant being removed with barium carbonate. 100 c.c. of the filtrate thus obtained, containing 10 mgm. ammonia nitrogen and 170 mgm. T.N. was then added to 50 gram ox liver. As this test contained at the end of incubation only 9.1 mgm. of ammonia nitrogen more than the amount of ammonia nitrogen in the control test, it is evident that there has been no deamidization of the digest.

TABLE VI

	Hours of incubation	CONTROL	DIGEST	
		Mg. NH ₃ N in 50 g.	Mg. NH ₃ N in 50 g.	Mg. NH ₃ N liberated
39. Ox Liver	4	91	96.2	5.2
46. Ox Liver	3	11.7	20.8	9.1
	3	11.6	lost	—

II. *Intestinal Mucosa*

A consideration of the following facts led to an investigation of the deamidizing action of the intestinal mucous membrane. Nencki, Pawlow and Zaleski found the ammonia content of the portal blood constantly higher than that of arterial blood. They found also an increased amount

of ammonia in the intestinal mucosa after flesh feeding compared with the amount present at the end of two days' starvation. These results were confirmed by Horodynski, Salaskin and Zaleski.²³ Cohnheim²⁴ found an increase of ammonia at the end of six hours' digestion in the blood bathing a fish's intestine, which he had previously filled with a solution of an amino acid (aspartic acid), proving that a deamidization had occurred. He obtained the following figures:—

9 mgm. ammonia were liberated from 0.25 gram aspartic acid; and 15 mgm. ammonia were liberated from 0.23 gram lysin chloride.

This would suggest that an active deamidization had taken place in the intestinal mucosa.

Lang carried out three experiments with ox intestinal mucosa, with the results shown in Table I.

I carried out a series of experiments detailed in Table VII. In Test 12, 50 grams sheep intestine, incubated antiseptically for seven days, liberated 17 mgm. ammonia nitrogen from asparagin, and 2 mgm. ammonia nitrogen from glycocoll. 50 grams of sheep liver liberated a similar amount of ammonia nitrogen from asparagin and glycocoll in nine days.

In the aseptic tests with mucous membrane there is always a small amount of ammonia nitrogen liberated from asparagin, the maximum amount in three hours' incubation being 2.8 mgm. Contrasting this with the amount liberated by 50 grams liver in the same time, we find, in Experiment 15, Table IV, a maximum of 9.94 mgm. The deamidization of asparagin in the aseptic tests carried out in the manner already described is more active apparently in the case of liver than in that of intestinal mucosa.

Possible co-ferment. The possibility of a co-ferment action was considered in the same series, 25 grams liver and 25 grams mucous membrane being incubated together. There is, perhaps, evidence of a slightly increased activity in the mixed test with asparagin, but it is not enough to postulate the existence of a co-ferment.

It was thought that a more active deamidization might be found at the height of digestion, and for this reason, in Experiment 40, Table VII, a young dog was killed seven hours after a large meat meal. The intestinal mucous membrane was scraped off the muscular coat and finely chopped. It was then incubated with a mixture of 50 c.c. defibrinated blood and 100 c.c. Locke's solution, and air was bubbled through the tests during the four hours of incubation; 4.7 mgm.

TABLE VII

INTESTINAL MUCOSA	CONTROL		ASPARAGIN		GLYCOCOLL		LEUCIN		
	Days	Mg. NH ₃ N in 50 g.	Mg. NH ₃ N in 50 g.	Mg. NH ₃ N split from Asp.	Percentage of T.N. of Asp.	Mg. NH ₃ N in 50 g.	Mg. NH ₃ N split	Percentage Mg. NH ₃ N of T.N. of Glyc.	Mg. NH ₃ N split from Leucin
12. Sheep 50 g. ... Antiseptic—	(1) 7	21	38	17	60.7	23	2	3.5	—
	(2) 19	29	49.9	20.9	74	—	—	—	—
	Hours								
29. Ox gut 50 g. ...	(1) 3	12.1	14.7	2.6	4.6	11.3	-0.8	—	—
	(2) 3	15.4	18.2	2.8	5	—	—	—	14.6
37. Sheep 50 g. ...	2	9.9	12.3	2.4	4.2	—	—	—	—
40. Puppy—fed ...	4	34.3	—	—	—	39	4.7	8.4	—
41. " fed ...	3½	19.9	21.2	1.3	2.3	—	—	—	—
42. " 25 g., fasting	3½	26.2	26.7	0.5	0.8	—	—	—	—
43. Fasting ...	3	15.7	—	—	—	15.91	0.21	0.3	—

TABLE VIII

Sheep	Incuba- ted	CONTROL		ASPARAGIN		GLYCOCOLL	
		Mg. NH ₃ N in 50 g.	Mg. NH ₃ N in 50 g.	Mg. NH ₃ N split from A.p.	Mg. NH ₃ N in 50 g.	Mg. NH ₃ N split from Glyc.	
Gut + Liver aa 25 g. ...	7	26	48	22	26	—	
Antiseptic—							
Gut 50 g.	7	21	38	17	23	2	
Liver 50 g.	9	35	52	17	37	2	
Gut 50 g.	19	29	49.9	20.0	29.4	0	
Sheep	Hours Incuba- ed	LEUCIN					
Aseptic—							
(37) Gut + Liver aa 25 g. ...	4	22.4	28	5.4	23.2	0.8	
Gut 34 g.	2	9.9	12.3	2.4	—	—	
Liver 50 g.	2	14.2	—	—	19.4	0.2	

ammonia nitrogen were liberated from glycocoll. Unfortunately the amount of mucous membrane was only sufficient for two tests—the control and the glycocoll test.

In Experiment 41 two young dogs were killed five hours after a meat meal, whilst Experiments 42 and 43 were carried out with similar material obtained twenty-five hours and twenty-seven hours, respectively, after a meat meal.

As a result of these experiments it was found that under the conditions present in one case (Experiment 40) deamidization of glycocoll is certainly greater at the height of digestion, but the experiments are too few in number to dogmatise upon. The extraordinarily large amount of ammonia present in the control of Experiment 40 is in accordance with the known facts as to the large ammonia content of the intestinal mucosa at the height of digestion.

Deamidization in various Species and in Foetal States. As metabolism varies in certain particulars in different species of animals, the question may be asked whether any marked differences are found in the deamidizing capacity of the liver of the various animals used, namely, dog, rabbit, sheep and ox. The experiments were not carried out with this definite point in view, but on looking through the tables it will be seen that the most active splitting of glycocoll occurs in the sheep (Experiments I and VII); no other definite variations are noticed.

It is interesting to note that in the foetal livers (Experiments 5, 7 and 21, Table II) of varying ages examined, quite an active splitting of asparagin has occurred. The presence of tissue enzymes in the embryo

is a well-established fact. Amongst other workers in this field may be mentioned Mendell and Leavenworth,²⁵ who carried out a series of investigations on embryo pigs. They found an active autolytic enzyme in the liver, and demonstrated the early presence of lipase in liver and intestine, although the activity of the latter was less pronounced than in the full-grown animal.

In considering the question of how far the amount of ammonia indicates the extent of deamidization, there are three possibilities as to the fate of the liberated ammonia:—

- (1) It may be converted into urea in the liver tests.
- (2) It may be fixed in some way by the tissue.
- (3) It appears as such.

The conversion of ammonia into urea by the liver *in vivo* is a well-established fact; in the case of organ emulsion, however, added ammonia only disappears to a limited extent. For example the following:— Table IX shows that in Experiments 44, 45 and 47, 3.54, 6.52 and 4 mgm. ammonia nitrogen (in percentage amount 12, 23 and 8), respectively, disappeared during incubation for three hours with 50 grams liver tissue.

TABLE IX

	Hours incubated	CONTROL	Mg. NH ₃ N in 50 g.	AMMONIA	Percentage of T.N. not recovered
		Mg. NH ₃ N in 50 g.		Mg. NH ₃ not recovered	
44. 50 g. Ox Liver 25 c.c. Ammon. Acet. Solution added to one test containing 27.82 mg. N.	3	12.4	36.68	3.54	12
45. 50 g. Ox Liver + 25 c.c. defibrinated blood Ammon. Acet. = 27.82 mg. N.	3	12.2	33.5	6.52	23
47. 50 g. Ox Liver, Ammon. Acet. = 50 mg. N.	3	13	59	4	8

Further insight into the fate of ammonia in these digest experiments could only be gained by quantitative estimations of urea or of nitrogen content of an alcohol extract carried out at the end of incubation. Difficulty was found in extracting the evaporated filtrate obtained with the alcohol-ether mixture or amyl alcohol, as the addition of these at once made the residue very sticky, rendering satisfactory extraction impossible. Folin's method could not be used owing to the presence of considerable amounts of sugar in the organ extract. The same objection applies to Pfluger-Schöndorff's method. The second possibility as to the

fate of ammonia is rendered not unlikely by the extremely interesting work of Kowalevsky and Marchewicz²⁶ on the capacity of the tissue to remove an excess of ammonia from the blood. Both points are of extreme interest and importance in connection with the present research, and are now being further investigated. The results will be given in a later communication.

With regard to the amino acids investigated in the present experiments, it is quite evident that more ammonia is liberated from asparagin than from any of the others. Glycocoll is split to a considerable extent in the antiseptic tests, but only to a small extent in the aseptic tests. Leucin and alanin were used only in the aseptic tests; no ammonia was ever found to have been liberated from alanin, but small amounts were set free in some of the leucin tests. It is quite evident that the amide nitrogen attached to the carboxyl group of asparagin is more readily liberated than the amide nitrogen occupying the α position to the carboxyl group of the other amino acids and of asparagin itself.

Having considered the effect of various organ emulsions on amino acids with regard to deamidization, it is of interest to observe the behaviour of these amino acids in the living organism itself. How soon and to what extent does their nitrogen appear in the urine as urea?

Levene and Kober²⁷ fed a dog on a standard diet of low nitrogen value. When they added glycocoll to this diet they found that its nitrogen was removed from the body in the form of urea within twenty-four hours. Dr. Cathcart, in an investigation (not yet published) on the rate of absorption of digest products and simple amino acids from the small intestine, found also a very rapid excretion of the nitrogen, mostly as urea.

To carry out a somewhat similar experiment, a dog of 21.900 kilos was fed for some days on a diet consisting of 300 grs. meal and 500 c.c. milk, representing a caloric intake of 50 calories per kilo. On the four test days, which were separated by intervals of a few days, the bladder was emptied by catheter at 9.30 a.m. The urine was next collected by catheter at 10.30 a.m., and thereafter at intervals of two hours until 6.30 p.m.

On two test days 200 c.c. of water were given alone at 10.30 a.m., by means of the stomach tube. On the other two test days 10 grams of glycocoll and 10 grams of asparagin, respectively, dissolved in 200 c.c. of water, were given in a similar manner at 10.30 a.m. On all four days

the animal fasted. The distribution of total nitrogen ammonia and urea in the samples of urine thus obtained was investigated. The total nitrogen was estimated by Kjeldahl's method, the ammonia and urea by Folin's methods.

The results are detailed in Tables X and XI.

Table XI gives the total amount of urea nitrogen excreted in the eight hours following the ingestion of the 200 c.c. of water alone. The mean of this amount for the two fast days is subtracted from the amount of urea similarly excreted on the glycocoll and asparagin day respectively. In this way it is found that 96 per cent. of the ingested glycocoll nitrogen in the present experiment is excreted within eight hours in the form of urea, while 63 per cent. of the ingested asparagin is similarly excreted within eight hours. This result is in marked contrast with the results of the *in vitro* experiments, as in the latter ammonia is liberated more rapidly from asparagin than from glycocoll, whereas in the living organism glycocoll is apparently metabolised more rapidly than asparagin.

TABLE X

	Vol. of Urine	NH ₃ N gms.	Urea N gms.	Total N gms.	
Fast Day I—					
10.30—12.30 ...	95/100	0.06	0.386	0.578	
12.30— 2.30 ...	40/60	0.032	0.199	0.231	
2.30— 4.30 ...	70/80	0.033	0.419	0.532	
4.30— 6.30 ...	20/50	0.028	0.291	0.353	
		0.150	1.295	1.694	T.N. excreted within 8 hours after ingestion of 200 c.c. water at 10.30 a.m.
Glycocoll Day—					
10.30—12.30 ...	38/110	0.032	0.747	0.856	
12.30— 2.30 ...	40/100	0.026	0.910	0.988	
2.30— 4.30 ...	28/100	0.029	0.766	0.855	
4.30— 6.30 ...	22/100	0.029	0.709	0.781	
		0.116	3.132	3.480	T.N. excreted within 8 hours after ingestion of 10 g. Glycocoll in 200 c.c. water at 10.30 a.m.
Asparagin Day—					
10.30—12.30 ...	60/100	0.031	0.453	0.606	
12.30— 2.30 ...	62/100	0.026	0.589	0.758	
2.30— 4.30 ...	28/100	0.022	0.519	0.627	
4.30— 6.30 ...	26/100	0.021	0.501	0.562	
		0.100	2.062	2.553	T.N. excreted within 8 hours after ingestion of 10 g. Asparagin in 200 c.c. water at 10.30 a.m.
Fast Day II—					
10.30—12.30 ...	85/100	0.022	0.389	0.434	
12.30— 2.30 ...	45/100	0.017	0.344	0.383	
2.30— 4.30 ...	44/100	0.016	0.335	0.399	
4.30— 6.30 ...	23/100	0.007	0.280	0.305	
		0.062	1.348	1.521	T.N. excreted within 8 hours after ingestion of 200 c.c. water at 10.30 a.m.

TABLE XI

Nitrogen eliminated in 8 hours following ingestion of water

	NH ₃ N	Urea N	Resid. N	Total N	Urea in excess of fast days	Percentage of ingested N	Gms. N in 10 gms. amino acid added
Fast Day 1 ...	0.150	1.295	1.321	0.249	1.694	—	—
Fast Day 2 ...	0.062	1.348		0.111	1.521	—	—
Glycocoll Day ...	0.116	3.132	0.232	3.480	1.811	96	1.86
Asparagin Day ...	0.100	2.062	0.391	2.553	0.741	63	1.2

CONCLUSIONS

In agreement with Lang, it has been found that emulsions of liver and intestinal mucosa, when incubated with asparagin, glycocoll, leucin, or alanin, liberate ammonia except in the case of alanin, and that the total amount of ammonia so liberated is much greater in the case of asparagin than in that of glycocoll or leucin.

On the other hand, the presence of an antiseptic does not exert the marked inhibition of the deamidizing enzyme claimed by Lang, i.e., the fresh organ, incubated without an antiseptic, shows no striking increase in its deamidization of glycocoll.

There is a marked contrast between the fate of the nitrogen of asparagin and glycocoll, respectively, *in vivo* and *in vitro*. In the living organism the nitrogen of glycocoll appears practically quantitatively at the end of eight hours in the urine as urea, while only about 63 per cent. of the nitrogen of asparagin so appears in the same time.

In vitro, however, ammonia is liberated more quickly and in larger amount from asparagin than from glycocoll, i.e., *in vitro* the amide nitrogen attached to the carboxyl group is more readily liberated than the amide group in the α position.

Altogether the results of the investigation indicate that the method of studying the deamidizing action of the tissues adopted by Lang is by no means representative of the intravital changes in the body, and that far-reaching conclusions based upon them are not justified.

In conclusion, I wish to express my best thanks to Professor Noël Paton for much helpful advice, and to Dr. E. P. Cathcart, at whose instigation and under whose direction the research has been carried out. The work was begun during my tenure of a McCunn Scholarship.

REFERENCES

1. Howell, *Amer. Journ. Physiol.*, Vol. XVII, p. 273, 1906.
2. Michaud, *Zeit. f. physiol. Chem.*, Vol. LIX, p. 405, 1909.
3. Abderhalden and Terruchi, *Zeit. f. physiol. Chem.*, Vol. XLVII, p. 159, 1906.
4. Stollte, *Hof. Beit.*, Vol. V, p. 15, 1904.
5. Salaskin, *Zeit. f. physiol. Chem.*, Vol. XXV, p. 125, 1898.
6. Flatow, *Zeit. f. physiol. Chem.*, Vol. LXIV, p. 267, 1910.
7. Friedmann, *Bioch. Zeit.*, Vol. XXVII, p. 97, 1910.
8. Neubauer and Fischer, *Zeit. f. physiol. Chem.*, Vol. LXVII, p. 230, 1910.
9. Abderhalden, Bloch and Rona, *Zeit. f. physiol. Chem.*, Vol. LII, p. 434, 1907.
10. Neubauer, Otto and Falta, *Zeit. f. physiol. Chem.*, Vol. XLII, p. 81, 1904.
11. Jacoby, *Ziet. f. physiol. Chem.*, Vol. XXX, p. 149, 1900.
12. Loewi, *Zeit. f. physiol. Chem.*, Vol. XXV, p. 511, 1898.
13. Gonnermann, *Pfl. Archiv.*, Vol. LXXXIX, p. 493, 1902; Vol. XCV, p. 278, 1903.
14. Lang, *Hof. Beit.*, Vol. ~~VIII~~ ^V.
15. Furth and Friedmann, *Bioch. Zeit.*, Vol. XXVI, p. 435, 1910.
16. Shaklee and Meltzer, *Amer. Jour. Physiol.*, Vol. XXIII, 1908; Vol. XXIX.
17. Kruger and Reich, *Zeit. f. physiol. Chem.*, Vol. XXXIX, p. 165, 1903.
18. Grafe, *Zeit. f. physiol. Chem.*, Vol. XLVIII, p. 300, 1906.
19. Brasch, *Bioch. Zeit.*, Vol. XXII, p. 402, 1909.
20. Schryver, *Bioch. Jour.*, Vol. I, p. 123, 1906.
21. Fischer and Abderhalden, *Zeit. f. physiol. Chem.*, Vol. XLVI, p. 52, 1905.
22. Bergell and Brugsch, *Zeit. f. physiol. Chem.*, Vol. LXVII, p. 97, 1910.
23. Horodynski, Salaskin and Zaleski, *Zeit. f. physiol. Chem.*, Vol. XXXV, p. 246, 1902.
24. Cohnheim, *Zeit. f. physiol. Chem.*, Vol. LIX, p. 239, 1909.
25. Mendell and Leavenworth, *Amer. Jour. Physiol.*, Vol. XXI, pp. 67 and 95, 1908.
26. Kowalevsky and Marchewicz, *Bioch. Zeit.*, Vol. IV, p. 196, 1907.
27. Levene and Kober, *Amer. Jour. Physiol.*, Vol. XXIII, p. 325, 1909.
28. Levene and Meyer, *Amer. Jour. Physiol.*, Vol. XXV, p. 214, 1909.

NOTE ON THE ESTIMATION OF POTASSIUM IN URINE

BY H. H. GREEN, B.Sc., *Physiological Laboratory, Glasgow University.**Communicated by Dr. E. P. Cathcart**(Received June 9th, 1911)*

The purpose of this note is to direct attention to the method of estimating potassium by precipitation as the double cobalti-nitrite of sodium and potassium, $K_2NaCo(NO_2)_6 \cdot H_2O$ —a method useful, but apparently little used, especially in physiological work. Its advantages over the platinic chloride process are the greater rapidity, the shorter working time involved, and the very much lower cost. In point of accuracy it may, in ordinary practice, be made equal to the platinum method. Its special feature lies in the fact that the presence of sodium does not interfere, since the precipitant is itself a sodium salt. Salts of other metals do not in general interfere, and hence a troublesome preliminary separation is avoided. Further, the difficulty of separating the mixed chloroplatinates of sodium and potassium by washing with alcohol is well known, and the results obtained by the platinum method as usually conducted may well be high, owing to occlusion of Na_2PtCl_6 , which cannot be separated by extraction with alcohol, however long continued. The method of obviating this error by re-dissolving the K_2PtCl_6 in water and re-precipitating by evaporation is troublesome.

The first reference to the cobalti-nitrite reaction appears to be the discovery by Fischer¹ in 1849 that on adding a solution of potassium nitrite to a cobalt salt, an orange coloured double compound is precipitated. Fischer found that a cobalt salt of concentration so dilute as 1 in 3,000 was apparently completely precipitated on the addition of potassium nitrite. Amongst other workers who have investigated the reaction may be mentioned Erdmann², Sadtler³, de Koninck⁴, Curtman⁵, and Bülman⁶. Macallum⁷ in 1905, in a paper upon 'Potassium in cells,' gives a full

1. *Poggen, Annalen*, LXXIV, p. 124, 1849.
2. *J. pr. Chem.*, XCVII, p. 385, 1866.
3. *Amer. J. Sci.*, 2, XLIX, p. 189, 1870.
4. *Zeit. für annal. Chem.*, XX, p. 390, 1881.
5. *Berichte d. ch. G. Jahrg.*, XIV, p. 1951, 1881.
6. *Zeit. für annal. Chem.*, XXXIX, p. 284, 1900.
7. *J. Physiol.*, XXXII, p. 95, 1905.

discussion of the reagent, and uses the method with satisfactory results for histological purposes. The fact that ammonium compounds react with sodium cobalti-nitrite suggested the possibility of amino and amido compounds reacting similarly. On investigation, however, Macallum finds that neither glycine, leucine, tyrosine, aspartic acid, glutamic acid, sarcosine, nor glucosamine, precipitate and that therefore their presence in tissues presents no difficulty. Neither do urea, asparagine, alloxan, allantoin, guanidine, and the purin bodies react. Although creatinine does not react, creatine does so readily, giving a precipitate similar to that of potassium.

The first quantitative method of importance appears to be that of Adie and Wood⁸ in 1900. The reagent as prepared by them, and now in general use, is made as follows:—113 grams of cobalt acetate are dissolved in 400 c.c. of water, and 100 c.c. of glacial acetic acid added. 220 grams of sodium nitrite are separately dissolved in 400 c.c. of water, and the two solutions are then mixed with stirring, the last of the NO_2 evolved being removed by evacuation over night or by blowing air through the mixture. After standing at least twenty-four hours any sediment is filtered off and the solution made up to a litre. It will be found that the bulk is approximately a litre without the addition of water, and it is perhaps best not to dilute further. The reagent prepared in this manner is of a dark plum colour. It should be stored in the dark and decanted for use as required.

Adie and Wood describe both volumetric and gravimetric methods of determining potassium in soils and manures.

The precipitation is accomplished by adding 10 c.c. of the reagent and 1 c.c. of glacial acetic acid to 10 c.c. of the solution to be determined, which must be so arranged as to have a concentration of 0.5 to 1 per cent. K_2O . Adie and Wood found the most important factor in the precipitation to be the state of dilution—at 0.1 per cent. concentration of K_2O , only two-thirds of the theoretical amount of potassium was recoverable. They determine the formula of the precipitate as obtained by them under standard conditions as $\text{K}_2\text{NaCo}(\text{NO}_2)_6 \cdot \text{H}_2\text{O}$, and its solubility in water as 1 in 20,000.

Autenreith and Bernheim⁹ in 1902 described a method for the determination of potassium in urine, and so far as I have ascertained, this represents the only instance in which the use of the cobalt method

8. *J.C.S.*, II, p. 1076, 1900.

9. *Zeit. physiol. Chem.*, XXXVII, p. 29, 1902.

in the analysis of physiological products is recorded. Their method consisted in treating 50 c.c. of the filtered urine direct with 6 to 10 c.c. of the reagent, shaking, allowing to stand, and determining the potassium in the precipitate by subsequent conversion into the perchlorate. This method, however, is tedious, and it was determined to seek a shorter method. A direct treatment of the precipitate without conversion into the perchlorate does not give satisfactory results.

Drushel¹⁰ in 1907 published a modification of Adie and Wood's method in which the reagent was added to the solution to be estimated, and the mixture evaporated almost to dryness. The precipitate was then extracted, washed with water, and decomposed directly with standard potassium permanganate. The reaction involved in treating the precipitate, $K_2NaCo(NO_2)_6 \cdot H_2O$, with permanganate, is one of oxidation of the nitrite to nitrate and concomitant reduction of trivalent cobalt to the divalent form.

The method of dealing with the precipitate which I have adopted for physiological purposes is in essence that of Drushel. The process as carried out on urine is as follows:—

25 c.c. of the urine is evaporated to dryness in a platinum dish, and gently ignited at a dull red heat. The ash is then moistened with nitric acid and reignited until free from organic matter and *ammonium salts*. The use of nitric acid allows of easy ignition at a temperature sufficiently low to prevent any loss of potassium by volatilisation. The ash is then dissolved up in water containing a few drops of hydrochloric acid and washed into a porcelain basin (200 c.c. capacity). The solution is then neutralised or rendered slightly alkaline with a few drops of caustic soda, acidified with acetic acid, and evaporated to between 5 c.c. and 10 c.c. 1 c.c. of glacial acetic acid, and 10 c.c. of the reagent (prepared according to the recipe of Adie and Wood, *loc. cit.*) are then added, and the evaporation is continued until the resulting syrup is of such consistency as to set to a stiff hardish mass on cooling. The time taken for evaporation is rather less than an hour, but the stage of evaporation is readily fixed after a little practice.

The cold mass, consisting of the yellow precipitate, $K_2NaCo(NO_2)_6 \cdot H_2O$, imbedded in a dark purplish-brown matrix, is then worked up with about 50 c.c. of 10 per cent. acetic acid and allowed to soak (stirring up occasionally with a glass rod) until the yellow precipitate is

10. *Amer. J. Sci.*, XXIV, p. 433, 1907.

disentangled and the rest of the mass *completely* dissolved up to give the clear tawny colour of the dilute reagent. The yellow precipitate is then washed by decantation with dilute acetic acid, the washings being poured through an asbestos filter. Finally, the precipitate is transferred completely to the filter, washed with cold water, and sucked dry. In general, six washings by decantation are necessary, using in all about 300 c.c. of wash-liquid. From a mechanical point of view, the precipitate is easily washed and filtered, but it is somewhat difficult to completely wash free from the excess of reagent used. A funnel with a Gooch disc well packed with clean coarse Gooch-asbestos, makes a convenient filter. If any trouble is experienced by sucking through of the precipitate taking place, a second packed disc above the first ensures complete retention.

While the filtering of the precipitate is in process, about 300 c.c. of water is raised to boiling and the requisite excess (30 c.c. to 50 c.c. N/5) of potassium permanganate run in from a burette. The pad of asbestos with the precipitate is picked off the disc and dropped into the hot permanganate, any precipitate adhering to the funnel being also carefully washed in. The precipitate is stirred up, and after a few minutes dilute sulphuric acid, in amount required to react with the permanganate, is added (20 c.c. of 25 per cent. sulphuric acid). The contents are well stirred, replaced over the bunsen and kept at, or just below, the boiling point until the yellow precipitate is completely decomposed (about five minutes). Darkening of the liquid with formation of manganese hydroxide begins before the addition of sulphuric acid and continues on heating. Standard oxalic acid is then run in from a burette, with stirring, until the manganese hydroxide is dissolved and the hot liquid is clear and of a very faint rose pink colour. Care must be taken that any manganese hydroxide adhering to the glass and asbestos is completely dissolved up. The excess of oxalic acid is then titrated back to colour with permanganate, the end-point being sharply marked. The difference between the total permanganate and oxalic acid burette readings gives the amount of permanganate used, from which the amount of K_2O is calculated. The theoretical factor for N/5 potassium permanganate is 1 c.c. = 0.001714 grams K_2O . It is, however, preferable to standardise the permanganate accurately against a solution of pure fused potassium chloride, using the equivalent so found—by this means any slight constant errors are embodied in the standard, if the procedure adopted in standardisation be rigidly adhered to in all subsequent determinations.

Calculation is obviously saved if the standard permanganate and oxalic acid be made up so that 1 c.c. = 0.001 gram K_2O ; or, if more convenient, 1 c.c. = 0.002 gram K_2O . This latter concentration is a little over $N/5$ and 10 c.c. of a 1 per cent. solution of KCl used in standardisation then requires 31.6 c.c. of permanganate—a convenient burette reading on a convenient working quantity of precipitate.

In order to investigate the influence of other factors which have been said to interfere with the accuracy of the results, a series of a hundred determinations was made in which various foreign salts were added to the same quantity of potassium chloride solution. Quantities of sodium chloride, sodium phosphate, calcium chloride, calcium nitrate, magnesium chloride and magnesium sulphate, in amounts varying between wide limits were found not to seriously influence the results—in most cases the error was below 0.4 c.c. in a titrate of 32.6 c.c. of permanganate, i.e., the determination was accurate to about 1 per cent. The general conclusion is that it is unnecessary to first remove such foreign salts unless they are present in amount many times greater than the potassium itself. For practical purposes, the amount of salts other than those of potassium likely to be present in the ash of urine, may be ignored. Potassium was found to be estimable with equal accuracy in the form of chloride, sulphate, nitrate and acetate, provided that no free acid other than acetic was present during evaporation with the sodium cobalti-nitrite reagent. The quantity of reagent used was found to be of little consequence provided that large excess was taken. Theoretically 2 c.c. of the reagent is rather more than sufficient to precipitate the 10 c.c. of 1 per cent. KCl (= 0.0632 gram K_2O) used in standardisation. The 10 c.c. of reagent used therefore represents the necessary large excess. The colour of the filtrate from the washed precipitate should be the characteristic colour of the dilute reagent—a pink filtrate indicates decomposition, and estimations showing such should be repeated, using a larger excess of the reagent. The concentrated reagent itself, if stored in the dark, may be kept for a year, but the fresh reagent is always preferable. In sunlight, decomposition is more rapid. If diluted and exposed to light it quickly goes pink, indicating rapid decomposition. After the 'thick paste' stage of evaporation in the estimation, further heating should be avoided as the precipitate then becomes more difficult to extract, and results may be accordingly vitiated.

To test the accuracy of the method exactly as it is conducted upon

urine, an artificial urine (free from potassium) was made up of the following composition per litre:—

Urea	30.0	grams	
NaCl	12.0	„	
NH ₄ · Cl	3.0	„	
MgSO ₄	0.8	„	
CaCl ₂	0.5	„	
Na ₂ HPO ₄	5.0	„	
Glucose	5.0	„	(to simulate difficulty of ignition)

—the solution being acidified to keep the phosphates in solution.

20 c.c. of this solution plus 10 c.c. of a one per cent. solution of KCl were evaporated to dryness, ignited until free from ammonium salts, and treated exactly as in the process described for urines. 10 c.c. of the KCl solution alone required 32.4 c.c. of the standard permanganate used. The following table shows, to the first decimal place, six successive determinations in which the artificial mixture was present:—

No.	K ₂ Mn ₂ O ₈ burette	Oxalic acid burette	Difference = K ₂ Mn ₂ O ₈ used	c.c. error	Per cent. KCl recovered
1	42.6 c.c.	10.0 c.c.	32.6 c.c.	+ 0.2 c.c.	100.6
2	41.6	9.3	32.3	— 0.1	99.7
3	42.3	10.0	32.3	— 0.1	99.7
4	42.9	11.0	31.9	— 0.5	98.5
5	42.3	10.0	32.3	— 0.1	99.7
6	42.5	10.0	32.5	+ 0.1	100.3

Two estimations, adopting the method of wet combustion with sulphuric acid, removing the excess of sulphuric acid by evaporation over a low flame to avoid spattering, and subsequently removing the ammonium sulphate by ignition, gave 100.3 per cent. and 99.4 per cent. of potash recovered. The cobalti-nitrite method is obviously applicable to all physiological products after careful preliminary ashing to remove organic matter and ammonium salts.

Where sodium as well as potassium is to be estimated, the ash is dissolved up in dilute hydrochloric acid, and the foreign metals along with sulphate and phosphate removed by treatment with barium chloride and ammonium carbonate as in the ordinary preliminary treatment in the platonic chloride process—the 'NaCl+KCl' being weighed as such, and the sodium found by difference after the estimation of potassium.

Even at this stage great economy in time, labour and cost of material is effected.

The cobalt method, as here described, has been used with satisfactory analytical results (checked by comparison with the platinum method) in a series of experiments upon the mineral metabolism of the dog—a discussion of the results of which is reserved for a future date.

NOTE.—Since the work in this paper was completed, I have discovered a third paper by Drushel (*Amer. J. Sci.*, December, 1908) which had unfortunately been previously overlooked. He adapted his method for use on physiological fluids, and found it satisfactory.

The expenses of this investigation were defrayed by a grant made to Dr. Cathcart by the Carnegie Trustees.

It will be seen from the above that the freezing points of the haemolysed corpuscles were nearly the same as those of the unhaemolysed corpuscles, and therefore osmosis must have taken place to the same extent in the haemolysed as well as the unhaemolysed corpuscles. In other words, the unhaemolysed corpuscles are nearly as much permeable to water as the haemolysed ones. The fact that some of the corpuscles do not haemolyse must therefore be due to their being able to bear the tension of distension better than those that haemolyse. We may describe this resistance of the erythrocytes to rupture as their specific resistance. This specific resistance to rupture varies in different animals, and may be expressed by the relative haemoglobin value of their resistant erythrocytes.

In the following tables the erythrocytes were invariably suspended in 0.85 per cent. saline, and the amount of suspension taken was always half that of the dissolving fluid, which in the present case was distilled water.

Specific resistance of erythrocytes to rupture in different animals

1. Human blood	0.2934
2. Fowl's blood	0.1875
3. Dog's blood	0.3333
4. Frog's blood	0.7917
5. Sheep's blood	0
6. Rabbit's blood	0

Effect of evaporation on the resistance of erythrocytes to haemolysis

If we spread the erythrocytes, from a suspension of these in N/10 sodium chloride solution, over a slide and then allow them to dry gently, we find that these dried corpuscles when treated with N/10 sodium chloride solution completely dissolve. Let us consider what happens when the erythrocytes are drying on the slide. They tend to stick to the slide and, as evaporation goes on, they tend to contract. As a result of these two antagonistic processes there is, perhaps, rupture of their membranous structure, and they dissolve when they come in contact with what would be an isotonic solution in the case of undried erythrocytes. Their complete solution indicates complete disruption of their cellular framework in the process of drying up.

This complete disruption is, as just now stated, either purely mechanical due to rupture of all the membranous portions inside the erythrocytes that become adherent to the slide, or the removal of water during evaporation brings about a complete change in the chemical

constitution of the erythrocytes, converting them into particles soluble in a saline of any strength, just as a lump of sugar dissolves in water. This latter view best explains the complete solution of erythrocytes when treated with saturated solution of sodium chloride in water. In the process of desiccation of the erythrocytes by the saturated sodium chloride solution, water is removed from them. A portion of this water is perhaps in chemical combination with the erythrocytes, and this compound is broken up when they are allowed to dry up over a slide or are treated with saturated sodium chloride solution. Water, therefore, as it exists inside erythrocytes, is partly in a chemical combination with its structure, and

this compound may be expressed as $X \begin{matrix} \diagup H \\ \diagdown OH \end{matrix}$.

A CONTRIBUTION TO THE STUDY OF THE PROTEIN METABOLISM OF THE FOETUS. THE DISTRIBUTION OF NITROGEN IN THE MATERNAL URINE AND IN THE FOETAL FLUIDS THROUGHOUT PREGNANCY

By DOROTHY E. LINDSAY, B.Sc., *Carnegie Scholar.*

(*From the Physiological Laboratory, University of Glasgow*)

Communicated by Professor D. Noël Paton

(*Received June 12th, 1911*)

CONTENTS

- I. Preliminary.
- II. Methods.
- III. Distribution of nitrogen in the urine of adult herbivora.
- IV. Foetal fluids.
 - A. Relationship of total non-protein nitrogen content to growth of foetus.
 - B. Variations in the nitrogenous constituents throughout pregnancy.
 - C. Comparison of the early allantoic fluid with the adult urine and the indications afforded as to foetal metabolism.

I. PRELIMINARY

That the foetal fluids of the allantoic and amniotic sacs are mainly foetal urine may now be considered as definitely proved. Structurally the allantoic sac develops as part of the urinary bladder, while the urethra of the foetus early opens into the amniotic sac. This anatomical evidence is confirmed by the experimental work of Gusserow¹, Doderlein², D. Noël Paton³, and Bruno Wolff⁴.

Since chemical examination of the adult urine throws so much light on the processes of metabolism, it was hoped that the examination of the foetal fluids might help to reveal any characteristic differences between adult and foetal protein metabolism.

II. METHODS

The total nitrogen was determined by Kjeldahl's method; non-protein nitrogen by Kjeldahl's method after precipitating with an equal volume of trichloroacetic acid, the filtrate being tested and found not to give

the biuret reaction; ammonia by Folin's method; urea by the Mörner-Folin method; amino acids (including hippuric acid) and allantoin by an indirect method described by me⁵; amino acids (not including hippuric acid) by the formol titration method, hippuric acid being thus got by difference; creatinine and creatine by Folin's colorimetric method, using a Dubosq colorimeter.

In dealing with the amino acids in the adult urine, the large proportion of hippuric acid which herbivorous urines contain has to be considered. By the method for the estimation of amino acids described by me⁵ and used throughout this work, hippuric acid is estimated along with the other amino acids. It was therefore considered necessary to ascertain what proportion of this amino acid nitrogen was due to the presence of hippuric acid, what to the free monamino acids. To actually isolate hippuric acid is a long and troublesome process, and it is difficult to obtain satisfactory quantitative results. An indirect method was therefore sought for which might prove simpler. This was found in the formol titration method first proposed by Sørensen⁶, and later elaborated by Henriques and Sørensen⁷. This method gives the amino acids not including hippuric acid, as the glycine being linked to benzoic acid does not react with formol. It is clearly possible from the difference in the amino acid nitrogen determined by my method and that determined by titration with formol to ascertain the amount of hippuric acid nitrogen present, and this procedure I have adopted. More recently, Henriques and Sørensen⁸ have modified their method so that by it hippuric acid may be directly determined. The following table gives a comparison of the results got by the two methods:—

Hippuric acid difference method			Hippuric acid formol titration direct		
Mgrs. nitrogen per cent.	Per cent. total nitrogen		Mgrs. nitrogen per cent.	Per cent. total nitrogen	
20	=	7	21	=	7.4
36	=	15.7	30	=	13
99	=	34.9	99	=	34.9
15	=	2.1	12	=	1.6

Henriques and Sørensen also show that heating with hydrochloric acid and subsequent titration with formol provides a convenient method for the estimation of the nitrogen present as polypeptides and in the more complex compounds.

III. DISTRIBUTION OF NITROGEN IN THE URINE OF ADULT HERBIVORA

As a preliminary to the study of the distribution of nitrogen in the foetal fluids, an investigation of the urine of the adult was essential. I have been unable to find any complete examination of the distribution of nitrogen in the urine of herbivora, though several workers have investigated the occurrence of specific constituents. Salkowski⁹ made no detailed examination of nitrogen in herbivorous urines, but was concerned chiefly with the presence of oxalic acid in urines which had been kept for a long time, and thence with the occurrence of allantoin and hippuric acid. He found that hippuric acid was present in very considerable quantities. In one case, from a twenty-four hours' urine, he recovered 11·85 grams hippuric acid, containing about 12 per cent. of the total nitrogen present. By evaporation he obtained crystals of allantoin, which previous to this had not been found in cows' urines. Salkowski, however, says it is a normal constituent, the presence of which had probably been overlooked, as was the case with allantoin in the dog's urine.

The urines examined by me were got from sheep, oxen and cows at the slaughter-house. These animals are kept for a few days in the slaughter-house before being killed, so that the food given previous to the collection of the urines was approximately the same in each case. This food consists mostly of hay.

These examinations show that urea averages 83 per cent. of the total nitrogen; that allantoin is almost entirely absent; that the amino acids vary in amount, the variation being apparently mostly in the hippuric acid and probably depends on the amount of benzoic compounds in the food. They average 6·5 per cent. of the total nitrogen, of which more than half is hippuric acid. Creatinine averages 3 per cent. of the total nitrogen, creatine 1·9 per cent. The amount of creatinine is almost constant, but that of creatine varies considerably. The sex of the animals was not determined in the sheep.

These tables for the ox show a very marked difference between the urine of the male and of the female. In the urine of the bullock there is a much smaller proportion of amino acids, only 56 per cent. of which is hippuric acid, while in the cow nearly 90 per cent. is in this form. In the urine of the cow allantoin is present in considerable amounts, while in that of the bullock there is at most only a trace. Creatinine constitutes about 5 per cent. of the total nitrogen and creatine, which

SHEEP

TABLE I.—Sheep's urine
Grs. nitrogen in 100 c.c. urine

No.	Total nitrogen	Ammonia	Urea	Allantoin	Amino acid, including hippuric acid	Amino acid, not including hippuric acid	Hippuric acid	Nitrogen not in these	Creatinine nitrogen	Creatine nitrogen
I	1.708	0	1.412	—	0.140	—	—	0.114	0.038	0.004
II	1.709	0	1.421	0.036	0.058	—	—	0.135	0.044	0.015
III	1.964	0.054	1.686	—	0.164	0.051	0.113	0	0.078	0.075
IV	1.540	0.009	1.272	0	0.085	0.053	0.032	0.086	0.051	0.046

Percentage of total nitrogen

No.	Ammonia	Urea	Allantoin	Amino acid, including hippuric acid	Amino acid, not including hippuric acid	Hippuric acid	Nitrogen not in these	Creatinine nitrogen	Creatine nitrogen
I	0	82.5	—	8.4	—	—	6.7	2.2	0.2
II	0	83.1	2.0	3.6	—	—	7.8	2.6	0.9
III	2.6	84.5	—	8.4	2.5	5.9	0	3.9	3.7
IV	0.5	81.9	0	5.6	3.5	2.1	5.6	3.4	2.9

COW AND OX

TABLE III.—Bovine urine
Grs. nitrogen in 100 c.c. urine

No.	Total nitrogen	Ammonia	Urea	Allantoin	Amino acid, including hippuric acid	Amino acid, not including hippuric acid	Hippuric acid	Nitrogen not in these	Creatinine nitrogen	Creatine nitrogen
Cow	I 1.427	0.025	0.991	0.029	—	0.045	—	0.199	0.087	0.058
	II 0.707	0	0.490	0.037	0.117	0.022	0.095	0	0.053	0.010
	III 2.257	0.009	1.309	0.219	0.192	0.011	0.181	0.393	0.086	0.049
	IV 1.584	0.011	1.094	0.131	0.173	0.024	0.149	0.058	0.044	0.073
Ox	I 1.737	0.024	1.335	0.012	0.106	0.052	0.054	0.149	0.082	0.029
	II 1.491	0	1.213	0.004	0.076	0.025	0.031	0.065	0.053	0.060
	III 0.176	0.006	0.150	0	0.017	0.008	0.009	—	0.006	0.002
	IV 1.818	0	1.546	0.013	0.078	—	—	0.090	0.091	0

Percentage of total nitrogen

No.	Ammonia	Urea	Allantoin	Amino acid, including hippuric acid	Amino acid, not including hippuric acid	Hippuric acid	Nitrogen not in these	Creatinine Nitrogen	Creatine nitrogen
Cow	I 1.7	69.4	2.0	—	3.1	—	14.2	6.0	4.4
	II 0	69.0	5.4	16.9	3.0	13.9	0	7.4	1.5
	III 0.4	58.1	9.6	8.5	0.5	8.0	17.5	3.8	2.1
	IV 1.0	68.7	8.3	11.3	1.2	10.1	3.3	2.8	4.6
Ox	I 1.3	76.8	0.8	5.7	3.0	2.7	8.9	4.7	1.7
	II 0	81.2	0.4	6.4	1.7	4.7	4.6	3.4	4.0
	III 3.5	85.2	0	9.4	4.7	4.7	—	3.5	1.2
	IV 0	85.0	0.7	4.3	—	—	5.0	5.0	0

is generally present, is rather more abundant in the female than in the male.

Salkowski, who found allantoin in the urine of the cows he examined, maintained that it is a normal constituent, but suggested the possibility that it is present in the urine only of milch cows and not in that of bullocks. This occurrence of allantoin in the urine of the female—presumably in calf, as are most cows killed in the slaughter-house—suggested that there may be an absorption from the foetus through the maternal placenta of metabolic products which are excreted by the mother. But two or three observations which I have made as to the occurrence of allantoin in the urines of goats during the period of lactation, and after lactation had stopped, do not support this explanation.

The following are the results:—

				Grs. nitrogen in 100 c.c.		
I. Goat in milk—						
Urea nitrogen	1.654	=	70.0 % T.N.
Allantoin nitrogen	0.136	=	4.9 % T.N.
II. Goat in milk—						
Urea nitrogen	3.136	=	79.2 % T.N.
Allantoin nitrogen	0.152	=	3.9 % T.N.
III. Goat not in milk and not pregnant—						
Urea nitrogen	0.532	=	70.9 % T.N.
Allantoin nitrogen	0.063	=	8.4 % T.N.

These observations show that the amount of allantoin present is very considerable, the proportion of nitrogen in this form being almost the same as that found in the urine of cows.

It must therefore be concluded that the presence of allantoin in the urine of pregnant cows is not due to the excretion of foetal products by the maternal kidney but is a characteristic of the maternal metabolism. The larger amount of hippuric acid in the urine of the cow is probably due to the greater intake of benzoic compounds in hay, &c., during pregnancy.

In considering the relation of the foetal fluids to the adult urine the urine of the female is of the most direct importance.

These tables show that in the cow urea constitutes, on an average, 66 per cent. of the total nitrogen; that allantoin averages 6.3 per cent.; that the amino acids vary somewhat, but on an average amount to 9.8 per cent., and of these hippuric acid constitutes about 87.6 per cent.;

that creatinine averages 5 per cent. of the total nitrogen, and that creatine is generally present in considerable proportions.

The impossibility of fixing an absolute standard of normal urine renders it more difficult to determine the significance of variations in the distribution of nitrogen in the foetal fluids since, although these are primarily produced by the foetal kidney, their character may also be modified by the conditions of maternal metabolism.

IV. THE FOETAL FLUIDS

While both fluids are largely of the nature of foetal urine and the allantoic in its early stages entirely so, it is possible that some of the amniotic fluid may be formed from the membranes before the urethra opens, although the structure of the epithelium does not suggest a secreting function. It is further probable that exchanges take place between the two fluids during pregnancy. This question is considered by Noël Paton³, who indicated the factors which may determine the passage of water from the allantoin to the amnion and the diffusion of sugar and non-protein nitrogen in the same direction. The intermittent addition of foetal urine along with these would account for the increased volume of the amniotic fluid and also the increase in its non-protein nitrogen and sugar content.

The possibility of such exchanges between the two fluids complicates the interpretation of any changes which may occur in their chemical composition. But undoubtedly in its early stages the allantoic fluid is urine alone, and its composition may be safely accepted as giving an indication of purely foetal metabolism.

A. RELATIONSHIP OF THE TOTAL NON-PROTEIN NITROGEN IN THE FOETAL FLUIDS TO THE GROWTH OF THE FOETUS

Mere exchanges between the two fluids will not modify the sum of the metabolic products, and it is of interest therefore to determine whether there is any relationship between the waste nitrogen accumulated in these sacs and the growth of the foetus. Taking Noël Paton's figures for the sheep, as being more complete on this point than those of the present investigation, the following table shows that the waste nitrogen accumulates as the foetus grows, but that the nitrogen per unit of weight markedly decreases. The present observations show the same thing in the cow.

SHEEP			
Weight of foetus		Mean weight	Non-protein nitrogen per 1000 grs.
Below 15	...	8	9
30— 100	...	50	4
100— 300	...	230	2
300—1,000	...	420	1·1
Over 1,000	...	1,700	0·5

Cow			
Weight of foetus		Mean weight	Non-protein nitrogen per 1,000 grs.
100—1,000	...	400	1·7
1,000—2,000	...	1,731	1·0
2,000—4,000	...	3,475	0·9
4,000—6,000	...	4,800	0·7

This may be explained by the more active metabolism of the young and rapidly growing foetus in which all the tissues are protoplasmic and undergoing the active metabolism of growth, whereas later the living tissue of the foetus constitutes a smaller proportion of the body.

This decrease in the nitrogen excreted per unit of weight continues throughout infancy. Camerer shows that from the age of 1½ years this decrease is constant, gradually diminishing till at the age of 15 years the metabolism is the same per unit of weight as in the adult.

Another factor which may influence this decrease is the fact that as pregnancy advances, and the vascular connections between the mother and foetus through the placenta become more fully established, the placenta may more and more play the part of the foetal kidney.

The following table and diagrams show the relationship which exists between the sum of the products accumulated in both sacs and the weight of the foetus:—

TABLE V.—SHEEP

Nitrogen per 1,000 grs. of foetus

Weight of foetus	Non-protein nitrogen	Urea nitrogen	Allantoin nitrogen	Amino acid nitrogen
235	1·9	0·96	0·4	0·18
660	0·47	0·27	0·07	0·05
860	0·49	0·21	—	0·17
1,100	0·83	0·15	0·15	0·14
1,230	1·3	0·4	0·17	0·5
1,340	0·41	0·18	0·08	—
Full time	0·52	0·07	0·04	0·06

Cow

Nitrogen per 1,000 grs. of foetus

Weight of foetus	Non-protein nitrogen	Urea nitrogen	Allantoin nitrogen	Amino acid nitrogen
100	1·54	0·52	—	—
900	1·5	0·5	0·12	—
1,930	1·3	0·52	0·09	0·14
3,200	1·0	0·35	0·16	0·33
3,870	1·1	0·28	0·12	0·22
4,050	0·7	0·13	—	0·22
4,500	0·9	0·13	0·22	0·27
5,600	0·5	0·08	0·11	0·13

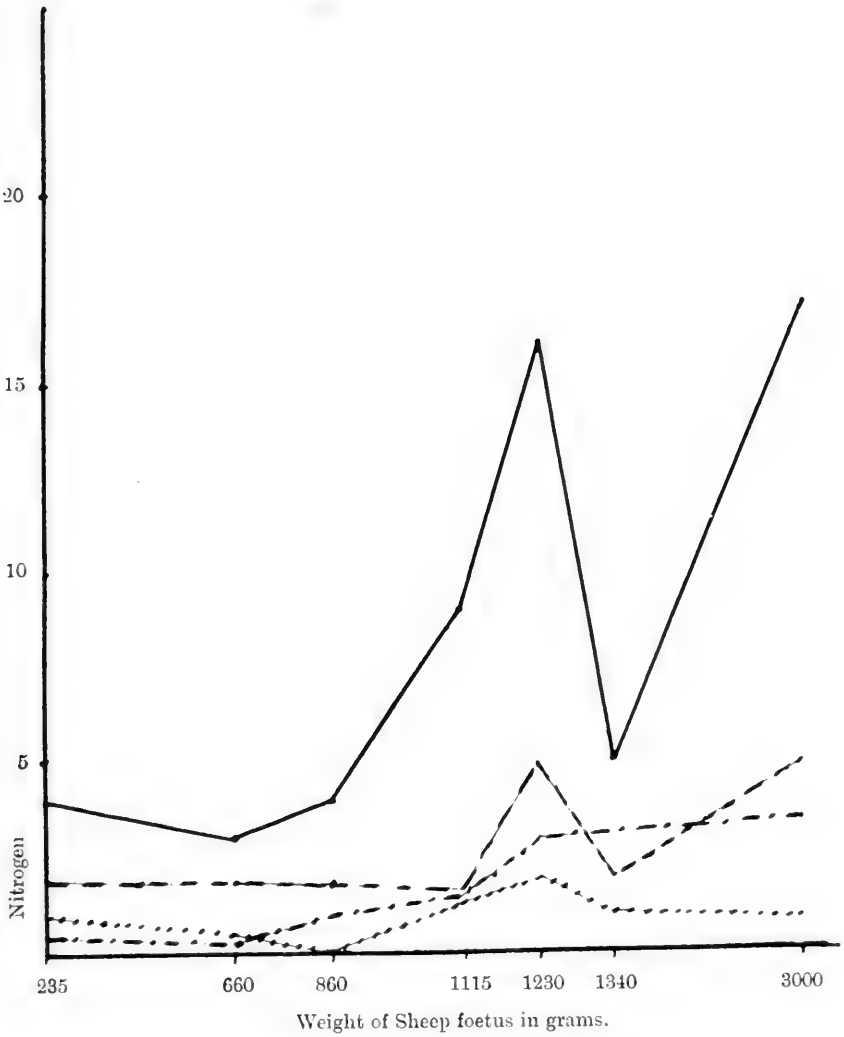

Non-protein nitrogen —————
 Urea " - - - - -
 Amino acid " - · - · -
 Allantoin " · · · · ·

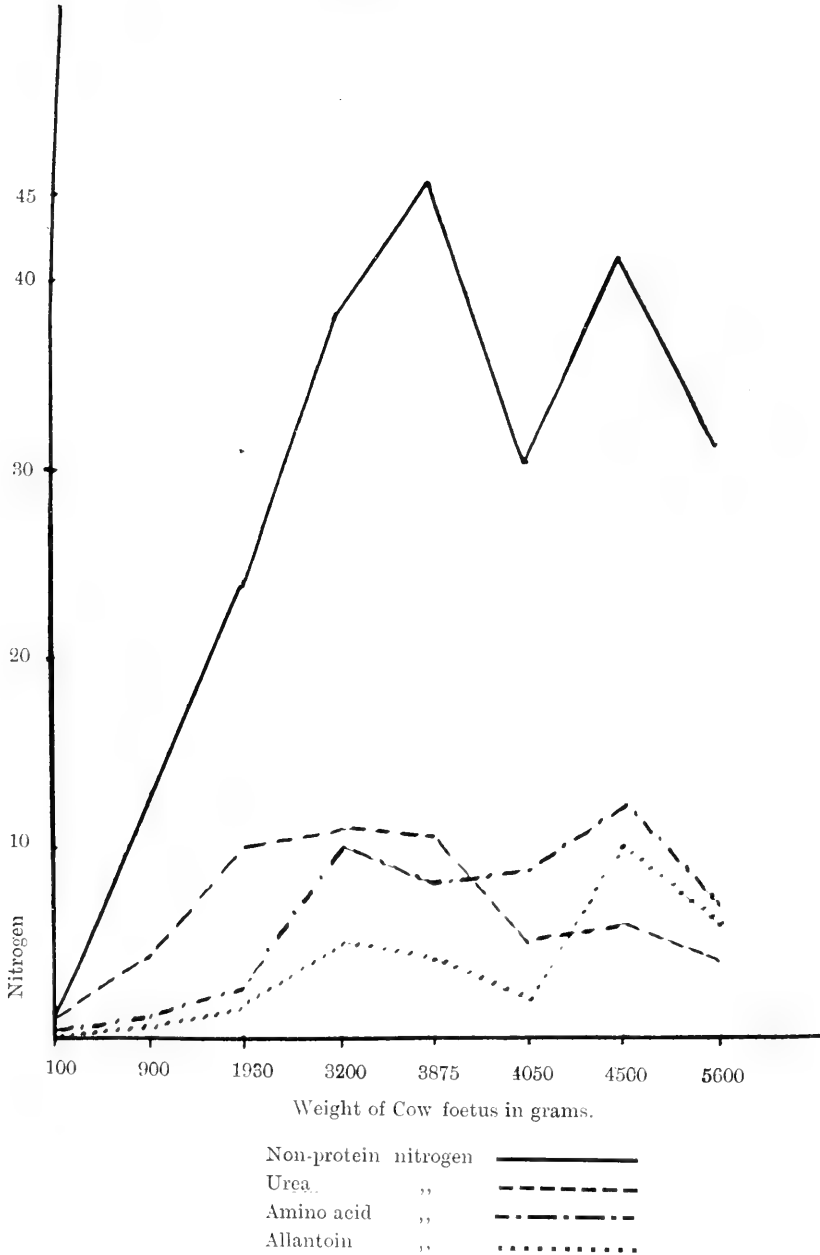

It will be seen that the nitrogen of the fluids varies directly with the weight of the foetus till about the middle of pregnancy. Allantoin shows a small but steady rise, but urea after about the middle of pregnancy decreases, its place being taken by the amino acids.

B. VARIATIONS IN THE NITROGENOUS CONSTITUENTS THROUGHOUT PREGNANCY

TABLE VI.—SHEEP ALLANTOIC FLUID

Mgrs. nitrogen per cent. of fluid									
Weight of foetus	No. examined	Total nitrogen	Non-protein nitrogen	Protein nitrogen	Urea	Allantoin	Amino acid including hippuric	Amino acid not including hippuric	Nitrogen not in these
200—1,000	4	140	123	17.5	43.0	16	32.0	7.0	44.0
1,000—1,350	4	236	209	27.2	30.2	28	66.3	19.5	96.6
Full time	4	299	289	10.5	58.6	36	76.0	30.0	115.0
Percentage of total non-protein nitrogen									
Weight of foetus	No. examined	Protein nitrogen per cent. of total nitrogen	Urea	Allantoin	Amino acid including hippuric	Amino acid not including hippuric	Nitrogen not in these	Urea	Protein nitrogen
200—1,000	4	14.3	33.3	20.3	18.5	7.5	31.4	20.3	14.3
1,000—1,350	4	8.8	15.2	12.4	31.7	10.8	42.1	12.4	8.8
Full time	4	4.6	21.6	12.3	26.7	14.7	40.2	12.3	4.6
AMNIOTIC FLUID									
Mgrs. nitrogen per cent. of fluid									
Weight of foetus	No. examined	Total nitrogen	Non-protein nitrogen	Protein nitrogen	Urea	Allantoin	Amino acid including hippuric	Amino acid not including hippuric	Creatinine nitrogen
60—300	4	33.5	31	2.5	20	2.0	6.0	6.0	0
300—1,000	3	37.0	34	3.0	22	3.6	2.5	7.3	0
1,000—1,350	3	67.0	55	12.0	37	8.3	7.0	7.0	1
Full time	4	94.0	80	14.0	72	2.0	6.0	6.0	—
Percentage of non-protein nitrogen									
Weight of foetus	No. examined	Protein nitrogen per cent. of total nitrogen	Urea	Allantoin	Amino acid including hippuric	Amino acid not including hippuric	Nitrogen not in these	Urea	Protein nitrogen
60—300	4	6.7	64.8	7.0	18.3	5.5	18.9	7.0	6.7
300—1,000	3	9.0	63.4	10.3	6.9	7.1	21.6	10.3	9.0
1,000—1,350	3	14.5	61.7	13.8	9.3	6.6	18.3	13.8	14.5
Full time	4	14.8	88.0	3.6	8.1	2.0	3.0	3.6	14.8

TABLE VII.—COW
ALLANTOIC FLUID

Weight of foetus	No. examined	Total nitrogen	Non-protein nitrogen	Protein nitrogen	Mgts. nitrogen per cent. of fluid			Creatinine nitrogen
					Urea	Allantoin	Amino acid including hippuric	
100—1,000	4	78.0	67	11.0	19.6	5.3	—	
1,000—4,000	5	172.6	168	4.2	37.0	17.4	5.5	
4,000—6,000	4	219.5	216	3.0	27.7	37.5	10.0	
Percentage of total non-protein nitrogen								
Weight of foetus	No. examined	Protein nitrogen per cent. of total nitrogen	Urea	Allantoin	Amino acid including hippuric			Creatinine nitrogen
					Amino acid including hippuric	Amino acid not including hippuric	Nitrogen not in these	
100—1,000	4	15.5	38.4	5.2	22.7	—	—	
1,000—4,000	5	2.4	22.7	10.2	26.9	25.3	2.6	
4,000—6,000	4	1.2	12.6	18.0	27.1	—	6.0	
AMNIOTIC FLUID								
Mgts. nitrogen per cent. of fluid								
Weight of foetus	No. examined	Total nitrogen	Non-protein nitrogen	Protein nitrogen	Amino acid including hippuric			Creatinine nitrogen
					Urea	Allantoin	Amino acid including hippuric	
100—1,000	2	20.5	19.5	1.0	1.0	—	—	
1,000—4,000	5	24.9	23.0	1.9	1.0	2.4	0.4	
4,000—6,000	3	35.6	26.0	9.6	11.6	6.3	—	
Percentage of total non-protein nitrogen								
Weight of foetus	No. examined	Protein nitrogen per cent. of total nitrogen	Urea	Allantoin	Amino acid including hippuric			Creatinine nitrogen
					Amino acid including hippuric	Amino acid not including hippuric	Nitrogen not in these	
100—1,000	2	5.0	63.0	5.2	12.3	—	—	
1,000—4,000	5	7.1	59.5	4.7	9.9	3.4	1.9	
4,000—6,000	3	27.7	42.8	16.3	25.4	—	—	

Urea nitrogen.—In the amniotic fluid the amount of urea present does not undergo any very marked variation with the advance of pregnancy, and the proportion it bears to the non-protein nitrogen shows a correspondingly small change, a slight decrease taking place towards the end of pregnancy. In the allantoic fluid the amount of urea is very much greater, but the proportion of non-protein nitrogen in this form is very much less than in the amniotic fluid and decreases markedly as the foetus increases in weight. This is true for both the cow and sheep, but the decrease in the proportion of urea nitrogen is much more marked in the allantoic fluid of the cow than in that of the sheep.

Allantoin nitrogen.—The amount of allantoin present in both amniotic and allantoic fluids is very considerable, but, as one would expect, is greater in the allantoic and shows a very marked increase towards the end of pregnancy. In both fluids of the cow the proportion is about the same, and in the later stages of development about three times what it was at the beginning. This increase in the proportion is less well marked in the amniotic fluid of the sheep, and is not found in the allantoic fluid of the sheep.

Amino acid nitrogen (including hippuric acid).—In the allantoic fluids, both of the sheep and cow, the amino acids are abundant, especially towards the middle of pregnancy. The increase in the amount is very rapid in the first half of pregnancy, and becomes slower as the foetus increases in weight. The allantoic fluid of the cow shows little change in the proportion of amino acid nitrogen with the advance of pregnancy, but in the amniotic there is a distinct rise in the later stages. The fluids of the sheep, on the contrary, show a slight increase in the proportion of amino acid nitrogen in the allantoic and in the amniotic very little change.

Hippuric acid nitrogen.—The presence of large amounts of hippuric acid in the adult urine renders it interesting to note the evidences of its presence in the foetal fluids. Gusserow¹ found that the injection of benzoic acid into the maternal circulation caused the appearance in the fluids of hippuric acid, not of benzoic acid, and from this argued that the foetal fluids were formed in the foetal kidneys. In the allantoic fluid of the sheep there is a considerable increase of hippuric acid as pregnancy advances, both absolute and proportionate, but in the amniotic fluid the reverse appears to be the tendency.

Creatine and Creatinine nitrogen.—In the allantoic fluid of the cow, in which most determinations have been made, both creatine and

creatinine are present in very nearly equal amounts, and they apparently increase with the weight of the foetus. In the amniotic fluid creatinine is absent, but creatine is present in small amounts. In the amniotic and allantoic fluids of the sheep no creatinine could be found, but a trace of creatine is present in the later stages of pregnancy.

Ammonia nitrogen.—This was absent in every case examined.

The chief points to be noted in regard to these fluids are—the large amount of amino acids, the presence of allantoin in considerable amount, and the large amount of undetermined nitrogen, i.e., nitrogen not in any of the above substances. In all these points the fluids differ from the adult urine.

Nitrogen not in these substances.—Perhaps the most interesting point is the very high proportion of nitrogen not in any of the ordinary urinary constituents of the adult. In the adult urine, 8·8 per cent. in the cow, 6·0 per cent. in the sheep, of the total nitrogen is in compounds other than those determined. In the early allantoic fluid the proportion in the cow is 24·6 per cent., in the sheep 31·4 per cent., figures which correspond approximately to the difference between the total non-protein nitrogen and that in the phosphotungstic acid filtrate. This large amount of undetermined nitrogen was also observed by Noël Paton, who used either the Morner Sjöqvist method for urea determination or the Bohland methods, which gave quite comparable results. The nature of this I have been able only partially to elucidate. It occurs altogether in the phosphotungstic acid precipitate, and is therefore probably mainly of the nature of polypeptides and diamino acids. Trichloroacetic acid was used to remove the protein, and lower proteins and peptones may therefore be excluded since the filtrate from the trichloroacetic acid gave no biuret reaction.

The possibility that the protein metabolism of the foetus had not gone beyond the stage of chains of amino acids was considered, and the amount of peptide nitrogen was estimated. The method used was that of Henriques and Sørensen⁸.

				SHEEP	
				Polypeptide nitrogen	Still undetermined
				per cent.	per cent.
Allantoic	XIII	7·9	35·9
	XV	0·6	38·9
	XVII	13·9	23·6
Amniotic	XIII	Doubtful	17·7
	XVII	0	4·6
	XVIII	7·6	— 2·1
Cow					
Allantoic	XV	12·3	15·8
Amniotic	XIV	6·9	24·2

The peptide nitrogen is quite insufficient to account for more than a small proportion of the undetermined nitrogen. I therefore investigated the nitrogen in the phosphotungstic acid precipitate. The precipitate was decomposed by means of barium carbonate and hydrate, the excess of barium removed with carbon dioxide, and silver nitrate added. The precipitate thus obtained probably consists mainly of the silver salts of the diamino acids.

		Cow			
		Silver precipitate nitrogen		Still undetermined	
		per cent. non-protein nitrogen		per cent. non-protein nitrogen	
Allantoic	X	17.9	14.3
	VII	19.0	26.0
Amniotic		9.4	24.0
				3.5	0.1

Diamino acids are thus seen to be present. The purin nitrogen is quite negligible in amount, and hence the conclusion seems to be that *nitrogenous compounds which are not products of metabolism in the adult are present in the early urine of the foetus*. Their nature will require further investigation.

C. COMPARISON OF THE EARLY ALLANTOIC FLUID WITH THE ADULT URINE

A comparison of the early allantoic fluid with the adult urine is of especial importance, since the former gives undoubted evidence as to the nature of purely foetal metabolism.

		Cow						
		Urea	Allantoin	Amino acid. including hippuric	Amino acid. not including hippuric	Creatinine	Creatine	Nitrogen not in these
Early allantoic	...	38.4	5.2	22.7	—	—	—	24.6
				26.9	25.3	4.6	2.6	
Adult urine	...	66.3	6.3	12.7	1.9	5.0	3.2	8.8
		SHEEP						
Early allantoic	...	33.3	20.3	18.5	7.5	—	—	31.4
Adult urine	...	83.0	?	6.5	3.0	3.0	1.9	6.7

These results for the allantoic fluids of the cow and sheep are fairly concordant and show:—

1. A small proportion of urea nitrogen in both.
2. A large proportion of allantoin in the sheep, but not in the cow,

in which the increase of allantoin occurs later and coincides with an increase in the allantoin of the amniotic fluid.

3. A high proportion of amino acids other than hippuric acid. The figures for the earliest stage in the cow are unfortunately wanting, but the fact that in the next period the total amino acids were almost the same, and consisted almost entirely of acids other than hippuric—26·9 of amino acids including hippuric corresponding to 25·3 per cent. of amino acids not including hippuric acid—justifies the conclusion that in the early stages, too, a high proportion of amino acids is present.

4. In the cow creatine and creatinine were present in considerable amounts in the second stage of gestation—amounts very similar to those of the adult urine. In the sheep the result is more doubtful.

5. The undetermined nitrogen was high for both sheep and cow, and consisted in part probably of diamino acids and polypeptides.

6. The picture of foetal metabolism thus shown by the chemical composition of the early allantoic fluid is one of low deamidizing power as indicated by the low urea and ammonia output and by the high proportion of amino acids. Since the purines are practically absent, the allantoin may be held to represent the purin metabolism. Its presence in the early urine of the cow in amounts similar to that of the adult probably indicates that the nuclear metabolism is already established in its normal course.

The amniotic fluid throughout resembles the adult urine more closely than does the allantoic. Possibly this is because it is a later foetal urine, and occurs when fuller placental development is masking the purely foetal metabolism by the passage of maternal excretory products.

SUMMARY

1. Certain differences are shown to exist between the distribution of nitrogen in the urine of the bullock and of the cow. The urine of the cow contains a large amount of allantoin and of hippuric acid. In the bullock's urine the amino acid content is much smaller and contains a much smaller proportion of hippuric acid, while allantoin is almost entirely absent.

2. There is an increase in the amount of non-protein nitrogen in the foetal fluids throughout the first half of pregnancy. But the amount of nitrogen per unit of weight of the foetus decreases regularly.

3. The foetal fluids are shown to contain the ordinary urinary constituents of adult urine—urea, allantoin, monamino acids, creatinine, creatine, with, in addition, small amounts of polypeptide nitrogen, nitrogen in diamino acids, and nitrogen in compounds which are not found in the adult urine, and the nature of which has not so far been elucidated.

4. Variations in the distribution of nitrogen in the foetal fluids throughout the course of pregnancy exist, which, in the main, consist of a decrease in the proportion of urea nitrogen with a corresponding increase in the proportion of allantoin and amino acid nitrogen.

5. A study of the early allantoic fluid—the urine of the early foetus—shows, as compared with the adult urine, a low urea content, a high proportion of allantoin and amino acids, and a large amount of undetermined nitrogen.

6. It is therefore concluded that the foetal metabolism differs from that of the adult in the less complete catabolism of the protein and in the greater activity of nuclear metabolism as indicated by the amount of allantoin.

I take this opportunity of acknowledging my deep indebtedness to Professor Noël Paton, under whose guidance this work has been done, for much help and criticism.

REFERENCES

1. Gusserow, *Arch. f. Gyn.*, III, 1872.
2. Doderlein, *Arch. f. Gyn.*, XXXVII, p. 141, 1890.
3. D. Noël Paton, *Trans. Roy. Soc. Edin.*, XLVI, p. 71, 1907.
4. Bruno Wolff, *Arch. f. Gyn.*, LXXXIX, p. 177, 1909.
5. D. E. Lindsay, *Bio-Chem. Journ.*, IV, p. 448, 1909.
6. Sørensen, *Biochem. Zeitsch.*, VII, p. 47, 1908.
7. Henriques and Sørensen, *Ztsch. f. phys. Chem.*, LX, p. 1, 1909.
8. Henriques and Sørensen, *Ztsch. f. phys. Chem.*, LXIII, p. 28, and LXIV, p. 120.
9. Salkowski, *Ztsch. f. phys. Chem.*, XLII, p. 212.

APPENDIX GIVING DETAILED RESULTS—NINE OBSERVATIONS

Cow

ALLANTOIC FLUID

No.	Total nitrogen	Non-protein nitrogen	Protein nitrogen	Mgns. nitrogen per cent. of fluid				Creatinine nitrogen	Creatinine nitrogen	Creatine nitrogen
				Urea	Allantoin	Amino acid, including hippuric	Amino acid, not including hippuric acid			
IX	59	46	13	—	0	3	—	—	4	—
V	33	26	7	19	5	25	—	—	25	—
I	78	74	4	19	11	—	—	—	—	—
XIII	148	126	22	26	16	17	—	—	74	—
IV	139	133	6	59	3	50	—	—	45	—
II	157	157	0	35	27	53	47	—	45	—
XIV	168	160	8	29	24	84	48	—	93	8
XV	237	230	7	36	17	33	—	—	76	3
III	162	162	0	17	17	69	—	—	111	13
XII	243	231	12	35	17	46	—	—	50	7
X	156	156	0	21	39	46	—	—	85	—
VII	189	189	0	17	40	47	—	—	128	—
VI	290	290	0	38	54	70	—	—	—	—

II—Cow

ALLANTOIC FLUID

No.	Weight of foetus	Volume in c.c.	Total nitrogen in total fluid	Non-protein nitrogen, grs. nitrogen in total fluid	Protein nitrogen per cent. total nitrogen	Urea	Allantoin	Amino acid, including hippuric acid	Nitrogen not in these	Creatinine nitrogen	Creatine nitrogen	Per cent. of non-protein nitrogen	
												Amino acid, including hippuric acid	Nitrogen not in these
IX	100	90	0.053	0.041	20.8	—	—	—	—	—	—	15.4	—
V	150	250	0.082	0.065	21.3	73.0	0	—	—	—	—	33.8	—
I	435	550	0.431	0.407	5.2	25.6	6.8	—	—	—	—	—	—
XIII	900	800	1.151	1.012	14.9	16.7	8.7	—	—	—	—	—	—
IV	1,930	1,090	1.514	1.45	4.4	19.5	12.0	—	—	—	—	—	—
II	2,012	540	0.847	0.847	0	37.5	1.9	—	—	—	—	—	—
XIV	3,200	1,970	3.309	3.144	4.8	21.9	16.6	—	—	—	—	—	—
XV	3,350	550	1.301	1.265	3.0	12.6	10.4	—	—	—	—	—	—
III	3,875	2,550	4.13	4.13	0	10.3	10.3	—	—	—	—	—	—
XII	4,050	1,250	3.041	2.887	5.0	22.4	10.3	—	—	—	—	—	—
X	4,500	2,510	3.936	3.936	0	15.1	7.4	—	—	—	—	—	—
VII	5,100	1,815	3.43	3.43	0	13.3	25.0	—	—	—	—	—	—
VI	5,600	985	2.854	2.854	0	9.0	21.1	—	—	—	—	—	—
						13.1	18.6	—	—	—	—	—	—

III—Cow

AMNIOTIC FLUID

Mgrs. nitrogen per cent. of fluid

No.	Total nitrogen	Non-protein nitrogen	Protein nitrogen	Urea	Allantoin	Amino acid including hippuric acid	Amino acid not including hippuric acid	Nitrogen not in these	Creatinine nitrogen	Creatine nitrogen
IX	21	21	0	9	1	4	—	7	0	0.4
XIII	20	18	2	15	1	1	—	1	—	—
XI	15	14	1	10	0	0	—	5	—	—
IV	29	28	1	20	0	3	—	5	—	—
II	23.5	23	0.5	14	2	6	—	1	0	0.4
XIV	34	29	5	19	0	1	1	9	0	—
III	23	21	2	7	3	2	—	9	—	—
XII	41	28	13	16	3	3	—	1	—	—
X	39	32	7	14	1	7	—	10	—	—
VI	27	18	9	5	7	4	—	2	—	—

IV—Cow

AMNIOTIC FLUID

Per cent. of non-protein nitrogen

No.	Weight of foetus	Volume in c.c.	Total nitrogen in total fluid	Non-protein nitrogen, grs. total fluid	Protein nitrogen per cent. total nitrogen	Urea	Allantoin	Amino acid including hippuric acid	Amino acid not including hippuric acid	Nitrogen not in these	Creatinine nitrogen	Creatine nitrogen	Poly-peptide nitrogen
IX	100	530	0.112	0.112	0	42.8	4.8	19.0	—	33.4	0	1.9	9.4
XIII	900	1,935	0.401	0.347	10.0	83.3	5.6	5.6	—	5.6	—	—	—
XI	1,250	3,280	0.505	0.459	6.7	66.6	0	0	—	33.4	—	—	—
IV	1,930	3,400	1.004	0.966	3.5	71.4	0	10.7	—	17.9	—	—	—
II	2,013	2,890	0.679	0.665	2.0	60.8	8.7	26.1	—	4.4	0	2.6	—
XIV	3,200	2,400	0.816	0.706	14.8	65.5	0	3.4	3.4	31.1	—	—	6.9
III	3,875	1,900	0.429	0.391	8.7	33.3	14.3	9.5	—	42.9	—	—	—
XII	4,050	430	0.178	0.120	31.8	57.1	7.1	32.2	—	3.6	—	—	3.5
X	4,500	620	0.246	0.201	18.0	43.7	3.1	21.9	—	31.3	—	—	—
VI	5,600	1,590	0.432	0.285	33.4	27.7	38.9	22.2	—	11.2	—	—	—

A PRELIMINARY STUDY OF THE BIO-CHEMICAL
RELATIONS OF VARIOUS LIPOID SUBSTANCES IN
THE LIVER

BY FREDERICK P. WILSON, M.Sc., M.D., *Beit Memorial Research
Fellow.*

(Received June 28th, 1911)

The discovery of Landsteiner, Müller and Pötzl that an alcoholic extract of human or animal liver could be used as an antigen, shed quite a new light on the Wassermann reaction. The idea that this reaction was of the same nature as the typical Bordet-Gengou phenomenon had to be abandoned. An enormous amount of work on the subject at once followed, and it was shown that the test could be performed with extracts of other organs, as well as with substances such as lecithin, cholesterin, bile salts and phosphatides from different organs.

Further, it was found that the antigenic properties of these substances varied considerably, and their suitability for use was still further modified by other factors, such as their haemolytic properties. While most workers with the Wassermann reaction have been content to use alcoholic extracts of liver or heart of varying composition, which were rejected if they possessed undesirable properties, others have made efforts to apply substances of more or less definite nature and free from the most objectionable features such as the presence of protein or haemolytic bodies. These have chiefly been lecithides obtained from various organs. Browning used a lecithin obtained by digesting a heart with ethyl acetate at 60° C., precipitating with acetone, and further purifying by repeatedly taking it up with ether and precipitating with acetone. He found that the antigenic powers of such a lecithin are increased by the addition of cholesterin.

Noguchi has advocated the use of a lecithin obtained by treating a liver or heart with warm alcohol, evaporating the extract to dryness by means of a current of air at 37° C., and treating this repeatedly with ether to separate the ether-soluble substances. The ether-soluble portion is evaporated, then dissolved with a little ether and precipitated with water-free acetone. It is this acetone-insoluble fraction which Noguchi has recommended for use as antigen.

Recently, Noguchi and Bronfenbrenner have published the results of an investigation into the antigenic, anti-complementary, and haemolytic properties of the different ether and acetone soluble and insoluble fractions obtained in the above process. The livers were chiefly derived from human beings who had suffered from various disorders, but, in addition, the livers of animals were also examined. The iodine values of the acetone-insoluble fractions were determined, and an attempt made to associate these with the antigenic properties and the clinical conditions. These investigators found that the most satisfactory antigenic properties were shown by the acetone-insoluble fractions and that, speaking generally, a high antigenic value in these fractions was associated with a high iodine value. This group consists chiefly of phosphatides.

Some recent workers on lipoids, such as Erlandsen and Maclean, have thought that under certain conditions part of these bodies might be in a free state in the tissues, and the rest combined with other tissue elements from which they might be separated by suitable treatment. The present investigation was undertaken with the object of ascertaining the haemolytic and anti-complementary properties of extracts obtained by the method used by these workers.

The tissue was first extracted with ether, then with cold alcohol, and finally with hot alcohol. From these three main extracts further fractions were separated by evaporation and precipitation with acetone. If the amount of material in each fraction sufficed, the saponification and iodine values were worked out.

METHOD OF PREPARATION

A pig's liver, obtained immediately after the slaughter of the animal, was passed through a mincing machine, and then spread out on glass plates and dried under a fan at 30° C. The dried mass was passed through a coffee mill and the resulting fine powder thoroughly dried *in vacuo* over H₂SO₄.

The tissue was then extracted with ether in a shaking machine for three or four hours and rapidly filtered. This was repeated four times till the addition of acetone caused only a very faint cloudiness. This extract was carefully preserved in a stoppered bottle in the ice-chest.

The residue of the tissue was then repeatedly treated with cold absolute alcohol in a similar manner, and the extract preserved. Finally,

the tissue was extracted with hot absolute alcohol until practically no more acetone-insoluble material could be obtained.

Three different extracts were thus obtained, which were treated in the following manner:—

Ether-soluble Extract.—The ether was distilled off at 40° C. until the extract had a syrupy consistency. Excess of acetone was now added, when a brownish-yellow mass separated out. The residual fluid was filtered and a clear yellow fluid obtained which, on evaporation under the fan, gave a greasy-looking yellow substance. These two fractions were preserved over H_2SO_4 *in vacuo*.

Cold Alcohol Extract.—Evaporation under the fan yielded a grayish greasy-looking substance. This was thoroughly extracted with ether and two fractions thus obtained—one ether-soluble and the other ether-insoluble. The former was further separated into an acetone-soluble portion of white colour, and a brownish acetone-insoluble one. Only very small amounts of these two fractions were obtained, as most of the cold alcohol extract seemed to be insoluble in ether, and was obtained as a light brown tenacious substance.

Hot Alcohol Extract.—On leaving this in the ice-chest over night, a small quantity of a brownish-yellow substance was deposited. This was insoluble in hot alcohol, but partly soluble in ether, from which a white precipitate was thrown down by acetone. This acetone precipitate was found to contain a fair amount of phosphorus. The rest of the hot-alcohol extract was evaporated until a dark brown sticky mass was left. This was treated in a similar manner to the cold alcohol extract. The ether-soluble fraction thus obtained was very small in amount and was practically all soluble in acetone. The various fractions thus obtained were preserved over H_2SO_4 in exhausted amber-coloured desiccators, and their haemolytic and anti-complementary properties tested as soon as possible

Preparation of Emulsions.—In each case the emulsion was prepared by dissolving 0.025 gram of the substance in a little warm absolute alcohol, and slowly adding 5 c.c. of a 0.9 per cent. solution of sodium chloride.

Determination of the Haemolytic Property.—Increasing dilutions of the emulsions were made with 0.9 per cent. saline solution. Four parts of each of these dilutions were mixed in a series of test-tubes with one part of a 20 per cent. suspension of washed human red blood corpuscles. The tubes were placed in a water bath at 37° C., and the

result noted after incubation for two hours. The figures in the accompanying table denote the weakest emulsion which produced haemolysis.

Determination of the Anti-complementary Property.—The technique used for this purpose was that advocated by D'Este Emery. This worker has pointed out in his Hunterian Lecture that all sera will give some absorption of complement if the extract be strong enough, and that the difference in the powers of absorption between normal and syphilitic sera is only one of degree. He claimed that for standardizing an extract it was better to use normal sera, as these are very much more constant than syphilitic ones, which vary over a wide range. This plan has been adopted in the present investigation, and the absorptive powers of the extracts tested against normal sera.

Progressing dilutions of each emulsion were placed in a series of small test-tubes and mixed with fresh normal human serum in the proportion of four parts of the former to one of the latter. The tubes were then placed in a water-bath at 37° C. for half an hour. To each tube was now added one part of a 20 per cent. suspension of sensitized human red blood corpuscles, which had previously been saturated with an excess of an appropriate dilution of anti-human rabbit serum. By using this technique of D'Este Emery a very minute amount of unabsorbed complement may be detected. Moreover, the time taken up is very much lessened, as haemolysis occurs very rapidly when there is any free complement, and when absorption has been complete the agglutination of the corpuscles enables the result to be read off in a very short time. The figures in the chart denote the weakest dilution which gave complete absorption.

Fraction		Saponification value	Iodine value	Haemolytic property	Anti-complementary value
Ether-soluble—					
1.	Acetone-soluble	190.5	106.5	2	2
2.	Acetone-insoluble	252	92.4	4	72
Cold alcohol—					
1.	Entire	246.4	28.4	9	22
2.	Ether-insoluble	285.5	16.9	8	5
3.	Ether-soluble—				
	(a) Acetone-soluble	—	47.5	5	38
	(b) Acetone-insoluble		Amount insufficient.		
Hot alcohol—					
1.	Entire	266	54	8	6
2.	Ether-insoluble	257	9.1	7	31
3.	Ether-soluble—				
	(a) Acetone-soluble	—	32.2	5	20
	(b) Acetone-insoluble		Amount insufficient.		

CONSIDERATION OF RESULTS

Saponification Values.—In the cases where sufficient material was obtained to estimate them, there was not much variation in the saponification values, except in the acetone-soluble fraction of the ether extract which was somewhat lower than the others. This may have been due to its containing fats of a higher molecular weight or to the presence of cholesterin.

Iodine Values.—The ether extract showed the greatest degree of unsaturation; the acetone-soluble fraction, as might be expected, giving the highest iodine value. The other extracts gave considerably lower values; that of the cold alcohol being about half the hot alcohol figure. No relation between the iodine value and the haemolytic property could be established. The fact that the acetone-soluble fraction of the ether extract, with its high iodine value, was practically non-haemolytic may have been due to the presence of cholesterin.

Haemolytic Property.—The fractions derived from the ether extract had a much weaker haemolytic action than those of the other extracts, which did not differ much from each other.

Anti-complementary Property.—Great differences were manifested by the various fractions in this respect. The acetone-soluble portion of the ether extract had practically no power of absorbing complement. On the other hand, the acetone-insoluble fraction possessed this property to a very high degree, in fact, was two and a half times stronger than the next highest fraction. A curious difference was shown by the cold and hot alcohol extracts, and the fractions obtained from them. While the entire cold alcohol extract gave a value of 22, and the hot alcohol a value of 6, the ether-insoluble fraction of the latter yielded a value of 31 against a value of only 5 by the ether-insoluble fraction of the former. The acetone-soluble fractions of the ether-soluble portions of both cold and hot alcohol extracts possessed very fair powers of absorbing complement, but, as mentioned above, were much inferior to the acetone-insoluble portion of the ether extract.

It was unfortunate that the amount of liver originally used was insufficient to yield enough acetone-insoluble portions of the cold and hot alcohol extracts to perform the tests. The greatest amount of material was obtained from the ether extract, which also contained a large quantity

of acetone-insoluble substances. Very small amounts of the cold and hot alcohol extracts were soluble in ether, and the greater part of what was soluble was also soluble in acetone.

CONCLUSIONS

1. The acetone-insoluble fraction of the ether extract yields the most suitable antigen.
2. The cold and hot alcohol extracts yield substances differing from each other and from the ether extract in physical and bio-chemical properties.
3. These differences are apparently not dependent on the saponification or iodine values.

THE ACTION OF SELENIUM SALTS ON RED BLOOD CORPUSCLES

By CHARLES O. JONES, M.D., M.Sc., M.R.C.S.

From the Bio-Chemical Laboratory, University of Liverpool

(Received June 29th, 1911)

While investigating the action of selenium salts, it was noticed that there was produced a marked effect on the red blood corpuscles, and as the action appeared to be an haemolytic one, this work was undertaken to investigate its action.

As was shown in the paper referred to, the soluble salts are reduced in the body by some reducing substance, in this case probably glucose, and the insoluble amorphous selenium becomes deposited in the cells, and can be demonstrated as a golden-brown deposit in the cells. Part of the selenium is excreted as soluble salts by the kidneys, part is excreted by the bile and large intestine, and part as methyl-selenide is excreted in the breath.

In these experiments rats were used. Owing to the extreme ease with which sodium selenite is reduced, all doses were given hypodermically and were freshly-prepared. Blood films were prepared in the usual way, dried without heating and stained with Leishmann's stain. Each film being prepared and stained in the same manner.

The first rat was given 0·3 cubic centimetre of 0·125 per cent. solution of sodium selenite. The blood was examined and found to be normal.

Very shortly afterwards there appeared an increase in lymphocytes; the polymorphonuclear leucocytes remained normal, so that there appeared twice as many lymphocytes as other leucocytes. The red blood cells, at the same time, had developed a cloudy white centre (fig. 1).

This was followed by the almost complete disappearance of leucocytes and the development of the cloudy centres described above into vacuoles. Some have one central vacuole of varied shape, while others have several small ones, and it is probable, as will be seen later, that most of these vacuoles are at first central and gradually move towards the periphery (fig. 2).

The rat was now evidently very ill; it was left till next day to see if the blood cells would recover. Next day its blood was normal again.

It was again given an hypodermic injection, and the blood again went through the same changes, namely increase of lymphocytes, development of a cloudy white centre in many of the red blood corpuscles, disappearance of leucocytes, and vacuolation of many of the red blood cells. It was given another hypodermic injection of the same amount.

The vacuolation became more marked, the vacuoles increasing in number and working towards the periphery. In one or two instances the vacuole was seen opening into the blood stream, and occasional corpuscles were seen that had extruded the vacuole (fig. 3).

The movement of the vacuoles to the periphery appeared to be accelerated, a large number of red cells having numbers of vacuoles all round the periphery of the cell (fig. 4).

The films now commenced to stain very badly. Many of the red blood cells, as will be seen in fig. 5, showed the extrusion of buds all round the periphery.

The next films stained hardly at all, indeed, it was difficult to see that any staining had been attempted. The rat was now extremely ill. The next few films showed little difference from fig. 5, but an hour later there was a distinct improvement: the films commenced to take the stain again, the red blood cells began to lose their vacuoles, and the rat was evidently recovering. Large numbers of polymorphonuclear leucocytes and lymphocytes were present. An hour later, except for occasional red blood cells with vacuoles, the blood appeared normal, and next day the blood was normal.

This recovery is interesting, for if this is a condition of haemolysis, as will be shown in the next experiment, the quick recovery must be due to the re-absorption of haemoglobin into the red blood cells that are not too injured to recover. For it is evident, that when the conditions that cause the haemolysis are removed, the red blood cells are able to prevent any further loss, and also to make good the loss which they have previously gone through.

These experiments were repeated with the same results. A second rat was given 0.6 cubic centimetre of 0.125 per cent. solution of sodium selenite hypodermically; the time from the injection to the death of the animal was about two hours.

The blood when first examined was normal. It was seen to go through the same changes as the previous one, the increase of lymphocytes with the white filmy centres in many of the red blood cells, followed by the presence of vacuoles which moved to the edge of the cells and were extruded. The polymorphonuclear leucocytes became scarce, and were swollen, and in some cases disintegrated. The film stained badly and, finally, the corpuscles would not take the stain at all.

The rat now developed profound dyspnoea, convulsions appeared and death very quickly followed.

The blood was removed from the animal and was found to have undergone haemolysis.

No haemolysis was produced by sodium selenite in test-tube experiments.

CONCLUSIONS

Although sodium selenite does not produce haemolysis outside the body, yet it has that effect when injected hypodermically into the tissues of the animal.

The cause of this haemolysis is obscure. Sodium selenite is reduced to selenium in the portal circulation, chiefly in the spleen and liver unless a very large dose is given, in which case it floods the whole system and selenium is found in all the organs; but in the doses given in the previous experiments the reduction took place in the spleen and liver. This is confirmed by the fact that only a proportion of the red cells undergo these changes. In a film one part will be found almost entirely changed, another portion almost entirely normal, while a third portion will show clumps of changed cells and clumps of normal ones, just as one would expect if the portal red blood cells alone became changed and then became mixed with the normal systemic blood. The only other factor which might have some action is the remarkable disappearance of glycogen and sugar which the soluble selenium salts cause, but what effect this would produce it is impossible to say.

My thanks are due to Professor Benjamin Moore for his assistance and many valuable suggestions.



FIG. 1

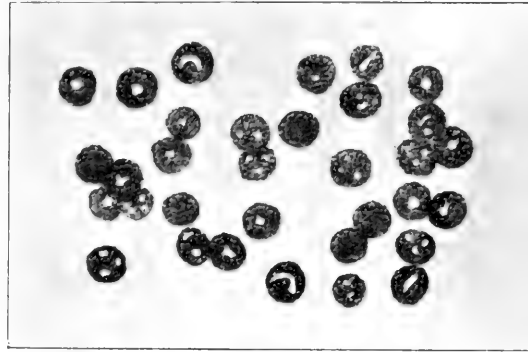

FIG. 2

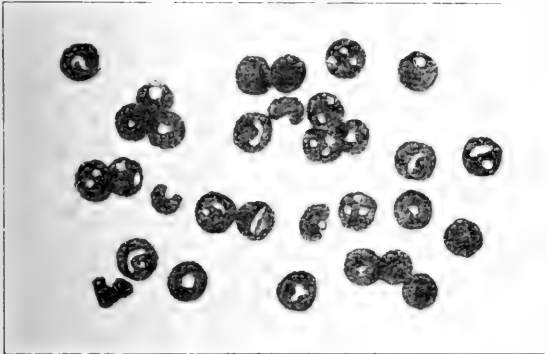

FIG. 3



FIG. 4

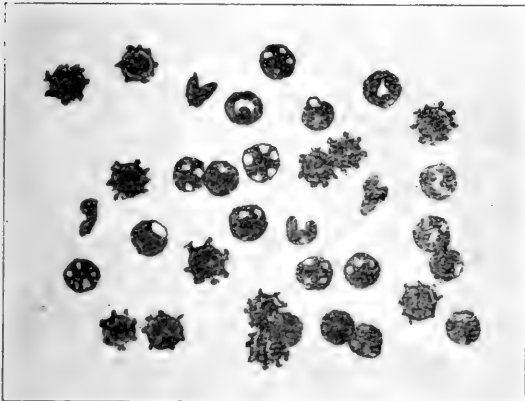

FIG. 5

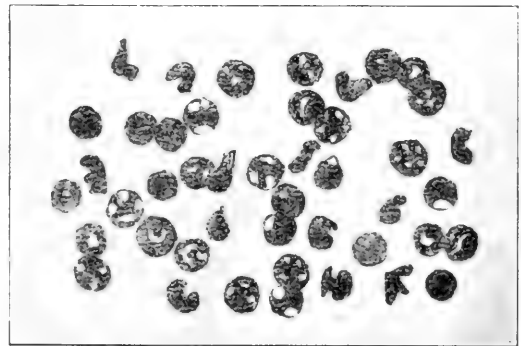

FIG. 6

DIRECT MEASUREMENTS OF THE OSMOTIC PRESSURE
OF CASEIN IN ALKALINE SOLUTION. EXPERIMENTAL
PROOF THAT APPARENT IMPERMEABILITY
OF A MEMBRANE TO IONS IS NOT DUE TO THE
PROPERTIES OF THE MEMBRANE BUT TO THE
COLLOID CONTAINED WITHIN THE MEMBRANE

BY BENJAMIN MOORE, M.A., D.Sc.; HERBERT E. ROAF, M.D.,
D.Sc.; AND ARTHUR WEBSTER, *University of Liverpool*.

*From the Laboratories of Bio-Chemistry and Physiology, University of
Liverpool*

(Received June 30th, 1911)

The most important experimental points settled by this research are the unequal distribution of alkali on the two sides of the membrane at the conclusion of each experiment, the high pressures observed, the flow of crystalloid *towards* the region of high pressure, and the proof that crystalloid, although associated with colloid, still exercises osmotic pressure.

This combination of observations appears to us to finally settle several outstanding questions as to osmotic pressure effects of colloids, and of the behaviour of living cells towards *apparently* impermeable ions which are, nevertheless, found in high concentration within the cells.

These experiments finally dispose of the older view, that osmotic pressures of colloids are not due to the colloids but to slowly diffusible crystalloids present as impurities (the ash of the colloid), which never get into equilibrium on account of the slowness of their diffusion through the membrane from the region of high pressure to that of low pressure.

For, the direction of movement of the crystalloid associating with the colloid, and causing the osmotic pressure as a crystallo-colloidal complex, is from the side of low pressure to the side of high pressure, and this to such a great extent as to leave no question about the matter. Until the colloid is almost saturated by crystalloid, practically no alkali remains on the non-colloid side of the membrane.

The alkali moves *against* osmotic pressure, into the colloid side, there to unite in some form with the colloid, and it is this union which causes the osmotic pressure. The purpose of the membrane is purely the mechanical one of holding together the colloidal aggregates, and its apparent impermeability to the ions is quite fictitious. Free ions pass through quite readily, ions anchored to colloid are retained on the colloid side and exercise pressure, and the membrane has no influence on permeability of free inorganic ions.

This observation throws a clear light on the behaviour of living cells towards ions: the varying concentrations of sodium, potassium, chlorine and phosphatic ions within and without the cell are an expression of specific affinities of the definite colloids of each particular cell-type for these ions, and do not mean that there is a membrane acting as a closed gate to these ions.

The osmometer containing the casein solution may be regarded as a cell, and the adsorbed or combined alkali is the analogue of the potassium ion of the living cell; the alkali has no appreciable concentration outside until the concentration within has become 0.03 N, and as alkali concentration is increased there persists always a higher concentration within and a lower without, just as the cell always has an almost negligible concentration of potassium ion without and a high concentration within the cell, and this concentration within the cell only slowly rises when the concentration outside is increased. On the contrary, if the crystalloid pressure outside is diminished, the specific affinity of colloid and crystalloid holds them together, so that there is only a very slow passage of crystalloid away from cell or osmometer. In this way a *fictitious* appearance of impermeability is produced.

There is no experimental evidence that the cell-membrane is impermeable to potassium, the actual presence of that ion within it shows that it must be permeable, and the analogous action of the osmometer membrane shows that the membrane is easily permeable to the free crystalloid, and that the high concentration of crystalloid within and low one without is due to a specific affinity of the colloid for the crystalloid.

In these experiments we can actually follow the process of the crystalloid being drawn through the membrane, *against* the gradient of osmotic pressure, the rise in osmotic pressure as a result of this, and the

establishment of a different concentration of the crystalloid on the two sides leading to the simulation of an impermeable membrane, such as is presented by the picture of the living cell.

Reasons have previously been assigned at greater length for the view that living cells are in reality permeable freely to ions which appear to pass with the greatest difficulty into or out of them.¹ In the first place, the heaped-up concentration of potassium and phosphate within the majority of living cells, as contrasted with the concentration of these ions in the outer plasma or other bathing fluids, is to us clear evidence that the cell, or cell membrane, is easily permeable to the potassium ion. Otherwise, in the process of reproduction of new cells as the organism grows, the initial concentration in potassium ion within must have rapidly fallen to zero, instead of remaining heaped-up high above the outer level, as one cell gave rise to many. This heaping-up of certain ions within the cell expresses for us a certain molecular affinity between the colloid contents of the cell and these ions, and it is that same affinity which prevents such ions being washed out when the cell is subjected to dialysis, and so causes the fictitious appearance of impermeability of a membrane upon which those observers still rely who believe in the existence of a cell-membrane impermeable, or only permeable with great difficulty, for these ions. Also, when the affinity of the cell colloids for an ion, such, say, as potassium, is satisfied, further uptake of potassium will be very slight and on a purely physical basis, so that when cells, such as red blood corpuscles, are bathed with salines rich in potassium, they take up but little more than their normal quantity. This, however, is no proof of impermeability, any more than is the fact that appreciable uptake of oxygen ceases when the haemoglobin is saturated with oxygen is a proof that the red blood corpuscle is impermeable or difficultly permeable to oxygen. All these experimental findings will present themselves in any living cell possessing a colloid with a molecular affinity for ions or other dissolved crystalloid substances, and such phenomena have nothing whatever to do with permeability, or impermeability, of a membrane to the ions or other crystalloids.

First, when the cell is washed with a saline solution free from the ion in question or containing that ion in very low concentration, the amount of the ion washed out of the cell may be practically inappreciable,

1. See Moore, 'Recent advances in Bio-Chemistry and Physiology,' edited by L. Hill, Arnold, London, 1907; Moore and Roaf, previous papers this Journal and elsewhere.

for it will only wash out till the concentration of free ion balances against the amount of adsorbed ion, and, depending on the molecular affinities, this concentration may be a very low one indeed, falling almost to zero in the case of the potassium ion. Thus, sodium ions can readily be washed out of cells because the cell proteins have no affinity for them, while potassium ions are retained to the last. This shows also how fresh-water organisms can saturate themselves with potassium and phosphatic ions from waters in which all tests for potassium would fail even after considerable concentration. A similar affinity of the colloidal constituents of the soil for potassium ions and phosphates retains these valuable constituents in the soil, while the sodium and chlorine ions are carried seawards by the rivers. No membrane retention hypothesis ever put forward can explain such facts as these.

Secondly, when a cell is washed with a saline containing a hypertonic quantity of one of these *apparently* impermeable ions, since the cell already contains, on account of its molecular affinities, a large amount of the particular ion, the further amount which it takes up physically is comparatively so small as to simulate impermeability and appear to lie within the limits of experimental error.

Physiological tests, which are always more delicately balanced than volumetric or gravimetric chemical tests with purely inorganic agents, clearly demonstrate, however, that the balance in the cell is being upset under such conditions. While the cell, to ordinary chemical tests, as pointed out above, appears to be at least difficultly permeable to potassium ions, physiological tests show that it is being profoundly affected. This is shown by the beautifully contrasted effects of perfusion with ordinary saline on the one hand, and with Ringer's solution on the other, in the case of the excised heart, as also in the effects of potassium starvation and potassium excess for practically all types of living cells. Witness also the profound effects of two or three grammes of potassium administered to a man of sixty to seventy kilograms, in depressing the whole nervous activities, and it must be admitted that the infinitesimal extra amount which has entered the cells has produced an enormous result. Such an effect cannot be explained by membranes. It is a result produced within the cell amongst the constituent cell-proteins affecting their aggregations, and fitness for chemical change and exhibition of chemical energy. Apart from living cells, we know experimentally that ions or crystalloids produce just such effects upon colloids in forming

their crystallo-colloidal aggregations. The solution-aggregate of the colloid varies in size with the nature and amount of crystalloids present, even far short of actual precipitation.¹ It is, therefore, easy to see that variations in amount and character of adsorbed crystalloids must lie at the very citadel of cell activities.

Now, what is claimed as the chief point of beauty and interest about the present series of experiments is that in an experimental and artificial system this march of events is clearly demonstrated.

At first there is the colloidal casein in the osmometer inert and showing no osmotic pressure, just as a living cell would be if deprived of all its potassium ion, then as alkali, which takes the place of the potassium ion of the living cell, is admitted slowly in the earlier experiments, and in increasing amounts in the later ones, the system, so to speak, becomes alive and active, and the osmotic pressure, which corresponds to the index of life, rises all the time till an optimum limit is reached, beyond which there is no further effect but rather a diminution in effect. It is not, of course, pretended that we have in this simple system of casein and alkali anything so labile and delicately balanced as a living cell. But in this simple type we see the same primary factors as in the cell, and the important point is that the chemical play and energy-discharge is within the osmometer as we hold it is within the cell. The function of the osmometric membrane is a mechanical one of holding crystalloid and colloid together, just as we hold that of the membrane of the living cell to be. The osmometer membrane is freely permeable to the alkali alone, it merely prevents back passage of the crystallo-colloidal mass, and this produces a fictitious appearance of impermeability, which we know, from having watched the experiment from the beginning, to be erroneous. We cannot watch the experiment from the start in the case of the cell, we take it up when the cell is already charged with potassium ion, and hence our first impression is that the cell possesses a membrane which is impermeable to the potassium ion. A moment of reflection convinces us, however, that the cell is now full of potassium, that it has arisen from a thousand previous generations of cells, all containing a like percentage of potassium to itself, and since in the thousand-fold repeated cell-division the volume has increased a thousand-fold of the entire mass of cells, it is irresistible

1. Moore and Roaf.

to conclude that potassium must have been going in all the time. Here the osmometric experiment shows us how the uptake or out-put of the crystalloid is regulated and how the fictitious and merely apparent impermeability is produced and maintained.

The thirst of the casein for alkali, demonstrated in the three experiments at the upper end of the table where the concentration of alkali is lower, illustrates the manner in which the colloids of living cells can extract and concentrate crystalloids for their purposes from infinitesimally low amounts in the fluids bathing them. Such, for example, as bone formation from the excessively low concentration of calcium ion in the blood, the formation of calcareous and siliceous shells in freshwater and marine organisms, and many similar cases. Such concentrations arise from affinities of a molecular type between colloids and crystalloids, which vary from time to time, so causing periods of uptake and deposition in a rhythmic manner.

The osmometer used was of metal lined by platinum and with a platinum grid supporting a parchment paper membrane. The two instruments used were those described by us in previous papers. The percentage of casein present was determined from the nitrogen of a Kjeldahl carried out in each case at the conclusion of the experiment, since the high pressure registered caused considerable dilution of the colloid solution during the experiment. Readings were recorded at intervals as shown in the protocols of experiments, and great care was always exercised that equilibrium was established before the experiment was concluded. Titration for free alkali was made, using phenol-phthalein as an indicator, when the end point is reached at the point where alkali and casein are combined. Of course no casein is present on the colloid-free side, and hence the titrations there are quite absolute. It is to be observed that in the beginning there is no free alkali on either side, and that the free alkali on the colloid-free side remains very low until about 0.07 to 0.08 N concentration has been reached, when the casein begins to be saturated at the levels used in the experiments.

It may be noted that, although the table seems but a short one involving little labour, that each line represents a prolonged experiment, with many observations and accompanying analyses.

Final concentration of Caseinogen	Observed Pressure	Pressure per one per cent. of Caseinogen	Initial concentration of Sodium Hydrate	Concentration of free Sodium Hydrate in Colloid chamber of Osmometer	Concentration of free Sodium Hydrate in Crystalloid chamber of Osmometer	Temperature at end of Experiment	Time in days Experiment lasted
<i>Expt. I</i> — 8.2 %	mm. 233	mm. 28	0.02 N	0.031 N Acid	Nil	11.5° C.	14
<i>Expt. II</i> — 5.4 %	310	57	0.033 N	0.02 N Acid	Nil	12.5° C.	10
<i>Expt. III</i> — 8.0 %	334	42	0.04 N	0.004 N	0.006 N	11.0° C.	14
<i>Expt. IV</i> — 5.6 %	460	82	0.06 N	0.025 N	0.013 N	15.0° C.	6
<i>Expt. V</i> — 5.7 %	488	85	0.065 N	0.024 N	0.018 N	19.0° C.	13
<i>Expt. VI</i> — 6.08 %	610	101	0.07 N	0.022 N	0.015 N	15.0° C.	10
<i>Expt. VII</i> — 5.37 %	686	129	0.08 N	0.047 N	0.025 N	15.0° C.	14
<i>Expt. VIII</i> — 4.7 %	588	125	0.09 N	0.048 N	0.034 N	13.0° C.	14
<i>Expt. IX</i> — 5.04 %	586	117	0.095 N	0.056 N	0.032 N	14.5° C.	14
<i>Expt. X</i> — 5.16 %	538	105	0.1 N	0.066 N	0.044 N	15.5° C.	9
<i>Expt. XI</i> — 5.1 %	508	100	0.1 N	0.06 N	0.042 N	13.0° C.	22

NOTE.—The concentration of alkali at the commencement was the same exactly on both sides of the membrane, and varied from one-fiftieth normal in the first to one-tenth normal in the last experiment. Observe the passage of alkali through the membrane to join casein, and the rising osmotic pressure demonstrating that the osmotic pressure is due to the combination of crystallo-colloid, and that the diffusion of crystalloid is against the gradient of osmotic pressure. Observe also that a maximum of osmotic pressure per one per cent. of colloid is reached at about 0.047 N of free alkali, and further increase of alkali lowers osmotic pressure.

Experiment I—Commenced December 6th, 1909. Ten per cent. caseinogen in 0.02 N sodium hydrate against 0.02 N sodium hydrate.

Time from commencement		Osmotic pressure in mm. of mercury	Temperature in °C.
Days	Hours		
0	0	0	14°
—	19	6	14
1	19	82	11.5
2	19	152	12.5
3	11	172	15.0
4	3	196	14.0
4	6	233	16.0
6	3	233	15.0
7	3	233	14.5
8	3	233	13.0

Analysis of contents of osmometer at end of experiment:—

Colloid Side: Clear solution, slightly opalescent. Titrated with N/10 NaOH and phenolphthalein, 5 c.c. required 1.55 cc. N/10 NaOH. Nitrogen by Kjeldahl gave 1.33 per cent. nitrogen, equal to 8.2 per cent. caseinogen.

Crystalloid Side: Clear neutral solution.

Experiment II—Commenced February 1st, 1910. Ten per cent. caseinogen in 0.033 N sodium hydrate against 0.033 N sodium hydrate.

Time from commencement		Osmotic pressure in mm. of mercury	Temperature in °C.
Days	Hours		
—	18	116	13
1	2	166	12
1	17	216	14
2	17	256	11.5
3	17	288	13.5
4	20	306	16
6	1	310	15
7	0	310	16

Analysis of contents of osmometer at end of experiment:—

Colloid Side: Opalescent fluid. Titrated with N/10 NaOH and phenolphthalein, 5 c.c. required 1 c.c. N/10 NaOH. Nitrogen by Kjeldahl gave 0.86 per cent. N, equal to 5.4 per cent. caseinogen.

Crystalloid Side: Clear neutral fluid.

Experiment III—Commenced December 6th, 1909. Ten per cent. caseinogen in 0.04 N sodium hydrate against 0.04 sodium hydrate.

Time from commencement		Osmotic pressure in mm. of mercury	Temperature in °C.
Days	Hours		
1	0	226	11
2	0	242	11.5
3	0	348	12.5
3	8	348	15
3	23	338	14.5
5	2	336	16
6	23	332	15
7	23	332	14.5
9	23	332	13
10	23	334	12
12	23	334	11

Analysis of contents of osmometer at end of experiment:—

Colloid Side: Opalescent fluid, alkaline; 5 c.c. required 0.2 c.c. N/10 sulphuric acid. Nitrogen by Kjeldahl gave 1.28 per cent. N, equal to 8.0 per cent. caseinogen.

Crystalloid Side: Clear alkaline fluid, no protein present; 5 c.c. took 0.3 c.c. N/10 H₂SO₄.

Experiment IV—Commenced December 19th, 1909. Ten per cent. caseinogen in 0.06 N sodium hydrate against 0.06 N sodium hydrate.

Time from commencement		Osmotic pressure in mm. of mercury	Temperature in °C.
Days	Hours		
0	17	160	14.5
1	17	356	14
2	13	396	11
3	13	430	12.5
4	11	460	17.5
6	0	460	15.5

Analysis of contents of osmometer at end of experiment:—

Colloid Side: Pale yellow alkaline fluid; 5 c.c. took 1.45 c.c. N/10 sulphuric acid. Nitrogen by Kjeldahl gave 0.88 per cent. N, equal to 5.6 per cent. caseinogen.

Crystalloid Side: Clear alkaline fluid, free from protein; 5 c.c. took 0.65 c.c. N/10 sulphuric acid.

Experiment V—Commenced April 14th, 1910. Ten per cent. caseinogen in 0.065 N sodium hydrate against 0.065 per cent. sodium hydrate.

Time from commencement		Osmotic pressure in mm. of mercury	Temperature in °C.
Days	Hours		
0	18	112	16
1	1	166	17.5
3	16	236	14.5
4	0	322	18
5	0	366	16
6	0	406	15.5
7	0	454	16
8	0	480	16
9	0	484	12
11	0	488	18.5
12	23	488	19.5

Analysis of contents of osmometer at end of experiment :—

Colloid Side : Opalescent alkaline fluid ; 5 c.c. required 1.2 c.c. N/10 H₂SO₄. Nitrogen by Kjeldahl gave 0.91 per cent. N, equal to 5.7 per cent. caseinogen.

Crystalloid Side : Clear fluid, alkaline, no protein present ; 5 c.c. required 0.9 c.c. N/10 sulphuric acid.

Experiment VI—Commenced January 31st, 1910. Ten per cent. caseinogen in 0.07 N sodium hydrate against 0.07 sodium hydrate.

Time from commencement		Osmotic pressure in mm. of mercury	Temperature in °C.
Days	Hours		
0	17	202	14
1	17	432	13.5
2	1	484	13.0
2	17	542	12.0
3	17	584	14.0
4	17	604	13.5
5	20	612	16.0
6	16	614	16.0
7	1	614	15.0
8	1	610	11.5
9	1	610	14.0
10	1	610	15.0

Analysis of contents of osmometer at end of experiment :—

Colloid Side : Clear alkaline fluid ; 5 c.c. required 1.1 c.c. N/10 sulphuric acid. Nitrogen by Kjeldahl gave 0.96 per cent. N, equal to 6.08 per cent. caseinogen.

Crystalloid Side : Clear alkaline fluid containing no protein ; 5 c.c. required 0.75 c.c. N/10 sulphuric acid.

Experiment VII—Commenced April 11th, 1910. Ten per cent. caseinogen in 0.08 N sodium hydrate against 0.08 N sodium hydrate.

Time from commencement		Osmotic pressure in mm. of mercury	Temperature in °C.
Days	Hours		
—	16	98	17
1	16	284	17
2	16	412	15
3	0	452	15
3	17	512	17.5
4	0	536	19
4	19	576	17
6	16	632	14.5
7	0	644	18
7	16	652	15.5
8	0	660	16.0
8	16	668	15.5
9	0	680	16.0
10	0	686	15

Analysis of contents of osmometer at end of experiment :—

Colloid Side : Clear alkaline fluid ; 5 c.c. required 2.35 c.c. N/10 sulphuric acid. Nitrogen by Kjeldahl gave 0.85 per cent. N, equal to 5.37 per cent. caseinogen.

Crystalloid Side : Clear alkaline fluid, free from protein ; 5 c.c. required 1.25 c.c. N/10 sulphuric acid.

Experiment VIII—Commenced February 26th, 1910. Ten per cent. caseinogen in 0.09 N sodium hydrate against 0.09 N sodium hydrate.

Time from commencement		Osmotic pressure in mm. of mercury	Temperature in °C.
Days	Hours		
1	22	332	12
2	6	392	14
2	22	458	10
3	6	490	15
4	0	520	14
5	0	542	13.5
6	0	558	13.5
6	8	564	16
7	0	568	13
8	3	576	15
9	5	580	16.5
9	22	580	14.0
10	22	582	14
11	22	584	13
12	6	588	16
13	6	588	16
14	6	588	13

Analysis of contents of osmometer at end of experiment :—

Colloid Side : Clear alkaline fluid ; 5 c.c. required 2.4 c.c. N/10 sulphuric acid. Nitrogen by Kjeldahl gave 0.76 per cent. N, equal to 4.7 per cent. caseinogen.

Crystalloid Side : Clear alkaline fluid free from protein ; 5 c.c. required 1.7 c.c. N/10 sulphuric acid.

Experiment IX—Commenced March 8th, 1910. Ten per cent. caseinogen in 0.095 N sodium hydrate against 0.095 N sodium hydrate.

Time from commencement		Osmotic pressure in mm. of mercury	Temperature in °C.
Days	Hours		
—	19	254	14
1	19	422	13
2	3	456	16
2	19	500	14
3	3	508	16
3	19	516	13
5	19	550	13
6	19	560	13
7	3	566	16
7	19	568	14
8	19	570	13
9	19	571	13
10	21	576	13
11	23	576	16.5
12	19	579	14.5
13	3	584	16.5
13	19	586	14.5
14	19	586	14

Analysis of contents of osmometer:—

Colloid Side: Clear yellow alkaline fluid; 5 c.c. required 2.8 c.c. N/10 sulphuric acid. Nitrogen by Kjeldahl gave 0.8 per cent. N, equal to 5.04 per cent. caseinogen.

Crystalloid Side: Clear alkaline fluid, free from protein; 5 c.c. required 1.6 c.c. N/10 sulphuric acid.

Experiment X—Commenced April 11th, 1910. Ten per cent. caseinogen in 0.1 N sodium hydrate against 0.1 N sodium hydrate.

Time from commencement		Osmotic pressure in mm. of mercury	Temperature in °C.
Days	Hours		
1	0	284	17
2	0	334	17
3	0	484	15
3	8	494	16
4	0	510	17.5
4	8	514	19
5	3	524	17
7	0	534	14.5
7	8	538	18
8	8	538	15.5
9	8	538	15.5

Analysis of contents of osmometer:—

Colloid Side: Clear alkaline fluid; 5 c.c. required 3.3 c.c. N/10 sulphuric acid. Nitrogen by Kjeldahl gave 0.82 per cent. N, equal to 5.16 per cent. caseinogen.

Crystalloid Side: Clear alkaline fluid, free from protein; 5 c.c. required 2.2 c.c. N/10 sulphuric acid.

Experiment XI--Commenced November 28th, 1910. Ten per cent. caseinogen in 0.1 N sodium hydrate against 0.1 N sodium hydrate.

Time from commencement		...	Osmotic pressure in		Temperature in °C.
Days	Hours		mm. of mercury		
—	16	...	4	...	11
2	16	...	130	...	11.5
3	19	...	268	...	14.0
4	16	...	340	...	12.0
5	16	...	400	...	13
6	16	...	430	...	11
7	16	...	450	...	12.5
8	16	...	462	...	15
9	16	...	468	...	14
10	16	...	472	...	14.5
11	16	...	476	...	14
12	16	...	480	...	14
13	16	...	484	...	16
14	16	...	486	...	14
15	16	...	490	...	14
16	16	...	500	...	16
17	12	...	504	...	14
18	12	...	508	...	15
20	12	...	508	...	13
22	12	...	508	...	13

Analysis of contents of osmometer:—

Colloid Side: Clear yellow alkaline fluid; 5 c.c. required 3 c.c. N/10 sulphuric acid. Nitrogen by Kjeldahl gave 0.81 per cent. N, equal to 5.1 per cent. caseinogen.

Crystalloid Side: Clear alkaline fluid, free from protein; 5 c.c. required 2.1 c.c. N/10 sulphuric acid.

THE SODIUM PHOSPHATE STANDARDS OF ACIDITY

BY E. B. R. PRIDEAUX.

(Received July 13th, 1911)

During a recent investigation into the hydrogen ion concentration $[H^+]$ of phosphate solutions by the hydrogen electrode method¹, certain relations were discovered between these and the second and third dissociation constants of phosphoric acid. These constants, K_2 and K_3 , allow of an easy calculation of $[H^+]$ over the range most required in the case of N/10 sodium phosphate solutions. The experience gained in the experimental work has led to certain conclusions as to the advantages and disadvantages of making up such solutions from standard NaOH and H_3PO_4 , rather than from mixtures of mono- di- and tri-sodium phosphate², or from mixtures of other salts³.

To eliminate the diffusion potential between the solutions, saturated potassium chloride was used in most of the measurements. A few comparisons with the liquid potential eliminator used by Salm, i.e., the addition of N/8 or N/10 sodium chloride to all solutions, showed that the same E.M.F. is obtained with either method, a fact which considerably strengthens the probability that both methods do really attain the desired object.

The normal H_3PO_4 was made from Merck's purest acid (density = 1.73) which was found free from nitrate, chloride, sulphate, and HPO_3 , and carefully analysed by conversion into $Mg_2P_2O_7$.

The NaOH was made from the sticks (pure by alcohol) dissolved in CO_2 free water, and analysed as sodium chloride.

All the decinormal solutions referred to can, of course, be rapidly prepared from these two stocks.

As will be seen from the enclosed table, all solutions up to the neutral point give values of $[H^+]$ closely agreeing with those obtained by Salm from various mixtures of N/10 NaH_2PO_4 and N/10 Na_2HPO_4 , and with those calculated by the formula mentioned below. No special care need be taken even to secure alkali or water free from CO_2 , since the solutions weighed in Jena glass flasks can be boiled for a few minutes after making

1. *Journ. Chem. Soc.*, p. 2224, June, 1911.

2. Salm, *Zeitsch. physikal. Chem.*, LVII, p. 492, 1907; Friedenthal, *Zeitsch. Elektrochem.*, X, p. 113, 1904.

3. See Walpole.

up, then brought to the original weight with the required volume of water.

As will be seen from the enclosed curve the $[\text{H}^+] = 1 \times 10^{-4}$ to $[\text{H}^+] = 1 \times 10^{-6}$ varies rather rapidly with the relative proportions of NaOH and H_3PO_4 . In this part, therefore, the ratios given in the table should be accurately observed, a difference of 1 per cent. in amount of NaOH added making a difference of about 0.5 in the exponent of $[\text{H}^+]$. Since, however, the normal solutions can easily be standardised within one per cent., and excess of CO_2 can be driven off as described above, the standards are easily reproducible in practice.

Even less accuracy is required in the preparation of solutions from $[\text{H}^+] = 1 \times 10^{-6}$ to the neutral point, since here the curve is quite flat, and the unavoidable errors of the hydrogen electrode will be far larger than any accruing from possible excess or defect of alkali. And from $[\text{H}^+] = 1 \times 10^{-7}$ to $[\text{H}^+] = 1 \times 10^{-8}$ the solutions are still easy to reproduce with sufficient accuracy, although, since they are on the alkaline side of the neutral point, CO_2 must be more carefully guarded against.

From this point onwards, however, the third dissociation constant begins to have an increasing effect, and the curve shows a rapid decrease of $[\text{H}^+]$ with added NaOH, until at $[\text{H}^+] = 1 \times 10^{-9}$, which corresponds almost exactly to the composition Na_2HPO_4 , an error of 1 per cent. in the composition of the mixture makes a difference of 0.25 in the exponent of $[\text{H}^+]$ on the acid side of 1×10^{-9} , and 0.37 on the alkaline side. It was actually found that deviations of about this order occurred in the measured $[\text{H}^+]$ of synthetic solutions of this composition, the cause being almost certainly the presence of small and varying quantities of CO_2 . The effect of CO_2 may easily be observed by leaving a solution coloured with phenolphthalein exposed to the air. It was measured in the following way. A solution giving by the hydrogen electrode a value of $[\text{H}^+] = 1.6 \times 10^{-11}$ was exposed for an hour to a current of CO_2 . The $[\text{H}^+]$ again measured was found to have risen to 7.0×10^{-9} . This is an extreme case, of course, but serves to illustrate the care required.

The reproducibility of Na_2HPO_4 standard from crystalline salt was next studied. The salt must, of course, be re-crystallized, since crude specimens may give $[\text{H}^+]$ as far from the true value as 1×10^{-11} . In view of the required accuracy of the ratio $\frac{\text{NaOH}}{\text{H}_3\text{PO}_4}$ the conditions of crystallisation would appear not unimportant, in order to ensure that

traces of Na_3PO_4 , or NaH_2PO_4 are absent. A solution of the crystalline salt is made slightly acid to phenolphthalein with phosphoric acid, and evaporated down to beyond the point where crystallisation should commence, a high degree of supersaturation being possible. The solution may be slightly pink when hot. To this, normal NaOH is added, drop by drop, from a burette, until, at a certain point crystallisation takes place, the mass of fine crystals being then rapidly sucked dry and washed on a Buchner funnel.

This preparation gave a value of $[\text{H}^+] = 1.3 \times 10^{-9}$ approximating very closely to that of Salm (1.5×10^{-9}) and to the value depending on the dissociation constants (1×10^{-9}).

Slightly on the alkaline side of $[\text{H}^+] = 1 \times 10^{-10}$ the errors in stoichiometrical proportions of NaOH and H_3PO_4 and the presence of CO_2 again become relatively unimportant compared to those of the hydrogen electrode, and this statement holds true up to Na_3PO_4 .

In conclusion it may be stated that solutions from $[\text{H}^+] = 1 \times 10^{-4}$ to $[\text{H}^+] = 1 \times 10^{-8}$ and 1×10^{-11} to 1×10^{-12} may be prepared, either from mixtures of the NaOH and H_3PO_4 or solutions prepared from the crystalline sodium phosphates, the former method being perhaps preferable as requiring only two standard solutions and analytical controls. For solutions in the neighbourhood of $[\text{H}^+] = 1 \times 10^{-9}$, however, it seems better to use the re-crystallised salt Na_2HPO_4 .

As far as an easily attainable analytical accuracy is concerned, the exponent of $[\text{H}^+]$ is actually determined for each solution to about 0.1 of a unit in the flat parts of the curve. Unfortunately the $[\text{H}^+]$ cannot be measured with anything like this accuracy. By using, however, a large number of measurements and finding an equation to the whole curve, it is considered that the numerical value $[\text{H}^+]$ has been determined with a much greater probability than could be attained by any individual measurement. The constants K_2 K_3 of this equation have been found to be 2.0×10^{-7} and 3.0×10^{-12} , the former being practically identical with the second dissociation constant of H_3PO_4 found by Abbott and Bray¹, using a different method; that of distribution ratios and conductivities.

A simplified equation which permits of a rapid calculation of the ratio $\frac{\text{NaOH}}{\text{H}_3\text{PO}_4}$ required for any given value of $[\text{H}^+]$; the solution being always $\frac{1}{10}$ molecular with respect to the latter, is as follows²:--

1. *Journ. Amer. Chem. Soc.*, XXXI, p. 730, 1909.

2. The deduction of this may be found in the preceding communication already referred to--*Journ. Chem. Soc.*, p. 2224, June, 1911.

$$\frac{\text{NaOH}}{\text{H}_3\text{PO}_4} = \frac{2 + \frac{a_1 [\text{H}^+]}{a_2 K_2} + \frac{3a_1 K_3}{a_3 [\text{H}^+]}}{1 + \frac{a_1 [\text{H}^+]}{a_2 K_2} + \frac{a_1 K_3}{a_3 [\text{H}^+]}}$$

$\alpha_1, \alpha_2, \alpha_3$, the degrees of dissociation of Na_2HPO_4 , NaH_2PO_4 and Na_3PO_4 were found to be 0.06, 0.077, 0.05 by Abbott and Bray¹.

Putting in K_2, K_3 as above:—

$$\frac{\text{NaOH}}{\text{H}_3\text{PO}_4} = \frac{2 + 0.39 \times 10^7 [\text{H}^+] + \frac{10.8 \times 10^{-12}}{[\text{H}^+]}}{1 + 0.39 \times 10^7 [\text{H}^+] + \frac{3.6 \times 10^{-12}}{[\text{H}^+]}}$$

This calculation may be used from $[\text{H}^+] = 1 \times 10^{-5}$ to $[\text{H}^+] = 1 \times 10^{-11}$. From 1×10^{-5} to $1 \times 10^{-7.5}$ the K_3 term is negligible and the equation reduces to:—

$$\frac{\text{c.c. } \frac{\text{N}}{\text{NaOH}}}{\text{c.c. } \frac{\text{N}}{\text{H}_3\text{PO}_4}} = \frac{2 + 0.39 \times 10^7 [\text{H}^+]}{1 + 0.39 \times 10^7 [\text{H}^+]}$$

The table gives some observed values for comparison with those calculated by this equation.

Molecules NaOH to 10 Molecules H_3PO_4	$[\text{H}^+]$ found	$[\text{H}^+]$ calculated
10.0 (NaH_2PO_4)	9.3×10^{-5} (Salm)	1.2×10^{-4} *
"	1.5×10^{-4} (Prideaux)	
10.6		1.0×10^{-5}
11.05	1.7×10^{-6} (P.)	
11.5	9.7×10^{-7} (S.)	
12.05		1.0×10^{-6}
14.45	2.6×10^{-7} (P.)	
14.45		3.2×10^{-7}
15.50	1.5×10^{-7} (S.)	
15.50	2.0×10^{-7} (P.)	
17.2		1.0×10^{-7}
17.7 (Neutral point)		0.73×10^{-7}
17.6	0.76×10^{-7} (P.)	
19.5	1.0×10^{-8} (S.)	
19.6		1.0×10^{-8}
20.0 (Na_2HPO_4)	1.3×10^{-9} (S.)	1.0×10^{-9}
"	1.5×10^{-9} (P.)	
20.04		1.0×10^{-10}
20.3	9.8×10^{-11} (S.)	
20.5	5.9×10^{-11} (P.)	
21.4	1.3×10^{-11} (S.)	
21.6	2.0×10^{-11} (P.)	
22.2	1.2×10^{-11} (P.)	
22.6		1.0×10^{-11}

* Directly from K_2, α (NaH_2PO_4) and $C. = 0.1$.

1. *Loc. cit.*

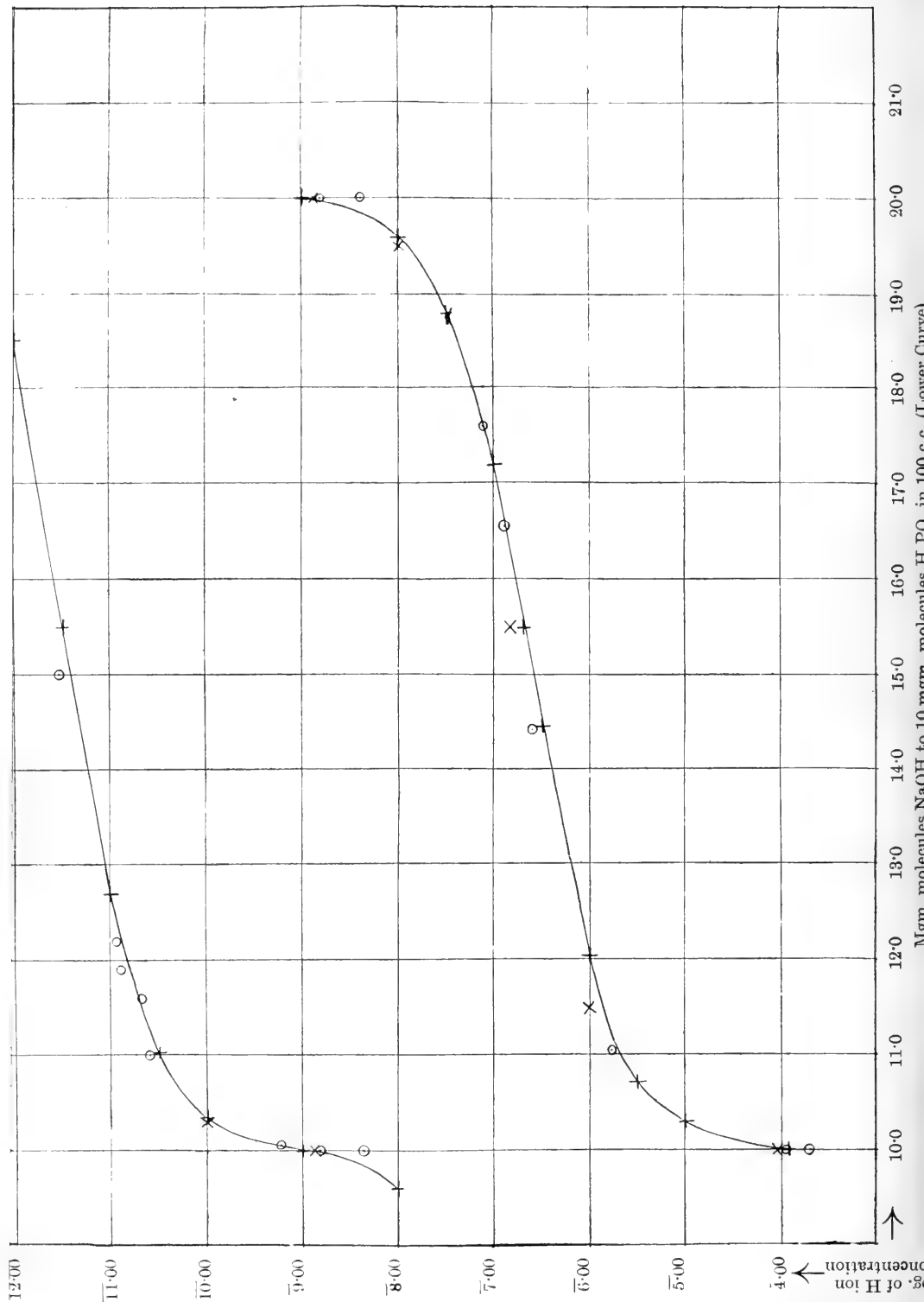

NOTE ON THE SYNONYMY AND HISTOLOGICAL
CHARACTERS OF EAST LONDON BOXWOOD
(*GONIOMA KAMASSI*, E. MEY.)

By R. J. HARVEY-GIBSON, M.A., F.L.S., *Professor of Botany in the
University of Liverpool.*

(Received August 2nd, 1911)

In this Journal¹ some observations were published on the physiological properties of a timber used in the manufacture of shuttles in Lancashire and Yorkshire, and believed to have an injurious effect on the health of the workmen employed. The piece of wood then submitted to me was described as 'West African Boxwood.' I was at first led to regard it as the wood of a plant described by De Wildeman as *Sarcocephalus diderrichii*, but on further examination I found that the wood was exported, not from West Africa, but from South Africa, and also went by the name of 'Knysna Wood' or 'East London Boxwood.'

I obtained a large quantity of the sawdust produced in the process of shuttle manufacture when 'East London Boxwood' was employed for that purpose, and Dr. A. W. Titherley, Lecturer on Organic Chemistry in the University, was kind enough to make an extract of this sawdust, obtaining from it an alkaloid or mixture of alkaloids, prepared in accordance with the method described in detail in the paper above referred to.

I then asked Miss S. C. M. Sowton, a research worker in the Physiological Laboratories to determine, if possible, whether the alkaloid extracted had any effect on the mammalian heart, as I was informed that the injurious effect on the health of those employed took the form of so-called 'cardiac asthma.' The experiments made, and the results arrived at, all pointed to the fact that the alkaloid was a marked cardiac depressant.

I had occasion recently to re-investigate the whole question, and as there seemed to be some doubt as to the exact botanical nature of the wood I thought it worth while, in view of the economic importance of the subject, to attempt to settle this problem of botanical identity. The present note, therefore, may be taken as supplementing the work already carried out in 1905.

1. Vol. I, No. 1, 1905.

Gonioma kamassi is generally spoken of as 'Knysna wood' or 'Knysna Boxwood.' In Stone's 'Timbers of Commerce' Knysna Boxwood is given as the trade name of *Gonioma kamassi* and synonymous with 'Cape Boxwood,' 'Kamassihout,' and 'East London Boxwood.' *Gonioma* is a genus of Apocynaceae and native of South Africa. Unfortunately, *Buxus macowani*, a member of the Euphorbiaceae, and also a South African plant, is known as well in commerce as 'Cape Boxwood' or 'East London Boxwood.' I submitted the questions of synonyms to the Director of the Royal Gardens, Kew, and was informed by him that *Gonioma kamassi* was only partly synonymous with 'East London Boxwood,' because the latter name also included *Buxus macowani*. The problem to be solved, therefore, was which of these two timbers was the one used in shuttle manufacture, whose deleterious effects on the workmen had been the subject of physiological investigation. To settle this question I examined, microscopically, preparations of the wood used in shuttle manufacture, and described as 'Knysna wood' and compared them with sections prepared from an authentic specimen of *Gonioma kamassi*, obtained from the Conservator of Forests, Knysna, and with sections prepared from a specimen of the timber of *Buxus macowani*, for which I am indebted to the Director of the Royal Gardens, Kew.

The wood of *Gonioma* is considerably lighter than that of *Buxus*, a cubic foot of the former, when dry, weighing (according to Stone) 58 lbs., while a cubic foot of *Buxus* weighs 74 lbs. *Gonioma* yields a pale yellow solution in water, while *Buxus* gives no coloration. When transverse sections are compared certain marked differences make their appearance.

In *Gonioma* the main mass of the xylem is composed of lignified fibres, whose walls are channelled by narrow canals and whose lumina are almost occluded. These fibres vary from 12μ to 15μ in diameter, while those of *Buxus macowani* rarely exceed 10μ . The fibres of *Gonioma* are irregularly arranged while those of *Buxus* are in fairly regular radial rows, not unlike those of a Gymnosperm. Mixed with these fibres are tracheae which in *Gonioma* average 35μ in diameter; the tracheae of *Buxus* seldom exceed 25μ in diameter. The medullary rays of *Buxus* are very narrow, seldom being more than two cells in breadth, and composed of thin, radially extended, pitted plates. The cells of the medullary rays of *Gonioma* are much larger and broader, and the rays

themselves may be from one to four cells broad. The wood of *Buxus macowani* is said by Stone¹ to be 'nearly identical' in anatomical characters with *Buxus sempervirens*, the European Boxwood. This is not so. The fibres as seen in transverse section are much more irregularly arranged than in *B. macowani*, and the tracheae are much larger, being seldom less than 35μ in diameter. An examination of many sections shows that the histological characters afford a reliable means of diagnosis of these three woods. Certainly, with the aid of an eye-piece micrometer, there is no difficulty in distinguishing 'East London Boxwood' derived from *Gonioma kamassi*, from 'East London Boxwood' derived from *Buxus macowani*. A histological comparison of the wood used in shuttle manufacture, and called 'East London Boxwood,' leaves no doubt that that timber is to be referred to *Gonioma kamassi* and not to *Buxus macowani*.

1. *Loc. cit.*, p. 194.

CRYOSCOPIC DETERMINATIONS OF THE OSMOTIC
PRESSURE OF THE BLOOD AND BODY FLUIDS OF
SOME AUSTRALIAN ANIMALS

By JUDAH LEON JONA, D.Sc., M.B., B.S.

From the Physiological Department of the University of Melbourne

(Received August 22nd, 1911)

The determination of the osmotic pressure of the body fluids of various animals has been carried out by a number of investigators. To the data thus acquired I am able to add the results of some experiments made with the blood, etc., of various Australian animals. The method employed was the determination of the depression of freezing point by the Beckmann apparatus (Centigrade scale being used throughout).

LAND MAMMALS :—	Δ
<i>Sheep</i> (defibrinated blood obtained from slaughter yards) ...	0.59
<i>Rabbit</i>	0.59
ECHIDNA HYSTRIX :—Hibernating (A)	(1) 0.624
(September)	(2) 0.622
Awake (B)	(1) 0.600
(May)	(2) 0.600
LAND REPTILES :—	
<i>Tortoise. Emydura macquariac</i> A	(1) 0.559
	(2) 0.561
	(3) 0.560
B	(1) 0.550
	(2) 0.545
	(3) 0.550
<i>Lizard. Mixed blood of Egernia cunninghami and a species of Tiliqua</i>	(1) 0.639
	(2) 0.637
FISH :— <i>Telcosts</i> (Sea water)— <i>Barracouta</i> A	(1) 0.979
(<i>Thyrsites atun</i>)	(2) 0.978
B	(1) 0.976
	(2) 0.980
(Fresh water)— <i>Murray Cod (Oligorus macquariensis)</i>	0.642
	0.660
	0.650
CRUSTACEAN (Fresh water)— <i>Astacopsis bicarinatus</i>	(1) 0.616
	(2) 0.611
	(3) 0.618

ON THE INFLUENCE EXERCISED BY CERTAIN ACIDS
ON THE INVERSION OF SACCHAROSE BY SUCRASE

By FREDERICK STOWARD, D.Sc., *Department of Agriculture,
Perth, West Australia.*

From the Laboratoire de Chimie Biologique, Institut Pasteur, Paris

(Received August 23rd, 1911)

Among the chemical conditions which influence enzymic action is the degree of alkalinity or acidity of the medium in which the action takes place; that is to say, the rapidity with which a given enzymatic splitting proceeds is influenced by the addition to the reaction medium of small quantities of an acid or base. In general, enzyme action, if certain exceptional cases are excluded, is greatly retarded and ultimately arrested by the addition of comparatively small amounts of a base. The addition of acids to the reaction medium, on the other hand, in small but variable amounts, according to the particular acid employed, appears to favour enzyme activity in certain cases. Most enzymes are, however, remarkably sensitive to changes in the chemical reaction of the medium in which they ordinarily manifest their normal activity, and examples illustrative of this characteristic are not difficult to find.

Malt amylase, for example, as the investigations of Ford¹ demonstrate, evidently function best in a medium which is approximately neutral. Departure from this condition of relative neutrality on either side, provided by the addition of quite minute amounts of either an acid or alkali, leads, as his results indicate, to perceptible diminution of the activity of this enzyme.

The researches of G. Bertrand² afford ample evidence of the extreme sensitiveness of the oxidizing enzyme laccase towards a number of different acids, a very active yet dilute preparation of this enzyme being completely paralysed by quite minute amounts of such acids as sulphuric, hydrochloric, acetic, oxalic, etc.

While a relatively neutral medium favours amylolytic activity, as exhibited by malt amylase, and while the oxidising action of laccase is enormously retarded and eventually completely arrested by minute amounts of different acids, the inversion of cane sugar by sucrase is

1. *Journ. Soc. Chem. Ind.*, XXIII, 8, 1904.

2. *Ann. Institut Pasteur*, XXI p. 673, 1907.

favourably influenced by the presence of small but variable amounts of different acids. Thus, Kjeldahl¹ states that inversion of cane sugar by sucrase is favoured by the addition of very small quantities of sulphuric acid, while larger amounts exercise a marked retarding influence on the action.

The correctness of Kjeldahl's observations was confirmed by O'Sullivan and Tompson,² who state that the most favourable amount of acid varies with the preparation of enzyme employed and the temperature at which the experiment is made. They were, however, unable to explain the cause of the variations observed.

Fernbach's³ researches include a comparative study of the influence exercised by various acids, chiefly organic, on the inversive activity of sucrase. The fact is established that for each acid there exists a certain range of optimal concentration, varying considerably according to the acid employed, within the limits of which the enzyme manifests its maximal activity. The addition of still smaller amounts of acid than those indicated by these limits leads to a slight diminution of the action in most instances, while addition of progressively larger amounts produces great retardation, and ultimately complete arrest of the action, as shown in the case of sulphuric and oxalic acids.

The more recent work of Sørensen⁴ directs attention to the importance of the concentration of the hydrogen ions in enzymatic reactions. Results of experiments on the inversion of cane sugar by sucrase in the presence of sulphuric acid and of mixtures of citrates and phosphates in which solutions of sucrase differing in strength and mode of preparation were employed, tend to prove the statement that, in otherwise equal conditions, the optimal concentration of hydrogen ions in the inversion of cane sugar is *almost* independent of the kind and quantity of sucrase employed, and likewise of the acidifying reagent utilised.

Although the fact has been established, that in general the presence of small amounts of different acids exercises a favourable influence on the inversive function of sucrase, it nevertheless appeared to be of interest to investigate the subject anew by the employment of different acids either in molecular concentrations or in amounts proportional to these latter, and further to endeavour to ascertain whether highly ionised acids

1. *C. R. des travaux du Lab. de Carlsberg*, 1879 and 1881.
2. *Journ. Chem. S c.*, LVII, p. 854, 1890.
3. *Thèse doct. Sciences Paris*, 1890.
4. *C.R. des Travaux du Lab. de Carlsberg*, 1909.

(such as hydrochloric, etc.) markedly differentiate themselves from the less highly ionised acids (such as phosphoric and acetic acids) in the influence they exercise on the activity of this enzyme.

The present paper, therefore, contains a short account of the results furnished by this method of enquiry.

PREPARATION OF SUCRASE

While it is impossible to prepare a solution of sucrase completely exempt from substances which are capable of interacting with acids or bases, yet by repeatedly adhering to an identical method of procedure, preparations may be obtained which differ among themselves in a minor degree only, and, therefore, probably possess a sufficient degree of purity to permit of their being employed in experiments of a comparative nature.

Following the method indicated by Duclaux, and utilised by Fernbach¹, cultures of *Aspergillus niger* were established on Raulin's solution and continued for four to five days at a temperature of 30° C. The mycelium having attained maturity, generally indicated by the commencement of blackening over its entire upper surface, the culture liquid after careful decantation and thorough washing of its under surface with distilled water² (the operation being repeated several times), was replaced by a definite volume of distilled water. The plasmolysis of the mycelium was thus established, and shielded from the light was allowed to proceed for forty-eight to fifty hours at 30° C., and invariably yielded an almost colourless solution of sucrase possessing a satisfactory degree of activity. In this connection it is to be noted that during plasmolysis of the mycelium it must not be submerged; to obtain a satisfactory preparation of the enzyme by this means it is desirable that only the under surface of the tough mycelial growth shall be in contact with the plasmolysing liquid. In the preparation of the culture and the subsequent operations of decantation, washing and maceration of the mycelium, Fernbach's flasks are specially serviceable. Each of these flat-bottomed flasks, in which a volume of culture liquid having a depth of about 2 to 3 cm. is placed, has a lateral tubulure by means of which aeration of the mould during its growth may be conveniently carried

1. *Loc. cit.*

2. Throughout, in these cultural and also the inversion experiments, the water employed was prepared by re-distillation, under diminished pressure, of ordinary distilled water with the aid of a glass apparatus.

out. Under these conditions *Aspergillus* makes regular and vigorous growth. Repeated experience of this, and trial of other methods of culture, showed distinctly the superior advantages afforded by the employment of the Fernbach flasks in these cultural experiments.

Under the above conditions it is possible to prepare an active solution of sucrase entirely free from other disturbing organisms, but often containing minute mycelial fragments which may still possess tardy or limited powers of development. Such a solution exposed to free access or even a limited volume of air, as experience of such preparations retained under these conditions showed, leads more or less speedily to diminution either of the quantity of active enzyme or of its activity.

The experiments, to be presently described, were carried out in sections, each comprising a certain range of concentrations of the acid under investigation, and the period of time involved in passing from the initial to the final series of concentrations of acid covered several days. Hence, in order to render the results of one portion of an experiment comparable with those of another, a necessary condition imposed was that the enzyme solution should be conserved in such a way as to retain, as far as possible, its original activity. As it is almost impossible rapidly to prepare solutions of enzymes which are quite identical, the following method of procedure was followed. A number of pipettes were made, each of such a capacity that its contents sufficed for a single sectional series of experiments. After sterilisation, these pipettes were filled with the sucrase solution and at once hermetically sealed. The enzyme solution thus aseptically collected and protected from the action of diffuse daylight, was conserved without undergoing any very marked alteration even during considerable periods of time.

MODE OF OPERATION

To study the influence of the different acids investigated on the inversion of sucrose by sucrase, after a number of preliminary trials the following method of experiment was adopted:—

Into each of a series of tubes exactly 5 c.c. of a 20 per cent. solution of saccharose and definite volumes of acid and water were measured, which, after the addition of the sucrase solution, brought the total volume of the reaction medium to 10 c.c. Corresponding series of

controls were similarly prepared, with the addition of a solution of passive sucrase prepared by raising the enzyme solution to the boiling point and retaining it at that temperature for some minutes. The contents of each tube containing the solution of saccharose, together with the requisite volume of water, were first allowed to acquire the temperature of the latter. The requisite volume of acid was then added, well mixed, and a definite and equal interval of time permitted to elapse before the addition of the enzyme-solution, in order that inversion due to the acid itself might be identical in the experimental tube and in its corresponding control, and then, after addition of the enzyme solution, the experiment was continued for one hour at 56° C. and terminated by adding a very moderate excess of strong soda solution.

Finally, the contents of each tube were diluted to 50 c.c., and the amount of inversion measured by determining the copper-reducing power of a definite volume of this dilution.

Throughout the course of this work these determinations, carried out in duplicate, were effected by means of the method of Mohr, as modified by Bertrand.¹

Carefully standardised solution of acids have been employed, and in preparing the more dilute solutions for the weaker concentrations, quantities of not less than 200 c.c. of each dilution have been freshly prepared.

The volume of sucrase solution employed in each sectional series of experiments has been so chosen as to produce under the given conditions of time, temperature, etc., an amount of inversion of approximately the same order of magnitude.

In the tables which follow, the quantities of saccharose inverted are given in milligrams; these values representing the results obtained after deducting the amounts furnished by the corresponding control experiments with passive enzyme in the presence of similar quantities of acid.

Experiments were first undertaken with representatives of the 'strong' acids in the physico-chemical sense, namely, sulphuric, hydrochloric and nitric acids.

1. *Bull. Soc. Chim.*, XXXV, p. 1285, 1906.

Concentration of acid				H ₂ SO ₄		HCl		HNO ₃	
				(i)	(ii)	Sucrose inverted		(i)	(ii)
					(i)	(ii)			
0.00	(Control) ¹	115.0	109.2	111.6	142.0	151.0	151.0
N.50	9.8	9.3	0.00	0.00	6.6	6.6
60	21.8	20.7	9.3	14.0	10.3	8.7
70	23.2	22.0	19.5	27.2	17.6	14.6
80	29.0	27.5	38.0	40.3	29.5	24.9
<hr/>									
0.00	(Control) ²	120.0	114.0	—	137.2	151.0	151.0
N.90	36.3	34.5	38.7	51.4	49.7	38.5
100	40.5	38.7	52.7	76.9	61.7	61.7
200	80.0	76.0	81.8	135.8	144.8	149.6
500	117.5	111.6	105.9	150.0	183.8	183.8
<hr/>									
0.00	(Control)	117.5	111.5	111.6	139.2	150.5	151.0
N.1000	119.0	113.5	117.5	155.5	181.9	176.2
2000	118.0	112.0	122.5	143.7	160.5	163.4
<hr/>									
0.00	(Control)	—	—	—	—	—	171.9
N.3000	114.5	108.7	118.7	145.8	165.7	180.5
4000	110.0	104.5	118.7	145.8	166.2	171.5
5000	115.0	109.2	97.8	142.5	159.6	172.0

These experimental results show that these acids in minute amounts favour, in a varying degree, the inversion of saccharose by sucrase. For each acid there exists a range of concentrations within the limits of which the action proceeds most rapidly, while the addition of gradually increasing quantities of acid leads to its progressive retardation, until ultimately when the concentration of the acid attains a value of about N/50 practically complete arrest of the action ensues. In general, amounts of these acids corresponding to concentrations ranging from N/1000 to N/5000 exercise a favourable influence on the action of the enzyme.

The method of measuring the amount of inversion by determining the copper-reducing power of the products of change, evidently does not permit of the defining of any one particular concentration as the optimal one, because the change in the amount of saccharose inverted in the

1. Control in this and succeeding experiments containing sucrose and enzyme without addition of acid.

2. Although solution of enzyme employed here perceptibly stronger, results are not quite comparable with those of first experiment.

passage from one dilute concentration of acid to the other of these optimal ranges of concentrations is relatively small. Moreover, it is probable that small amounts of substances capable of fixing a relatively large proportion of the added acid now make their presence felt, and thus somewhat obscure the actual influence exercised by the acid on the action of the enzyme.

The three acids so far examined are typically strong acids, and the experimental results adduced show that their behaviour is very similar.

The influence of phosphoric acid on the progress of the action affords a marked contrast to that exercised by either of the foregoing acids, as the following experiment shows:—

Concentration of acid	Phosphoric acid Saccharose inverted Milligrams
0·00 (Control)	135·8
M/10	8·0
M/20	44·3
M/40	91·2
0·00 (Control)	164·3
M/60	124·9
M/80	140·6
M/100	152·4
M/200	166·3
0·00 (Control)	144·4
M/500	169·1
M/1000	163·4
M/2000	164·3
M/4000	158·6

To effect virtual arrest of the enzymatic action, a concentration of acid equivalent to that of an M/10 solution of the acid is required. The range of optimal concentrations evidently lies within the limits of M/200 and M/4000. The acid behaves somewhat similarly to a monobasic acid, apparently containing only one active hydrogen atom, a point already indicated by the work of G. Bertrand.¹

The following experiment with KH_2PO_4 lends support to this supposition, for in the experimental condition employed this salt is without any influence on the action of the enzyme.

1. *Loc. cit.*

Concentration of salt		Potassium dihydric phosphate Saccharose inverted Milligrams	
0.00 (Control)	159.6
M/5	160.5
M/10	159.6
M/20	159.6
M/40	159.6

The influence exercised by acetic acid on the action is peculiar. When comparison is made with the other acids examined, the principal feature exhibited is that relatively large amounts of this acid, as already evidenced by the investigations of Fernbach,¹ favour inversion instead of retarding it. This favourable influence is manifested, as the following experiment shows, over a wide range of concentrations. In the presence of amounts of acid corresponding to that of N/500 to N/2000 solutions, this favouring influence, however, declines somewhat.

Concentration of acid		Acetic acid Saccharose inverted Milligrams	
0.00 (Control)	121.6
N/1	71.2
N/2.5	119.7
N/5	128.2
N/10	133.9
N/20	137.7
0.00 (Control)	120.6
N/40	130.1
N/60	130.0
N/80	132.0
N/100	133.0
0.00 (Control)	151.0
N/200	167.2
N/500	159.6
N/1000	156.7
N/2000	155.8

1. *Loc. cit.*

SUMMARY

The results described in this paper show that within the limits represented by certain concentrations, each of the acids examined exercises a favourable influence on the inversion of saccharose by sucrase. The amounts of acid which exercise this favouring influence, as well as the extent of the latter, exhibit considerable variation, and apart from other considerations are apparently dependent on the nature of the acid and the proportion of enzyme employed.¹ Thus, while the action proceeds most rapidly in the presence of comparatively small quantities of sulphuric, hydrochloric, nitric and phosphoric acids, a similar result also ensues even where relatively much larger amounts of acetic acid are included in the reaction medium.

The retarding influence exhibited by these various acids also differs in a similar sense. It is most marked in the case of sulphuric, hydrochloric and nitric acids; amounts of these acids in the reaction medium corresponding to that of an N/50 solution being sufficient to almost completely arrest enzymatic action. Phosphoric acid behaves similarly when the quantity present is equivalent to that of an M/10 solution of this acid. The behaviour of acetic acid in this respect is singular; even when the amount present corresponds to that of an N/1 solution the action, instead of being completely arrested, is merely retarded to a pronounced extent.

In general the results demonstrate that the retarding and arresting influence exercised by the acids investigated on saccharose-inverting action of sucrase differs in a marked degree from that observed by

1. In view of the work of Sørensen, it appears to be not improbable that the observed changes in the progress of inversion of saccharose by sucrase in presence of varying quantities of the different acids examined actually turns, not on the degree of the acidity of the reaction medium, but on the concentration of the hydrogen ions present at each stage of the experiment.

On such an assumption the differences exhibited in the optimal range of concentrations possessed, for example, by acetic and phosphoric acids, as compared with the other acids investigated might perhaps be brought into line.

While the results of this enquiry confirm the favourable influence exercised, it is equally evident that the difficulty of determining the optimal range of concentrations for a given acid becomes a matter of difficulty on account of the disturbing influence of minute amounts of foreign substances unavoidably present in the enzyme solution, the influence of these being progressively more marked with diminution of the quantity of acid employed.

G. Bertrand¹ with these reagents in the case of laccase, the oxidising action of this enzyme being completely arrested by very minute amounts of sulphuric, hydrochloric, phosphoric and acetic acids.

In conclusion the writer desires to record his acknowledgements to M. Gabriel Bertrand for the laboratory facilities he so kindly placed at his disposal, and also for much critical and useful advice generally accorded during the progress of this enquiry.

1. *Loc. cit.*

THE PHYSIOLOGICAL ACTION OF INDOLETHYLAMINE

By P. P. LAIDLAW.

From the Wellcome Physiological Research Laboratories, Brockwell Hall, Herne Hill, S.E.

(Received September 7th, 1911)

The indolethylamine with which this paper deals is 3- β -aminoethylindole. It is the amine corresponding to the amino-acid tryptophane. A number of amines formed from the native amino-acids by the elimination of CO₂ have been shown to be physiologically active substances.^{1, 2, 3, 4.}

It appeared probable that indolethylamine would be physiologically active, and a brief investigation of its action on the normal animal be of some interest. The synthesis of this amine was accordingly undertaken by Mr. A. J. Ewins,⁵ to whom I am indebted for a supply of material for physiological experiments. At the same time I prepared a small quantity of the base by putrefaction from tryptophane (see Note on p. 150).

The Intact Animal. Subcutaneous administration of the hydrochloride of indolethylamine to cats and rabbits gives rise to practically no symptoms, a rapid heart is the only certain symptom observable after 100 mgm. doses. (In the cat, symptoms of nausea, uneasiness, salivation, etc., may occur.) It will be seen later that indolethylamine produces vaso-constriction; its absorption after this method of administration will therefore probably be somewhat slow; the effects it produces are of short duration, and hence symptoms will not be well marked unless very large doses are given by this means. Ten milligram doses were given to rabbits by the marginal ear vein. In each case, immediately after the injection, a spastic condition of the limbs developed, on which was superimposed a fine, rapid tremor of fore and hind limbs; this condition persisted for about one minute and then rapidly disappeared. The respiration became slow, temporarily, and then recovered. The heart one minute after the injection was accelerated. A

1. Dale and Dixon, *Journ. of Phys.*, XXXIX, p. 25, 1909.
2. Barger and Dale, *Journ. of Phys.*, XLI, p. 19, 910.
3. Ackermann and Kutscher, *Zeit. für Biol.*, LIV, p. 387, 1910.
4. Dale and Laidlaw, *Journ. of Phys.*, XLI, p. 318, 1910.
5. Ewins, *Trans. Chem. Soc.*, XCIX, p. 270, 1911.

small cat was given 20 mgm. of indolethylamine hydrochloride intravenously (long saphena vein), and a remarkable series of symptoms ensued. Within thirty seconds of the administration violent convulsive movements of limbs and body occurred, quite suddenly these clonic spasms became tonic: the fore limbs were spread out straight in front, paws off the ground and claws protruded; hind limbs stiff, flexed on the trunk, and claws extended. A fine tremor was present in all limbs. The pupils were dilated, salivation was marked, and although the animal had purred contentedly during the injection it now exhibited a high degree of excitement. These symptoms were maximal in one minute, and passed off in about three minutes. The cat sat up, all signs of muscular spasm had disappeared, it was once more docile and purred when stroked. Salivation continued for three or four minutes more. The pupils became small slits about three minutes after the injection and remained so even in dull illumination. Fifteen minutes after the first symptoms the cat appeared to be perfectly normal. The heart beat was good throughout the experiment, but respiration was severely interfered with during the convulsive stage, being jerky and irregular. It is very probable that a slightly larger dose would have caused death from respiratory failure.

The convulsive movements seen in the intact animal on intravenous administration of indolethylamine appear to be due to a transient stimulation of the central nervous system. A very similar series of muscular movements is seen when a spinal cat, under artificial respiration, is given a small dose intravenously. On complete destruction of the cord these symptoms disappear. It is noteworthy that the effect is peculiar to warm-blooded animals. Frogs receiving doses of 10 mgm. showed no sign of convulsions. The symptoms shown by the latter animal are a gradually increasing depression culminating in coma.

The Vascular System. Indolethylamine produces a large rise of blood pressure in the spinal cat when administered intravenously (see fig. 2). The pressor effect has a superficial resemblance to that produced by a small dose of adrenine. The rise of pressure is very rapid, and is accompanied by an increased rate of heart beat and the return to normal follows quickly upon the attainment of the maximum. Tonic contraction and tremors of trunk and limb muscles also occur, which may help in producing the rise of pressure through raising the intra-abdominal pressure. This, however, is quite a subsidiary factor since large rises of pressure are obtainable with the abdomen laid open. Direct comparison of rises of pressure produced by equal doses before and after opening

abdomen is untrustworthy, since a second dose of the base rarely produces quite as large an effect as the first. In the animal anaesthetised with volatile anaesthetic the rise of blood pressure is never as great as in a spinal animal. The normal blood pressure is higher, the cardio-inhibitor mechanism prevents any large rise, the anaesthetic depresses the heart's response to most drugs, and, therefore, a large rise of blood pressure is impossible. Moreover, large doses cannot be given in this condition since the respiratory centre, already somewhat depressed by the anaesthetic, may be paralysed by comparatively small doses of the base. Five milligrams may cause respiratory arrest in an anaesthetised animal, while an intact cat, as shown above, survived 20 mgm. The difference can only be due to the anaesthetic depression of the respiratory centre.

The rise of blood pressure is due to vaso-constriction and increased cardiac activity. Fig. 1 shows a tracing of the isolated heart of a rabbit, together with a drop record of the coronary outflow; between the arrows 3 mgm. of indolethylamine were injected into the perfusion cannula. It will be observed that there is a considerable rise in the tone of the heart muscle, accompanied by a greatly increased rate of heart beat; a count of the heart beat shows that the rate is increased by one-half (from 18 to 27 in equal time intervals). The coronary outflow is quicker. It is probable that the last-mentioned feature of the tracing is due to the increased rate of heart beat, and not to an actual dilatation of the coronary vessels. The heart beat exerts such a profound influence on the coronary circulation that the increase seen in this tracing could easily be explained in this way. Moreover, as will be seen later, all forms of plain muscle, elsewhere in the body, which respond to the new base, show motor effects irrespective of innervation, and it is improbable that the coronary vessels behave in an exceptional manner. The vaso-constriction may be observed on inspection of the viscera after intravenous administration, and also after local application of a 1 in 1000 solution to a highly vascular surface. The effect is not nearly so striking as that produced by adrenaline. A diminution of viscus volume is not readily demonstrated in oncometer experiments. As a rule, the first effect is constriction, but this is often followed by a secondary dilatation. This diphasic response is probably due to the vessels in the plethysmograph giving an abnormal response. The exposure, cooling, and manipulation necessary in the introduction of a viscus into a plethysmograph frequently destroys the sensitiveness of the preparation. The initial constriction is the true result, and the

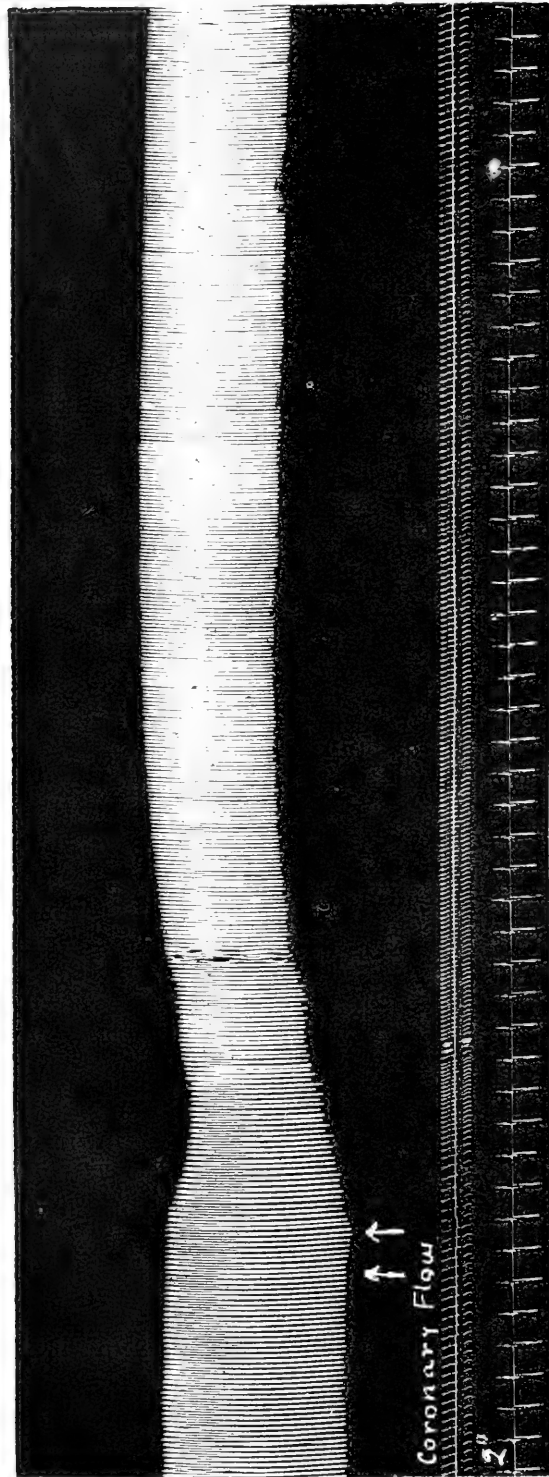

FIG. 1.—Isolated heart, rabbit, Locke Langendorff. Between arrows 3 mgm. indolethylamine injected into perfusion cannula.

dilatation following is due to the large rise of blood-pressure dilating arterioles which, though stimulated to constrict, owing to abnormal conditions are unable to do so against a large rise of blood pressure. Occasionally a pure diminution in volume is observed. There can be no doubt that considerable vaso-constriction does occur, but the exact method by which this vaso-constriction is brought about is not so certain. The vaso-constriction is undoubtedly due in part to a peripheral effect of the amine upon the plain muscle of the arterioles, because after large paralytic doses of nicotine or curare have been given to a spinal cat, a rise of blood-pressure is still obtainable with 3 or 4 mgm. indolethylamine. This rise is, however, diminished by about half by the administration of nicotine. In this experiment the ganglion cells and the paths from cord to periphery are paralysed completely. It is possible that the diminution in response to the new base brought about by paralytic dose of nicotine is an expression of the cutting-out of vaso-constrictor impulses of central origin. A similar effect is observed after paralytic doses of ergotoxine. In cats which had received ergotoxine in sufficient quantity to reverse the adrenine response (Dale¹) a pressor effect is still elicited by indolethylamine, but this pressor effect is not nearly so striking as that observed previous to the administration of ergotoxine. If one could regard nicotine and ergotoxine as having a selective paralytic action on the nervous structures, a central factor in the pressor effect induced by indolethylamine would be proved. Unfortunately nicotine and ergotoxine have a decided effect on plain muscle itself. As far as these experiments are trustworthy they suggest a central factor of some importance. This suggestion is borne out by the following further evidence. In a spinal cat preparation, the rise of blood pressure brought about by the intravenous administration of 2 mgm. indolethylamine was recorded. The cord was then completely destroyed, and after a short interval the effect of the same dose of indolethylamine was recorded once more. The effect of the second dose was about half the first. The evidence of a general stimulant effect on the cord, as illustrated by the generalised muscular spasms, has already been described. The balance of evidence is decidedly in favour of a mixed origin of the vaso-constriction: (1) central from vasomotor centres in the cord, and (2) peripheral upon the plain muscle of the arterioles.

One or two features of interest are met with in the responses of the

1. Dale, *Journ. of Phys.*, XXXIV, p. 163, 1906, and *Bio-Chem. Journ.*, II, p. 240, 1907.

several organs of the body containing plain muscle; of these the uterus and the eye are the most interesting.

The Uterus. Fig. 2 shows the typical action of indolethylamine upon the virgin cat's uterus *in situ*, and upon the blood pressure. Just after the rise in blood pressure has started to develop, the uterus

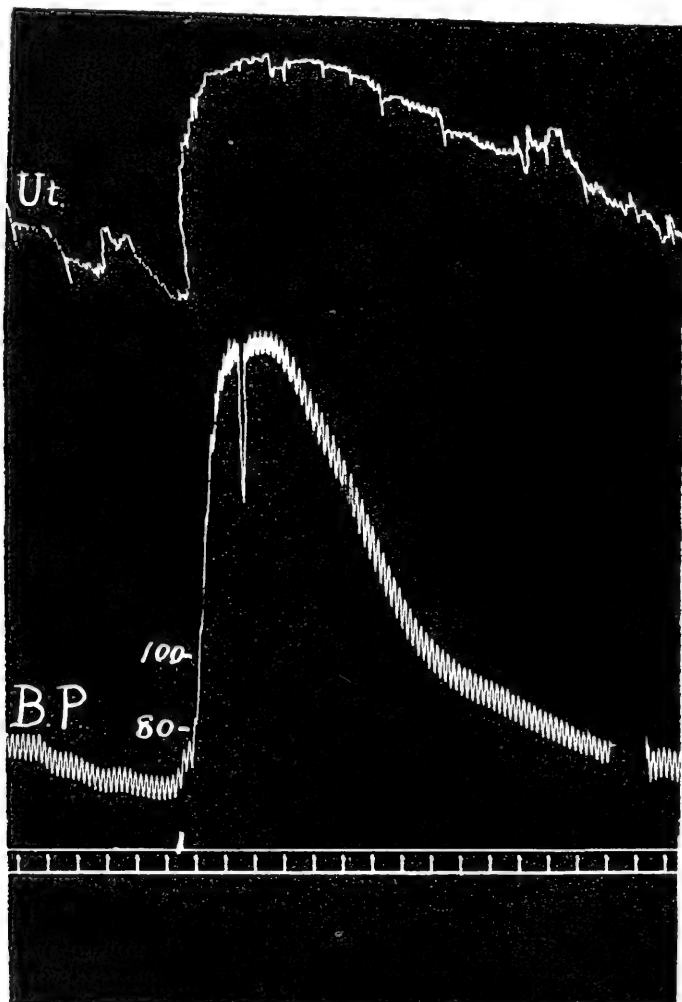

FIG. II.—Spinal cat. Virgin. Effect of 2 mgm. indolethylamine.
Uterine Contractions. Blood Pressure.

commences to relax. This effect is not abolished by section of the hypogastrics. This combination of effects is suggestive of an adrenine type of action. But this is not borne out by further experiment, for if the virgin cat's uterus be isolated, suspended in Ringer solution, and its movements recorded graphically, the opposite result is obtained. The

new amine always produces motor responses from a virgin cat's uterus in this condition. Fig. 3: In the pregnant cat a well-marked motor response is obtained on administration of indolethylamine. Fig. 4: The rabbit's uterus and the guinea-pig's do not respond well to the new base. In two rabbits, where adrenine and other drugs produced well-marked contractions of the uterus, indolethylamine was without action. This difference in action on the virgin cat's uterus *in situ* and when isolated, is one that is not readily explained. If it were demonstrable that the new amine had an action resembling that of nicotine, the explanation is obvious. The result in any given experiment would be the sum of two variables: (1) stimulant action on plain muscle, hence motor response in the isolated organ; (2) stimulation of sympathetic ganglion cells or peripheral neurone supplying the uterus. The dominant supply in the case of the virgin cat is inhibitor, hence relaxation *in situ*. The dominant supply in the pregnant cat is motor, and thus the nervous influence aids the muscular one. Experiments with a view to demonstrating a nicotine-like action of indolethylamine on the superior cervical ganglion or on the splanchnic system all failed. It is quite possible that this substance has an action on the peripheral neurone supplying the uterus as well as on the muscle of the organ, but not on the peripheral sympathetic neurones elsewhere. Very similar effects have been described by myself with a number of other substances (hydrastinine, cotarnine, and 6:7-dimethoxy-2-methyl-3:4-dihydro isoquinolinium chloride), and the same explanation was tendered. There is some peripheral structure which does not survive excision, and determines the action of many substances upon the cat's uterus *in situ*. From the manner in which the response varies with the dominant nerve supply to the uterus, and the close parallelism which exists between the action of these substances and that of nicotine on this organ, it is suggested that the unknown peripheral structure is nervous, probably the peripheral neurone. It is, unfortunately, impossible to submit the problem to the crucial experiment of excision of these ganglion cells, owing to their scattered peripheral distribution.

The Iris. Upon the plain muscle of the iris indolethylamine has a well-marked effect in doses of 10 to 20 mgm. If a dose of this size be given intravenously to a cat with pithed brain, the pupil becomes constricted to a fine slit (fig. 5). This contracted pupil persists for several minutes. Smaller doses produce smaller effects which are less lasting. A further dose of 20 mgm. produces a dilatation of the pupil, and the elongated oval opening tends to become circular. This dilatation

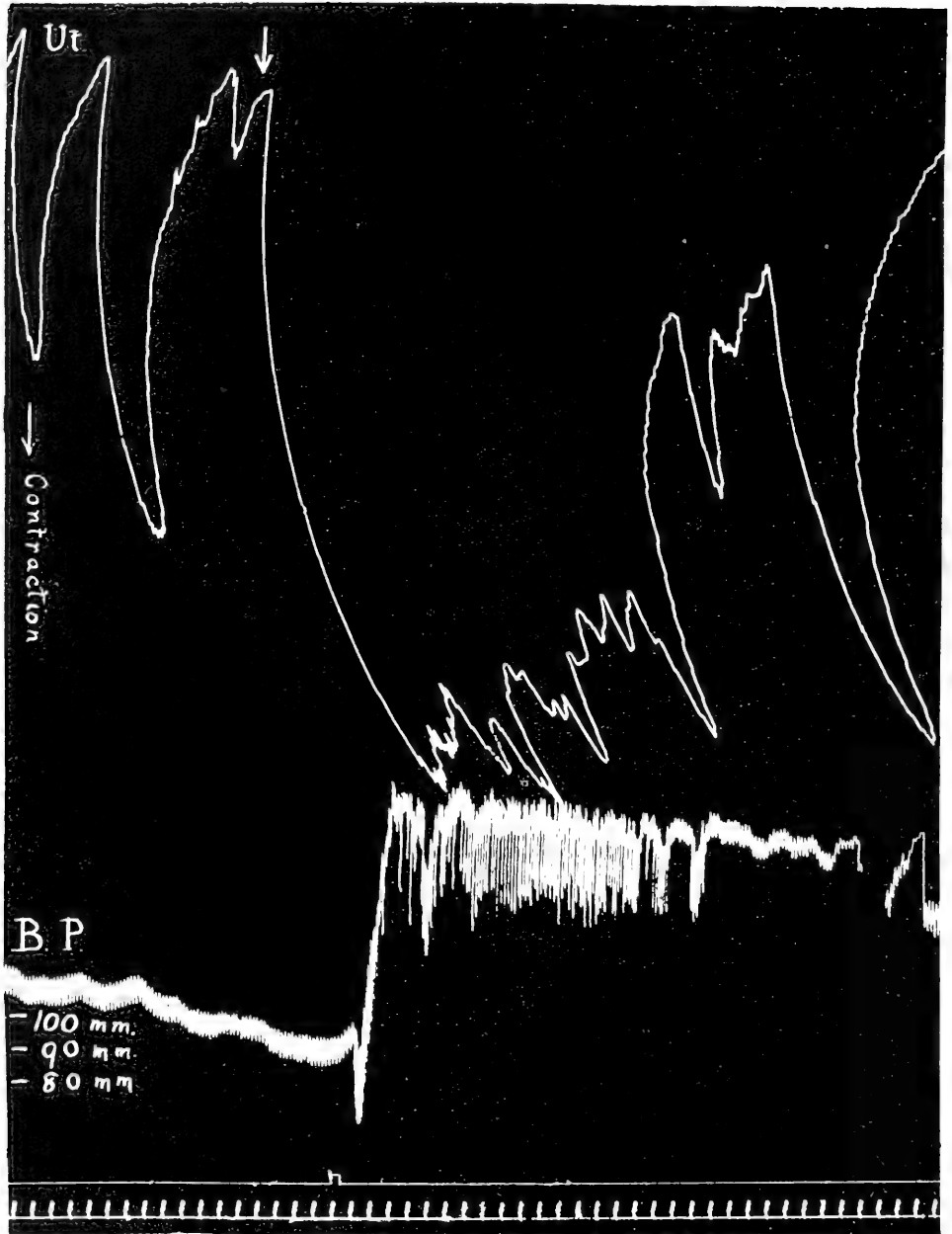

FIG. III. —Isolated uterus. Virgin cat. Effect of 10 mgm. indoethylamine in 250 c.c. Ringer's solution.

gradually gives way again to profound constriction, and once more a thin black slit is all that is visible. Stimulation of the cervical sympathetic can still produce some dilatation at this stage. Full doses of atropine do not abolish the slit-like pupil or prevent its appearance. It must, therefore, be regarded as of direct muscular origin. The tendency to form a circular pupil after the second injection indicates a simultaneous motor effect upon both sphincter and dilator muscles, the sphincter muscle being the more powerful, ultimately overcomes the dilator muscle and produces the slit-like pupil. The effect is not observable in cats anaesthetised with chloroform or ether, nor in an intact cat which received 100 mgm.

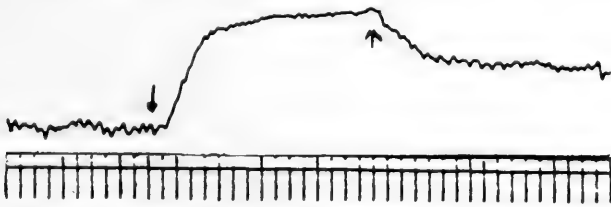

FIG. IV.—Cat. Ether. Pregnant. Effect of 10 mgm. indolethylamine. Uterine Contractions. Blood Pressure.

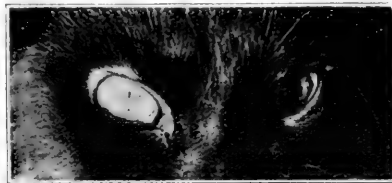

FIG. V.—Cat. Pithed brain. Circulation to left eye impaired by cannula in left common carotid. Effect of 20 mgm. indolethylamine on pupil of right and left.

hypodermically. It can only be produced by intravenous administration to an intact animal or one which is anatomically anaesthetised. Instillation, like hypodermic administration, is without effect.

Other plain muscle. The plain muscle of the intestine is mildly stimulated by indolethylamine. The effect is better shown in the isolated organ, but even in this condition the effect of 20 mgm. of the base in 250 c.c. Ringer solution is very small. The retractor penis of the dog also gives weak motor responses to the amine when isolated from the body. The plain muscle of the bladder is thrown into contraction on administration of 2 or 4 mgm. of indolethylamine; and a bladder, which before administration of the base was quiescent, may develop a slight rhythm. The amount of contraction of the bladder volume under the influence of indolethylamine is increased on destruction of the cord.

The salivation observed in cats receiving hypodermic or intravenous

doses of the new base must be central in origin, for no evidence of salivary secretion could be obtained in the anaesthetised animal. The pancreatic secretion in the dog is unaffected by indolethylamine. Ten milligrams of indolethylamine were given intravenously to an anaesthetised cat in which the urinary secretion was being recorded. A marked slowing of the urine flow was observed during the rise of blood pressure, which, however, soon passed off. The effect is in all probability the expression of a transient constriction of the arterioles of the kidney. Experiments in conjunction with Mr. A. J. Ewins, are in progress with regard to the metabolism of the new base.

NOTE ON THE FORMATION OF INDOLETHYLAMINE FROM TRYPTOPHANE

It has been shown by several observers that putrefactive micro-organisms will remove CO_2 from amino-acids and form the corresponding amine. It was thought possible that indolethylamine might be made in this manner from tryptophane. A number of experiments were carried out with different mixtures of bacteria: only one of them proved successful. 0.5 gram tryptophane was dissolved in 250 c.c. of a simple culture medium.¹ This was then infected from a putrid pancreas subculture which had been shown to be capable of forming β -iminazolylethylamine from histidine and *p*-hydroxyphenylethylamine from tyrosine. After one fortnight's incubation the mixture was found to produce a good rise of blood pressure, and indolethylamine could be isolated from it. The mixture was boiled with charcoal and filtered. It was then evaporated to about 100 c.c. and excess of picric acid added. On cooling, the highly insoluble indolethylamine picrate separated out as a deep orange-red crystalline precipitate. The crude product was then recrystallised from alcohol and again from aqueous acetone, when crystalline form, colour reactions, melting point, and physiological action were found to be identical with those of the synthetic product. The yield from the one experiment which went in the desired direction was poor, about 140 mgm. of pure picrate being obtained from 0.5 gram tryptophane.

SUMMARY

(I) Indolethylamine produces a transient stimulant effect upon the central nervous system, causing clonic and tonic convulsions, tremors of limbs, and vaso-constriction.

(II) It has a direct stimulant action on plain muscle, which is most marked in the arterioles, the iris, and the uterus.

(III) The formation of indolethylamine from tryptophane by bacterial action is described.

1. Peptone 2 grm., dextrose 8 grm., trace sodium phosphate, trace magnesium sulphate, precipitated calcium carbonate 5 grm., and tap water to the litre.

THE EFFECTS OF CAFFEINE UPON THE GERMINATION AND GROWTH OF SEEDS

By FRED RANSOM, M.D., *Edinburgh, Beit Research Fellow.*

From the Pharmacological Laboratory, Cambridge

(Received November 7th, 1911)

The following report contains the results of some preliminary experiments made to ascertain the effect of subjecting seeds to the action of caffeine.

The method adopted was to take two equal quantities of each sort of seed and place one lot in 1 per cent. solution of caffeine in tapwater, the other in tapwater alone. Both sets were then left for twenty-four hours in a thermostat at 25° C. At the end of this period each portion of seed was washed on a muslin filter with tapwater and sown in ordinary coarse garden sand. Very small seeds were first mixed with a little dry sand, so as to allow of equal distribution. The sowings were made in red flowerpot saucers, placed in the laboratory windows and watered as required. Care was taken that the conditions of light and temperature were as far as possible equal. The results observed are given in tabular form at the end of this report, Table I.

Although the list of seeds is comparatively short, still the results obtained are so uniform that they can hardly be attributed to chance. In every case except one (nasturtium) the seeds which had been treated with caffeine were later in germinating than the tapwater controls, and in a great majority of cases fewer seeds germinated in the caffeine groups. In the course of growth the caffeine seeds were at first relatively less vigorous than those from tapwater, and in many cases they remained so till the end of the experiment. In three caffeine groups no seeds germinated. In no instance except the nasturtium had the caffeine groups any advantage over the controls.

The well-known action of caffeine upon striped muscle and its effect on plant cells, as described by Bokorny,¹ show that it has a disintegrating effect upon certain vegetable and animal proteins. In the case of muscular tissue there is considerable resemblance between the action of caffeine and that of chloroform, toluol, ether, alcohol, and similar bodies. With plants, on the contrary, there would appear to be a notable difference. This may be shown by an adaptation of the method

described by Armstrong² for the rapid detection of emulsine, and by Waller³ for the colorimetric estimation of hydrocyanic acid. The following, Table II, demonstrates the difference in action of two members of the chloroform group on the one hand and caffeine and formaldehyde on the other.

TABLE II

			Condition of solution after 3 hours at 37° C.	Condition of solution after 24 hours at 37° C.
Laurel leaf immersed in	Na picrate solution Aqua	5 c.c. 35 c.c.	Unchanged	Unchanged
„	Na picrate solution Aqua Chloroform	5 c.c. 35 c.c. 12 drops	Dark-red-brown	Dark-red-brown
„	Na picrate solution Aqua Toluol	5 c.c. 35 c.c. 1 c.c.	Dark-red-brown	Dark-red-brown
„	Na picrate solution 1% Caffeine solution	5 c.c. 35 c.c.	Unchanged	Unchanged
„	Na picrate solution 1% Formaldehyde	5 c.c. 35 c.c.	Unchanged	Unchanged
„	Na picrate solution 10% Formaldehyde	5 c.c. 35 c.c.	Unchanged	Unchanged

Even when the immersion in caffeine solution was prolonged to forty-eight hours there was no production of hydrocyanic acid; but the same leaf, placed afterwards in chloroform water with sodium picrate, quickly turned the solution brown. The two protoplasmic poisons, caffeine and formaldehyde, obviously act upon the laurel leaves in a manner different from that of chloroform.

It seems not unlikely that caffeine may produce its effects both on muscle and on seeds by increasing the activity of a protease. If this were the case it might be expected that in small doses it would stimulate germination and growth. Caffeine in dilute solution applied to muscle increases the response to stimulation, whereas in greater concentration it induces rigor and death. I am inclined to ascribe the exceptional position of the nasturtium seeds in these experiments to the density of the seed-covering limiting the access of caffeine.

In the meantime the present paper brings evidence that caffeine in 1 per cent. solution may retard or even prevent the germination and growth of seeds. In a paper which has just appeared Bokorny⁴ gives some instances of the deleterious effects of caffeine upon seedlings.

TABLE I

Name of seed			Previous treatment 24 hours at 25° C. in	Quantity	Date of planting	Sprouts first visible	Condition 4 weeks after planting
Endive	Tap water	0.5 g.	29/4/11	7/5/11	Fewer seeds have germinated in Caffeine group. The growth in both groups is about equal.
..			1% Caffeine	0.5 g.	..	11/5/11	
Onion	Tap water	0.5 g.	..	11/5/11	Fewer seeds have germinated in the caffeine group, and they are shorter and thinner than those of the tap-water group.
..			1% Caffeine	0.5 g.	..	3/6/11	
Lettuce	Tap water	0.5 g.	..	8 5/11	Fewer seeds have germinated in the caffeine group. The growth in both groups about equal.
..			1% Caffeine	0.5 g.	..	12/5/11	
Cress	Tap water	0.5 g.	..	5/5/11	Fewer seeds have germinated in the caffeine group. Growth about equal.
..			1% Caffeine	0.5 g.	..	7/5/11	
Turnip	Tap water	0.5 g.	..	5/5/11	About the same number have germinated in each group, and the seedlings are about equally vigorous.
..			1% Caffeine	0.5 g.	..	7/5/11	
Carrot	Tap water	0.5 g.	30/4/11	12/5/11	Fewer seeds have germinated in the caffeine group, and they are less vigorous than those of the tap-water group.
..			1% Caffeine	0.5 g.	..	22/5/11	
Radish	Tap water	0.5 g.	..	4/5/11	About the same number of seeds have germinated in each group and the seedlings are about equally vigorous.
..			1% Caffeine	0.5 g.	..	6/5/11	
Spinach	Tap water	0.5 g.	..	6/5/11	About equal in number and vigour.
..			1% Caffeine	0.5 g.	..	8/5/11	
Sweet peas	Tap water	12	..	9/5/11	Nine seeds of tap-water group have germinated, average length 12 inches; four seeds of caffeine group, with average length 4 inches.
..			1% Caffeine	12	..	30/5/11	
Peas	Tap water	10	..	6/5/11	Of tap-water group six seeds have germinated, average length 22 inches; of caffeine group five seeds have germinated, average length 18 inches.
..			1% Caffeine	10	..	12/5/11	

Name of seed	Previous treatment 24 hours at 25° C. in	Quantity	Date of planting	Sprouts first visible	Condition 4 weeks after planting
Broad beans "	... Tap water 1% Caffeine	6 6	1/5/11 "	12/5/11 Nil.	Six seeds of tap-water group have germinated, vigorous plants.
Nasturtium "	... Tap water 1% Caffeine	14 14	4/5/11 "	30/5/11 21/5/11	Six seeds have germinated in the tap-water group, nine in the caffeine. Both are about equally vigorous.
Viscaria "	... Tap water 1% Caffeine	0.5 g. 0.5 g.	" "	16/5/11 18/5/11	Fewer seeds have germinated in the caffeine group. Both groups about equally vigorous.
Helianthus "	... Tap water 1% Caffeine	0.5 g. 0.5 g.	" "	13/5/11 18/5/11	Fewer seeds have germinated in the caffeine group. Both groups about equally vigorous.
Nemophila "	... Tap water 1% Caffeine	0.5 g. 0.5 g.	" "	10/5/11 16/5/11	Many less seeds have germinated in the caffeine group. Both groups equally vigorous.
Wheat "	... Tap water 1% Caffeine	11 11	" "	30/5/11 4/6/11	Ten seeds have germinated in tap-water group. One in the caffeine group.
Barley "	... Tap water 1% Caffeine	12 12	" "	30/5/11 Nil	Six seeds have germinated in the tap-water group.
Oats "	... Tap water 1% Caffeine	13 13	" "	11/5/11 31/5/11	Eleven seeds have germinated in the tap-water group, two in the caffeine group; the former are the stronger.
Canariensis "	... Tap water 1% Caffeine	10 10	" "	16/5/11 Nil	Six seeds have germinated in the tap-water group.
Eschscholtzia "	... Tap water 1% Caffeine	0.5 g. 0.5 g.	7/5/11 "	18/5/11 25/5/11	Many more seeds have germinated in the tap-water group, and they are much the stronger.
Zinnia "	... Tap water 1% Caffeine	0.5 g. 0.5 g.	" "	15/5/11 17/5/11	In the tap-water group thirty-one seeds have germinated, in the caffeine group nineteen; the latter are the weaker.

Name of seed	Previous treatment 24 hours at 25° C. in	Quantity	Date of planting	Sprouts first visible	Condition 4 weeks after planting
Marigold	Tap water	0.2 g.	7/5/11	17/5/11	The tap-water group is more numerous and better grown than the caffeine group.
..	1% Caffeine	0.2 g.	..	23/5/11	
Gaillardia	Tap water	0.25 g.	..	21.5.11	The number of seeds which have germinated is about equal. The tap-water group is much more vigorous.
..	1% Caffeine	0.25 g.	..	27.5.11	
Chrysanthemum ...	Tap water	0.5 g.	..	16/5/11	Many more seeds have germinated in the tap-water group, and the seedlings are much stronger than in the caffeine group.
..	1% Caffeine	0.5 g.	..	23/5/11	
Linum rubrum ...	Tap water	0.5 g.	..	16/5/11	Fewer seeds have germinated in the caffeine group, and the seedlings are weaker than in the tap-water group.
..	1% Caffeine	0.5 g.	..	21/5/11	
Convolvulus ...	Tap water	0.5 g.	20/6/11	23/6/11	The seedlings in the tap-water group are stronger and more numerous than in the caffeine group.
..	1% Caffeine	0.5 g.	..	25/6/11	
Sweet Rocket ...	Tap water	0.5 g.	..	29/6/11	The seedlings in the tap-water group are stronger and more numerous than in the caffeine group.
..	1% Caffeine	0.5 g.	..	10/7/11	
Coreopsis	Tap water	0.3 g.	..	2/7/11	The seedlings in the tap-water group are stronger and more numerous than in the caffeine group.
..	1% Caffeine	0.3 g.	..	5/7/11	
Lavatera	Tap water	0.5 g.	..	23/6/11	The seedlings in the tap-water group are stronger and more numerous than in the caffeine group.
..	1% Caffeine	0.5 g.	..	25/6/11	
Nasturtium ...	Tap water	16	..	29/6/11	The seedlings in the caffeine group are more numerous, both groups about equally vigorous.
..	1% Caffeine	16	..	27/6/11	

REFERENCES

1. Bokorny, *Pflüger's Archiv.*, CXXXVII, p. 470, 1911.
2. Armstrong, *Journal of Physiology*, XL, p. 22, 1910.
3. Waller, *Journal of Physiology*, XL, p. 49, 1910.
4. Bokorny, *Biochem. Zeitschr.*, XXXVI, p. 83, 1911.

THE ACTION OF CAFFEINE UPON THE GERMINATION AND GROWTH OF SEEDS

By FRED RANSOM, M.D., Ed., *Beit Research Fellow.*

*From the Pharmacological Laboratory, Cambridge
(Second Communication)*

(Received January 17th, 1912)

In the following communication an endeavour is made to throw light upon the function which caffeine exercises in plant economy. At present the reason for the storage of caffeine in certain parts of some plants is quite as unexplained as is the appearance of its allies, xanthine and hypoxanthine, in animal tissues. On the other hand, the fact that it is found chiefly in the seeds and in young and growing shoots suggests that it may have something to do with germination or with growth.

In a previous paper I have shown that 1 per cent. solution of caffeine has a marked effect in delaying or preventing germination in a considerable variety of seeds. The following experiments unreservedly confirm those results. There was, however, the possibility that by treating seeds with very dilute solutions of caffeine a stimulating effect might be produced on germination or on growth or on both. The settlement of this point was one object of the present investigation.

The method adopted was the following:—On the bottom of glass needle boxes a thin layer of absorbent cotton-wool was placed, over this a piece of fine muslin was laid and the whole moistened with 50 c.c. of caffeine solution or tapwater. The seeds were then scattered thinly upon the muslin. The needle glasses were closed with loosely-fitting glass lids and stood either in the laboratory at about 17° C. or in a thermostat regulated to 22° C. Usually a series of glasses were charged with caffeine solutions of varying strength, with tapwater controls. At certain intervals the growths were compared by examination with the eye and, finally, the seedlings were carefully removed, either with or without the ungerminated seeds, superficially dried on blotting paper and weighed at once.

As regards germination it was found that caffeine solutions of 1·0, 0·1, 0·01 per cent. caused very distinct delay. With 0·001 per cent. that was not so obvious, and seeds sown in 0·0001 per cent. germinated as quickly as the tapwater controls (Table I).

Besides delay, the stronger caffeine solutions had a very marked

inhibitory effect, so that of the seeds sown in 1.0, 0.1, and 0.01 per cent. fewer germinated than in the weaker solutions or in tapwater (Table II).

Very dilute solutions of caffeine, 0.0001 per cent. and less, were without any obvious effect at all, either on germination or on growth. As will be seen from the table, 0.001 per cent. appears to have a slight effect in hindering growth (Table III).

The effect of caffeine in solutions of about 0.01 per cent. or more, was such that the seedlings, weighed after two or three days' growth, were distinctly lighter than the tapwater controls (Table IV). In most of the following tables the same effect can be observed.

It being thus evident that caffeine added to tapwater does not stimulate germination or growth; further experiments were made to ascertain whether a different effect would follow when a salt or other substance was added to the caffeine solution.

NITRATE OF POTASH—SACCHAROSE. (All solutions in tap water)

Cress 0.5 g. in each glass and 50 c.c. fluid. Sown on 6/12/1911. Room temperature

Medium	Condition on 8/12/1911	Condition on 9/12/1911	Weight on 12/12/1911
(1) KNO_3 0.05 %	... 1 and 4 are the best	Relatively about the same	2.620
(2) KNO_3 0.05 % Caffeine 0.01 %	... 2 and 3 about equal but smaller than the others		2.385
(3) Caffeine 0.01 %	...		2.590
(4) Tap water	...		2.830
(5) Saccharose 2 %	... 5 and 6 are about equal and less than 4	6 is smaller than 5. Both are less than 4	2.620
(6) Saccharose 2 % Caffeine 0.01 %	...		2.350

The table shows very distinctly the influence of caffeine in retarding growth, but there was no stimulation.

DEXTROSE. (All solutions in tap water)

Mustard 1.0 g. seed in each glass and 50 c.c. fluid. Sown on 12/12/1911. Room temperature

Medium	Condition on 14/12/1911	Weight on 16/12/1911
(1) Dextrose 0.8 %	... 5 and 6 are the best grown and are about equal	3.100
(2) Dextrose 0.2 %	...	3.730
(3) Dextrose 0.8 % Caffeine 0.001 %	... 1 and 3 are the smallest	3.040
(4) Dextrose 0.2 % Caffeine 0.001 %	... 2 and 4 are about equal	3.670
(5) Tap water	...	4.420
(6) Caffeine 0.001 %	...	4.320

There is here no evidence whatever that the caffeine combined with dextrose stimulates, on the contrary what little difference there is indicates retardation. The best growth took place in tapwater, followed closely by the 0.001 per cent. caffeine solution.

ALANIN. (All solutions in tap water)

Mustard 1.0 g. seed in each glass and 50 c.c. fluid. Sown on 16/12/1911. Room temperature

Medium	Condition on 19/12/1911 in order of merit	Number of not germinated 20/12/1911	Weight, 20/12/1911 without not germinated
Alanin 0.5 %	Best	39	2.750
	Tap water		
Alanin 0.1 %	0.0001 % caffeine	27	3.465
Alanin 0.5 %	0.001 ,, caffeine	62	2.265
Caffeine 0.01 %			
Alanin 0.5 %	{ 0.1 ,, alanin	30	3.050
Caffeine 0.001 %	{ 0.0001 ,, caffeine		
Alanin 0.5 %	{ 0.1 ,, alanin	46	2.610
Caffeine 0.0001 %	{ 0.001 ,, caffeine		
Alanin 0.1 %	equal { 0.1 ,, alanin	27	3.190
Caffeine 0.01 %	{ 0.1 ,, alanin		
	{ 0.01 ,, caffeine		
	{ 0.01 ,, caffeine		
Alanin 0.1 %		34	3.550
Caffeine 0.001 %			
Alanin 0.1 %	equal { 0.5 ,, alanin	25	3.380
Caffeine 0.0001 %	{ 0.0001 ,, caffeine		
	{ 0.5 ,, alanin		
	{ 0.001 ,, caffeine		
Caffeine 0.01 %		22	3.850
Caffeine 0.001 %	equal { 0.5 ,, alanin	24	3.850
Caffeine 0.0001 %	{ 0.01 ,, caffeine	25	4.355
	{ 0.5 ,, alanin		
Tap water	Worst	19	4.420

The table shows that more seeds germinated and the seedlings developed best in tapwater. There were no signs of stimulation, on the contrary the combination alanin-caffeine was more deleterious than caffeine alone.

WITTE'S PEPTONE. (All solutions in tap water)

Mustard 1.0 g. in each glass and 50 c.c. fluid. Sown on 19/12/1911. 22° C.

Medium	Condition on 20/12/1911	Condition on 21/12/1911	Weight on 21/12/1911
(1) Peptone 0.5 %	5 and 6 have begun to sprout	6 is much the best	3.410
(2) Peptone 0.5 %		Then 1 and 2	3.280
(3) Peptone 0.5 %	1, 2, 3, 4 have hardly any sprouts	Then 5	2.830
(4) Peptone 0.5 %		3 and 4 are the least grown	2.700
Caffeine 0.02 %			
(5) Tap water			2.900
Caffeine 0.02 %			
(6) Tap water			4.800

The seeds in tapwater developed best, and the combination of peptone with caffeine was more inhibitory than either peptone or caffeine alone.

WITTE'S PEPTONE. (All solutions in tap water)

Mustard 1.0 g. in each glass and 50 c.c. fluid.		Sown on 20/12/1911.		22° C.
Medium	Condition on 21/12/1911	Condition on 22/12/1911	Weighed on 22/12/1911	Arranged in order of merit
(1) Peptone 0.1 %	... 11 and 12 have germinated best.	12 is the best	3.220	Tap water, best
(2) Peptone 0.5 %	...	Then 9, 10, 11	2.960	0.0001 % caffeine
(3) Peptone 0.5 % Caffeine 0.01 %	... Then 9 and 10	Of the rest, 1, 2, 8, 7, 6 are better than 3, 4, 5	2.820	0.001 % caffeine 0.1 % P. + 0.0001 % caffeine
(4) Peptone 0.5 % Caffeine 0.001 %	... The rest are fairly equal, 5 being the least grown		2.930	0.1 % P. + 0.01 % caffeine
(5) Peptone 0.5 % Caffeine 0.0001 %	...		2.690	{ 0.1 % P. 0.1 % P. + 0.001 % caffeine
(6) Peptone 0.1 % Caffeine 0.01 %	...		3.370	0.5 % P.
(7) Peptone 0.1 % Caffeine 0.001 %	...		3.220	0.5 P. + 0.001 % caffeine
(8) Peptone 0.1 % Caffeine 0.0001 %	...		3.410	0.5 % P. + 0.01 % caffeine
(9) Caffeine 0.01 %	...		3.650	0.5 % P. + 0.0001 % caffeine
(10) Caffeine 0.001 %	...		3.600	
(11) Caffeine 0.0001 %	...		3.840	
(12) Tap water	...		3.890	

The best results were obtained with tapwater followed closely by the weakest caffeine solution. The combination of caffeine with peptone was more inhibitory than either caffeine or peptone alone.

CONCLUSIONS

The foregoing experiments afford ample evidence that caffeine added in the proportion of from 1 per cent. to 0.01 per cent. to water, in which seeds are then sown, exercises a powerful effect in retarding germination and growth. If as much as 1 per cent. caffeine is present there may even be complete inhibition of germination.

On the other hand there is nothing at present to show that caffeine, either alone or in combination with other substances can act as a stimulant to plant life. Nevertheless, the subject is not exhausted and the investigations are being continued.

TABLE I

Sown on 31/10/1911, at Room temperature

Medium	Cress, 0.5 g. in each glass Condition on 3/11/1911	Radish, 18 seeds in each glass Condition on 4/11/1911	Mustard, 0.5 g. in each glass Condition on 3/11/1911	
1 % caffeine in water	... None germinated	None germinated	None germinated	
0.1 % caffeine in water	... A very few small shoots	None germinated	None germinated	
0.01 % caffeine in water	... The greater part sprouted 2 mm.	A few very small shoots	A few just showing	
0.001 % caffeine in water	... The greater part sprouted 3 mm.	The greater part sprouted 2 mm.	The greater part sprouted	
0.0001 % caffeine in water	} Equal. Almost all sprouted 3-4 mm.	} Equal. Mostly sprouted 3 mm.	} Equal. Almost all sprouted. The best grown	
Tap water only				
Mustard, 0.5 g. in each glass. Sown on 10/11/1911, at room temperature		Lettuce, 0.3 g. in each glass. Sown on 25/11/1911, at room temperature		Radish, 18 seeds in each glass. Sown on 5/12/1911. 22° C.
Medium	Condition on 13/11/1911	Medium	Condition on 28/11/1911	Condition on 7/12/1911
0.1 % caffeine	A few very small shoots	0.1 % caffeine	None germinated	A few very small shoots
0.02 % caffeine	Mostly sprouted, but small	0.01 % caffeine	Few and small	More and stronger
0.004 % caffeine	Mostly sprouted, longer	0.001 % caffeine	More and larger	More still and stronger
0.0008 % caffeine	} Mostly sprouted. The best grown. Equal	0.0001 % caffeine	} About equal. The best grown	} About equal. Distinctly the best grown
Tap water only		Tap water only		

TABLE II

Mustard, 0.5 g. in each glass. Sown on 31/10/1911. Room Temperature		Radish, 18 seeds in each glass. Sown on 5/12/1911. Room temperature		Radish, 18 seeds in each glass. Sown on 5/12/1911. 22° C.	
Medium	Number not germinated	Condition of seeds on 12/12/1911		Condition of seeds on 12/12/1911	
		Germinated	Not germinated	Germinated	Not germinated
1 % caffeine	... 103 = all sown	5	13	8	10
0.1 % caffeine	... 35	7	11	10	8
0.01 % caffeine	... 26	6	12	10	8
0.001 % caffeine	... 15	12	6	13	5
0.0001 % caffeine	... 17	14	4	13	5
Tap water	... 16	13	5	14	4

TABLE III

Mustard seed, 1.0 g. in each glass. Sown on 17/12/1911. 22° C.

Medium	Weight on 19/12/1911
0.001 % caffeine	4.520 g.
0.0001 % caffeine	4.750
0.00001 % caffeine	4.610
0.000001 % caffeine	4.770
Tap water	4.830
Tap water	4.710

TABLE IV

Turnip seed, 0.5 g. in each glass. Sown on 15/11/1911. Room temperature

Cress, 0.5 g. in each glass.
Sown on 15/11/1911. Room temperature

Medium	Weight on 22/11/1911	Weight on 22/11/1911
0.1 % caffeine	2.400 g.	2.530 g.
0.02 % caffeine	3.070	3.830
0.004 % caffeine	3.530	4.320
0.0008 % caffeine	3.760	5.370
0.00016 % caffeine	3.740	6.320
Tap water	3.730	6.430

CELL STIMULATION BY MEANS OF PROLONGED INGESTION OF ALKALINE SALTS¹

(From the Bio-Chemical Department, University of Liverpool)

(Received November 14th, 1911)

The research here recorded was undertaken originally in the hope of ascertaining the relationship of cell stimulation to cancer. The original scheme of work included the driving in of alkaline ions daily into the same spot by means of weak electric currents, using both normal rabbits and those which were receiving daily an alkaline salt in their food; the ordinary and differential counts of leucocytes in rabbits under alkaline treatment; the effects of keeping mice for several weeks in an atmosphere containing an excess of carbon dioxide; and the daily ingestion of increasing doses of alkaline salts by mice, rabbits and dogs. As negative results were obtained in all except the last class of experiments, these are the only ones which will be described in detail.

INGESTION EXPERIMENTS ON MICE

Two sets of mice were taken; one received sodium bicarbonate, the other alkaline sodium phosphate in the food. The salts, containing their water of crystallisation, were thoroughly mixed up with the food which consisted of bread or dog biscuit soaked in water, with an occasional change to dry oats. It was thought important to vary the food in this way, so as to avoid the effects of prolonged maintenance on bread alone or meat alone, such as have been described by Chalmers Watson. The amount of food was so regulated that there was none left over from the previous day. In each case the dose to begin with was 0.1 gram per head; this was gradually increased till some mice were receiving 0.7 gram per head. Some of the mice died within a day or two of the commencement of the experiment, probably from extraneous causes, and so have not been included in the results detailed below. As regards the more resistant ones it was noticed that after a time they became very thin and their coats dull, but up to the time of their death they seemed to feed well.

1. This research has been carried out by Dr. F. P. Wilson, working under the direction of a Committee consisting of E. C. C. Baly, F. W. Goodbody, A. C. Jessup, A. E. Jessup and B. Moore. The expenses of the research have been defrayed by Mr. A. E. Jessup. In the histological part of the research the Committee has been much assisted by Mr. George Arnold.

The period of treatment in the different cases varied from two weeks to five months. Some of the mice died naturally, others were killed for purposes of examination. All cases which had been on alkalis for any length of time showed, post mortem, marked wasting with an entire absence of body fat, in this respect coinciding with the experience of Moore, Roaf and Knowles in the case of guinea-pigs. Beyond this extreme wasting no reason for death could be found.

Pieces of the various organs were fixed in Zenker's fluid as soon after death as possible, cut in paraffin, stained by Breinl's basic fuchsin methylene blue and orange method, and examined microscopically.

No obvious changes were evident in the liver, kidneys, lungs, spleen and intestines, but in the testes some extraordinary alterations were found. These results are of especial interest as the cells of the testis, except the basal cells, are regarded by many cytologists, as out of 'co-ordination' with the somatic cells. As a result of these experiments it would seem that they are more susceptible to changes in the reactivity of the surrounding plasma. On the other hand, no changes were observed in the ovaries of the female mice subjected to similar conditions.

Below are set out in detail the kind of salt administered, the length of time given for, and the histological changes found in the seminiferous tubules. The photographs appended show a normal tubule and part of a degenerated tubule in Mouse 1. This was one of the cases which showed the most profound changes.

CHANGES IN THE SEMINIFEROUS TUBULES

Mice fed with Alkalis

Mouse 1. Na₂HPO₄. March 9, 1909 to May 6, 1909.

Fig. 1 is a portion of a tubule from a healthy untreated mouse.

The lumen is occupied by spermatozoa and spermatids, with one or two spermatocytes of the second layer (homotype). The layer of cells between these and the outermost layer are all spermatocytes of the first order (heterotypes). The outermost layer contains early heterotype prophase with leptotene nuclei, a few spermatogonia (*spg.*) and foot cells (*fc.*)

A section of a tubule from a mouse which has been treated for eight weeks, with the phosphate salts, presents a startlingly different picture. Indeed, the alterations produced in the tissue are so profound,

that at first sight the section would not be recognised as a portion of the testis. (Fig. II.)

The cells of the tubule, Fig. II, have been reduced to a single layer, adjacent to the external investing membrane.

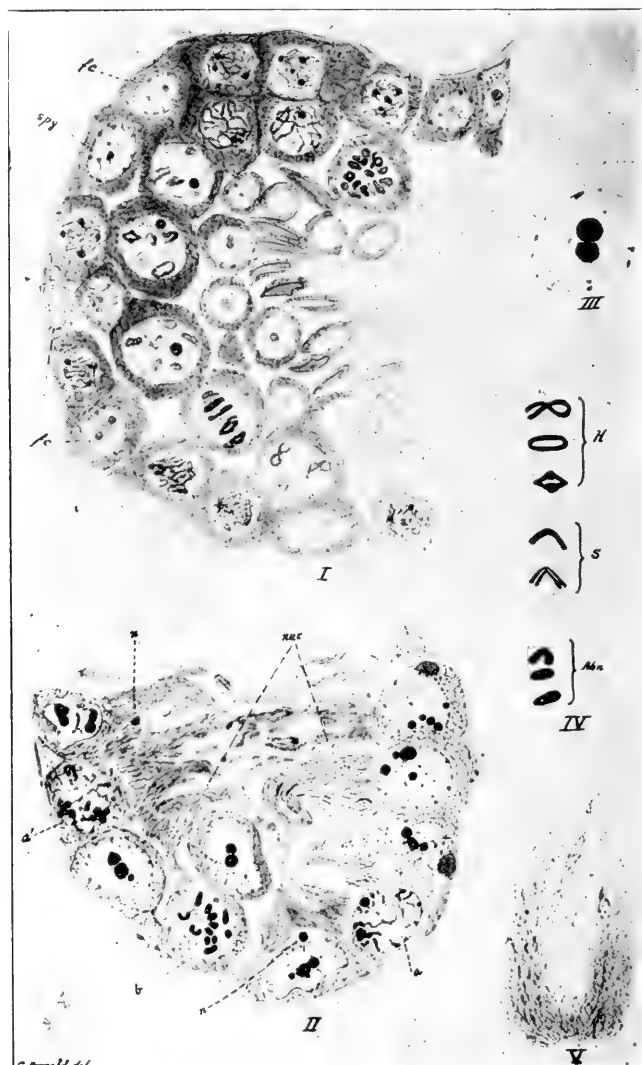

The interior of the tubule is filled with a stringy mass of cytoplasm. Some of it appears to be connected with the cytoplasm of the cells surrounding the periphery of the tubule, and it is possible that

these portions represent protoplasmic extensions of those cells, since there are some observers who claim that the foot cells, or cells of Sertoli, possess a cytoplasm of an uneven outline with long pseudopodial extensions connecting one cell with another. Such a structure cannot be demonstrated definitely in the normal testis, but possibly the hypertrophy of the cell under these abnormal conditions may make these protoplasmic strands show up more clearly. However, some of the cytoplasm which occupies the lumen of the tubules encloses traces of broken-down nuclear material (*nur.*).

The nuclei of the cells are slightly larger than the nuclei of the normal spermatogenic cells, except cells in the later heterotype prophase, and they appear to be even larger than these. This, however, is not really the case, but is brought about by the fact that the cytoplasm of these altered cells is considerably less in proportion to the nucleus, than in healthy cells. The cytoplasm is also more coarsely reticulated, or perhaps, the reticular mesh-work takes the stain more readily. The nuclear membranes take the basic stain very deeply. In each nucleus there is at least one nucleolus, sometimes two or three. Generally, in the neighbourhood of the nucleoli are other large round bodies, which represent nearly all the chromatin of nucleus massed together. (Fig. II and Fig. III.)

These cells, by the distinctive appearance, can be recognised as Sertoli or foot cells, and differ from the foot cells in the normal testis only by their size, in the manner already mentioned.

Except by the irregularity of the margins, and the fact that they generally take the blue stain very strongly (whereas the nucleolus is distinctly red), these bodies are very similar to the nucleoli. Rarely some division figures are seen (*b*), and also the intermediate stages leading up to those divisions (*a* and *d*). In the latter a very coarse and irregular spireme is formed, obviously at the expense of the nucleolus-like masses of chromatin just mentioned, which get smaller and smaller as the spireme is completed. The chromosomes of these divisions also have an abnormal stamp. In Fig. IV these chromosomes (*abn.*) can be compared with typical heterotype (*H*) and somatic (*S*) chromosomes. It will be seen that they are unlike either.

Judging by the position of these cells, and the general character of the spireme stages, it is certain that they are spermatogonia, and their irregular mitoses indicate degeneration, and compared with the foot cells they are few in number, much below the normal found in

transverse section of a healthy tubule; and probably even these would disappear at an early date, leaving the tubules lined with foot cells only, as is indeed the case in a large number of the tubules in this slide.

There can be no doubt that some of the stringy masses of cytoplasm in the interior of the tubules represent the remains of the cells which in a healthy tubule would normally occupy that position. These cells, then, have completely broken down, and only here and there in the cytoplasmic threads can traces of their nuclei be seen. (*nur.*, Fig. II and Fig. V.)

The nucleolar activity in these cells is very noticeable, a very large number showing the nucleoli dividing. Some of these daughter nucleoli are extruded through the nucleus and cytoplasm into the lumen of the tubule. (Fig. II, *n.n.*)

The striking features in the altered testis are these:—(a) Only those cells which lie on the investing membrane of the tubule are living and active. (b) The volume of their nuclei is out of all proportion to that of the cytoplasm. (c) The chromatin is massed together in each nucleus into a few round lumps.

Mouse 2. NaHCO₃. April 27, 1909, to June 23, 1909.

Normal.

Mouse 3. NaHCO₃. April 27, 1909, to July 27, 1909.

Almost as bad as No. 1, except that spermatozoa are still present in some numbers. Like No. 1, marginal cells with nuclei considerably altered, and abnormal in appearance, line all the tubules. Spermatocytes completely absent. The central part of the tubules filled with cytoplasmic remains and spermatozoa, and some concentrations of chromatin, derived from broken-down nuclei.

Mouse 4. Na₂HPO₄. March 15, 1909, to August 3, 1909.

Normal.

Mouse 5. NaHCO₃. September 1, 1909, to September 10, 1909.

Double nucleoli-marginal cells very marked. Spermatid degeneration extensive. Nuclei of some spermatocytes considerably altered, having a mossy appearance, due to the chromatin and linin breaking up into irregular lumps and specks, especially noticeable in spireme stages.

Mouse 6. NaHCO₃. September 1, 1909, to September 15, 1909.

Like No. 5.

Mouse 7. Na_2HPO_4 . September 1, 1909, to September 15, 1909.

Multipolar mitoses rather plentiful. Chromosomes unrecognisable, merely shapeless lumps of chromatin.

Mouse 8. Na_2HPO_4 . September 1, 1909, to September 26, 1909.

Normal.

Mouse 9. $NaHCO_3$. September 15, 1909, to September 28, 1909.

Normal.

Mouse 10. $NaHCO_3$. September 15, 1909, to September 28, 1909.

Like No. 5. The degeneration of the spermatocytes takes the following course. The spireme threads lose their staining reaction and the nucleolus enlarges and attaches to it a large mass of chromatin derived from the spireme, in fact the latter stains more faintly owing to the absence of chromatin.

Mouse 11. Na_2HPO_4 . September 1, 1909, to September 28, 1909.

Normal.

Mouse 12. $NaHCO_3$. September 15, 1909, to September 29, 1909.

Normal.

Mouse 13. Normal control.

Normal.

Mouse 14. Normal control.

Normal.

Mouse 15. Normal control.

Normal.

Mouse 16. Normal control.

Normal.

Mouse 17. Normal control.

Normal.

Mouse 18. $NaHCO_3$. September 15, 1909, to October 28, 1909.

Mitoses normal.

Mouse 19. $NaHCO_3$. September 15, 1909, to October 28, 1909.

Normal.

Mouse 20. $NaHCO_3$. September 15, 1909, to October 28, 1909.

Normal.

Mouse 21. NaHCO₃. September 1, 1909, to October 28, 1909.

Normal.

Mouse 22. NaHCO₃. September 1, 1909, to October 28, 1909.

Normal.

Mouse 23. NaHCO₃. September 1, 1909, to October 30, 1909.

A large mass of degenerated chromatin, spermatocytes present.

Mouse 24. Normal control.

Normal.

Mouse 25. Normal control.

Normal.

Mouse 26. Normal control.

Normal.

Mouse 27. Normal control.

Normal.

Mouse 28. Normal control.

Ovary, normal.

Mouse 29. NaHCO₃. September 15, 1909, to November 30, 1909.

Normal.

Mouse 30. Na₂HPO₄. August 9, 1909, to January 14, 1910.

Ovary, normal.

Mouse 31. NaHCO₃. September 15, 1909, to January 14, 1910.

Ovary, normal.

Mouse 32. Na₂HPO₄. September 9, 1909, to February 22, 1910.

Ovary, normal

Mouse 33. Normal control.

Normal.

CONSIDERATION OF THE ABOVE RESULTS

Out of twenty-two treated mice there were ten normal testes and three normal ovaries, the remaining nine (all testes) showed deviations, more or less marked, from the normal. The eleven controls were all normal.

The fact that 41 per cent. of the treated mice presented unusual

degenerative changes in the testes is good evidence that these results were due to the ingestion of the alkaline salts.

In addition to the above tame mice, the testes of six wild mice were examined and found to be quite normal.

INGESTION OF POTASSIUM BICARBONATE

A third series of ten mice were fed on increasing doses of potassium bicarbonate. The general effects of the potassium ion resembled those of the sodium, but seemed to be produced more quickly. Changes in the liver and the testes were found similar to the sodium-fed mice.

K. 1. In a very small number of the tubules of this testis only marginal cells, *i.e.*, Sertoli or foot cells remained intact. The rest of the cells are in a state of degeneration, as evidenced by the cytoplasm taking the basic stain, and the nuclei fragmenting. In other tubules the percentage of foot cells is above the normal. This slide probably indicates the earliest steps on the road to degeneration leading to the condition found in sodium bicarbonate mice, 1, 3 and 14.

K. 2. Resembles *K. 1.*

K. 3 and K. 4. Normal.

K. 5. Normal.

K. 6. Resembles *K. 1.*

K. 7. Resembles *K. 1.*

K. 8. Normal.

K. 9. Ovary, normal.

K. 10. Ovary, normal

INGESTION EXPERIMENTS WITH RABBITS

Altogether five rabbits (Nos. 3, 13, 18, 20 and 21) have been fed with increasing doses of sodium bicarbonate for varying periods. The daily dose to begin with was in each case 0.5 gram per head. This was increased by 0.5 gram each week until the animal was taking 7 grams of salt in its food daily. The quantity of food given was adjusted so that as far as possible all was eaten.

The animals seemed to stand 5 grams per head daily without much change, but beyond this dose they rapidly began to lose flesh and to become poor in coat.

At post mortem examination the most marked feature was the wasting and the entire absence of body fat, even round the kidneys. The lungs were congested, and in the case of rabbit No. 21, which had developed a purulent cyst of the neck, the lungs were tuberculous. Otherwise there were no obvious naked-eye changes met with, and it seemed probable that the animals would have died of extreme inanition. As regards this, it is worthy to note that the animals continued to feed well to the end.

Rabbits 3, 13 and 20 were females. Treated with NaHCO_3 for ten weeks. The ovaries presented no pathological changes. In Rabbits 3 and 20 there were changes in the liver cells, which stained very badly. The cytoplasm was in a slightly necrotic condition in parts, and the nuclei lying free in clear spaces. The cells of the renal tubules were in a desquamative condition. Rabbit 13 presented no evident histological changes. Rabbits 18 and 21 were males. Treated with NaHCO_3 for eight weeks. The testes appeared normal. The liver cells had a hyaline appearance and took the stains badly. The renal epithelium presented a similar appearance. The other organs seemed normal. In the rabbit, therefore, it would appear as though the sexual glands were more resistant to the action of the alkali than was the case in mice. On the other hand, the salt seems to irritate the liver and renal cells in the rabbit more than in the mice. It is possible that this susceptibility or otherwise is in some way dependent on the natural habits of the animal in respect to the kind of food usually eaten.

THE PROTEINS OF RICE

By S. KAJIURA, *Imperial Japanese Navy.*

From the Physiological Laboratory, King's College, London

(Received November 24th, 1911)

Rice forms the staple food of many Oriental races, and a knowledge of the composition of its proteins is therefore important from an economic and hygienic point of view, especially in relation to 'Beri-beri,' the disease of rice-eating nations. It appears, however, from a review of the literature that the nature and composition of the rice proteins has, up till now, not been studied with anything like the thoroughness which has been bestowed on the proteins of European cereals.

In a preliminary communication, Rosenheim and Kajiura¹ showed that the distribution and nature of the rice proteins differ characteristically from what is found in other cereals. They found that the principal protein, to which they gave the name *Oryzenin*, belongs to the class of glutelins (proteins insoluble in water and neutral salt solutions, but soluble in dilute alkali); the amount of albumin and globulin is very small, and an important result noted was the almost complete absence of a protein soluble in alcohol. This latter observation sharply differentiates the proteins of rice from those of other cereals.² The present communication gives a fuller account of the experiments which led to these results.

The material used was procured directly from Japan, and consisted of the ordinary rice used there for dietary purposes, namely, peeled and polished 'white rice.' Portions of this were freshly ground, when required, to a fine flour in an 'Excelsior' mill. The ground rice contained 12.92 per cent. of water. The dried material contained 1.24 per cent. of nitrogen. If all the nitrogen were present in the form of protein, the percentage of protein would be according to the usual calculation 7.75 ($N. \times 6.25$).

The methods generally used for the preparation of vegetable proteins are based on their different behaviour towards solvents, and they are classified according to their solubilities into four main groups.³

1. *Proc. Physiological Society*, January, 1908. *Journal of Physiology*, Vol. XXXVI. Suzuki, Yoshimura and Fuji shortly afterwards obtained practically the same results (*Journ. Tokyo Chem. Soc.*, XXIX, No. 3, March, 1908).

2. See S. Kajiura and O. Rosenheim. 'A Contribution to the Etiology of Beri-Beri.' *Journal of Hygiene*, Vol. X, p. 49, 1910.

3. O. Rosenheim, 'Science Progress,' No. 8, 1908. T. B. Osborne, 'The Vegetable Proteins,' published in Longmans' *Monographs on Bio-Chemistry*, 1909.

- I. Phyto-albumins; soluble in water.
- II. Phyto-globulins; insoluble in water, soluble in saline solution.
- III. Prolamins (Gliadins); insoluble in water, soluble in alcohol.
- IV. Glutelins (phyto-caseins); insoluble in water, saline solutions and alcohol, soluble in dilute alkali.

The first step in the investigation, in the absence of any data from previous literature, consisted in examining systematically the effects of these various solvents on rice, and thus to classify the proteins which are present.

I. THE ALBUMINS AND GLOBULINS OF RICE

Preliminary experiments showed that distilled water extracts from rice contained exceedingly small quantities of protein. The aqueous extract must be assumed to contain the albumins, together with proteoses, which may also possibly be present (see later). But it is well known that under these conditions, a considerable quantity of globulin also goes into solution owing to the presence of salts in the seeds. The total quantity of protein so obtained was, however, small, and it was therefore considered advisable to dissolve out the albumins together with the globulins by means of salt solution, and to separate the two classes of protein subsequently. The methods employed for separating them were: (1) dialysis; (2) saturation by ammonium sulphate followed by dialysis; and (3) fractional heat-coagulation.

Before dealing with the extraction of large quantities of rice with neutral salt solution, a number of preliminary quantitative experiments were carried out on a small scale. For this purpose 10 to 12 grams of finely ground rice were extracted with 40 c.c. of a 10 per cent. solution of sodium chloride with frequent shaking. The mixture was then allowed to stand, and the supernatant fluid was decanted off. The residue was extracted twice more with 30 c.c. of the salt solution; chloroform was used throughout as an antiseptic. The combined extracts were filtered under pressure through asbestos or paper pulp, and made up to 100 c.c. Nitrogen was then estimated in two portions of 50 c.c. each. The results of four such experiments were as follow:—Nitrogen present in the extract of 100 grams of rice made with 10 per cent. salt solution.

- | | | |
|-------|------|-------|
| (i) | 0·14 | gram. |
| (ii) | 0·11 | „ |
| (iii) | 0·14 | „ |
| (iv) | 0·10 | „ |

Two nitrogen estimations were made in each case, except in (iv), and the above figures represent the amount calculated from the average. The mean result of the four experiments is that 100 grams of dry rice contain 0.12 gram of nitrogen, corresponding to 0.75 gram of protein soluble in 10 per cent. sodium chloride solution. This assumes that all the nitrogen was combined in protein form, and on this assumption only about 10 per cent. of the total proteins of rice consist of albumins and globulins. When working on a larger scale, however, with a view to preparing these proteins in bulk, it will be seen that even this small theoretical yield was not reached.

(a) *Preparation of Rice Globulin by Dialysis.* Five kilograms of finely ground rice were extracted at room temperature with 8 litres of 10 per cent. sodium chloride solution; the extract was filtered off and the residue was pressed in a filter press and again extracted with 4 litres of the salt solution. The extracts were filtered through paper and paper pulp. Nine litres of a perfectly clear extract were obtained, which were subjected to dialysis in parchment tubes in a special apparatus. Toluene was used as an antiseptic. Dialysis was continued for 190 hours, after which time the contents of the dialyser were practically free from chloride. The small precipitate which had formed in the dialysing tubes was separated by decantation and finally by the centrifuge. After washing and drying *in vacuo* it weighed 7.34 grams.

The product was a yellowish, amorphous powder, which gave the usual protein colour reactions, and showed the characteristic solubilities of a globulin. It contained phosphorus and is, therefore, possibly a globulin nucleate. On dissolving it in 10 per cent. sodium chloride solution, a small amount remained insoluble. The filtered solution, when dialysed, gave again an amorphous precipitate. The quantity was, however, too small for further purification or study. All attempts to obtain it in crystalline form by dialysis or by cooling its warm solution failed.

The main bulk of the extract thus freed from globulin by dialysis still contained a very small amount of protein coagulable by heat. Owing to the large volume of the solution and the extremely small amount of protein contained in it, no attempt was made to isolate it. Its isolation was, therefore, carried out in the experiment to be described next, in which the bulk of fluid to be dealt with was much reduced.

(b) *Preparation of Rice Albumins and Globulins from the saline extract by saturation with ammonium sulphate.* Five kilograms of finely

ground rice were extracted with 10 per cent. salt solution as described under (a). Eight litres of clear filtrate were obtained; this was saturated with ammonium sulphate; the flocculent precipitate so produced was filtered; the filtrate was protein-free; the precipitate was washed with saturated ammonium sulphate solution, and redissolved in 1.5 litres of 10 per cent. sodium chloride solution. This was filtered and dialysed against running water, as before, for 120 hours, putrefaction being prevented by the addition of toluene. At the end of this time the contents of the dialyser were free from sulphates and chlorides. The precipitated globulin was separated and dried as before. When dissolved in 10 per cent. salt solution, a sample became slightly opaque at 55° C., but a flocculent precipitate did not appear until the temperature was raised to 87° C.

After the removal of the globulin the solution contained a considerable amount of protein which coagulated at 65° C. The whole bulk of the solution was, therefore, left at this temperature for some time, and the coagulated protein was filtered off, dried and weighed. It is difficult to decide whether this protein can be considered as a true albumin, or whether it represents a globulin held in solution by minute quantities of acids¹. On heating the remaining solution to boiling point, a further very small amount of protein was coagulated, and the solution thus freed from all coagulable protein gave a faint biuret reaction; it was concentrated to a small bulk on the water-bath and finally poured into absolute alcohol. The white precipitate so produced was filtered off and dried as before. The last precipitate presumably consisted of proteoses, but whether these are preformed in the rice grain, or are produced hydrolytically by the process of boiling, it is not possible to say.

The weights of the different fractions obtained in this experiment will be found in the following table:—

(i) Globulin, precipitated by dialysis	1.40 gram) From 5,000 grams of rice.
(ii) Albumin (?) coagulated at 65°	1.72 "	
(iii) Residual protein coagulated at 100	0.58 "	
(iv) Proteoses (?) precipitated by alcohol	1.29 "	
				4.99	= 0.1 per cent.

The figures in the foregoing table must not be taken as absolute, for there was probably some loss owing to the operations being performed with large volumes of fluid and owing to incomplete extraction. They

1. A similar difficulty was experienced by Osborne (*Journ. Amer. Chem. Soc.*, XIX, p. 525, 1897) in his examination of the proteins of maize.

are useful as an indication of the relative amounts of the different fractions. At any rate the total quantity of protein in saline extracts is very small, and on the assumption that rice contains 7.75 per cent. of total protein, and that the foregoing estimations are approximately correct, the albumin and globulin account for but little more than 1.5 per cent. of the total.

In this particular, rice resembles maize¹ and differs from other cereals.

(c) *Fractional heat coagulation.* The following results were obtained by heating a clear extract of rice made with 10 per cent. solution of sodium chloride.

- 49°-50° C. Opalescence.
- 52°-53° C. Slight flocculent coagulum; the fluid was left at this temperature for two minutes.
- 57°-58° C. Slight increase of coagulum; the fluid was left at this temperature for five minutes, and then filtered, and the filtrate was heated further.
- 64°-65° C. Opalescence; the fluid was left at this temperature for ten minutes, but no coagulum formed.
- 70°-71° C. Bulky coagulum; the fluid was kept at this temperature for five minutes, and then filtered. The clear filtrate was heated further.
- 75° C. Slight opalescence.
- 85°-86° C. Distinct coagulum; the fluid was kept at 87° C. for five minutes, and then filtered; the filtrate was further heated.
- 90°-99° C. Slight opalescence.

It will be seen that the two principal coagula were those obtained at 70° to 71° C., and at 85° to 86° C.; of these the former was the more bulky. The great limitations of this method for the separation of vegetable proteins are well known.² As the method, however, seemed to encourage the hope that it would provide a larger supply of these proteins for further study, some experiments were carried out on a larger scale.

Five kilograms of rice were extracted with 10 per cent. salt solution as before; three extractions were made and 15 litres of a clear solution were obtained. This was worked up in two portions. Each portion was gradually brought to 70° C. in a large water-bath, and kept at that temperature for half an hour. After cooling, the clear supernatant fluid was decanted, and the coagulated protein was collected on a filter, washed with water, alcohol and ether, dried *in vacuo* and weighed.

The clear filtrate, after the separation of the 70° C. coagulum, was

1. Chittenden and Osborne, *Amer. Chem. Journ.*, XIII, p. 453, 1891; XIV, p. 20, 1892; Osborne, *Journ. Amer. Chem. Soc.*, XIX, p. 525, 1897.

2. See Osborne, 'The Vegetable Proteins,' Longmans' *Monographs on Bio-Chemistry*, pp. 15, 44-45, 1909.

heated to 95° C. in a boiling water-bath, and the coagulum collected, washed, dried and weighed as before.

The experiment was repeated in another sample of 5 kilograms of rice in exactly the same way. The yields obtained are given in the following table. Unfortunately in the second experiment an accidental loss occurred during the filtration of the second protein, so the figure there has to be omitted.

Amount of proteins extracted from 5,000 grams of rice, with 10 per cent. sodium chloride solution:—

			Coagulated at 70° C.		Coagulated at 95° C.
<i>Experiment I</i>	5.58 grams	...	1.26 grams
" <i>II</i>	5.0 "	...	—

Taking the first of these two experiments, the only complete one, as a fair sample, it will be seen that the total yield of protein coagulable by heat is 6.84 grams; 100 grams of rice will, therefore, yield 0.13 grams, a figure approximately equal to that obtained in Experiment (*b*) (ammonium sulphate method).

The products obtained by heat-coagulation were obviously of no use for further purification, and an elementary analysis would have been of no value and was therefore not carried out. It also seemed doubtful whether a study of their cleavage products would serve any useful purpose, and so no attempt was made to obtain them in the large quantities which would have been necessary; the amount of raw material which would have had to be dealt with exceeds the usual laboratory conveniences.

The general conclusion to be drawn from this part of the work is that the amount of albumin and globulin forms only a small fraction of the total proteins of 'white rice,' and in this respect rice differs from other cereals (maize alone excepted), the proteins of which have been investigated.

II. THE ALCOHOL-SOLUBLE PROTEINS OF RICE

Preliminary quantitative experiments were first carried out on a small scale in order to estimate the amount of nitrogenous material soluble in 75 per cent. alcohol at various temperatures before and after the extraction of the albumins and globulins. Two of these may be given in detail.

(i) 11.504 grams of finely ground rice were extracted, with frequent shaking, at room temperature with 40 c.c. of 75 per cent. alcohol. After eighteen hours the fluid was decanted off, and the residue again extracted with 15 c.c. of the alcohol. This was repeated three times, and the combined extracts were filtered through asbestos under pressure. The clear filtrate was made up to 100 c.c., and divided into two portions of 50 c.c. each, in which nitrogen estimations were made. The residue was then treated in a similar way with alcohol at 50°-60° C., and nitrogen estimations were made also in the warm alcohol extract. The results calculated from these estimations for 100 grams of dry rice were:

	Gram	
Soluble in cold 75 per cent. alcohol	0.04	Nitrogen
.. warm ..	0.04	..
Total amount soluble in 75 per cent. alcohol	0.08	..

(ii) 10.925 grams of ground rice were extracted with 10 per cent. salt solution to remove albumins and globulins, and subsequently with 75 per cent. alcohol at 60° C. The result calculated for 100 grams of rice came out very near that of the first experiment, namely, 0.085 per cent

Assuming that the whole of the nitrogenous material soluble in alcohol consists of protein (which is probably not the case), its amount is only about 0.5 per cent. of the whole rice, or approximately 6.5 per cent. of the total protein present.

As it seemed advisable to control this result by working on a larger scale, 3 kilograms of the finely ground 'white rice' were allowed to soak in 4 litres of 75 per cent. alcohol. Afterwards the temperature was raised to 50° C. and the mixture kept at this temperature for some time. After filtration the residue was again extracted with 2,500 c.c. of the alcohol, and the clear extracts were concentrated *in vacuo*. As concentration progressed and the alcohol evaporated, a precipitate formed in the residual aqueous solution; more water was added and the precipitate was separated by the centrifuge; this was again suspended in water and again centrifuged. On warming it in 75 per cent. alcohol to 50° C. most of the precipitate went into solution. The solution was filtered warm, and poured into a large volume of absolute alcohol. A white precipitate formed, which was collected on a filter, well washed with absolute alcohol, and dried *in vacuo*. A granular, whitish powder was thus obtained which weighed 0.43 gram (0.014 per cent. of the whole rice).

This experiment was repeated several times with different samples of 'white rice' with practically the same results; and the average percentage worked out at 0.013.

The product appeared to be of protein nature, as it gave the usual protein colour reactions, but it is doubtful if it can be considered a true

alcohol-soluble protein. If we compare its amount (0.013 per cent.) with the amounts easily obtainable from other cereals (for instance, zein from maize is present to the extent of 5 per cent. of the whole grain), the conclusion one arrives at is that 'white rice,' as used for dietary purposes in Japan, contains only a negligible trace of alcohol-soluble protein, a feature which distinguishes rice sharply from all other cereals used as food. This result has since been confirmed by Suzuki, Yoshimura and Fuji⁶ and by A. Fraser and A. T. Stanton⁷.

III. ORYZENIN, THE ALKALI-SOLUBLE PROTEIN OF RICE

It is clear from the preceding that the proteins of rice are only to the smallest extent soluble in salt solution and in 75 per cent. of alcohol. A preliminary experiment on a small scale showed that rice treated with 0.2 per cent. sodium hydroxide solution gave an extract in which a stream of carbon dioxide, or dilute acids produced an abundant white precipitate of protein nature, and from quantitative experiments carried out as before, it appears that approximately 70 per cent. of the total proteins of rice consist of this alkali-soluble protein, to which Rosenheim and Kajiura⁸ gave the name *Oryzenin*.

In order to prepare oryzenin on a larger scale, the ground rice was first thoroughly extracted with 10 per cent. sodium chloride solution, and the residue thus freed from albumins and globulins was then subjected to the alkali treatment.

It was found that the crude preparation always contained a considerable amount of phosphorus, evidently owing to admixture with nucleic acid. When dilute mineral acids were used for the precipitation of the protein from its alkaline solution, the percentage of phosphorus was in every case nearly double of that found when the protein was precipitated by carbon dioxide. Although the amount of phosphorus decreased after repeated precipitation, the last traces were difficult to remove when mineral acid had once been used in its original preparation. The following table shows strikingly the variation in the phosphorus percentage of the crude products. Two consecutive extracts of rice with 0.2 per cent. sodium hydroxide were prepared, and each

6. *Loc. cit.*

7. *Studies from the Institute of Medical Research, Federated Malay States, No. 12, 1911.* These authors also found that the 'polishings' removed from 'white rice' contain a rather larger amount of alcohol-soluble protein, which they, however, were unable to isolate.

8. *Loc. cit.*

extract divided into two parts; one part was precipitated with dilute sulphuric acid, and the other by a current of carbon dioxide.

		P	
Crude oryzenin from first extract	Precipitated with sulphuric acid	...	1.71 per cent.
	„ „ carbon dioxide	...	0.88 ..
From second extract	„ „ sulphuric acid	...	1.58 ..
	„ „ carbon dioxide	...	0.78 ..

In the following preparations, therefore, the alkaline extracts of rice were precipitated by carbon dioxide, and purified by redissolving in 0.2 per cent. alkali and reprecipitation by the same gas.

Preparation of Oryzenin. Five kilograms of finely ground rice were extracted with 10 litres of 10 per cent. salt solution, and after filtration the residue was again extracted with 5 litres of the salt solution. This process was repeated a third time. The residue was then freed as far as possible from the salt solution by pressure in a strong hand-press and then treated with 8 litres of 0.2 per cent. solution of sodium hydroxide, the extract was decanted off, and the extraction repeated four times more with fresh alkali solution, 6 litres being employed each time⁹. The extracts were obtained quite clear by filtration through several layers of thick filter paper, and then precipitated with carbon dioxide; an abundant white amorphous precipitate formed. The precipitates obtained from the first two and the last three extracts were combined and purified separately. They were washed repeatedly by decantation with distilled water, dissolved in 0.2 per cent. alkali and reprecipitated by carbon dioxide. They were washed again by decantation with distilled water, followed by 50 per cent. alcohol, and finally filtered, washed with absolute alcohol and ether, and dried *in vacuo*. The total average yield of crude oryzenin so obtained from 5 kilograms of rice was 62 grams.

For still further purification the product was redissolved in 0.2 per cent. alkali and reprecipitated, the process being repeated many times. As oryzenin, like the glutenin of wheat, is insoluble in neutral salt solutions, its purification by fractional precipitation is impossible, and the only available criterion of its purity consists in the absence of phosphorus after many reprecipitations.

Properties and composition of Oryzenin. The product finally obtained was a perfectly white powder, insoluble in water, neutral salt

⁹ In some cases the extraction was continued still further, until no precipitate was obtained on neutralisation. This is usually the case after the seventh extraction.

solutions alcohol and ether. It dissolves easily in dilute alkalies and acids, and is precipitated on neutralisation. On boiling its suspension in water, oryzenin is coagulated and is thus rendered insoluble in dilute alkali. It gives all the usual protein colour reactions.

Although elementary analysis is of secondary value in the case of high molecular substances, the results obtained by the analysis of two of the purest preparations may not be without interest. The specimens had been redissolved and reprecipitated five times and were practically free from phosphorus. The combustions were carried out by Dumas's method; nitrogen was estimated by Kjeldahl's and sulphur by Pringsheim's method.

As oryzenin represents the only glutelin, except glutenin from wheat, which can be easily obtained from grain, its elementary composition is compared in the following table with that of glutenin. The figures in the table are percentages.

	C	H	N	S	O
Oryzenin preparation (1) ...	51.30	7.05	16.27	0.90	24.48
" (2) ...	51.34	7.24	16.13	0.93	24.36
Glutenin from wheat ¹⁰ ...	52.34	6.83	17.89	1.08	22.26

The figures for oryzenin show a remarkable agreement, considering the nature of the substance, and speak in favour of the uniformity of the product.

The Partition of Nitrogen in Oryzenin. Hausmann's method is now generally accepted as a convenient means for comparing the different forms in which the nitrogen of proteins is present after complete hydrolysis with hydrochloric acid. In the following table the results are given which were obtained from oryzenin by this method, and those furnished by wheat glutenin¹¹ are added for the sake of comparison.

	Total N	In per cent. of Protein				In per cent. of Nitrogen		
		N as Ammonia	N in MgO precipitate	Basic N	Non-Basic N	N as Ammonia	Basic N	Non-Basic N
Oryzenin (1) ...	16.20	1.43	0.11	4.53	10.13	8.8	29.2	61.3
" (2) ...	16.20	1.42	0.11	4.92	9.75			
Glutenin ...	17.49	3.30	0.19	2.05	11.95	18.8	11.7	68.3

It will be seen that the partition of nitrogen in oryzenin differs considerably from that in glutenin, the nitrogen present as ammonia being much lower and the basic nitrogen much higher in the former protein. These features also distinguish oryzenin from the alcohol-soluble proteins. In this respect oryzenin most nearly approaches what is found in the phyto-globulins.

10. Osborne and Vorhees, *Journ. Amer. Chem. Soc.*, XV, p. 392, 1893.

11. Osborne and Harris, *Ibid.*, XXV, p. 323, 1903.

IV. GENERAL CONCLUSIONS

1. The proteins of 'white rice,' as used for dietary purposes in Japan consist only to the smallest extent of albumins and globulins.

2. The amount of alcohol-soluble protein is practically negligible thus distinguishing rice sharply from all other cereals hitherto investigated.

3. The main protein of rice, oryzenin, belongs to the glutelin class (proteins soluble in dilute alkali). In its nitrogen partition it differs from wheat glutenin (the only other glutelin so far studied) very considerably.

This research was carried out under the direction of Dr. Otto Rosenheim. Unfortunately it was left in an unfinished state owing to the author's return to Japan. It has, however, been thought advisable to publish the results, and the paper has been compiled by Dr. Rosenheim from the notes which Dr. Kajiura left behind him.

The expenses of the research were defrayed from grants made by the Government Grant Committee of the Royal Society, to whom the thanks of the Laboratory are due.—
W. D. HALLIBURTON, Professor.

SOME FURTHER EXPERIMENTS ON THE PHYSIOLOGY OF THE ALLYL COMPOUNDS

By E. WACE CARLIER, M.D., F.R.S.E., ETC.

From the Physiological Laboratories of the University of Birmingham

(Received December 9th, 1911)

Owing to the difficulty of determining whether the effects of allyl-isothiocyanate upon respiration and blood pressure, previously recorded by me,¹ were due to the allyl or the isothiocyanate moiety of the compound, it appeared advisable to perform similar experiments with at least one other isothiocyanate as well as with various allyl compounds.

With this end in view it was determined to investigate the action of phenyl-isothiocyanate C_6H_5NCS upon deeply-anaesthetised rabbits.

As in the case of the allyl compound, 10 per cent. and 20 per cent. solutions of the substance in olive oil were used, but produced so little effect that in subsequent experiments undiluted phenyl-isothiocyanate was alone employed.

Phenol-isothiocyanate

Only one experiment with this substance needs to be recorded in detail. Fig. 1.

1 minim (0.06 c.c.) of the drug was injected into the jugular vein of a deeply-etherised rabbit, weighing 1950 grams and registering a blood pressure of 75 mm. mercury.

Eleven seconds after the commencement of the injection the blood pressure began to rise, and attained to 82 mm. in 20 seconds; this was followed by a depressor effect to 67 mm. at the 60th second. Seven seconds later it rose again to 70 mm.; this slight recovery was succeeded by a slow fall, which reached as low as 31 mm. at the 480th second, after which a slow rise commenced that had attained to 79 mm. at the 1070th second.

No marked effect upon the respiratory movements was observed until the 63rd second after injection, when a deep gasp occurred followed by respirations rapidly diminishing in amplitude to the 95th second, after

1. *Bio-Chemical Journal*, Vol. IV, p. 107.

which they quickly increased, almost but not quite reaching their initial amplitude at the 120th second. At the 170th second a slight decrease set in, followed at the 193rd second by a sudden fall to one-fourth the initial

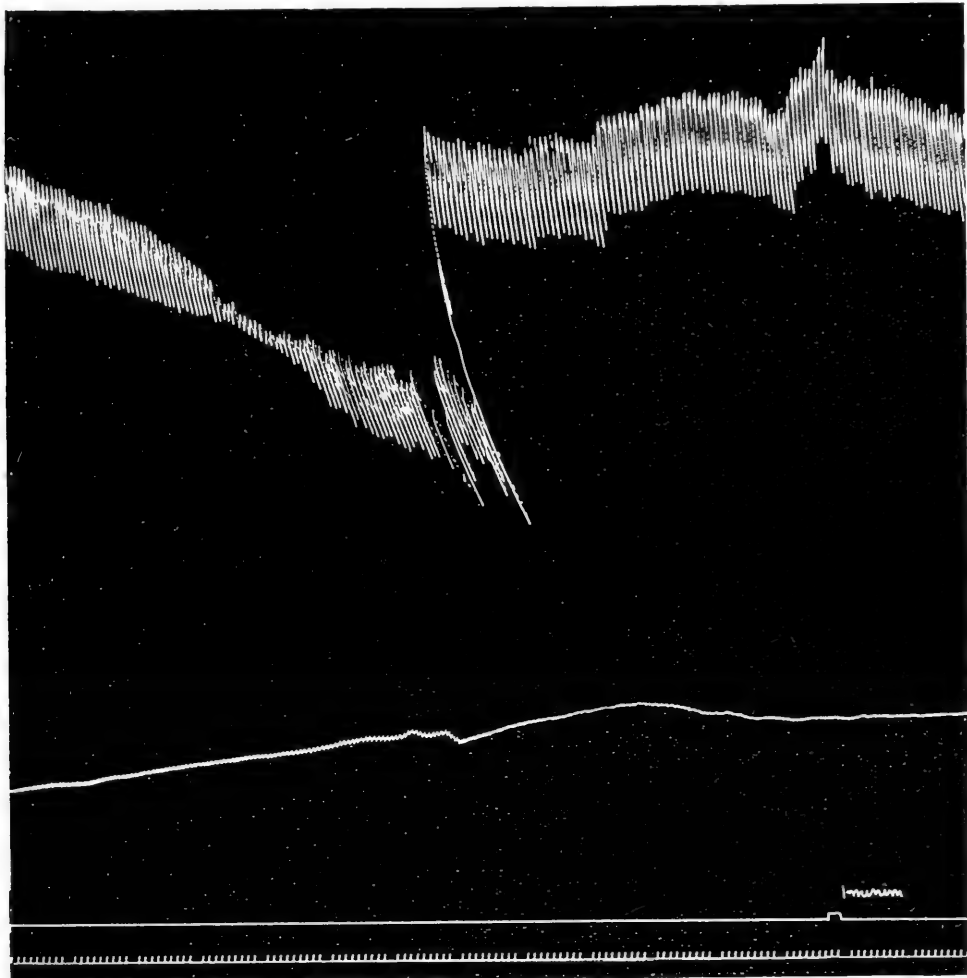

FIG. 1. The effect of 1 minim (0.06 c.c.) Phenyl-isothiocyanate injected into the Jugular Vein of a Rabbit.

All Figures to be read from right to left.

amplitude accompanied by a slowing of rhythm; from this recovery was slow, reaching only one-third the original size at the 1076th second. A marked feature of this recovery was the occurrence, at fairly regular

intervals, of a gasping inspiration, the first of which took place at the 210th second, the second at the 274th, followed by others at the 340th, 403rd, 471st, 530th, 580th, 636th, 675th, 717th, 753rd, 801st, 836th, 873rd, 910th, 950th, 980th, 1012th, 1047th, second.

Very little change in the force and rate of the heart beat appears in the tracing.

The temperature of the animal, as ascertained by placing the bulb of a thermometer in the vagina from the 210th to the 274th second, was 35° C.

Some time later, when the respiratory movements had become equal to half their initial size, another minim (0.06 c.c.) was injected into the vein, with similar though less-marked results, except for respiratory gasps which were repeated every twenty to thirty seconds. The animal was killed twenty-two minutes after the second injection.

In other experiments 2 minims (0.132 c.c.) and 3 minims (0.198 c.c.) doses were injected into the jugular vein, and produced similar results on the pressure, but caused more marked and more lasting respiratory spasms. The 3 minims (0.198 c.c.) dose proved fatal in 190 seconds, at which moment the blood pressure fell to zero, the heart having ceased beating ten seconds earlier. Nevertheless the respiratory movements continued, increasing in amplitude and rate till the 240th second when they suddenly failed. The heart, therefore, stopped quite fifty seconds sooner than the respiration.

Post mortem examination showed that intra-vascular clotting had taken place.

Effect of small doses.— $\frac{1}{10}$ minim (0.006 c.c.) in olive oil when injected into the circulation produces a temporary slight fall in the blood pressure. $\frac{1}{5}$ minim (0.012 c.c.) dose causes an initial slight rise followed by a fall, which is still more marked by a $\frac{1}{2}$ minim (0.03 c.c.) dose.

To affect the respiration a 1 minim (0.06 c.c.) dose is necessary, and a dose of $1\frac{1}{2}$ minims (0.09 c.c.) to alter the heart beat. Three minims (0.198 c.c.) may be taken as a fatal dose for a full sized rabbit weighing 2200 grams. This is approximately $1\frac{1}{2}$ minims (0.09 c.c.) per kilogram of body weight.

Phenyl-isothiocyanate, though a poison, is much less fatal than allyl-isothiocyanate, the lethal dose of which is $\frac{1}{5}$ minim (0.012 c.c.) per kilogram of body weight.

The phenyl compound acts upon the circulatory system more powerfully than upon the respiratory; probably, therefore, the very

poisonous action of allyl-isothiocyanate upon the respiratory centre is due to the allyl moiety; its action on the circulation may or may not be due in some measure to the isothiocyanate moiety.

Two substances analogous to allyl sulphide were experimented with: ethyl sulphide and ethyl hydrogen sulphide. Ethyl sulphide (C_2H_5)₂S differs from allyl sulphide (C_3H_5)₂S only in containing two atoms of carbon less in its molecule. Ethyl hydrogen sulphide or mercaptan is C_2H_5HS .

Ethyl Sulphide (C_2H_5)₂S

Ethyl sulphide in saturated solution has but slight effect upon the frog's heart.

Five minims (0.33 c.c.) injected into the ventricle of a pithed frog diminished the force of the heart to half the normal for a beat or two only, the heart completely recovering from this dose in five beats. A similar dose injected into the right auricle produced no alteration in the heart's action. A 10 minim (0.66 c.c.) dose, slowly injected into the ventricle produced a more marked effect, arresting its contractions for forty seconds, after which the ventricle began to beat again, feebly and slowly at first, but rapidly increasing in force and frequency, with very strong contractions at intervals; it regained first its normal rhythm and some time later, at the 390th second, its initial force. The auricles continued beating throughout the experiment, though with diminished rapidity during the ventricular stasis.

Fifteen minims (0.99 c.c.) injected into the ventricle produced a similar change in the heart's action lasting 410 seconds, but its effect was rather one of duration than of amount.

Owing to the feeble action of this drug on the frog's heart no experiments upon rabbits were made with it.

Ethyl mercaptan, C_2H_5HS

Two minims (0.12 c.c.) injected into the right auricle of a pithed frog resulted at once in the loss of one heart beat, followed by considerable increase in the force of the contractions for eleven beats. This was followed by a sudden diminution in force lasting for twelve beats, from which it returned again to normal eleven beats later. The effect of the dose lasted in all through thirty-five heart beats, occupying seventy-four seconds. The injection of 2 minims (0.12 c.c.) (Fig. 2a)

into the ventricle immediately produced a diminution in the rate and force of its contractions, which gradually became smaller during twenty-four beats. Recovery began at the 39th beat and was achieved at the 74th. From the moment of injection to the completion of recovery 125 seconds had elapsed. At no time was there complete cessation of either auricular or ventricular movement and the diminution in rate was trivial and transitory, the beats succeeding each other more rapidly as the heart's contractions diminished.

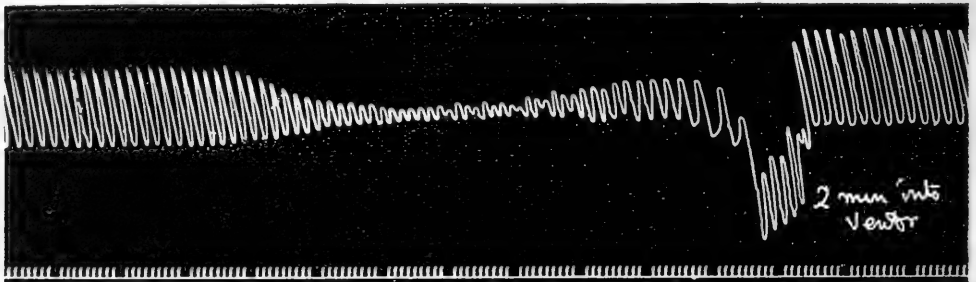

FIG. 2a. Injection of 2 minims (0.12 c.c.) Ethyl mercaptan into Frog's Ventricle.

An injection into the ventricle of 3 minims (0.18 c.c.) (Fig. 2b) resulted in a gradual diminution of the heart beat, until the auricles alone remained in action. Complete recovery eventually occurred, but not until the 789th second after injection.

Five minims (0.30 c.c.) introduced into the ventricle stopped that chamber in sixteen beats, but succeeded only in slowing the auricular rhythm. After a time the ventricle started to beat again, and quickly not only regained but surpassed its normal force, but with much slower rhythm.

When 10 minims (0.60 c.c.) were slowly injected into the ventricle, spasms of the skeletal muscles occurred with arrest of the heart for thirty-six seconds, both auricles and ventricle ceasing to beat. At the 36th second a feeble contraction took place, followed at intervals by several stronger ones, then, after a pause, a number of rapid beats were registered in succession, followed by a pause of a few seconds' duration; after which the heart rapidly recovered its strength but not its speed, which remained diminished as long as the experiment lasted.

These experiments prove that in the frog ethyl mercaptan acts more powerfully upon the ventricle than upon the auricles; that in some cases it can produce heart block, but the dose required to effect this is large

and the duration of the blocking short. Small doses accelerate the rhythm to some extent, whilst large doses retard it for a considerable time. In no case was the dose administered sufficiently large to permanently arrest the heart.

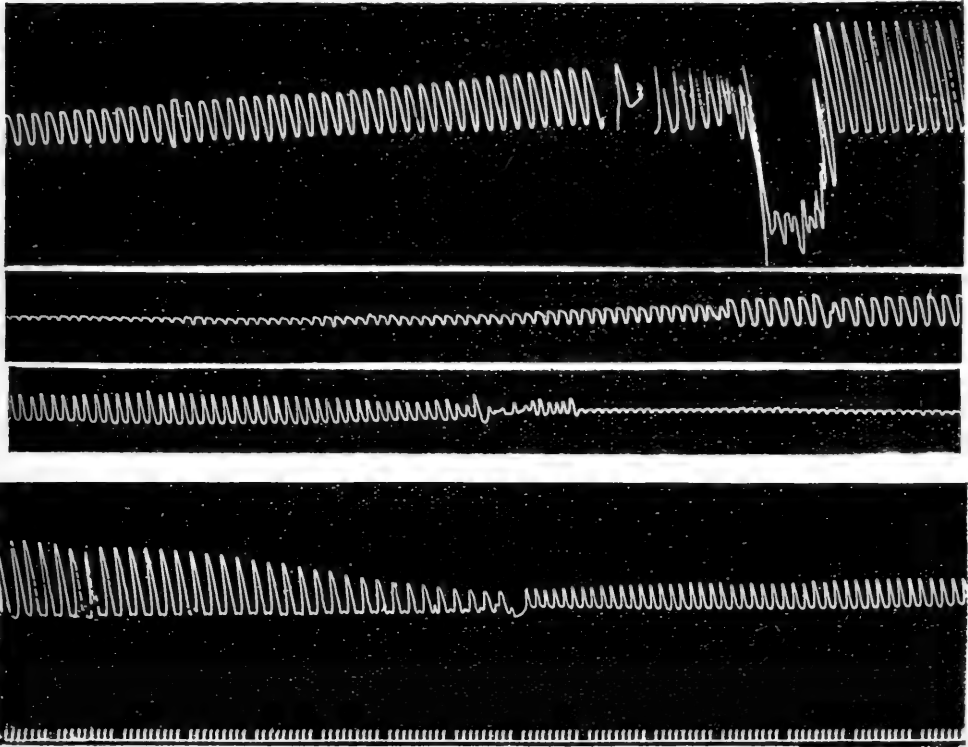

FIG. 2*b*. Injection of 3 minims (0.18 c.c.) Ethyl mercaptan into Frog's Ventricle.

Read from right to left.

A number of experiments with ethyl mercaptan were performed on deeply etherised rabbits; the solutions used varying in strength in different cases. As with allyl sulphide the best diluent was found to be olive oil.

The injection of 5 minims (0.30 c.c.) of a 20 per cent. solution into the jugular vein of a large rabbit weighing 2250 grams produced a slight fall in blood pressure, followed 40 seconds later by a slight rise above the normal. The highest pressure was recorded 130 seconds later, and was maintained for 90 seconds; then a gradual fall set in which reached the normal in 260 seconds.

An injection of 15 minims (0.90 c.c.) of the same solution was then made, producing a sudden rise followed by a continuous slow rise lasting 310 seconds.

When 20 minims (1.20 c.c.) of a 20 per cent. solution were introduced into the jugular vein a slight fall from 86 to 81 mm. mercury at once occurred, followed by a rapid rise to 93 mm. in 25 seconds. Then there was a sudden fall to 85 mm. in 2 seconds, after which a gradual rise to 89.2 mm. set in and occupied 163 seconds. At this moment the pressure suddenly fell to 89 mm. and continued to fall slowly to normal, which was reached in 135 seconds.

These small doses produced no visible alteration either in the heart beats or in the respiratory movements.

One minim (0.06 c.c.) of undiluted mercaptan introduced into the jugular vein of a rabbit (Fig. 3) produced, 10 seconds after its injection, a rapid fall in blood pressure from 79 mm. mercury to 74 mm. in 13 seconds, succeeded by a further fall to 50 mm. in the next 29 seconds. Thereafter the pressure began to rise and attained to 76 mm. 423 seconds after injection. Coincident with the beginning of the pressure fall a great respiratory effort was made, followed by increased respiration, lasting 60 seconds. The amplitude of these movements then began to diminish, but at the 130th second another deep breath occurred, followed by increased breathing, which continued so to the end of the experiment. At the 310th second a very deep inspiration was registered, after which slight Traube-Herring curves appeared in the pressure trace.

At the time of the pressure fall, the heart became weakened without change of rhythm, and remained affected for some time though it completely recovered its strength towards the close of the experiment.

The injection into the jugular vein of a rabbit of 3 minims (0.18 c.c.) of undiluted drug caused at the end of 10 seconds a deep inspiration, and at the end of 29 seconds a rapid fall in blood pressure. The pressure fell from 69 mm. mercury to 48 mm. in 22 seconds, followed by a sudden drop to 28 mm. in 1 second. At the 80th second recovery began, but after reaching 38 mm. at the 103rd second began again to fall rapidly. At the 150th second the pressure was only 10 mm., and at the 293rd it had died out altogether.

The respiratory mechanism was much affected by this dose. The deep inspiration at the 10th second was followed by normal breathing until the 40th second, when suddenly the movements trebled in size for four seconds, after which they grew rapidly more and more shallow,

without alteration in speed, until the 70th second. After that their frequency as well as their force became less, until they failed entirely at

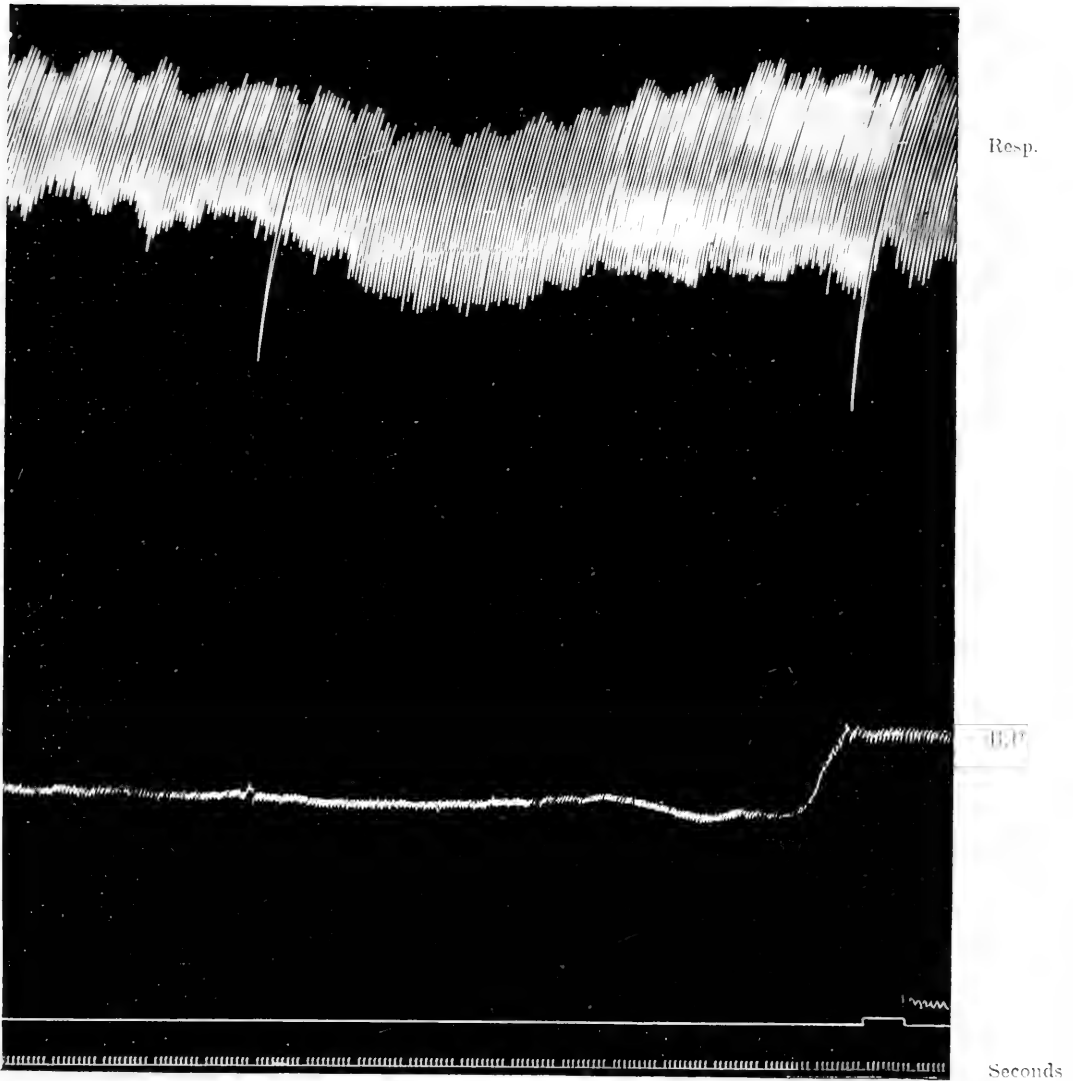

FIG. 3. 1 minim Ethyl mercaptan injected into the Jugular Vein of a Rabbit.

the 124th second. Artificial respiration proved of no avail, though it was continued to the end of the experiment.

The force of the heart began to diminish at the same time as the blood pressure began to fall and the heart almost stopped when the sudden fall in pressure was registered; it, however, recovered for a time, but again became feeble just before the respiration ceased. Thereafter the beats were minute, and the heart finally stopped at the 293rd second after the injection.

Three minims (0.18 c.c.) of ethyl mercaptan introduced into the circulation of a rabbit appears to cause death by respiratory paralysis, whether it is administered in one dose or injected in two doses with a short interval between.

The fatal dose for the rabbit works out approximately at $1\frac{1}{4}$ minims (0.075 c.c.) per kilogram of body weight.

Injection into Serous Cavities

Three minims (0.18 c.c.) of ethyl mercaptan were injected into the pericardial cavity of a deeply-etherised rabbit weighing 2800 grams. Its blood pressure, which registered 98 mm. mercury, rose in 260 seconds to 126 mm., at which it was maintained for 90 seconds, then muscular tremors set in, producing a slight fall, but when they ceased the pressure increased to 146 mm. This high pressure was not long maintained, but was followed by a fall, rapid at first, then gradually becoming slower, it reached to 124 mm. Next a gradual rise set in to 138 mm., followed by a slower fall to 108 mm.

In this experiment the respirations increased in amplitude somewhat, especially just after the muscular tremors ceased, but returned again to their initial size long before the blood pressure had fallen to 108 mm. The heart's action was not appreciably affected.

When the blood pressure had remained stationary at 108 mm. for some time, 1 minim (0.06 c.c.) of allyl sulphide was introduced into the pericardial sac, with the result that in 13 seconds the blood pressure began to fall and reached 96 mm. in 17 seconds. Fifty-five seconds later it had again returned to 108 mm.

No change was observed in either respiratory or cardiac movement.

Two minims (0.18 c.c.) of allyl sulphide were now slowly injected into the pericardial cavity (Fig. 4) and produced considerable variation in blood pressure, due no doubt to the fluid pressing on the heart. Ten seconds after the injection a rapid fall in pressure occurred to 84 mm. succeeded by a slower fall to 44 mm., which was reached at the 35th second and at which it remained until the 50th second. A slight pressor

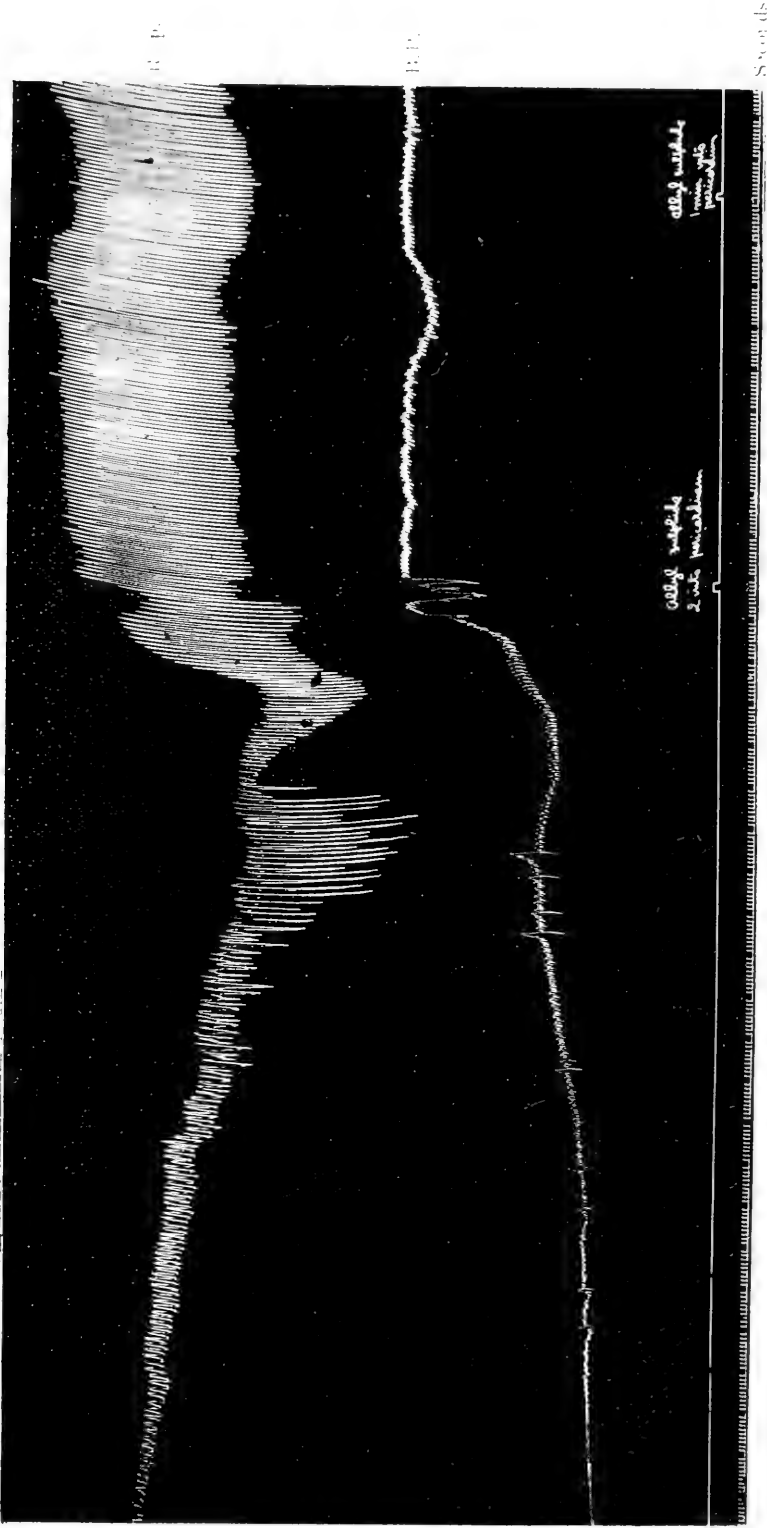

FIG. 4. 2 minims (0.12 c.c.) of Allyl Sulphide injected into the Pericardial Cavity of a Rabbit.

effect then set in which reached 50 mm. at the 70th second, followed by a depressor movement which ended at 0 mm. at the 420th second. The respiratory mechanism was at first somewhat depressed, and from the 31st second began to fail rapidly. At the 51st second hyperpnoea supervened and lasted thirty seconds, after which respiratory movements became gradually feebler and failed altogether at the 270th second, thus failing much sooner than the heart. This is a typical action of allyl sulphide.

One minim (0.06 c.c.) of ethyl mercaptan was injected into the pericardial cavity of a deeply-etherised rabbit weighing 1850 grams. The initial blood pressure was 85 mm. mercury. Eight seconds after injection the pressure began to fall, reaching 56 mm. at the 24th second, a rise then began and reached 68 mm. at the 77th second. This was succeeded by another fall which attained to 63 mm. at the 107th second, at which level it remained until the 217th second, when a new pressor movement set in and reached 78 mm. by the 517th second.

Respiratory movements were but slightly diminished in amplitude, without change of rhythm, and the heart remained quite unaffected by this dose.

Two more minims (0.18 c.c.) were then slowly introduced into the pericardium. Nine seconds later the blood pressure began slowly to fall and reached 60 mm. in 175 seconds, this was followed by a gradual rise to 68 mm., which was reached 150 seconds later. At this time the respiratory movements were becoming weaker though the heart was beating normally. Four minims (0.24 c.c.) were now slowly injected into the pericardial sac and produced no effect for 126 seconds, when respiratory spasms occurred and lasted 20 seconds. They produced a slight rise in blood pressure, but it returned again almost immediately to 68 mm. The animal was then killed.

Allyl Acetate

One minim (0.06 c.c.) (Fig. 5) of allyl acetate was injected into the jugular vein of a deeply-etherised rabbit weighing 2300 grams. Ten seconds after injection the blood pressure began to fall from 98 mm. to 70 mm. in 16 seconds. The pressure then began to rise again, slowly at first, then more rapidly and attained to 100 mm. at the 51st second. A U-shaped depression was thus produced in the pressure trace. This dose produced considerable alteration in the respiratory movements, reducing their amplitude by one-third in the first twelve seconds. Slight

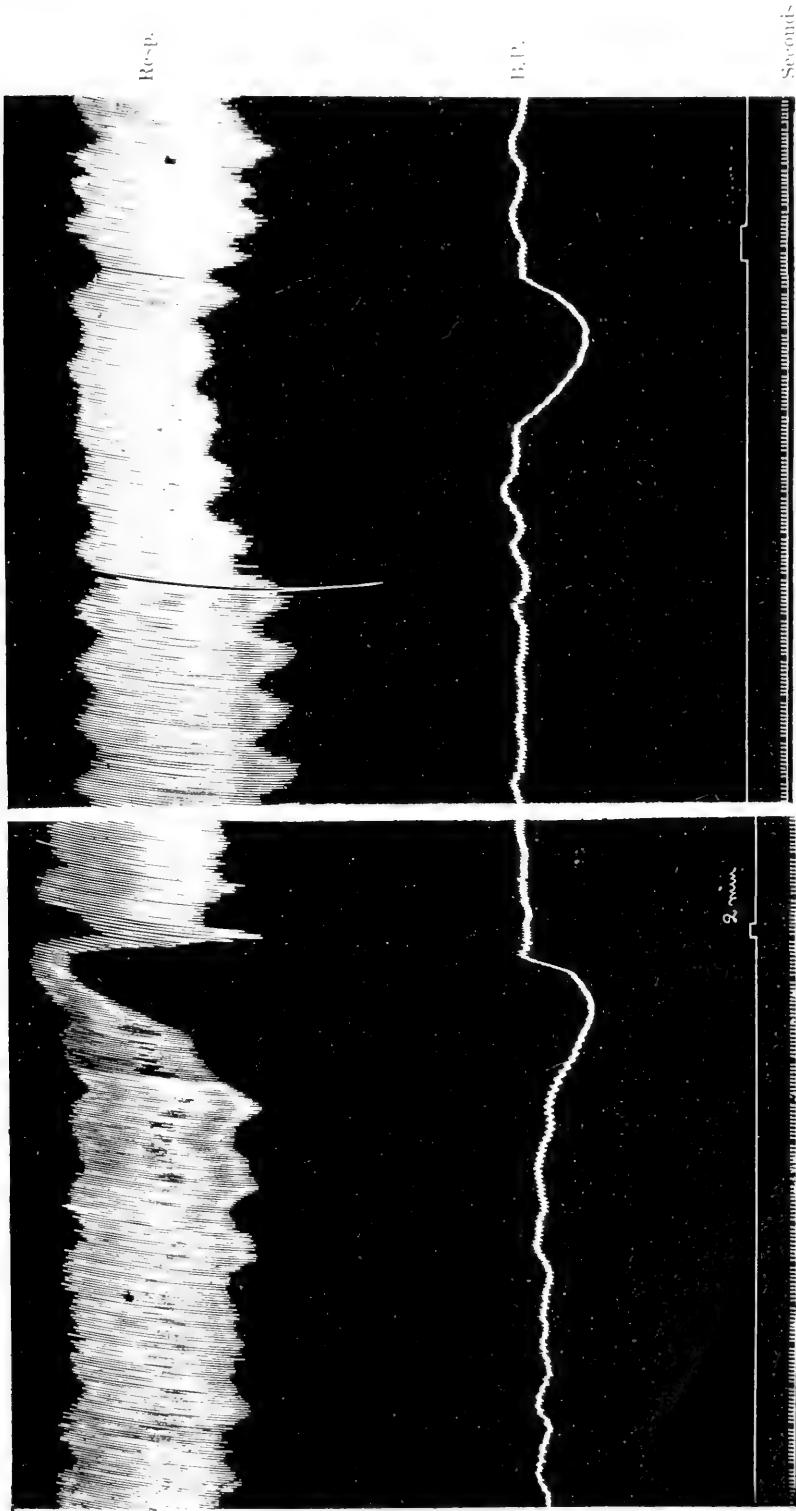

FIG. 5. 1 minims (0.06 c.c.) Allyl Acetate injected into the Jugular Vein of a Rabbit.

FIG. 6. 2 minims (0.12 c.c.) Allyl Acetate injected into the Jugular Vein of a Rabbit.

recovery then set in, but at the 19th second they again became smaller and remained so to the 58th second; from this moment the movements increased until they finally slightly surpassed their initial size. At the 88th second a deep inspiration was recorded. During the whole experiment no change in the respiratory rhythm or alteration in the cardiac movements occurred.

Two minims (0.18 c.c.) (Fig. 6) were next injected into the vein, producing similar results, beginning from the 8th second and being more intense and prolonged than with the previous dose. Another 2 minims (0.18 c.c.) were introduced into the vein, with the result that the blood pressure began to fall from the 8th second, but did not fall so low as on the previous occasion, and on again rising did not attain a higher level than 93 mm., at which it remained to the end of the experiment.

These results show that allyl acetate is very feeble when compared with allyl sulphide, but that its action is similar in that it affects the respiratory mechanism first, leaving the heart practically unaffected by the small doses exhibited. No doubt larger doses would have altered the cardiac action also, but the supply of the drug failed.

The lethal dose of allyl acetate was not determined.

Allyl Alcohol, C₃H₅OH

To ascertain the action of this substance upon the vascular and respiratory mechanisms it was deemed advisable to dilute it, otherwise intravascular clotting was to be feared soon after its introduction into the circulation. One minim (0.06 c.c.) of a ten per cent. solution in normal saline was injected into the jugular vein of a deeply-etherised rabbit weighing 2750 grams, with the result that the blood pressure fell from 105 mm. mercury to 96 mm. in 79 seconds. The heart beat and respiration remained unchanged, and therefore 4 minims (0.24 c.c.) of the same solution were introduced, which sent the blood pressure up to 98 mm. in 31 seconds. A fall to 90 mm. at the 42nd second followed and was succeeded by a rise that attained to 97 mm. at the 66th second. This was not maintained, the pressure falling to 90 mm. at the 82nd second, after which it again started to rise. This alternate rise and fall of the pressure continued until the 222nd second, when another injection was made. During the whole of this time the heart beats and respiratory movements remained unaltered.

Five minims (0.30 c.c.) were introduced, as just stated, at the 222nd second, and produced a fall of pressure to 87 mm. 19 seconds later,

followed by a steady rise to 108 mm., which was reached in another 131 seconds. As before, the respiration remained unaffected, but the force of the heart was increased by one-half, without alteration in rhythm. The introduction of another 5 minims (0.30 c.c.) produced a similar result.

When this dose was doubled the blood pressure rose to 122 mm. in 190 seconds, but the respiratory and cardiac mechanisms were not further altered by it.

Three minims (0.18 c.c.) of undiluted allyl alcohol were next injected into the vein, with the result that the blood pressure fell to 79 mm. in three seconds, and was followed by a rise to 84 mm. at the 21st second. Then another fall began, reaching 69 mm. at the 32nd second followed by a second rise to 88 mm. at the 47th second. Thereafter a slower fall commenced, reaching as low as 65 mm. by the 93rd second and remained at that level until a new injection was attempted at the 300th second, which was found impossible owing to a long clot extending from the syringe to the thoracic veins. The only effect produced by this dose upon the respiration was to cause two deep inspiratory movements, but the force of the heart beat was increased by half its initial amount, its rhythm remaining the same.

Forty minims (2.4 c.c.) of a twenty per cent. solution in normal saline, equivalent to 8 minims (0.48 c.c.) pure allyl alcohol (Fig. 7), were introduced into the jugular vein of a deeply-etherised rabbit weighing 2270 grams, the injection taking 86 seconds.

From the very commencement of the injection the blood pressure began to rise from 108 mm., and reached 116 mm. in 11 seconds; then it began to fall more gradually to 100 mm., taking 14 seconds to reach that point, only to again rise gradually to 110 at the 51st second; followed by another fall to 98 mm. at the 66th second. Again it rose to 108 mm. at the 174 second only to fall to 46 mm. at the 1100th second. This was followed by a rise to 66 mm. at the 1900th second, when suddenly violent convulsions occurred that put a stop to further experiments.

This dose had an effect upon the respiration, causing at first a temporary decrease in the amplitude of the respiratory movements, followed by an increase with sundry fluctuations until the movements had nearly doubled at the onset of the convulsions. A marked feature of its action was the occurrence of a number of sudden very deep inspirations, beginning at the 258th second and recurring at intervals of about 70 seconds until the end of the experiment. The heart was but little affected.

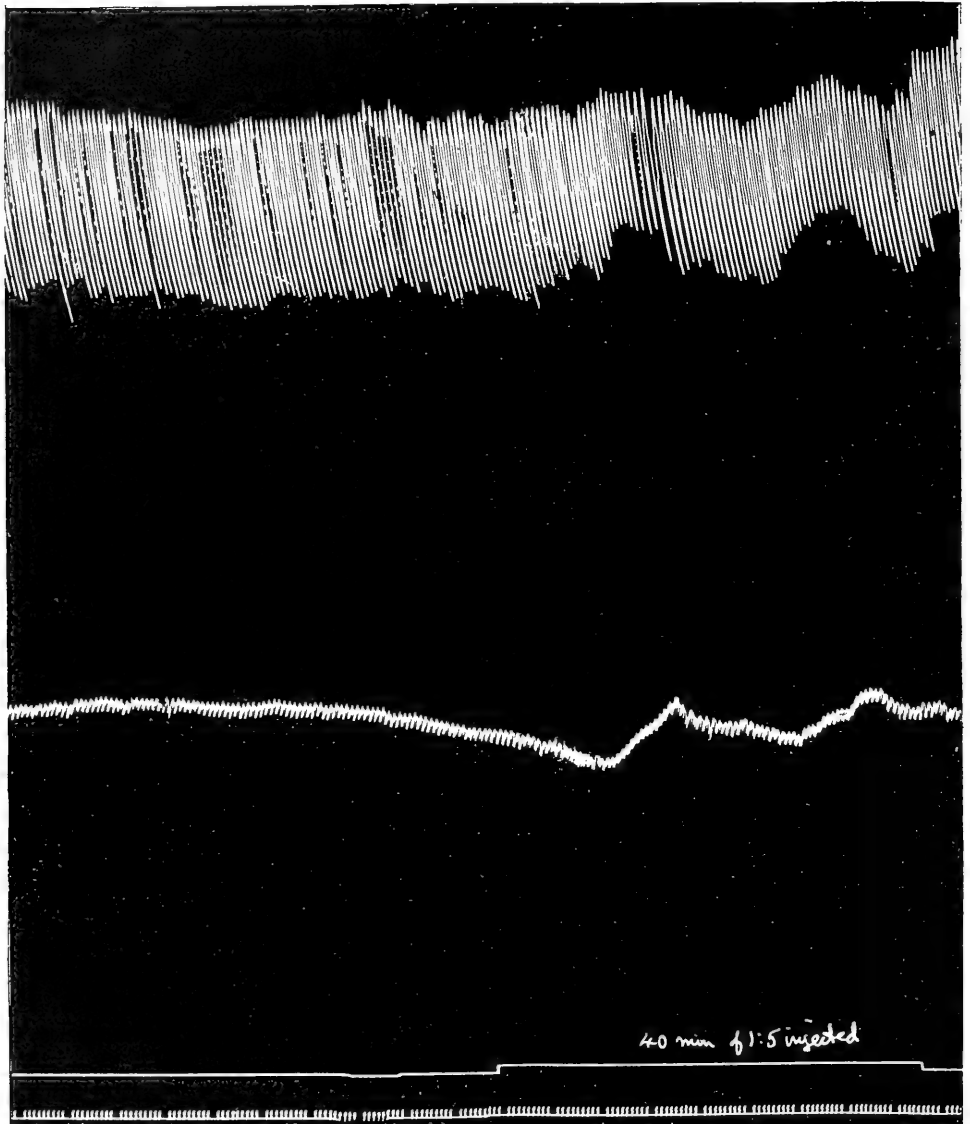

FIG. 7. 40 minims (2.4 c.c.) of a 20% solution of Allyl Alcohol in normal Saline injected into the Jugular Vein of a Rabbit.

In the rabbit, therefore, allyl alcohol acts chiefly upon the blood pressure, but in large doses affects the respiration also, resembling phenyl-isothiocyanate in producing deep inspirations at intervals. Its effect upon the heart is slight, merely increasing its force.

The lethal dose was not ascertained.

Though allyl alcohol appears to have little action on the mammalian heart when injected into the circulation, the case is very different when it is applied directly to the amphibian heart, as will be apparent from the following experiments:—

A drop of pure allyl alcohol allowed to fall upon the surface of the ventricle of a pithed frog at once diminished the force of the contraction by one-third. This depressed condition gradually passed off, the beat attaining to three-fourths of its initial amplitude in 140 seconds.

Two drops allowed to fall on the ventricle diminished the heart beats by one-half; from which they recovered somewhat, but attained only two-third their original amplitude in 230 seconds.

One minim (0.06 c.c.) of a twenty per cent. solution in normal saline injected into the left auricle (Fig. 8) produced cessation of the ventricular contraction in 15 seconds, though the auricles continued to beat as before. Ninety seconds later the ventricle started to beat again, but not with normal force; 320 seconds later the beats had regained only three-fourths of their normal size.

When one minim (0.06 c.c.) of the same solution was injected into the cavity of the ventricle (Fig. 9) the whole heart ceased contracting in 10 seconds and remained motionless for 120 seconds. The auricles then resumed beating, feebly at first, but gaining in strength they continued to contract for 750 seconds, their contractions succeeding each other more slowly than before the injection. The ventricle never contracted again.

From a number of such experiments performed upon large healthy frogs it may be concluded that allyl alcohol does act upon the heart, both auricles and ventricles being affected by it; but its action is much more profound upon the latter chamber than upon the auricles.

Some experiments, by way of contrast, were performed upon the hearts of pithed frogs with ethyl alcohol (C_2H_5OH) with the object of ascertaining whether or no the results obtained with alcohol were due to dehydration or to coagulation of the muscular substance.

One minim (0.06 c.c.) ethyl alcohol placed on the surface of the ventricle, at once brought the heart to a standstill, but this lasted only ten seconds, after which the whole heart started beating again with normal force and rhythm.

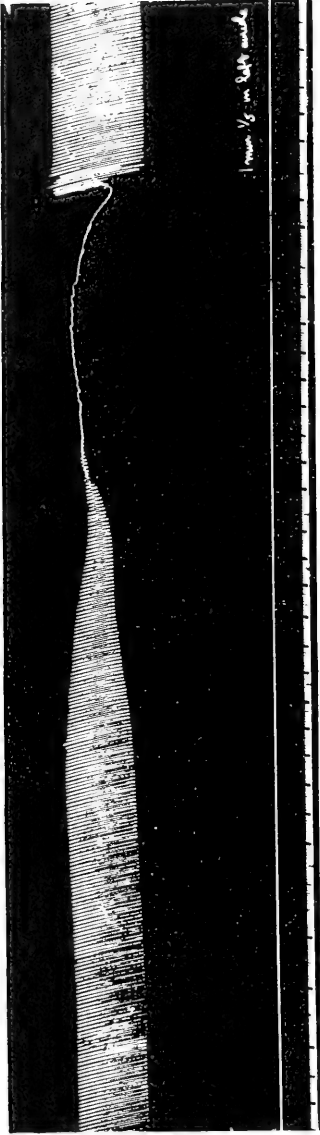

FIG. 8. One minim (0.06 c.c.) of a 2% solution of Allyl Alcohol in Normal Saline injected into Frog's Auricle.

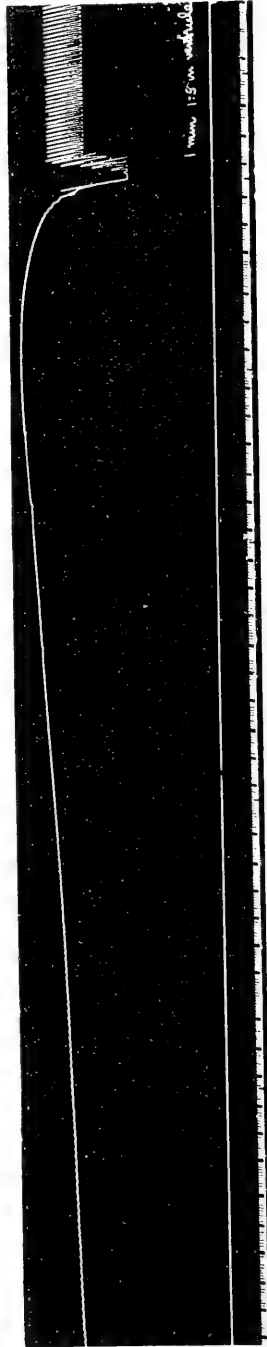

FIG. 9. One minim (0.06 c.c.) of a 20% solution of Allyl Alcohol injected into Frog's Ventricle.



FIG. 10. 3 minims (0.18 c.c.) of a 20% solution of Ethyl Alcohol injected into Frog's Ventricle.

A single drop placed on the auricles caused the heart to stop at once for 17 seconds, then, after slowly contracting twice, it resumed its normal beat.

In both cases the effect was suddenly produced and as suddenly recovered from.

Three minims (0.18 c.c.) of a twenty per cent. solution in normal saline injected into the ventricle (Fig. 10) stopped the heart in diastole for 120 seconds, the auricles then resumed their beating, somewhat feebly at first, but steadily gaining in strength. The ventricle resumed beating 140 seconds later, at first feebly with numerous interruptions, but gradually increasing in strength, the beats had attained to one-half their original amplitude when a second injection was made. This only increased the duration of the period of rest and delayed recovery.

This is again an example of the lethal effect of allyl as compared with ordinary alcohol. One minim (0.06 c.c.) of a twenty per cent. solution of the former was sufficient to permanently arrest the ventricle whilst 3 minims (0.18 c.c.) of the same strength of ethyl alcohol did not prove fatal to the heart's action. Both alcohols have this in common, that they affect the ventricle more profoundly than the auricles.

CONCLUSION

From all these experiments it may, I think, be concluded that the poisonous action of the allyl compounds is due to the allyl they contain, though in some cases, no doubt, its activity may be increased, and in others diminished by the substances with which it happens to be combined.

My thanks are due to Mr. C. Lovatt Evans, B.Sc., for the preparation in my laboratories of most of the compounds used in these experiments.

THE INFLUENCE OF PROTOPLASMIC POISONS ON
'REDUCTASE'

By D. FRASER HARRIS, M.D., D.Sc., *Professor of Physiology and
Histology in the Dalhousie University, Halifax, N.S.*

(Received December 16th, 1911)

Continuing my investigations¹ into the reducing endo-enzyme, I have examined a number of 'protoplasmic poisons' to see whether they inhibited the activity of tissue reductase.

Waller² lately emphasised the necessity of distinguishing between the action of a poison upon protoplasm and its action on enzymes. He pointed to chloroform killing the laurel leaf but liberating instead of restraining an enzyme in the leaf which evolves hydrocyanic acid. The poison studied must not, of course, by itself bleach any of the pigments used in this research, viz., soluble Prussian blue, methylene blue and sodium indigo disulphonate. This condition eliminated such a poison as hydrocyanic acid, for instance, so that I need only record results with those as follow:—

Chloroform. Five drops of chloroform added to 5 c.c. of sheep's liver juice in presence of 5 c.c. of 0.06 per cent. of Prussian blue exerted only a very slight inhibitory action.

Chloroform has, however, the property of altering the physical state of the press-juice as to make it much less miscible with watery liquids so that it thus removes the pigment from the sphere of action of the reductase.

To vary the conditions, I perfused a sheep's kidney, previously washed till blood-free, with 1 per cent. sodium chloride having 10 per cent. chloroform in it. As soon as the vessels had been traversed by this mixture, the kidney became of a soft, 'dead white' appearance, and was also more friable.

1. This Journal, Vol. V, p. 143, 1910.
2. Proc. Phys. Soc., June 18th, 1910.

The glycerine extract of this chloroform-killed kidney reduced Prussian blue, but much more slowly than did the juice of a control of normal kidney.

The general conclusion come to was that chloroform did not inhibit the enzyme, but tended to coagulate the cell-proteins in which the enzyme was fixed and immobilised.

Sodium fluoride. A 0.5 per cent. solution was used. Employed against a control, this substance certainly did not seem to act as an inhibitor of the reducing enzyme. The solution was noticed to be distinctly alkaline, so that the bleaching might have been due to that condition.

Accordingly some sodium fluoride solution was made very slightly acid, and added to a mixture of glycerine extract of sheep's liver and Prussian blue. This mixture was well reduced, and the leuco compound readily restored by treatment with hydrogen peroxide. Sodium fluoride does not *per se* inhibit reductase.

Nitrobenzene. This is a powerful protoplasmic poison without reducing action on the three pigments. A glycerine extract of sheep liver juice was used with this poison. -

After twelve hours in the water bath at 40° C. the contents of the tube with the poison and the control tube were both well reduced; the laboratory notebook has the entry: 'if anything, the tube with the nitrobenzene is the whiter.' This observation was repeated several times, so that I think we may infer that nitrobenzene is not a poison to 'reductase.'

Formalin (10 per cent. solution). This poison does not reduce Prussian blue although it precipitates it. Some kidney press-juice and Prussian blue were mixed with 5 c.c. of the formalin solution and, along with a control tube, were kept in the water bath at 40° C. overnight. Next morning the control tube was almost white, while the tube with the poison was still blue. Suspecting acidity, I found that this formalin was acid both to litmus and to phenolphthalein. When a little formalin was the very slightest over-neutralised by some N/10 sodium hydrate, and added to kidney juice in presence of Prussian blue, the pigment was bleached. It would appear that the reductase was previously inhibited by the acidity of the formalin and not by its poisonous property, whatever that may be.

From these experiments the general impression seems to be that acidity is the inhibitant factor rather than the toxicity. Hydroxylamine sulphate, for instance, a powerful protoplasmic poison, is so acid in reaction that the fact that it prevents any fading of Prussian blue in presence of tissue-juice is not to be taken as a proof that hydroxylamine sulphate inhibits the reducing endo-enzyme.

The expenses involved in this research were met by a grant from the Government Grant Committee of the Royal Society.

NOTE ON HYDROLYSIS OF VEGETABLE OILS BY EMULSION OF *RICINUS COMMUNIS*

By DAVID SOMMERVILLE, B.A., M.D., M.R.C.P., *Lecturer in Public Health, King's College, University of London.*

(Received October 7th, 1911)

In 1902 Counstein Hoyer and Wartenberg described a series of experiments carried out at Charlottenburg, by which it was sought to determine the *modus operandi* of fat-splitting in vegetable oils by an emulsion of the castor bean. Hoyer continued the work in 1904 and made an attempt to isolate the enzyme. He used as activators of his enzyme acetic acid and sulphate of manganese.

In 1906 Nicloux, after several years' work on the fat-splitting properties of the castor oil bean, came to the conclusion that the cytoplasm of the seed contains the active agent, and that this substance acts in every way as an enzyme, but is not an enzyme.

It is customary to-day to assume that hydrolysis is preceded by a combination of the hydrolyte with the enzyme—Emil Fischer's lock and key relationship between bodies of asymmetric configuration.

It is known that esters of the lower terms are more difficult to hydrolyse than those of the higher; in other words those esters most readily soluble in water are most difficult of hydrolysis. Is this due to a previous hydrolysis of some portion of the hydrolyte, or to a previous hydrolysis of some portion of the so-called enzyme?

In reviewing the experiments of Nicloux and Hoyer I worked with the castor oil bean acting on its own oil and on cottonseed oil. The results were equally good in the two cases, so that no specificity can be claimed for the enzyme of the castor seed towards its own oil.

I prepared an emulsion of ground castor beans and incubated it at 25° C. until hydrolysis of the oil had been definitely established. A measured quantity of the incubated emulsion was then added to a mixture of measured quantities of oil (castor or cotton, as the case might be) and water. The mixture was shaken for a few minutes at intervals of a quarter of an hour for some hours and then left. The percentage of free fatty acids formed in three days at laboratory temperature ranged from 80 to 85.

On repeating Hoyer's experiments, in which he used acetic acid and manganese sulphate, I did not find that the addition of these bodies produced any increase in the amount of free fatty acids liberated.

I noticed early in the experiments that if hydrolysis (fatty acid liberation) were not properly established in the emulsion (enzyme) the yield of free fatty acids was correspondingly low. Success in the experiment largely depends on the intimate mixture of oil and enzyme. The preparation of the enzyme demands the use of a quantity of water from which the enzyme can later be separated. This water when applied to oil is wholly inactive. Further, the active enzyme, when mixed with two or three volumes of water, alcohol, or acetone, rapidly loses its activity; whereas when mixed with two or three volumes of ether or benzene no loss of activity occurs. On the lock and key hypothesis the meaning of these contrasts is difficult to seek.

Nieloux described his enzyme as refractory to heat when protected by oil; my emulsion, when heated to 60° C., rapidly loses its activity. But when the bean from which the emulsion is prepared is heated to 100° C. for twenty-four hours in a dry bath little or none of its activity is lost.

Pancreatic lipase has been separated into two portions by ordinary filtration, and it has been found that the activity of the filtrate is not diminished by boiling, whereas heating the residue destroys its potential energy. I have not been able to effect any such separation in the castor bean enzyme.

That the activity is related to nitrogen-containing matter can be demonstrated; but whether the nitrogen is active or not it is impossible to say. The total organic nitrogen of my active emulsions, as estimated by Kjeldahl's method, always amounted to at least 0·2 per cent.

Cotton oil and castor oil, when carefully neutralised and freed from proteins fails to undergo hydrolysis. If to this oil an enzymic emulsion, in which hydrolysis of fat has not yet commenced, be added, nothing results. But let hydrolysis be established in the emulsion, and hydrolysis proceeds in the added oil, irrespective of whether this oil be neutral or contain within wide limits (25 per cent.) free fatty acids.

Perhaps the most striking of all these features is the failure of the prolonged heating at 100° C.—a temperature which kills practically all proteins—to interfere with the activities of the bean. Is it that in the case of the dry bean, when heated, hydrolysis fails to commence, whereas in the mixture of enzymes and water hydrolysis rapidly exhausts itself?

A CLINICAL METHOD OF ESTIMATING THE AMOUNT OF CALCIUM IN THE URINE AND OTHER PHYSIOLOGICAL FLUIDS

By W. BLAIR BELL, B.S., M.D. (LOND.), *Assistant Gynaecological Surgeon, Royal Infirmary, Liverpool, etc.*

From the Bio-Chemical Laboratory, University of Liverpool

(Received March 15th, 1912)

INTRODUCTION

To gauge the condition of the general metabolism of the calcium salts, an accurate knowledge of the amount at the disposal of the tissues is necessary, and this knowledge has been difficult to obtain.

For instance, some workers have estimated—chiefly experimentally—the amount of calcium taken in with the food, and have compared this with the amount recovered from the faeces.

This method cannot give reliable results. For although we know the amount taken in by the mouth, we are unable to find out how much of this quantity is absorbed and how much passes through the alimentary canal without being absorbed. Consequently, it is evident that although we may know the amount taken into the alimentary canal and the amount passed out, calculations based on such data must err, because we do not know how much has simply passed through. Recognising this difficulty, in 1907 I published a method of estimating the quantity of ionizable calcium in the blood¹. By this method one is able to determine at any given time the relative amount of ionizable calcium in the blood, and so to get a good indication of the amount at the disposal of the tissues. But as I then, and have since, emphasised, even this method requires careful interpretation. For instance, a low calcium content in the blood may mean either that very little was being absorbed or that too much was being excreted. I devised the method for a specific experimental purpose in regard to menstruation, and it served that purpose; but when it was used for routine clinical work, unless careful consideration were given to the findings, wrong deductions—as I have just pointed out—might be drawn from them.

If, however, the blood estimation method be used in conjunction with a method which will indicate the amount excreted, a perfectly reliable

1. *Brit. Med. Journ.*, April 20, 1907.

knowledge of the condition of the general metabolism in regard to the calcium salts may be obtained.

Since the excretions from the intestinal canal are, as I have just shown, useless for the purpose, we must fall back on the urine, in which it is safe to say that, provided the urogenital apparatus be healthy, the calcium found must represent a true index of the excretory ratio. If the blood index be low, and the amount excreted in the urine also be small, it is fair to assume that not enough calcium is being absorbed. If, on the other hand, the blood index be low and the urinary excretion high, then probably too much is being excreted; and conversely a high blood index and low excretory ratio might indicate that an excessive amount was being retained in the tissues.

PRELIMINARY INVESTIGATIONS

1. The precipitates obtained with oxalic and acetic acid from many specimens of urine were pooled, and on chemical examination were found to consist of pure calcium oxalate. It may be noted here that practically all the calcium present in urine is in an inorganic form, consequently it is precipitated. When the proper measures, to be described directly, are adopted, no phosphates were found in the many precipitates examined.

2. It was found that a rough calculation of the amount of precipitate was not accurate, except in so far as a very large quantity could be distinguished from a small one. Our attention was therefore directed to devising some clinical method of estimating accurately the amount of the precipitate which we had proved to consist of pure oxalate of calcium. Our experiments consisted in centrifuging and measuring the deposit in calibrated tubes.

Our first difficulty was to prevent the deposit sticking to the sides of the tube, and to get it to lie fairly evenly to the calibrated portion. After trying many things, we finally overcame what threatened seriously to interfere with the perfection of our method by adding alcohol or methylated spirit to our urine and reagent.

Next, we found, as we anticipated, that with different rates of revolution of the centrifuge, and with different times spent on the operation we obtained different results; that is to say, urines and solutions containing the same quantity of calcium gave deposits which stood at different levels according to the circumstances mentioned.

However, we eventually got over this difficulty by centrifuging a

standard solution of artificial urine containing a known quantity of calcium in one tube and the urine to be examined in the opposite one. In this way we were able always to get an absolutely accurate relation between the two deposits whatever the rate of revolution or the time employed. So that if the urine showed a deposit of calcium oxalate standing at half the height of the precipitate in the tube containing the standard solution, that urine was found on chemical analysis to contain a quantity of calcium just half in amount of the known quantity in the standard solution. All our results were, of course, verified chemically.

DESCRIPTION OF THE METHOD

A sample from a twenty-four hours' specimen of urine is made faintly acid with hydrochloric acid to dissolve any insoluble phosphate present. It is then made faintly alkaline with ammonia, and filtered. Next 5 c.cm. of the filtrate are placed with a pipette in the special centrifuge tube, which is of the usual size and shape in the upper portion, but tapers at the lower end into a cylindrical extremity of even bore (1.25 mm.) and calibrated into 1 mm. divisions (Fig. 1). A line, with 'urine' marked below it, encircles the upper part of the tube at the 5 c.cm. level. Any air bubbles which may collect in the calibrated portion are got rid of with a fine wire or strand of silkworm gut. Then 1 c.cm. of the reagent, consisting of a saturated solution of oxalic acid in a 5 per cent. solution of acetic acid, is added. The correct quantity of reagent (1 c.cm.) is also indicated by a line round the tube which is marked 'reagent.' Finally 2 c.cm. of alcohol or methylated spirit, as indicated by the line marked 'alcohol,' are added, and the contents of the tube are thoroughly mixed by shaking.

The second tube is then taken, and 5 c.cm. of the standard solution¹ is run into it with a pipette that is up to the line marked 'solution' (Fig. 2), and any air bubbles removed as before. Next the reagent and alcohol are added as in the case of the first tube, and the whole is thoroughly shaken. Both tubes with their calibrated ends packed in wool are then carefully placed in the opposite buckets of a centrifuge, and are centrifuged for about a quarter of an hour. On removing the tubes the precipitate will be found to stand at a certain height, say 10 mm. in the 'standard solution' tube, while it may stand at 7 mm. in the other

1. *Standard Solutions.*—0.05 gram. of calcium phosphate [$\text{Ca}_3(\text{PO}_4)_2$] is dissolved in a little hydrochloric acid. This is made alkaline with ammonia, and finally acid with acetic acid. Finally, 2 grams of urea are added to the solution, and the whole is diluted up to 100 c.cm. with distilled water. Specific gravity = 1015.

which contains the urine to be examined. As a rule, there is a slight slant on the surface of the deposit. This can be obviated by stopping the machine at the end of one or two minutes and turning the tubes through half a circle.

But if this be not done—and it is not absolutely necessary, although it makes for greater accuracy—the height of the *middle* of the meniscus or slant in each tube should be read off and compared. In the above instance the deposit in the tube containing the standard solution was stated to stand at 10 mm., and that in tube containing the urine at 7 mm.,



FIG. 1



FIG. 2

consequently the urine contains 7-10th or 0.7 of the quantity of calcium in the standard solution, which is known to be 0.02 per cent; in other words, the urine contains $0.02 \times 0.7 = 0.014$ per cent. of calcium. This gives a general equation $\frac{U}{S} \times \frac{1}{50} = \text{percentage of calcium in the urine examined}$, in which U = height in millimetres of precipitate in the urine

to be examined, and S = height in millimetres of precipitate in the standard solution.

If any specimen of urine be found to contain an unusually large amount of calcium, so that the precipitate more than fills the calibrated portion of the tube, it should first be diluted with an equal quantity of distilled water, and the final result obtained in regard to the calcium content doubled.

In our experiments to test the accuracy of the method we found that the difference between the percentage of calcium obtained in this way and that obtained by chemical analysis never amounted to more than 1 per cent. of the quantity present.

OBSERVATIONS ON THE SECRETION AND COMPOSITION OF HUMAN BILE

By J. A. MENZIES, M.D. (EDIN.)

*From the Physiological Laboratory, University of Durham College
of Medicine, Newcastle-upon-Tyne.*

(Received March 16th, 1912)

An opportunity having offered for making some observations on the secretion of bile in the human subject in a case of biliary fistula, it has appeared advisable to record the results obtained, though it is recognised that in themselves these observations do not lead to any definite conclusions, and are only of value as confirming, or otherwise, accepted teaching or as offering suggestions for further work.

The patient was a woman, aged 24, who had been operated on in October, 1911, for acute suppurative cholecystitis with gall-stones. The gall-stones and half of the gall bladder were removed. The wound was drained for a time, but had healed five weeks after the operation. It remained healed for two days, then broke down with the formation of a fistula. Jaundice was present before the operation, but after operation, in the opinion of the surgeons, the common bile duct was not completely blocked. The faeces were said to be light coloured. Apart from the fistula the woman's health was good.

The research was undertaken on Professor Bainbridge's suggestion, the primary object being to ascertain the immediate effect, if any, on bile secretion of the administration of protein, carbohydrate, fat or hydrochloric acid. It was, of course, impracticable to introduce these substances into an absolutely empty stomach, and therefore pure results could not be anticipated. Moreover, inasmuch as the common bile duct was presumably patent, though probably constricted, the further difficulty had to be allowed for that the results obtained by the collection of the fistula bile would be unreliable in so far as there was a passage of an unknown quantity of the secretion into the intestine. With a view to minimising this source of error, arrangements were made for the examination of the faeces, but unfortunately owing to a series of misunderstandings the stools were never obtained. The pale colour of the faeces and the probability that the common bile duct was thickened as a result of the original disease make it reasonable to suppose that only a small quantity of bile, if any, found its

way into the intestine. Making full allowance for these difficulties, there are still some points of interest to be found in the results obtained.

The bile was collected by a tube similar to that employed for bladder drainage after suprapubic cystotomy. It was measured at intervals of five, ten or fifteen minutes, but it was found that the results were most instructive if the fifteen-minute interval was adopted throughout, and accordingly in the subjoined charts each second ordinate represents a fifteen-minute interval. The patient was in bed throughout the whole period of observation. The charts show the rate of flow in relation to the diet, each abscissa representing 0.5 cubic centimetre of bile and every second ordinate a quarter-hour period. With each is given the total quantity collected and a note of the nature of the pigment.

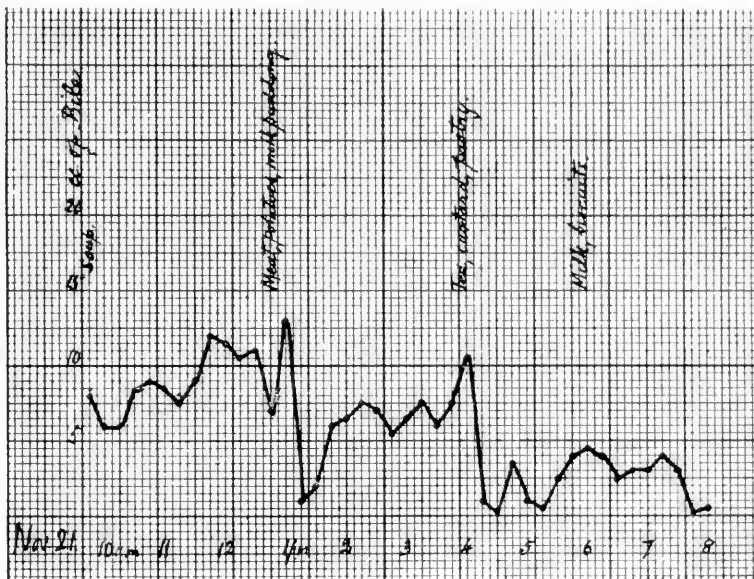

FIG 1. Bile in 11 hours 239 c.c. (8 p.m. to 8 a.m., 22nd, 99 c.c.) Colour, brown. Night bile darker in tint than day bile. In this and the succeeding charts, the abscissae represent 0.5 c.c., and each second ordinate indicates a 15 minute period.

Fig. I shows the rate of flow during one day on ordinary hospital diet. The curve divides itself into three periods, the first of three and a half hours from 9-30 to 1 o'clock, ending in a sharp fall within half an hour after the midday meal; the second of three hours from 1 to 4, ending in a sharp fall immediately after tea; and the third of four hours from 4 to 8, showing a slight fall after supper at 6 o'clock and a final fall at the end of the curve. The average flow for each quarter-hour during the first

period was 8.3 c.c., during the second period 6.5 c.c., and during the third 2.3 c.c. The flow from 8 p.m. to 8 a.m. the next day totalled 99 c.c., or an average for each fifteen minutes of 2 c.c. There are thus two main features of interest in this curve, (1) the progressive fall in the output from morning till evening, and (2) the sudden diminution after the midday and afternoon meals. The suddenness of the fall within at most half an hour of the meal suggests four possibilities, (1) a mechanical interference with the flow by pressure of the distended stomach on the portal fissure, (2) inhibition of the secretion, (3) diversion of the flow to the common bile duct, or (4) removal of a normal stimulus. Mechanical interference is *a priori* improbable, and is made more so by the fact that there was no increase in the flow from the fistula as the stomach contents diminished, but, on the contrary, the rate of flow remained at the lower level. Inhibition either by chemical or nervous means would be contrary to the known facts with regard to other secretions in connection with the digestive system. With regard to the possibility of a diversion of the flow into the duodenum, it is common knowledge that no flow of bile into the intestine occurs normally so soon after food is taken, and the question remains whether this fall has any association with the previous meal. Normally, of course, the gall bladder empties itself a few hours after a meal is taken, and it may be assumed that the contraction of the gall bladder is accompanied by some degree of dilatation of the bile duct. Mr. R. J. Willan informs me that in a case of duodenal fistula in the Royal Victoria Infirmery, Newcastle, a gush of partially digested food mixed with bile escaped with great regularity from three to four hours after each meal. If this is the normal time for the outflow of bile in the human subject, it is obvious that the diminished flow in this case coincides with the normal period for escape of bile into the duodenum in relation to the previous meal, and the occurrence immediately after food may be a pure coincidence. On the other hand, the meal at 9 a.m. was a very light one, consisting of soup; and again on the 22nd November, when the midday meal was given an hour earlier than usual, the diminution of flow also occurred earlier. Professor Bainbridge has suggested the fourth possible explanation which appears to be the most probable, viz., that as a result of the entrance of the meal into the stomach the pyloric orifice is closed for a time, and the normal stimulant for the production of secretion is thus withdrawn, leading to a diminished flow until digestion has proceeded for a time and chyme again begins to pass into the duodenum.

I had no opportunity of repeating this full-day collection, but it is

noteworthy that the quantity of bile collected during the midday hours in the subsequent experiments, with two exceptions to be discussed later, agreed closely with the quantity during the same hours on the normal day. The quantities obtained between the hours of 11 a.m. and 1 p.m. on the seven days were as follows (11.10 to 1.10 on the 28th):—

21st	81 c.c.
22nd	59 c.c.
23rd	18 c.c.
24th	77 c.c.
25th	85 c.c.
26th	75 c.c.
28th	84 c.c.

On the 22nd a solid meal was taken an hour before the usual time, between 11 and 12 instead of between 12 and 1, and the corresponding fall in the rate of flow took place before 1 o'clock. The small quantity obtained on the 23rd will be discussed in relation to the diet. Omitting these abnormal days, it will be seen that the rate of flow at this period of the day is remarkably constant, and gives some support to the possibility that Fig. I represents a normal rate of secretion.

As will be seen from Fig. II, a carbohydrate meal with a negligible amount of protein was given on November 22nd instead of the customary midday meal, and about an hour before the usual time for that meal. It was followed by a diminution in the rate of flow similar to that observed in connection with the ordinary meals on the 22nd, but the curve shows a sharp rise followed by an equally sharp fall two hours after the meal. This rise appears to be due to a sudden gush, possibly from some mechanical cause such as a change of position, and the average rate of flow for two and a quarter hours after food is just under 7 c.c. per quarter-hour.

The absence of protein in this day's food appears to be the only explanation available for two peculiarities which appeared on the following days. On November 23rd the flow was markedly diminished (Fig. III), only 28 c.c. being obtained in six hours, or an average of just over 1 c.c. per quarter-hour. This came mainly in three gushes, two of which followed the administration of cream and soda, but, in the light of the other experiments, were probably independent of this. The third gush occurred just before tea without any perceptible cause.

The second peculiarity which may possibly be due to the carbohydrate diet was that on November 24th, the second day after the non-protein food,

the bile was markedly green in colour. This green colour persisted for three days, till on the night of the 26th the bile showed a preponderance of brown, and on the 28th (no bile was collected on the 27th) the colour was again the normal brown of human bile. Kunkel¹ states that in dogs the sulphur taken in protein is excreted partly in the bile, and that whereas the excretion of protein sulphur in the urine takes place on the same day on which the protein food is taken, the increase in the biliary sulphur does

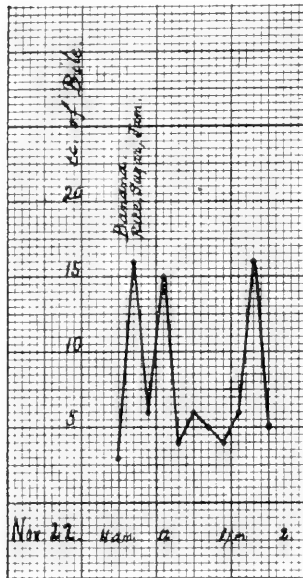

FIG. II. Bile in 27 hours 81 c.c.
Colour, brown.

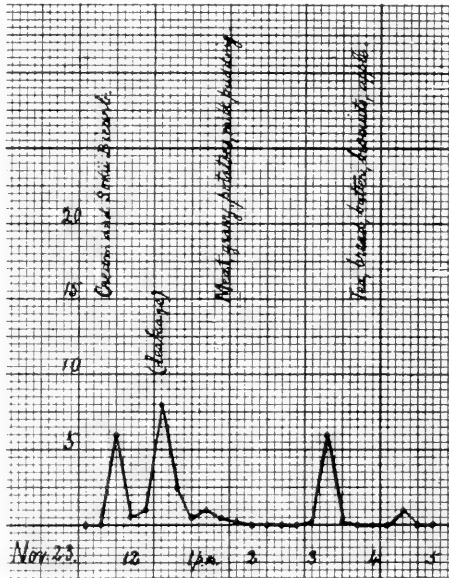

FIG. III. Bile in 6 hours 28 c.c.
Colour, brown.

not appear till two or three days later. In view of that fact, it appears possible that the green colour of the bile, appearing in this case from the second to the fourth day after that on which the carbohydrate food was taken, may be traceable to the nature of the food. This is especially possible when one remembers that the bile of herbivorous animals is habitually green in colour.

Hydrochloric acid (half a pint of 0.2 per cent. solution) was administered with a view to stimulating the production of secretin. As Hertz² has shown that food begins to leave the stomach very shortly after a meal, and as the present observations appear to indicate that no marked constriction

1. Quoted by Noel Paton in Schäfer's *Physiology*.

2. *Brit. Med. Journal*, 1912.

of the pylorus follows the ingestion of fluid, it may be assumed that any increase in the flow of bile will be due to the influence of the acid in stimulating the production of secretin, the fact that secretin does excite the flow of bile having been demonstrated by Bayliss and Starling.¹ The chart shows that such an increase did occur (Fig. IV). The flow averaged over 12 c.c. per fifteen minutes during two and a half hours after the administration of the acid, in spite of the fact that some bile was lost by leakage. A repetition of the experiment on November 28th confirmed this result (Fig. VII), the fifteen-minute average during one and three-quarter hours after the acid was given being 11.4 c.c.

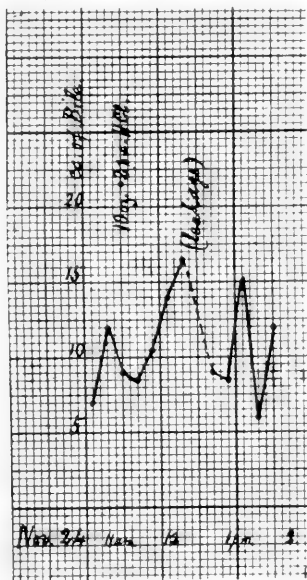

FIG. IV. Bile in 3½ hours 129 c.c.
Colour, markedly green

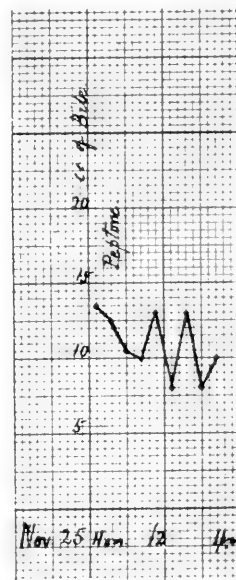

FIG. V. Bile in 2½ hours 98 c.c.
Colour, distinctly green.

Peptone (Fig. V) and bovril (Fig. VI) did not appear to have any marked immediate effect on the flow of bile, the average flow for fifteen minutes during one and three-quarters hours after the administration being 10 c.c. and 9 c.c. respectively, or about the average rate for the period of the day at which these substances were given. It is worthy of note, however, that the amount collected on the 26th and during the night of the 26-27th was above the average (see below), and the question arises whether this increase

1. *Journal of Physiology*, Vol. XXVIII, 1902.

is in any way connected with the increased nitrogenous intake. The peptone was administered on the 25th and the bovril on the 26th, in each case during the forenoon and in addition to the ordinary meals. The increased flow occurring on the day after the addition of the peptone to the diet is in sharp contrast to the great diminution which occurred on the day after a protein-free diet, and supports the suggestion that the remote metabolism of protein food is a factor in bile production.

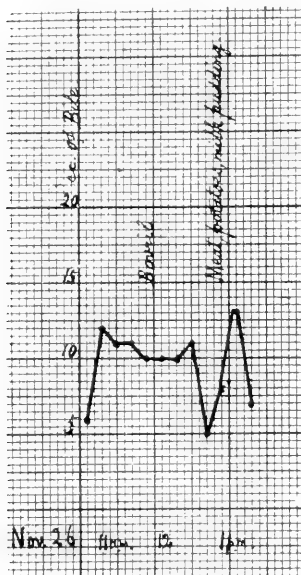

FIG. VI. Bile in 3 hours 114 c.c. (8 p.m. to 8 a.m., 27th, 266 c.c.) Colour—in day bile, green preponderates; in night bile, brown.

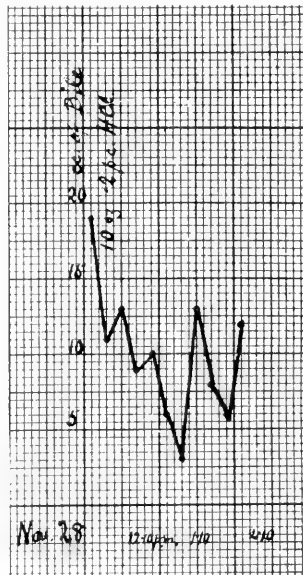

FIG. VII. Bile in 2½ hours 110 c.c. Colour, brown.

TOTAL DAILY QUANTITY

The total quantity obtained on the 21st-22nd in twenty-three hours was 338 c.c., and the quantity for twenty-four hours may therefore be estimated as 350 c.c. This was on ordinary diet. On the 26th-27th 380 c.c. were collected in fifteen hours, giving an estimated total for twenty-four hours of about 600 c.c. This was, as stated above, after an increased nitrogenous intake during the previous two days. Previous observations¹ of the daily quantity of bile secreted in the human subject

1. Quoted in Gamgee's *Physiological Chemistry of the Animal Body*, Vol. II, 1893.

show results varying from 374 c.c. (Yeo and Herroun) to 850 c.c. (Mayo Robson). Ranke obtained 636 c.c., von Wittich 542 c.c., Copeman and Winston 779 c.c., and Paton and Balfour 590 c.c. These figures would indicate that in the case under investigation a very considerable proportion of the daily secretion was obtained through the fistula.

COMPOSITION

Several analyses were made, the charcoal method being chiefly used, but these only confirmed the accepted figures for fistula bile. It was found that the bile secreted by night had virtually the same composition as that obtained during the day. As a rule the night bile had a slightly higher specific gravity, approximating to 1,011 when the day bile was 1,010, and the night bile of the 21st-22nd was distinctly darker in colour than the day bile. The results of analysis were almost identical with those of Jacobsen¹, who found the solids in his case (also fistula bile) amounted to 2·26 per cent. In the present case 9·275 grams of day bile (November 26th) yielded 0·209 gram or 2·253 per cent. of solids. 10·074 grams of the corresponding night bile yielded 0·217 gram or 2·253 per cent. of solids. The ash of the day bile equalled 0·582 per cent. of the total bile, and that of the night bile 0·516 per cent. But whereas Jacobsen found over 1 per cent. of glycocholate of sodium, I found the bile salts always under 0·5 per cent. A typical result is the analysis of the night bile of November 26th-27th:—

Water	97·747
Total solids	2·253
Bile Salts	0·416
Cholesterol	0·094
Lipoids	0·298
Ash	0·516

This leaves 0·929 for mucin and pigments.

REMARKS

The observations recorded in this paper are much diminished in value by the uncertainty as to the condition of the common bile duct and the absence of information as to the quantity of bile which may have found its way into the intestine. They indicate, however, that the composition

1. Quoted in Gamgee's *Physiological Chemistry of the Animal Body*, Vol. II, 1893.

of day and night bile is the same, and they suggest that the effect of food substances on bile secretion may show themselves from the second to the fourth day after ingestion, in agreement with Kunkel's results¹ on sulphur excretion. They further appear to support Starling's statement² that 'As an excretion the production of bile must be continuous, and related, not to the processes of digestion, but to the intensity of the destruction of the red corpuscles.' They raise the question as to whether the more remote metabolism of the ingested food may not have an equal share with the destruction of red corpuscles in determining the amount of secretion, thus throwing doubt on what Moore³ has said, that 'No connection exists between the amount of proteid metabolism and the amount of cholates produced, such as would be found if the cholates were a channel for the excretion of the nitrogen and sulphur of proteid decomposition products.' They accord rather with Spiro's statement⁴ that nitrogen and sulphur are increased in bile by a protein diet, and with that of Rosenberg and Barbera⁵ that in dogs both bile and its solid constituents are increased after protein food.

I have to express my thanks to Professor Rutherford Morison for permission to make these observations on his patient. I am very greatly indebted to Professor Bainbridge who initiated the work and has helped me throughout with his advice. I would also especially thank Mr. R. J. Willan for arranging for the special diet and for organising the collection of the bile and applying the collecting apparatus. Finally, I am indebted to the nurses and dressers who willingly undertook the task of keeping the necessary log.

1. *Loc. cit.*

2. *Recent Advances in the Physiology of Digestion*, 1906.

3. Schäfer's *Physiology*, Vol. I.

4 and 5. Quoted in Schäfer's *Physiology*, Vol. I, by Noel Paton.

NOTES ON SOME NEW SUBSTITUTES FOR THE GALENICAL PREPARATIONS OF DIGITALIS

By DOUGLAS COW, M.D.

From the Pharmacological Laboratory, Cambridge

(Received March 25th, 1912)

The experiments, which form the basis of this paper, were undertaken with the object of comparing the actions of Digalen*, Digipuratum† and Digitalone‡, all recently put on the market as substitutes for Digitalis preparations in therapeutics.

Digalen is an aqueous solution containing 25 per cent. of glycerine: it was first prepared by Cloetta², and is an amorphous powder, soluble in water. Its exact chemical composition appears to be somewhat doubtful. Dixon³ states that it bears a certain chemical and physiological resemblance to Digitoxin; and he points out that it is not identical with the product of Schmiedeberg and Killiani, which is crystalline and insoluble in water. Killiani¹⁰ believes that it consists chiefly of Digitalin. Cloetta states that, whilst it is quite as good a therapeutic agent as Digitoxin, it is less toxic. The latter statement is confirmed by Neave¹⁴, Hale⁷, Hatcher⁸, Symes¹⁶ and Moore¹². There is great variation in the reports on the clinical value of this product.

It has been stated that Digalen is more rapid in its action than the Galenical preparations of Digitalis, though the results of Fränkel⁵, Müller and others show that it is not absorbed any more rapidly than Digitalis. Digalen, whilst it is probably less irritant to the stomach than Digitoxin, appears to be a violent irritant when used subcutaneously, and not devoid of irritant power when injected intramuscularly (Dixon⁴).

Digipuratum is prepared by treating Digitalis leaves with alcohol and ether, the preparation being in the form of a powder, which is insoluble in water, though soluble in dilute alkaline solutions. It is said to contain about 95 per cent. of the active principles of Digitalis leaves, though 85 per cent. of the saponins and inert matter are excluded (Gottlieb)⁶. Schüttler¹⁵ states that Digipuratum is about 50 per cent. less toxic than Digitalis leaves: it is also said to be free from irritant effect on the stomach.

* Digalen, Hoffmann La Roche.

† Digipuratum, Knoll.

‡ Digitalone, Parke Davis & Co.

NOTE.—The tincture of digitalis used as a control was the product of Ferris & Co. physiologically standardised.

Höpfner⁹ reports favourably on its action: Müller¹³ states that gastric disturbance is rarely caused by it, though Szinnyei¹⁷ records nausea and vomiting as following its use.

Digitalone is an alcohol-free solution containing 0·6 per cent. of chloretone, and is said to contain all the active principles of *Digitalis* leaves. It is said to be less irritant than *Digitoxin* or *Digitalin*, though subcutaneous injections are by no means free from pain.

My experiments divide themselves naturally into two parts, the first part consisting of a series of perfusion experiments on the isolated mammalian heart, in an endeavour to ascertain the relative stimulating powers and toxicities of these preparations, whilst the second part is confined to an attempt to establish their relative rates of absorption from the intestinal tract and their irritant properties.

PERFUSION EXPERIMENTS

Equivalent doses of these three preparations were taken, and of these, solutions of 1 in 2,500 were prepared as required in freshly oxygenated Ringer's solution made up with special glass-distilled water. Rabbits of medium size (averaging 1·8 kilograms) were used in all these experiments: these were decerebrated, their hearts immediately excised and perfused by the method of Langendorff, using the apparatus described by Brodie. By this means the hearts were perfused through the coronary vessels, and maintained at a steady temperature of 37° C. A silk thread was attached by an entomological hook to the apex of the heart, and connected with a suitably placed counterbalanced recording lever, the writing point of which recorded the cardiac movements on a revolving drum. The perfusion fluid was placed in two glass jars at a suitable height above the suspended heart, one jar containing Ringer's solution and the other a 1 in 2,500 solution of the drug in Ringer's solution. By means of a Y-tube junction-piece either solution could be made to supply the perfusion fluid at will.

In all, twenty experiments were performed, the results of which may be given under six heads:—

1. Alteration in rate of heart-beat.
2. Alteration in amplitude of heart-beat.
3. Toxicity.
4. Alteration in rate of coronary flow.
5. Alteration in height of mean tonus.
6. Incidental remarks.

1. *Alteration in rate of heart-beat.*

In this particular Digipuratum had by far the strongest action, the average alteration being a slowing of 33 per cent. in 30 minutes. In one experiment the beat was slowed from 90 to 48 per minute, nearly 50 per cent. Between Digalen and Digitalone there was but little difference, both being far less potent than Digipuratum: Digalen produced a slowing of 7.6 per cent. and Digitalone of 6.2 per cent. The greatest degree of slowing produced by these drugs in any experiment was from 81 to 69 per minute by Digalen, and from 96 to 82 by Digitalone. These results are shown graphically in Fig. 1.

FIG. 1. Rate of Heart Beat showing percentage slowing produced.

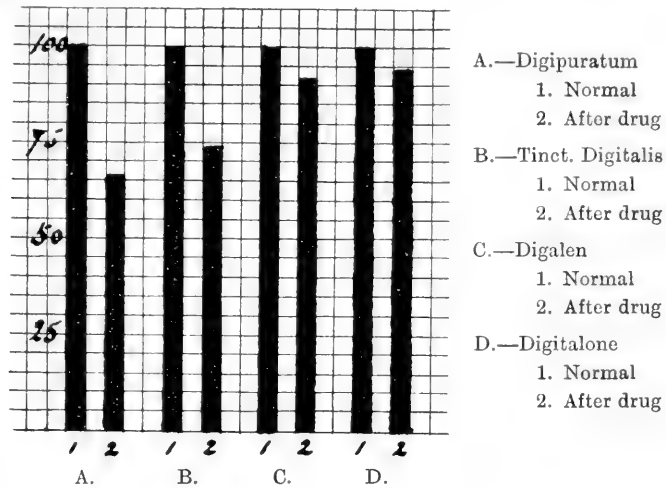

2. *Alteration in amplitude of heart-beat.*

Digipuratum again showed the most powerful action, very closely followed in this case by Digalen; the average figures being an increase of 97 per cent. for Digipuratum, 90.9 per cent. for Digalen and 22.7 per cent. for Digitalone; but, whereas the Digipuratum effect was produced in 10 minutes, that of Digitalone did not reach its maximum under 30 minutes. Digitalone also required 30 minutes for the production of its maximum effect. Corresponding experiments with Tincture of Digitalis showed an increase in amplitude of 88.9 per cent., produced in 30 minutes. It should be stated, however, that the increase in amplitude produced by Digipuratum is not so well maintained as is that produced by Digalen and Digitalone, as shown in Fig. 2.

3. *Toxicity.*

The relative toxicities of these preparations were measured by the times elapsing between the moment at which the drugs were first put into the perfusion fluid, and the time at which the heart finally ceased beating in systole. The average results are as follows:—

Digitalone	260 minutes.
Digalen	235 minutes.
Tincture of Digitalis	165 minutes.
Digipuratum	160 minutes.

Their ratios of toxicity may then be put at: Digitalone 0·63, Digalen 0·70, Tincture of Digitalis 1·00 and Digipuratum 1·03. These results are shown graphically in Fig. 3.

Professor W. E. Dixon very kindly undertook to perform a series of injection experiments on frogs, and by his courtesy I am able to publish the results of these in confirmation of the above toxicity figures. The frogs were injected with varying doses diluted with an equal quantity of saline solution, the injections being made with a fine hypodermic needle into the dorsal lymph-sac.

Briefly stated, these four drugs showed exactly the same order of toxicity as in the perfusion experiments: 2·5 minims of Digipuratum killed a frog of 20 grams in 1½ hours, a frog of the same weight was killed by 2·6 minims of Tincture of Digitalis in 3 hours, whilst 4·5 minims of Digalen were necessary to kill a 20 grams frog in 3 hours, and 5 minims of Digitalone failed to kill a frog of 22 grams in 3 hours.

If we compare the ratios of toxicity given above with similar figures obtained from the results of alteration in amplitude of heart-beat, in each case putting Tincture of Digitalis at 1·00, we obtain the following table:—

					Ratio of increase in amplitude		Ratio of toxicity
Tincture of digitalis	1·00	...	1·00
Digipuratum	1·09	...	1·03
Digalen	1·02	...	0·70
Digitalone	0·25	...	0·63

From these figures it is evident that, taking Tincture of Digitalis as a standard, both Digipuratum and Digalen are pharmacologically relatively more potent than toxic, whilst Digitalone is both less potent, pharmacologically, and also less toxic than the Tincture; but, whereas its toxicity is 37 per cent. less than that of Tincture of Digitalis, its pharmacological activity, as judged by its power of increasing the amplitude of the heart-beat, is as much as 75 per cent. less.

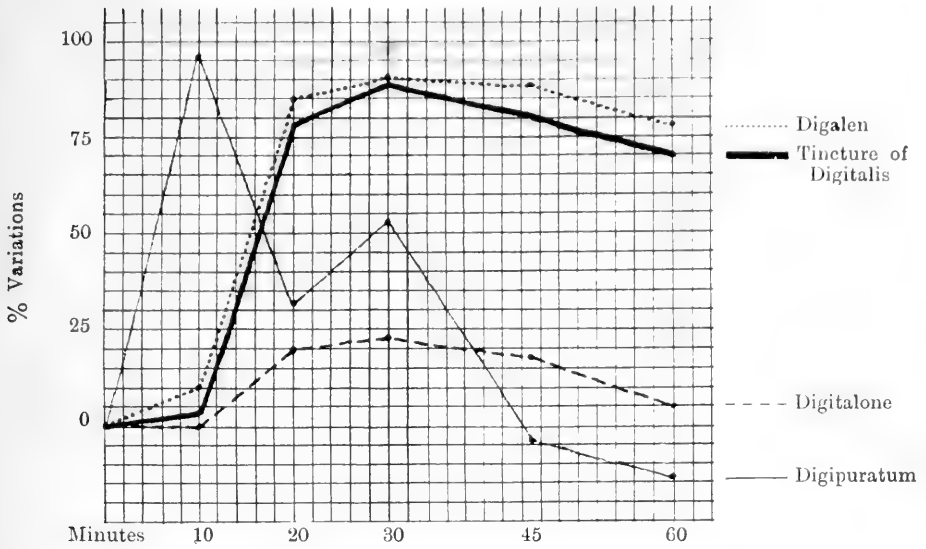
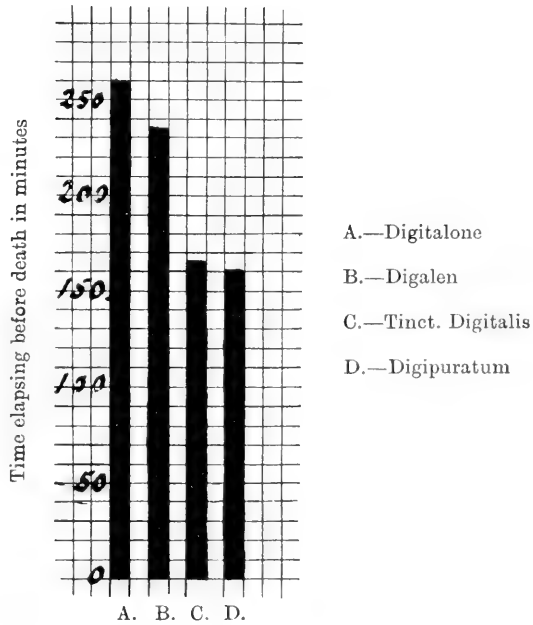

FIG. 2. Variation in Amplitude of Heart Beat.

FIG. 3. Relative Toxicities to the Isolated Heart.



4. *Alteration in Rate of Coronary Flow.*

Digipuratum has a far more powerful action than the other preparations, the rate of coronary flow sinking from 5 c.c. in 60 seconds to 5 c.c. in 201 seconds. Digalen comes next with a fall of from 5 c.c. in 55 seconds to 5 c.c. in 90 seconds. Digitalone produced a fall of from 5 c.c. in 42 seconds to 5 c.c. in 65 seconds. This gives the following table of percentage diminution in rate of coronary flow:—

Digipuratum	233.0 %
Digalen	63.6 %
Digitalone	54.8 %
Tincture of digitalis	40.0 %

The results are shown graphically in Fig. 4. It will be noticed that Digipuratum produces its maximum effect in 10 minutes, whilst that of Digalen is not reached till 45 minutes after the drug was first admitted to the perfusing fluid.

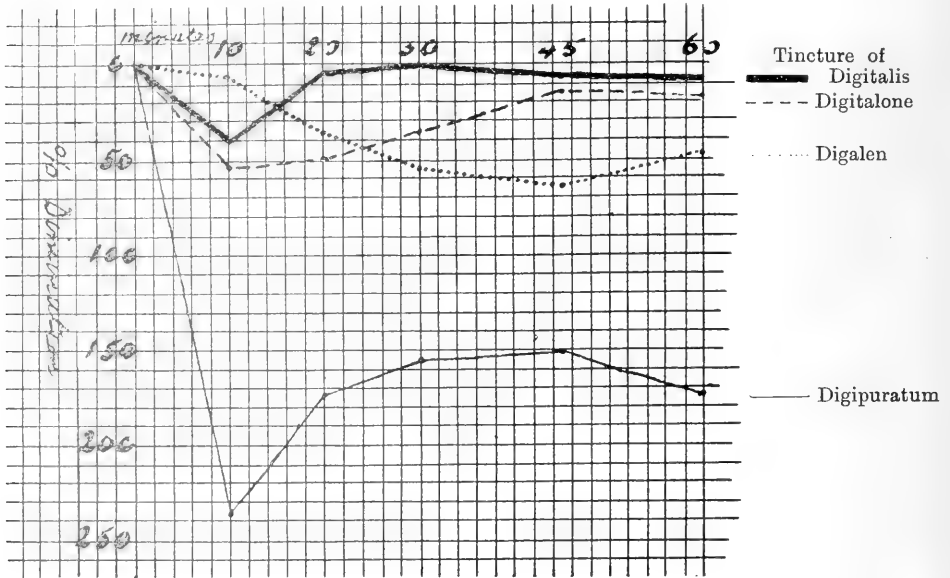

FIG. 4. Variation in Rate of Coronary Flow in the Isolated Heart.

5. *Variation in Height of Mean Tonus.*

These results were obtained by measuring the height of the middle point of the curve above the base-line at certain times. It was found that, starting from an average height of 23 mm., Digalen produced an increase in tonus to 28 mm. in 10 minutes, after which followed a gradual

fall. Digipuratum, from an initial average height of 49 mm. above the base-line, caused a rise to a maximum of 53 mm., 60 minutes after the introduction of the drug. Digitalone and the Tincture of Digitalis produced no increase in mean tonus until the final rise of approaching death in systole. Reducing these results to percentages we can express them graphically, as in Fig. 5.

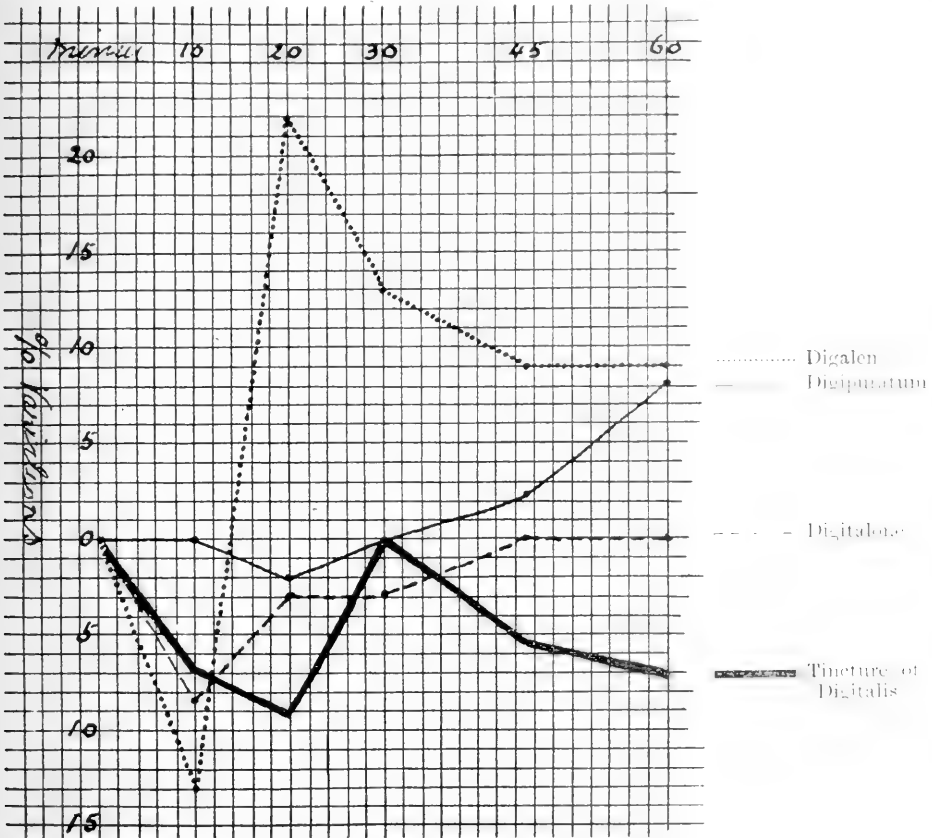

FIG. 5. Variation in Height of Mean Tonus.

Reading these results in conjunction with the results of variation in total amplitude of heart-beat, it is noted that Digipuratum in the first 10 minutes produces an increase of nearly 100 per cent. in amplitude without altering the tonus, so that when the amplitude of the beat is greatest the tonus is unaltered. At the end of an hour after the introduction of this drug, when the total amplitude of the beat is nearly 15 per cent. less than the normal, the mean tonus is nearly 10 per cent.

higher than the initial figure. In the case of Digipuratum the heart has by this time commenced its final rise of tonus towards its approaching death in extreme systole. Digalen, on the other hand, shows two almost parallel curves, in that, 20 minutes after the introduction of the drug, the amplitude of heart-beat has increased by 80 per cent., and the mean tonus has risen 20 per cent. At this time each curve often shows a slight fall.

Thus, in the therapeutic stage, Digipuratum increases the amplitude of the beat without increase of tonus, whilst Digalen produces an increase in tonus coincident with the increase in amplitude of heart-beat.

6. *Incidental Remarks.*

Under this heading I have grouped such occurrences as variation in rhythm, partial heart-block and extra-systole, merely wishing to direct attention thereto, owing to the prominence given to such features of cardiac action by Mackenzie¹¹ and others.

Variation in rhythm was noticed once only, and that in a heart under the influence of Tincture of Digitalis, the change being to a 3 : 1 rhythm, and occurring 105 minutes after the commencement of perfusion with that drug.

Partial heart-block was produced once by Digipuratum, once by Digalen, twice by Digitalone, and not at all in this series of experiments by Tincture of Digitalis. (Fig. 6.)

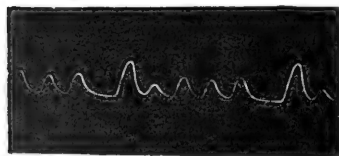

FIG. 6. Shows partial Heart Block produced by Digalen 190 minutes after introduction of drug.

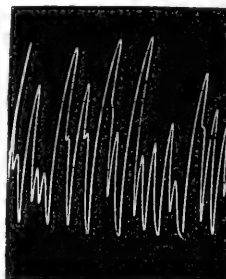

FIG. 7. Shows extra-Systole produced by Digipuratum 30 minutes after introduction of drug.

Extra-systole was noticed but once, Digipuratum being the drug which produced it: it occurred 30 minutes after the introduction of the drug into the perfusion fluid. (Fig. 7.)

Figs. 8, 9, 10, 11 show typical tracings of the action of Digalen, Digipuratum, Digitalone and Tincture of Digitalis, respectively, when perfused through the isolated heart.

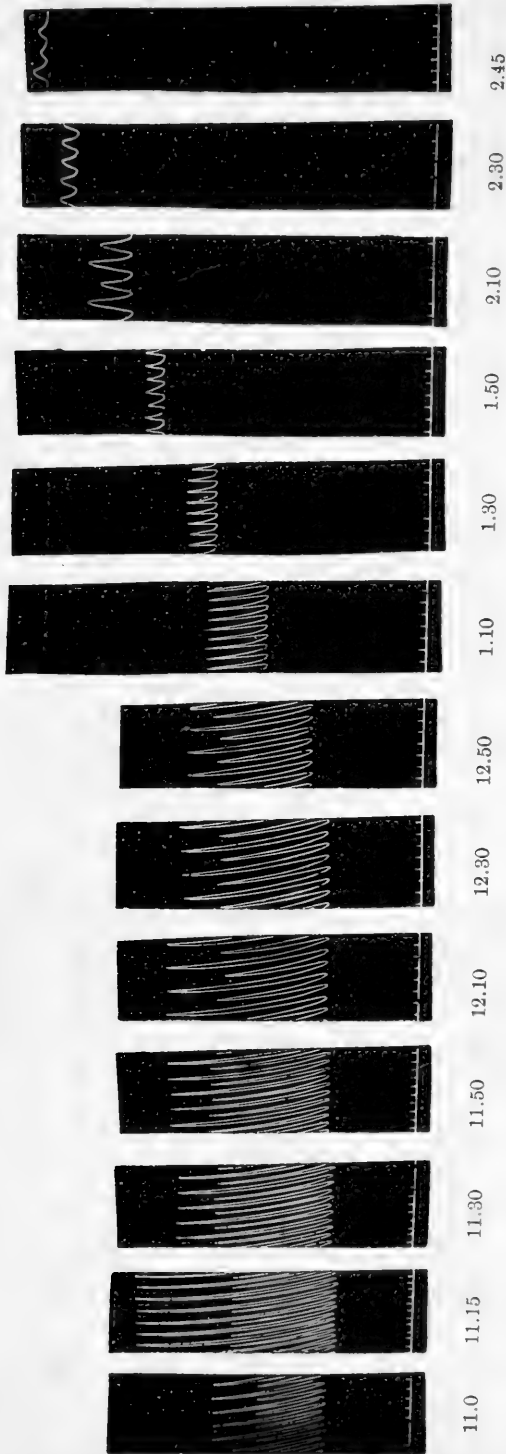

FIG. 8. Rabbit's Heart perfused with Ringer's Solution At 11.0, 1 in 2,500 Digitalis was admitted into the perfusion fluid.
Time in seconds.

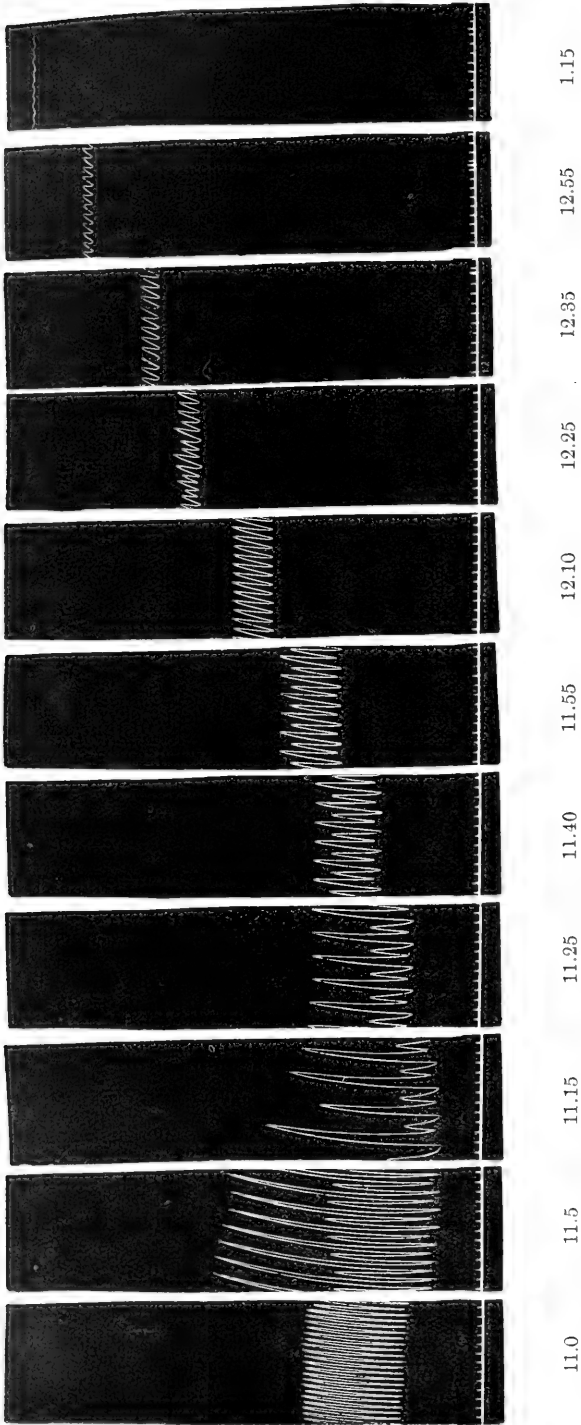

FIG. 9. Rabbit's Heart perfused with Ringer's Solution. At 11.0, 1 in 2,500 Digipuratum was admitted into the perfusion fluid. Time in seconds.

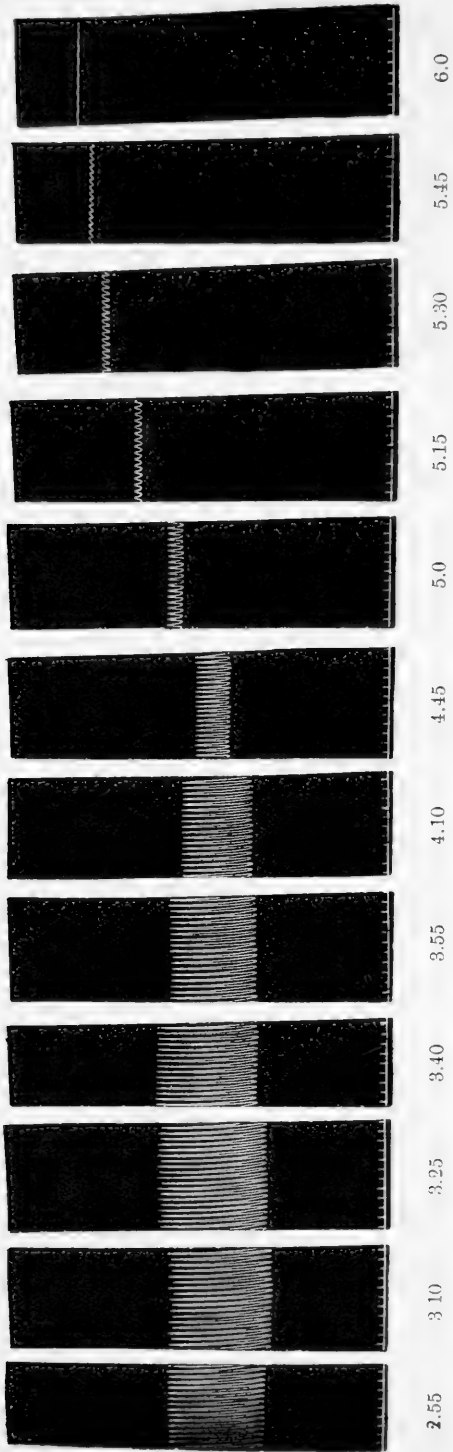

FIG. 10. Rabbit's Heart perfused with Ringer's Solution. At 2.55, 1 in 2,500 Digitalone was admitted into the perfusion fluid.
Time in seconds.

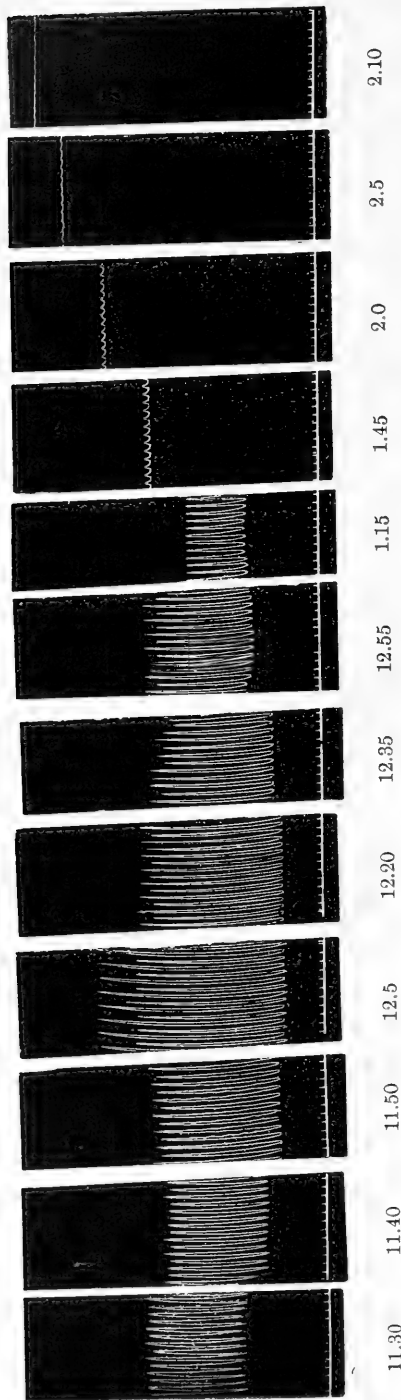

Fig. 11. Rabbit's Heart perfused with Ringer's Solution. At 11.30, 1 in 2,500 Tincture of Digitalis was admitted into the perfusion fluid. Time in seconds.

RATE OF ABSORPTION FROM THE ALIMENTARY CANAL

Cats of medium size were used in these experiments (weighing circa 2 kilo.). They were anaesthetised with ether, followed by urethane intraperitoneally; tracheotomy was performed and a respiration tube tied in the trachea. The animals were then decerebrated, and the carotid artery of one side put into connection with a mercurial manometer. The abdomen was then opened in the middle line, and the duodenum brought forward in readiness to receive the drug. When the blood-pressure had reached a constant level—usually in about 15 minutes—the drug was injected into the lumen of the duodenum by means of a fine hypodermic needle; the bowel was immediately replaced in the abdomen, which was stitched up. Doses equivalent to 16 c.c. of the Tincture of Digitalis were used in all cases, and diluted up to a total volume of 20 c.c.

The average results of these experiments may be given with advantage in tabular form:—

	Digipuratum	Digalen	Digitalone	Tincture of Digitalis
Variation in blood pressure	Slight rise after 70 minutes	Slight rise after 50 minutes	No appreciable rise in 5 hours	No appreciable rise
Condition of heart at end of experiments	Still beating after 6½ hours	Death 2 hours 20 minutes after introduction of drug	Still beating 5 hours after introduction of drug	Death 2½ hours after introduction of drug
Condition of duodenal mucous membrane	Very slight injection	Slight injection	No sign of injection	Considerable inflammation
Evidence of absorption	Yes	Yes	No	Yes

In order to obtain further information as to the irritant properties of these drugs a further experiment was performed: a rabbit, as large as could be obtained, was anaesthetised with ether, followed by urethane intraperitoneally; the abdominal wall was then cleaned of fur by means of a depilatory, and washed. Four skin areas was then mapped out, and a hypodermic injection of one drug was made with due aseptic precautions into each area. Doses equivalent to 1 minim of the Tincture of Digitalis were used. The animal was then wrapped up and kept on a warm stage and examined from time to time.

Little or no change was noticed in the condition of the skin around the areas of injection for more than 4 hours—after which time the following changes were noted:—

				5 hours after injection	6½ hours after injection
Digalen	Distinct redness	Oedema, definite inflammation, hot
Digipuratum	Slight injection	As before
Digitalone	No change	No change
Tincture of digitalis	Discoloration and slight injection	As before

CONCLUSIONS

In comparing these three preparations with the Tincture of Digitalis, Digitalone may be at once discarded as a useful therapeutic agent, since its cardiac action is in every respect inferior to that of the Tincture of Digitalis; and when this drug was administered by way of the alimentary canal no evidence was obtained that it exerted any physiological action on the circulatory system.

Digalen has the advantage over the Tincture of Digitalis that it is less toxic when directly perfused through the heart, though, when it is administered by way of the alimentary canal, this difference is not evident: it increases the amplitude of the heart-beat to about the same extent as the Tincture of Digitalis. It is, however, inferior to the Tincture, in that it does not slow the beat so much; indeed this effect on the vagus is extremely small. The mean tonus of the heart is raised, producing a condition which involves a large expenditure of energy (Barcroft and Dixon¹) it may be of a useless kind. It is conceivable that, in certain conditions such as acute dilatation of the heart, this might be advantageous, but if the mean tonus of the heart is normal it could hardly be other than a harmful effect. Injected subcutaneously, Digalen produces more irritation than any other preparation. Moreover, Digalen has not the merit of cheapness.

Digipuratum is, if anything, more toxic than Tincture of Digitalis, when perfused through the isolated heart; but it has the disadvantage of

very markedly diminishing the rate of coronary flow. It slows the heart rather more than does Tincture of Digitalis: between it and the Tincture there is but little to choose in the matter of increase in amplitude. It acts quite well when administered by the alimentary canal; and is much less irritant than Digalen when injected subcutaneously, though quite as irritant, when given in this way, as the Tincture.

All things considered, it appears that not one of these new preparations has made a successful bid for superiority to the Tincture of Digitalis.

It gives me great pleasure to record my thanks to Professor W. E. Dixon for his continued help and advice.

BIBLIOGRAPHY

1. Barcroft and Dixon, *Journ. of Physiol.*, XXXV, pp. 3, 182, 1907.
2. Cloetta, *Münch. med. Woch.*, LI, p. 1446, 1904.
3. Dixon, *Quart. Journ. of Medicine*, V, pp. 18, 297, 1912.
4. Dixon, *loc. cit.*
5. Fränkel, *Arch. f. Exp. Path. u. Pharm.*, Leipzig, LVII, p. 131, 1907.
6. Gottlieb, *Münch. med. Woch.*, LVIII, p. 10, 1911.
7. Hale, *U.S. Hygien. Lab. Bull.*, p. 74, 1911.
8. Hatcher, *Amer. Journ. Pharm.*, LXXXIII, p. 360, 1910.
9. Höpfner, *Münch. med. Woch.*, LV, p. 1774, 1908.
10. Killiani, *Münch. med. Woch.*, LIV, pp. 886, 1112, 1907.
11. Mackenzie, *Heart*, II, p. 4, Aug., 1911.
12. Moore, *Brit. Med. Journ.*, p. 60, Jan. 13th, 1912.
13. Müller, *Münch. med. Woch.*, LV, p. 2651, 1908.
14. Neave, *Scot. Med. and Surg. Journ.*, Edinb., XX, p. 390, 1907.
15. Schüttler, *Dissertation*, Berlin, 1909.
16. Symes, *Brit. Med. Journ.*, II, p. 1346, 1911.
17. Szinnyei, *Therap. Monatsh.*, XXIV, p. 427, 1910.

THE ANTI-NEURITIC BASES OF VEGETABLE ORIGIN IN
RELATIONSHIP TO BERI-BERI, WITH A METHOD OF
ISOLATION OF TORULIN THE ANTI-NEURITIC BASE
OF YEAST

By E. S. EDIE, W. H. EVANS, B. MOORE, G. C. E. SIMPSON,
AND A. WEBSTER.

*From the laboratories of Bio-Chemistry and Tropical Medicine of the
University of Liverpool*

(Received March 29th, 1912)

In a recent paper from these laboratories an account was given of the chief investigations into the causation of Beri-beri up to 1910; this account was largely an abstract of the masterly monograph in which Schaumann² described the work of other investigators, added much important work of his own, and brought evidence to suggest that other diseases might have a similar etiology to Beri-beri.

Some of our earlier results were briefly mentioned in that paper, and the account of our further researches will be prefaced by a brief summary of some of the numerous papers on this subject which have appeared in the interval.

One of the most interesting papers gives an account of the later researches of Fraser and Stanton³ who have already contributed so largely to the knowledge of this subject.

They demonstrate that the active anti-neuritic substance of rice meal is soluble in water and in alcohol, show that it is stable in acid, unstable in alkaline solution, and that its thermolability varies with varying physical factors. They show that it is not a phytin or a fat, and that it probably is not a protein nor does it contain phosphorus.

They further confirm, however, the fact that the phosphorus content of a rice is an indicator of its safety as an article of diet, and, with a view to the prevention of Beri-beri, recommend administrative measures to prevent the sale in the Malay States of rice with less than 0.4 per cent. phosphorus pentoxide.

Eijkman⁴ recapitulates his earlier work on the subject, and all must regret that he and his colleagues were prevented from continuing their work in Batavia and Java where, in the years 1889 to 1897, they had so far advanced the study of Beri-beri and Polyneuritis on experimental lines,

and had demonstrated that *Beri-beri* could be cured and its occurrence prevented by the use of hand-milled rice.

His further researches to isolate the active substance from rice meal are recorded. Cure of polyneuritis in fowls was effected by two or three doses of extracts from rice meal; less than five grams of extract containing 0.085 per cent. P_2O_5 and 0.012 per cent. N, sufficed to restore to activity birds severely lamed. He strongly opposes Schaumann's theory (1910) that the active substance is a phosphorus-containing compound, though awaiting fuller accounts of his later communications⁵.

Shiga and Kusama⁶ report extensive investigations disproving the bacterial and toxic theories of *Beri-beri*, and confirm much of Eijkman's, and Fraser and Stanton's work.

Kilbourne⁷ shows that the potassium content of rice meal is of almost equal value to the phosphorus content as an indicator of its safety.

Chamberlain and Vedder⁸, following Fraser and Stanton, showed that an extract of rice meal in 70 per cent. alcohol, concentrated at a low temperature till alcohol free, maintains its activity to cure polyneuritis. They further showed that the active substance is able to dialyze through parchment. A daily dose of these extracts, containing 0.16 mg. P_2O_5 and 4.06 mg. Nitrogen, cured, in a few days, fowls severely lamed.

In another contribution⁹ they confirm these results, having kept fowls for 100 days on polished rice and the extract without development of neuritis. They find that the sucrose and ash in the extract are inactive, and so exclude 0.91 of the 1.34 per cent. solids in the extract.

In addition, they find that the active substance is absorbed by bone-black, and are now proceeding to attempt to isolate and analyse it.

Funk¹¹ has isolated from rice meal a crystalline nitrate of an organic base which is extremely active in reviving pigeons with polyneuritis from feeding on polished rice.

The necessary dose contains about 4 mgs. of Nitrogen, corresponding to 0.05 gram. of the nitrate of the base, to which he allots the provisional formula $C_{17}H_{18}O_4N(HNO_3)$.

The crystals were in the form of microscopic needles, melting at 233° C., insoluble in cold water or alcohol, soluble, with difficulty, in hot water. They were free from ash and from chlorine and sulphuric acid.

This is the first record of the isolation and analysis of an active substance, and the method by which it was obtained will be briefly described. One and a half kilograms of rice meal was extracted with four litres of acid alcohol; separation of the filtrate was completed by the hydraulic press; about three and a half litres of extract were obtained, and evaporated in vacuo at 30°, leaving a fat-like residue. This was melted and treated with water,

and filtered while warm. The aqueous part was treated with ether to remove all fatty substances; it cured pigeons in doses corresponding to 20 grams of the original polishings.

The total aqueous extracts from 54 kilos rice meal amounted to 17 litres, which was treated with sulphuric acid and phosphotungstic acid throwing down 900 grams of precipitate. The precipitate was dried, washed with 5 per cent. H_2SO_4 , ground with baryta and shaken three hours with water. The precipitate was filtered off, the filtrate smelt of ammonia and methylamine. The baryta was precipitated with sulphuric acid, and the filtrate neutralised with hydrochloric acid, and evaporated in vacuo at room temperature. The residue was extracted with alcohol, and the alcoholic solution was active in doses = 40 grams of rice polishings. The solution was free from proteins, phosphorus, and carbohydrates.

The alcoholic solution gave a crystalline precipitate with mercuric chloride, which was separated, washed, and recrystallised from water; this consisted mostly of cholin, but some active substance was also present. Active substance was present in both the alcoholic and aqueous filtrates.

Aqueous filtrate. The mercury was removed, and the filtrate evaporated and taken up in alcohol was treated with platinum chloride to remove cholin. After removing the platinum from the filtrate it was treated with phosphotungstic acid, giving a crystalline precipitate which yielded an active substance when freed from phosphotungstate with baryta and carbon dioxide.

Alcoholic filtrate evaporated and dissolved in water: mercury removed by sulphuretted hydrogen; chlorine, &c., were removed by successive treatment with silver sulphate, sulphuretted hydrogen, and baryta. The alkaline solution was precipitated with silver nitrate and baryta, the precipitate decomposed with sulphuretted hydrogen and freed from silver and barium. It proved active, and, after evaporation in vacuo, crystals were with difficulty obtained from alcohol, with the composition, &c., given above.

BIO-CHEMISTRY OF EXTRACTS OF RICE MEAL AND YEAST

Among other points, we find that nearly twice as much of the phosphorus of rice meal goes into solution in water after denaturisation at $120^\circ C$. Of the soluble phosphorus of rice meal nearly five-sixths dialyses: of the soluble phosphorus of denaturised rice meal only two-thirds dialyses. The protective properties of the fractions separated were not tried, as the quantities were insufficient for continued feeding experiments.

More than twice as much of the phosphorus of dried yeast, after denaturisation at $120^\circ C$., appeared as so-called phosphatide phosphorus.

The pentosan content was also investigated, and it was found that:—
100 grams of rice meal yielded 3.93 grams. of phloro-glucide.

100 grams of potato scrapings yielded 0.43 grams. of phloro-glucide.

There appeared to be no pentosan in Chamberlain-Vedder extract of rice meal.

Aqueous and alcoholic extracts of rice meal have a marked reducing power after hydrolysis with dilute acids: the reducing materials were not soluble in alcohol-ether mixture.

Alcoholic (90 per cent.) extract of rice meal was found to be active (as stated by Fraser and Stanton) in protecting birds from the onset of neuritis, and in curing them, but concentration on the water bath rendered the extracts inactive.

The extracts were concentrated under a fan at room temperature to small bulk till all smell of alcohol had disappeared. These extracts preserved some activity (see Chamberlain and Vedder, *loc. cit.*). Four birds, which were very weak and disabled with polyneuritis, were each given the extract from 25 grams of rice meal, daily: in the first week they showed a decided improvement; became more active; three gained 5 per cent., 15 per cent. and 8 per cent. in weight, respectively, in one week (loss previous to treatment, 32 per cent., 30 per cent. and 36 per cent.). The other, though it became more active at first, lost a further 2 per cent. in 7 days, and 14 per cent. in ten days, being then 47 per cent. below its original weight. It died on the 15th day of feeding, having lost a further 7 per cent.

Of the other three birds, two fell in weight (5 per cent. and 2 per cent.) between the 7th and 10th days, the other one gained a further 2 per cent: two fell again in weight, one losing a further 5 per cent., the other falling 5 per cent. more to nearly its weight at the commencement of treatment. The last just maintained its increase. All were now extremely weak again and could scarcely survive more than a day: they were now put on yeast, and rapidly improved; walking and flying well in a few days, and gaining, respectively, 9.6 and 6 per cent. in the week.

Attempts were made to precipitate the active principle from these extracts by the lead acetate method, which will be described in more detail in dealing with yeast.

Neither the normal or basic lead acetate precipitates proved active: the filtrate, however, was active: the precipitate from this by phosphotungstic acid did not, however, prove active.

Funk's method was now tried directly on the original extract of the meal. A strong odour of ammonia and methylamine was noticed in the treatment with baryta. In spite of continued treatment with this extract, however, the birds died in a few days.

We considered that other foodstuffs might give more favourable results, and so, for the present, abandoned the investigation of rice meal.

On account of the resemblance of the active substance in solubility, etc., to some of the peculiar lecithins and bases described by Winterstein in wheat meal, we tried the lead acetate precipitable portions of Katjang beans, but found them inactive. Feeding with fresh brain also failed to preserve birds from death when incapacitated with neuritis.

An attempt to isolate the active substance from Katjang beans proved

unsuccessful; neither the lead acetate filtrate or precipitate proving active. Further experiments will be made.

Natural yeast had been previously found to possess marked preventive and curative properties, and extracts from yeast were next investigated.

INVESTIGATION OF ANTI-NEURITIC POWERS OF EXTRACTS OF YEAST

I.—*Cold Alcohol*. Extract of yeast with 90 per cent. alcohol in the cold takes out the active substances.

The residue had lost its power to cure neuritis.

The extract rapidly revived birds suffering from neuritis, both of the convulsive and lame types. The weights improved markedly under treatment, but occasionally relapsed on continued treatment.

Bird *a2*.—Loss of weight 25 per cent., and marked lameness: 1 c.c. extract (6 grams yeast) given daily. Bird able to walk and fly next day. Improved in weight 5 per cent. in 7 days, but then began to lose again. Lived 4 weeks on this dose of extract, and re-developed lameness slowly on cessation of the extract.

Bird *d5*.—Lameness, loss 32 per cent. Improved 6 per cent. in weight in 3 days; 11 per cent. in 21 days on 1 c.c. extract daily.

Bird *e1*.—Lameness, moribund, loss 23 per cent. Improved 4 per cent. in weight in 3 days; 14 per cent. in 14 days on 1 c.c. extract daily.

Bird *f2*.—33 per cent. loss, severe convulsions. Active in 24 hours. Gained 3 per cent. in 3 days.

The first extracts were made by standing the yeast under alcohol, shaking at intervals. The later extracts were made by passing the alcohol successively over fresh portions of yeast. Finally, the principle of the 'Gegenstrom' was adopted: the alcohol first passing over partly exhausted yeast and then over successive fractions, and finally over fresh yeast. These extracts proved much more potent than the earlier ones.

The alcohol was removed under the fan at room temperature before use.

All extracts were thus made alcohol free before further precipitations or feeding experiments.

II.—*Hot Alcohol*. Hot alcoholic extracts of yeast, or extracts concentrated on the water bath, proved inactive.

III.—*Acetone*. The precipitate thrown down by acetone at 0°C. from cold alcoholic extract proved inactive.

The filtrate after removal of the acetone proved active.

Bird *e3*.—Loss 40 per cent., lameness very marked, moribund. 2 c.c. daily acetone filtrate. Flying and walking well in 24 hours. Gain in weight 14 per cent. in 3 days; 18 per cent. in 10 days. Lived on this extract for 15 days, though losing a little weight in the last 4 days, and was then put on another extract.

IV.—*Platinic Chloride*. Cold alcoholic yeast extract throws down a golden yellow precipitate with platinum chloride.

Precipitate (freed from platinum) dissolved in very dilute hydrochloric acid. Proved inactive.

Filtrate (freed from platinum) seemed largely inactivated.

V.—*Phosphotungstic Acid*. A bulky greyish white precipitate was obtained by treating cold alcoholic yeast extract free from alcohol with phosphotungstic acid. This was separated and allowed to stand with excess of baryta at 57° C., being frequently shaken. The colour changed to bright yellow. On filtering, a bright yellow liquid was obtained, from which the baryta was precipitated with carbon dioxide. Tremethylamine and ammonia are liberated by the baryta.

The filtrate from the phosphotungstic acid was similarly treated.

The active substance is separated in the phosphotungstic precipitate. The filtrate is inactive.

The solution of the phosphotungstic precipitate, prepared as above described, was fed to several birds with neuritis.

The convulsive form of neuritis is rapidly cured by it, but the improvement in lameness is not so marked, and the lameness sometimes progresses in spite of the treatment being continued.

Bird p4.—Loss 17 per cent., severe convulsions, lame. Bird flying in 3 days, but lost 10 per cent. more weight in a week.

Bird o3.—Loss 17 per cent., very severe convulsions. Convulsions cured. Bird became markedly lame, and lost 3 per cent. more weight in 3 days.

Bird o1.—Loss 25 per cent., convulsions, lame. Convulsions cured. Lameness improved in 2 days. Gain 5 per cent. in 3 days.

The solution of the precipitate freed from baryta was concentrated to a syrup under the fan: crystals separated from the syrup. A solution of these crystals was active.

V.—The active filtrate after lead acetate precipitation was similarly treated with phosphotungstic acid: the baryta was added in the solid form (thoroughly ground into the precipitate) to avoid great dilution. A large amount of amine is liberated.

The active substance was precipitated by phosphotungstic acid from the lead acetate filtrate.

Bird o3.—20 per cent. down, very lame. Continuous treatment with extract. Lameness cured in 7 days, but bird still very thin and weak. Gained 3 per cent. in 10 days.

VI.—Benzoylation of lead acetate filtrate.

No satisfactory benzoyl compound isolated.

VII.—Precipitation of lead acetate soluble, phosphotungstic precipitable, fraction.

Active substance was removed by silver nitrate and baryta, but the amount obtained was too small to be tested.

VIII.—*Ammonia* throws down a scanty fine white precipitate from yeast extract: the precipitate dissolves in dilute acid; it is inactive.

The filtrate (neutralised) remains active.

Bird *i2*.—Loss 33 per cent., very lame, severe convulsions; 2 c.c. ammonia filtrate daily. Running about, no convulsions, 24 hours. Quite lively, slightly lame, 48 hours.

IX.—*Lead Acetate* (normal and basic).

Cold alcoholic yeast extract was precipitated with slight excess of normal lead acetate, giving a fine white precipitate.

(i) Normal lead acetate. Precipitate was freed from lead by sulphuretted hydrogen, and from the latter under the fan and concentrated.

The solution of the precipitate proved inactive.

(ii) Normal lead acetate. The filtrate remained active when freed from lead and sulphuretted hydrogen.

This was now treated with basic lead acetate in slight excess.

A yellow precipitate in small amount was obtained.

Basic lead acetate precipitate (freed from lead and sulphuretted hydrogen) inactive.

Basic lead acetate filtrate (freed from lead and sulphuretted hydrogen) active.

X.—*Yeast extract—portion non-precipitable by lead acetates.*

A small portion of the filtrate, after removal of lead and sulphuretted hydrogen, was concentrated in vacuo to a thick syrup.

From this a deposit of fine feathery crystals takes place (also a few other crystals). One decigram of the crystals was separated as well as possible, dissolved in water, and given to a bird lame with neuritis. The bird recovered and was able to walk and fly in forty-eight hours. It lived for a week without further treatment, and then again become lame, and died fourteen days after the one dose.

METHOD OF ISOLATION FINALLY ADOPTED

Twenty pounds of commercial fresh pressed yeast were extracted in the cold with successive quantities of methylated spirits, using in all, about twenty litres of spirit; the yeast was filtered through thick calico, and the alcoholic filtrate was freed from alcohol at room temperature by means of an electric fan. There remained about 7 litres of watery fluid, dark yellow in colour, smelling strongly of beer, and with an intense bitter taste.

This water extract was mixed with sufficient plaster of Paris to make it 'set.' The plaster matrix, after standing overnight, was ground to a fine powder, and extracted in the shaking machine with successive small quantities of methylated spirits made faintly acid with hydrochloric acid. These extracts were freed from alcohol, as before, and the watery fluid obtained, amounting to 3-4 litres, was precipitated with excess of basic lead acetate. The lead precipitate, having previously been found to be inactive, was discarded. The filtrate was freed from lead with sulphuretted hydrogen, and then concentrated to a syrup in vacuo at 38° C. This syrup was treated with absolute alcohol, and the sticky hygroscopic yellow precipitate (creatinin, etc.) was filtered off. The alcoholic filtrate was again freed from alcohol and then precipitated with baryta and silver nitrate. This precipitate was decomposed with sulphuretted hydrogen, filtered, excess of sulphuretted hydrogen removed by the fan, and then taken to dryness in vacuo at 38° C. A small quantity of a brown, sticky, hygroscopic mass was obtained in this way, easily soluble in cold water, and intensely active.

A dose of 0.006 gram administered to a bird with severe convulsions and lameness, improved the convulsions in four hours: the bird was flying strongly in twenty hours, and the lameness disappeared in forty-eight hours. Two further doses of 0.003 gram were given on the third and eighth day; the bird appeared normal, and gained weight on polished rice diet, but died on the 15th day without return of lameness or convulsions. Other results were equally favourable, the dose (3 mgs.) corresponds to 15 grams of yeast.

The substance was further purified by treatment with alcohol: it was insoluble in ether and acetone, and on standing yielded feathery crystals identical with those found in Experiment X.

The ash consisted principally of barium nitrate and a small amount of phosphate.

Pending further investigations into the exact nature of the ash and its relationship to the organic compound, it is assumed to consist entirely of impurity, and the composition of the residue is approximately:—

C =	40.5
H =	8.07
N =	13.32
O =	38.11
	100.00

This corresponds to the formula $C_7H_{17}N_2O_5$ or $C_7H_{16}NO_2(HNO_3)$.

As the action of baryta splits off trimethylamine we may assume further the presence of this group, and write the formula as:—



The substance isolated we propose to call Torulin, and we hope to prepare a larger amount with a view to further investigations into its exact composition and relationships, and also into its physiological action; among other questions to be determined may be mentioned:—

(i) Whether pigeons, etc., can fully maintain their weight and activity on a diet of polished rice with the addition of small doses of Torulin; or whether it will only prevent the onset of convulsions or nervous changes without being able to maintain full nutrition.

(ii) Whether it is active in itself or only serves as an 'activator' for some other substance (cp. Schaumann).

(iii) In what state does it exist in the food stuffs? Has each food stuff a special base of this class, these bases being interchangeable in animal metabolism?

(iv) What is the cause of the convulsive form of polyneuritis? Is it an early neuritis of the labyrinth or of the cerebral or cerebellar cortex? How does Torulin cure it so rapidly?

(v) Why does the phosphorus content of a food stuff serve as an indicator of its richness in antineuritic bases? Was the phosphate in our purified product merely an accidental contamination?

REFERENCES

1. Simpson and Edie, *Annals of Tropical Medicine*, Vol. V, 1911.
2. Schaumann, *Archiv. f. Schiffs- und Tropen- Hygiene*, Vol. XIV, Beiheft 8, 1910.
3. Fraser and Stanton, 'The Etiology of Beri-beri,' *Studies from Institute for Med. Research, Malay States*, No. 12; also *Philippine Journal of Science*, Vol. V, p. 55, 1910.
4. Eijkman, 'Polyneuritis Gallinarum und Beriberi,' *Archiv. f. Schiffs- und Tropen-Hygiene*, Bd. XV, p. 698, 1911.
5. Schaumann, *Transactions of Society of Tropical Medicine*, 1911.
6. Shiga and Kusama, *Archiv. f. Schiffs- und Tropen- Hygiene*, Vol. XV, 1911.
7. Kilbourne, *Philippine Journal of Science*, Vol. V, p. 127, 1910.
8. Chamberlain and Vedder, *Philippine Journal of Science*, Vol. VI, p. 251, 1911.
9. Chamberlain and Vedder, *Philippine Journal of Science*, Vol. VI, p. 395, 1911.
10. Cooper and Funk, *Lancet*, No. 4601, 1911.
11. Funk, *Journal of Physiology*, XLIII, p. 395, 1911.
12. Kutscher, *Zeits. f. physiol. Chem.*, Bd. LI, 1907.

THE CREATIN CONTENT OF MUSCLE IN MALIGNANT DISEASE AND OTHER PATHOLOGICAL CONDITIONS

By R. A. CHISOLM, M.A., D.M., M.R.C.P., *Greville Research Student.*

From the Gordon Pathological Department, Guy's Hospital

(Received April 24th, 1912)

Since Folin¹ in 1904 published his adaptation of Jaffé's picric acid test to the quantitative estimation of creatin and creatinin, much work* has been done on the circumstances which govern the appearance of creatin in the urine; but, so far as I am aware, no figures have yet been published showing the alterations that occur in the amount of creatin in the muscles of man in various conditions as estimated by this method. The present communication shews the results of some work undertaken to fill this gap in our knowledge.

The method adopted was that given by Mellanby², and is as follows:—At the time the body was opened for the post-mortem examination, part of the pectoral muscles, usually about 40 grams, was removed and freed from fat and connective tissue. It was then finely divided with scissors, and ground up in a mortar with 97 per cent. alcohol. After standing for twenty-four hours the alcohol was strained off through muslin, and the residue extracted four times with distilled water, the last drops of the extract being squeezed out in a meat-press. Control experiments showed that all the creatin is extracted by this process. The extracts were then added together and evaporated to dryness on a water bath: the dry residue was then extracted with 75 per cent. alcohol, filtered, and made up to a definite volume, usually 200 c.c. An aliquot part of this was then evaporated to dryness and extracted with a measured amount of distilled water. Finally 20 c.c. of the extract was taken and heated on a water bath for five hours with a 5 c.c. of normal HCl, the volume being kept constant. After cooling, the acid was exactly neutralised with normal KOH solution; and the creatin, which by this process is entirely converted into creatinin, estimated by Folin's method. The figure arrived at expresses the amount of creatinin present, and the creatin figures shewn in the tables are obtained by multiplying the creatinin figures by 1.16 (Folin).

* For references to the literature, see Mendel and Rose. *Journ. of Biol. Chem.*, Vol. X, p. 213, 1911.

Mellanby and others* have shown that creatin alone is present in muscle, to the exclusion of creatinin. In several cases the mixed alcoholic and watery extracts, which had undergone no treatment capable of converting creatin into creatinin, were tested for the presence of the latter body, which was however always absent.

At Guy's the bodies awaiting post-mortem examination are kept in a cold chamber at a temperature of about 40° F. In view of the possibility that during the period of waiting some alteration might be produced in the creatin content of the muscles, control experiments were undertaken with rabbit's muscle. In two cases rabbits were killed with chloroform, and the creatin estimated at once in the shoulder-girdle muscles, thigh muscles, and rectus abdominis (Rabbit A), or erector spinae (Rabbit B) of one side. The rabbit was then wrapped in a cloth and placed in the cold chamber for twenty-four hours. At the end of that time the creatin was estimated in the corresponding muscles of the opposite side of the body. The results are shewn in the following table:—

TABLE I.—Rabbit A, male, 2,500 grams

Creatin as percentage of fresh muscle.

	At once	After 24 hours	Difference
Thigh muscles	0.296	0.279	5.7%
Shoulder girdle	0.306	0.290	5.5%
Rectus abdominis	0.253	0.217	14.2%
Average	0.285	0.262	8.1%

Rabbit B, male, 1,270 grams.

Thigh muscles	0.384	0.349	9.1%
Shoulder girdle	0.305	0.204	33.2%
Erector spinea	0.364	0.352	3.3%
Averages	0.351	0.302	14.0%

The table indicates that a stay of twenty-four hours in the cold room lessens the amount of creatin in the muscles. The number of hours elapsing between death and removal of the muscle from the body has therefore been noted in all cases. Further, there appears to be a difference in the creatin content of muscles from different parts of the same body; in all cases, therefore, the same muscle (the pectoral) has been used.

* The first observers to make this statement were Toppelius and Pommerehne. *Archiv. de Pharm.*, Vol. CCXXXIV, p. 380, 1896. Their work has been confirmed by Wörner, *Zeits. f. Physiol. Chemie*, XXVII, p. 1, 1899, and by Grindley and Woods, *Journ. of Biol. Chem.*, II, p. 309, 1906-7.

The Creatin Content of Normal Muscle

In order to arrive at the creatin content of normal muscle, the cases selected were all young adults who had met with an accident, and were either brought in dead to the hospital or died shortly after admission, and in whom no abnormality, apart from their injuries, could be found. As permission has to be obtained from the coroner in cases of accident before the post-mortem can be made, the time elapsing between death and the post-mortem examination is considerably larger than in any of the other groups of cases. As will be seen, the results are remarkably uniform, but rather lower than those given by Hofmann³ (0·282—0·316 per cent.), who worked with Neubauer's method. This may be partly due to the destruction of creatin caused by the prolonged stay in the cold room, and also in part to the imperfections of the method employed by Hofmann. If we estimate the loss of creatin during the stay in the cold room at 10 per cent., we arrive at 0·300 per cent. as the creatin content of the muscles of a healthy young adult.

TABLE II.—Normal Adults

Sex	Age	Injury	Hours after death	Creatin as percentage of fresh muscle
1. Male	... 27	Multiple fractures	32	0·257
2. Male	... 31	Fractured spine	30	0·290
3. Male	... 27	Ruptured lung and spleen, fractured ribs	39	0·271
4. Male	... 22	Multiple fractures	36	0·280
5. Male	... 35	Fractured ribs	46	0·251
6. Male	... 38	Fractured tibia and fibula	20	0·268
Averages	... 30		34	0·270

THE CREATIN CONTENT IN PATHOLOGICAL CONDITIONS

The pathological conditions may be separated into the following groups:—

1. Cases of carcinoma and sarcoma.
2. Cases of acute disease of short duration.
3. Cases of subacute and chronic disease:—
 - (a) Accompanied by marked loss of weight.
 - (b) Not accompanied by marked loss of weight.

1. *Cases of Carcinoma and Sarcoma*

It has been shown by Mellanby in the paper already quoted that patients suffering from malignant disease frequently excrete creatin in their urine, and Shaffer⁴ has never failed to find it under these conditions. This excretion is specially marked in patients suffering from growths in the liver. Indeed in Mellanby's cases the amount of creatin in the urine in such cases was greater than the amount of creatinin, and the same was true on many occasions of a case of secondary carcinoma of the liver that was under my own observation for some time. The cases of carcinoma and sarcoma have, therefore, been grouped together in Table III.

TABLE III.—Cases of Sarcoma and Carcinoma

Sex	Age	Disease	Hours after death	Creatin as percentage of fresh muscle
1. Female ...	62	Carcinoma of colon and liver	12	0.186
2. Male ...	71	Carcinoma of cheek abscess of lung	28	0.201
3. Female ...	38	Carcinoma of pylorus	25	0.199
4. Female ...	37	Sarcoma of uterus	16	0.232
5. Male ...	67	Carcinoma of stomach	24	0.315
6. Female ...	68	Carcinoma of rectum, deposits in liver and lung	27	0.167
7. Male ...	50	Carcinoma of gall bladder and liver	27	0.212
8. Female ...	58	Carcinoma of pancreas	21	0.228
9. Male ...	65	Carcinoma of hepatic duct, jaundice	3	0.226
10. Male ...	52	Carcinoma of rectum	8	0.210
Averages ...	57		19	0.218

In spite of the fact that the average interval between death and the post-mortem examination is 44 per cent. less than in the normal cases, there is a decrease in the average creatin content of the muscles of 19 per cent., and this decrease is shown by all the ten cases, with the exception of Case 5, where the creatin is for some undiscovered reason abnormally high. It will be noticed that the amount of creatin is lowest of all in Cases 1 and 6, where there were large masses of growth on the liver; in Case 7, where the content of creatin is somewhat larger, the growths on the liver were both smaller and fewer. The appearance of creatin in the urine of patients suffering from malignant disease is apparently due to a larger muscle breakdown, as suggested by Mellanby,*

* In support of this Shaffer's results may be quoted. This observer found the largest amount of creatin in the urine in the case of puerperal involution of the uterus, where muscle breakdown is at its highest.

following Benedict and others;⁵ and this muscle breakdown is most marked in cases of carcinoma of the liver, that is to say, in cases marked clinically by excessive loss of body weight.*

This excessive muscle breakdown may not, however, be the sole cause of the low creatin content of the muscles in this class of case. Mellanby has shewn that there are reasons for supposing that muscle creatin is formed in the liver, and that one of the functions of that organ is to keep the amount of creatin in the muscles up to a certain standard. It is, therefore, quite possible that the low creatin content is not due merely to excess of muscle breakdown, but is also due in part to failure on the part of the liver to make good the usual loss. In both Cases 1 and 6 the amount of liver substance remaining was obviously much less than normal, and it is a point of some interest in this connection that the lowest creatin content in Table V, which consists of cases where no wasting was observed clinically, is found in Case 6, where much of the parenchyma of the liver was replaced by connective tissue: diminished creatin production as well as increased creatin loss may therefore both be factors in the causation of the low creatin content of the muscles in cases of hepatic disease.

2. Cases of Acute Disease of Short Duration

The cases in the following table showed no muscular wasting, and the creatin content is that of the normal adult, and requires no comment.

TABLE IV.—Cases of Acute Disease

	Sex	Age	Disease	Hours after death	Creatin as percentage of fresh muscle
1.	Male	10	Intus-susception. Operation—general peritonitis	11	0.275
2.	Male	65	Acute obstruction by band. Operation	22	0.285
3.	Female	7	Intus-susception. Operation—general peritonitis	19	0.280
4.	Male	59	Appendicitis. Operation—general peritonitis	15	0.328
5.	Male	21	Lateral sinus thrombosis, septicaemia	12	0.215
6.	Male	59	Acute ptomaine poisoning	13	0.240
	Average	37		15	0.270

* A possible factor in the origin of the large amount of creatin found in the urine in cases of carcinoma of the liver is the production of creatin by the new growth itself. That this factor is comparatively unimportant is shown by the fact that in one case the percentage of creatin in a mass of new growth taken from the liver was only 0.014, while in two other cases the amount could not be measured accurately, but was even less than this. Even supposing the growth to weigh 1,000 grams, this only represents 0.14 grams of creatin, while the total creatin excretion per diem in Mellanby's cases averaged 1.18 grams. Cf. Saiki, *J. Biol. Chem.*, p. 23, VII, 1909-10.

3. *Cases of Subacute and Chronic Disease*

(a) Not accompanied by marked loss of body weight.

(b) Accompanied by marked loss of body weight.

TABLE V.—Subacute and Chronic Disease, without marked loss of weight

Sex	Age	Disease	Hours after death	Creatin as percentage of fresh muscle
1. Male ...	48	Chronic interstitial nephritis, pericarditis	48	0.268
2. Male ...	36	Aortic disease	12	0.232
3. Male ...	56	Fibroid lung	14	0.278
4. Male ...	59	Myocardial degeneration	27	0.224
5. Female ...	76	Diabetes	50	0.257
6. Female ...	58	Gall stones, cirrhosis	9	0.202
Averages ...	55		27	0.244

TABLE VI.—Subacute and Chronic Disease, with marked loss of weight

Sex	Age	Disease	Hours after death	Creatin as percentage of fresh muscle
1. Male ...	10	Appendicitis, subdiaphragmatic abscess	6	0.259
2. Female ...	13	Phthisis	9	0.184
3. Female ...	17	Infective endocarditis, pericarditis	20	0.184
4. Male ...	31	Laceration of liver and kidney, general peritonitis	22	0.219
5. Female ...	15	Chronic peritonitis, intestinal obstruction	17	0.203
6. Male ...	32	Phthisis	10	0.266
7. Male ...	9	Adherent pericardium	23	0.147
8. Male ...	58	Hodgkins' disease, a few nodules in liver	24	0.260
Averages ...	23		16	0.215

The cases in Table V showed no obvious signs of loss of weight during life, and no mention is made of loss of weight in the reports. The statement, however, rests usually on the patient's own impression, and in no case were the actual weights given. There may, therefore, easily have been some slight unnoticed loss, which would account for the fact that the creatin content is somewhat below the normal for healthy adults. All the cases in Table VI were accompanied by loss of flesh so marked as to attract the patient's own attention, and here the average creatin content is the same as that found in cases of malignant disease.

SUMMARY

1. The average creatin content of the muscles of a healthy adult is 0.300 per cent. of the fresh weight.

2. The creatin content is reduced in cases of malignant disease, especially in cases of growth in the liver, and there is reason to suppose that in these latter cases the low content is due to diminished production as well as to increased loss.

3. The content is not reduced in cases of rapidly fatal acute disease, but is lowered in cases of subacute and chronic disease, where there has been marked loss of body weight.

REFERENCES

1. Folin, *Zeitschrift f. Physiol. Chemie*, XLI, p. 223, 1904.
2. E. Mellanby, *Journ. of Physiol.*, XXXVI, p. 447, 1908.
3. Hofmann (quoted by Voit), *Zeitschrift f. Biologie*, IV, p. 82, 1868.
4. Shaffer, *American Journ. of Physiol.*, XXIII, p. 1, 1908.
5. Benedict, *Carnegie Institute of Washington*, Publication No. 77, 1907.
Benedict and Myers, *Amer. Journ. of Physiol.*, Vol. XVIII, p. 406, 1907.

ON THE NATURE OF ANIMAL LACTASE

By MARJORY STEPHENSON.

*From the Bio-Chemical Laboratory, Institute of Physiology, University College, London**(Received May 15th, 1912)*

The rate of hydrolysis of disaccharides by enzymes has been found to be considerably influenced by the presence of the products of hydrolysis. The cases of invertase and emulsin by Tammann in 1892,¹ maltase by Croft Hill² in 1898, and lactase by Armstrong³ in 1904. V. Henri,⁴ in 1901, showed that the retarding effect on invertase was mainly due to the fructose, an observation which was confirmed in 1902 by Adrian Brown,⁵ who proved that it was not due to the increased viscosity of the solution. E. F. Armstrong found that the lactase present in Kefir grains was retarded in its action by galactose, but that the lactase present in emulsin was retarded by glucose. He thus showed the existence of two kinds of lactase—a galacto-lactase, inhibited only by galactose and a gluco-lactase inhibited only by glucose. As no data as to the nature of animal lactase at present exist, it was of some interest to ascertain whether the lactase in the intestines of animals was of the type present in Kefir grains or of the type present in emulsin.

The procedure for examining for the existence of animal lactase which was adopted in these experiments was essentially the same as that of Plimmer.⁶ The enzyme solution was prepared by extracting the ground-up mucous membrane of the intestine of the dog for forty-eight hours with water containing toluene as antiseptic, and then filtering through cambric.

A definite volume of this extract was mixed with an equal volume of (a) 5 per cent. lactose solution, (b) 5 per cent. lactose solution to which glucose or fructose, in varying concentrations were added, to both mixtures 5 per cent. toluene was then added as antiseptic.* Samples of 50 c.c. were withdrawn immediately after mixing; the remainder was kept at 37° C.; and at intervals of one to four days, so as to give ample time for the enzyme to act, further samples of 50 c.c. were withdrawn. Each sample was treated with 5 c.c. mercuric nitrate solution to

* In all the experiments the same volume of extract was added to 5 per cent. solutions of glucose and galactose, to ascertain if there were any disappearance of reducing carbohydrate. No disappearance was obtained in any of the experiments here recorded.

precipitate protein; 30 c.c. of the filtrate from this precipitate were treated with 2 c.c. of caustic soda; after again filtering 20 c.c. of the solution were treated with hydrogen sulphide, excess of the gas was removed with copper sulphate, and the filtrate and washings from the sulphides made up to 100 c.c.

The reducing carbohydrate was then estimated by Bertrand's method, instead of gravimetrically. This method is as accurate as the gravimetric method and more rapid; the precipitate of cuprous oxide is filtered off, dissolved in acid ferric sulphate solution, and the ferrous salt titrated with permanganate. A solution of glucose was found to contain by the gravimetric method 4.63 per cent., by Bertrand's method 4.67 per cent.

The reducing power of completely hydrolysed lactose calculated from Bertrand's table is raised from 6.7 to 10. These figures were verified.

Lactose Solution	Hydrolysed Lactose Solution	
7.9 c.c. KMnO_4	11.8 c.c. KMnO_4	$\frac{7.9}{11.8} = 0.670$

With the concentration of lactose employed in these experiments, complete hydrolysis corresponds to a difference of 2.8 c.c. of permanganate. Differences in the titration of two solutions are generally less than 0.2 c.c.; a difference of 0.3 c.c. for experimental error has been allowed for. This is equivalent to 10 per cent. hydrolysis. Less than 10 per cent. hydrolysis of the lactose is therefore neglected in the results. The following data have been obtained; for comparison a similar experiment was made with the lactase in emulsin.

Experiment I.

ANIMAL LACTASE

Concentration of carbohydrate solution	Time of action of enzyme	No. of c.c. KMnO_4 for 10 c.c. of sugar solution	Difference in c.c. of KMnO_4	Percentage of hydrolysis	
2.5 per cent. lactose	0	5.6 5.8	5.7	0	0
	36 hours	6.9 7.0	6.9	1.2	43
	4 days	7.5 7.5	7.5	1.8	64
	0	15.0 15.0	15.0	0	0
2.5 per cent. glucose +	36 hours	15.2 15.0	15.1	0.1	0
	4 days	15.2 15.0	15.1	0.1	0

Concentration of carbohydrate solution	Time of action of enzyme	No. of c.c. KMnO ₄ for 10 c.c. of sugar solution	Difference in c.c. of KMnO ₄	Percentage of hydrolysis
2.5 per cent. lactose	0	13.2	0	0
+		13.4		
2.5 per cent. galactose	36 hours	14.5	1.1	39
		14.4		
	4 days	15.2	1.8	71
		15.1		

Experiment II.

ANIMAL LACTASE

2.5 per cent. lactose	0	5.9	5.9	0	0
		5.9			
	26 hours	7.7	7.7	1.8	62
		7.7			
	96 hours	8.9	8.9	3.0	84
		8.9			
2.5 per cent. lactose	0	14.2	14.4	0	0
+		14.6			
2.5 per cent. glucose	26 hours	15.2	15.05	0.65	22
		14.9			
	96 hours	16.9	16.85	2.45	84
		16.8			
2.5 per cent. lactose	0	10.3	10.35	0	0
+		10.4			
1.25 per cent. glucose	26 hours	11.5	11.5	1.15	40
		11.45			
	96 hours	12.6	12.55	2.2	76
		12.5			
2.5 per cent. lactose	0	13.8	13.75	0	0
+		13.7			
2.5 per cent. galactose	26 hours	15.7	15.65	1.9	65
		15.6			
	96 hours	16.2	16.2	2.45	84
		16.2			

Experiment III.

ANIMAL LACTASE

2.5 per cent. lactose	0	6.1	6.05	0	0
		6.0			
	89 hours	8.5	8.5	2.45	84
		8.5			
	168 hours	8.7	8.6	2.55	88
		8.5			
2.5 per cent. lactose	0	15.0	15.1	0	0
+		15.2			
2.5 per cent. glucose	89 hours	16.0	15.8	0.7	24
		15.6			
	168 hours	16.8	16.8	1.7	58
		16.8			

Concentration of carbohydrate solution	Time of action of enzyme	No. of c.c. KMnO ₄ for 10 c.c. of sugar solution	Difference in c.c. of KMnO ₄	Percentage of hydrolysis
2.5 per cent. lactose	0	10.5	10.45	0
+ 1.25 per cent. glucose	89 hours	10.4		
		11.6	11.7	43
		11.8		
2.5 per cent. lactose	0	14.1	13.9	0
+ 2.5 per cent. galactose	89 hours	13.7		
		15.8	15.8	65
	168 hours	15.8		
		16.4	16.3	83
		16.2		

Experiment IV.

EMULSIN

2.5 per cent. lactose	0	5.8	5.7	0	0
	1 day	5.6			
		6.6	6.6	0.9	32
	3 days	6.7			
		7.3	7.3	1.6	57
	11 days	7.3			
		8.3	8.2	2.5	89
		8.2			
2.5 per cent. lactose	0	14.8	14.8	0	0
+ 2.5 per cent. glucose	1 day	14.8			
		14.8	14.9	0.1	0
	3 days	15.0			
		16.2	16.0	1.2	42
	11 days	15.8			
		18.0	17.7	2.9	100
		17.4			
2.5 per cent. lactose	0	14.0	14.0	0	0
+ 2.5 per cent. galactose	1 day	14.0			
		15.0	14.8	0.8	28
	3 days	14.6			
		15.8	15.9	1.9	68
	11 days	16.0			
		17.0	16.9	2.9	100
		16.8			

In all the experiments the inhibition by glucose is very marked, whereas galactose has little or no influence. Animal lactase appears to be extraordinarily sensitive to the presence of glucose: in the first experiment 2.5 per cent. glucose entirely inhibited the action, in the second and third experiments this quantity of glucose reduced the hydrolysis from 62 and 84 per cent. to 22 and 24 per cent. Even smaller amounts of glucose produced inhibition. In the experiment with

emulsin, glucose caused total inhibition at first, but after forty hours hydrolysis occurred. The curve represents the hydrolysis of Experiment 3.

It may be concluded that animal lactase is a gluco-lactase like the lactase in emulsin.

I wish to thank Dr. Plimmer for suggesting these experiments and for assistance in the methods employed.

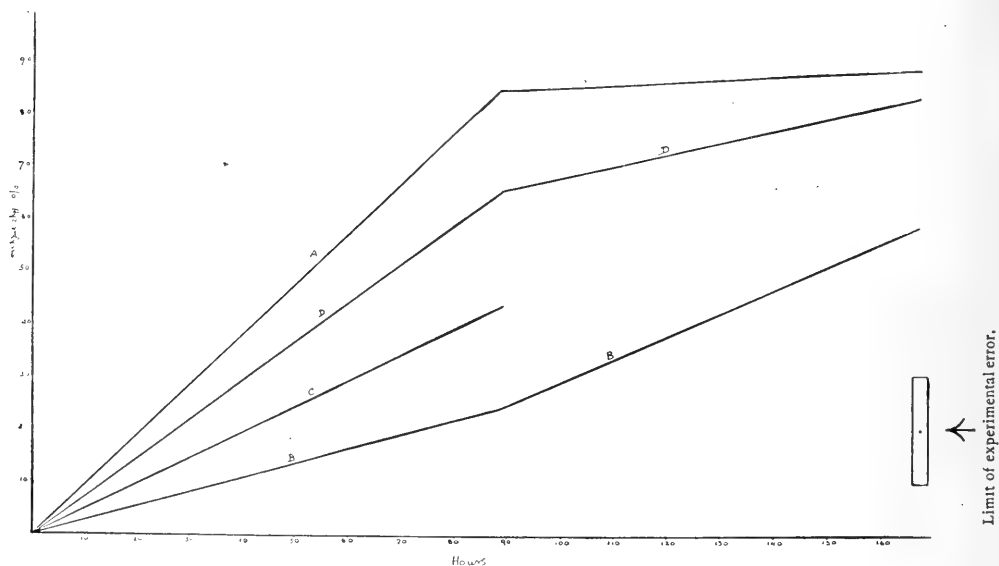

- A. 2.5 per cent. lactose
- B. 2.5 per cent. lactose + 2.5 per cent. glucose.
- C. 2.5 per cent. lactose + 1.25 per cent. glucose.
- D. 2.5 per cent. lactose + 2.5 per cent. galactose.

REFERENCES

1. Tammann, *Zeit. physiol. Chem.*, XVI, p. 271, 1892.
2. Croft Hill, *Trans. Chem. Soc.*, LVII, p. 919, 1898.
3. Armstrong, *Proc. Roy. Soc.*, LXXIII, p. 516, 1904.
4. V. Henri, *Compt. Rend.*, CXXXIII, p. 891, 1901.
5. A. Brown, *Trans. Chem. Soc.*, LXXXI, p. 373, 1902.
6. Plimmer, *J. Physiol.*, XXXIV, p. 93; XXXV, p. 20, 1906.

[PERCY SLADEN TRUST RESEARCH]

THE NUTRITION AND METABOLISM OF MARINE ANIMALS
IN RELATIONSHIP TO (a) DISSOLVED ORGANIC
MATTER AND (b) PARTICULATE ORGANIC MATTER OF
SEA-WATER

By BENJAMIN MOORE, M.A., D.Sc., F.R.S.; EDWARD S. EDIE,
M.A.; EDWARD WHITLEY, M.A.; AND W. J. DAKIN, D.Sc.

*From the Marine Biological Station, Port Erin, Isle of Man, and the
Bio-Chemical Department, The University, Liverpool*

(Received May 15th, 1912)

A fundamental problem in the economics of life in the ocean is that of the manner in which different types of marine organisms take up their food from the sea. There is no question that bacteria in the sea-water are nourished by food taken up in solution. The distribution of such bacteria is not uniform, they flourish in abundance near any decomposing organic matter of either vegetable or animal origin, and, although invariably present everywhere, they occur in much smaller numbers in purer water some distance from shore, where decomposing organic matter in quantity does not exist. Just as in the case of terrestrial bacteria, it is obvious that bacteria in the sea, growing on or near dead matter from plants or animals, throw out secretions which aid in the solution of such organic matter, and increase in this way the amount of their available pabulum in dissolved form. Such dissolved organic matter is carried away in part by the motion of the sea-water, and along with similar organic matter, such as sewage and humus, from rivers and smaller streams, must give a certain amount of dissolved organic matter to the general bulk of the ocean water.

The amount of such organic matter undoubtedly remains balanced or constant, at a certain value, on account of its being broken down into inorganic matter as it is oxidised by bacteria and other agencies.

It is hence a very probable view, *prima facie*, that many forms of protozoa and other minute organisms possessing no special alimentary system, or free movement of their cytoplasm for enveloping and digesting such particulate food as bacteria, algae or minute debris, may exist and grow and maintain an oxidizing metabolism on the dissolved

organic material so added to the sea, either from the land or from the débris and excreta of larger and higher denizens of the sea.

From this point of view it is of the highest importance that our knowledge of the amount of dissolved organic matter in the sea should be enriched by more quantitative determinations than have hitherto been carried out, so that some idea may be obtained of the value of the sea as a nutrient medium apart from the particulate organic matter in living condition and otherwise which it contains.

Such experimentation upon the dissolved organic matter is made still more essential for two reasons: first, there exist at present most marked divergencies in the experimental findings of observers as to the amount of dissolved organic matter in the sea-water, the figures obtained ranging from quantitatively indeterminate traces of less than 1 mgm. per litre to over 90 mgms. per litre; and, secondly, it has been prominently urged by one investigator in recent years that not only bacteria and protozoa, but many classes of higher invertebrates, and even fishes, obtain the greater part of their nutrition from the dissolved organic matter, rather than, as has hitherto been held, from organisms forming the floating life or plankton of the sea, or from other organisms accumulated along the shore, which form their prey.

From the bio-chemical or physiological point of view, it is quite well known that organic matter destined to form an intrinsic part of the body of an animal must, first of all, be broken down into smaller molecules and dissolved. These soluble molecules are then, in the specific metabolism of the particular animal, built up into the definite colloidal molecules or aggregates which exist in the cell substance of that type of animal.

Even in the simplest and most rudimentary type of digestion, such as that shown by an amoeboid protozoon or a leucocyte, the food particle has not become part of the animal when it is engulfed and surrounded by the cytoplasm. It is afterwards gradually dissolved in so far as the digestive cell-fluids can act upon it, and it is the soluble molecules only which are then aggregated and built up in the single-celled organism to give those specific colloidal structures which lie at the basis of the differentiation of species from one another, and yield those delicate differences of chemical structure which, in turn, give the morphological substratum for functional differences.

The same is true for the metazoa, only the special types of cell fabricate the secretions which act upon the colloidal aggregates of the

food and break them down into soluble molecules to form the building stones, for constructing on different lines the new colloidal aggregates necessary for the animal's own cells with their accompanying peculiar functions. Accordingly, all food of protozoa and metazoa alike must pass through a stage of hydrolysis and disintegration and solution, and there is nothing inherently erroneous in the suggestion as a working hypothesis that the dissolved organic matter of water in which aquatic animals are living may play a large or even a predominating part as a food supply.

On the other hand, in all such preliminary considerations of a general theoretical nature, the fact that a large number of species of protozoa possess means of taking up particulate matter such as organic débris, diatoms and bacteria, must not be lost sight of, as also that with the exception of certain parasitic forms, all of the higher metazoa possess a specially developed system of cells with both mechanical and chemical devices (e.g., intestinal canal and digestive glands) for taking up solid food and rendering it soluble afterwards. In addition, as the scale of life is ascended, there arise special systems for absorption of the material prepared for the nutrition by the solvent action of the digestive secretions, and other systems again for the intermediate metabolism which renders the absorbed material suitable by specialized chemical syntheses for entry into the circulating nutrient fluid which bathes or irrigates the living cells.

This process has proceeded so far in the case of most terrestrial animals that there remains no possibility of their nutrition in any other way than by organic matter taken in by the alimentary canal and passed through the processes outlined above. A great part of the existence of such animals consists either in the pursuit of nutriment or in its ingestion and assimilation, and it is a general law, even up to and including the human species, that the distribution and migration of life follows the distribution in comparative abundance or scarcity of food.

Now, in nearly all the aquatic invertebrata and in the fishes, similar developments for the capture and elaboration of particulate food are to be found, and the same variations in distribution in relationship to abundance or scarcity of other plant and animal life occur, as also the same migrations of motile animals after food. Therefore a purposeful relationship of these factors becomes obvious, and it would appear probable that with the more extensive development of organs designed for the capture, digestion and metabolism of solid food, the direct

absorption of soluble organic food in unchanged condition by organs evidently intended for other physiological purposes, such as the gills of molluscs or fishes, would lessen in degree and become comparatively unimportant as a source of energy, if, indeed, such an intake persisted at all.

Organs specially developed for the performance of such an important function as the intake of nutrition, it can safely be said, would never have evolved to such a high degree of perfection and elaboration if they were only used occasionally as a luxury or an accessory to a main mode of nutrition, in which the food was ready prepared and soluble, and capable of entering the main stream of nutrition at once without injury to the animal. If an abundance of dissolved nutrient matter already existed in the sea, the saving in work by direct utilization of this supply of energy would be so great that digestive and metabolic organs would not develop, and if already developed would atrophy from disuse.

Dissolved organic matter means practically no struggle for existence, and no reason for the development of many organs, such as the sense organs, which have developed in connection with such a struggle.

This is clearly seen in the case of many parasites such as the cestodes, which utilize dissolved nutriment from their hosts.

If the sea-water were a nutrient medium of so considerable concentration in dissolved organic matter as to play any important part in the nutrition of such an animal as a fish, it must not be forgotten that the sea would undoubtedly be swarming with creatures so designed as to be capable of flourishing without solid aliment, and, in addition, there would be a host of other creatures making their prey of these. Life in the ocean away from land would be far more abundant than it is at present. If the sea-water, for example, contained 90 mgms. per litre of organic matter of a type suitable for supporting life, instead of being, as at present, comparatively free from bacteria and containing only 0·83 mgm. per 1,000 litres,¹ it would be a most excellent culture medium, swarming with bacteria and infusoria like the stagnant pools containing decomposing sea-weed found at higher levels along the shore.

Finally, it may be pointed out that as the size of an organism

1. This is the moist weight of bacteria found by Lohmann working at Syracuse in the Mediterranean, as computed by Pütter (*Zeitsch. f. allgem. Physiol.*, Bd. VII, p. 290, 1908) in so large a quantity as 1,000 litres of sea-water. In the 1,000 litres there were only by volume 53·63 cubic millimetres of Plankton made up as follows:—Protophytes No. 2,082,850, vol. 17 c.mm.; Protozoa 325,510, vol. 1·13 c.mm.; Metazoa 17,325, vol. 34·7 c.mm.; Bacteria 785,000,000, vol. 0·80 c.mm. Allowing a specific gravity of 1,080 this gives a total moist weight of Plankton of 55·6 milligrams.

increases, the surface decreases relatively to the weight, and hence a concentration of dissolved organic matter which would be ample for the support of a bacterium or protozoan, would be altogether useless for the support of a fish. When solid organic food is swallowed and digested by a fish, it is taken up in higher concentration from the intestinal tract, and a smaller area of absorptive tract is capable of carrying on the work. But if such a creature were compelled to derive its nutrition from a solution of only one or two parts in a million, the necessary uptake could only be obtained by providing a large surface, such as the lung of an animal, or the green leaf of a plant, or a fish gill, over which the water was very rapidly moved. No such mechanism designed for absorption of soluble food and connected up with a metabolic gland, such as a liver, has ever developed.

The gill of the fish has been supposed by Pütter to carry on such a function in addition to its more obvious function of respiration, but all experimental proof of this supposed function of the gill is lacking. The gill epithelium is not such as to warrant any belief that it can modify any organic matter possibly absorbed, and there is no provision anywhere for a metabolic change of any material absorbed by the gill before it is thrown into the general circulation and carried as nutriment to the tissue cells. All analogy teaches us that promiscuous organic matters so absorbed, and distributed without appropriate intermediate changes, instead of acting as nutriment would produce the effects of a violent poison. The products of digestion removed from the intestine and injected into the blood stream, so that they may reach the tissue cells without passing through the liver, act in man as exceedingly toxic agents and cause death when administered in this way, even in small quantities.

Again, for an adequate uptake of dissolved matter from a very dilute solution, it becomes necessary to have some substance in the circulating fluid with a specific affinity for it. The haemocyanin of crustacean blood and the haemoglobin of fishes is an example of such a body, related to uptake of oxygen in dissolved form by the gills. Yet sea-water contains 8 mgms. of oxygen in solution per litre, it is hence exceedingly difficult to believe that, without any such chemical absorbent, the blood of a fish in process of circulation through the gill could take up anything approaching the amount required for a nutritional balance. Especially is this the case in view of the low limit of organic matter shown by the present experiments as the maximum which can possibly be present in sea-water.

The figures which have been obtained in the present research for the rate of oxidation of organic matter by the species experimented upon, taken in relationship with the low values for dissolved organic matter, demonstrates clearly that the views put forward by Pütter,¹ that marine animals obtain a large amount of their food in soluble form from the sea-water must be regarded as erroneous.

On the other hand, from our own observations, as well as from a consideration of the results of plankton studies of other observers, it becomes evident that many marine animals could not possibly maintain themselves in nutritive equilibrium by any process of consuming plankton as uniformly distributed in the sea without some special local concentration, for the organic material contained in the plankton is also far too small for such a purpose. On the basis of the higher animal acting even as a complete filter to the quantity of water passing through its body, the volumes of water which must necessarily be filtered to yield the daily quota of food are far too large to be credible. There is no mechanism in most species at all comparable to a Chamberland filter for such purposes, since this filter refuses passage even to bacteria, but we find that the combined amounts of particulate organic matter held back by (a) a fine silk netting of 20 gauge, which is the finest used for tow-netting, and (b) that afterwards retained by the Chamberland filter amount together to not more than 1 mgm. per litre, that is to say, to one part in one million of organic matter oxidizable by potassium permanganate. If a calculation is made of the volume of water necessary, as shown in Section B of this paper, to yield the amounts of organic matter experimentally shown to be utilized by those animals with an active metabolism, it becomes at once obvious that the uniformly distributed plankton in this sense cannot play any considerable part in the nutrition of such animals.

It is only in the case of fixed animals with a slow metabolism, such as sponges and ascidians, that the demand for organic nutrition can be satisfied by the minute forms present in plankton by such a reasonable volume as may be supposed to be passed through the animals. (See Section B, p. 281.)

To this extent, therefore, we confirm the view of Pütter, but we disagree with him in that we do not find an available source of supply of adequate value in the soluble organic matter, and believe his results are

1. Die Ernährung der Wassertiere, *Zeitsch. f. allg. Physiol.*, Bd. VII, S. 283-320; Der Stoffhaushalt des Meeres. *Ibid.* S. 321-368; Studien z. vergleichenden Physiologie des Stoffwechsels, *Abhand. d. kgl. Gesellsch. d. Wissensch. zu Göttingen, Math.-Physiol. Klasse, Neue Folge*, Bd. VI, S. 1-79.

due to lack of appreciation of the defects of the ordinary methods of analysis of fresh water when applied to sea-water.

All the wealth of argument so ably applied by Pütter to prove that the organic energy supply of the plankton is inadequate for the support of life, applies with equal force to the dissolved organic matter, for neither source yields more than one part per million.

But if the plankton figures, on the basis of uniform distribution, fail to furnish an explanation, and the organic matter in solution also is inadequate, what, it may be asked, is the food-supply? In our opinion the answer lies in the unequal distribution of the plankton, similar in nature and cause to the unequal distribution in space of the higher marine animals and of nearly all terrestrial animals.

The terrestrial animals have to seek their food, and, as a rule, congregate in flocks or herds for that purpose where food is most abundant and follow the food. Other purposes of a biological nature are also served and fostered by the communities so formed for the primal necessity of obtaining food. Fish in the sea live together in shoals for the same reason, and anyone who has walked along a sea-cliff in summer must have been struck by the fact that birds, such as sea-gulls, follow the movements of the young fish, and do not spread themselves uniformly over the sea-surface regardless of the concentration of the food.

Where there is a good supply of pasturage and water, under natural conditions there will be a greater wealth of herbivorous animals, and where these are found in abundance there will be more of the carnivorous animals which prey upon them. Thus some factor in the environment of a permanent physical nature in soil or water, or of seasonal variation, such as light or heat or moisture, produces abundance or scarcity of one species of animal or plant, and this precipitates a whole train of events, the causal relationship of which can only be unravelled by patient study and experimentation.

There is no prevalence of monotony and uniformity in Nature, all is cyclical and undergoing constant variation, and so also there exists no uniform distribution of plankton in the sea.

The postulate of a uniform distribution of plankton would appear to be assumed by many workers on the floating life of the sea and its variations in season and in space. This postulate is taken as a basis by Pütter when he deduces the inefficiency of the plankton as a food-supply. It underlies all his arguments that the fish, or large invertebrate, is engaged all the time in exhausting a certain volume of water either

(a) of plankton on the views of the orthodox school of plankton workers, or (b) of dissolved organic matter on his own views.

This is the fundamentally wrong conception in the whole argument, because it leaves out of account anything in the nature of a taxis towards the food in the lower species or of what we term instinct in the higher species, and in the case of non-motile organisms any selective action of the organism in choosing a site for its operations more favourable for the capture of the particular kind of food upon which it lives. Yet every observer of distribution of marine animals knows that this is precisely what happens, and that at a given time of year he will find particular species by dredging or fishing in particular spots.

The knowledge of the floating life of the sea and its variations in season, and in locality, is most important, and although the experimental methods available may be imperfect and may not show all variations in the content of the water in living organisms, yet much as to sequence and interdependence of life may be found out by such study.

It is equally important that the limitations of such study should be appreciated, and that figures so obtained should not be applied with a direct mathematical rigour for which there is no warrant.

Tow-nettings taken with care throughout a season may show quite clearly the relative quantities of a certain organism available as food for another, but such figures taken and multiplied into volumes of water to show how many litres of water the latter organism must filter through its body before it can make a sufficient meal from the former constitutes a drifting into ridiculous absurdity, such as usually overtakes the biologist when he applies mathematics in a blindfold fashion without thinking of the many natural limitations unrepresented in his simple formula.

A herring, which swam about aimlessly with its mouth open in a sea containing 0.5 parts in one million of organic matter as plankton, would have to filter a good deal of water before it obtained an adequate supply of food, and might grow very lean in the process; another herring in the same sea making proper use of its sensory and nervous systems might be able to detect enormous variations in the distribution of food and grow fat where the other was starving.

It is, accordingly, the factor of the animal's one action which appears to us to have been disregarded too much, and this explains how a balance of nutrition can be obtained, in spite of the low figures for dissolved organic matter and for plankton on the supposition of a uniform distribution.

These theoretical considerations illustrate the importance of determining such questions as the organic content in solution and suspension of the sea-water, and of the amounts of organic matter required by different types of animal.

In regard to the first part, viz., the organic content of the sea-water, we believe that we have obtained definite results which place a maximum at such a low level as to show that the organic content in solution is almost negligible and lies within the limits of error of determination, and also that the plankton, whether as ordinarily fished with a fine silk netting or as separated by the Chamberland filter, is represented by a very low figure. But in respect to the amounts of organic matter oxidized by the species of animal with which we have worked, we are only able to put preliminary figures forward as yet, and intend to supplement these later by fuller study of each species. This latter portion of the work has opened up certain new problems which will be mentioned in describing the experiments.

The work was carried out at the Marine Biological Station, Port Erin, Isle of Man, during April, 1912, and our thanks are due to Professor Herdman, for the invitation to work at the problem, for the use of the steam yacht 'Runa' in collecting water and specimens, as also for many most valuable suggestions in the course of the work. The expenses of the research have been defrayed by a grant from the Percy Sladen Memorial Trust, and we desire to take this opportunity of expressing our indebtedness to the Trustees.

The water used was collected purposely in different situations, sometimes four miles out at sea, sometimes between one and two hundred yards, sometimes close to shore from beside Port Erin Breakwater, and sometimes in the Aquarium at the Biological Station, so as to follow all variations which might be possible, but all water used was clean fresh sea-water.

The plankton was completely separated from the water in a measured volume passed through the Chamberland pump, in two portions, viz., (*a*) that separated by a No. 20 silk-netting, which is the finest silk gauze made and used for plankton work, and (*b*) that separated by the material of the Chamberland filter candle after passing through the silk.

Determinations were then made (*a*) of the organic matter oxidizable by potassium permanganate, (1) in acid, (2) in alkaline solution; and (*b*) of (1) free and saline ammonia, (2) organic or albuminoid ammonia, in the following portions: (i) The unfiltered sea-water, (ii) The sea-water

filtered through the silk-netting only, (iii) the sea-water filtered through both silk and filter, (iv) the residue caught on the silk, (v) the residue left on the candle of the Chamberland filter.

As the total number of litres filtered for each experiment was known, it follows that such a method of procedure gave (a) total amounts of organic matter in unfiltered, partially filtered, and completely filtered water, and (b) amount of organic matter removed by ordinary silk tow-netting and by complete filtration of all organic matter, including bacteria.

It may at once be indicated that the organic matter as determined by the direct method was exceedingly small, and fell well within the limits of experimental error. The residues gave reliable titrations, as the suspended organic matter from several litres could be taken for analysis and so experimental errors could be discovered, but when worked out to amount per litre the figures give very small amounts and amply confirm those obtained directly in the analyses in the water, since they fall within one part per million. The fraction stopped by the Chamberland is much greater than that stopped by the silk-netting.

In the second portion of our enquiries, estimations were made of the rate at which organic matter was oxidized by various species of marine animals, by making determinations of the rate of disappearance of dissolved oxygen from a known large volume of *filtered* sea-water in wide-mouthed stoppered bottles in which the animals were enclosed without the presence of air for a known period of some hours' duration. In addition, the carbon dioxide produced in the same period by the respiration of the animals was estimated by simple titration of a known volume of the water with centinormal acid at the end of the experiment, and using phenol-phthalein as indicator. This simple method was found to give results of considerable value. Also the amount of oxidizable matter in the water was determined at the beginning and end of each set of experiments by the permanganate methods, alongside controls in which no animals were present in the water, and the amounts similarly of free and saline, and of albuminoid or organic ammonia. So far from showing any diminution in dissolved organic matter, as might have been expected if dissolved organic matter formed the main source of nutrition, as supposed by Pütter, it was always found that both organic carbon and organic nitrogen were largely increased, and this also even when the animals had been kept without food for twenty-four hours previously, and no obvious solid dejecta were present.

In such experiments as these the animals are, of course, living on the reserve food of their tissues and metabolic organs. The total wastage from the animals is rightly represented by the sum of the oxygen disappearing in oxidizing organic matter (and so yielding energy to the animal for its life-processes) and of the unoxidized organic matter added as waste of excretions and secretions to the water. Both these quantities would be increased in an animal which was fed during an experiment, so that the sum of these two quantities of organic matter must be regarded as the minimal demand. The amounts are given in Section B, and it will there be shown that the amounts of organic matter in solution, or as separated by a Chamberland pump, sufficient to satisfy such demands, would be distributed in too inordinately large volumes of water for the animals to obtain them by fishing out or filtering average sea-water.

It would appear from these experiments as if the higher animals, instead of living upon dissolved organic matter, or bacteria or protozoa, on the contrary contributed energy in the form of organic compounds to sea-water for the use of these lowlier organisms. The source of this organic matter, in addition to that required for their own use, being grosser food-supply, or plankton occurring in shoals.

The results of the investigations will be described in two separate sections, the first dealing with the organic matter of the sea-water and the second with the metabolism of the marine animals.

Section A. THE ORGANIC MATTER OF THE SEA IN SOLUTION AND SUSPENSION

Any accurate determination of the amount of organic matter in sea-water is rendered almost impossible for two reasons: first, the amount of organic matter is excessively small; secondly, the amount of inorganic matter as chlorides and carbonates is relatively enormous, and the chlorides especially interfere with all known methods of oxidation by yielding free hydrochloric acid, and, in presence of oxidising agents, free chlorine which interferes with the titrations. For these reasons all that can at present be given is a very low figure as a maximum, which it can safely be said that the organic matter does not exceed.

Strange as it may seem, in view of the immense superstructures which have been built upon the supposed presence of appreciable amounts of organic matter, we have only been able to find one observer, E Raben,¹

1. *Wissensch. Meeresuntersuch.* herausg. v. d. Kommission z. Wissensch. Untersuch. d. deut. Meere in Kiel u. d. biol. Anstalt auf Heligoland, N.F., Bd. XI, Leipzig, Lipsius u. Tischer, 1910.

who has carried out a series of analyses in filtered sea-water, and the greater part of these are vitiated by being made on polluted water from Kiel Ford, the great naval base of the German Navy.

In regard to unfiltered water the amount of quantitative work is also most meagre. Not only has Pütter failed to make any determinations of the amount of organic matter in water completely cleared of suspended matter by Chamberland filtration, there is no note in his paper that the water was filtered from plankton by silk-netting or filter paper, and one is left from the description to understand that the water analysed was entirely unfiltered water from the Gulf of Naples. Twelve analyses are given, and, as Henze points out, although these were taken on days close together, the values obtained show enormous variations from 68 mgms. of organic carbon per litre to 134 mgms. Such variations might have caused Pütter to suspect the accuracy of the method used, but he draws no attention to them. In discussing the nature of the supposed organic carbon, he concludes from the simple process of distillation in acid, and catching the distillate in decinormal alkali, that no less than 36 mgms. per litre are present as volatile organic acids. One would have thought that this large quantity of volatile organic acids would have afforded an opportunity of finding out the nature of such acids, but Pütter replaces this experimental work by a theoretical speculation, as a result of which he places the average molecular weight of the volatile fatty acids at 128. Inspired by this result, he proceeds to fix on a theoretical basis, the composition and oxygen value of the remaining part of the supposed organic matter amounting to two-thirds of the whole.

There is little doubt that the supposed volatile organic acids of Pütter consist of hydrochloric acid distilled off from his mixture of sea-water and sulphuric acid, and the same type of explanation holds for his supposed 68 to 134 mgms. of organic carbon per litre of sea-water, upon which the whole superstructure of his solution-nutrition theory is based. This organic carbon in Pütter's experiments probably arose, as Raben¹ points out, from acetic acid set free from lead acetate, which Pütter interposed to take up the evolved hydrochloric acid. The volatile acetic acid was carried over to the glowing tube containing lead chromate and copper oxide, and there combusted. So that Pütter's figures for organic carbon represent a variable amount of organic matter arising from one of the reagents used in the analyses.

The method used was that known as Messinger's wet combustion

1. *Loc. cit.*

method, in which the organic matter is oxidised by a mixture of potassium bichromate and strong sulphuric acid, or by chromic acid. This method was originally designed for use in potable waters where the amount of chlorides is low. When transferred to use in the case of sea-water, the utmost care must be taken that hydrochloric acid or chlorine bodies are not allowed to pass over and become absorbed in the weighed potash bulbs intended for absorption of the carbon dioxide.

Shortly afterwards Henze¹ repeated Pütter's work, taking care by the interposition of a tube of metallic antimony and of a glowing tube of lead chromate and copper oxide to prevent any chlorine compounds or acid reaching the carbon-dioxide absorption apparatus. With such precautions, Henze found that while organic matter added to sea-water was readily oxidizable and re-obtained with ease, the amount of organic matter in sea-water under natural conditions was such as to fall within the region of experimental error. Henze concludes that so far as Pütter's views are based on presence of appreciable amounts of organic matter in the sea-water they are devoid of all experimental proof.

In his later monograph,² Pütter refers to this work of Henze's, and appears to accept it as proving that his former work was based on much too high figures, and without any further experimentation discards his earlier average amount of 90 mgms. of organic carbon, and replaces it by a new figure of 4 to 5 mgms.

In this later monograph on the subject, Pütter admits that the Messinger method of determining organic carbon cannot be utilized, and suggests its replacement by determinations of the amount of oxygen necessary for oxidation of the organic matter as completely as may be done by potassium permanganate in acid or alkaline solution.

This method is used by Pütter in his respiratory experiments, and he appears to be unaware of the fact that it also is upset by the action of the hydrochloric acid and chlorine set free by the interaction of the acid and permanganate upon the chlorides present in such preponderating quantity.

As will be shown later, the method can only be used with the greatest caution, *in the cold*, and using as a zero a blank, in which no organic matter but an equal amount of chlorides is present, under comparable conditions throughout.

When this is done, the difference in readings between sea-water and

1. Pflüger's *Archiv. f. d. ges. Physiol.*, Bd. CXXIII, S. 487, 1908.

2. Die Ernährung der Wasserthiere, und der Stoffhaushalt der Gewässer, Fischer, Jena, 1909, pp. 49 and 99 to 101.

the inorganic control fall practically to zero, showing that organic matter is scarcely detectable in the sea-water.

But Pütter recommends that the mixture of sea-water, acid, and permanganate shall be boiled for ten minutes.

In an experiment carried out by us to test the effects of such a procedure, six grams of pure fused sodium chloride were taken and dissolved in 250 c.c. of distilled water, so as to represent approximately the concentration in chlorides of sea-water, and the usual amount taken in actual experiments. To this, 10 c.c. of 25 per cent. sulphuric acid and 10 c.c. of N/20 KMnO_4 solution were added, the same quantities as might be used in an experiment.¹ The whole was then boiled for only five minutes, instead of the ten recommended by Pütter, cooled and titrated with N/10 $\text{Na}_2\text{S}_2\text{O}_3$, after adding excess of potassium iodide to release iodine, when only 5.8 c.c. were required instead of 10 c.c. A parallel experiment with 250 c.c. of distilled water and no sodium chloride, treated otherwise similarly, gave no loss of chlorine, requiring at the end 10 c.c. of decinormal thiosulphate for neutralization.

This shows clearly that any kind of result as to content of oxidizable organic matter may be obtained by following the method described by Pütter in his monograph. For example, the above experiment would fallaciously show 13.4 mgms. per litre of oxygen required for oxidation of organic matter, this in an artificial sea-water containing not a trace of organic matter but only pure sodium chloride fused before use.

The experiments recorded below with 'Falk' salt,² and the salts of sea-water after evaporation and ignition over a bunsen-burner, show the same effects, but in lessened degree, because the experiments were carried out in the cold and in stoppered bottles. These figures form the blanks to the sea-water. Where organic matter is actually present as in the residues on silk-netting and Chamberland, the change in the figures shows that such true organic matter is readily oxidizable by the permanganate, and results can be obtained when proper precautions are taken.

For these reasons, the results obtained by Pütter by the permanganate method resemble those with the Messenger method in being vitiated by experimental errors, and all proof is lacking of any appreciable amount of oxidizable organic matter in normal filtered sea-water.

1. See below.

2. This is a pure table salt manufactured by the Salt Union, Ltd., Liverpool. It contains no appreciable amount of organic matter, but in any case it was always heated before use.

More recently, an important contribution to the subject of the amount of organic matter in sea-water has been made by Raben, who has, like Henze, demonstrated the illusory character of Pütter's analyses, and expresses his complete concurrence with Henze's concluding statement quoted above.

Four out of the six complete and careful analyses made by Raben were carried out upon water from the 'Kieler Förde,' and two only with water from the open sea. The results show a wide difference, the four from Kiel yield 13.9, 12.8, 11.4, and 10.9 mgms. per litre respectively, while those from the open sea yield only 3.0 and 3.2 mgms. respectively. Raben ascribes this difference to three causes, viz., nearness to land, presence of the German fleet in the harbour, and the access of sewage (Schmutzwasser).

An amount of 3 mgms. per litre is equivalent to 0.3 mgm in the quantity of water taken for analysis, viz., 100 c.c., which would yield 1.1 mgm. of carbon dioxide or approximately 0.5 c.c. This is a quantity, as Henze states, which is well within the limits of experimental error with such a complicated apparatus, working for a period of two hours in a stream of air.

The exacter experiments of Henze and of Raben have accordingly shown that the organic carbon dissolved in sea-water is an exceedingly minute quantity lying at the limits of detectability by the best known methods.

There are one or two figures given by earlier observers indicating a higher value, but the methods of analysis are so questionable in the light of more recent knowledge as to rob them of all value. In connection with the Challenger Expedition, J. Y. Buchanan made a few estimates of organic carbon by the rather drastic procedure of distilling to dryness with potassium permanganate, and found in different samples from 2.3 to 7.7 mgms. of organic carbon per litre. But in summarizing, he himself states: 'The few determinations of "organic carbon" by means of permanganate of potash were experimental, and were entered in my journal in course. I was, however, so dissatisfied with the experiments that I soon gave them up, and I attach no value to the results.'

The early observations of Natterer in 1892 need only be mentioned because Pütter seems to attach some importance to them at the present day. They were made long before the difficulties of the problem were appreciated, and gave results varying in different samples from 10 to 50 mgms. per litre. But when it is explained that they were obtained

by heating an alcoholic filtrate, still containing a large residue of inorganic salts, in a test-tube until the test-tube began to soften, the difference in weight of the tube before and after being taken as the amount of organic matter, chemists of to-day will know how much credence to give them.

Pütter in his monograph¹ also lays considerable stress on an organic substance obtained from sea-water resembling stearin or palmitin. This substance was obtained at the end distillation of 200 litres of water, thrown together from all sources at the end of the expedition, as Natterer himself states it came over 'in ganz geringer Menge' only a few centigrams from the whole 200 litres, of a miscellaneous collection of water samples at the end of the trip, and the only evidence of palmitin or stearin is that in heating in an open tube it gave a smell resembling overheated palmitic or stearic acid, and that it melted at approximately the same temperature as stearic acid.

It is certainly remarkable to find such an isolated experiment of such a type as this quoted fifteen years later, without any further experimental work by the person quoting it, as evidence of the presence of higher fatty acids in sea-water.

The most reliable method for obtaining the organic carbon in well and river water consists in evaporating down to dryness in presence of sulphurous acid to drive off the inorganic carbonate, and then subjecting the residue to combustion by either the ordinary dry method or a wet method, and estimating the carbon dioxide produced either volumetrically by gas analysis, or by absorption in potash balls and weighing.

This method is rendered useless in the case of sea-water by the enormous amount of chlorides present compared to the small amount of organic matter. When sea-water is evaporated to dryness in a porcelain basin and then heated over a Bunsen burner, there is just a faint yellowing of the mass and then it turns white. To obtain enough carbon to give any appreciable reading in a combustion, would require enough sea-salt to fill a combustion tube.

The method used throughout was wet oxidation with potassium permanganate in the cold for a number of hours stated in each case. As soon as we appreciated the precautions required we employed a control, carried out under like conditions, of ignited sea-salt or Falk table salt, also ignited before use.

For the greater number of cases oxidation in acid solution was

1. *Loc. cit.*, p. 102.

employed, but as we thought part of the difficulty might be avoided by oxidizing in alkaline solution, in later experiments we also used alkali. It would appear, however, that the greater part of the difficulty with the chlorides is attached to the actual titration at the end, which must be done in both cases in acid solution, and when allowance is made for the fact that in alkaline reduction only 3, in acid solution 5 atoms of oxygen are set free, there is practically no difference in the two sets of results.

It has been suggested by Dupré¹ that the method can be used in presence of chlorides, and even in sea-water, if glacial phosphoric acid be used instead of sulphuric acid. Accordingly, we experimented with this modification, but without change in the result. In presence of sodium chloride the titration figure showing remaining excess of permanganate at the end is always lower than with distilled water, so falsely indicating a small amount of organic matter.

The nearest we were able to approach the problem, accordingly, consisted in carrying out a control under as like conditions as possible to give a zero, and when this is done the organic matter found in the sea-water is negligibly low.

The method is too well known to require detailed description.² The following is an outline:—250 c.c. of the water were taken, alongside other samples and controls, in wide mouthed glass-stoppered bottles of about 400 c.c. capacity, 10 c.c. of one in four sulphuric (or phosphoric acid) was added, and the appropriate amount of N/20 or N/80 KMnO_4 solution, such as 10 or 20 c.c. of N/80, or 5, 10, or 15 c.c. of N/20, as detailed below. The bottles were left at laboratory temperature, except where otherwise stated, for a number of hours, but all for some time. A few drops of a 5 per cent. solution of potassium iodide are then added, so as to give excess and set free iodine corresponding to the unused excess of potassium permanganate, and the iodine was then titrated in the usual way with a N/40 solution of sodium thiosulphate, using starch indicator.

EXPERIMENT I.—The water used for this experiment was taken on the steam yacht 'Runa,' about four miles west of Port Erin, in the open sea. It was filtered on board the yacht, and the potassium permanganate and sulphuric acid were at once added on board, and it was then taken to the laboratory for analysis. In addition, about five litres of the completely filtered water were retained for determinations of the free and saline

1. *Analyst*, Vol. X, 1885.

2. See Sutton, *Volumetric Analysis*, tenth edition, 1911, pp. 484-488.

ammonia and of the organic or albuminoid ammonia. The removal of the non-dissolved constituents took place in two stages. The water coming up from the sea in a rubber hose pipe of about one inch bore (2.5 centimetres), which was sunk about 4 metres in the sea, before passing to the Chamberland pump was attached to a piece of wide glass tubing about two feet long. This glass tube passed through a cork about four inches from one end. The cork fitted into the neck of an ordinary filter flask, such as is used with a suction pump in ordinary laboratory work. A piece of the finest silk netting (20 mesh gauze) was used to make a tube about five inches long, somewhat narrower at the closed end, and fitting by its wider open end around the cork, so that it was enclosed airtight between the cork and the neck of the filter flask, and all the water filtered had to pass through it. The side outlet of the filter flask was connected by a second short piece of hose with the Chamberland pump. The silk-netting accordingly retained the amount of plankton separated from the quantity of water filtered in any such experiment, the filter flask contained water which had been silk filtered only, the deposit on the Chamberland candle at the end gave the non-soluble matter in the volume of water filtered, which was too small to be removed by the silk netting, and the completely filtered water was obtained and measured as it came from the pump. At the time of the experiment a sample of unfiltered water was taken by the closing water bottle from the same depth as the open end of the inlet hose. In this way five things, viz., two deposits and three waters, were taken at one time from the same spot for analysis.

The quantity of water filtered in this particular experiment was forty litres. Two samples of the Chamberland filtered water, and one sample each of the unfiltered and silk-filtered waters, were analysed, 10 c.c. of $N/80 \text{ KMnO}_4$ (1 c.c. = 0.0001 gram of oxygen) being added to each, and all being then kept in the incubator at 25°C . for four hours. As the first amounts added were decolourized, 10 c.c. of $N/20 \text{ KMnO}_4$ were added later in each case. The results obtained are shown in the following table in milligrams of oxygen required for oxidation of organic matter per litre, but as explained above these results really show that no organic matter is present, for the amounts are no greater than those shown in Experiment V, D, where no organic matter is present, and merely represent a small amount of hydrochloric acid decomposed with liberation of chlorine and its partial escape. This loss is higher than in subsequent experiments, because the samples were heated in an incubator to 25°C . instead of being kept at air temperature.

No. 1.	Chamberland filtered water	=3·16	mgms.	per	litre.
No. 1a.	„ „ „	=3·16	„ „	„ „	
No. 2.	Silk filtered water	=2·48	„ „	„ „	
No. 3.	Unfiltered water	=3·84	„ „	„ „	

The fact that the completely filtered samples appear to contain more organic matter than that only filtered through silk, is confirmatory evidence that it is not really organic matter which is determined. But even making no allowance for experimental errors, it is seen that the amount of organic matter possibly present taken at a maximum is very small.

As at this period the disturbing influence of the chlorides was not fully appreciated, the two deposits on silk and Chamberland candle, respectively, were taken up in sea-water in this experiment and the next one. In later experiments the deposits were taken up in distilled water. Allowances based on the above data were made as deductions for the amounts of filtered sea-water so used in taking up the residue. The residue on the silk-netting, which was very small in amount, required permanganate representing 11·6 mgms, and as this came from 40 litres, the amount of plankton, separable from the sea-water by such silk, corresponded to 0·29 mgms. of oxygen¹ per litre. Similarly, the Chamberland deposit, which was more copious, was taken, mixed thoroughly with 400 c.c. of filtered sea-water, and 50 c.c. were taken for the analysis. This portion was equivalent to 4·55 mgms., or 36·4 in the whole amount of 40 litres, which works out at 0·91 mgms. of oxygen per litre. The total amount of matter in suspension is therefore equivalent in oxygen to:—silk=0·29, Chamberland 0·91=1·2 mgms. of total plankton. This figure is free from the chloride error, and as the titration figures are quite large, it probably fairly accurately represents the plankton on that day, when fairly heavy takes were being recorded by the ordinary tow-nettings of the Biologists on board. It is to be noted that the Chamberland here retains about three times the quantity removed by the silk.

The free and saline, and albuminoid ammonia as determined by the usual water analysis method, and testing by Nessler's reagent against standard dilutions of ammonium chloride solution, gave 0·04 parts per million of free and saline ammonia, i.e., 0·04 mgms. per litre, and of albuminoid ammonia 0·2 parts per million or 0·2 mgm. per litre. If all

1. One milligram of oxygen may be roughly taken as equivalent to 2·5 milligrams of organic matter, and this factor must be used throughout, see Table at end of this section of the paper.

this albuminoid ammonia be taken as protein it must be multiplied by the factor 5 to get protein, which would give 1 mgm. per litre of protein.

EXPERIMENT II. In this experiment the oxidation with permanganate and sulphuric acid was carried out at laboratory temperature for a period of about fifteen hours. The volume of water filtered was 43 litres. It was taken from three to four metres below the surface, on the yacht 'Runa,' on the afternoon of the same day as that of the preceding experiment, the situation from which it was taken was about three miles north-west of Port Erin in the open sea.

The analyses concern one sample of water completely filtered through Chamberland, two samples filtered through silk only, one of unfiltered water, one the deposit retained by the silk, and one of the deposit on the Chamberland candle.

The water analyses gave the following figures, to which the same remarks apply as in the preceding experiment:—

No. 1.	Chamberland filtered water	= 2.24	mgms.	per	litre
No. 2.	Silk filtered water	= 1.89	,,	,,	
No. 2a.	,,	= 2.24	,,	,,	
No. 3.	Unfiltered water	= 1.73	,,	,,	

The deposit on the silk-netting, taken up in 240 c.c. of filtered sea-water, required 6.35 mgms. of oxygen for oxidation. On making allowance for the sea-water, this gave 5.79 mgms. in 43 litres, or 0.13 mgms. of oxygen per litre.

The deposit on the Chamberland candle was taken up in 600 c.c. of filtered sea-water, and 50 c.c. of this, or $\frac{1}{12}$ th, with 50 c.c. additional of filtered sea-water were taken for analysis. Its organic matter required 2.75 mgms. of oxygen, which amounts to 2.64 mgms. for the fraction of the residue only, multiplied by 12, this gives 31.68 mgms. from the 43 litres, or 0.74 mgm. per litre. The total suspended matter per litre is accordingly represented by 0.87 mgm. of oxygen, of which about $\frac{1}{6}$ is removed by the silk and $\frac{5}{6}$ by the Chamberland.

The ammonia determinations were made in this case on the unfiltered water, and gave:—Free and saline ammonia=0.1 mgm. per litre; albuminoid ammonia=0.16 mgm. per litre. These do not differ greatly from the results of the previous experiment with filtered water, and illustrate the excessively low organic content of pure sea-water whether filtered or unfiltered.

EXPERIMENT III. The oxidation in this experiment was also carried out in the cold for a period of fifteen hours, and phosphoric acid (ortho-phosphoric prepared by acid combustion and oxidation of phosphorus in the laboratory) was substituted for sulphuric acid to attempt to minimize loss of chlorine from the chlorides as recommended by Dupré (*loc cit.*). No difference, however, was found, as will be seen by comparing the results with sea-salt and 'Falk' salt after ignition as shown in Experiment V, D.

The water was filtered and treated on the yacht, taken on Saturday morning, April 13th.

The volume of water filtered was 53·2 litres. The silk netting deposit was so meagre that it was not regarded as worth doing, and it may be remarked that the ordinary tow-nettings taken on that occasion for biological purposes were very meagre. There was no visible deposit on the silk-netting in this experiment at the end of filtration of the 53·2 litres.

One sample each of the three conditions of the water were analysed for oxidizable organic matter, using in all 25 c.c. of N/20 KMnO_4 and 10 c.c. of 25 per cent. phosphoric acid to 250 c.c. of sea-water, the amounts used up of the standard KMnO_4 were only 0·7, 2·2, and 2·3 c.c. respectively in the three samples, and the results per litre work out as follows:—

- | | | |
|-------------------------------|--------|------------------|
| 1. Chamberland filtered water | = 1·12 | mgms. per litre. |
| 2. Silk filtered water | = 3·52 | „ „ |
| 3. Unfiltered water | = 3·68 | „ „ |

The residue in the Chamberland candle showed 9·38 mgms. of oxygen required for 53·2 litres, corresponding to 0·18 mgms. per litre.

In this experiment, both filtered and unfiltered water were analysed for ammonia with the following results:—

Unfiltered water:—Free and saline ammonia = 0·06 per million or 0·06 mgm. per litre; albuminoid ammonia = 0·17 per million or 0·17 mgm. per litre.

Chamberland filtered water:—Free and saline ammonia = 0·02 per million, or 0·02 mgm. per litre; albuminoid ammonia = 0·1 per million or 0·1 mgm. per litre.

Such a water would be put down as excellent amongst potable waters as regards organic matter. The figures again show what an infinitesimal trace of organic matter is present, especially in the filtered water, which contains less than the unfiltered, but all figures lie at the limit.

EXPERIMENT IV. The water used in this experiment was taken, on

the yacht, about 200 yards off Sugar Loaf Rock, outside Calf Island Sound in deep water, about two metres from surface, on Monday afternoon, April 15th. The volume of water filtered was 25·2 litres. The oxidation was carried out in the cold for fifteen hours, using 20 c.c. of $N/80 \text{ KMnO}_4$ and 10 c.c. of 25 per cent. glacial phosphoric acid to the 250 c.c. sample of water. The reagents, as usual, were added at once on the yacht.

The results were as follows:—

No. 1.	Chamberland filtered water	= 0·82	mgms.	per litre.
No. 2.	Silk filtered water	= 0·82	„	„
No. 3.	Unfiltered water	= 0·89	„	„

In regard to the silk-netting and Chamberland candle deposits, these, instead of being taken up in sea-water, were washed off by distilled water, so as to get rid of adverse influence of chlorides. The entire residue was taken in each case, in 250 c.c. of distilled water, and 10 c.c. of $N/20 \text{ KMnO}_4$ and 10 c.c. of 25 per cent. glacial phosphoric acid were used for oxidation.

The silk-netting deposit was oxidised by 0·664 mgm. of oxygen, which represents 0·03 mgm. of oxygen per litre.

The Chamberland candle deposit required 2·33 mgms., which gives 0·09 mgm. of oxygen per litre.

The total plankton is accordingly represented by 0·12 mgm. of oxygen per litre.

The unfiltered water gave the following low figures in the ammonia determinations:—Free and saline ammonia = 0·035 per million, and albuminoid ammonia = 0·08 per million.

EXPERIMENT V. The sea-water used in this experiment was pumped from the beach at the shore end of Port Erin Breakwater, when the water was about eight or nine feet deep, and the inlet hose was about five or six feet below the surface. A volume of 140 litres was pumped, and in addition to the analyses this water was utilized for Experiment VII of Section B for the oxygen exchanges of the animals.

Twelve analyses of oxidizable organic matter with permanganate were made in all in this experiment. Six of these were with the three conditions of the water, viz., Chamberland, and silk filtered, and unfiltered (*a*) in acid solution, and (*b*) in alkaline solution. Four were made on the two deposits, on silk and on Chamberland, (*a*) in acid and (*b*) in alkaline solution.

Two analyses were made upon 8 grams of 'Falk' salt made up, after

ignition to destroy any possible organic matter, to 250 c.c. with distilled water, so as to give an artificial sea-water free from any organic matter to serve as a control. All were carried out alongside of one another in similar bottles of equal size, and all conditions made as closely identical as possible.

The results of these two controls may also be used for the previous experiments, and show that the apparent small amounts of organic matter can all be accounted for on the basis of chloride decomposition.

The results were as follows:—

(A) WATERS IN ACID SOLUTION

No. 1. *Unfiltered water*

250 c.c. + 20 c.c. N/80 KMnO_4 + 10 c.c. of 25 per cent. glacial phosphoric acid, used up 1.4 c.c. = 0.56 mgm. per litre.

No. 2. *Silk-filtered water*

250 c.c. + 20 c.c. N/80 KMnO_4 + 10 c.c. of 25 per cent. glacial phosphoric acid, used up 1.16 c.c. = 0.46 mgm. per litre.

No. 3. *Chamberland filtered water*

250 c.c. + 20 c.c. N/80 KMnO_4 + 10 c.c. of 25 per cent. glacial phosphoric acid, used up 0.96 c.c. = 0.38 mgm. per litre.

(B) WATERS IN ALKALINE SOLUTION

No. 4. *Unfiltered water*

250 c.c. + 20 c.c. N/80 KMnO_4 + 5 c.c. N NaOH, at the end of 20 hours made acid (with glacial phosphoric acid 25 per cent., 11 c.c.) and titrated used up 2 c.c. = 0.48 mgm. per litre.

No. 5. *Silk-filtered water*

250 c.c. + 20 c.c. N/80 KMnO_4 + 5 c.c. N NaOH, titrated as above in acid, used up 1.16 c.c. = 0.28 mgm. per litre.

No. 6. *Chamberland filtered water*

250 c.c. + 20 c.c. N/80 KMnO_4 + 5 c.c. N NaOH, titrated in acid, used up 1.16 c.c. = 0.28 mgm. per litre.

(C) DEPOSITS IN ACID AND ALKALINE OXIDATION

No. 7. *Silk-netting Deposit oxidized in acid solution*

One half of the deposit + 250 c.c. distilled water + 10 c.c. N/20 KMnO_4 + 10 c.c. of 25 per cent. glacial phosphoric acid, after 20 hours at air temperature, used up 1.66 c.c. of N/20 KMnO_4 = 0.664 mgm. = 1.33 mgm. in whole deposit, this in 140 litres = 0.009 mgm. of oxygen per litre.

No. 8. *Silk-netting Deposit oxidized in alkaline solution*

One half of the deposit + 250 c.c. distilled water + 10 c.c. N/20 KMnO_4 + 5 c.c. N NaOH, after 20 hours at air temperature, made acid with 11 c.c. of 25 per cent. glacial phosphoric acid, used up 3.16 of N/20 $\text{KMnO}_4 = 0.758$ mgm., so in whole deposit = 1.516 mgm., as this is in 140 litres, the amount is 0.011 mgm. of oxygen per litre.

No. 9. *Chamberland deposit in acid solution*

One-tenth of Chamberland deposit + 250 c.c. of distilled water + 10 c.c. N/20 KMnO_4 + 10 c.c. of 25 per cent. glacial phosphoric acid, left 20 hours at air temperature, used up 2.4 c.c. of N/20 $\text{KMnO}_4 = 0.96$ mgm., therefore whole deposit = 9.6 mgms., this in 140 litres = 0.069 mgm. of oxygen per litre.

No. 10. *Chamberland deposit in alkaline solution*

One-tenth of Chamberland deposit + 250 c.c. of distilled water + 10 c.c. of N/20 KMnO_4 + 5 c.c. N NaOH., at end of 20 hours at air temperature made acid with 11 c.c. of 25 per cent. glacial phosphoric acid, used up 3.8 c.c. of N/20 $\text{KMnO}_4 = 0.92$ mgm., so in whole deposit there are 9.2 mgm., as this is in 140 litres the amount per litre is 0.066 mgm. of oxygen.

The total suspended matter removable both by silk and Chamberland is when oxidized in acid solution = 0.078 mgm., in alkaline solution 0.077 mgm. In working out the calculation it is to be remembered that the oxidizing power of the permanganate in alkaline solution is only three-fifths of its power in acid solution. Also the end titration in both cases is in acid solution. These concordant results demonstrate clearly that the oxidizing value of the organic matter in suspension, or total plankton in this water, is less than 0.1 mgm. per litre. The factor for conversion of oxygen used into total organic matter, as shown by combustion, ranges between two and six for different waters, taking the highest value, the maximum amount of organic matter in the total plankton lies at 0.4 mgm. per litre.¹ The amount of material available in the deposits from 140 litres was quite sufficient to give good figures, there were practically no chlorides present, and there is, therefore, little question as to the accuracy of these figures.

1. The remaining eight-tenths of the Chamberland deposit was dried and weighed and found to be 0.195 gram, this gives 0.247 gram for the entire deposit. This deposit was found by careful incineration to contain 77.5 per cent. of ash and 22.5 per cent. of organic matter. The amount of organic matter in the total 140 litres stopped by the Chamberland filter was accordingly 56 milligrams or 0.4 milligram per litre. On comparison with the result by the permanganate method in the text, this yields a multiplier of 6.

(D) 'FALK' SALT AFTER INCINERATION

No. 11. '*Falk*' salt (ignited), oxidized in acid solution

Eight grams 'Falk' salt + 250 cc. distilled water + 20 c.c. N/80 KMnO_4 + 10 c.c. of 25 per cent. glacial phosphoric acid left for 20 hours at air temperature, used up 3.52 c.c. of N/80 KMnO_4 = 1.40 mgms. per litre.

No. 12. '*Falk*' salt (ignited), oxidized in alkaline solution

Eight grams of 'Falk' salt + 250 c.c. of distilled water + 20 c.c. of N/80 KMnO_4 + 5 c.c. N NaOH, left at air temperature for 20 hours, then made acid with 11 c.c. of 25 per cent. glacial phosphoric acid and titrated, used up 4.72 c.c. of N/80 KMnO_4 , equivalent to 1.13 mgms. per litre.

These two samples of artificial sea-water, quite free from organic matter, hence show more organic matter per litre than the natural water, and prove that the slight amounts of organic matter there indicated lie within the limits of experimental error, and are probably due to slight chlorine escape.

The ammonia figures were also obtained for this filtered sea-water and confirm the above results in showing the usual amounts of organic matter present. The results are as follows:—Free and saline ammonia = 0.04 per million; albuminoid ammonia = 0.21 per million.

EXPERIMENT VI. This experiment was carried out to provide more controls than those mentioned in the previous experiment.

No. 1. *Sea-water titrated at once without allowing time for oxidation.*

A volume of 250 c.c. of Chamberland filtered sea-water was taken, 10 c.c. of N/20 KMnO_4 , and 10 c.c. of 25 per cent. sulphuric acid, then excess of potassium iodide solution was added at once without waiting and it was at once titrated. It appeared to have used up 0.8 c.c. of N/40 thiosulphate = 1.6 c.c. of N/80 KMnO_4 = 0.16 mgm. of oxygen or 0.64 mgm. per litre.

No. 2. A volume of 250 c.c. of sea-water was taken to dryness in a porcelain evaporating dish, and incinerated over a Bunsen burner. The salt turned slightly yellowish and then white. The residue in which organic matter had been thus destroyed was taken up in 250 c.c. of distilled water + 15 c.c. of N/20 KMnO_4 + 10 c.c. of 25 per cent. sulphuric

acid, after standing 15 hours this had used up 2.1 c.c. of N/20 KMnO_4 = 0.84 mgm. of oxygen or 3.36 mgm. per litre.

No. 3. A similar experiment but kept for 15 hours in the oven at 25° C., used up 4.4 c.c. of N/20 KMnO_4 = 1.76 mgm. or 7.04 mgms. per litre.

No. 4. Eight grams 'Falk' salt (unincinerated) + 250 c.c. distilled water + 20 c.c. N/80 KMnO_4 + 10 c.c. of 25 per cent. glacial phosphoric, for 24 hours at air temperature, uses up 1.8 c.c. = 0.18 mgm. of oxygen or 0.72 mgm. per litre.

No. 5. Same as No. 4, but 'Falk' salt, incinerated beforehand, uses up 2.1 c.c. = 0.21 mgm. oxygen or 0.84 mgm. per litre.

No. 6. Same amounts as Nos. 4 and 5, but in alkali instead of acid and unincinerated, uses up 4.6 c.c., which with factor of 3 instead of 5 oxygen, amounts to 0.27 mgm or 1.08 mgm. per litre.

No. 7. Same as No. 6, also in alkali, but the 'Falk' salt incinerated, used up 4.3 c.c. = 0.26 mgm., or 1.04 mgm. per litre.

No. 8. Sea-water, 250 c.c. evaporated down and incinerated, gave 8.2 grams of salt, this made up again to 250 c.c. with distilled water, 20 c.c. of N/80 KMnO_4 and 10 c.c. of 25 per cent. glacial phosphoric acid added, and left 24 hours at room temperature alongside Nos. 4 to 7 of this series, used up 2.7 c.c. = 0.27 mgm., or 1.04 mgm. in one litre.

It appears, accordingly, from the results of these controls that an amount of 1 to 3 mgms. per litre must be deducted from the results obtained above with the sea-water and the various filtrates, in order to show any organic matter, and when this is done all organic matter disappears; in other words, dissolved organic matter in pure sea-water is so small in amount as to fall within experimental error, and in the average certainly can be safely said not to exceed one mgm. per litre.

In other words, the titration figure of the permanganate solution in presence of so much chlorides is slightly lower than in distilled water, so falsely showing a trace of organic matter if compared with the titration in distilled water; when allowance is made for this, no organic matter is shown by this method, which would certainly detect it if any appreciable amount were present.

For this reason, the organic ammonia in the case of sea-water gives a more satisfactory guide. Even when all the organic ammonia is taken as protein, there is less than 1 mgm. per litre present, and it is probable that only a fraction is present as protein.

In all cases analysed, the amount of organic matter as plankton is surprisingly low. Although the Chamberland filtration removes about three times as much as silk-net filtration, the two together only form a fraction of a milligram per litre.

It may be concluded that at the season and under the conditions of our experiments, the combined dissolved and suspended organic matter does not on the average much exceed 1 to 2 mgms. per litre.

The various results of Experiments I to V on amounts of plankton are shown in the accompanying Table, in which the last column gives organic matter obtained by multiplying the oxygen consumed by 2.5, the average factor¹:—

TOTAL PLANKTON IN MILLIGRAMS PER LITRE						
			Silk Netting.	Chamberland.	Total.	Organic Mat ter.
Expt. I	0.29	0.91	1.2	3.00
Expt. II	0.13	0.74	0.87	2.17
Expt. III	Nil.	0.18	0.18	0.45
Expt. IV	0.03	0.09	0.12	0.30
Expt. V, in acid	0.009	0.069	0.078	0.19
„	in alkali	...	0.011	0.066	0.077	0.19

Section B. THE RATE OF OXIDATION OF ORGANIC MATTER IN CERTAIN MARINE ANIMALS

The amount of oxidizable organic matter in solution and suspension in sea-water, under conditions of average distribution, having been determined as nearly as possible in the preceding experiments, we passed on to obtain some idea of the rate at which certain marine animals consumed organic matter, as measured by the rate at which they consumed oxygen dissolved in the water. Three series of experiments were made, in the first two series the animals were used as soon as taken from the sea, and the considerable amount of excrement in some cases showed that digestion was actively proceeding; in the third, the animals were kept without feeding, in filtered sea-water for 24 hours before commencing the experiment, in order to obtain results in the analyses of the water afterwards as free as might be from the disturbing influence of excretion of solid matter.

In the latter case the period of deprivation of food was not of

1. The actual value of this factor cannot be determined for the sea-water. The estimation of the organic matter in the Chamberland deposit of Expt. V leads as already indicated to a value of 6, but this is probably too high.

sufficient duration so far to reduce the reserve store of metabolized material as to decrease the rate of using up of food by oxidation. The volume of sea-water allowed was in most cases large compared to the volume of the animals, and under such conditions it might have been expected on the hypothesis of Pütter that the amount of dissolved organic matter would have decreased, but, on the contrary, it was always considerably augmented.

Both this increased amount of dissolved and suspended organic matter, and the amount which had disappeared, corresponding to the amount of oxygen used up by the animal in its respiratory exchanges, must be added together to indicate the amount which under natural conditions would have to be replaced by the food of the animal.

These two quantities of organic matter are the index of the demand of the animal for a food supply, the amount of the oxygen used up gives a measure of the energy utilized by the animal, and the organic matter added to the water shows the amount passed through without utilization.

Each type of animal was kept separately for an observed time-interval in a large wide-mouthed bottle, the average volume of the bottle being 2,800 c.c. A control bottle was kept under like conditions throughout the experiment without any animals, so as to give a deduction for any consumption of oxygen by bacteria or small plankton during the experiment, but the loss of oxygen in this way was found to be very small.

In starting the experiment the animal was transferred to the bottle in which it was to be kept, and well washed with filtered sea-water coming directly from the Chamberland pump. The bottle was then filled in a large clean bucket, which was also full of the filtered water, so that the lid or stopper of the bottle could be slipped on under water without including any air. Each experiment was carried out in two stages. Samples were taken out at the expiry of the first period mentioned in each case for the determinations to be indicated presently, and then a sufficient amount of filtered sea-water was added to replace that removed, and the experiment allowed to proceed overnight till the following day, when it was finally interrupted and the determinations made.

The most important determination in this series was (*a*) the amount of dissolved oxygen in the measured volume of water at the beginning and end of the experiment, but in addition (*b*) the output of carbon dioxide was determined by titration, as described below, of the water at beginning and end with centinormal caustic alkali using phenol-phthalein

as indicator, (c) the oxidizable organic matter by the permanganate method as in Section A, (d) the free and saline and organic ammonia, (e) the moist weight of the animals, the total dried weight, the weight of organic matter when dried, the weight of skeleton, and the ash in the skeleton.

The method used for determining the dissolved oxygen was that of Winckler, which has been so often described in connection with similar work and in text-books of water analyses,¹ that it need not be given in detail. In principle it consists in utilizing the free dissolved oxygen to convert manganous to manganic oxide, then by acting upon this with hydrochloric acid in presence of hydriodic acid to set free the corresponding amount of iodine, which is then titrated in the usual fashion by standard sodium thiosulphate in presence of starch indicator.

The work is carried out in an ordinary narrow-mouthed bottle of about 300 c.c. capacity, such as is used for bench reagents in the laboratory. This is completely filled with water, so that the stopper is inscrtable without any air-bubbles, then the stopper is removed, and the volume it contains is measured and noted. Such a bottle of measured volume is completely filled with the sample of sea-water to be estimated, taking care this is not aerated in the process. By means of a pipette 1 c.c. of a 10 per cent. solution of manganous chloride is introduced to the bottom of the bottle, and followed by 3 c.c. of a mixture of saturated caustic potash containing 10 per cent. of potassium iodide, also passed in at the bottom. The stopper of the bottle is then inserted without introducing any air-bubbles and the contents mixed by rotation. The bottle is left for some time for the manganous hydrate to take up all oxygen and settle to the bottom. In about half an hour, the bottle may be opened and 5 c.c. of concentrated hydrochloric acid passed to the bottom by a pipette, the stopper is again inserted and the contents thoroughly mixed, when the acid re-dissolves the mixed hydrates of manganese, and an amount of iodine is set free corresponding to the amount of oxygen in the water. The contents are transferred to a flask and titrated with thiosulphate.

EXPERIMENT VII. The water used in this experiment was Chamberland filtered, being a portion of the 140 litres pumped from beside the Breakwater as described in Experiment V, Section A. Three large wide-mouthed bottles of 2,800 c.c. capacity were completely filled,

1. See Sutton's *Volumetric Analysis*, tenth edition, 1911.

the lids being fitted on under the sea-water, so as to exclude all air, and contained as follows:—(a) Control containing the filtered sea-water only, (b) a large-sized sponge, (c) a group of ascidians.

The experiment was commenced at 11 a.m., April 16th, and was interrupted in $8\frac{1}{2}$ hours, viz., at 7.30 p.m., to take samples for determination of dissolved oxygen, a small volume of fresh sea-water was then added to replace that removed for analysis (about 300 c.c.), and the experiment was allowed to continue till 11 a.m. on April 18th; that is, for 48 hours in all. The results of the two intervals are shown in Table I, Part 1 and Part 2, as under:—

TABLE I.—Part 1

Dissolved Oxygen after $8\frac{1}{2}$ hours			
	Milligrams per litre.	Total mg. in 2,800 c.c.	Milligrams of Oxygen used by Animals.
(a) Control	... 7.93	22.20	—
(b) Sponge	... 7.42	20.77	1.43
(c) Ascidians	... 7.00	19.60	2.60

TABLE I.—Part 2

Determinations at end of 48 hours

1. Dissolved Oxygen used up

	Milligrams per litre.	Milligrams in 2,800 c.c.	Milligrams used by Animals in 48 hours.
(a) Control	... 7.02	19.66	—
(b) Sponge	... 6.46	18.09	1.57
(c) Ascidians	... 6.82	19.10	0.56

2. Oxygen given out in form of Carbon dioxide

	Milligrams per litre.	Milligrams in 2,800 c.c.	Milligrams excreted by Animals in 48 hours.	Respiratory Quotient.
(a) Control	... 1.28	3.58	—	—
(b) Sponge	... 2.40	6.72	3.14	2.1
(c) Ascidians	... 1.12	3.14	0.44	Indeterminate

3. Oxygen required for oxidation of organic matter

	Milligrams per litre.	Milligrams in 2,800 c.c.	Added to water by Animals.
(a) Control	... 1.04	2.91	—
(b) Sponge	... 1.84	4.15	1.24
(c) Ascidians	... 1.16	3.25	0.34

4. Ammonia determinations (a) Free and Saline, (b) Albuminoid

	FREE AND SALINE.			ALBUMINOID.		
	Mg. per litre.	Mg. Total.	Mg. excreted by Animals.	Mg. per litre.	Mg. Total.	Mg. excreted by Animals.
(a) Control ...	0.07	0.20	—	0.22	0.62	—
(b) Sponge ...	0.33	0.92	0.72	1.20	3.36	2.74
(c) Ascidiains ...	0.03	0.08	0.12	0.42	1.18	0.56

5. Constants for Animals (Weights, etc.)

	Moist Weight in grms.	Total Dry Weight.
(a) Control ...	Nil	—
(b) Sponge ...	43.9	9.345
(c) Ascidiains ...	11.3	1.092

REMARKS.—The chief points to be noted about this experiment are:—(1) That there was an ample supply of water, because when allowance is made for specific gravity, the volume of the Sponge would be about 40 c.c., and that of the Ascidiains 10 c.c., and as the volume of water was 2,800 c.c., the Sponge had about 70 times its volume of water and the Ascidiains about 280 times their own volume of water. Also the supply of oxygen was ample, as shown by the slight fall in the 48 hours. With larger volumes it would have been impossible to estimate the gaseous exchanges. (2) The very small amounts of oxygen required by these two types of animals in the 48 hours, less than two milligrams by the Sponge, and about half a milligram by the Ascidiains, and the very much greater output of carbon dioxide by the Sponge, the amount for the Ascidiains, although it is negative apparently, probably lies within the limits of experimental error. (3) So far from using up any dissolved organic matter, both types distinctly increase the amount of organic matter in the water, and this is confirmed by two quite independent methods, viz., oxidation by permanganate and determination of albuminoid ammonia. Permanganate oxidation is not complete, and, on an average, multiplication of the weight of oxygen used by 2.5 gives the weight of organic matter present. In the case of the Sponge this gives 3.1 mgms., and for the Ascidiains 0.85 mgm. of organic matter excreted and added to the water in the 48 hours. (4) In the complete oxidations of respiration, the weight of oxygen required may approximately be taken as equal to the weight of organic matter combusted. If the higher figure of the oxygen in the carbon dioxide be taken, the Sponge shows about 3 mgms.

combusted. Similarly, taking the higher figure of oxygen consumed for the Ascidians, the amount combusted is about 0.6 mgm. (5) Adding together the organic matter under sources (3) and (4), the probable amounts used in the 48 hours are: Sponge, 6 mgms.; Ascidians, 1.5 mgms. (6) The determinations given under Experiment V, for the total plankton in the water used for the experiment, are very concordant for the acid and alkaline oxidation, giving for oxygen used, 0.078 in acid, and 0.077 mgm. in alkali per litre, taking 0.08 mgm. as a round number and multiplying by the factor 2.5, the amount of organic matter in the plankton becomes 0.2 mgm. per litre. (7) From these data it can be calculated what volume of sea-water would require to pass through each type. The amount works out at 30 litres for the Sponge, and 7.5 litres for the Ascidians, in 48 hours, or approximately 600 c.c. per hour for the Sponge and 150 c.c. per hour for the Ascidians. Taking the volume of organism used as the unit, viz., 40 c.c. and 10 c.c., this may be expressed by saying that in each case the organism requires fifteen times its own volume of sea-water per hour. It may be pointed out that this sample of water was the lowest of the series in plankton, and on the other hand, that in the sea the animals would possibly have been more active and had a higher metabolism.

EXPERIMENT VIII. This experiment was also carried out with Chamberland filtered water obtained from the same spot by the Breakwater on April 19th. The details were as described in the previous experiment. The experiment was commenced at 4 p.m., April 19th, was interrupted to take oxygen samples at 8 p.m. (i.e., in 4 hours), a small volume of water was added to replace that removed, and the experiment allowed to go on till next morning at 11 a.m. (i.e., total duration was 19 hours). Volume of filtered sea-water=2,800 c.c. in each case. The results are shown in Table II.

TABLE II.—*Part 1*
Time-interval=4 hours

Dissolved Oxygen used up		Milligrams per litre present at end.	Milligrams in 2,800 c.c.	Milligrams used by Animals
(a) Control	...	7.42	20.78	—
(b) <i>Aplysia</i> (6 specimens)	...	7.48	20.94	0.16
(c) <i>Fusus</i>	...	6.63	18.56	2.22
(d) <i>Echinus</i>	...	7.33	20.52	0.26
(e) Cancer	...	1.07	2.99	17.79

TABLE II.—*Part 2*

Determinations at end of 19 hours

1. Dissolved Oxygen

	Milligrams per litre at end.	Milligrams in 2,800 c.c.	Milligrams used by Animals in 19 hours.
(a) Control	7.94	22.23	—
(b) Aplysia	6.37	17.84	4.39
(c) Fusus	2.75	7.70	14.53
(d) Echinus	6.76	18.93	3.30
(e) Cancer	0.98	2.74	19.49

2. Oxygen given out in form of Carbon dioxide

	Milligrams per litre.	Milligrams in 2,800 c.c.	Amount formed by Animals.	Respiratory Quotient.
(a) Control	2.2	6.16	—	—
(b) Aplysia	6.4	17.92	11.76	2.68
(c) Fusus	12.0	33.60	27.44	1.88
(d) Echinus	3.8	8.40	2.24	0.68
(e) Cancer	17.6	49.28	43.12	2.21

3. Ammonia excreted (a) Free and Saline, (b) Albuminoid

	FREE AND SALINE			ALBUMINOID		
	Mg. per litre.	Mg. Total.	Mg. excreted by Animals.	Mg. per litre.	Mg. Total.	Mg. excreted by Animals.
(a) Control	0.07	0.20	—	0.22	0.62	—
(b) Aplysia	0.16	0.45	0.25	0.54	1.51	0.89
(c) Fusus	0.87	2.44	2.24	1.10	3.08	2.46
(d) Echinus	0.14	0.39	0.19	0.35	0.98	0.36
(e) Cancer	0.11	0.31	0.11	0.49	1.32	0.70

4. Constants of Animals (weights, etc.) in grams

	Moist Weights.	Total Dry Weights.
(a) Control	—	—
(b) Aplysia	47.95	3.935
		Soft Parts + Skeleton.
(c) Fusus	249.80 (115 grams soft parts)	20.448 + 134.317
(d) Echinus	277.15	11.447 + 35.541
(e) Cancer	236.20	37.364 + 63.748

REMARKS.—(1) The most remarkable feature in this experiment is the great consumption of oxygen by the crustacean, as compared with the other types. Thus in the first four hours nearly 18 mgms. of oxygen are

used up, and the dissolved oxygen has been reduced to a very low level. In the remaining 15 hours, the available oxygen was so little that only 2·30 mgms. was used in this longer period, while the total output of oxygen as carbon dioxide for the nineteen hours was 43·12 mgms., or more than double the oxygen taken in during the same period. Similar results with another species of crab of smaller size are seen in the next experiment, and these findings seem to us of such importance that it is our intention to make a special and more detailed examination of the matter. Both animals, although very quiescent, were quite healthy at the end, and recovered and became quite active when placed in ordinary fresh oxygenated water. On account of the rapid fall in dissolved oxygen, it is probable that the 17·79 grams used up in the first four hours do not represent the full oxidation if the dissolved oxygen had not fallen, but taking them as a basis for calculation, the hourly requirement would be 4·45 mgms., and if the total plankton be again taken at 0·08 mgm. per litre, this would require 55 litres of water completely cleared per hour, or approximately 250 times the animal's own volume per hour. This would appear to demonstrate that such a type of animal can only live by the capture of food in other ways. (2) It is again to be noted that the animals add dissolved organic matter to the water in all cases, and that there is accordingly no evidence of consumption of dissolved organic matter by any of these types. (3) With the exception of *Echinus esculentus*, where the production of carbon dioxide and uptake of oxygen were both so small as to be liable to considerable experimental error, the oxygen given out as carbon dioxide is much higher than the oxygen intake from the water, so leading to such respiratory quotients as 1·88, 2·21, 2·68, the possible meaning of this peculiar respiratory phenomenon is discussed at the end of this section. (4) The greater output of albuminoid nitrogen in the case of *Fusus* is in all probability due to the large amount of mucin excreted by this type. (5) Calculations of the volumes of water containing the amount of organic matter as plankton required, on the basis of 0·2 mgm. per litre, yield the following results:—*Aplysia*, 3·7 litres per hour or 82 volumes per hour; *Fusus*, 10 litres per hour or 90 times volume of soft parts per hour; *Cancer* has already been given at 250 times its volume per hour. These values would appear too great to support purely plankton feeding.

EXPERIMENT IX. This experiment was carried out with Chamberland filtered water pumped from the supply to the Fish Hatchery. The details were as described under Experiments VII and VIII. The

experiment was commenced at 12 noon, April 21st, the first part of the experiment lasted $7\frac{1}{2}$ hours, the second $16\frac{1}{2}$ hours, making 24 hours in all. All the animals were alive at the end, at noon, April 22nd. The results are given in Table III.

TABLE III.—*Part 1*
Time-interval = $7\frac{1}{2}$ hours

Dissolved Oxygen used up

	Milligrams per litre.	Milligrams in 2,800 c.c.	Milligrams used by Animals.
(a) Control	7.64	21.39	—
(b) Fish (Blennius)	7.72	21.62	0.23
(c) Echinoderm (Asterias)	5.72	16.02	5.37
(d) Mollusc (Buccinum)	7.81	21.67	0.28
(e) Crustacean (Eupagurus)	2.75	7.70	13.69

TABLE III.—*Part 2*

Determinations at end of 24 hours

1. Dissolved Oxygen used up

	Milligrams per litre.	Milligrams in 2,800 c.c.	Milligrams used by Animals.
(a) Control	7.34	20.55	—
(b) Fish (Blennius)	3.98	11.14	9.41
(c) Echinoderm (Asterias)	1.22	3.42	17.13
(d) Mollusc (Buccinum)	5.79	16.21	4.34
(e) Crustacean (Eupagurus)	0.97	2.72	17.83

2. Oxygen given out as Carbon-dioxide

	Milligrams per litre.	Milligrams in 2,800 c.c.	Milligrams excreted by Animals.	Respiratory Quotient.
(a) Control	1.92	5.38	—	
(b) Fish (Blennius)	7.04	19.71	14.33	1.52
(c) Echinoderm (Asterias)	9.60	26.88	21.50	1.25
(d) Mollusc (Buccinum)	3.84	10.75	5.37	1.24
(e) Crustacean (Eupagurus)	8.96	25.09	19.71	1.11

3. Oxygen required to oxidize organic matter in water at end

	Milligrams per litre.	Milligrams in 2,800 c.c.	Milligrams added by Animals.
(a) Control	0.38	1.06	—
(b) Fish (Blennius)	1.32	3.70	2.64
(c) Echinoderm (Asterias)	1.52	4.26	3.20
(d) Mollusc (Buccinum)	2.00	5.60	4.54
(e) Crustacean (Eupagurus)	1.64	4.59	3.53

4. Ammonia excreted (*a*) Free and Saline, (*b*) Albuminoid

	Milligrams per litre.	FREE AND SALINE		Mg. excreted by Animals.
		Mg. in 2,800 c.c.	Mg. in 2,800 c.c.	
(<i>a</i>) Control	Nil	Nil	—	—
(<i>b</i>) Fish (Blennius)	0·07	0·20	0·20	0·20
(<i>c</i>) Echinoderm (Asterias)	0·20	0·56	0·56	0·56
(<i>d</i>) Mollusc (Buccinum)	0·02	0·06	0·06	0·06
(<i>e</i>) Crustacean (Eupagurus)	0·27	0·76	0·76	0·76

	Milligrams per litre.	ALBUMINOID		Mg. excreted by Animals.
		Mg. in 2,800 c.c.	Mg. in 2,800 c.c.	
(<i>a</i>) Control	0·05	0·14	—	—
(<i>b</i>) Fish (Blennius)	0·31	0·87	0·73	0·73
(<i>c</i>) Echinoderm (Asterias)	0·41	1·15	1·01	1·01
(<i>d</i>) Mollusc (Buccinum)	0·35	0·98	0·84	0·84
(<i>e</i>) Crustacean (Eupagurus)	0·37	1·04	0·90	0·90

5. Constants of animals (weights, etc.) in grams

	Moist Weights.		Dry Weights of Soft Parts.	
	Wt.	Wt.	Wt.	Wt.
(<i>a</i>) Control	—	—	—	—
(<i>b</i>) Fish (Blennius)	10·57	10·57	1·918	1·918
(<i>c</i>) Echinoderm (Asterias)	80·60	80·60	5·031	5·031
(<i>d</i>) Mollusc (Buccinum)	49·68*	49·68*	16·565	16·565
(<i>e</i>) Crustacean (Eupagurus)	34·34*	34·34*	4·046	4·046

	Wt. of Dried Skeleton.		Organic Matter in Skeleton.		Ash in Skeleton.	
	Wt.	Wt.	Wt.	Wt.	Wt.	Wt.
(<i>a</i>) Control	—	—	—	—	—	—
(<i>b</i>) Fish (Blennius)	1·486	1·486	1·151	1·151	0·335	0·335
(<i>c</i>) Echinoderm (Asterias)	10·129	10·129	4·024	4·024	6·105	6·105
(<i>d</i>) Mollusc (Buccinum)	37·332	37·332	—	—	—	—
(<i>e</i>) Crustacean (Eupagurus)	5·757	5·757	—	—	—	—

*In each case without shell, the Mollusc shell weighed 56·88 grams, the shell inhabited by the Hermit crab was not weighed.

TABLE IV

TEMPERATURE OF SEA AND AIR DURING EXPERIMENTS OF SECTION B.

	Sea.	Air.		Sea.	Air.
April 16th, 1912—			April 18th, 1912—		
Morning	8·0° C.	8·3° C.	Morning ...	8·0° C.	8·6° C.
Afternoon ...	8·6° C.	11·4° C.	Afternoon ...	8·6° C.	9·4° C.
April 17th, 1912—			April 19th, 1912—		
Morning ...	8·0° C.	8·0° C.	Morning ...	8·3° C.	9·0° C.
Afternoon ...	8·6° C.	10·0° C.	Afternoon ...	8·3° C.	10·8° C.
			Sea.	Air.	
April 20th, 1912—					
Morning ...	8·0° C.	9·4° C.			
Afternoon ...	8·0° C.	11·6° C.			

TABLE V

COMPOSITION OF THE SOFT PARTS OF CERTAIN OF THE ANIMALS USED IN SECTION B.

After removal of the skeleton the soft parts were dried and the percentage of mineral matter and of organic matter, and in the latter of fat and protein were determined. It was found impossible without a great expenditure of labour to estimate carbohydrates on account of the interference of the proteins. All figures are in percentages of total dried weights, it may be especially emphasized that this is so in the case of fat and protein which are not percentages of the organic matter. Attention may be called to the high percentage of inorganic matter even in the soft parts of these animals. Fat means total ethereal extract, and proteins were obtained by estimating the total nitrogen by Kjeldahl's method and multiplying by the factor 6·25.

	Ash.	Organic Matter.	Fat.	Protein.
Sponge	59·54	40·46	2·75	18·8
Ascidians	46·43	53·57	2·35	28·8
Aplysia	28·58	72·42	2·87	37·0
Fusus	12·49	87·51	8·47	52·6
Echinus	60·75	39·25	1·95	7·8
Cancer	10·06	89·94	14·06	50·7

THE RESPIRATORY QUOTIENT IN INVERTEBRATES

In nearly all the cases shown in the tables above, the respiratory quotient is greater than unity; that is to say, the volume of carbon-dioxide produced is greater than that of the oxygen used up. In many cases the over-production of carbon-dioxide is very marked, and in the case of the two crustaceans in the later stages of the experiment, scarcely any oxygen is taken up, while a considerable evolution of carbon-dioxide continues.

Such a process is also found in the ripening processes of seeds and fruits, and has been observed in animals well fed with carbohydrates which are in process of fattening.

A respiratory quotient greater than unity is impossible if complete oxidation of foodstuffs takes place, and such a quotient is an indication of the linking together of a reducing and an oxidizing agency, whereby a smaller quantity of a substance of higher chemical energy potential is formed, so setting free oxygen which is used in oxidizing more material, as a result of which energy for the use of the organism is set free without any intake of oxygen.

If carbohydrate be completely oxidized, since hydrogen and oxygen are present in the proportions to form water, a volume of carbon-dioxide is set free exactly equal to that of the oxygen used for combustion, so that the respiratory quotient is unity.

If fat be completely oxidized, since there is a large excess of hydrogen, this uses up a great deal of oxygen which appears as the end-product, water, and as a result the carbon-dioxide formed is considerably less than the oxygen used. As a result, the respiratory quotient falls to 0.5, or even less. Proteins lie intermediately, but much nearer to the carbohydrate, as there is very little hydrogen excess.

As the energy yielded weight for weight by hydrogen in undergoing combustion is much higher than that given by carbon, it follows that the heat value of the fats is much greater than that of the carbohydrates or proteins for equal weights.

In the building up of fats, proteins or carbohydrates in the organism, these processes are reversed, and, if, as commonly happens, fat is synthesized from carbohydrate, twice the weight of carbohydrate at least must be used up to yield a given weight of fat. The process is one of reduction, and if the end members of the molecular groupings be neglected, the carbon atom of the carbohydrate may be represented as

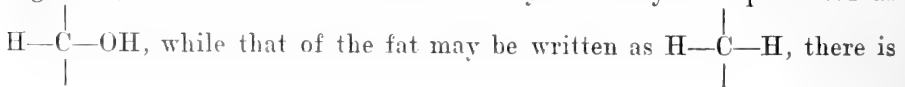

hence an atom of oxygen set free from each carbon atom, which may be utilized to oxidize carbon down to carbon-dioxide in another carbohydrate molecule, and so yield energy for the formation of the fat. If this process be aided by a little oxygen from outside, still more carbohydrate may be oxidized, and the net result is that the exo-thermic or carbohydrate oxidizing reaction runs the endo-thermic or fat synthesizing reaction, and a surplus of energy is left over for the uses of the animal.

When such a linkage of reactions has occurred, the respiratory quotient may much exceed unity in value, and there is no doubt that, even in mammalia, when fat is being produced from carbohydrate, such a condition of affairs does arise.

It was observed by Gautier,¹ in 1881, that even warm-blooded animals lived in part in an anaerobic fashion, producing carbon-dioxide without equivalent uptake of oxygen, so obtaining a portion of oxygen not from the air but by fermentative processes from oxygen-containing organic bodies. Gautier also indicated that a portion of such oxygen might arise from fat formation from carbohydrate.

Hanriot,² in 1892, showed that after heavy meals of carbohydrate the respiratory quotient might rise as high as 1.30, and attributed this to conversion of carbohydrate into fat. Hanriot illustrates how such an effect might arise by the equation:—

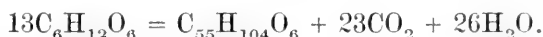

In this equation the formula $\text{C}_{55}\text{H}_{104}\text{O}_6$ represents a neutral fat containing one molecule each of oleic, palmitic and stearic acid.

Thus Hanriot was the first observer clearly to put forward the view mentioned above in explanation of respiratory quotients greater than unity.

In the course of work somewhat similar to our own, upon the respiration of invertebrates, Vernon³ found respiratory quotients greater than unity, and also, like us, found that certain of these animals could continue living with a very minimal oxygen supply, and during this period produced large amounts of carbon-dioxide, so that the respiratory quotient in one case rose to over four.

Vernon attempted to drive all the carbon-dioxide out of the water by heating in a vacuum, and as completeness here is almost impossible,

1. *Comptes rendus* CXIV, p. 374, 1892.

2. *Ibid.*, p. 371.

3. *Journ. of Physiol.*, XIX, p. 18, 1895.

it is probable that his results ought to be even higher than they are. Vernon ascribes his results to the animals being in a pathological condition and moribund, but since, like our own, most of them recovered when fresh oxygen was admitted we scarcely can agree in this view. Also, in our case we have obtained similar results long before there was any real dearth of oxygen in the water.

Athanasiu,¹ in 1900, found a mean respiratory quotient of 1.24 in frogs, which were not feeding during the experiments, and concluded that frogs stored up oxygen in their tissues for use during such a period of hibernation.

Pembrey,² on the other hand, found an exceedingly low respiratory quotient in the hibernating marmot, but a quotient of well over unity (viz., 1.24, 1.28, and 1.39) during the feeding and fat-storing period in the same animal.

Pembrey agrees with Hanriot as to the explanation being the conversion of carbohydrate into fat.

It is somewhat difficult to believe that fat storage can occur during starvation, except for a short period, and it may be that the real explanation in our own experiments may be as suggested by Athanasiu, some oxygen storage in the tissues in some form at present unknown to us. Certainly the amounts of fat present at the end, as shown by Table VI, are not very high; and this, so far as it goes, indicates that either some reduced substances other than fat were formed, or that there is normally a storage of oxygen in some organic form which was utilized during the period of experiment.

Similar results were obtained by Pütter,³ by keeping leeches in an atmosphere free from oxygen. This observer traces the results to the substitution of hydrolytic cleavages for oxidations, but the amount of energy obtainable in this way is very small.

Granting, however, that such a linkage of reactions can occur, as is premised above, then the effect might be shown by such an equation as the following:—

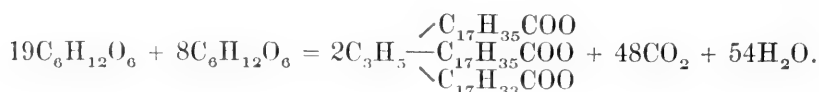

1. *Journ. de Physiol. et de Path. gen.*, II, p. 243, 1900.

2. *Journ. of Physiol.*, Vol. XXVII, p. 407, 1902.

3. *Zeitsch. f. allgem. Physiol.*, Bd. VII.

The two amounts of carbohydrate on the left-hand side are written separately to indicate that nineteen molecules go to form the two molecules of neutral fat shown on the right-hand side, while the eight additional molecules are completely oxidized in combination with the oxygen set free in the fat formation to form carbon-dioxide and water, so yielding more than enough energy to run the reaction exo-thermically.

The weight of carbohydrate expressed in gramme-molecular weights is 4,860 grammes, the weight of fat formed is 1,776 grammes, carbon-dioxide is 2,112 grammes, and water 972 grammes.

Taking the relative caloric values of fat and carbohydrate as 9 to 4, the 1,776 grammes of fat are equivalent in energy to 3,996 grammes of carbohydrate, and subtracting this from the original weight there is the energy of 864 grammes of carbohydrate to run the reaction exo-thermically, or about 32,000 large calories.

This may be stated otherwise thus:—Without any oxygen from without, carbohydrate can yield about one-third of its weight of fat, and at the same time yield a supply of energy equivalent to about one-sixth of that total amount which it would yield if directly and completely combusted to carbon-dioxide and water.

A parallel case of utilization of carbohydrate energy by partial reduction and partial oxidation, linked together by the agency of a living cell, is the formation of alcohol from glucose by the yeast cell.

All degrees between these two cases (where the respiratory quotient is, of course, infinity) and those exemplified above in invertebrate animals with respiratory quotients lying between 1 and 2, can be obtained by varying intakes of oxygen.

If, for example, in the above equation eight gramme molecules more of carbohydrate were taken in on the left-hand side, and forty-eight gramme molecules of oxygen for their complete oxidation, there would then appear a total of ninety-six gramme molecules of carbon-dioxide on the right-hand side, and the carbohydrate would now yield only about one-fourth of its weight for storage as fat. Under such conditions the respiratory quotient would be 2 exactly, and there would be a large amount of energy for heat and external work.

It is most interesting to note that these considerations indicate fat formation in the tissues under conditions of diminished oxidation, which is in accord with physiological facts.

An animal with a rich reserve of carbohydrate might also actually increase its fat content during inanition and inactivity, for a short period, until carbohydrate became exhausted. Such a process as this actually does occur in the ripening of many fatty seeds.

Our thanks are due to Mr. A. Webster for much valuable assistance in the practical work, and especially for the determinations contained in Table V.

THE EFFECTS OF ATMOSPHERES ENRICHED WITH OXYGEN
UPON LIVING ORGANISMS, (a) EFFECTS UPON MICRO-
ORGANISMS, (b) EFFECTS UPON MAMMALS EXPERI-
MENTALLY INOCULATED WITH TUBERCULOSIS, (c)
EFFECTS UPON THE LUNGS OF MAMMALS, OR OXYGEN
PNEUMONIA

By ALFRED ADAMS, M.B., Ch.B. (Liverpool).

From the Bio-Chemical Laboratory, University of Liverpool

(Received May 22nd, 1912)

SECTION A. THE ACTION OF OXYGEN UPON MICRO-ORGANISMS

In the course of two previous investigations, published by Moore and Williams¹, in 1909 and 1910, it was shown that while certain micro-organisms are indifferent to amounts of oxygen lying between the atmospheric value and a full atmosphere of oxygen at ordinary barometric pressure, others, notably *Bacillus tuberculosis* and *Bacillus pestis*, are very sensitive to oxygen, and cease to grow when the percentage of oxygen exceeds about seventy per cent. of 760 millimetres.

It is remarkable how few organisms show this oxyphobic property, and how specific and definite the effect is when the property is present.

Out of twenty-six various organisms tested in a partial pressure of oxygen of 500 millimetres of mercury and over, only two showed complete stoppage of growth, viz., the bacilli of plague and tuberculosis, while those of the staphylococcic group were adversely affected and grew less rapidly than normally, and on some occasions failed to grow entirely, viz., *Staphylococcus pyogenes aureus*, and *albus*. All the remaining twenty-two organisms grew as well, so far as could be observed, in the increased oxygen as in air.

In the present investigation, these experiments have been repeated and amplified, and two additional and interesting members have been added to the oxyphobic group, namely, actinomyces and mycetoma from the streptothrix family.

1. *Bio-Chemical Journal*, Vol. IV, p. 177, 1909; Vol. V, p. 181, 1910.

It was noticed by Moore and Williams that *B. pestis* was only arrested but not killed by exposure to the oxygen, for although no growth developed after some days' keeping in the enriched atmosphere, on afterwards transferring to ordinary air a good growth soon appeared. On the other hand, these observers found it impossible to revivify or sub-culture from *B. tuberculosis* which had been kept for a period of from two to three weeks in an atmosphere of 70 per cent. of oxygen, or over that amount.

In the present work it has been found that *B. tuberculosis*, while arrested completely in oxygen as they described, was found to grow again when transferred to air, as shown below. It was found in confirmation of their work that *B. pestis* was completely arrested during a stay in the oxygen-enriched air, but commenced to grow again as soon as the culture tubes were replaced in ordinary air.

It was otherwise, however, with the streptothrix organisms, which, in both instances, failed to grow again after exposure to the higher percentage of oxygen.

All experiments were carried out at atmospheric pressure of the total gases, the partial pressure of the oxygen being increased by complete or partial evacuation of the bell-jar under which the tubes containing the culture tubes were placed, so as to get varying percentages of oxygen.

The oxygen used was prepared most carefully in the laboratory from potassium permanganate, as the gas sold in the usual cylinders is contaminated with a good deal of nitrogen. It was most carefully washed, and stored until required in a large gas holder capable of holding about 100 litres.

The tubes with the cultures to be exposed to additional oxygen were placed in a large bell-jar fitting on to a ground glass-plate, and it was found necessary, on account of the long duration of each experiment, to prevent slow leakage by a mercury trap outside the flange of the bell-jar. The mercury was held in position by a circular mound of putty, and no mercury penetrated under the bell-jar. The bell-jar was evacuated after placing the desired inoculated culture tubes within, and then oxygen to the desired amount was allowed to enter, and analyses of the percentages of oxygen at beginning and end of the experiment were carried out by the usual gas analysis methods.

The control tubes were kept under similar conditions under a like bell-jar but in ordinary air, and both bell-jars were placed alongside of each other in the same incubator at 37° C.

The enriched oxygen atmosphere was entirely without effect on the following organisms:—

Bacillus coli communis	Bacillus pyocyaneus
„ typhosus	„ of hog cholera
„ dysenteriae (Flexner)	„ diphtheriae
„ „ (Kruse)	„ anthracis
„ mallei	Vibrio cholerae
„ gaertner	Sarcina lutea
„ prodigiosus	„ aurentiaca
„ pneumoniae	Oidium albicans
	Proteus vulgaris

The staphylococcic group showed very fair growth, but not so marked as in the controls. The results with *B. pestis* were as stated above. *B. tuberculosis* showed a very small but definite growth at the end of a prolonged experiment lasting seven weeks. The organism was not killed but only inhibited by its treatment, and was able on further incubation in air to overcome to a slight degree the adverse circumstances under which it had been placed, and sub-cultures then made from it developed normally.

Actinomyces and mycetoma, on the other hand, were not only inhibited but killed, no growths appearing after the oxygen treatment.

These results are shown in the following protocols:—

Experiments I, II and III.—Six tubes of Glycerin-acid-agar were inoculated with a laboratory strain of Bacillus Tuberculosis (Human), and three were placed in an atmosphere of 90 per cent. of oxygen and the controls in the air chamber.

Results:—At the end of three weeks' incubation of the two sets under similar conditions, the three controls showed good growths and the tubes in oxygen, in which the percentage had diminished to 70 per cent., showed no appreciable growth.

The tubes were replaced in the oxygen chamber with oxygen of 85 per cent. strength and incubated for a further four weeks, when the oxygen had diminished to 68 per cent., and there was an appreciable amount of growth. The oxygen was renewed and incubation continued for a further two weeks, when the growth was about equal in amount to the growth at the end of three weeks only in the control tubes, but it was of a dark brown colour and consisted of raised discrete masses differing from the uniform growth in the controls.

One of the tubes was continued in the oxygen and three weeks later showed a very slight increase in growth of the same character.

Another was placed in the air bell-jar, and after three weeks showed a much more profuse growth, but still of the dark brown colour.

The remaining tube was sub-cultured, and incubated in the ordinary manner, and three weeks later, growths, normal in colour and other respects, were obtained.

Specimens from the various tubes were now stained and submitted to microscopical examination, but no appreciable difference could be discovered in the smears.

These results were confirmed later in all respects by two additional similar experiments.

Experiments IV and V.—Three agar tubes were inoculated with each of two different strains of actinomyces, and two tubes of each strain were placed in the oxygen chamber, which was then filled with oxygen and the percentage determined, and found to be 87 per cent. The remaining tubes were placed as controls in the air chamber.

After four days' incubation the control tubes showed a slight growth as minute white specks, whilst the tubes in oxygen showed no growth. The tubes were replaced in their respective chambers, and seven days later again examined, when the controls showed a good growth. There was no trace of growth in the tubes kept in oxygen.

A further seven days' incubation in the oxygen chamber was tried, without any trace of growth, and the tubes were then transferred to the ordinary incubator. Fourteen days subsequently there was no trace of growth in either of them.

This experiment was again repeated, with similar results throughout.

Experiments VI and VII.—Three agar tubes were inoculated with mycetoma from the original strain, and two of these were placed in the oxygen chamber, and one in the air chamber for control. Seven days later, on careful examination, the control tubes showed a growth, but the tubes in oxygen showed no trace of growth. After incubation for an additional seven days, under the same conditions, they were again examined, and the controls showed a good growth, while again the tubes in oxygen gave no growth.

This was repeated for a third week with a like result, and the oxygen tubes were then transferred to the ordinary incubator and examined fourteen days later, when no evidence of growth could be found in the tubes.

This experiment was then repeated twice with similar results.

It having been suggested to me by Professor B. Moore that the inhibiting effect of the oxygen on the *Bacillus tuberculosis* in vitro, as well as the well-known effects of fresh air on tubercular patients, might be due to the presence of traces of oxides of nitrogen in the atmosphere, the following experiments were carried out.

Experiment VIII.—Suitable culture media, in tubes as for the previous experiments, were inoculated with the following organisms:—

<i>Bacillus tuberculosis</i>	<i>Actinomyces</i>
„ <i>pestis</i>	<i>Mycetoma</i>
„ <i>typhosus</i>	<i>Pneumococcus</i>
„ <i>diphtheriae</i>	<i>Staphylococcus aureus</i>
„ <i>coli communis</i>	<i>Streptococcus pyogenes</i>
„ <i>anthracis</i>	<i>Staphylococcus albus</i>

The tubes to be tested were placed in a similar bell-jar to that used in the previous experiments, and this was exhausted to a pressure of ten millimetres of mercury. A sufficient quantity of nitric oxide gas, was prepared by action of nitric acid on copper, and washed and found to contain 90 per cent. of nitric oxide, was added so as to form 0.5 per cent. of the total capacity of the jar. Atmospheric air was now admitted, thus ensuring the entrance of the nitric oxide dilution into the tubes, and the jar was placed in the incubator, accompanied by the controls in a similar jar, but containing only atmospheric air.

Twenty-four hours later there was no appreciable difference in the results obtained from the two sets of tubes.

The incubation was repeated for one week, when there was no apparent difference between the controls and those tested, and at the expiration of three weeks the tubes containing the more slowly growing organisms, viz., *Bacillus tuberculosis*, *Actinomyces*, and *Mycetoma*, were identical in amount of growth.

Experiment IX.—The following organisms were inoculated on suitable media, viz.:—

<i>Bacillus coli communis</i>	<i>Bacillus diphtheriae</i>
„ <i>typhosus</i>	„ <i>anthracis</i>
„ <i>dysenteriae</i> (Flexner)	„ <i>pestis</i>
„ „ (Kruse)	<i>Staphylococcus pyogenes aureus</i>
„ <i>mallei</i>	„ „ <i>albus</i>
„ <i>gaertner</i>	„ „ <i>citreus</i>
„ <i>prodigiosus</i>	<i>Vibrio cholera</i>
„ <i>pneumoniae</i>	<i>Sarcina lutea</i>
„ <i>pyocyaneus</i>	„ <i>aurentiaca</i>
<i>Proteus vulgaris</i>	<i>Oidium albicans</i>

One set of the inoculated culture tubes was placed in the oxygen chamber, and by evacuation and introduction of oxygen the oxygen concentration was raised to 90 per cent. A series of controls in the ordinary air bell-jar in the same incubator were compared at the expiration of twenty-four hours with the tubes being tested in the oxygen. On examination, *Bacillus pestis* showed no growth on the oxygen tube, while the control tube showed a commencing growth, and two days later the control showed a good growth but the oxygen tube showed nothing.

Staphylococcus pyogenes aureus on the oxygen tube gave a very minute growth, while the *S. albus* and *S. citreus* showed no growth. All three of the controls of the staphylococci gave good growths.

All the remaining organisms gave practically identical growths on the oxygen and control tubes.

The tubes of the *Bacillus pestis* and the staphylococci were replaced, and again examined in a further forty-eight hours, when the staphylococcus tubes all showed growth, but definitely less in those exposed to the oxygen than in the controls. The *B. pestis* was quite free of growth in the oxygen tube, the control showed good growth.

CONCLUSIONS

1. That the action of oxygen in increased percentages on the *Bacillus tuberculosis* is to arrest its growth, but the action is not bactericidal but inhibitory, as in the case of those other oxyphobic micro-organisms, *Bacillus pestis*, and in a lesser degree the members of the staphylococci group.

2. That an atmosphere enriched with oxygen not only arrests the growth of actinomyces and mycetoma but kills these organisms. This may be the explanation of the differences in the literature as to the description of actinomyces, which some authors describe as aerobic, while others state that it is anaerobic. The probability is that it lies on the border line; a small increase in oxygen turns the scale and prevents its growth.

3. That the action of the oxygen is not due to oxides of nitrogen contained as an atmospheric impurity is shown by Experiment VIII.

SECTION B. EXPERIMENTS UPON MAMMALS EXPERIMENTALLY INOCULATED WITH TUBERCULOSIS

The effects of oxygen in stopping the growth of the *Bacillus tuberculosis* obviously suggests an attempt at treatment of the disease by respiration of oxygen, and with this object in view Moore administered oxygen of about 80 per cent. at ordinary atmospheric pressure to three patients with pulmonary tuberculosis for one hour daily over a period of some weeks. The oxygen inhalation was enjoyed by the patients, but did not show any clear effect upon the course of the disease.

It was thought that an extension of the period of oxygen administration, by keeping animals for a prolonged period in oxygen in a respiratory chamber, might have an effect, and accordingly guinea-pigs were introduced into the chamber described below after subcutaneous inoculation with a strain of *Bacillus tuberculosis*, and retained there for some days.

Unfortunately it was found that with the more prolonged periods in oxygen, that peculiar form of simple exudative pneumonia, which has been termed oxygen pneumonia, made its appearance when over 70 per cent. of oxygen was employed, and below this level no action on the development of the bacilli as shown by arrest of the tubercles was obtainable.

The lung effects are described in Section C. For the sake of completeness, the history of the inoculation experiments is here recorded.

A suitable dose for inoculation which would show definite pathological lesions in a guinea-pig in a reasonable time was determined after a considerable number of experiments with various strains. This dose ranged from 0.1 to 10 milligrams, according to the virulence of the particular strain, and was so selected that definite and fairly advanced lesions appeared in about six weeks. The injections were made subcutaneously in the thigh. A number of animals were inoculated at the same time, and of these a portion were kept in the animal house as controls, while the rest were placed in the oxygen respiratory chamber.

The oxygen used was prepared by heating permanganate of potassium in an iron retort. After all the air had been expelled, and a steady stream of oxygen was coming off, this was conveyed through wash-bottles into a gasometer of a capacity of 100 litres, with suspension weights so adjusted that there was a constant pressure sufficient to cause the gas to bubble through a wash-bottle placed between the gasometer and the

respiratory chamber, where it was stored for use, a sufficient quantity for four or five days being made at once.

By this means an oxygen of a strength of 95 to 96 per cent. was obtained, the remaining 4 to 5 per cent. consisting of nitrogen. The solid and soluble impurities were removed by the washing process.

The respiratory chamber used consisted of a cylindrical vessel (see fig. 1) made of galvanized iron, with a conical bottom ending in a

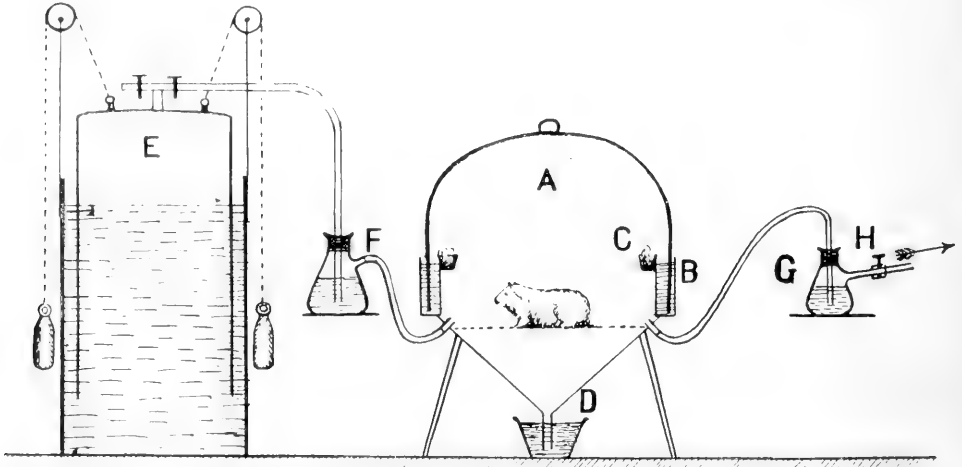

A Respiration Chamber. B Water Seal. C Soda Lime Tray. D Excreta Outlet. E Gasometer. F Wash Bottle. G Indicator Wash Bottle. H Outlet to Vacuum Pump.

rubber tube which dipped into a vessel of water for about three centimetres, and served to convey away the urine. Its roof was formed by a glass dome,¹ made airtight by a circular water-seal in the tinware under-portion. This dome was about fifteen centimetres in diameter, and through it the animals could be observed during the experiments. The capacity of the chamber was about forty litres.

The animals rested on a floor formed by a perforated zinc plate, and suspended round the chamber was an annular gallery filled with soda lime, of which it contained about 500 grams when loosely charged. The inlet and outlet for the gases to the chamber were situated just above the floor, the former attached by indiarubber tubing to the wash-bottle from the gasometer, and the latter to a small vacuum pump, with a thumb-screw on the tube by which the flow could be easily regulated, and a small wash-bottle served as an indicator of the rate of flow.

1. The glass-cover was such as are made for protecting memorial flower wreaths.

The inoculated guinea-pigs were placed in this chamber, with an adequate supply of food for three days. Three pigs were used at each test, it being found impossible to store food for more for the required time in the chamber, owing to their increased appetites, due possibly to the raised oxygen percentage. The outlet was then attached to the vacuum pump and the inlet to the oxygen container and the chamber flooded with oxygen until the required percentage was obtained, as shown by analysis.

Specimens of the gas were obtained by disconnecting between the vacuum pump and the wash-bottle indicator, and tested in Hempel's bulbs for carbon-dioxide and oxygen. Once the required concentration was reached, it was found that a flow of about twenty bubbles per minute from a drawn-out tube of about one millimetre diameter through the wash-bottle was sufficient to preserve the standard. This outflow is necessary because it is impossible to prepare oxygen quite free from nitrogen in such large quantities.

Specimens of the gas were taken morning and evening for the first week, and later daily, and by regulating the thumbscrew on the exhaust, it was found that fairly constant oxygen percentage could be retained, the variation not exceeding five to ten per cent. over the periods between the changing of the food supply. The carbon-dioxide percentage with fresh soda-lime did not rise above three per cent. and was usually much lower. Any excess over this showed the necessity of a fresh supply of the absorbent.

At the end of each period of three days, the chamber was cleaned out and the food supply renewed. It was found advisable on each occasion to wash it out thoroughly with a dilute solution of Lysol, and the use of this preparation on the glass dome was most advantageous in preventing condensation of moisture in drops, thereby obscuring vision.

The controls and the animals undergoing the tests received alike the same food. Bran moistened with boiling water, carrots, and straw were the staple articles of diet.

The percentage of oxygen used in the tests was regulated by the amount the animals were able to bear. It was found, as already stated, that a continuous exposure for prolonged periods to a concentration greater than 70 per cent. caused death by pneumonia. Below this strength the animals seemed to be very little affected by their surroundings; the only observable difference being that they ate much more greedily, and on increasing the concentration they were for a time much more lively, but soon settled down to their normal condition again. The sudden increase

from the normal atmospheric percentage of oxygen to the increased concentration used, showed no ill effects, and on opening the chamber for cleansing purposes, the guinea-pigs, after their three days in the stronger oxygen, seemed unaffected by the change back to atmospheric air, and greedily attacked the fresh food supplied to them.

Experiment X.—A number of guinea-pigs were inoculated with a virulent strain of *Bacillus tuberculosis* (Human) under the skin of the thigh. Three, weighing together 1230 grams, were placed in the respiration apparatus, and the oxygen passed in until a sample of the gas withdrawn at the exhaust showed a strength of oxygen of 64 per cent. The thumbscrew on the exhaust was then screwed down so as to allow only a small bubble at a time to pass. The suspension weight on the gasometer was so regulated for this purpose, that the water-seal round the glass dome showed the water to be about one centimetre lower inside the dome than outside.

The remaining guinea-pigs were placed as controls in the ordinary animal house.

Next morning an analysis of the gas gave Carbon dioxide, nil; Oxygen, 60 per cent.

The current from the exhaust was slightly increased, and two days later an analysis gave Carbon-dioxide, 1·4 per cent.; Oxygen, 59 per cent.

The weight of the guinea-pigs on taking out showed an increase to 1,345 grams. They were again placed in the oxygen chamber, and the oxygen percentage raised to 66 per cent. The gas analysis next day gave Carbon-dioxide, 0·8 per cent.; Oxygen, 60 per cent.

The succeeding day, the percentages were Carbon-dioxide, 1·2 per cent.; Oxygen, 61·0 per cent.

The chamber was again cleansed next morning and the experiment restarted. This course of treatment was continued during the whole period with short intermissions for cleansing, the percentage of oxygen not rising above 68 per cent. or falling below 50 per cent., and the Carbon dioxide not rising above 2·8 per cent. on any occasion.

During the third week one of the guinea-pigs in the chamber died of natural causes. Small glands in the groin were found, post mortem, also *Bacillus tuberculosis* at the site of inoculation.

The lungs were healthy. This animal was replaced by one of the controls in the latter part of the experiment.

At the end of the fifth week, the guinea-pigs were showing signs of

loss of weight, and were killed and examined and compared with the controls kept in the animal house.

All three animals kept in the oxygen chamber showed definite tubercular lesions, consisting, in two cases, of sinuses discharging pus, enlarged caseating glands in the groins and axillae, and general emaciation. The controls also showed definite lesions of a similar character.

No definite difference could be observed between the stages of the lesions in the controls and treated guinea-pigs, and it was impossible to say that either was the more advanced or serious.

A number of other experiments were carried out under the same conditions, but none were continued for so prolonged a period, owing, usually, to accidental death of the tested animals, but all the results pointed to the same conclusions.

CONCLUSIONS

1. That the inhibiting effect of the increased oxygen percentage on the growth of the *Bacillus tuberculosis* in vitro cannot be extended to treatment in vivo.

2. That the beneficial effects of fresh air and ventilation on strumous diseases are not due to the small increase of oxygen over that of the interiors of dwellings, or to any chemical condition of the air, but rather to some physical stimulus.

SECTION C. ACTION UPON THE MAMMALIAN LUNG OR OXYGEN PNEUMONIA

As stated in the previous section, it was found that while oxygen up to a partial pressure of about 500 millimetres of mercury could be readily tolerated for days together without any observable ill effects, a slight increase to about 550 millimetres always led to the animals perishing from a condition resembling lobar pneumonia. The limit bearable without injury for prolonged periods thus lies just below seventy per cent. of oxygen in an atmosphere at 760 millimetres of total pressure.

This pneumonic effect has been observed by several previous observers, but in most cases it has been studied in cases where the total pressure has been raised to many atmospheres, and the duration of the experiment has been a short one.

As the subject has some importance now that oxygen is becoming popular in the treatment of disease, and also has relationship to caisson work, rescue work with oxygen apparatus where oxygen may be breathed for long intervals and similar uses of the gas for respiration in confined or vitiated spaces, it was determined to experiment more fully and find the limits of causation, show freedom from any bacterial causation, and obtain micro-photographs showing the nature of the lesions and the minute pathology. It was found by several observers in early days after the isolation of oxygen that respiration of the gas produced inflammatory effects. The respiration and circulation were both found to be increased, in time the lungs became congested, and in certain cases inflammation and death occurred. The adherents of the school of Lavoisier set these effects down to the effects of increased pulmonary combustion, but this was controverted by Regnault and Reiset, who showed that no increased oxidation took place. It was Bert who introduced the fact that the pathological effects due to high pressures were dependent on the partial pressure of the oxygen only, by demonstrating that as much effect was obtained with four atmospheres of pure oxygen as with twenty atmospheres of compressed atmospheric air.

Bert worked chiefly with very high pressures, and found that these induced a status epilepticus in birds, and also in mammals at a higher pressure. He compared the effect to that of tetanus or strychnine poisoning, and thought it due to a toxic action on the nervous system either directly by the oxygen or indirectly by some nerve intoxicant formed by the action of the oxygen on the blood. The symptoms persisted for hours after brief exposures to high oxygen pressures, the animals remaining in an epileptic condition and having fits of tetanic nature at short intervals. Blood transfused from such animals did not, however, induce the condition in normal animals.

The animals in Bert's experiments succumbed to the nervous effects before the lungs became pneumonic, and he does not appear to have investigated the effects of lower concentrations of oxygen acting for longer periods. After a considerable interval, this was taken up by Lorrain Smith¹, who also worked with a pressure chamber, but used much lower pressures than Bert. In Bert's experiments the convulsions occurred at about 3 atmospheres of oxygen with birds, and 4 atmospheres with dogs; in Lorrain Smith's work while some experiments were carried

1. *Journal of Physiology*, Vol. XXIV, p. 19, 1899. We are also indebted to this paper for the materials for the brief resumé of the literature given above.

out at 3 atmospheres or slightly higher, the greater number were carried out at a level lying between 1 and 2 atmospheres of oxygen, and two were performed at pressures between 70 and 80 per cent. of an atmosphere of oxygen.

An important point made out by Lorrain Smith was that previous exposure to an intermediate pressure (1.4 atmosphere) acted to a certain extent as a preservative against the onset of convulsions, which did not occur at the later stage until a higher concentration for a longer interval. This is ascribed by Lorrain Smith to the previous lower exposure reducing or upsetting the normal secretory activity of the lung epithelium, which when uninjured causes the blood to be more highly and rapidly charged with oxygen.

In the first experiment recorded by Lorrain Smith, the percentage of oxygen was only 41.6 of an atmosphere, and this caused no injury within eight days, our own results confirm this finding. In his second and third experiments the percentages were 73.6 and 79.9 respectively. In each two mice were employed, and in each one succumbed in four days with more or less marked congestion of the lungs, while two of the animals survived for a week.

All the other experiments recorded in Lorrain Smith's paper are with amounts of over an atmosphere of oxygen, and more results seemed to us desirable between 70 per cent. and one atmosphere of oxygen.

The fact of working with a small pressure chamber precluded also the use of large animals, and with the exception of one short experiment at a fairly high pressure on a guinea-pig, and a brief one on a rat, all the experiments recorded by Lorrain Smith were made upon mice or small birds.

The pneumonia produced in these experiments with over one atmosphere of oxygen pressure, as described by Lorrain Smith, was identical with that described in this paper. Bacteria in many cases were entirely absent. The alveoli were filled with an exudate which was granular and fibrillated in appearance, but did not give the fibrin test by Weigert's method. There were no leucocytes in the exudate. The pneumonic condition was universal, and could be compared only with the earliest stages of catarrhal pneumonia.

The onset of the pneumonia and time of death, varied with the percentage of oxygen, as stated above in his two experiments with between 70 and 80 per cent., death occurred, in two cases out of four only, in 4 days; at 120 to 130 per cent., sluggish in 48 hours and found dead

at 90 hours, lungs pneumonic; at 128·9 per cent., sluggish in 48 hours, died in about 69, lungs congested and consolidated; at 129·7 per cent., dead in 40 hours, similar appearances; at 114 per cent., dead in 60 hours, consolidated lungs; at 182·9 per cent., one death in 23 and one in 27 hours; at 176·6 per cent., deaths within 24 hours; at 188·5 per cent., death in 7 hours; at 285 per cent. death in 8 $\frac{3}{4}$ hours; at 357 per cent., death in 5 hours with the characteristic consolidation and congestion of the lungs.

The filling of the lungs with exudate in such a short interval as five hours appears to us to be a most remarkable and interesting result, and seems to point to the exudate being a kind of pathological secretion by the lung epithelium, rather than an irritative exudation due to injury of that epithelium.

Observations have also been made by Leonard Hill¹ and J. J. R. Macleod showing that prolonged exposure of mice to a partial pressure of oxygen amounting to 70 to 80 per cent. of an atmosphere produces inflammation of the lungs, but 80 to 90 per cent. of oxygen used for two hours or more with the Fleuss rescue apparatus by miners in training for rescue work produced no ill results whatever. This has also been our own experience in this laboratory, in breathing oxygen of 80 to 90 per cent. from a large gas-holder before giving it to patients as mentioned above. The carbon-dioxide was fully taken up by a series of four annular trays in the lower part of the gas-holder, into and out of which the patient breathed by a very wide tube without the interposition of any valves, and no inconvenience whatever was ever experienced.

In the experiments here to be recorded with guinea-pigs, no total pressure greater than atmospheric was used throughout, the animals had plenty of food in a large respiration chamber sufficiently roomy for them to move about, the carbon-dioxide was efficiently removed by the soda-lime, and as much oxygen as required was sucked in as the animals used it, and enough extra supply was drawn in as described in a previous section by the suction pump to keep up the desired oxygen percentage. The oxygen appeared to increase appetite in the earlier stages, and the animals ate their food greedily and seemed to suffer from no inconvenience.

EXPERIMENTS XI, XII, XIII

Three guinea-pigs were placed at the same time in the respiratory chamber under the usual conditions described already. The history of each animal is separately given in the following account:—

1. See *British Medical Journal*, Vol. I, p. 71, 1912.; *Proc. Roy. Soc.*, Vol. LXX, p. 455, 1902; *Journal of Physiology*, Vol. XXIX, p. 492, 1903.

Experiment XI.—The guinea-pig was placed in the chamber and the oxygen was slowly raised to 79 per cent. Next day the oxygen stood at 88 per cent., the carbon-dioxide at 1·5 per cent. The animal seemed quite well, and was eating and lively. On the third morning the oxygen was 79 per cent., and carbon-dioxide 1·6 per cent. The chamber was cleansed out, the guinea-pig was in the air outside for thirty minutes during this operation, and the oxygen was raised to 70 per cent. On the fourth morning the animal was found dead. The oxygen stood at 75 per cent., and carbon-dioxide at 0·76 per cent.

A post-mortem examination was at once made with the following findings:—

(a) *Microscopic Examination.*—The lungs showed a markedly acute active congestion, which was in patches in certain places. All the lobes were so affected, and the tissue sank in water. The heart showed the distended and engorged condition of an asphyxial death.

(b) *Microscopic Examination.*—The sections of the lung when cut and stained showed the extraordinarily acute active congestion demonstrated by the first micro-photograph accompanying this paper. The capillaries are seen to be dilated to three or four times their normal diameter. There is a slight exudate in the alveoli, and a few leucocytes. The epithelium of the bronchi is somewhat desquamated, and there are traces of proliferation. By Weigert's stain traces of fibrin were found in some of the alveoli.

Bacteriological smears and cultures on various suitable media were made from the cut lung, as well as from the exudate in the smaller bronchi, and all these were found to be negative.

The cause of death was an acute lobar or catarrhal pneumonia, suppressing the respiratory function of the lungs.

Experiment XII.—The second of the three guinea-pigs in the chamber being treated in the same manner, was noticed, when the preceding one was dead, to be suffering from dyspnoea. At 10 a.m. on the fourth day from the beginning of the experiment, the respirations were 120 per minute, the breathing was laboured, and the animal did not eat and avoided movements. At 2 p.m. this animal succumbed, and it was found that the oxygen was then 76·3 per cent., and the carbon-dioxide 0·5 per cent.

The examination gave identical results with those described in the previous case, the micro-photograph shows the extreme condition of congestion in the lungs.

Experiment XIII.—The third guinea-pig in the chamber with the preceding two was removed from the oxygen chamber at 2 p.m. on this same fourth day. It was then very dyspnoeic; respirations, 120 per minute, with heavy respiration, but not quite so pronounced as in the last experiment. It was removed to the animal house and placed in a straw bed. Next morning it was somewhat recovered, but still had not eaten and remained still. In the afternoon it began to eat a little, and was moving about freely in two days' time, having made a rapid recovery. Four days later, this animal was killed in order to examine the condition of the lungs. These showed, microscopically, a congestion in patches, but a considerable amount of air-space was present, and pieces of the lung now floated in water, instead of sinking as in Experiments XI and XII.

Microscopical Examination.—The lungs showed patchy congestion, alveoli generally full, capillaries distended, epithelium of bronchi desquamating and proliferating. Catarrhal cells show many fat vacuoles in the cytoplasm; the nuclei stained well and were displaced to one side. (See Micro-photograph No. 3.)

Experiment XIV.—Three guinea-pigs were placed in the respiratory chamber, and the percentage of oxygen was raised to 69. The next morning the oxygen had risen to 74 per cent., and the carbon-dioxide 0.6 per cent. The guinea-pigs were active and well on the third day, when analysis showed: oxygen 71 per cent., and carbon-dioxide 1 per cent.; and on the fourth day, before cleaning out the chamber, it was found that the oxygen was 68 per cent., and carbon-dioxide 1.3 per cent.

The chamber was now cleansed and the guinea-pigs, which were not so active or feeding so well as usual, were replaced, and the oxygen raised to 72 per cent. Next morning (fifth day), one animal was found dead: the oxygen standing at 69 per cent., and the carbon-dioxide at 0.3 per cent. During this fifth day the two remaining guinea-pigs showed evident signs of the effects of the oxygen in their respiration and general appearance, and the second one died next morning (sixth day), and the third one succumbed in the same afternoon (sixth day.) The oxygen on analysis showed now a strength of 72 per cent., and the carbon-dioxide stood at 0.6 per cent. The examinations of the tissues showed a pneumonia of a slightly more chronic type than that of the previous experiment (see Micro-photograph No. 4, from the second of these three animals).

From the results of these experiments it was concluded that

about 70 per cent. of oxygen was the minimum which was necessary to cause this pneumonic flooding of the lungs, and this was found in practically every succeeding experiment to be the result; for if the strength of the oxygen dilution rose over 70 per cent. for a day, the guinea-pigs invariably showed symptoms of lung mischief; whereas, with the lower dilutions, leaving out accidental causes of death, the guinea-pigs progressed favourably and were free from symptoms. Such results were obtained in four similar experiments to the above, in which about 70 per cent. of oxygen was used, while in an equal number with 60 to 65 per cent. of oxygen no pneumonic effects were observed.

CONCLUSIONS

1. That oxygen in any percentage at atmospheric pressure can be inhaled for *short* periods without ill effects.

2. That at percentages below 70 per cent. it can be inhaled for prolonged periods without giving rise to any symptoms or pathological signs.

3. That above 70 per cent. its use for a prolonged period is attended with serious risk of causing an irritative pneumonia, and if persisted in, produces death.

4. That the pneumonia is of a lobar and catarrhal character and due to the effects of the oxygen and not to any micro-organism.

In conclusion, I desire to express my thanks to Professor Benjamin Moore for the suggestion of the research, and his kindness and unfailing assistance at all times during its progress; also to Professor Ernest Glynn for much valuable advice on the pathological changes in the lungs, and to Dr. Stenhouse Williams for his assistance and advice.

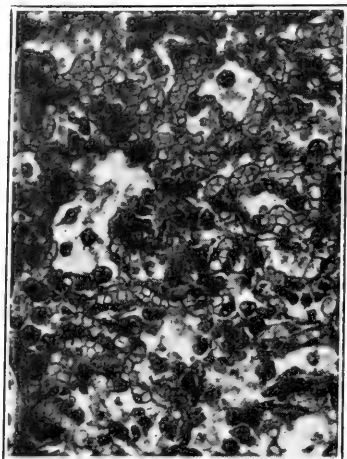

EXPERIMENT XI

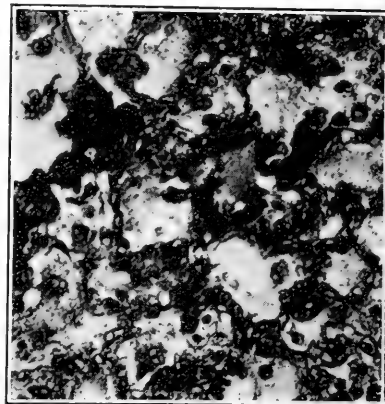

EXPERIMENT XII

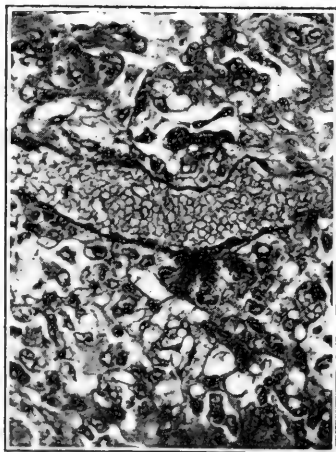

EXPERIMENT XIII

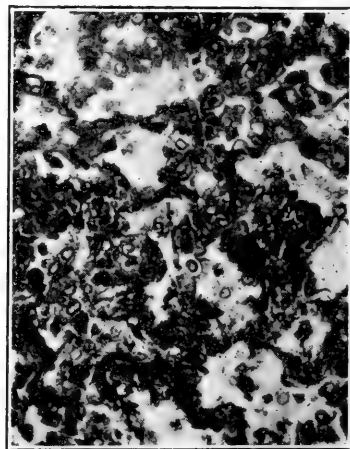

EXPERIMENT XIV

OBSERVATIONS ON ELECTRO-OSMOSIS

BY J. O. WAKELIN BARRATT AND A. B. HARRIS:

*From the Cancer Research Laboratory, University of Liverpool**(Received June 13th, 1912)*

The present investigation was undertaken with the object of throwing light upon the enquiry whether it is possible to introduce dissolved substances into living tissues by means of electro-osmosis. Early in the course of this work it became apparent that, so long as the investigation was confined to living tissues, serious limitations would be encountered as regards the number and duration of the observations possible, as well as in consequence of the relatively low strength of current necessarily employed when it was desired to preserve uninjured the vitality of the living surface to which the current was applied. Since living matter is largely colloidal it was determined to study as far as possible electro-osmosis in respect of colloidal membranes. In all of such experiments the degree of electro-osmosis was ascertained quantitatively, for it is obvious that the practical value of electro-osmosis, if it can be employed as a means of introducing dissolved substances, would depend upon the amount of fluid which could be made to pass into the living tissues under the conditions of experiment obtaining. The selection of the type of experiment performed is necessarily largely determined by current hypothesis as to the nature of this phenomenon, and the same applies to the interpretation of the results obtained.

It will be convenient, in detailing the results of this investigation, to exhibit first of all the degree of osmosis obtainable through living tissues, colloidal membranes and porous diaphragms under similar conditions of experiment. A short reference will then be made to the theory of electro-osmosis, after which some experiments bearing upon the possibility of employing electro-osmosis as a means of introducing dissolved substances into living tissues will be described. The latter are incomplete, but as the course of this work is temporarily interrupted, it has been thought best to present it in an incomplete form rather than delay for an indefinite period publication of the results already obtained.

DEGREE OF ELECTRO-OSMOSIS OBTAINABLE

The fluids employed in the experiments about to be described were alcohol and water. The latter was sometimes used in the form of distilled water, but more frequently contained dissolved salts.

The media in which electro-osmosis was studied were of three kinds; porous plugs, contained in glass tubes; colloids in the form of hydrogel or colloidal solid; and living tissues.

For convenience of comparison the degree of electro-osmosis is always given per square centimetre sectional area of the medium and in respect of a potential fall of one volt per centimetre length of the medium. It may here be observed that the amount of electro-osmosis with a given sectional area of medium is proportional to the potential fall per centimetre. So long as the potential fall is maintained constant, the degree of electro-osmosis per square centimetre is independent of the length of medium traversed by the current.

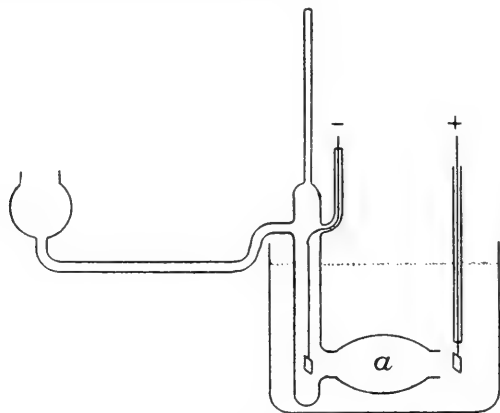

FIG. 1.

The experiments made with porous plugs were of two kinds; those made with filter paper or cotton wool and those in which powdered naphthalene or sulphur was employed.

In experiments made with filter paper the apparatus shown in fig. 1¹ was used. The description of this apparatus is given on p. 330 In the experiments made with cotton wool, naphthalene, and sulphur, Perrin's apparatus shown in fig. 2 was used. This consists of a glass tube (*a*), filled with the substance employed as diaphragm, and fitted by means of ground surfaces into (1) a vertical limb (*b*), provided above with a stopcock and connected with a horizontal measuring tube

1. Figs. 1 and 2 are approximately one-quarter, and Figs. 5 and 7 one-half the natural size. Figs. 3 and 4 are reduced to one-sixth and three-quarters, respectively, of the actual size.

(*d*), furnished with a bulb at its extremity; and (2) the curved limb (*c*), provided below with a stopcock. Two electrodes, marked + and -, are introduced into the apparatus as shown in the figure.

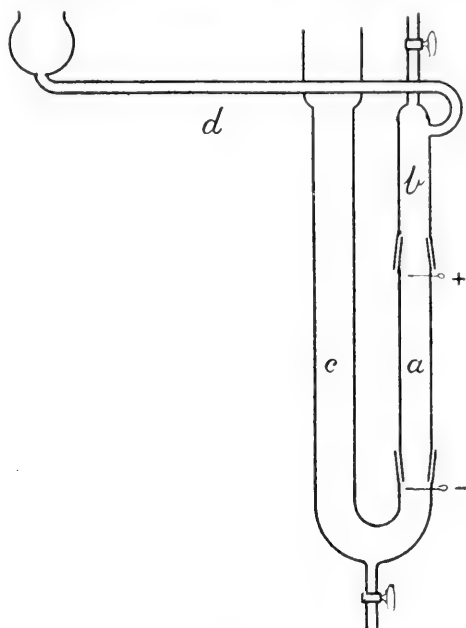

FIG. 2.

Some observations made with the above forms of apparatus are recorded in Table I, which serves to illustrate the degree of electro-osmosis observed. The latter ranged; it may be observed, between 0.015 c.c. and 0.2 c.c. per hour, being less marked when 70 per cent. alcohol was employed than when distilled water or a solution of glucose was used. In all cases the flow of liquid by electro-osmosis was from anode to kathode, that is to say, in the direction of the current.

TABLE I.—Electro-osmosis through various diaphragms. The amounts of fluid given below correspond to a sectional area of one square centimetre and a potential fall in the plug of one volt per centimetre. The first three experiments were made with Perrin's apparatus, Fig. 1; the remaining experiments were made with the apparatus shown in Fig. 2; the + sign indicates flow of fluid from anode to kathode.

No. of Experiment	Liquid in contact with diaphragm	Material of which diaphragm was composed	Amount of electro-osmosis per hour.
1	5 % solution of glucose in water	Filter paper	Approximately + 180 c.mm.
2	5 % solution of glucose in water	Filter paper	Approximately + 130 c.mm.
3	5 % solution of glucose in water	Filter paper	Approximately + 100 c.mm.
4	70 % alcohol	Cotton wool (<i>a</i>)	Approximately + 34 c.mm.
5	70 % alcohol	Cotton wool (<i>b</i>)	Approximately + 35 c.mm.
6	70 % alcohol	Cotton wool (<i>c</i>)	Approximately + 35 c.mm.
7	70 % alcohol	Powdered naphthalene	Approximately + 15 c.mm.
8	70 % alcohol	Powdered sulphur	Approximately + 44 c.mm.
9	Distilled water	Powdered sulphur	Approximately + 191 c.mm.
10	Distilled water	Powdered sulphur	Approximately + 197 c.mm.

When studying electro-osmosis through colloids immersed in watery liquids the apparatus shown in fig. 3 was employed. In this apparatus the colloid is used in the form of a diaphragm (*a*), 1 mm. or less in thickness, placed between two curved tubes (*bb*), in the lower part of which electrodes, marked + and -, are placed. Above are two graduated measuring tubes (*cc*), 3 mm. in internal diameter, by means of which the amount of fluid passing through the diaphragm is determined, the stopcocks shown in the figure being closed during the passage of the current. Fluid is introduced into the apparatus through the narrowed portion of the curved limbs, which are provided with stopcocks, or by means of a very fine capillary pipette introduced into the graduated vertical pieces (*cc*). The electrodes were usually made of copper immersed in a 10 per cent. solution of CuSO_4 , above which was placed the fluid in which the diaphragm was immersed; but in experiments with gelatine, silver electrodes were employed, immersed in a N/10 solution of AgNO_3 , between which and the liquid used for observing electro-osmosis a solution of NaNO_3 generally intervened.

The colloids employed for the diaphragm were three in number; a hydrogel of washed gelatine (10 per cent.); a hydrogel of agar (1.5 per cent.); and an insoluble colloidal solid consisting of parchment paper. These diaphragms were held in position by metal or vulcanite flanges, indicated in fig. 3, which were clamped together and rendered water-

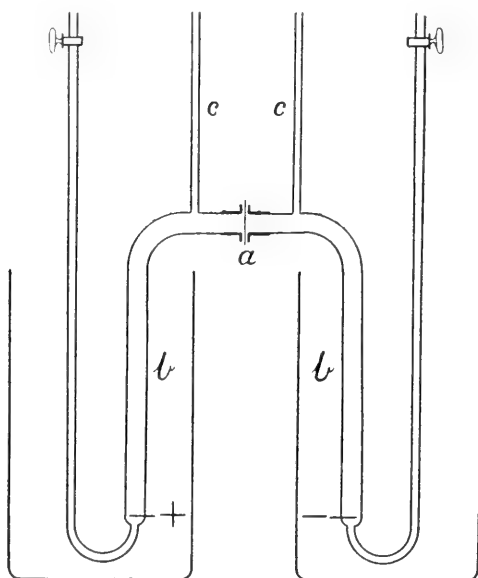

FIG. 3.

tight by means of shellac. When gelatine or agar was employed, the diaphragm was formed by painting linen with the dissolved colloid which was then allowed to set. In some of our earlier experiments, instead of the diaphragm of gelatine or agar shown in fig. 3, a solid plug was employed several centimetres in length, but this was given up in consequence of a difficulty referred to later (p. 323). When a thin diaphragm is used diffusion readily occurs, so that an equilibrium between the salts contained in the colloid and those present in the surrounding liquid is very quickly obtained, but if a solid colloidal plug is employed it is difficult to secure such equilibrium.

The fluids employed when using the apparatus shown in fig. 3 consisted, in addition to distilled water, of varying concentrations of the monovalent, divalent and trivalent salts enumerated in Experiments 2 to 8, Table 2, and in Experiments 9 to 12, of a 0.01M to 0.02M solution of sodium sulphate or nitrate saturated with iodine and containing, in addition, in Experiments 9 and 10, 33 per cent. of alcohol. The results obtained in the former series (Experiments 2 to 8) are given in full elsewhere;¹ in the Table the amount of electro-osmosis obtainable with 0.02M and 0.01M solutions is given. The degree of electro-osmosis obtained should be compared with that exhibited in the preceding and succeeding Tables.

TABLE II.—Electro-osmosis through colloidal membranes immersed in watery liquids. The apparatus shown in Fig. 3 was employed. The amounts of fluid given below correspond to a sectional area of one square centimetre and a potential fall in the colloid of one volt per centimetre. The sign + indicates a flow of fluid from anode to kathode; the sign — indicates a flow of fluid from kathode to anode.

No. of Experiment	Concentration of electrolyte in liquid in contact with medium	Amount of fluid passing per hour by electro-osmosis through colloid. The electrolytes employed are given in brackets		
		Gelatine (10 %)	Agar (1.5 %)	Parchment paper
1	Distilled water	Could not be measured	Could not be measured	Could not be measured
2	0.02M			
3	0.02M +	198.3 c.mm. (Na ₂ SO ₄)	+ 365 c.mm. (Na ₃ PO ₄)	+ 4.15 c.mm. (Na ₃ PO ₄)
4	0.02M +	184.2 c.mm. (NaOH)	+ 374 c.mm. (Na ₂ SO ₄)	+ 4.31 c.mm. (Na ₂ SO ₄)
5	0.02M +	68.3 c.mm. (NaNO ₃)	+ 370 c.mm. (NaOH)	+ 3.64 c.mm. (NaOH)
6	0.02M —	171.4 c.mm. (HNO ₃)	+ 362 c.mm. (NaCl)	+ 2.10 c.mm. (NaCl)
7	0.02M —	286.5 c.mm. (Cu(NO ₃) ₂)	+ 103 c.mm. (HCl)	+ 1.08 c.mm. (HCl)
8	0.02M —	693.0 c.mm. (Al(NO ₃) ₃)	+ 103 c.mm. (CuCl ₂)	+ 1.32 c.mm. (CuCl ₂)
			+ 64 c.mm. (AlCl ₃)	+ 0.15 c.mm. (AlCl ₃)
9	0.01M —	19.6 c.mm. (Na ₂ SO ₄)*		
10	0.01M —	28.5 c.mm. (NaNO ₃)*		
11	0.01M —	36.6 c.mm. (NaNO ₃)*		
12	0.02M —	54.8 c.mm. (NaNO ₃)*		

1. Barratt, J. O. Wakelin, and Harris, A. B. 'Elektroosmose und Konzentration der Elektrolyte,' *Zeitschr. f. Elektrochemie*, Bd. XVIII, S. 221, 1912.

* In Experiments 9 and 10 the sodium salt employed was dissolved in water containing 33 per cent. of alcohol. In Experiments 11 and 12 a watery solution of sodium nitrate free from alcohol was used. In these four experiments the solution of sodium salt in contact with the diaphragm was saturated with iodine.

The amount of electro-osmosis observed ranges, it will be seen, from 0.693 c.c. to less than 0.0002 c.c. per hour. The direction of osmosis is that of the current, except in some observations made with gelatine, in which the direction is from kathode to anode. In Experiments 2 to 8 the influence of decreasing valency of anion and of increasing valency of kation in diminishing the rate of flow of liquid from anode to kathode or of reversing its direction (in the case of gelatine) is shown. When gelatine is immersed in a solution of sodium sulphate or nitrate, the flow of liquid is from anode to kathode; if iodine is added the direction of flow is reversed.

The observations made upon living tissues now remain to be described. In these experiments the human forearm was used, the apparatus shown in fig. 4 being employed. This consists of a flanged glass bowl, the mouth of which is applied to the skin, to which it is affixed by means of collodion. To the upper part of the bowl is attached a graduated glass tube, having an internal diameter of 2 mm., which is

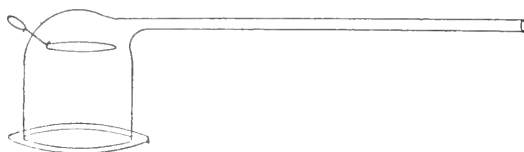

FIG. 4.

kept in a horizontal position during experiment. Near this tube a platinum electrode is sealed into the bowl. Before use the electrode is covered thickly with electrolytically deposited zinc. When used for experiment the apparatus, after being attached to the skin, is filled with a 4 per cent. solution of $ZnSO_4$, by means of a pipette introduced into the horizontal tube, all air bubbles being removed. The forearm is supported below in a dish containing a 4 per cent. solution of $ZnSO_4$, into which an electrode is placed.

When a current is passed through the forearm a passage of fluid from anode to kathode occurs. So long as the circulation in the forearm continues this is not, however, recognisable, for oedema of the skin occurs, in consequence of which the fluid in the horizontal tube is driven towards the mouth of this tube whatever the direction of the current may be. This difficulty was removed by applying an indiarubber bandage to the forearm and elbow so that the tissues were largely emptied of blood, after which a ligature was placed on the middle of the arm, arresting the circulation beyond; the indiarubber bandage was then removed below

the ligature and the apparatus fixed in position. Under these circumstances no oedema occurred during the course of the experiment. The forearm and hand soon became numb, and after a time cold. The application of the ligature was attended with a certain amount of discomfort; it could be borne, however, for a period of about three-quarters of an hour.

The experiments were performed in the following manner. After the apparatus had been applied as above described, an interval of ten minutes was allowed to elapse in order to make sure that the level of fluid in the horizontal tube was nearly constant. A current was then allowed to pass for fifteen minutes and the movement of the meniscus in the horizontal tube noted. At the end of this period the current was passed in the reverse direction for ten to fifteen minutes, during which time a nearly equal movement of the meniscus in the opposite direction occurred. The current was then broken, and the position of the meniscus noted for a further period of ten minutes, during which no current was passing. Sometimes the current was passed for about twenty-five minutes in one direction only, the reversal of current being omitted. In these experiments it is essential that the forearm should be kept as free from movement as possible, the subject assuming at the beginning of the experiment a comfortable position, which is subsequently maintained unchanged. During the periods, at the beginning and end of the experiment, while no current is passing, the meniscus in the horizontal

TABLE III.—Electro-osmosis through forearm. The apparatus shown in Fig. 4 was attached to the skin. The amounts of fluid given below correspond to a sectional area of one square centimetre and a potential fall of approximately one volt per centimetre. The sign + indicates that the flow of fluid is from anode to kathode.

Subject of Experiment	Amount of fluid passing per hour by electro-osmosis through forearm.	
B	+ 11.3 c.mm. (kathode inside apparatus)	+ 5.0 c.mm. (anode inside apparatus)
B	+ 10.7 c.mm. (kathode inside apparatus)	+ 11.5 c.mm. (anode inside apparatus)
H	+ 9.0 c.mm. (kathode inside apparatus)	+ 7.9 c.mm. (anode inside apparatus)
A	+ 6.3 c.mm. (kathode inside apparatus)	+ 15.0 c.mm. (anode inside apparatus)
A	+ 26.0 c.mm. (kathode inside apparatus)	+ 17.5 c.mm. (anode inside apparatus)
W	+ 13.0 c.mm. (kathode inside apparatus)	+ 9.8 c.mm. (anode inside apparatus)
	Mean 12.7 c.mm.	Mean 11.1 c.mm.

tube exhibited slight variation in position, but no definite movement in one direction; during the passage of the current a movement was observed which was constant, its direction being determined by that of the current.

The results of a number of experiments of this type are given in Table III. With different subjects and strengths of current ranging

from 2 milliamperes to 4 milliamperes per square centimetre, some differences in the rate of flow of fluid were observed, and again on changing the direction of the current the reversed flow did not always take place at the original rate. Nevertheless, the variations observed were on the whole inconsiderable, the mean value for a potential fall of approximately one volt per centimetre being 11.9 c.m.m. per hour per square centimetre of surface of skin. With currents exceeding 9 milliamperes per square centimetre of surface, superficial sloughing of the skin occurred. The duration of application of the current was, as already mentioned, about twenty-five minutes.

The direction of electro-osmosis through the forearm was from anode to kathode. For convenience of comparison the direction of flow of fluid in these and the preceding experiments is indicated in Table IV.

TABLE IV.—Direction of electro-osmosis (compiled from I, II and III).

No. of Experiment	Liquid in contact with medium	Medium employed and direction taken by fluid.			
		Plug of filter paper	Gelatine	Agar	Parchment paper Forearm
1	Solution of glucose	+—>—			
2	Distilled water	No movement recognisable			
3	Solution of Na_3PO_4		+—>—	+—>—	+—>—
4	Solution of Na_2SO_4		+—>—	+—>—	+—>—
5	Solution of NaOH		+—>—	+—>—	+—>—
6	Solution of NaCl or NaNO_3		+—>—	+—>—	+—>—
7	Solution of HCl or HNO_3		+<—	+—>—	+—>—
8	Solution of CuCl_2 or $\text{Cu}(\text{NO}_3)_2$		+<—	+—>—	+—>—
9	Solution of AlCl_3 or $\text{Al}(\text{NO}_3)_3$		+<—	+—>—	+—>—
10	Iodine in water		+<—		
11	Solution of zinc sulphate				+>—

When a current is passed as above described through the forearm, little or no sensation is ordinarily experienced, so long as the strength of the current does not exceed 3 milliamperes per square centimetre. With a current of 6 milliamperes, tingling is frequently produced. If still stronger currents are employed, a smarting or burning sensation is felt; such currents can, however, be borne provided the strength of current is increased very gradually, the passage of the current being after a time attended with some blunting of sensibility. When the circulation is re-established in the limb, transient swelling of the skin, generally attended by redness, occurs in the area of application of the current.

If the current has been too strong, blanching of the skin may take place, and superficial necrosis is likely to occur. When such injury follows the application of the current, it is generally irregular in distribution, the surface of the skin being unequally affected. Commonly necrosis, if it occurs, takes place around the mouths of the hair follicles, in which situation the current appears to enter more readily than elsewhere. The current which can be applied without injury, varies in different individuals. Any breach of surface which may be present at the time of application of the current is likely to be the seat of subsequent sloughing, even if a current of only 2 milliamperes per square centimetre is employed.

Before concluding this section, reference may be made to an effect of electro-osmosis, which at first exercised a disturbing influence upon the course of these experiments. It was sometimes found that when a current

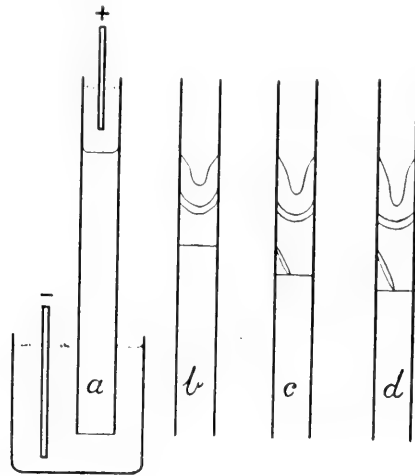

FIG. 5.

was passed through a glass tube (*a*, fig. 5) partly filled with a hydrogel of gelatine (containing 40 per cent. of gelatine and 0.6 per cent. of NaCl), above which was a solution of an electrolyte, the degree of electro-osmosis diminished as the experiment proceeded, and after a time its direction¹ became reversed. In such cases, the upper surface of the gelatine (the condition of the lower surface could not usually be

1. To measure the rate and direction of flow the upper electrode was sealed into the vertical tube *a*, which was closed above and connected with a horizontal measuring capillary. Other forms of apparatus were also used.

observed) was seen to become cupped, and a few millimetres below the apex of the cup a crack appeared after a time in the gelatine. This phenomenon was observed when a 0.1M solution of CuSO_4 , containing a copper anode, or a 0.1M solution of ZnSO_4 , containing a zinc anode, was placed above the gelatine. In fig. 5, *b c d* represent the appearance of the gelatine in tube *a*, two hours, three hours, and four hours, respectively, after the commencement of the experiment. Below the surface of the gelatine is a dark-coloured green zone into which Cu^{++} ions have penetrated; beneath this is a lighter greenish zone indicated by a double contour in *b, c* and *d*, representing the advancing layer of these ions. Still lower a horizontal reflecting surface is seen (indicated in the figure by a horizontal line). This appears to be caused by removal of water by electro-osmosis from the upper portion of the gelatine, the refractive index of which is in consequence no longer the same as that of the more watery portion of the gelatine below. This boundary surface was found to travel, under a potential fall of one volt per centimetre, at the rate of 0.93 cm. to 1.05 cm. per hour. A crack, placed obliquely and reaching below to this boundary surface, is seen in *c* and *d*.

The explanation of this phenomenon was ultimately found to be as follows:—When Cu^{++} or Zn^{++} ions passed into the gel, causing it to become green in the former case, and somewhat opaque, the direction of electro-osmosis in this portion of the gel, in contact with the solution of CuSO_4 or ZnSO_4 , became reversed, while that occurring in the unchanged gel below continued its original direction unaltered. In consequence, at the junction of the two the gel became rapidly deprived of water and very marked cupping took place. As soon as the latter became unable to compensate for the contraction of the gelatine a crack appeared in the gelatine, attended with the formation of an air space. When the hydrogel of gelatine, instead of being made up with 0.6 per cent. NaCl solution or with distilled water, was made up with CuSO_4 solution of the same concentration as that used in the liquid above, cupping did not occur or was very slight, and no cracks formed.

It may be observed that the effect of adding an electrolyte to a gel of gelatine or agar is to cause contraction of the gel, which usually swells up again (though not necessarily to the original extent) when placed once more in distilled water. Some salts, however, such as HgCl_2 , cause permanent shrinking. Irreversibility is also conferred upon gelatine by Hg salts, formol and iodine.

NATURE OF ELECTRO-OSMOSIS

Electro-osmosis was observed as long ago as 1807 by Reuss.¹ It was re-discovered by Porret,² and was further studied by de la Rive,³ Becquerel⁴, Daniell,⁵ Napier,⁶ and Wiedemann.⁷

Reuss placed two tubes, containing electrodes immersed in water, in a mass of clay and found that the level of the fluid during the passage of the current rose in the kathode tube and sank in the anode tube. In consequence of this passage of fluid the phenomenon was compared to osmosis, but the resemblance is only a superficial one, since at the commencement of the experiment the fluids are of the same concentration. As the current continued to pass, the difference of level in the two sections of the cell increased up to a certain point and then remained unchanged, the hydrostatic pressure balancing the action of electro-osmosis. The

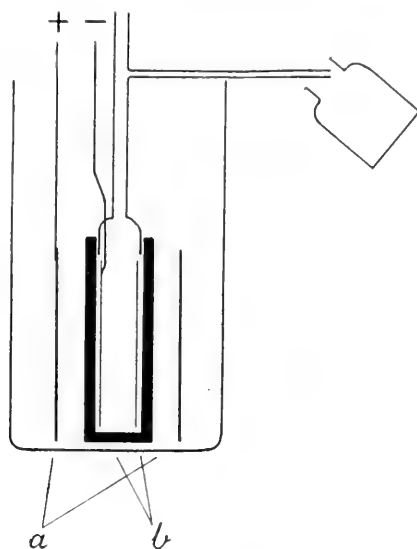

FIG. 6.

degree of electro-osmosis can therefore be measured in terms of the equilibril height (H), which has been shown by G. Wiedemann,⁷

1. Reuss, F. 'Notice sur un nouvel effet de d'électricité galvanique.' *Mémoire de la Soc. imp. des Naturalistes à Moscou*, T. H., 1809, pp. 330-332.
2. Porret. Thomson, *Annals of Phil.*, VIII, p. 74, July, 1816.
3. de la Rive. *Traité de l'Electr.*, II, p. 379; *Ann. de Chim. et de Phys.*, XXVIII, p. 125, 1825.
4. Becquerel. *Traité de l'Electr.*, III, 102.
5. Daniell. *Ann. d. Physik. u. Chemie*, 1835, Ergänzungsbd., I, 569.
6. Napier. *Phil. Mag.*, July, 1846.
7. Wiedemann, G. *Galvanismus*, I, S. 377; 'Über die Bewegung von Flüssigkeiten im Kreise der geschlossenen galvanischen Säule.' *Ann. d. Physik. u. Chemie*, Bd. LXXXVII, 321, 1852; 'Über die Bewegung der Flüssigkeiten im Kreise der geschlossenen galvanischen Säule und ihre Beziehungen zur Elektrolyse.' *Ann. d. Physik. u. Chemie*, XCIX, p. 177, 1856.

employing the apparatus shown in fig. 6,¹ to be directly proportional to the strength of the current (c), the specific resistance of the solution (r), and the thickness of the diaphragm (t), and inversely proportional to the sectional area S , according to the formula:—

$$H = \text{constant} \times \frac{Crt}{S}$$

Since $\frac{rt}{S}$ represents the resistance of the diaphragm the expression $C \frac{rt}{S} = CR$, i.e., the potential fall between the sides of the diaphragm (E), so that the formula may be written:—

$$H = \text{constant} \times E$$

Wiedemann concluded that the galvanic current caused a direct transport of fluid, in virtue of a traction which it exerted upon each element of volume of fluid which it traversed. This conclusion was contested by Graham,² v. Quintus Icilius,³ and Breda and Logemann,⁴ who pointed out that it was impossible to demonstrate the transport of fluid in the absence of a diaphragm.

Further investigations were made by G. Quincke,⁵ who studying electro-osmosis in capillary glass tubes provided with platinum wire electrodes, advanced an interpretation of electro-osmosis, which still remains the accepted explanation of this phenomenon. Quincke observed that when particles of clay were suspended in the liquid between the electrodes, a movement towards one or other electrode occurred (in water towards the anode). He therefore concluded that, at the surface of contact of solid and liquid, opposite electrical charges appeared, an electrical double layer resulting. A system of this kind would be affected by a potential gradient in such a way that the positively charged portion of the system is moved in one direction and the negatively charged portion in the other direction. If the solid were fixed, then movement of the

1. This consists of a porous clay cylinder, closed below and cemented above to a vertical glass tube provided with a horizontal capillary which delivers fluid into a receiver or, in another form of the apparatus, is continuous with a manometer tube. Passing through the vertical glass tube is a platinum wire connected with a cylindrical electrode of platinum foil, (*b*) placed in the clay vessel. The latter is contained in a beaker filled with water and is surrounded by a second cylindrical electrode (*a*) made of lead.

2. Graham. *Phil. Mag.*, VIII, p. 151, 1854.

3. v. Quintus Icilius. *Lehrbuch der Experimental-Physik*, S. 642, 1855.

4. Breda and Logemann. *Ann. d. Physik. u. Chemie*, Bd. C, S. 149, 1857.

5. Quincke, G. 'Über die Fortführung materieller Theilchen durch strömende Elektrizität.' *Ann. d. Physik. u. Chemie*, Bd. CXIII, S. 513, 1861.

liquid alone would occur. Subsequently Helmholtz¹ advanced a mathematical theory of the electrical double layer and showed that Quincke's explanation was theoretically tenable.

Hardy² observed that particles of globulin of different size contained in solutions of varying concentration, the aspect of which ranged from transparency to opalescence, moved at the same rate. Since the velocity of the particles was, within the limits of concentration employed, independent of their size, it follows from Helmholtz's theory of electro-osmosis that the density of the charge per unit of surface is constant and the total quantity of electricity on each particle (Q) is directly proportional to the surface according to the equation

$$Q = \sigma 4 \pi r^2$$

Helmholtz showed that the potential difference E , at the junction of solid and fluid in a capillary tube was given by the equation

$$E = \frac{4 \eta \phi}{K r^2 H}$$

Where K is the specific inductive coefficient of the liquid,³ η the coefficient of internal friction of the fluid, (r) the radius of the tube, H the strength of the electric field, and ϕ the amount of liquid passing through the tube per second under the influence of the electric field.

Data respecting the amount of fluid carried by electro-osmosis are scanty. A few determinations of the amounts of fluid transported through a clay diaphragm immersed in dilute solutions of H_2SO_4 , $CuSO_4$, $Cu(NO_3)_2$, and $AgNO_3$ by currents of a known strength were given by Wiedemann (1856).⁴ Further determinations of the relative rate of flow of fluid through hydrogels under a fixed potential gradient are given by Perrin.⁵ More recently Barratt and Harris⁶ have determined the absolute rate of flow of fluid by electro-osmosis through gelatine, agar, and parchment paper, when various concentrations of electrolytes are employed. From these observations the data given in Experiments 2 to 8, Table II, are selected.

1. Helmholtz. 'Studien über electrische Grenzschichten. Wiedem., *Ann. d. Ph. u. Ch.*, Bd. VII, S. 337. 1887.
2. Hardy, W. B. 'Colloidal solution. The globulins.' *Journ. of Physiol.*, XXXIII, p. 251, 1905-6.
3. K is introduced into the formula by J. Perrin, 'Mécanisme der l'électrisation de contact et solutions colloïdales.' *Journ. der Chimie Physique*, II, p. 601, 1904; III, p. 50, 1905.
4. *Loc. cit.*, p. 177.
5. *Loc. cit.*
6. Barratt, J. O. Wakelin, and Harris, A. B. *Loc. cit.*

The flow of fluid in electro-osmosis is obviously determined by the movement of the ions contained in the liquid at the surface of contact with solid. These ions, as they move under the influence of the potential gradient, cause a passive movement, in the same direction, of the molecules of liquid. The narrower the interval between the particles of which the diaphragm is composed, the more marked this movement of liquid will be. Further, the more numerous the ions in the liquid portion of the double layer, the greater the flow of liquid will at first be, though with continued increase in the number of ions a diminution of concentration of fluid will later occur and the flow will diminish; thus the curve obtained by plotting concentrations, as abscissae, against rates of flow, as ordinates, under a given potential gradient, will exhibit a maximum, corresponding in the case of agar to a concentration of electrolyte about 0.02M, while on each side of this maximum, with greater and lesser concentrations, the curve will exhibit a diminished rate of flow.¹

Up to the present it has been tacitly assumed that electro-osmosis has been brought about solely by the movement of unaltered ions. If, however, the ions in question became centres for the condensation or combination of water molecules, then an additional factor in the transport of fluid would come into play. Nernst² showed how the problem of ionic hydration might be investigated by means of diffusion and migration experiments in which an indifferent dissolved substance was used as indicator. Lotmar,³ employing one of Nernst's methods, showed that hydration of ions occurs. Lobry de Bruyn,⁴ using a solution of silver nitrate in aqueous methyl alcohol, was unable to obtain evidence of ion hydrates or alcoholates. Morgan and Kanolt,⁵ however, studying electrolysis of a solution of copper nitrate in water and alcohol by a procedure similar to Nernst's second method, concluded that copper ions were hydrated.

Obviously if the ions contained in the liquid portion of the double electrical layer are hydrated, the rate of flow will be much greater than would be the case if no hydration occurred. Usually the current

1. Barratt, J. O. Wakelin, and Harris, A. B. *Loc. cit.* Figs. 172-174, pp. 223-224.
2. Nernst, W. 'Zur Frage nach der Hydratation gelöster Substanzen,' I, *Nachr. d. k. Gesellsch. d. Wissensch.*, Göttingen, Math.-Phys. Kl., S. 68, 1900.
3. Lotmar, H. 'Zur Frage nach der Hydratation gelöster Substanzen,' II, *Nachr. d. k. Gesellsch. d. Wissensch.*, Göttingen, Math.-Phys. Kl., S. 70, 1900.
4. Lobry de Bruyn. *Jahrb. d. Elektrochemie*, Bd. X, p. 260, 1904.
5. Morgan and Kanolt. 'Über die Verbindung der Lösungsmittel mit den Ionen,' *Zeitschr. f. physikal. Chemie*, Bd. XLVIII, S. 365, 1904.

would not be conveyed wholly by the ions contained in the liquid portion of the double layer, though as an exceptional event this might conceivably occur if the particles of which the diaphragm was composed were in sufficiently close apposition. More usually the current would be in part conveyed by ions of the electrolyte employed, which do not form part of the double electrical layer at the surface of solid and liquid. In the latter case there would be, if the ions were hydrated, an additional transport of fluid representing the difference between the hydration of opposite ions involved. Presumably, also, the degree of ionic hydration would be different at the surface of liquid in contact with the solid, in which situation the concentration of water would be different from that obtaining elsewhere in the liquid. At the present time sufficient data are not available to enable an estimate to be formed of the extent to which electro-osmosis is affected by ionic hydration. If, however, an agar diaphragm is employed in the apparatus shown in fig. 3, the number of molecules of water passing when electro-osmosis is at a maximum is found to be from eighteen to three hundred and seventy times greater than the number of molecules of electrolyte decomposed by the current,¹ a circumstance which may be interpreted as indicating that conveyance of fluid by hydrated ions plays only a subordinate part in electro-osmosis.

THE INTRODUCTION OF DISSOLVED SUBSTANCES INTO LIVING TISSUES BY MEANS OF ELECTRO-OSMOSIS

The conditions under which experiments directed to this end are performed, are attended with limitations, which render investigation difficult.

Thus the amount of current which can be employed without damaging the skin is limited ordinarily to from one to three milliamperes per square centimetre, and even this current cannot usually be continued safely for more than twenty minutes. Again, since ions derived from dissolved electrolytes enter and leave the skin under the action of a potential gradient, the dissolved substances which can be employed in the investigation of the problem under consideration are limited to non-electrolytes of sufficiently simple molecular constitution to be able to pass through colloidal material. Further, such dissolved substances, after passing into the skin, must be capable, even in the very small quantities which in practice can alone be introduced, of producing a marked local or remote effect upon the organism. Unfortunately, it is in many cases

1. Barratt, J. O. Wakelin, and Harris, A. B. *Loc. cit.*, p. 225.

difficult, when employing dissolved substances in experiments on electro-osmosis, to be quite sure that an ionisation effect is wholly excluded.

It is obvious that a solution of the problem whether non-electrolytes can be introduced into the skin by electro-osmosis is best approached by first ascertaining if dissolved substances can be made to pass by electro-osmosis through colloidal membranes. This aspect of the enquiry will alone be dealt with in this section, experiments made with living tissues being reserved for a subsequent communication.

This problem has already been studied by Oker Blom,¹ who introduced I-ions by means of electrolysis into colloidal masses. As a want of correspondence between the calculated amounts I-ions which should have been introduced by the strength of current used, and the amounts actually present in the gel at different distances from the site of entry of the current occurred, Oker Blom concluded that evidence of a kataphoric action of the current had been obtained.

Our own experiments directed to the investigation of this problem have been made with two dissolved substances, namely glucose and iodine.

In the first series of experiments a plug of filter paper contained in a glass bulb was moistened with a 5 per cent. solution of glucose in distilled water, and an electric current caused to pass through it for a period of time sufficient to permit of the passage of so large an amount of liquid by electro-osmosis that any alteration in composition, such as would occur if water were carried to the complete or partial exclusion of glucose, would be readily determined.

The apparatus employed (fig. 1, p. 316) consisted of a glass bulb, tightly packed with filter paper, and placed horizontally in a beaker containing a 5 per cent. solution of glucose. At one end the bulb was open, communicating with the liquid in the beaker; a platinum electrode was placed in the beaker opposite this open end. The other end of the bulb was sealed into a vertical tube, also filled with glucose solution, containing another platinum electrode. Connected with the vertical piece were two measuring capillary tubes of two millimetres internal diameter, one above, placed vertically, and the other, placed horizontally, used for measuring the amount of fluid passing by electro-osmosis. The latter tube terminated in a thistle funnel in which the fluid passing could, if desired, be allowed to collect.

1. Oker Blom. 'Beitrag zur Feststellung einer physikalisch-chemischen Grundlage der elektro-medikamentösen Behandlung mit besonderer Berücksichtigung der Jodsalzlösungen,' Kuopio, 1896; 'Experimentelle Untersuchungen über das unter Einwirkung des konstanten elektrischen Stromes stattfindende Eindringen von medikamentösen Stoffen in den Thierkörper,' Willmanstrand, 1898.

In the experiments made the strength of current passing was 8 milliamperes to 10 milliamperes per square centimetre, the potential gradient per centimetre being 23 volts. The amount of fluid passing per square centimetre by electro-osmosis, calculated for a potential fall of 1 volt per centimetre, was 0.10 c.c. to 0.18 c.c. per hour (Table I, Experiments 1 to 3). The current was allowed to pass for fourteen to sixteen hours, during which period the actual amount of fluid which passed through the plug of filter paper was 60 c.c. to 70 c.c.

The fluid passing by electro-osmosis was found to exhibit the same specific gravity as the solution of glucose in the beaker. These experiments, therefore, indicate that the water passing by electro-osmosis through the plug underwent no change in respect of its content of dissolved glucose. It is therefore proven that a non-electrolyte dissolved in water may be carried passively by electro-osmosis through a colloidal membrane. The actual amount of glucose transported during the period of experiment by electro-osmosis was, it may be observed, 3.0 g. to 3.5 g.

In the second series of experiments the dissolved substance employed was iodine in 0.01 N NaCl solution. In these experiments the plug of filter paper was discarded, and instead a hydrogel of gelatine was employed in the form of a thin diaphragm. Before use the gelatine was, in the earlier experiments, allowed to remain in contact with the iodine solution for some time; in some of the later experiments the gelatine was not previously exposed to the action of iodine. It may here be observed that iodine changes the condition of gelatine, rendering it after a time insoluble even in boiling water. It also causes reversal of the direction of electro-osmosis when Na_2SO_4 or NaNO_3 are employed as electrolytes (Table II).¹

The apparatus employed to determine, if the fluid passing by electro-osmosis contained iodine, is shown in fig. 7. It consisted of two short glass tubes, *a*, *b*, closed below by a membrane of gelatine half to one millimetre thick. These tubes were partially immersed in a 0.01M solution of NaCl, containing a small amount of starch solution. The current was conveyed to the cups by non-polarisable electrodes formed by two glass tubes, *c*, *d*, closed below by a plug consisting of a hydrogel of gelatine (10 per cent.), and containing above zinc electrodes, marked + and - in the figure, immersed in a saturated solution of ZnSO_4 . The potential gradient in these experiments was about 10 volts per centimetre,

1. Separate determinations of the direction and amount of fluid and the amount passing by electro-osmosis were made with the apparatus shown in Fig. 3.

the strength of current being about 5 milliamperes per square centimetre of gelatine membrane.

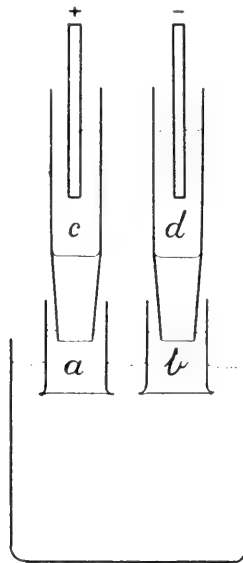

FIG. 7.

In carrying out an experiment the empty tubes, *a*, *b*, were partly immersed in the liquid contained in the beaker as shown in fig. 7, the electrodes, connected to the source of the current, being also placed in position. The iodine solution was then rapidly poured into the cups, *a*, *b*, thus completing the circuit. The object of the latter procedure was to avoid the passage of iodine, by diffusion through the gelatine diaphragm, into the liquid contained in the beaker before the circuit was closed, whereby a blue deposit or coloration would make its appearance in the liquid below the cups before electro-osmosis was set up.

When an experiment was made, as above described, it was found that at the kathode cup iodine passed into the liquid contained in the beaker, a blue deposit or cloud appearing at the under surface of the gelatine, while at the anode cup no blue coloration appeared. If the current was reversed, a blue coloration or deposit appeared below the gelatine diaphragm of the former anode cup, while no further coloration appeared beneath the former kathode cup. Thus the iodine passed in the direction of electro-osmosis, from kathode to anode.

It appears to be admissible to conclude that in these experiments the dissolved iodine passes in the unionised condition through gelatine under the action of electro-osmosis.

THE PHOSPHATIDES OF THE KIDNEY

BY HUGH MACLEAN.

*From the Lister Institute, Bio-Chemical Department**(Received June 20th, 1912)*

The researches of Erlandsen¹ on the phosphatides of cardiac muscle showed that the older methods of extracting tissues with alcohol did not suffice to isolate pure substances, and that the so-called lecithin obtained was really a mixture. According to this investigator the phosphatides contained in the ethereal extract of dried cardiac muscle consisted chiefly of two substances—lecithin with a nitrogen : phosphorus ratio of 1 : 1, and cuorin with a nitrogen : phosphorus ratio of 1 : 2. Another ether soluble substance, however, was present in large amount, but was incapable of being extracted by ether until the tissue had undergone a preliminary treatment with alcohol. This behaviour towards ether suggested that this substance was present in the tissue in some combination which was split up by the alcohol, or that the ether did not penetrate the dried tissue sufficiently well to extract it. Erlandsen extracted this substance by means of alcohol after a thorough preliminary treatment of the tissue with ether, and found that the greater part of the alcoholic extract consisted of a phosphatide which differed materially in constitution from lecithin and cuorin, and contained in its molecule two atoms of nitrogen to one of phosphorus.

These observations of Erlandsen strongly supported the combination view, for if the ether were incapable of penetration as the result of purely physical conditions, it is difficult to understand why there should be any material difference in the nature of the phosphatide obtained in the ether and alcohol extracts respectively.

These results with cardiac muscle suggested that other tissues probably behave in a similar manner towards ether and alcohol, and in order to determine this the following investigation of kidney phosphatides was carried out.

PREPARATION OF MATERIAL

Horse kidneys were used on account of their cheapness and the ease with which large supplies could be obtained. In the first experiment fifteen fresh kidneys were washed with normal saline solution and freed

as much as possible from adherent fat and fibrous tissue. They were then passed through a mincing machine, and the finely divided tissue dried on a glass plate by means of a fan at a temperature of about 30°. The dried substance obtained was now dried in a desiccator over sulphuric acid and finely ground in a mill to a fine powder.

EXTRACTION WITH ETHER

The dried powder, which weighed 2075 grams, was shaken up with ether in a dark, well-stoppered bottle, which contained CO_2 in order to prevent oxidation. After extracting six times, the ethereal extracts were evaporated to very small bulk under reduced pressure and at room temperature. The residue, which now formed a syrupy mass, was treated with a large excess of acetone and the mixture allowed to stand for half an hour. The precipitate which formed was separated from the ether-acetone liquid, dissolved in some pure ether, and again precipitated by acetone. It was then thoroughly washed with acetone and dried in vacuo. By this treatment with acetone, most of the ordinary fat and cholesterol was separated. In separating phosphatides from fat by means of acetone, it is important to separate the precipitate from the ether-acetone solution in a short time, for though acetone first precipitates phosphatides from an ethereal solution, it gradually precipitates such substances as neutral fat and certain saturated fatty acids. The crude phosphatide obtained weighed about 29 grams.

TREATMENT OF CRUDE PHOSPHATIDE OF ETHEREAL EXTRACT

The crude extract was dissolved in about 150 c.c. ether, and an opalescent solution obtained which on centrifuging yielded a fair amount of a white precipitate and a clear dark amber-coloured fluid. The phosphatides were precipitated from this solution by the addition of excess of acetone, and dried in vacuo. This process of dissolving in ether, centrifuging and treating with acetone was repeated four times. All the white precipitates obtained on centrifuging were mixed together, and for purposes of reference may be called 'white substance.'

The phosphatide residue was dissolved in 100 c.c. ether and gave an almost clear solution; to this 500 c.c. absolute alcohol were added, and the mixture left to stand in an ice-room overnight. Immediately on the addition of the alcohol, a precipitate formed which became more marked on standing. After sixteen hours, this precipitate was separated by

filtration and washed thoroughly with alcohol. It was then dissolved in ether, precipitated by acetone and dried in vacuo.

An ether-alcohol solution (*b*) and a precipitate (*a*) were thus obtained.

TREATMENT OF ALCOHOL-INSOLUBLE SUBSTANCE (*a*)

This substance was treated with alcohol at 45° C., and the residue dried in vacuo, dissolved in ether and precipitated by acetone. After drying it was re-dissolved in freshly distilled hot ethyl acetate and allowed to stand for some hours in the ice-room, when a substance of syrupy consistency fell out. This treatment with ethyl acetate was repeated and the syrup obtained dried and analysed.

All the above operations were carried out as far as possible in an atmosphere of CO₂ to prevent oxidation; at the same time an endeavour was made to prevent any deleterious action of light by the use of dark glass desiccators and bottles.

TREATMENT OF ETHER-ALCOHOL SOLUTION (*b*)

This liquid was evaporated under reduced pressure at a temperature of about 35° C., and a small amount of a substance obtained, which was dissolved in pure ether and precipitated by acetone. This substance, which represents ordinary 'lecithin,' was dried and analysed.

TREATMENT OF 'WHITE SUBSTANCE' OBTAINED BY CENTRIFUGE

This substance was first treated with cold alcohol, when a small amount of it dissolved. On filtering, the residue was extracted with hot alcohol, when a considerable amount easily went into solution, while part seemed quite insoluble. The solution was filtered hot and the filtrate left to stand at room temperature, when a white flocculent substance separated out. This substance was filtered off, again dissolved in hot alcohol and filtered hot as before. The flocculent substance obtained was thoroughly washed with cold ether, in which it was practically insoluble; it was then treated with hot ether and dried. The part insoluble in hot alcohol was composed chiefly of inorganic salts and was not further investigated.

From the ethereal extract of kidney, three substances were now obtained.

- (1) *A small amount of a substance soluble in hot alcohol but insoluble in ether. 'White substance.'*
- (2) *A substance soluble in alcohol and in ether—lecithin.*
- (3) *A substance insoluble in alcohol but soluble in ether—Cuorin.*

It is interesting to note that only a very small amount of ordinary lecithin was found. The greater part of the ethereal extract was composed of the alcohol insoluble portion, of which about 13 grams were isolated, while only about 2.5 grams lecithin were obtained.

(1) '*White substance*' separated by centrifuge

The total amount of this substance obtained was only 0.55 gram. On analysis it gave the following figures. Nitrogen and phosphorus were estimated by the methods of Kjeldahl and Neumann respectively.

Nitrogen

0.3125 gm. used 6.6 c.c. N/10 H₂SO₄ = 2.9 per cent. Nitrogen.

Phosphorus

0.1120 gm. used 7 c.c. N/2 NaOH = 3.46 per cent. Phosphorus.

N : P = 1.86 : 1.

While it is probable that this substance was not quite pure, the small quantity obtained rendered it very difficult to get quite accurate figures; it is practically a diamino-monophosphatide, and from its general appearance and properties is probably of the same nature as a similar substance described under the alcoholic extract of the kidneys.

Thus it was practically insoluble in cold ether and only very slightly soluble in cold alcohol, in hot alcohol it dissolved with ease and separated out on cooling as a flocculent substance which on drying formed a white non-hygroscopic powder. In chloroform and benzene it dissolved easily, especially on heating; cold glacial acetic acid dissolved it with some difficulty, but on heating it dissolved readily. From these solutions it was precipitated by acetone. In general it bears a close resemblance to a substance described by Stern and Thierfelder,² and isolated by them from egg yolk.

(2) *Alcohol and ether soluble substance—Lecithin*

This fraction had all the properties of the mono-amino-monophosphatide—lecithin. It was of somewhat waxy consistence, yellowish white in appearance and very hygroscopic. In vacuo it dried very quickly to constant weight, but was sticky to the touch and incapable of being powdered. In ether, alcohol, benzene, chloroform and petroleum ether it dissolved with ease and was readily precipitated from these solutions by acetone. In ether it gave a slightly opalescent solution which cleared up in a short time to a clear dark liquid.

Analyses

0.1021 gm. substance gave 0.2385 gm. CO_2 = 63.7 per cent. C.
and 0.1040 gm. H_2O = 11.3 per cent. H.

Nitrogen

0.3219 gm. used 4.5 c.c. $\text{N}/10 \text{H}_2\text{SO}_4$ = 2.0 per cent.

0.6123 gm. used 8.5 c.c. $\text{N}/10 \text{H}_2\text{SO}_4$ = 1.94 per cent.

Average = 1.97 per cent. Nitrogen.

Phosphorus

0.3202 gm. used 21.8 $\text{N}/2 \text{NaOH}$ = 3.77 per cent.

0.2151 gm. used 16 c.c. $\text{N}/2 \text{NaOH}$ = 3.9 per cent.

Average = 3.83 per cent.

N : P = 1.14 : 1.

It is probable that this lecithin was not quite pure, as the ratio of nitrogen to phosphorus is somewhat too high. In general, however, it agrees well with the lecithins described by Stern and Thierfelder,² and by Erlandsen,¹ as the following table shows.

ANALYSES OF DIFFERENT LECITHINS

		Lecithin from horse kidney	Lecithin from heart muscle (Erlandsen)	Lecithin from egg yolk (Stern and Thierfelder)
C	63.7	66.29	64.63
H	11.3	10.17	10.96
N	1.97	1.87	2.08
P	3.83	3.95	3.97
N : P ratio	1.14 : 1	1 : 1	1.16 : 1

On hydrolysis a substance which gave the reactions of glycerophosphoric acid was obtained as well as choline, but, as in other lecithins, the yield of choline obtained was considerably less than the theoretical amount.

In order to determine the iodine value of the lecithin, a small amount was prepared specially for the purpose, as it was found that even when preserved in as complete a vacuum as possible, the iodine number gradually diminished. This specially prepared substance was isolated and purified as quickly as possible, and gave an iodine value of 85. The free fatty acids obtained from this sample by saponification with alcoholic potash in an atmosphere of hydrogen gave an iodine value of 113. It is probable, however, despite the precautions taken, that a certain amount of oxidation had occurred, so that the value obtained is perhaps somewhat low.

No saturated acids were found while bromine derivatives of acids, having three or more unsaturated bonds, were prepared.

The nature of the acids present in lecithin and other phosphatides will be discussed in a later paper.

(3) *Substance insoluble in alcohol but soluble in ether—Cuorin*

While a comparatively small amount of lecithin was found in the ethereal extract, a considerable amount of cuorin was present.

It was obtained as a yellowish transparent substance, which was exceedingly hygroscopic, but dried quickly in vacuo to a hard solid mass, which was easily reduced to a fine powder. It dissolved at room temperature in ether, petroleum-ether, carbon disulphide, and chloroform; while it was practically insoluble in cold ethyl acetate, it dissolved easily on heating; on cooling it separated out as a syrupy mass. In cold and hot alcohol it was quite insoluble. This substance oxidised with great readiness, so that it was difficult to keep it unchanged for any length of time; as it oxidised, it gradually changed its solubility, and, after a time, it became insoluble in ether and somewhat soluble in water.

It was precipitated by acetone out of its ethereal solution; platinum chloride and cadmium chloride gave insoluble combinations.

The iodine value of the freshly prepared substance was 100, while that of the fatty acids was 133. Even when kept in an evacuated desiccator the iodine value gradually diminished, so that after a fortnight it was only 83; on exposure to the air it decreased in about a week to 52.

Analyses

0.1216 gm. substance gave 0.2695 gm. CO_2 = 60.4 per cent. C.
and 0.1120 gm. H_2O = 10.2 per cent. H.

Nitrogen

0.5216 gm. used 3.8 N/10 H_2SO_4 = 1.02 per cent.

0.6210 gm. used 4.7 N/10 H_2SO_4 = 1.06 per cent.

Average = 1.04 per cent. N.

Phosphorus

0.3105 gm. used 25.2 c.c. N/2 NaOH = 4.49 per cent.

0.2108 gm. used 16.8 c.c. N/2 NaOH = 4.41 per cent.

Average = 4.45 per cent. P.

N : P = 1 : 1.93.

A comparison of this substance with the cuorin described by Erlandsen shows that it agrees exactly with the analysis of cuorin. A

somewhat similar substance has been isolated by Baskoff from the liver, but though its properties are similar to those of cuorin, it gave somewhat different figures on analysis. It is probable that this substance, which Baskoff called heparphosphatid, was not isolated in a pure form, and the fact that it contains sulphur strengthens this idea.

A somewhat similar substance which I isolated from egg yolk³ differed in its percentage of nitrogen and phosphorus from this substance, but had a N : P ratio of exactly 1:2.

COMPARISON OF ANALYSES OF DIFFERENT MONO-AMINO-DIPHOSPHATIDES HITHERTO ISOLATED

	Substance from horse kidney (MacLean) [†]	Cuorin from heart muscle (Erlandsen)	Heparphosphatid from liver (Baskoff)	Mono-amino - diphosphatide from egg yolk (MacLean)
C	60.4	61.33	61.12	59.12
H	10.2	9.02	8.95	9.44
N	1.04	1.01	1.23	0.812
P	4.45	4.47	4.0	3.59
N : P ...	1 : 2	1 : 2	1 : 1.5	1 : 2

These figures indicate that the substance obtained from horse kidney is the same as that obtained from heart muscle by Erlandsen.

On saponification with alcoholic potash, 60 per cent. of the weight of cuorin was obtained as fatty acids, which were solid at room temperature and melted at about 45°.

They were composed of one solid saturated acid and two unsaturated liquid acids; the solid acid was found to be stearic, while the liquid acids, as in the case of lecithin, gave bromination products, indicating the presence of acids having three or more double bonds. They will be discussed, along with the acids of lecithin, in a later paper.

The other cleavage products consisted of a substance having the reactions of glycerophosphoric acid, though the amount of barium obtained on analysis of the barium salt did not quite agree with the theoretical amount. Only a very small amount of a basic substance precipitated by platinum chloride could be obtained, so it is certain that the nitrogen is not represented by choline.

From these results it is clear that the acetone insoluble phosphatides present in the ethereal extract of horse kidneys are of the same nature as those described by Erlandsen from heart muscle. In spite of the observation of Fraenkel that he could not obtain any evidence of the presence of lecithin in the kidney, there can be no doubt that a small amount is present in the ethereal extract. It will be shown later that

quite a considerable amount of lecithin is present in the alcoholic extract.

The three substances present in the ethereal extract of kidney are therefore lecithin, cuorin and a diamino-monophosphatide. Cuorin was found in greatest amount, while only a small quantity of lecithin and a very small amount of the diamino-monophosphatide was isolated.

THE ALCOHOLIC EXTRACT

Our knowledge of the phosphatides present in the alcoholic extract of the different tissues is very unsatisfactory. According to Erlandsen, by far the greater part of the extract consists of a phosphatide having a N : P ratio of 2 : 1.

This observation was based on the analyses of cadmium chloride compounds, but he was unable to isolate the substance in a free state. An attempt to liberate the phosphatide from the cadmium compound was unsuccessful, the substance obtained differing in its constitution from the theoretical composition deduced from the cadmium salt. In order to explain this result, Erlandsen assumed that the manipulations required for setting free the phosphatide resulted in a partial decomposition of this body, but it is interesting to observe that the N : P ratio of the substance obtained was 1.48 : 1.

Baskoff extracted the liver, first with alcohol, then with ether, and lastly with 96 per cent. alcohol. This second alcoholic extract was evaporated to small bulk in vacuo, and the residue dissolved in a small amount of alcohol. An insoluble fraction remained which consisted chiefly of inorganic substances. The alcoholic filtrate was now evaporated to dryness, and the residue extracted with ether, when a white substance was obtained and filtered off. This substance contained 4.16 per cent. nitrogen and 2.52 per cent. phosphorus = N : P 3.68 : 1, and was regarded by Baskoff as a jecorin-like substance. The ethereal solution was concentrated and precipitated with acetone, the precipitate dissolved in ether and some alcohol added. A precipitate was now obtained which on analysis gave 4.703 per cent. nitrogen and 1.93 per cent. phosphorus = N : P 5.07 : 1.

After filtering off this substance the ether-alcohol solution was evaporated to dryness and the residue dissolved in ether and precipitated by acetone. This fraction constituted by far the greater part of the alcohol soluble substance; it was once again purified by ether and acetone. This substance was now analysed and compared with a corresponding body obtained by Erlandsen from heart muscle.

				Baskoff's substance	Erlandsen's substance	
					I	II
P	3.39 %	3.28	3.01
N	3.91 %	3.63	3.53
P : N				1 : 2.55	1 : 2.50	1 : 2.59

These figures show that the substances contain nearly the same amount of nitrogen and phosphorus, the N : P ratio in each case being practically the same.

From this substance Erlandsen succeeded in isolating a cadmium chloride compound which gave a N : P ratio of exactly 2 : 1, while on the contrary Baskoff's cadmium compound had a N : P ratio of 1.57 : 1.

These results suggest that the substances thus obtained were not quite pure, and evidence in support of this will be brought forward later. Baskoff agrees with Erlandsen that the alcohol extract contains phosphatides with a higher nitrogen content than those of the ether extract, though he was unable fully to substantiate Erlandsen's results. It is noteworthy that both the jecorin-like substances and the alcohol soluble phosphatides all contain a high percentage of nitrogen.

TREATMENT OF ETHER EXTRACTED TISSUE

After thorough treatment with ether, the kidney substance was extracted with alcohol, first at room temperature and then at 40° C. This was repeated six times, the combined alcohol extracts evaporated off under reduced pressure and the residue extracted with pure ether. A considerable amount of substance was obtained which gave a very opalescent solution with ether. This was left to stand, the supernatant fluid treated with excess of acetone and the crude phosphatide obtained dried in vacuo.

TREATMENT OF CRUDE PHOSPHATIDE MIXTURE

The dried crude substance, which weighed about 50 grams, was now dissolved in ether, and gave a somewhat opalescent solution which soon cleared up, leaving a small amount of a white insoluble precipitate. This was filtered off, the ethereal solution precipitated by acetone, the precipitate dried and extracted with a small amount of absolute alcohol. A very turbid liquid was obtained. On centrifuging, a white precipitate (*a*) separated, and a clear alcoholic solution was obtained.

This solution was evaporated to dryness under reduced pressure at a low temperature, and the residue taken up in alcohol. The alcoholic

solution was at first somewhat turbid, but soon became quite clear. On standing in the ice-room overnight a white substance was precipitated which, on separation by the centrifuge, was washed twice with a small amount of cold alcohol = white precipitate (*b*).

This precipitate (*b*) was now mixed with precipitate (*a*), and the whole extracted twice with hot acetone. The residue was only partly soluble in ether and in alcohol.

On analysis it was found to contain 6.2 per cent. nitrogen and 1.5 per cent. phosphorus; it was not further examined.

The alcoholic solution was again evaporated to dryness, and the residue dissolved in a very small amount of alcohol by the aid of gentle heat. On standing in the ice-room overnight some more white substance separated out. After filtering, the alcoholic extract was evaporated to small bulk and about five times its volume of pure ether added, a precipitate consisting partly of a white powder and partly of a slimy mass formed and was filtered off. This precipitate was washed with ether, in which the white substance remained in suspension while the slimy portion remained at the bottom of the vessel.

The ethereal suspension was syphoned off and left to stand, when the white particles fell to the bottom of the glass. On separating the ether a perfectly white substance was obtained which, on drying, formed a white solid mass which was easily broken up to a white powder = white powder (*d*).

The slimy mass obtained was dried in vacuo = substance (*f*). The alcohol-ether filtrate was evaporated to dryness and the residue dissolved in ether, when a perfectly clear solution was obtained after standing a short time. This was precipitated by acetone, the precipitate again dissolved in ether and reprecipitated by acetone. The substance obtained gave a clear solution in alcohol, while in ether it was at first somewhat cloudy, but on standing soon became quite clear.

This substance was now dissolved in alcohol and three times its volume of acetone added. A precipitate at once formed which was filtered off, dissolved in ether, precipitated by acetone, and dried. This fraction constituted by far the greater part of the phosphatides of the alcoholic extract = phosphatide (*m*). On adding more acetone to the above acetone-alcohol solution a slight cloudiness was in evidence, but on the addition of great excess of acetone a white sticky substance separated, which differed in appearance from substance (*m*) above. This will be referred to as phosphatide (*p*).

As it was thought that these two fractions might differ in constitution, they were dried and analysed separately. The fraction (*m*), which was at first easily soluble in alcohol, became partly insoluble after some time, while precipitate (*p*) remained soluble for a much longer time.

From the alcoholic extract four fractions were now obtained.

- (1) Lecithin-like substance (*m*) about 16 grams.
- (2) Lecithin-like substance (*p*) ,, 2.5 grams.
- (3) White substance ... (*d*) ,, 3.1 grams.
- (4) Slimy mass ... (*f*) ,, 3.5 grams.

SUBSTANCE (*m*)

This was obtained as a yellowish white lecithin-like substance soluble in alcohol, ether, chloroform, benzene and petroleum-ether. It dried quickly to constant weight, was very hygroscopic, and had all the general properties of lecithin.

Analyses

Nitrogen—

1.0460 gm. used 36.2 N/10 H₂SO₄ = 4.9 per cent.

0.9027 gm. used 31.5 N/10 H₂SO₄ = 4.9 per cent.

Average = 4.9 per cent. N.

Phosphorus—

0.4172 gm. used 27.48 c.c. N/2 NaOH = 3.65 per cent.

0.4691 gm. used 30 c.c. N/2 NaOH = 3.54 per cent.

Average = 3.59 per cent. P.

N : P = 3 : 1.

From the nitrogen phosphorus ratio it seemed as if this might possibly be a pure phosphatide, and to determine this the cadmium chloride compound was prepared.

Five grams of the substance were dissolved in alcohol, and an alcoholic solution of cadmium chloride added as long as a precipitate formed. The alcohol was then filtered off, the precipitate washed thoroughly with alcohol, dried and analysed.

Analyses of cadmium chloride salt

Nitrogen—

0.7028 gm. used 11.8 c.c. N/10 H₂SO₄ = 2.35 per cent.

0.3504 gm. used 6 c.c. N/10 H₂SO₄ = 2.4 per cent.

Average = 2.3 per cent. N.

Phosphorus—

0.3264 gm. used 19.4 c.c. N/2 NaOH = 3.3 per cent.

0.2603 gm. used 15.9 c.c. N/2 NaOH = 3.4 per cent.

Average = 3.35 per cent. P.

N : P = 1.5 : 1.

From this result it was obvious that the substance (*m*) was not a chemical entity, and that the precipitation with cadmium chloride had separated off a large amount of the nitrogen. Analysis of 100 c.c. of the alcoholic filtrate obtained from the cadmium chloride precipitation showed that a very great excess of nitrogen was present. As cadmium chloride does not precipitate phosphatides quantitatively out of alcoholic solution, it is probable that part of the nitrogen was accounted for in this way. On the other hand, some nitrogenous substance free from phosphorus must have been present.

Analysis of filtrate

50 c.c. filtrate used 31.5 c.c. N/10 H₂SO₄ = 0.88 per cent. N.

50 c.c. filtrate used 12.6 c.c. N/2 NaOH = 0.14 per cent. P.

N : P = 14 : 1.

These results proved that the phosphatide present could not be of the nature of the diamino-monophosphatide found by Erlandsen in heart muscle.

An endeavour was made to decompose the cadmium chloride compound in order to investigate the phosphatide set free, but the amount of substance at my disposal was too small to give a definite result.

Another sample of cadmium chloride phosphatide prepared from the substance (*m*) was washed very thoroughly with alcohol and gave the following figures:—

0.3590 gm. required 6.55 c.c. N/10 H₂SO₄ = 2.50 per cent. N.

0.3120 gm. required 18.6 c.c. N/2 NaOH = 3.3 per cent. P.

N : P = 1.6 : 1.

It would thus seem that thorough washing of the cadmium compound does not materially alter the result.

As already mentioned, part of the substance (*m*) became insoluble in alcohol after being kept for some time. This was dissolved in ether, precipitated by acetone and the nitrogen and phosphorus estimated. It contained 2.35 per cent. nitrogen and 3.46 per cent. phosphorus = N : P 1.5 : 1. On adding an alcoholic solution of cadmium chloride to

an ethereal solution of this substance, a precipitate was obtained which had a N : P ratio of 1·2 : 1.

The inference drawn from these results was that the substance present was possibly a lecithin with a N : P ratio of 1 : 1, for since the treatment with cadmium chloride caused such a marked difference in the nitrogen percentage of the substance it was quite probable that an impurity was present, all of which was not removed. Further purification of the substance, however, by dissolving in ether and precipitating with acetone did not appreciably change the nitrogen percentage, and it was obvious that a pure substance could not be obtained by this method.

SUBSTANCE (*p*)

This was also a lecithin-like body, but much whiter in appearance than the fraction described above. It had the properties and solubilities of ordinary lecithin.

Analyses gave the following results:—

Nitrogen

0·6384 gm. used 25·5 c.c. N/10 H₂SO₄ = 5·4 per cent

0·7544 gm. used 28·25 c.c. N/10 H₂SO₄ = 5·2 per cent.

Average = 5·3 per cent. N.

Phosphorus

0·5717 gm. used 28·35 c.c. N/2 NaOH = 2·7 per cent.

0·4220 gm. used 22·74 c.c. N/2 NaOH = 2·9 per cent.

Average = 2·8 per cent. P.

N : P = 4·2 : 1.

This substance differed materially from substance (*m*), the percentage of nitrogen being much higher and that of phosphorus being considerably lower. This result also suggested that the substance was impure, but owing to lack of material a cadmium chloride combination could not be investigated.

Some of these experiments were repeated with other samples of phosphatides obtained by alcohol extraction in the manner described. It was found, however, that fractions corresponding to (*m*) and (*p*) contained different amounts of nitrogen from these fractions. This was taken as strong evidence that the phosphatide of the alcoholic extract contained impurities which had not hitherto been separated by any of the methods in use at present. After many attempts at purification of this lipid, a

method was at last found which solved all the difficulties and showed that the different results obtained were really due to the presence of nitrogenous impurities.

PURIFICATION OF THE PHOSPHATIDES OF THE ALCOHOLIC EXTRACT

In the course of this investigation it was observed that when the residue of the alcoholic extract was shaken up with water, the fluid became coloured, suggesting that part of the substance had passed into solution. Since phosphatides are ordinarily insoluble in water, it was thought that extraction with water might result in a purer substance being obtained, since obviously something more than phosphatide was present.

Part of fraction (*m*), described above, was therefore treated as follows:—Several grammes were taken and rubbed up in a mortar with a small quantity of water. When the substance was thoroughly broken up, more water was gradually added, and a dilute aqueous emulsion obtained. To this was added a small amount of pure acetone, when a white substance at once separated out and floated on the surface of the fluid. This was easily skimmed off, when the water-acetone fluid was found to be yellow in colour. The white substance separated was subjected to the same process several times in order to ensure access of the water to the fatty lipid particles. The final product was thoroughly extracted with pure acetone, dried and analysed. The result was exceedingly satisfactory, as it showed that a great deal of nitrogen was got rid of by this method, while at the same time the purified substance had a N : P ratio of nearly 1 : 1.

Analyses of substance (*m*), which had been treated three times with water and acetone, gave results very similar to those obtained from ordinary lecithin.

Analyses of purified substance

Nitrogen—

0·3989 gm. used 5·8 c.c. N/10 H₂SO₄ = 2·1 per cent.

0·4770 gm. used 7 c.c. N/10 H₂SO₄ = 2·06 per cent.

Average = 2·08 per cent. N.

Phosphorus—

0·3800 gm. used 26·6 c.c. N/2 NaOH = 3·88 per cent

0·2158 gm. used 15 c.c. N/2 NaOH = 3·9 per cent.

Average = 3·9 per cent. P.

N : P = 1·18 : 1.

Thus a substance having originally a N : P ratio of 3 : 1 and containing 4.9 per cent. nitrogen had, after being three times treated as above described, only about 2 per cent. nitrogen and a N : P ratio of 1.18 : 1.

After being emulsified and precipitated six times it gave the same figures as ordinary lecithin.

Nitrogen

0.6516 gm. used 9.2 c.c. N/10 H₂SO₄ = 1.97 per cent. N.

Phosphorus

0.2900 gm. used 21.3 c.c. N/2 NaOH = 4.07 per cent. P.

N : P = 1.07 : 1.

This proved that the ether soluble lecithin-like substance present in the alcohol extract of the kidney is really a monamino-monophosphatide and not a diamino-monophosphatide as described by Erlandsen in heart muscle. This point is further discussed in the following paper 'On the purification of phosphatides.'

WHITE SUBSTANCE (*d*)

This white substance isolated as described formed on drying a whitish yellow non-hygroscopic powder. Before making any attempt to purify it, an analysis was made, which showed that it was probably an impure substance.

Nitrogen

0.3076 gm. used 6.6 c.c. N/10 H₂SO₄ = 3 per cent. N.

Phosphorus

0.4020 gm. used 13.45 c.c. N/2 NaOH = 1.85 per cent. P.

N : P = 3.6 : 1.

This impure substance was partly soluble in benzene, and in chloroform, from which it was precipitated by acetone; it was slightly soluble in ether, and gave Lassaigue's test for nitrogen and the ammonium molybdate test for phosphorus. After boiling with weak HCl it reduced Fehling's solution. No glycogen reaction was obtained, and Millon's protein reaction was also negative. In H₂O part of it seemed to dissolve; the aqueous solution contained abundance of chlorides but no sulphates. The substance was now shaken up with water several times until the filtrate gave no chloride reaction. On testing the

aqueous filtrate it was found to contain a considerable amount of nitrogen. This treatment of the substance with water was very tedious on account of the difficulty of filtration. The addition of water to the powder gave rise to a more or less sticky opalescent mass like thick starch paste, which quickly closed up the pores of the filter paper. The use of the centrifuge evaded this difficulty to some extent, but as the washing proceeded, precipitation was very incomplete, probably due to the absence of salts, and some loss of substance was unavoidable.

Analyses of the purified substance showed that it differed materially from the crude material.

Analyses

0.1190 gm. substance gave 0.2980 gm. CO_2 = 68.3 per cent. C
and 0.1335 gm. H_2O = 12.46 per cent. H.

Nitrogen

0.3586 gm. used 7.7 c.c. $\text{N}/10 \text{H}_2\text{SO}_4$ = 3 per cent. N.

Phosphorus

0.2346 gm. used 14.55 c.c. $\text{N}/2 \text{NaOH}$ = 3.44 per cent. P.
N : P = 1.93 : 1.

Thus a substance was obtained which had a nitrogen phosphorus ratio of almost exactly 2 : 1, and was probably the same substance as that described under the ether extract.

PROPERTIES

This white substance formed a tasteless and odourless powder, which was non-hygroscopic and preserved its properties after being exposed to the air for a considerable time. It was practically insoluble in cold or hot ether, but easily dissolved in ethyl alcohol, especially on heating; from concentrated alcoholic solution it separated on cooling to room temperature. It was insoluble in acetone but soluble in hot methyl alcohol, from which it crystallised out on cooling, as in the case of ethyl alcohol. In chloroform, benzene, glacial acetic acid and pyridine, it dissolved at ordinary temperature but very easily on heating. With water it formed an opalescent starch-like mixture, from which it was precipitated by the addition of acetone. On boiling for some time with weak HCl it reduced Fehling's solution, decolourised safranin, and gave all the ordinary sugar reactions. It contained no sulphur.

The alcoholic solution was neutral and gave a precipitate with cadmium chloride and with platinum chloride, also with lead acetate.

On boiling with acids it yielded a substance which formed a double salt with platinum chloride and gave the reactions of choline. The amount obtained was much less than that represented by the nitrogen present, amounting to somewhat less than 50 per cent. of the theory. No glycerine could be obtained, but owing to the relatively small amount of substance isolated and the difficulties of testing for this substance, no definite statement as to its absence can be made.

On hydrolysis, about 65 per cent. of fatty acids were obtained. The existence in the tissues of substances similar to the above was first suggested by Thudichum, who isolated from the brain three substances which he named apomyelin, sphingomyelin and amidomyelin.

Substances of this nature were afterwards described by Stern and Thierfelder, who isolated a diamino-monophosphatide from egg yolk, and by Erlandsen, who found a somewhat similar substance in heart muscle. Dunham and Jacobson also obtained a substance from ox kidney, which had a nitrogen phosphorus ratio of 3 : 1, but in other respects was very similar to certain of the above substances.

It has already been shown that the so-called diamino-monophosphatide isolated by Erlandsen was probably a mixture, as from a similar substance prepared from the kidney I succeeded in obtaining ordinary lecithin with a nitrogen to phosphorus ratio of 1 : 1. Erlandsen's substance also differed from the above in its physical properties, and especially in the fact that it was soluble in ether. The bodies described by Thudichum as sphingomyelin and amidomyelin were both in many respects similar to the substance isolated by me. In ether and cold alcohol they were only very slightly soluble and were precipitated from alcoholic solution by cadmium chloride. Amidomyelin was further described as a substance which on drying in vacuo formed a white mass which could be easily powdered, while sphingomyelin did not form a sticky mass, but was also capable of forming a powder. The properties of amidomyelin are not given. The diamino-monophosphatide described by Stern and Thierfelder agrees in analyses and properties almost exactly with my substance, the most marked difference being that it did not reduce Fehling's solution on boiling.

As the reduction with Fehling's solution is not very marked and is only obtained distinctly when a comparatively large amount of the substance is taken, it is not possible to say at present whether this reaction is due to traces of impurity or is really dependent on a carbohydrate radicle incorporated in the molecule.

The following table shows the results of analyses of these different diamino-monophosphatides.

			Substance from horse kidney (MacLean)	Substance from egg yolk (Stern and Thier- felder)	Substance from heart muscle (Erlandsen) from CdCl ₂ compound	Substances from brain (Thudichum)			Substance from ox kidney (Dunham and Jacobson)
						Apo- myelin	Sphingo- myelin	Amido- myelin	
C	68.19	68.13	59.48	67.01	65.37	62.4	67.12
H	12.37	12.14	9.42	11.35	11.29	—	11.54
N	3.0	2.77	3.47	3.0	2.96	—	2.84
P	3.44	3.22	3.84	3.23	3.24	—	2.18
N : P ratio	...		1.93 : 1	1.9 : 1	2 : 1	2 : 1	2 : 1	—	2.9 : 1

CARNAUBON

This substance, which was described by Dunham and Jacobson as a triamino-monophosphatide, possesses all the properties of the substance isolated from the horse kidney. It is the most fully described and investigated of this class of substances and its composition is given as similar to lecithin, but having, instead of glycerine, another body—galactose—to which the fatty acids are attached. The acids isolated were carnaubic acid, stearic acid, and palmitic acid. Though described as a triamino-monophosphatide, the authors agree that the N : P ratio was often about 7 : 3, and consider the possibility of the substance being impure. In the light of the results of the present investigation, it seems probable that the substance was a diamino-monophosphatide, which treatment with water as above described would have purified.

If so, the question of these ether insoluble phosphatides is much simplified, for the available evidence suggests that all the substances of this nature hitherto isolated are of the nature of diamino-monophosphatides, and are probably identical in structure with pure carnaubon. In order to make certain that the substance isolated from horse kidney was really a diamino-monophosphatide, two more samples were prepared by different methods.

SAMPLE II

This sample was prepared in the same way as that described by Dunham and Jacobson, only it was finally extracted with water. Fresh kidneys were treated with hot 95 per cent. alcohol and the extract

discarded. The residue was extracted first with 95 per cent., and then with 85 per cent. alcohol, and the mixed solutions filtered hot. They were then left to stand in the ice-room. The precipitate formed was collected, dried and dissolved in benzene, the solution filtered, and the benzene evaporated off by distillation under reduced pressure. The syrup obtained was thoroughly mixed with ether and left to stand, when a white precipitate separated. The ether was syphoned off and the residue washed with more ether. It was then dissolved in hot alcohol and left to stand, when a white substance separated out. This was treated with ether, dried in vacuo and extracted with several changes of water as described above. This final treatment with water is important, as otherwise a pure substance is not obtained. The resulting product gave the following figures on analysis:—

Analyses

0.1025 gm. substance gave 0.2567 gm. CO_2 = 68.29 per cent. C.
and 0.1132 gm. H_2O = 12.26 per cent. H.

Nitrogen—

0.3806 gm. used 7.8 c.c. N/10 H_2SO_4 = 2.9 per cent. N.

Phosphorus—

0.2380 gm. used 14 c.c. N/2 NaOH = 3.3 per cent. P.

N : P = 1.95 : 1.

SAMPLE III

This substance was prepared as follows:—The crude alcoholic extract of the kidneys was evaporated to a syrup, excess of acetone added, and the precipitate rubbed up with ether, when an opalescent mixture was obtained. On centrifuging, a white precipitate separated. This white substance was thoroughly extracted with ether and centrifuged three times. The residue was dissolved in hot alcohol and filtered hot. The filtrate, however, was not quite clear, so it was again filtered and a perfectly clear solution obtained; a small quantity of a sticky substance, insoluble in alcohol and in ether, remained on the bottom of the flask.

This clear solution was allowed to stand, and the white substance which separated filtered off and dried. It was then emulsified with water, and after the addition of some acetone, left to stand for twenty-four hours, when a flocculent white precipitate was obtained. This process was repeated twice and the final product dried and analysed. It had the same composition as the two substances formerly described.

Analyses

0.1321 gm. substance gave 0.3292 gm. CO_2 = 68.0 per cent. C

0.1321 gm. substance gave 0.1475 gm. H_2O = 12.4 per cent. H.

Nitrogen—

0.1591 gm. used 3.3 c.c. N/10 H_2SO_4 = 2.9 per cent. N.

Phosphorus—

0.1300 gm. used 8 c.c. N/2 NaOH = 3.4 per cent. P.

$$\text{N} : \text{P} = 1.9 : 1.$$

Both these substances had the same properties as the one first described.

A comparison of their analyses shows that this substance was certainly a diamino-monophosphatide.

COMPARISON OF THREE SAMPLES OF DIAMINO-MONOPHOSPHATIDE

	No. 1	No. 2	No. 3	Average
C	68.3	68.29	68.0	68.19
H	12.46	12.26	12.4	12.37
N	3.0	2.9	2.9	2.93
P	3.44	3.3	3.4	3.38
N : P ratio	1.9 : 1	1.95 : 1	1.9 : 1	1.92 : 1

Since the white substance present in the ether extract agrees with this in composition and properties, it shows that this substance is identical with that described above.

Consideration of the properties of this substance suggest that part of it would be present in the ethereal extract.

GENERAL SUMMARY

The ethereal extract of the horse kidney contains three phosphatides lecithin, cuorin, and a diamino-monophosphatide. The subsequent alcoholic extract also contains a diamino-monophosphatide, which is the same as that obtained in very small amount from the ether extract. This substance is but very slightly soluble in ether, but there is a good deal of evidence to show that it is fairly soluble in an ethereal solution of lecithin. Thus, if the crude phosphatide residue of the ethereal extract of kidney is taken and extracted with ether, a very opalescent mixture is at first obtained, but as the lipoids present dissolve, the solution becomes much clearer. On centrifuging, a perfectly clear ethereal solution is obtained, but if the ether be evaporated off and the residue again extracted with ether, the solution so obtained is by no means clear, and some more

white substance can be separated by the centrifuge; if, however, the solution is allowed to stand for some time before centrifuging, it may become quite clear. Again, when it seems as if all the white substance had been got rid of, it often happens that the addition of ether to the lipid residue gives a solution which becomes clear only after some little time. This property of the diamino-monophosphatide suggests the probability that every sample of lecithin prepared from tissues containing this substance was contaminated by it, and it is difficult to see how complete separation can be achieved, though careful treatment with ether and quick centrifuging undoubtedly gets rid of all but traces. This substance is entirely different from lecithin and other lipoids in its physical properties, as it forms a white non-hygroscopic powder, and not a more or less sticky mass, as is seen in the case of lecithin and cuorin.

Owing to its greater solubility in alcohol, the majority of it is found in the alcoholic extract, but it is present only in comparatively small amount, and is not to be confounded with the substance found by Erlandsen in the alcoholic extract of heart muscle. Erlandsen's substance possessed all the properties of ordinary lecithin and was quite soluble in ether; it constituted also the chief bulk of the phosphatides present in the alcoholic extract. A corresponding substance is present in the kidney in comparatively large amount, but its analyses did not quite compare with that of heart muscle, and on subjecting it to purification by means of H_2O and acetone, it was found to be of the nature of ordinary lecithin, with a nitrogen to phosphorus ratio of 1 : 1.

Thus the lipoids of the alcoholic extract of kidney are the same as the alcohol soluble ones contained in the ethereal extract; the alcohol insoluble substance cuorin, very soluble in ether, is naturally present in the ether extract. The alcohol extract contains other bodies with a high percentage of nitrogen, but these are soluble in water and may be separated in the manner described. The water soluble substances contain only a small amount of phosphorus and are not of the nature of ordinary phosphatides; their nitrogen percentage is very high. From these observations it follows that the subject of the kidney lipoids has been much simplified, and an extension of these results to other organs and tissues will probably show that many of the substances hitherto described as containing large percentages of nitrogen are really mixtures of simpler bodies with these nitrogenous water-soluble bodies mentioned above. Other tissues such as heart muscle, liver and egg yolk, are at present being investigated from this point of view.

CONCLUSIONS

(1) The acetone insoluble phosphatides of the horse kidney are lecithin, cuorin, and a diamino-monophosphatide—carnaubon.

All these are contained in the primary ether extract, while the subsequent alcoholic extract contains lecithin and carnaubon; cuorin, being insoluble in alcohol, is not present here. Thus, so far as solubility allows, the lipoids of the ether extract are the same as those present in the alcoholic extract.

(2) In the kidneys investigated, the ethereal extract contained much more cuorin than lecithin.

(3) A method is described whereby the complicated alcoholic extract can be purified from a nitrogenous substance. In all tissues investigated hitherto, the phosphatides of the alcoholic extract must have been contaminated by this substance; this explains many of the divergent results obtained.

(4) The diamino-monophosphatide isolated has all the properties of a substance found in ox kidney by Dunham and Jacobson, and called by them carnaubon. They state that this substance is a triamino-monophosphatide.

(5) It is probable that carnaubon is not a tri-, but a diamino-monophosphatide, and that the methods used for its isolation by Dunham and Jacobson were inefficient to obtain a pure substance. On extracting a substance obtained by the method employed by the above investigators with water, a diamino-monophosphatide was obtained.

REFERENCES

1. Erlandsen, *Ztsch. f. physiol. Chem.*, LI, p. 71, 1907.
2. Stern and Thierfelder, *Ztsch. f. physiol. Chem.*, LIII, p. 379, 1907.
3. MacLean, *Ztsch. f. physiol. Chem.*, LVII, p. 304, 1908.
4. Fränkel, *Bio-Chem. Ztsch.*, XIX, p. 262, 1909.
5. Baskoff, *Ztsch. f. physiol. Chem.*, LVII, p. 395, 1908.
6. Thudichum, *Physiological Chemistry of the Brain*.
7. Dunham and Jacobson, *Ztsch. f. physiol. Chem.*, LXIV, p. 303, 1910.

ON THE PURIFICATION OF PHOSPHATIDES

By HUGH MacLEAN.

*From the Lister Institute, Bio-Chemical Department**(Received June 19th, 1912)*

In the preceding paper on 'The Phosphatides of the Kidney,' it has been shown that the chief part of the lipoid occurring in the alcoholic extract of horse kidney is not a diamino-monophosphatide as described by Erlandsen¹ in heart muscle, but a monamino-monophosphatide which contains nitrogenous impurities. The phosphatide was freed from these impurities by repeatedly emulsifying with water and adding some acetone when the lecithin separated out, leaving the contaminating substance in solution. In order to obtain fairly complete separation of the phosphatide from the water-acetone mixture, it is necessary to have some salt present, otherwise acetone fails to precipitate the lipoid from its aqueous emulsion; a trace of sodium chloride suffices, and it is only necessary to add a few drops of a weak solution of this substance to the water used for the emulsion in order to ensure good separation. It is important to make the emulsion with water which contains traces of sodium chloride, for the addition of salt after the emulsion is formed gives very unsatisfactory results.

The substance can be very easily emulsified by adding at first a very little water and rubbing up thoroughly in a mortar; more water is gradually added and after each addition the whole is well rubbed up. In this way a very fine emulsion approaching to a colloidal solution is formed, and the best results are obtained when great care is taken to have this emulsion as fine as possible. Both the nitrogen impurity and lecithin are precipitated by acetone, but very much less suffices to separate the lecithin than is required for the precipitation of the other substance; only the minimum quantity of acetone necessary to separate the phosphatide is added. The lecithin rises to the top of the liquid and can be easily skimmed off, while any of the impurity that may be precipitated remains suspended in the liquid and gradually falls to the bottom of the vessel. This separation of the phosphatide is by no means quantitative, and the water-acetone solution always contains a certain amount of lecithin. With care, however, the loss in this way is comparatively small.

As the method of purification had been tested only on kidneys which had been already extracted with ether, some experiments were made on other tissues. At the same time an extension of the kidney experiments was carried out. Since the phosphatide present in the ether extract was the same as that contained in the subsequent alcoholic extract, it is obvious that the primary ether extract, the secondary alcoholic extract, and a control alcoholic extract, without primary treatment of the tissues with ether, should on purification all give a substance with an approximate nitrogen to phosphorus ratio as 1 : 1. This proved to be the case.

KIDNEY EXPERIMENTS

Some kidneys were minced and dried in the usual way. Two portions of the dried substance were then extracted as follows:—

- (a) With ether.
- (b) With alcohol.
- (c) With alcohol after ether (*a* extracted subsequently with alcohol).

(a) *Ether extract*

The ethereal extract was treated as before described in order to separate fat, cuorin and cholesterol. The final lipid obtained was then subjected to the acetone-water purification, dried and analysed. The results show that the substance was a lecithin.

Analyses

0.4242 gm. used 6 c.c. N/10 H_2SO_4 = 1.9 per cent. Nitrogen.

0.2814 gm. used 21 c.c. N/2 NaOH = 4.1 per cent. Phosphorus.

N : P = 1 : 1.

(b) *Alcohol extract without ether*

The dried tissue was extracted six times, first at room temperature, then at 40° C. and the different extracts mixed together. On standing some time a white precipitate formed which was filtered off. The clear extract was now evaporated to small bulk at 40° C. under reduced pressure. On adding ether to the residue a very muddy liquid was obtained, which was treated with excess of acetone in order to get rid of cholesterol and fat. The precipitate obtained from the alcohol-ether mixture was treated several times with cold acetone and finally dried in vacuo over H_2SO_4 . This crude substance was dissolved in a small amount

of ether and centrifuged, when a white precipitate was obtained. The precipitate was discarded and the clear supernatant fluid treated with acetone. The precipitate was again thoroughly extracted with acetone, dissolved in alcohol and left to stand in the ice-room overnight. A precipitate formed which was filtered off. This process was repeated until a concentrated alcoholic solution produced little or no precipitate when left to stand in the ice-room. The alcohol was then evaporated off and the residue extracted with ether. A fair amount of a slimy substance (κ) remained behind at the bottom of the vessel. The ether solution was now treated with acetone and the precipitate dried. It was then emulsified and precipitated with acetone eight times, extracted with acetone, dried and analysed. It gave the following figures.

Analyses

0.4211 gm. used 6.2 c.c. N/10 H_2SO_4 = 2.0 per cent. Nitrogen.

0.2204 gm. used 16.5 c.c. N/2 NaOH = 4.1 per cent. Phosphorus.

N : P = 1.08 : 1.

This substance was therefore a monamino-monophosphatide and so far agreed with that obtained from the ether extract.

(c) *Extract with alcohol after ether*

The different processes utilised for the separation of the phosphatide are the same as described for the alcohol extract above. The final product obtained was treated with water and acetone eight times.

Analyses

0.6241 gm. used 9.5 c.c. N/10 H_2SO_4 = 2.1 per cent. Nitrogen.

0.3216 gm. used 24 c.c. N/2 NaOH = 3.9 per cent. Phosphorus.

N : P = 1.2 : 1.

A comparison of these three substances shows that the analytical figures are practically the same for all three preparations. The slight differences are not greater than can be accounted for by experimental error.

COMPARISON OF THREE PREPARATIONS

	Ether extract	Alcohol extract	Alcohol extract after ether	
			I	II*
Nitrogen ...	1.9	2.0	2.1	1.97
Phosphorus...	4.1	4.1	3.9	4.07
N : P ratio ...	1 : 1	1.08 : 1	1.2 : 1	1.07 : 1

* Sample described in paper on 'The phosphatides of the kidney.'

The results prove that the chief phosphatide of the kidney is lecithin or a lecithin-like substance, and that the method of purification adopted is capable of separating off the impurities associated with this phosphatide.

MUSCLE

Experiments similar to the above were carried out on horse muscle, and three substances corresponding to the fractions described above were obtained.

- (a) Ether extract.
- (b) Alcohol extract without ether.
- (c) Alcohol after ether.

The treatment of the muscle tissue prior to the separation of the different fractions was almost entirely the same as that described for kidney. It is interesting to note that while much 'white substance' was present in the kidney alcoholic extract, little or none of the diamino-monophosphatide was found in muscle.

(a) *Ether extract.*

The phosphatide present, after being separated in the usual way and purified three times with water and acetone, gave the following figures.

Analyses

0.6212 gm. used 8.5 c.c. N/10 H₂SO₄ = 1.9 per cent. Nitrogen.

0.2164 gm. used 15.5 c.c. N/2 NaOH = 4.0 per cent. Phosphorus.

N : P = 1.05 : 1.

(b) *Alcohol extract without ether.*

The crude alcohol extract here contained a great amount of a slimy substance insoluble in ether, similar to a corresponding substance mentioned under kidney. The final impure phosphatide obtained was purified with acetone and water in the usual way, and samples examined at different stages in order to determine how many times it was necessary to emulsify the substance. The crude product, which contained originally nearly 4.0 per cent. of nitrogen, gave the following results:—

Substance emulsified and precipitated once.

Analyses

0.3562 gm. used 5.7 c.c. N/10 H₂SO₄ = 2.24 per cent. Nitrogen.

0.4245 gm. used 30 c.c. N/2 NaOH = 3.9 per cent. Phosphorus.

N : P = 1.3 : 1.

Thus a single treatment reduced the nitrogen percentage from

4 per cent. to 2.24 per cent., and gave a substance having a N : P ratio nearly the same as that of lecithin.

Although this sample of crude phosphatide had been prepared in the usual way, previous to the emulsification treatment it contained over 50 per cent. of its weight of a substance soluble in water. This was obtained from the water-acetone solution by evaporation = substance (κ). The following results were obtained after the phosphatide had been purified four and eight times respectively.

Substance emulsified and precipitated four times.

Analyses

0.3802 gm. used 5.3 c.c. N/10 H_2SO_4 = 1.95 per cent. Nitrogen.

0.2609 gm. used 18.7 c.c. N/2 NaOH = 4.14 per cent. Phosphorus.

N : P = 1.04 : 1.

Substance emulsified and precipitated eight times.

Analyses

0.3750 gm. used 5.1 c.c. N/10 H_2SO_4 = 1.9 per cent. Nitrogen.

0.1790 gm. used 12.8 c.c. N/2 NaOH = 3.97 per cent. Phosphorus.

N : P = 1.06 : 1.

From these results it appears that the first purification by this method is sufficient to remove all but a small amount of impurities. Naturally it becomes much more difficult to get rid of these traces, but the substance obtained after four precipitations was just as pure, judging from the N : P ratio as that obtained after eight precipitations. If care is taken to make a good emulsion, it is probable that only traces of impurities remain after four successive treatments. A fine emulsion is essential in order to provide access of the water to impurities enclosed in the fatty globules.

(c) *Alcohol extract after ether.*

This was purified six times in the usual way and gave the same figures as the other samples.

Analyses

0.6428 gm. used 8 c.c. N/10 H_2SO_4 = 1.8 per cent. Nitrogen.

0.5069 gm. used 3 c.c. N/2 NaOH = 3.9 per cent. Phosphorus.

N : P = 1.02 : 1.

The chief phosphatide of muscle is therefore a lecithin, and the lipid

of the alcoholic extract is the same as the alcohol soluble one present in the ether extract—a monamino-diphosphatide. In muscle a great amount of water soluble substance is present in the alcohol extract, but this does not appear to be a lipid, though it is precipitated by excess of acetone from both its alcohol and aqueous solutions. A comparison of the analytical figures with those obtained from the purified lecithin of kidneys suggests that the phosphatide present in both cases is the same.

On the nature of the nitrogenous-impurity

As already described, on emulsifying the phosphatide obtained from the alcohol extract of muscle and precipitating with acetone, a considerable amount of material remained in solution. This substance was dark in colour, sticky to the touch, and exceedingly tenacious; on drying it formed a hard substance, but could not be powdered. It was exceedingly soluble in water, and in alcohol containing traces of water, but much less soluble in absolute alcohol. It appeared to be absolutely insoluble in ether, by which it was precipitated from solution as a dark, sticky mass. On adding some alcohol to its clear alcoholic solution, a faint white precipitate formed, causing an opalescence which soon cleared up again.

Analyses

Nitrogen—

0.4202 gm. used 18 c.c. N/10 H_2SO_4 = 6.0 per cent. Nitrogen.

0.2231 gm. used 9.8 c.c. N/10 H_2SO_4 = 6.15 per cent. Nitrogen.

Phosphorus—

0.3513 gm. used 9.1 c.c. N/2 NaOH = 1.44 per cent. Phosphorus.

Another sample gave 6 per cent. of nitrogen and only 0.5 per cent. phosphorus, so that it is probable that the latter is present as an impurity. On standing, its aqueous solution deposited small minute white round balls which were but slightly soluble in cold water, but dissolved easily on heating. The substance was practically insoluble in cold, but somewhat soluble in hot alcohol. In ether, chloroform and benzene, it was insoluble. With mercuric chloride it gave a voluminous precipitate. On recrystallising twice from water and alcohol, a pure white substance was obtained. This contained no phosphorus. Analysis gave the following figures:—

0.0934 gm. used 16.6 c.c. N/10 H_2SO_4 = 24.9 per cent. Nitrogen.

Its melting-point was indistinct, but the high nitrogen content and other reactions suggest that it is of the nature of a purin base. Further

experiments on this substance are in progress. After the separation of the white substance, the residue obtained by evaporation of the mother liquor was treated as follows:—An alcohol solution was made and ether added when a precipitate was obtained; this was repeated twice. The substance was now dissolved in water and again precipitated by acetone; the residue was then extracted thoroughly with acetone and ether and dried. On analysis it was found to contain 6 per cent. nitrogen and only about 0·3 per cent. phosphorus. As it has been found that tissues contain a substance which cures beri-beri, some of this material was given to pigeons suffering from polyneuritis in order to test its effect. The result was very marked, as three pigeons exhibiting very severe symptoms were completely cured in a short time. Partially purified lecithin had a certain effect on these pigeons, but a dose of 1 gm. of such lecithin resulted only in an amelioration of the symptoms and no cure was obtained. As many observers have placed it on record that lecithin is more or less efficient in curing beri-beri, it is probable that here we have an explanation of their results. The curative substance is not lecithin, but is present in ordinary lecithin as an impurity. It can be separated, however, by the method above described, and a lecithin so purified has but little effect in curing beri-beri. The whole subject is being investigated and the results will be published at a later date.

CONCLUSIONS

The alcohol soluble phosphatide of kidney and muscle is lecithin with a N : P ratio of 1 : 1.

(1) Though substances containing different amounts of nitrogen are obtained in the different extracts, the application of the method described—emulsification and precipitation with acetone—gives a single product of the nature of an ordinary lecithin. No alcohol soluble substance having a higher percentage of nitrogen than that of lecithin has been found.

(2) From an aqueous extract of the nitrogenous impurity of lecithin a substance of basic nature crystallises out; after the separation of this substance the mother liquor is very effective in curing polyneuritis (beri-beri).

(3) This explains the anomalous results of many observers who have endeavoured to cure pigeons suffering from beri-beri by lecithin.

REFERENCE

1. Erlandsen, *Ztsch. f. physiol. Chem.*, LI, p. 71, 1907.

ON THE RELATIONS OF PHENOL AND META-CRESOL TO
 PROTEINS; A CONTRIBUTION TO OUR KNOWLEDGE
 OF THE MECHANISM OF DISINFECTION

BY E. A. COOPER, B.Sc., *Beit Memorial Fellow, formerly Jenner
 Scholar, Lister Institute of Preventive Medicine.*

(Received July 2nd, 1912)

CONTENTS

	PAGE
Introduction and method of study	362
I. The influence of concentration upon the distribution of phenol between water and proteins—	
(a) Gelatin	365
(b) Dissolved egg-albumen	368
(c) Heat-coagulated egg-albumen	372
(d) Heat-coagulated egg-globulin	373
(e) Casein	374
II. The influence of temperature upon the distribution of phenol between water and proteins—	
(a) Dissolved egg-albumen	376
(b) Heat-coagulated egg-albumen	376
(c) Gelatin	377
III. The influence of alcohol upon the distribution of phenol between water and heat-coagulated egg-albumen	377
IV. The influence of hydrochloric acid upon the distribution of phenol between water and heat-coagulated egg-albumen	378
V. The influence of concentration upon the distribution of m-cresol between water and proteins—	
(a) Gelatin	379
(b) Dissolved egg-albumen	380
VI. The solubility of proteins in phenol and m-cresol	381
VII. The application of some of these facts to the theory of phenol disinfection ...	382
VIII. Summary and conclusion	385

In the case of such substances as formaldehyde, halogens, mercuric chloride, oxidising agents, acids and alkalies, it is possible to understand why they should behave as disinfectants, as they all form chemical combinations with proteins. We have, however, very little knowledge of the relations of phenol and the cresols to proteins, so that it is at present not possible to understand the nature of the germicidal action of these common disinfectants.

Reichel,¹ in 1909, showed that heat-coagulated serum and egg-white absorbed phenol from its aqueous solution in an amount directly proportional to the concentration and that the process was reversible. He also showed that *Bacillus pyocyaneus* absorbed phenol, and that the addition of sodium chloride increased the uptake by both bacilli and heat coagula and also increased the bactericidal action of phenol.

Herzog and Betzel,² in 1911, found that yeast reversibly absorbed phenol in an amount, which relatively decreased with rise in concentration. A rise in phenol concentration, on the other hand, increased the rate of disinfection of yeast-cells to a degree disproportionate to the increase in concentration. They conclude that the absorption of the germicide is the first phase in the process of disinfection, and that this is followed by the chemical action of the germicide upon the cells, which is not affected by concentration in the same way as the absorption.

The object of the investigation described below was to obtain further knowledge of the relations of phenol and m-cresol to proteins with a view to understanding the nature of their germicidal action.

THE METHOD OF STUDY

(a) *The estimation of phenol and cresol*

The method used was that described by Lloyd³ in 1905. It consists in the bromination of phenol in the presence of a large excess of hydrochloric acid, under which condition three bromine atoms are quantitatively introduced into the phenol molecule.

Some further experiments showed that it was also possible to employ this method for the accurate determination of meta-cresol. Accurate results, however, could not be obtained with ortho- and para-cresol. The relative positions of the hydroxyl and methyl groups in the cresol molecule evidently influence the entrance of bromine atoms into the benzene nucleus.

(b) *The materials used*

The proteins used were gelatin, precipitated casein, dialysed crystalline egg-albumen and heat-coagulated egg-globulin (the fraction of egg-white precipitated by 1/2 saturated ammonium sulphate).

The gelatin (best gold label, Swiss) was first washed in running water for twenty-four hours. It was then air dried for twenty-four hours, cut into slips, and dried in a muslin bag at 110° C.

Merck's casein, prepared according to Hammarsten, was used in the experiments with casein.

The egg-albumen was prepared in the crystallized state from egg-white by the method of Hopkins and Pinkus, described in 1898,⁴ and was dialysed for ten days, first of all, in tap-water and finally in distilled water. The heat-coagulum was prepared by heating the dialysed solution of the protein slightly acidified by a few drops of 1 per cent. acetic acid. The coagulum was well washed and dried at 105° C.

The globulin fraction of egg-white was separated from the albumen as far as possible by several precipitations with half-saturated ammonium sulphate. The globulin was then dissolved in very dilute ammonium sulphate, coagulated by heat, washed free of ammonium sulphate and dried at 105° C.

(c) *The experimental methods*

Experiments with gelatin.—A definite amount of gelatin in the form of slips about one inch by three inches was suspended in a known volume of an aqueous solution of phenol of estimated strength. When the maximum amount of phenol had been taken up by the protein—the equilibrium-time having been determined by some preliminary experiments—the strength of the aqueous phenol solution was again estimated. By a comparison of the initial and final concentrations the distribution of phenol between water and protein was determined. New equilibria with phenol between water and gelatin were obtained by withdrawing a known volume of the water-phase and replacing this with an equal volume of water or phenol solution.

Experiments with casein, egg-albumen and egg-globulin.—The suspended casein was so fine that it could not be completely removed by filtration. Accordingly, in the experiments with it, and also with egg-albumen and globulin, the method introduced by Moore and Bigland⁵ was employed. This consists in restricting the protein to one region of the water-phase by means of a piece of dialysing paper, which was crumpled into the shape of a bag and enclosed in a stoppered bottle. Phenol was found to pass the dialyser readily. When equilibrium was attained, samples were removed for analysis from the portion of the water phase outside the dialyser. In other respects the procedure was similar to that adopted in the experiments with gelatin. All experiments were carried out at 20° C. in a thermostat, except where otherwise stated.

THE EXPERIMENTAL RESULTS

I

THE INFLUENCE OF CONCENTRATION UPON THE DISTRIBUTION OF PHENOL
BETWEEN WATER AND PROTEINS*(a) Gelatin*

Phenol below concentrations of 2·6 per cent. caused no visible change in gelatin. When immersed in concentrations between 2·6 and 5 per cent. the gelatin became white and semi-transparent but did not lose its shape, and in concentrations above 5 per cent. it contracted, lost its form, and settled on the bottom of the vessel as a viscous mass. The precipitated protein was soluble in hot 5 per cent. phenol solutions, but on cooling the gelatin was reprecipitated, having lost the property of setting. These changes were reversed when the supernatant liquid was poured off and replaced by water. In the case of the effects of concentrations less than 5 per cent., the protein quickly assumed its original appearance, except that it had acquired the property of swelling considerably, just as it does after immersion in acid. The reversibility was less rapid when the gelatin had been immersed in phenol concentrations above 5 per cent. The recovered gelatin was still soluble in warm water, and had regained the property of setting when the solution was cooled.

The time required for equilibrium.—The maximum amount of phenol was taken up by gelatin from concentrations less than 2·6 per cent. in two minutes. The reverse process was complete in fifteen minutes.

From concentrations of 2·6 per cent. to 5 per cent., namely, those which visibly changed the gelatin but did not prevent its suspension in water, the uptake of phenol was complete in twenty-four hours, and the reverse process was finished in the same time.

From concentrations of 5 to 7 per cent., causing the precipitation of the protein on the bottom of the vessel, the maximum amount of phenol was absorbed in forty-eight hours. The reverse process, however, required five weeks for its completion.

In concentrations from 0 to 2·6 per cent., at which point the gelatin was precipitated, the phenol was distributed between water and protein according to the partition-law. It was about three times as soluble in gelatin as in water.

At concentrations of about 2·6 per cent. the gelatin became white and opaque, and a greatly increased proportional uptake of phenol occurred.

TABLE I
EQUILIBRIA

10 grams gelatin ; 250 c.c. phenol solution

	Water-phase		Amount of phenol in grams absorbed by 1 gram gelatin (by difference)	Condition of protein	Distribution-ratio
	Initial phenol concentration (grams per 100 c.c.)	Final phenol concentration (grams per 100 c.c.)			Amount of phenol held by 1 gram gelatin
<i>Experiment I—</i>					
(B)	0.990	1.039	0.026	Unprecipitated	2.5
(B)	1.162	1.237	0.039	"	3.2
	1.813	1.729	0.047	"	2.7
	2.167	1.936	0.058	"	3.0
	2.365	2.277	0.069	"	3.0
	2.801	2.609	0.117	Precipitated	4.5
	3.077	2.847	0.175	"	6.2
	3.255	3.027	0.232	"	7.7
(A)	3.399	3.188	0.285	"	9.0
	3.816	3.488	0.383	"	11.0
	4.272	3.938	0.484	"	12.3
	4.535	4.260	0.566	"	13.3
	5.625	4.962	0.765	"	15.4
	5.976	5.524	0.901	"	16.3
	6.283	5.910	1.012	"	17.1
	6.489	6.154	1.113	"	18.1

Mean
= 2.9

Experiment II (Diagram I).—1.02 grams gelatin ; 60 c.c. phenol solution

	Water-phase		Amount of phenol in grams absorbed by 1 gram gelatin	Condition of protein	Distribution-ratio
	Initial phenol concentration (grams per 100 c.c.)	Final phenol concentration (grams per 100 c.c.)			
(A)	0.410	0.390	0.0123	Unprecipitated	3.1
	0.575	0.551	0.014	"	2.5
	0.739	0.706	0.019	"	2.7
	1.889	1.791	0.057	"	3.2
	2.518	2.402	0.068	"	2.8
	2.665	2.566	0.075	"	2.9
	3.778	3.246	0.313	Precipitated	9.6
	4.080	3.609	0.352	"	9.7
	5.037	4.008	0.605	"	15.1
	6.296	4.838	0.858	"	17.7
	6.561	5.510	0.970	"	17.6
	7.556	5.606	1.150	"	20.5
(B)	2.419	3.244	0.373	"	11.5
	0.934	2.707	0.104	Unprecipitated	3.8
	0.540	1.122	0.031	"	2.8
	0.561	0.579	0.020	"	3.4
	0.386	0.392	0.017	"	4.3

Mean
= 2.9

Mean
= 3.6

N.B.—(A) Equilibria obtained whilst phenol concentration was increased
(B) Equilibria obtained by reverse process.

With further increase in concentration the distribution-ratio continued to rise. No evidence of saturation of the gelatin with phenol was obtained, although the saturation point in water was closely approached.

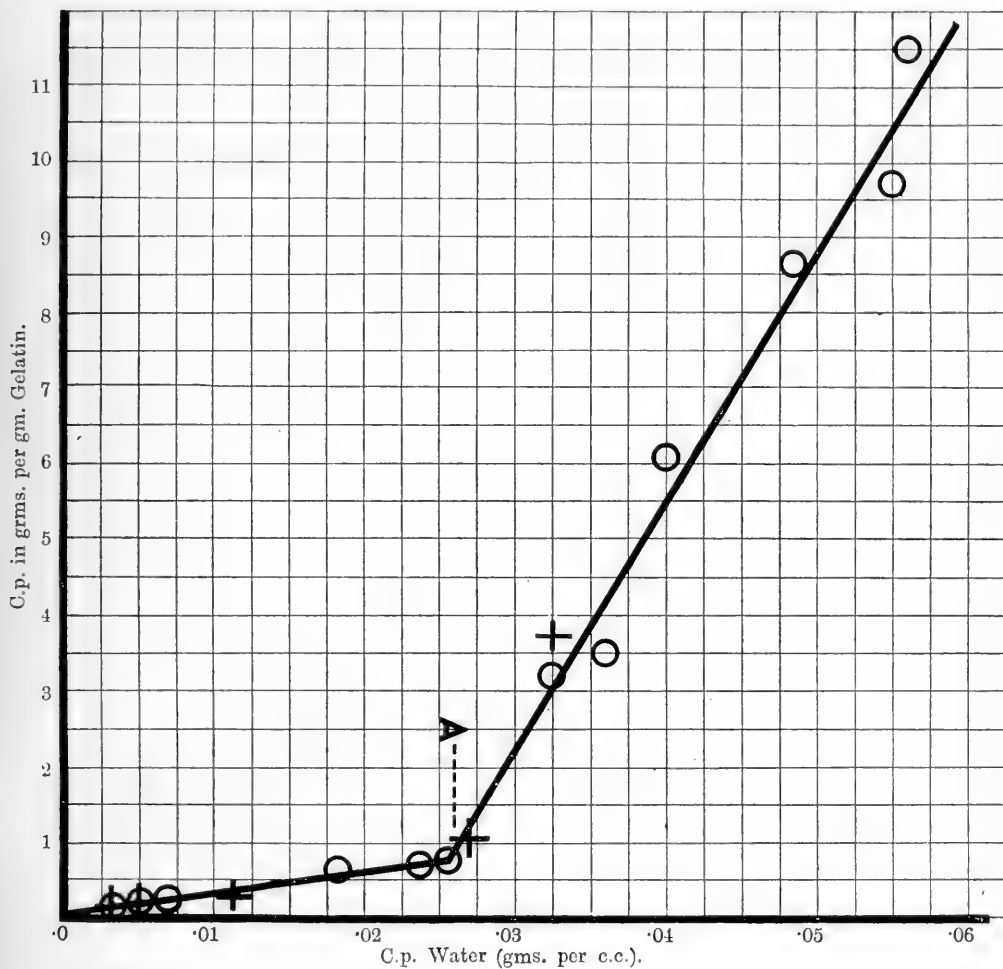

DIAGRAM I.—Equilibria with phenol between water and gelatin showing influence of phenol-coagulation upon the distribution of phenol between water and protein. (*Experiment II*, Table I).

○ = Equilibria obtained during rising concentration of phenol.

+ = Equilibria obtained by reverse process.

A = Commencement of precipitation of protein.

The equilibria (A) in Experiments I and II were obtained whilst the concentration of phenol was successively raised, and equilibria (B) by the reverse process. The approximate coincidence of the two series of equilibria, indicated by Diagram I, shows that the absorption of phenol by gelatin is a reversible process throughout the whole range of concentration investigated. The precipitation at 2.6 per cent. is also reversible.

It appears that, although unprecipitated gelatin below concentrations of 2.6 per cent. absorbs phenol according to the partition-law, when the concentration of phenol in the water reaches about 2.6 per cent. the phenol enters into a new relationship with the gelatin with the result that the protein undergoes precipitation and its absorptive capacity for phenol is enormously increased. The experiments on the distribution of phenol between water and gelatin did not afford good results when higher concentrations of phenol were employed, as equilibria were difficult to obtain. The precipitation of the gelatin in concentrations above 2.6 per cent. seems to be responsible for the somewhat erratic results. Nevertheless, the observational points plotted in diagram 1 evidently indicate again a linear relation to concentration, but in this case the uptake of phenol by the gelatin is proportional, not to the total concentration of phenol in the water-phase, but to this less 2.6 per cent. What the significance of this may be I am unable to suggest, but it is evidently associated with the sudden change in condition of the gelatin on precipitation.

(b) *Egg-albumen in solution*

Egg-albumen was more sensitive than gelatin to the precipitating action of phenol. A 10 per cent. suspension of gelatin in water was not visibly affected until the phenol concentration reached about 2.6 per cent., whereas a 10 per cent. solution of egg-albumen was rendered turbid by 1 per cent. phenol, slightly precipitated by $1\frac{1}{2}$ per cent., and completely precipitated by 2 per cent. phenol. Smaller concentrations of egg-albumen were affected by still lower phenol concentrations. The precipitates of egg-albumen were stable on the addition of water.

The absorption of phenol by unprecipitated egg-albumen and the reverse process were both complete within twenty-four hours. In the case of the protein precipitated by phenol the equilibrium approached from either side was attained within ninety-six hours.

TABLE II
EQUILIBRIA

	Water-phase		Amount of phenol held by 1 gram of egg-albumen in grams (by difference)	State of protein	Distribution-ratio
	Initial concentration (grams per 100 c.c.)	Final concentration (grams per 100 c.c.)			Amount of phenol held by 1 gram protein
<i>Experiment I</i> (Diagram II).—10 c.c. 16.47 per cent. egg-albumen solution ; 50 c.c. phenol solution					
(B)	0.251	0.237	0.005	Unprecipitated	2.1
(B)	0.332	0.312	0.007	"	2.3
(B)	0.805	0.757	0.025	Turbid	3.3
(B)	1.259	1.055	0.074	Slightly precipitated	7.1
(B)	1.666	1.332	0.122	Precipitated	9.1
(B)	4.233	3.229	0.365	"	11.3
(A)	0.777	0.874	0.086	"	9.8
(A)	0.510	0.579	0.0614	"	10.5

<i>Experiment II</i> .—10 c.c. 9.62 per cent. albumen solution ; 50 c.c. phenol solution					
(B)	0.138	0.132	0.004	Unprecipitated	3.0
(B)	0.214	0.203	0.007	"	3.5
(B)	0.712	0.695	0.015	"	2.1
(B)	0.971	0.938	0.035	Turbid	3.7
(B)	1.666	1.440	0.140	Precipitated	9.7
(A)	0.600	0.701	0.077	"	11.0
(A)	0.292	0.344	0.045	"	13.1
(A)	0.143	0.174	0.025	"	14.3
(A)	0.102	0.114	0.018	"	15.8

N.B.—(B) Equilibria obtained by uptake of phenol.

(A) Equilibria obtained by reverse process.

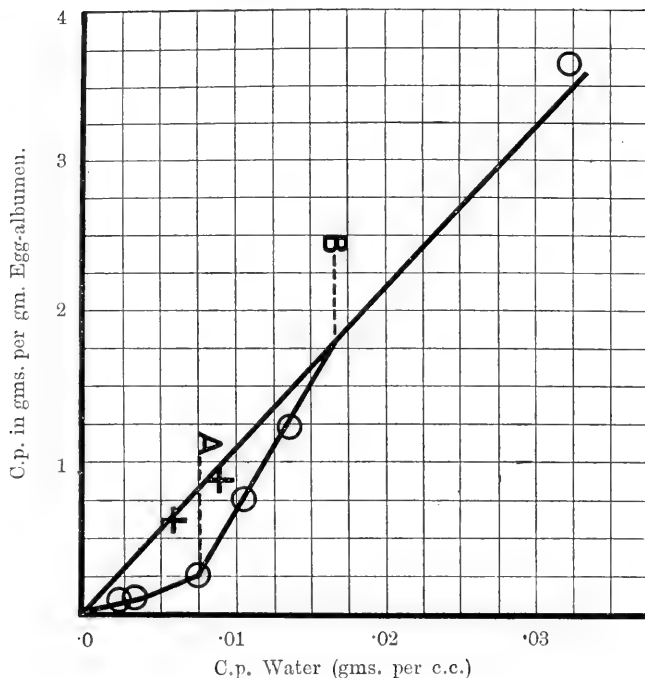

DIAGRAM II.—Equilibria with phenol between water and egg-albumen showing the influence of phenol-coagulation on the distribution of phenol between water and protein. (*Experiment I*, Table II).

O = Equilibria obtained during rising concentration of phenol.

+ = Equilibria obtained by reverse process.

A = Commencement of precipitation. B = Completion of precipitation.

Experiment III.—10 c.c. 10.2 per cent. egg-albumen solution ; 50 c.c. phenol solution

	Water-phase		Amount of phenol in grams taken up by 1 gram protein (by difference)	State of protein	Distribution-ratio
	Initial concentration (grams per 100 c.c.)	Final concentration (grams per 100 c.c.)			
(B)	0.164	0.155	0.005	Unprecipitated	3.2
(B)	0.410	0.390	0.012	"	3.0
(B)	0.639	0.623	0.014	"	2.3
(B)	0.737	0.727	0.018	"	2.5
(B)	0.877	0.857	0.030	"	3.5
(B)	2.148	1.807	0.215	Precipitated	11.9
(B)	4.926	3.466	0.376	"	10.8
(B)	4.651	4.235	0.460	"	10.9
(B)	5.475	5.280	0.575	"	10.9
(B)	6.056	5.742	0.760	"	13.2
(A)	3.346	3.812	0.486	"	12.7
(A)	1.444	1.699	0.226	"	13.3
(A)	0.708	0.864	0.134	"	15.5
(A)	0.360	0.441	0.086	"	19.5
(A)	0.184	0.231	0.059	"	25.5
(A)	0.096	0.119	0.046	"	38.7

Mean
= 2.9

Experiment IV.—10.2 per cent. egg-albumen solution ; 50 c.c. phenol solution

(B)	0.400	0.383	0.011	Unprecipitated	2.9	} Mean = 3.0
(B)	0.400	0.387	0.010	"	2.6	
(A)	0.258	0.262	0.009	"	3.4	
(A)	0.258	0.262	0.008	"	3.1	

N.B.—(B) Equilibria obtained whilst phenol concentration was rising.

(A) Equilibria obtained by reverse process.

The results obtained show that the distribution of phenol between water and unprecipitated egg-albumen followed the partition-law, and that phenol was on the average 2.8 times as soluble in the protein as in water. The absorption of phenol by the egg-albumen was reversible.

A comparison of the above results with those of the experiments with gelatin indicates that the solubilities of phenol in egg-albumen and gelatin were approximately equal. Since egg-albumen was precipitated by much lower phenol concentrations than gelatin, there was therefore no relationship between their susceptibilities to precipitation and their absorptive capacities for phenol.

In the neighbourhood of 1.0 per cent. final concentration of phenol, where the precipitation of egg-albumen commenced, as indicated in Diagram II, there was a greatly increased proportional uptake of phenol, and with rising concentration the distribution-ratio continued to increase until precipitation was complete (at about $1\frac{1}{2}$ per cent. final concentration). With further rise in concentration the uptake of phenol by the protein again became proportional to the concentration in the water, but with a higher partition-coefficient than at the commencement.

The observations on equilibria, made as the concentration of phenol in the water was being successively diminished, show that the egg-albumen once having been irreversibly precipitated by phenol maintains the high absorptive capacity for this substance until the concentration of phenol in the water is reduced to zero. Although with diminishing concentration the coagulated albumen gave up some of its absorbed phenol, so that in low concentrations it only retained a very small amount, the protein remained permanently denatured. It would appear that the denatured albumen is not an intimate phenol-protein complex, but is some modification of the original protein, which possesses a high solvent power for phenol.

(c) *Egg-albumen coagulated by heat*TABLE III
EQUILIBRIA

Water-phase		Weight of coagulum taken in grams	Amount of phenol in grams absorbed by 1 gram coagulum (by difference)	Distribution-ratio
Initial concentration (grams per 100 c.c.)	Final concentration (grams per 100 c.c.)			Amount of phenol held by 1 gram coagulum
Amount of phenol held by 1 gram water				
<i>Experiment I.—25 c.c. phenol solution</i>				
4.916	4.054	0.5	0.431	10.6
1.992	1.682	0.5	0.155	9.2
0.987	0.822	0.5	0.082	10.0
0.984	0.703	1.0	0.070	10.0
0.584	0.515	0.35	0.049	9.5
<i>Experiment II (Diagram III).—25 c.c. phenol solution</i>				
(A) 6.512	5.190	0.5	0.661	12.7
(B) 2.076	2.706	0.5	0.346	12.8
(A) 0.495	0.399	0.5	0.048	12.0
(B) 0.159	0.198	0.5	0.028	14.2

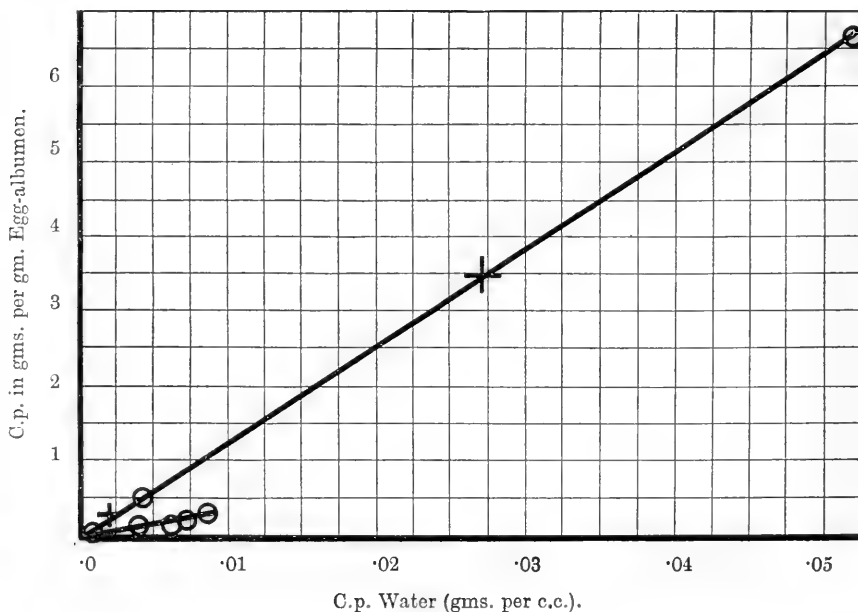

DIAGRAM III.—Equilibria with phenol between water and egg-albumen showing the influence of heat-coagulation on the distribution of phenol between water and protein.

Lower Curve.—Unprecipitated protein. (*Experiment III*, Table II).Upper Curve.—Heat-coagulated protein. (*Experiment II*, Table III).

○ = Equilibria obtained during rising concentration of phenol,

+ = Equilibria obtained by reverse process.

The distribution of phenol between heat-coagulated egg-albumen and water therefore followed the partition-law.

In Experiment II, equilibria (A) were obtained by the uptake of phenol by the coagulum, and equilibria (B) by the reverse process. The similarity in the values of the distribution-ratios deduced from the two series of equilibria showed that the absorption was reversible.

The mean partition-coefficient in Experiment I was 9.8, while in Experiment II it was 12.9. The coagula used were prepared from different batches of albumen. This may explain the difference in these values which, however, may also have its explanation in the varying conditions existing during the formation of the heat-coagula.

A comparison of the solvent power of the heat-coagulum for phenol with that of unprecipitated egg-albumen and of the phenol precipitated protein (Tables II and III) indicates that heat-coagulation was accompanied by an increase in the absorptive capacity of this protein for phenol, and that, except in low concentrations, heat- and phenol-coagulation affected the distribution of phenol between egg-albumen and water to somewhat similar degrees. Moore and Bigland⁵ showed that the uptake of alkali by egg-albumen was also increased by heat-coagulation.

(d) *Heat-coagulated egg-globulin*

TABLE IV

EQUILIBRIA

$\frac{1}{2}$ gram coagulum ; 25 c.c. phenol solution

Water-phase		Amount of phenol in grams taken up by 1 gram coagulum	Distribution-ratio Amount of phenol held by 1 gram protein
Initial concentration (grams per 100 c.c.)	Final concentration (grams per 100 c.c.)		Amount of phenol held by 1 gram water
5.195	4.470	0.524	11.7
4.632	3.871	0.420	10.8
4.572	3.810	0.408	10.7
1.977	1.653	0.162	9.8
0.505	0.416	0.044	10.6
0.373	0.342	0.039	11.4
0.166	0.201	0.027	13.5
0.247	0.199	0.024	12.0

Mean = 11.3

The distribution of phenol between water and the coagulated globulin therefore followed the partition-law, and phenol was 11.3 times as soluble in the protein as in water. By comparing the above results with those in Table III it is found that the solubilities of phenol in heat-coagulated egg-albumen and globulin were approximately the same.

(e) *Casein*

Casein was not precipitated from its solutions in sodium hydroxide by phenol. The experiments described below were carried out with the precipitated casein of commerce. The maximum amount of phenol was absorbed by casein in forty hours, which time was therefore allowed for equilibrium to be established.

TABLE V

EQUILIBRIA

$\frac{1}{2}$ gram casein ; 25 c.c. phenol solution

	Water-phase		Amount of phenol in grams taken up by 1 gram casein (by difference)	Distribution-ratio Amount of phenol held by 1 gram protein
	Initial concentration (grams per 100 c.c.)	Final concentration (grams per 100 c.c.)		Amount of phenol held by 1 gram water
<i>Experiment I</i> (Diagram IV)				
1	7.485	5.614	0.936	16.6
2	5.233	4.418	0.662	15.0
3	4.491	3.491	0.500	14.3
4	1.396	1.888	0.254	13.5
5	1.497	1.227	0.135	11.0
6	0.491	0.633	0.064	10.1
7	0.253	0.315	0.033	10.4
8	0.126	0.156	0.018	11.5
<i>Experiment II</i>				
	0.409	0.344	0.033	9.6
2	1.137	0.986	0.108	11.0
3	3.634	3.125	0.363	11.6
4	4.966	4.508	0.592	13.1
5	5.527	5.266	0.722	13.7

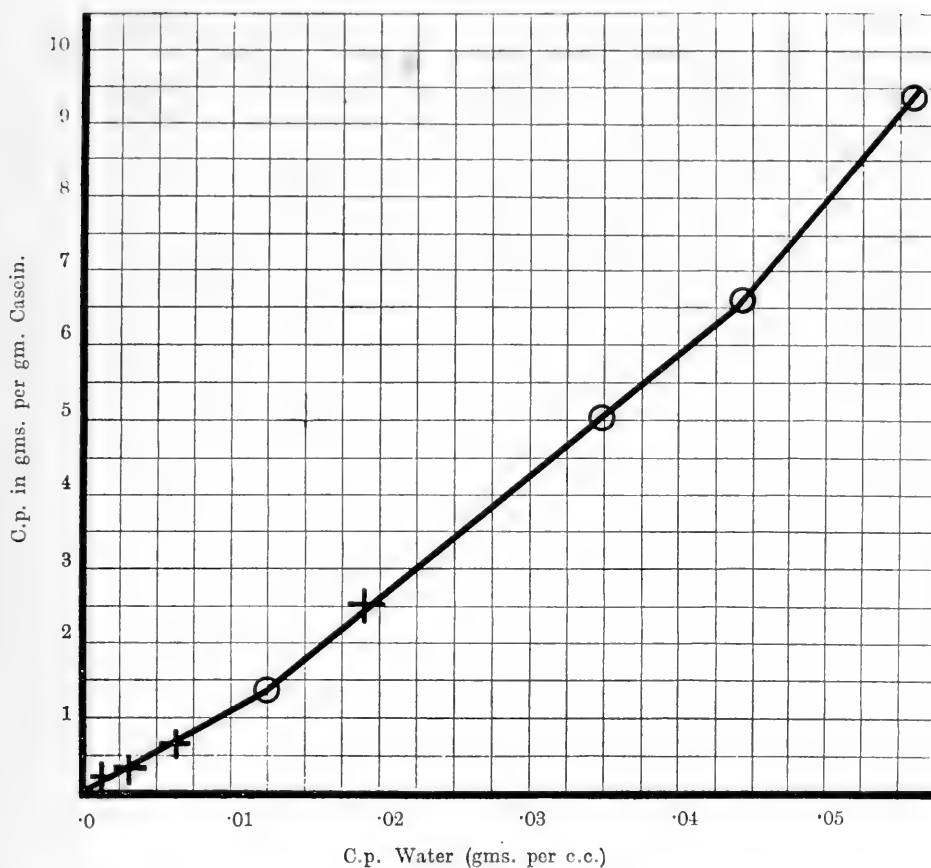

DIAGRAM IV.—Equilibria with phenol between water and casein. (*Experiment I*, Table V.)

○ = Equilibria obtained during rising phenol concentration.

+ = Equilibria obtained by reverse process.

The absorptive capacity of casein for phenol was thus considerably greater than that of water, and was of the same order of magnitude as the absorptive capacities of other precipitated proteins for this substance. The results of Experiment I indicated that although below a final phenol concentration of 1.8 per cent., the distribution of phenol between water and casein followed the partition-law, at 1.8 per cent. there was a deviation therefrom, the distribution-ratio increasing with further rise in concentration. The results of Experiment II also indicated this deviation, but there were not sufficient equilibria determined in this

experiment to show the constancy in magnitude of the distribution-ratio at low concentrations.

Equilibria 1, 2, 3, 5, in Experiment I were obtained by the uptake of phenol by casein; the remaining equilibria by the reverse process. The coincidence of the two series (Diagram IV) showed that the absorption of phenol by casein was reversible.

II

THE INFLUENCE OF TEMPERATURE UPON THE DISTRIBUTION OF PHENOL BETWEEN WATER AND PROTEINS

(a) *Egg-albumen in solution*

In the following table are given the amounts of phenol absorbed by a definite amount of protein from the same concentration at 20° C. and 37.5° C.

TABLE VI.—10 c.c. 11.2 per cent. egg-albumen solution; 50 c.c. phenol solution

Temperature	Water-phase		Amount of phenol in grams taken up by 1.0 gram protein	Distribution-ratio
	Initial concentration (grams per 100 c.c.)	Final concentration (grams per 100 c.c.)		
20° C.	0.248	0.196	0.006	3.0
20° C.	0.248	0.196	0.006	3.0
37.5° C.	0.248	0.197	0.005	2.5

A rise in temperature of 17.5° C. thus had no measurable effect upon the uptake of phenol by unprecipitated egg-albumen.

(b) *Heat-coagulated egg-albumen*

The experiments with the heat-coagulum were also carried out at 20° C. and 37.5° C.

TABLE VII
EQUILIBRIA

Temperature	Water-phase=25 c.c.		Weight of coagulum taken in grams	Amount of phenol in grams taken up by the coagulum	Distribution-ratio
	Initial concentration (grams per 100 c.c.)	Final concentration (grams per 100 c.c.)			
20° C.	0.584	0.515	0.35	0.017	9.7
20° C.	0.984	0.702	1.0	0.070	10.0
20° C.	0.984	0.705	1.0	0.070	9.9
37.5° C.	0.984	0.731	1.0	0.063	8.6
37.5° C.	0.984	0.732	1.0	0.063	8.6
37.5° C.	0.584	0.524	0.35	0.015	8.2

The results show that the uptake of phenol by the coagulum was slightly decreased by a rise in temperature from 20° C. to 37.5° C.

(c) Gelatin

As gelatin dissolves in water at temperatures above 20° C., experiments were carried out at lower temperatures.

TABLE VIII

EQUILIBRIA

Gelatin, 4 grams ; phenol solution, 100 c.c.

Temperature	Water-phase		Amount of phenol in grams absorbed by protein (4 grams)	Distribution-ratio
	Initial concentration (grams per 100 c.c.)	Final concentration (grams per 100 c.c.)		
4.4° (Minimum) to 6.6° C. (Maximum) = 5.5° C. Mean	0.994	0.914	0.080	2.2
	0.994	0.922	0.072	1.9
20° C.	0.994	0.914	0.080	2.2
20° C.	0.994	0.916	0.078	2.1
20° C.	0.994	0.917	0.077	2.1

A rise in temperature of about 15° C. therefore caused no change in the distribution of phenol between water and gelatin.

The results indicate that, although the solubilities of phenol in water, gelatin and dissolved egg-albumen were increased equally by rise in temperature, the solubility of phenol in heat-coagulated egg-albumen was increased to a slightly smaller extent than that of the same substance in water.

III

THE INFLUENCE OF ALCOHOL UPON THE DISTRIBUTION OF PHENOL BETWEEN
WATER AND HEAT-COAGULATED EGG-ALBUMEN

A definite amount of coagulum was added to each of a number of phenol solutions containing different percentages by volume of alcohol. The mixtures were kept at 20° C. for four days, and the filtrates from the coagula then analysed. Alcohol was found not to interfere with the process of estimating phenol. The results are tabulated below.

TABLE IX.—1 gram coagulum ; 100 c.c. phenol solution

Water-phase		Per cent. of alcohol initially present (by volume)	Amount of phenol in grams taken up by 1 gram of protein (by difference)	Distribution-ratio
Initial concentration (grams per 100 c.c.)	Final concentration (grams per 100 c.c.)			Amount of phenol held by 1 gram protein
1.992	1.680	0	0.156	9.3
1.992	1.684	0	0.154	9.2
0.993	0.833	0	0.080	9.6
1.992	1.758	25	0.117	6.7
1.992	1.770	25	0.113	6.4
0.993	0.974	50	0.010	1.0

These experiments indicate that alcohol considerably decreased the uptake of phenol by the protein. The alcohol as well as the phenol would be absorbed by the coagulum and, since alcohol is a very efficient solvent for phenol, its distribution between water and protein would lead to an increased solubility of phenol in both phases. The results of the above experiments therefore mean that the amount of alcohol absorbed was not sufficiently great to increase the solvent power of the protein for phenol to as great an extent as the alcohol unabsorbed increased the solvent power of the water for this substance.

IV

THE INFLUENCE OF HYDROCHLORIC ACID UPON THE DISTRIBUTION OF PHENOL BETWEEN WATER AND HEAT-COAGULATED EGG-ALBUMEN

Hydrochloric acid decreases the solubility of phenol in water, and it was therefore of interest to investigate its influence on the distribution of phenol between water and proteins. Definite amounts of the coagulum were immersed in a number of phenol solutions containing different concentrations of hydrochloric acid. After equilibrium was established, the phenol contents of the filtrates were estimated. The results are tabulated below.

TABLE X.—0.5 gram coagulum ; 25 c.c. phenol solution

Water-phase		Concentration of acid (HCl)	Amount of phenol in grams taken up by 1 gram coagulum (by difference)	Distribution-ratio
Initial concentration (grams per 100 c.c.)	Final concentration (grams per 100 c.c.)			Amount of phenol taken up by 1 gram protein
<i>Experiment I</i>				
0.996	0.824	0	0.085	10.3
0.996	0.793	N × 3	0.101	12.7
0.996	0.805	N × 6	0.095	11.8
<i>Experiment II</i>				
0.983	0.808	0	0.087	10.7
0.983	0.784	N × 3	0.100	12.7
0.983	0.797	N × 5	0.093	11.7
0.983	0.801	N × 5	0.091	11.3

The presence of hydrochloric acid therefore slightly increased the uptake of phenol by the coagulum, but the increase was more marked in lower concentrations of acid than in higher ones.

The hydrochloric acid, as well as the phenol, would be absorbed by the protein, and it would seem that the amount of acid absorbed was not sufficient to decrease the solubility of phenol in the protein to as great an extent as the amount of acid left in aqueous solution decreased the solubility of phenol in water.

On comparing the results of the experiments with alcohol and acid with those of Reichel's¹ experiments on the influence of sodium chloride upon the uptake of phenol by proteins (see introduction), it is found that a substance increasing the solubility of phenol in water diminishes the uptake of phenol by a protein, while substances decreasing the solubility have exactly the opposite effect.

V

THE INFLUENCE OF CONCENTRATION UPON THE DISTRIBUTION OF
META-CRESOL BETWEEN WATER AND PROTEINS

(a) *Gelatin*

Saturated aqueous solutions (1.25 per cent.) of ortho-, meta- and para-cresols had no precipitating action upon gelatin. Below are tabulated some equilibria with meta-cresol between water and gelatin, and also some equilibria with phenol determined under the same conditions.

TABLE XI.—5 grams gelatin ; 125 c.c. phenol or cresol solution

Water-phase		Amount of phenol or cresol in grams absorbed by 5 grams gelatin (by difference)	Distribution-ratio
Initial concentration (grams per 100 c.c.)	Final concentration (grams per 100 c.c.)		Amount of phenol or cresol absorbed by 1 gram protein
<i>Experiment I</i>			Amount of phenol or cresol absorbed by 1 gram water
	Meta-cresol		
	1.040	0.140	2.9
	0.832	0.122	3.2
	0.624	0.082	2.8
			} Mean = 3.0
<i>Experiment II</i>			
	Phenol		
	0.906	0.102	2.4
	0.725	0.080	2.4
	0.544	0.057	2.2
			} Mean = 2.3

Over the small concentration range possible to work with, owing to the slight solubility of cresol in water, the distribution of meta-cresol between water and gelatin followed the partition-law, and quantitatively was very similar to that of phenol between the same solvents.

Since meta-cresol is much less soluble than phenol in water, the above results indicate that the introduction of a methyl group into the benzene nucleus of phenol decreased its solubilities in water and gelatin to approximately the same degree.

(b) *Egg-albumen (dialysed solution)*

A 0.7 per cent. solution of meta-cresol was sufficient to produce a turbidity in a 10 per cent. egg-albumen solution, and a 1 per cent. solution immediately produced a copious precipitate of protein, which was irreversible. A 1 per cent. solution of phenol, however, only caused a faint turbidity in an egg-albumen solution of the same strength. The introduction of a methyl group into the benzene ring of phenol therefore increased its precipitating action upon egg-albumen.

In the following table are given some equilibria with meta-cresol between water and egg-albumen.

TABLE XII.—10 c.c. 10.2 per cent. egg-albumen solution; 50 c.c. cresol solution

Water-phase		Amount of meta-cresol in grams taken up by 1 gram protein	Condition of protein	Distribution-ratio
Initial concentration (grams per 100 c.c.)	Final concentration (grams per 100 c.c.)			Amount of meta-cresol held by 1 gram protein
0.188	0.180	0.005	Unprecipitated	2.8 } Mean
0.471	0.445	0.015	Unprecipitated	3.4 } = 3.1
0.846	0.696	0.104	Precipitated by cresol	14.9
0.950	0.822	0.179	Precipitated by cresol	21.8

Over the small concentration range possible to work with, the distribution of meta-cresol between water and unprecipitated egg-albumen followed the partition-law, and the cresol was 3.1 times as soluble in the protein as in water.

Experiment III in Table II with phenol was carried out under the same conditions as the above experiment with cresol, and it was found that phenol was 2.9 times as soluble in egg-albumen as in water. Egg-albumen, therefore, absorbed about equal amounts of phenol and cresol from solutions of the same percentage strength, so that the solu-

bilities of phenol in water and egg-albumen were equally decreased by the introduction of a methyl group into its benzene nucleus. Since egg-albumen was precipitated by lower concentrations of cresol than of phenol, the above results indicate that the relative precipitating power of these substances was not entirely determined by their equilibrium positions between water and the protein.

A comparison of the distribution-ratio of meta-cresol between water and egg-albumen with that of the same substance between water and gelatin indicated that the solubilities of cresol in the two proteins were equal. It was found that while egg-albumen was precipitated by dilute solutions of meta-cresol, gelatin was not even affected by saturated solutions (1.25 per cent.). As in the case of phenol, the susceptibilities of these proteins to precipitation by cresol were therefore not entirely determined by their absorptive capacities for this substance.

The precipitation of egg-albumen by cresol was accompanied by a large increase in the absorptive capacity of the protein for this substance. This increased absorption took place at a lower concentration with cresol than with phenol owing to the greater precipitating power of the former substance.

VI

THE SOLUBILITY OF PROTEINS IN PHENOL AND META-CRESOL

Ritthausen (1872),⁶ and Osborne⁷ and his co-workers (1891-93), found that zein dissolved in warm crystallized phenol. Kjeldahl (1896)⁸ showed that gliadin was also soluble in para-cresol and was precipitated from its phenol solution by many organic reagents.

Reichel (1909)¹ found that when serum was warmed with anhydrous phenol a clear solution resulted which underwent no apparent change on boiling.

The high solvent powers of egg-albumen and gelatin for phenol suggested that these proteins would also be soluble in anhydrous phenols.

When egg-albumen crystals were heated with molten phenol at 45° C. the protein gradually dissolved, and a clear solution was obtained. On dialysis or the addition of water to this solution the protein was precipitated. This was also effected by dialysing at 45° C. Similarly heat-coagulated egg-albumen dissolved in molten phenol and was reprecipitated when the solution was diluted. Gelatin dissolved in

phenol less readily than egg-albumen. It could be recovered in the unprecipitated state from the solution by dialysis at ordinary temperatures.

Meta-cresol also dissolved egg-albumen and gelatin at temperatures of about 40° C. Solution was not detected at room temperatures. By dialysing these solutions at room temperatures while the egg-albumen separated as a coagulum, the gelatin was recovered in the unprecipitated condition.

The facts that egg-albumen could only be recovered from these solutions in the precipitated state, while gelatin could be recovered in an unaltered condition, corresponded with the known differences in the stability in the presence of water or dilute phenol solutions of the products of the precipitating action of the phenols upon these proteins.

When anhydrous meta-cresol was added to 1/2 its volume of horse-serum at ordinary temperatures the serum proteins were precipitated, but on heating to 100° C. these were redissolved and a clear homogeneous fluid resulted. On cooling the liquid again became turbid owing to separation of the proteins. Meta-cresol rapidly dissolved Witte's peptone at 100° C., forming a brown liquid. Solution was also found to proceed slowly at ordinary temperatures.

Although meta-cresol dissolved proteins readily, it had no solvent action, even at high temperatures, upon the amino acids, glycyl-l-tyrosin and di-alanyl-cystin. These amino-acids also differed from proteins in not being precipitated from their aqueous solutions by strong solutions of phenol.

VII

THE APPLICATION OF SOME OF THESE FACTS TO THE THEORY OF PHENOL DISINFECTION

I.—The influence of alcohol upon the germicidal power of phenol

Kronig and Paul (1897)¹⁰ showed that the germicidal action of phenol upon anthrax spores was decreased by the presence of alcohol, a solution of phenol in 98 per cent. alcohol possessing only a very feeble bactericidal power.

The experiments described in Section III showed that the presence of alcohol decreased the uptake of phenol by heat-coagulated albumen. The decrease was of such magnitude that the protein absorbed eight

times as much phenol from an aqueous solution as from a solution of phenol in 50 per cent. alcohol.

The inhibiting influence of alcohol upon the bactericidal action of phenol is sufficiently explained by a decreased uptake of phenol by the spore-proteins, i.e., to a decreased amount of phenol available for disinfection.

It may be pointed out in this connection that, although the addition of acids considerably increases the germicidal action of phenol and cresol, the presence of hydrochloric acid only very slightly increased the uptake of phenol by egg-albumen. This suggests that the effect of acid upon germicidal power is only to a small extent due to an increased uptake of phenol by the bacterial proteins. It is probably due chiefly to the bactericidal action of the acids themselves.

II.—The effect of the presence of organic matter upon the germicidal action of phenol and cresol

Blyth,¹¹ in 1906, showed that the bactericidal action of phenol and cresol was decreased by the presence of milk, and to a lesser extent by separated milk. As the latter contains the proteins and sugar of the original milk with only a trace of fat and as lactose was found to have practically no effect upon the germicidal action of phenol, the depreciating effect of separated milk upon bactericidal action must be due to its constituent proteins. Some experiments recorded in Section I showed that casein absorbed phenol from aqueous solution. In a mixture of separated milk and phenol solution the casein therefore renders a considerable portion of the germicide unavailable for disinfection, and in this rests the explanation of the depreciating effect of separated milk upon bactericidal action.

III.—The influence of temperature upon the germicidal action of phenol

Henle (1889)¹² showed that the disinfection of *B. typhosus* was more rapidly completed if the temperature of medication were raised.

H. Chick (1908)¹³ quantitatively determined the influence of temperature upon the rate of disinfection of *B. paratyphosus* by phenol. It was found that the velocity of disinfection increased seven to eight fold for a rise in temperature of 10° C.

Since it was found that the uptake of phenol by an unprecipitated protein (gelatin) proceeded very rapidly, being complete within two minutes even at low concentrations, the influences of temperature upon

the equilibrium positions of phenol between water and proteins and upon the velocity of disinfection can be compared. It was shown that a rise in temperature of about 15° C. had no measurable effect upon the distribution of phenol between water and unprecipitated proteins. This suggests that the great accelerating influence of rise in temperature upon the process of disinfection is not due to an increased uptake of phenol by the bacterial proteins, but must be due to an increased velocity of a reaction between the phenol and proteins which proceeds subsequently to the absorption.

IV.—The unequal germicidal powers of phenol and meta-cresol

Several investigators have shown that the germicidal power of meta-cresol exceeds that of phenol. This is indicated in the following table, in which the number of times meta-cresol exceeds phenol in germicidal power is represented by the carbolic acid co-efficient.

Organism	Carbolic acid co-efficient of meta-cresol (Pure phenol = 1.0)
B. typhosus	2.6
Staphylococcus py. aur	2.0
B. coli	2.1

The experiments described in Section V showed that, although meta-cresol was superior to phenol in its precipitating action upon egg-albumen, there was no difference in the amounts absorbed by this protein from equal concentrations of the two substances.

The introduction of a methyl group into the benzene nucleus of phenol therefore led to an increase in both bactericidal power and protein-precipitating power, but to no change in the uptake of the phenol by the protein. This suggests that the superiority of meta-cresol over phenol as a germicidal agent is due to the fact that cresol precipitates proteins in smaller concentrations than phenol.

V.—Selective germicidal action

The germicidal power of a substance depends upon the nature of the organism employed. This is indicated in the following table:—

Organism	Concentration of phenol killing in 15 mins. under constant conditions
B. typhosus	7 in 1,000
B. diphtheria	5 in 1,000
B. coli	8 in 1,000
Staphylococcus py. aur	10 in 1,000
B. pestis	7 in 1,000

The cresols exhibit similar cases of selective germicidal action.

Some experiments described in a previous section showed that proteins possessing equal absorptive capacities for a phenol were unequally susceptible to its precipitating action. This suggests that the phenomenon of selective germicidal action is determined by the phenol concentration at which the specific proteins are precipitated.

SUMMARY AND CONCLUSION

I.—On the relations of phenol and meta-cresol to proteins

1. Gelatin and egg-albumen absorb phenol and meta-cresol according to the partition-law.

2. When a certain phenol concentration is reached the proteins are precipitated. This is accompanied by a great increase in their absorptive capacities for phenol.

3. The precipitation of gelatin by phenol is reversible, and the absorption of phenol by this protein is also reversible throughout the whole range of phenol concentration in water. The precipitation of egg-albumen, on the other hand, is irreversible, and the precipitated protein retains permanently its high absorptive capacity for phenol.

4. Heat coagulation also increases the solvent power of egg-albumen for phenol and, except at low concentrations, influences the equilibrium of phenol between water and this protein to about the same degree as phenol precipitation.

5. Meta-cresol does not precipitate gelatin, but it precipitates egg-albumen at lower concentrations than phenol. The precipitation leads to an increase in the absorptive capacity of the protein for cresol.

6. The solubilities of phenol in gelatin and egg-albumen at 20° C. are equal. This is also true of meta-cresol. Although this is the case, egg-albumen is precipitated by lower phenol and cresol concentrations than gelatin. The susceptibilities of the two proteins to precipitation are therefore not entirely determined by their absorptive capacities for the phenols.

7. Egg-albumen absorbs identical amounts of phenol and meta-cresol from equal percentage concentrations, but is precipitated by lower concentrations of cresol than of phenol. The relative precipitating power of these substances is therefore not entirely determined by their equilibrium positions between water and the protein.

8. Heat-coagulated egg-albumen and egg-globulin absorb phenol according to the partition-law. Their solvent powers for phenol are approximately equal.

9. Casein at low concentrations absorbs phenol according to the partition-law. Above 1·8 per cent., however, with rising concentration there is an increased proportional uptake of phenol. The absorption is reversible. Casein possesses the high absorptive capacity of precipitated proteins.

10. Rise in temperature has no measurable effect upon the distribution of phenol between water and egg-albumen and gelatin; it leads, however, to a slightly decreased uptake of phenol by heat-coagulated egg-albumen.

11. Alcohol considerably decreases the uptake of phenol by heat-coagulated egg-albumen. Hydrochloric acid, on the other hand, slightly increases the uptake.

12. Egg-albumen (crystallized or heat-coagulated) and gelatin dissolve in warm anhydrous phenol and meta-cresol. When the solutions are dialysed, the albumen is irreversibly precipitated, while the gelatin can be recovered in the unaltered condition.

13. Horse-serum forms a homogeneous fluid with about twice its volume of meta-cresol at 100° C. On cooling the serum proteins are precipitated.

14. Although meta-cresol dissolves proteins and also peptone, it does not dissolve even at high temperatures the polypeptides—glycyl-l-tyrosin and di-alanyl-cystin. These substances are also not precipitated from aqueous solution by strong phenol solutions.

II.—The application of some of these facts to the theory of disinfection

1. The depreciating effect of alcohol upon the bactericidal action of phenol is explained by a reduction in the absorptive capacities of the bacterial proteins for this substance. The action of hydrochloric acid in increasing the germicidal power of phenol, on the other hand, is only partially explained by a redistribution of phenol between water and proteins.

2. The depressing effect of separated milk upon the germicidal action of phenol is due to the absorptive capacity of the constituent casein for this substance.

3. The great increase in the germicidal power of phenol, which results from rise in temperature, is not explained by the influence of temperature upon the distribution of phenol between water and proteins.

4. The superiority of meta-cresol to phenol as a germicide appears to be due to the fact that cresol precipitates proteins in lower concentrations than phenol.

5. The selective action of phenol as a germicide upon different organisms seems to be associated with the observed dissimilar susceptibilities of proteins to its precipitating action.

MAIN CONCLUSION

The absorption of the phenols by bacteria is merely the initial stage in the process of disinfection.

The germicidal action which follows the absorption does not seem to be the result of a typical chemical union between the phenols and bacterial proteins, as is the case, for instance, with formaldehyde, but is apparently associated with the de-emulsification of the colloidal suspension as evidenced by the precipitation of proteins when a certain phenol concentration is attained. In the case of egg-albumen the change is irreversible, and the precipitated protein is not again dispersed on the removal of the phenol. The germicidal action of phenol thus appears to be similar in mechanism to that of heat. This interpretation of the process of disinfection by phenol may explain the fact that below certain concentrations (about 0.5 per cent.) this substance exerts but a very feeble bactericidal action, there being a disproportionate falling off in germicidal power when the phenol concentration is reduced to this point.

I desire to express my best thanks to Dr. C. J. Martin, F.R.S., for much helpful advice in the course of this work.

REFERENCES

1. Reichel, 'Zur theorie der desinfektion,' *Biochem. Zeitschrift* XXII, p. 149, 1909.
2. Herzog and Betzel, 'Zur theorie der desinfektion,' *Hoppe-Seyler's Zeit. physiol. Chemie*, LXVII, iv and v, p. 309, 1910; LXXIV, iii, p. 221, 1911.
3. Lloyd, *Journ. Amer. Chem. Soc.*, p. 23, 1905.
4. Hopkins and Pinkus, *Journ. Physiology*, XXIII, p. 130, 1898.
5. Moore and Bigland, *Bio-Chem. Journ.*, Vol. V, p. 32, 1910.
6. Ritthausen, *Die Eiweisskorper der Getreidearten*, Bonn, 1872.
7. Osborne and co-workers, 'Alcohol soluble proteins,' *Amer. Chem. Journ.*, XIII, XIV, XV, 1891-93.
8. Kjeldahl, 'Untersuchungen über das optische Verhalten einiger vegetabilischer Eiweisskorper,' *Beid. Cent.*, XXV, pp. 197-199, 1896.
9. Mathewson, 'The optical rotation of gliadin in certain organic solvents,' *Journ. Amer. Chem. Soc.*, XXVIII, pp. 1482-1485, 1906.
10. Kronig and Paul, *Zeitsch. für Hygiene*, XXV, ii, p. 1, 1897.
11. Blyth, 'The standardization of disinfectants,' *Journ. Soc. Chem. Ind.*, December 31, 1906.
12. Henle, 'Ueber Creolin und seine wirksamen Bestandtheile,' *Archiv. f. Hygiene*, Vol. IX, p. 188, 1889.
13. Chick, 'An investigation of the laws of disinfection,' *Journ. Hygiene*, Vol. VIII, No. 1, January, 1908.

THE DISTRIBUTION OF NITROGEN IN AUTOLYSIS, WITH
SPECIAL REFERENCE TO DEAMINIZATION

By GERTRUDE D. BOSTOCK, B.Sc., M.B., Ch.B., *Carnegie Scholar.*

From the Laboratory of Physiology, University of Glasgow

Communicated by Dr. E. P. Cathcart

(Received July 5th, 1912)

The object of the present investigation was not primarily to establish a closer connection between autolysis and intravital processes, but merely to determine whether the ammonia liberated in liver digests was converted into amide nitrogen, and whether the incubation of an amino acid with liver tissue led to a similar increase.

In a previous paper¹ on deaminization of amino acids when incubated with liver tissue under aseptic and antiseptic conditions, the fate of the liberated ammonia was discussed. Lang² had previously found that a considerable deaminization occurred, but in my experiments the amount of ammonia liberated from the amino acids (alanin, glycocoll and leucin) was insignificant, while on the other hand a considerable amount of ammonia made its appearance after the incubation of an amide—*asparagin*—with liver tissue.

The question arose as to whether the apparent absence of deaminization might not be due to the conversion of the liberated ammonia into urea.

In 1898, Loewi³ had investigated the urea-forming function of the liver *in vitro*, and had found an increase in the amount of a urea-like body in a liver extract after incubation, but the experiments were not very satisfactory. An absence of a proportionate consecutive increase is evident in the following figures, for the amount of nitrogen found in a Mörner Sjöquist estimation on an alcoholic extract of liver after varying periods of digestion:—

I.	After 8 hours' incubation	0·093 gm. N increase in 1000 gm. liver.
II.	„ 8 „ „	0·004 „ „
III.	„ 12 „ „	0·027 „ „
IV.	„ 24 „ „	0·013 „ „

Moreover, he was unable to isolate urea from the alcohol-ether extract, and he left the nature of the substance unsettled.

In view of the fact that only a small liberation of ammonia from amino acids, when incubated with liver pulp, was to be expected, the addition of ammonia or an ammonium salt to the liver tissue suggested itself as being more likely to lead to an increase in the amount of amide nitrogen at the end of incubation.

The investigation proved less straightforward than was anticipated, on account of the difficulty in finding a suitable method for the determination of the amide nitrogen.

The following methods were finally adopted and gave satisfactory results.

Methods.—The incubation of the tests was carried out in the way described in the previous paper, the only modification being that in a majority of cases 100 gm. liver tissues were employed, instead of 50 gm., and the tests were shaken with 5 c.c. toluol, instead of 2 c.c. Shaking varied in the different experiments from thirty to sixty minutes.

A modification of the working up of the tests was introduced when the attempt was made to determine the amino acids, i.e., from Experiment 32 onwards. After this 100 c.c. rectified spirit, instead of tannic acid, was used to coagulate the proteins, coagulation being rendered more complete by boiling. Filtration was carried out after the combined precipitate and solution had been made up to a definite volume, i.e., 400 c.c. The ammonia, amide and amino acid nitrogen and the total nitrogen were then determined in the filtrate, 100 c.c. of which corresponded to 25 gm. liver tissue.

All the figures in this paper are expressed in c.c. N/10 sulphuric acid for 100 c.c. of the filtrate.

Ammonia was determined by a modification of the Kruger-Reich-Schittenhelm⁴ vacuum distillation method, the temperature was kept at 38° C. or just under. Distillation was carried on two hours; 40 c.c. of ethyl alcohol were added to the filtrate before distillation. The alkaline mixture used was one volume of a saturated solution of Na₂CO₃, and two volumes of a saturated solution of NaCl, 20 to 25 c.c. being added to each test. Rosolic acid was used as indicator.

The amount of filtrate taken for examination was 100 c.c. in the majority of cases; in a few instances only 50 c.c. was taken.

The *Amide nitrogen* was determined by a modification of the Benedict Gephart method⁵ for estimating urea suggested by Henriques and

Gammeltoft⁶ (omitting, however, the phosphotungstic precipitation). In carrying out the estimation, 5 c.c. of a 1 in 20 solution of hydrochloric acid was added to a 100 c.c.* of the filtrate to be tested, and the mixture was heated in the autoclave to 150° C. for 1½ hours, after which the ammonia was distilled off in vacuo by the Kruger-Reich-Schittenhelm method. The heating of the autoclave was most carefully conducted, the pressure only varying between 68 and 72 lbs. per square inch. The later modification suggested by Benedict⁷ in 1910, i.e., the addition of MgCl₂ before heating, was not adopted, as most of the work had already been carried out. Wolf and Osterberg,⁸ Levene and Meyer,⁹ and Benedict himself point out that a disadvantage of the autoclave method is that small amounts of uric acid and creatinine are decomposed in addition to the urea. In the present work on liver digests, however, accurate relative values, and not absolute values are claimed, and the fact that concordant control results were obtained shows that the method (within its limitations) is at least reliable. Legitimate conclusions as to the fate of amide nitrogen in these digests can therefore be drawn from a comparison of the figures obtained.

Amino acid nitrogen was estimated by the Henriques-Sørensen method.¹⁰ The initial neutralisation, however, was carried out with phenolphthalein¹¹ as an indicator, the first appearance of a pink tint being regarded as the end point. In the earlier tests the end point after the addition of the neutral formol was not taken to a deep rose as Henriques and Sørensen recommend. In the later tests, however, the deep rose was always taken as the end point.

The colour of the original filtrate, which varied from a pale amber to a deep yellow, interfered considerably with the sharpness of the end point in some cases, and the only safety lay in repeating the estimations. Here again no claim is made for absolute values, but a comparison of the relative values is justified by the concordance of the results obtained from controls. The error, such as it is, is on the side of low rather than of high values. Various observers (de Jager 1909),¹² (Henriques and Sørensen 1910),¹³ have drawn attention to the fact that in the presence of ammonia in excess the estimation of the amino acids yields too low a figure. To obviate this difficulty, Henriques and Sørensen recommend a determination of the formol-titratable nitrogen on the residue of an ammonia distillation. This was accordingly tried, but unfortunately

* In a few cases 50 c.c. instead of 100 c.c. of the filtrate, were used for the determination of the Amide nitrogen.

the yellow colour always seemed to be stronger in the case of such a residue—and probably as a result of this and the consequent masking of the end point, a lower value was frequently obtained for the amino acid nitrogen than in a direct estimation.

The direct estimations have therefore been given unless otherwise stated. 20 to 25 c.c. of the filtrate were used for the determinations, which were carried out in duplicate, except in the case of the very earliest estimations.

Total nitrogen has been estimated by Kjeldahl method, duplicate analyses being always carried out. 10 to 30 c.c. of the filtrate were used for each determination.

PRESENT INVESTIGATION

In the initial experiments recorded in Table I, ammonia and amide nitrogen only were estimated. It was found after the digestion of ammonia with liver pulp, that the amount of amide nitrogen, so far from being increased, was actually smaller than in the case of a control test to which no addition of ammonia had been made.

As the ammonia was added in the form of the hydrate, there was a possibility that the addition of alkali had something to do with the result. In Experiment 27, therefore, additions of equal amounts of NaOH and NH_4OH were made to digests, and in each case, i.e., after two, four and six days' incubation, respectively, the amide value agreed fairly well in the two alkaline tests, and was considerably lower than those of the control tests. Moreover, if the NaOH test were taken as the control test for the NH_4OH test, there had been no disappearance of ammonia, but a recovery of the whole amount. Evidently, then, the alkaline reaction had modified the course of digestion.

It was imperative to determine whether the addition of alkali had produced this effect by diminishing the rate of autolysis. This could best be ascertained by estimating the total soluble nitrogen at the end of incubation. If it were equal in the control and the alkali test, it might be safely assumed that autolysis had proceeded at the same rate in both. Without such an estimation of the total soluble nitrogen, conclusions regarding the conversion of ammonia into amide nitrogen *in vitro* were not valid.

The action of acid and alkali in accelerating and inhibiting autolysis respectively is well known, a number of observers having made contributions on the subject. A further investigation seemed advisable

TABLE I. All the figures are in c.c. N/10 acid for 100 c.c. filtrate, or 25 grams ox liver.

	Period of incubation	CONTROL		GLYCOCOLL		AMMONIA		Amount of NH_3N recovered	Calculated amount of NH_3N of NH_3N
		NH_3N	Amide N	NH_3N	Amide N	NH_3N	Amide N		
25. In ammonia tests 20.8 c.c. N/10 NH_4OH added. In glyco coll tests, 5 c.c. of 4% solution ...	(1) 20 hours	5.9	9.35	6.2	12.35	10.3	1.9	4.4	5.2
	(2) 3 days	9.5	19.8	9.45	16.15	13.9	17.0	4.6	5.2
	(3) 5 days	11.15	34.95	10.85	31.65	14.9	37.3	3.8	5.2
22. In ammonia tests 19.6 c.c. N/10 NH_4OH added to (1) and 39.2 c.c. to (2). In glyco coll tests 10 c.c. of a 4% solution added ...	14 days	14.75	42.1	14.69	47.39	19.36	38.7	(1) 4.6	4.9
	24.6	36.3	(2) 9.8	9.8
26. To ammonia tests 20 c.c. N/10 NH_4OH added ...	(1) 20 hours	8.7	11.1
	(2) 2 days	8.3	11.4	lost	...	14.3	8.55	2.6	5.0
	(3) 3 days	11.65	12.26	15.1	9.1	2.8	5.0
27. Fresh tissue. To NaOH and NH_4OH tests 19.2 c.c. N/10 NaOH and NH_4OH added respectively ...	(1) ...	1.9	6.1
	(2) 2 days	1.9	6.0	6.15	7.65	10.9	8.5	4.1	4.8
	(3) 4 days	6.8	9.8	7.85	9.2	12.45	9.5	3.4	...
	(4) 6 days	9.0	17.1	8.9	11.5	13.7	12.05	3.2	...

in view of the fact that (so far as I know) no attempt had been made to estimate the increase in ammonia and amide nitrogen in relation to the total soluble nitrogen. Attention was now directed to the effect of acid and alkali on autolysis, particularly with regard to the distribution of ammonia and amide nitrogen. From this time onward the total soluble nitrogen was always determined, so that the ammonia and amide values might be expressed as percentages of this. Eventually a further modification of the method allowed of an amino acid determination, and an attempt was made to study the nitrogen distribution in autolysis and the effect upon it of various factors.

The factors investigated were:—

1. Length of incubation.
2. Acid and alkali.
3. Presence of bacteria.

It was felt that a study of these conditions was a necessity in determining the fate of amino acid or ammonia added to digests.

LENGTH OF INCUBATION

In discussing the influence of these factors on autolysis, it will be more satisfactory to study first that of time or the length of incubation. The literature deals chiefly with the effect of acid or alkali on autolysis and the time factor itself has been almost ignored. In most of the work incubation has been of short duration, usually three to seven or eight days. Simon,¹⁴ using Salkowski's¹⁵ method, found an increase in the soluble nitrogen of a liver digest up to the 22nd day, when the experiment was stopped.

Dakin¹⁶ found that the formation of ammonia in kidney autolysis extended over two months, during which time it was proportional to the time of digestion. Drjewezki¹⁷ points out the value of a consideration of the partition of nitrogen, as he found that the total soluble nitrogen might remain stationary, while changes occurred in the ratios of the various nitrogen constituents to the total soluble nitrogen.

The following two questions may now be asked, before reviewing the experiments tabulated below.

- (1) Does autolysis proceed at the same rate from day to day, or does it rapidly reach a maximum and then gradually diminish until it finally comes to a standstill?
- (2) Does the percentage distribution of nitrogen remain unchanged throughout the course of autolysis?

In Table II all the control tests from the whole series of experiments have been collected for purposes of comparison.

Experiments 34 and 35 (1), however, were carried out solely to determine the influence of the length of incubation on the actual and percentage distribution of the soluble nitrogen in autolysis. In Experiment 34 eight tests were prepared at the same time, two were worked up immediately, while two were incubated for two, four, and fifteen days respectively.

Total Soluble Nitrogen.—In fresh liver tissue the total soluble nitrogen is fairly constant, 51 to 57 c.c. N/10 for 25 gm. liver tissue. Within the first twenty-four hours' incubation the increase is more rapid than at any subsequent period; after the third day (see Experiment 34) the increase is comparatively small, and it gradually becomes less and less. Unfortunately, the data are not sufficient to determine the precise time at which it ceases, but it would seem that after nine weeks, at any rate, no further increase occurred, the figures indeed show that in Experiment 35 there is actually a diminution after the ninth week until the twelfth.*

An examination of Table II will show that there is sometimes a considerable difference in the total soluble nitrogen of different tests, incubated for the same period, although in serial tests the increase shows a fairly regular sequence. In Experiment 28, for example, the values at the end of two, four and seven days are all higher than in some of the other tests, such as 34. Such differences are probably due to initial differences in the organs themselves, or are perhaps due to a longer interval having elapsed between the slaughter of the animal and the working up of the tissues in some cases than in others.

Ammonia.—The preformed ammonia in fresh liver tissue is strikingly small, i.e., 1.75 to 2 c.c. N/10 in 25 gm. This result is confirmed by some unpublished work on the ammonia content of the fresh dog's liver, when the following values were obtained, 1.8, 1.8, 1.25, 1.72 and 1.22 c.c. N/10 in 25 gm. This fact is also emphasized by Folin¹⁸ in his most recent work. He holds that both in blood and liver tissue more ammonia is produced by decomposition in a few hours than is actually present as preformed ammonia in the fresh blood or tissue itself.

In the serial experiment 30, the ammonia has more than doubled

* In 35 (1) only 50 gm. of liver tissue were put up with 100 c.c. physiol. salt solution, while in 35 (2) and (3) 100 gms. were put up with the same amount of fluid, this might account for the difference in the total soluble Nitrogen figures. In 35 (2) and (3) the difference lies within the limits of experimental error.

itself in the first twenty-four hours, after this the increase is much more gradual (see Experiment 34).

Ammonia, expressed in percentage of the total soluble nitrogen, is also small in fresh tissue and just about doubles itself in twenty-four hours. In 34 it shows a gradual increase after the second day, being 7.3, 7.7 and 8.1 on the second, fourth, and fifteenth day respectively. In 35 (1) it is 8.6 at the end of the ninth week, so that little change occurs in the ammonia percentage after the second week. In some experiments, as in 37, the percentage is higher than this, e.g., 11.5 to 11.8, and is practically the same after nine days, two weeks, and three weeks respectively. In different experiments, then, the percentage ammonia varies within somewhat wide limits (7.8 to 11.9) without any definite relation to time after the first twenty-four hours.

Amide nitrogen.—The amide content of the fresh tissue is low, 5.85 to 6.4, but it does not show the same rapid increase as the ammonia. Experiment 34 shows a fairly regular sequence in the absolute amounts, but there is a less regular sequence in the percentage amounts. This holds good for most of the experiments, although Table II shows a certain lack of uniformity about the percentage figures. In 37 the percentage amount throughout the series is practically the same as that of the ammonia, but in every other case, it is higher than the latter. The explanation may be in the initial reaction of the tissue (see later). In connection with the total soluble nitrogen in this experiment, it was noted that autolysis had apparently come to a standstill by the second week. The amide shows the same standstill. In Experiment 35 the actual amount shows a decrease, if anything, from the ninth to the twelfth week, while the percentage amount remains practically constant.

Amino acid nitrogen.—The amino acid nitrogen shows the same general characters as the ammonia and amide nitrogen, i.e., it is smallest in the fresh tissue. It more than doubles itself within forty-eight hours, after which the increase is more gradual.

In 35 there is apparently an increase in the amino acid nitrogen after nine weeks' incubation, which might perhaps be explained by the splitting of polypeptides. As, however, it has already been pointed out that the method applied to tissue digests is not free from possible error, no stress is laid on this single apparent increase.

It is interesting with regard to the percentage figures to see that practically 50 per cent. of the soluble nitrogen at the end of nine to twelve weeks' digestion is in the form of amino acid or rather formol titratable nitrogen, whilst the proportion in fresh tissue is about 17 per cent.

In Experiments 36 and 37 the percentage varies from 49 per cent. to 51 per cent. in the nine days' digests, and from 47 per cent. to 54 per cent. in the three weeks' digests, so that apparently the maximum percentage is reached at a fairly early stage in autolysis. It would appear that after the ninth day amino acid nitrogen increases only parallel with the total soluble nitrogen.

34 (4) gives only 29 per cent. amino acid nitrogen at end of fifteen days' incubation. This low value is probably due to the imperfect technique, as these tests were among the earliest in which the amino acid nitrogen was estimated.

Undetermined Nitrogen.—In Experiment 34 the undetermined nitrogen shows a slight actual increase in amount with the increasing duration of incubation, but the percentage amount has diminished from 68 per cent. in the fresh tissue to 48 per cent. at the end of fourteen days' incubation. In the later tests, i.e., 35, 36 and 37, in which incubation lasted from nine days to twelve weeks, the actual amounts of undetermined nitrogen are low, the percentage amounts are also low; no definite relation to time can be made out within this period.

The questions formulated above can now be answered as follows:—

- (1) Autolysis does not proceed at the same rate from day to day, it reaches a maximum within the first forty-eight hours, after which the increase in all the constituents of the soluble nitrogen gradually ceases.
- (2) The percentage distribution of the soluble nitrogen in fresh tissue is quite distinctive in character; the ammonia and amino acid nitrogen are much lower, and the undetermined nitrogen is considerably higher than at any subsequent period of incubation. The ratio of ammonia to amide nitrogen is less than 1 : 3 in fresh tissue. Within forty-eight hours the ratio has changed, and is usually greater, but never less than 1 : 2.

How long proteolytic ferments remain active under the conditions of antiseptic incubation cannot be answered; there is a lack of literature on this point. Vernon¹⁹ points out that if tissue be minced, much of the enzyme goes at once into solution, but that days or weeks elapse before a filtered test of the extract shows its maximum zymolising power.

DISTRIBUTION OF NITROGEN IN AUTOLYSIS 397

 TABLE II.—All figures are in c.c. N/10 H₂SO₄ for 100 c.c. filtrate or 25 grams ox liver,

			Period of incubation	NH ₃ N	Amide N	Amino acid N	Undetermined N	Total Sol. N	
30.	Fresh liver	(1)	3.0	11.2	56.7	
				1.75	6.4	57.0	
				7.2	14.3		
			(2)	6.0	11.9	83.2	
31.	Fresh liver	(1)	5 hours	5.7	13.4	59.0
				3.4	7.95		
				9.5	13.8		
			(2)	1 day	6.8	9.9	...	72.0	
32.	Fresh liver	(1)	1 day	7.2	12.9	30.2	49.7	81.0
				5.8	10.4	24.4	40.2		
				8.0	12.0	32.2	47.8		
			(2)	2 days	8.0	11.9	32.0	47.5	99.0
33	Fresh liver	(1)	1 day	6.7	11.0	22.1	60.2	75.0
				5.0	8.2	16.6	45.1		
				8.7	12.5	31.0	47.8		
				7.6	10.9	27.0	41.5	87.0	
				10.3	16.5	34.0	39.2		
			(3)	20 days	10.7	17.0	35.4	40.8	104.0
28.	Fresh liver	(1)	2 days	9.0	18.5	90.5
				8.2	16.8		
				9.4	21.0	110.0	
				10.4	23.1		
			(3)	7 days	11.3	20.8	113.0
				12.8	23.5		
29.	Fresh liver	(1)	8 days	9.0	16.0	131.0
				11.9	21.2		
				7.8	18.5		
			(2)	32 days	13.8	32.6	176.0
35.	Fresh liver	(1)	9 weeks	8.7	14.8	39.8	36.6	196.0
				17.4	28.4	76.8	71.0	192.0	
				16.4	29.2	77.8	71.0		
				9.0	15.8	45.5	29.7		
			(2)	9½ weeks	16.5	28.8	83.0	53.7	182.0
				11.0	15.1	52.4	21.5		
			(3)	12 weeks	19.6	26.8	92.9	37.7	177.0
36.	Fresh liver	(1)	9 days	9.9	12.9	49.8	27.4	115.0
				11.4	14.8	57.3	31.5		
				10.2	15.9	54.3	19.6		
			(2)	3 weeks	15.1	23.5	80.4	29.0	148.0

TABLE II.—*Continued.*

	Period of incubation	NH ₃ N	Amide N	Amino acid N	Undetermined N	Total Sol. N
37. Fresh liver	(1) 9 days	11.8 11.8	11.6 11.7	51.0 51.1	25.6 25.4	100.0
	(2) 2 weeks	11.6 13.5	12.0 14.0	48.8 56.5	27.6 32.0	116.0
	(3) 3 weeks	11.9 13.6	12.4 14.1	46.7 53.3	29.0 33.0	114.0
34. Fresh tissue	(1) 0	3.6	11.3	17.0	68.1	
		2.0	6.1	9.0	31.2	53.5
		1.8	5.85	8.9		51.5
	(2) 2 days	7.4	10.0	28.9	53.2	
		6.0	8.45	22.8		79.0
		5.8	8.35	23.4	42.6	81.0
	(3) 4 days	8.2	11.9	26.5	53.4	
		7.5	10.3	23.3		89.0
		7.3	11.2	24.7	48.3	92.0
	(4) 15 days	8.2	13.5	29.9	48.4	
		8.8	14.4	31.6		106.0
		8.7	14.5	32.3	51.8	108.0

NOTE.—The upper row of figures in each case represents percentages.

EFFECT OF ACID AND ALKALI ON AUTOLYSIS

It is on considering the effects of acid and alkali on autolysis that the value of the percentage relationship is at once apparent. There is undoubtedly an inhibition of autolysis on addition of alkali and an acceleration on that of acid. Whether the effect is merely one of inhibition or acceleration, or whether it is something more, can only be determined by an investigation of the nitrogen partition.

The earliest record of the action of alkali in diminishing the amount of total soluble nitrogen in antiseptic autolysis is by Schwiening²⁰ in 1894. Two years later, Biondi²¹ noted an increase of total soluble nitrogen when acid was added to the digest. Hildebrandt²² found that an addition of acid or alkali to the mammary gland caused an increase and diminution respectively of the total soluble nitrogen.

Hedin and Rowland in 1901²³ found that the spleen of various animals contained a proteolytic ferment which acted most strongly in acid solution, and least strongly in presence of alkali. In the same year²⁴ they found similar proteolytic enzymes in the liver, lymph gland and kidney of calf, dog and horse.

In 1903/04 Hedin²⁵ came to the conclusion that the spleen contained

two proteolytic ferments, an α protease which only acted in alkaline medium and a β protease which only acted in an acid medium.

In 1906,²⁶ he found that previous treatment with alkali was enough to inhibit autolysis in organs, although acid was added subsequently, while previous treatment with acid sufficed to accelerate it in spite of subsequent addition of alkali.

Baer and Loeb in 1905²⁷ found that small amounts of alkali diminished autolysis (i.e., the total soluble nitrogen), while large amounts accelerated it. This latter observation has not been confirmed.

In 1906, Wiener²⁸ found that alkali diminished the total soluble nitrogen in liver digests, and that alkali present in amount equal to that of the blood allowed no increase at the end of one week's incubation. The same year Drjewecki¹⁷ worked at the influence of alkali on autolysis of the liver—examining not only the total soluble nitrogen but also the monamino, diamino, and albumose nitrogen. He found that autolysis took place in an alkaline medium of 0.2 per cent. to 0.3 per cent. concentration, but was much diminished. It may be noted, however, that in the alkaline tests, monamino nitrogen has a smaller percentage value than that of the control test, while the opposite condition is found in the case of the albumose nitrogen.

Shryver,²⁹ following up some work done by J. Lane Claypon and himself on autolysis in the fasting and fed animal, examined the influence of acid and alkali on autolysis as indicated by the total soluble nitrogen. He found that acids markedly accelerated the process, the amount not the degree of concentration of the acid being the important factor. Lactic acid was more powerful than H_2SO_4 . Alkali inhibited autolysis.

In 1907, Arinkin³⁰ thoroughly investigated the influence of inorganic and organic acids on liver autolysis, and also dealt with the question of the hydrolytic action of the acid on the liver tissue. The conclusion arrived at was that the protein cleavage was due to ferment action alone, and not to acid hydrolysis. The action of the acid was to stimulate the ferments. In his experiments, incubation was carried on for forty-eight hours. The most interesting conclusions are that:

- (1) There is a definite optimum for each acid, beyond which autolysis diminishes.
- (2) In equivalent and percentage relations inorganic and organic acids behave differently, i.e., some stimulate more than others.

The accelerating action of acid is specially marked in the first stage of autolysis.

Preti³¹ in 1907 made another contribution to the action of alkali on autolysis. He found that small amounts of alkali inhibited the autolytic action. Laqueur³² investigated the effect of carbon dioxide on liver autolysis, and found that it produced a marked increase in the total soluble nitrogen, thus confirming an observation of Yoshimoto³³.

Experiments 28, 33 and 35 deal with the influences of acid and alkali on autolysis. In 28, lactic acid, 20 c.c. N/10, was added to one series of tests, while a similar amount of N/10 NaOH was added to another series, a third series being used as controls. Incubation was carried on for two, four and seven days respectively.

In 33, lactic acid was added to one series and sulphuric acid to another in amounts equal to 19.75 c.c. N/10; incubation was carried on for one, four and twenty days respectively. Finally, to determine whether prolongation of the incubation for a considerable period made a marked difference in the relations already found in the first two experiments, Experiment 35 was carried out; incubation lasted 9½ and twelve weeks respectively, 20 c.c. N/10 sulphuric acid being added to one series and the same amount of NaOH to another series.

It is apparent from the total soluble nitrogen figures on Table III, that the effect of the acid is to markedly increase, while alkali has the opposite effect. If the control test be taken as 100, the following relations are obtained:—

	Control	Acid Test	Alkali Test
(1) 1 day's incubation	100	130	—
(2) 2 ,, ,,	100	181	83
(3) 9½ weeks' ,,	100	136	67
(4) 12 ,, ,,	100	151	68

The percentage figures are full of interest, for there are unmistakable differences in the nitrogen partition in the control, acid and alkaline tests respectively. The percentage of ammonia is distinctly lower in the acid than in the control tests, while that of the alkaline test tends to be higher. These characters are maintained in all the periods of incubation investigated. It is interesting to note that the ammonia percentage in the acid test is almost as low at the end of one day's incubation as that of fresh tissue. The percentage amide figures on the whole are higher in the acid and lower in the alkaline tests than in the control. 28 (2) is an exception, but these tests were unfortunately overheated in the autoclave,

and only the control was capable of repetition. These characteristics are also persistent through the whole incubation period.

The percentage of amino acid nitrogen in 33 and 35 shows the same characters as the amide nitrogen, i.e., a relative increase in the acid tests and a relative diminution in the alkaline test.

The percentage of undetermined nitrogen is higher in the acid and lower in the alkaline than in the control tests, and this difference holds good at the different stages of incubation.

Before discussing the significance of these changes, another relation may be brought out, namely, that in all the acid tests the percentage values for ammonia and amides have a ratio between 1 : 2 and 1 : 3, whereas in the alkaline tests the ammonia and amide percentage value approximates 1 : 1.6.

The fact that my experiments show a definite type of autolysis in the presence of acid and alkali respectively, which is persistent throughout the whole course of digestion, leads to the conclusion that the effect of acid is not merely to accelerate, neither is that of alkali merely to inhibit autolysis. Arinkin noted the peculiar cleavage of the protein molecule in the presence of acid in liver autolysis. The nitrogen of the monamino, diamino, ammonia, albumose and peptone fractions was usually increased. This observation was abundantly supported. Yoshimoto, on the other hand, found that the cleavage of the protein molecule by the liver in presence of carbon dioxide occurred in exactly the same way as in normal autolysis. His conclusion carries less weight, as his investigation was primarily directed to the influence of antiseptics on autolysis.

In Drjewezki's work the percentage of monamino acid nitrogen in autolysis in presence of alkali is smaller than in normal autolysis, which bears out the contention that there is a characteristic type of autolysis in presence of alkali.

The nature of this alteration in the type of autolysis is by no means clear. We are hampered in the first place by our ignorance of the origin of the ammonia and amide nitrogen in normal autolysis.

One of the sources of this ammonia is doubtless the so-called amide group in the protein molecule, which is not only readily split off by the action of acid or alkali, but which can be liberated in even larger amount by the proteolytic ferments of the gastric and pancreatic juice according to Driergowski and Salaskin.³⁴

Another possible source is preformed amide nitrogen. Dakin¹⁶

found an increase of ammonia nitrogen in kidney autolysis at the expense of the amide nitrogen, the latter decreasing in proportion as the former increased. In the light of my subsequent experiments on bacterial contamination of tissue digests, however, this result may have been due to bacterial action.

Vernon¹⁹ holds that the hydrolysis of urea by liver tissue is much less doubtful than its formation—but even so the evidence is scanty. Jakoby³⁵ found that liver juice liberated ammonia from urea after thirty-six hours' incubation, although his experiments are not numerous and the results are not very concordant. Gonnerman³⁶ found a liberation of free acid from certain amides by liver tissue, and thus produced indirect evidence of a deamidization. Lang² found a small amount of ammonia after incubating urea, and an abundant liberation after the incubation of asparagin with liver tissue. Furth and Friedmann³⁷ found an asparagin-splitting ferment in the liver, spleen, muscle, kidney, lung, brain and bowel. I¹ also found a considerable liberation of ammonia from the amide asparagin—after incubation with liver emulsion. Lastly, Lang's work would suggest the amino acids as a possible source of ammonia in autolysis. As will be shown later, the percentage of amino acid at the end of incubation shows no diminution, and the ratio of ammonia to amino acid nitrogen does not increase with prolonged incubation; this fact certainly suggests that the amino acids do not furnish appreciable amounts of ammonia during autolysis.

In considering the cause of the characteristic type of alkaline digestion, the question arises whether the presence of alkali favours an enzyme which liberates ammonia from amides, for I have shown that the percentages for ammonia and amide nitrogen approached each other more closely than in any other type of autolysis yet considered.

The difficulty of answering this question is great, for undoubtedly in such a liver emulsion we have not one enzyme but many, some of which at any rate carry on their activities simultaneously. The continual production of more amide nitrogen would in this way mask the action of the amide splitting ferments.

The work of previous investigators is sufficient to show that the difference in the action of acid and alkali is not merely one of acid or alkaline hydrolysis respectively. Drjewezki and Arinkin both compared the action of acid and alkali on boiled tests and found no appreciable effect. This method of putting the ferments out of action is certainly not ideal, but it is the only available one.

On the whole, it seems probable that the different types of autolysis in presence of acid and alkali are due to an initial difference in the protein cleavage rather than to variation in the subsequent catabolism of any of the nitrogen fractions of the digest, for there is no evidence of any alteration in the relative proportions of the latter, i.e., such as might be expected if an increase of one fraction at the expense of another occurred. On the contrary, the characteristic type is present at the end of twenty-four hours' incubation and persists throughout digestion.

INFLUENCE OF BACTERIA ON AUTOLYSIS

No investigation on the effects of tissue digestion can afford to ignore the question of bacterial action, as was pointed out in the previous paper.

Samuely,³⁸ in Oppenheimer's *Handbuch*, states that toluol does not inhibit the tissue ferments in a concentration sufficient to stop bacterial action—this is a very general statement which lacks confirmation. The difficulty of testing its accuracy in the case of autolysis is obvious, and in the hope of finding a characteristic partition of nitrogen for the common bacteria of putrefaction, some experiments were made in a manner similar to those carried out in the investigation of deamination.

In Experiments 30 and 31, three series of tests were prepared, each consisting of 100 gm. liver tissue in the usual way:—

- (1) To the controls the usual addition of toluol was made.
- (2) The boiled tests were heated to 100° and were then allowed to cool, after which about 0·5 c.c. of the mixture from the third series of tests (3) was added to each one—to inoculate them with the bacteria of putrefaction.
- (3) No addition of antiseptic was made to these tests, which simply stood at room temperature until the boiled tests had cooled. 1 c.c. of the mixture was then removed from each test, and after mixing was used for the inoculation of (2).

All the tests were then incubated in the usual way after having been shaken in the machine for not less than half an hour.

- (1) contained enzyme and no bacteria or a minimal quantity.
- (2) contained bacteria and no enzyme.
- (3) contained both enzyme and bacteria.

The naked eye changes were striking after one day's incubation, the bacterial tests showing abundant gas formation, together with alterations in the colour and in the consistence of the fluid. In Experiments 30 and 32 the gas formation was so active in the (3) tests that some of the liver mixture actually spilled over.

TABLE III. All the figures are in c.c. N/10 H₂SO₄ for 100 c.c. filtrate or 25 grams ox liver.

Period of incubation	CONTROL						ACID						ALKALI			
	NH ₃ N	Amide N	Amino acid N	Undeter- mined N	Total Sol. N	NH ₃ N	Amide N	Amino acid N	Undeter- mined N	Total Sol. N	NH ₃ N	Amide N	Amino acid N	Undeter- mined N	Total Sol. N	
28. Addition of 20 c.c. N/10 soda and lactic acid to alkaline and acid tests respectively	(1) 2 days	9.0	18.5	...	90.5	4.4	15.9	...	163.0	9.9	12.2	75.0		
	(2) 4 days	9.4	14.3	...	110.0	5.2	21.4	...	192.0	11.8	18.8	80.0		
	(3) 7 days	11.3	20.8	...	113.0	6.0	18.5	...	216.0	11.8	15.2	90.0		
35. Addition of 20 c.c. N/10 soda and H ₂ SO ₄ to alkaline and acid tests respectively	(1) 9½ days	9.0	15.8	45.5	29.7	6.8	19.9	54.4	18.9	12.1	12.8	35.4	39.7	123.0		
	(2) 12 days	11.0	15.1	52.4	21.5	8.4	17.4	58.7	15.5	12.3	10.1	47.1	30.5	121.0		
	(3) 20 days	19.6	26.8	92.9	37.7	22.7	46.8	157.0	41.5	268.0	15.0	12.3	57.0	36.7	121.0	
33. Addition of 19.75 c.c. N/10 lactic acid and H ₂ SO ₄ to lactic acid and H ₂ SO ₄ tests respectively	(1) 1 day	6.7	11.0	22.1	60.2	3.8	15.3	31.0	49.9	3.8	15.3	29.8	51.1	105.0		
	(2) 4 days	8.7	12.5	31.0	47.8	5.1	18.0	36.3	40.6	4.9	18.0	37.5	39.6	150.0		
	(3) 20 days	10.3	16.5	34.0	39.2	7.1	15.7	34.9	86.9	84.5	222.0		

NOTE.—The upper row of figures in each case represents percentages.

The figures are no less striking, the total soluble nitrogen after one day's incubation is more than twice as great in the unboiled as in the antiseptic tests—in the boiled test, on the other hand, it is practically the same as in the fresh tissue. This may be due to the fact that coagulated protein is less readily attacked than uncoagulated, or that the bacteria in the boiled tests had not had enough 'start.'

The most interesting point, however, is that in both boiled and unboiled tests the percentage amount of ammonia is increased in relation to that of amide, whereas in the control tests the opposite relation is found. The obvious explanation is that part of the ammonia is being liberated from amide nitrogen by bacterial action. Although it must be remembered that Brasch³⁹ has shown that ammonia is readily liberated from amino acids by bacteria.

The tests worked up at the end of five hours' digestion in 31 show ratios for ammonia and amide very like that of the control, the inference being that in five hours bacterial growth and action had not made itself felt to any extent.*

In Experiment 32 no boiled tests were prepared, only tests with and without antiseptic—the reversal of the normal amide and ammonia ratio is again visible in the bacterial tests, and at the end of eight weeks' incubation it holds good.—See 35 A.

Undetermined Nitrogen.—In Experiment 32, after one and two incubations respectively, the actual and percentage amounts of undetermined nitrogen are larger than those of the controls, but in Experiment 36 (2), A and B, the percentage amounts at the end of seven days' incubation reach the lowest limit in any of the Tables, namely 20·6 per cent. and 20·4 per cent.

In Experiments 35 and 36, the effect of adding varying amounts of antiseptic was tried, three series of tests being prepared, each of 50 grams. To A no antiseptic was added, to B 0·5 c.c. toluol, and to C 1 c.c. toluol was added. All the tests were then shaken by hand for a few minutes before incubating them.

On looking at the tabulated results, one is at once struck by their irregularity. Certain general characters prevail for test A, i.e., the ammonia percentage is always higher than the amide. This is true for B and C in Experiments 35 and 36 (2), but in 36 (1) the normal (i.e., in antiseptic) relation of ammonia and amide is found.

* The amide tests were overheated in the autoclave and the values are consequently rather high.

The amino acid nitrogen show a better sequence in 30 (1), (2), and 35, i.e., after three days, seven days, and eight weeks' incubation respectively, than any of the other fractions. The amino acid percentage increases from the third till the seventh days, and diminishes again at the end of the eighth week. It is highest in the case of the A and B tests.

The odour varied, being sometimes putrid and sometimes yeasty. In Experiment 32 the odour was intensely yeasty, in 36 it was noticed that the A test had an odour of sulphuretted hydrogen after one day's incubation; after three days' incubation the A tests, however, had also a sour yeasty odour. At the end of seven days' incubation there is no note of any odour, but growing on the surface of A a mould was noticed.

In 35, after eight weeks' digestion, A had a putrid odour and a strongly alkaline reaction. B had an unpleasant but not putrid odour, and was also strongly alkaline; while C had an acid odour suggestive of butyric acid, and had a faintly acid reaction. The reaction of all the other tests was faintly acid.

In the light of Ellinger's⁴⁰ work on the chemistry of putrefaction, the variations found as the result of the small amounts of antiseptic added may probably be explained on the basis of variations in the bacterial flora.

The following factors would lead one to expect bacterial contamination in an organ digest; viz., a high ammonia percentage combined with a lower amide percentage, and a high total soluble nitrogen figure.

It is interesting to note that the bacterial type of nitrogen distribution approximates more closely to the alkaline type of autolysis, with regard to the ammonia and amide ratios; the amino acid percentage, however, is higher than in the case of the alkaline autolysis.

A few words may be said about the influence of antiseptics on autolysis.

Cruickshank,⁴¹ from a study of the histological appearances in organs undergoing autolysis, found that the action of toluol markedly delayed the onset and progress of autolysis—the liver showed complete necrosis on the third day, in aseptic autolysis, while well-stained nuclei were found after five or six days if autolysis took place in the presence of toluol vapour. He also points out that toluol vapour is enough to completely inhibit the growth of *Staph. aur.* and *B. coli*; the organisms were not killed, however, growth occurring on the removal of the toluol.

Navassart⁴² investigated the action of antiseptics on yeast autolysis

In experiments 35 and 36, 100 c.c. filtrate corresponds to 12.5 grams of liver.

Experiment	Period of incubation	CONTROL						BACTERIAL					
		NH ₃ N	Amide N	Amino acid N	Undeter- mined N	Total Sol. N	NH ₃ N	Amide N	Amino acid N	Undeter- mined N	Total Sol. N		
28	...	9.0	18.5	90.5	2.4	10.9	300.0		
	2 days	8.2	16.8	90.5	7.17	32.8	300.0		
30	...	7.2	14.3	83.2	12.3	4.4	214.0		
	1 day	6.0	11.9	83.2	26.4	9.4	214.0		
31	...	5.7	13.4	59.0	5.7	12.1	71.0		
	5 hours	3.4	7.95	59.0	4.0	8.6	71.0		
32	...	9.5	13.8	72.0	7.0	11.5	43.0		
	1 day	6.8	9.9	72.0	3.05	4.95	43.0		
33	...	7.2	12.9	30.2	49.7	81.0	9.6	7.4	22.9	58.0	147.0		
	1 day	5.8	10.4	24.4	40.2	81.0	22.5	17.4	33.0	85.2	147.0		
34	...	8.0	12.0	32.2	47.8	99.0	12.3	4.1	24.0	59.5	259.0		
	2 days	8.0	11.9	32.0	47.5	99.0	32.0	10.65	62.0	154.3	259.0		
35	...	20.8	10.2	40.0	29.0	216.5	13.0	10.5	45.0		
	8 weeks	45.0	22.2	86.6	62.7	216.5	5.8	4.75	45.0		
36	...	31.4	21.0	34.6	13.0	182.5	11.8	7.7	22.9	58.0	147.0		
	3 days	57.4	38.4	63.3	23.4	182.5	17.4	11.4	33.0	85.2	147.0		
37	...	42.8	4.1	16.8	36.3	158.0	12.3	4.1	24.0	59.5	259.0		
	3 days	67.7	6.5	26.5	57.3	158.0	32.0	10.65	62.0	154.3	259.0		
Remarks on Experiments 35 and 36													
A = Without antiseptic													
B = 0.5 c.c. toluol present													
C = 1.0 c.c. toluol present													
38	...	11.2	4.0	48.3	36.5	124.0	14.4	5.1	59.9	20.6	211.7		
	3 days	14.0	5.0	60.0	45.0	124.0	30.6	10.7	126.8	43.6	211.7		
39	...	2.6	9.2	49.9	43.8	167.5	8.1	7.5	64.0	20.4	218.0		
	3 days	4.1	14.0	76.0	73.4	167.5	17.8	16.3	139.4	44.5	218.0		
40	...	5.4	9.6	45.8	39.2	78.5	8.3	6.9	54.6	30.2	146.0		
	3 days	4.3	7.6	36.0	30.6	78.5	12.2	10.0	79.8	44.0	146.0		

NOTE.—The upper row of figures in each case represents percentages.

in 1911—comparing the various antiseptics with chloroform. He showed that a half saturated solution of toluol did not destroy bacteria.

Laqueur⁴³ stated that sodium fluoride in 0.3 per cent. solution acted well as an antiseptic and was less injurious to the autolytic ferments than toluol.

With regard to so-called aseptic autolysis, Magnus Levy,⁴⁴ in 1902, found that the addition of antiseptic caused delay and a marked diminution in autolytic changes. At the end of twenty-four hours' incubation the liver was intensely acid, soft, and floating in a dark froth, while it was covered with a foam layer.

It must be mentioned that Magnus Levy's figures show no regular sequence even in the serial tests—and in the light of Wolbach and Saiki's work,⁴⁵ it is an open question whether bacteria were not largely responsible for the above changes. These workers removed the liver from dogs with elaborate aseptic precautions, and found that only two remained sterile out of twenty-three. The two sterile livers were firm and elastic after forty-eight hours' incubation, while the ones showing the bacillus were soft, discoloured, showing gas formation and having a peculiar rancid odour.

The organism found was a spore bearing anaerobe, which was cultivated with considerable difficulty.

Jackson⁴⁶ found that the total soluble nitrogen at the end of forty-eight hours in the two sterile livers of Wolbach and Saiki was only equal to that of the non-sterile livers at the end of ten to twelve hours' incubation.

Lindemann,⁴⁷ 1911, studied the autolysis of aseptically removed livers of rabbits, cats and dogs, finding gas formation (carbonic acid and hydrogen) and acid formation if the organs were immediately incubated at 37°. His results fully confirm those of Magnus Levy. He mentions the fact that organs other than the liver and heart never remain sterile, while one-third only of the heart and liver remained sterile, i.e., negative cultures were obtained from them.

FORMATION OF AMIDE NITROGEN FROM AN AMMONIUM SALT IN VITRO

The question may now be considered as to the fate of a neutral ammonium salt when incubated with liver tissue under the conditions already described. We shall find it convenient to look at the results of the last two tests first, namely Test 37, Table V. The ammonia was added to the liver tissue in the form of ammonium hydrate, neutralized

with lactic acid. The amount added to 100 grams liver was equal to 38.0 c.c. N/10, i.e., 9.5 c.c. for every 25 grams of tissue or 100 c.c. of the final filtrate.

The percentage values in relation to the total soluble nitrogen are calculated after subtracting 9.5 (the amount of added ammonia) from the figure for the total soluble nitrogen. The percentage for the ammonia values are calculated after subtracting 9.5 from the figure for the ammonia also.

Three series of tests, 1, 2 and 3, were incubated nine days, two weeks, and three weeks respectively. The ammonia recovered at the end of that time was 9.7, 9.1, and 10.4 respectively. Although in the ammonia tests the actual figures for the amide nitrogen all show a slight increase, the percentage figures do not bear this out, the differences between the control and the ammonia tests being within the limits of experimental error. The same holds good for the amino acid figures. The total soluble nitrogen (after the subtraction of the equivalent of the added ammonia) is higher than that of the control test in one case, the greatest difference being in No. (3). From these figures it is evident that there has been no appreciable change in the ammonium salt added, and there is no evidence of any of it being converted into amide nitrogen.

In 35, two series of tests were incubated 9½ and 12 weeks respectively. 35.6 c.c. N/10 ammonia neutralized with H₂SO₄ was added to the ammonia tests or 8.9 c.c. for 100 c.c. filtrate. The amounts of ammonia recovered were 9.6 in (1) and 7.7 in (2). The amide figures in absolute and percentage amount are lower than those of the control. They are so low in (1) as to raise suspicion of error—the amino acid figures are actually rather higher than in the control, but the percentage figures, although higher, are almost within the limits of experimental error. The total soluble nitrogen figures are equal in (1) and slightly higher in (2). These results confirm those of Experiment 37.

In 29, where ammonia equal to 20.4 c.c. N/10 neutralized with lactic acid was added to 100 gm. liver, two series of tests were incubated eight and thirty-two days respectively. The amount of added ammonia calculated for 100 c.c. filtrate is 5.1 c.c. N/10. In (1) 7.95 c.c. is recovered, and in (2) 2 c.c., but the latter result is doubtful in view of the fact that the value for ammonia is actually lower in the (2) ammonia test than in (1). There is a small actual increase of the amide nitrogen in both tests, but the percentage increase is negligible.

TABLE V.—All figures in c.c. N/10 H₂SO₄ for 100 c.c. filtrate or 25 grams liver tissue

		CONTROL					
		NH ₃ N	Amide N	Amino acid N	Undetermined N	Total Sol. N	
		Period of incubation					
35. NH ₃ N added in ammonia test to 100 grams liver = 35.6 c.c. N/10 H ₂ SO ₄	(1) 9½ weeks		9.1	15.8	45.6	29.5	
			16.5	28.8	83.0	53.7	182.0
	(2) 12 weeks		11.1	15.1	52.5	21.3	
			19.6	26.8	92.9	37.7	177.0
	37. NH ₃ N in glycocoll added to 100 grams liver = 55.6 N/10 H ₂ SO ₄	(1) 9 days		11.8	11.6	51.0	25.6
				11.8	11.7	51.1	25.4
(2) 2 weeks			11.6	12.0	48.8	27.6	
			13.5	14.0	56.5	32.0	116.0
(3) 3 weeks			11.9	12.4	46.7	29.0	
			13.6	14.1	53.3	33.0	114.0
36. NH ₃ N in glycocoll added to 100 grams liver = 55.6 N/10 H ₂ SO ₄	(1) 9 days		9.9	12.9	49.8	27.4	
			11.4	14.8	57.3	31.5	115.0
	(2) 3 weeks		10.2	15.9	54.3	19.6	
			15.1	23.5	80.4	29.0	148.0
	39. NH ₃ N added to 100 grams liver in ammonia tests = 20.4 c.c. N/10 H ₂ SO ₄	8 days		9.0	16.0
				11.9	21.2
32 days			7.8	18.5	
NH ₃ N in glycocoll added to 100 grams liver = 53.2 c.c. N/10			13.8	32.6	176.0

NOTE.—The upper row of figures in each case represents percentages.

GLYCOCOLL							AMMONIA					
NH ₃ N	Amide N	Amino acid N	Undeter- mined N	Total sol. N	Total Sol. N minus added N	NH ₃ N recovered	NH ₃ N	Amide N	Amino acid N	Undeter- mined N	Total sol. N	Total Sol. N minus added N
—	—	—	—	—	—	9.6	9.4	11.2	48.7	30.7	—	—
—	—	—	—	—	—	—	26.1	20.5	88.6	55.8	191.0	182.1
—	—	—	—	—	—	—	10.1	12.6	56.1	21.2	—	—
—	—	—	—	—	—	7.7	27.3	22.9	102.2	38.6	191.0	182.1
—	—	—	—	—	—	—	11.0	11.2	49.3	28.5	—	—
—	—	—	—	—	—	9.7	21.5	12.2	53.4	30.9	118.0	108.5
—	—	—	—	—	—	—	10.8	12.7	51.0	25.5	—	—
—	—	—	—	—	—	9.1	22.6	15.2	60.9	30.3	129.0	119.5
11.1	12.9	48.0	28.0	—	—	—	10.7	12.2	44.1	33.0	—	—
15.2	17.7	79.7	38.4	151.0	137.1	10.4	23.9	16.4	59.1	44.2	142.0	134.3
—	—	—	—	—	—	—	24.1	16.5	59.1	—	145.7	—
10.2	14.7	54.7	20.3	—	—	—	—	—	—	—	—	—
11.7	16.8	76.3	23.2	128.0	114.1	—	—	—	—	—	—	—
10.1	17.3	55.5	17.1	—	—	—	—	—	—	—	—	—
15.3	26.3	98.2	26.2	166.0	152.1	—	—	—	—	—	—	—
8.1	17.9	—	—	—	—	—	8.9	16.8	—	—	—	—
10.2	22.8	—	—	139.0	125.6	4.9	16.85	22.4	—	—	138.0	132.9
—	—	—	—	—	—	—	6.2	19.7	—	—	—	—
—	—	—	—	—	—	2.0	15.8	34.9	—	—	177.0	171.9

NOTE.—The upper row of figures in each case represents percentages.

It is interesting to note in connection with the above that Loewi was unable to obtain urea formation in a liver extract to which ammonium acetate had been added.

FORMATION OF AMIDE NITROGEN FROM GLYCOCOLL IN VITRO

After finding that the formation of amide nitrogen from a neutral ammonium salt in liver digests is absent or so small in amount as to be negligible, one would not expect to find evidence of much amide formation when an amino acid was incubated with the liver tissue.

As in the ammonia tests, the percentage figures are calculated from the total soluble nitrogen after subtracting the amount of added glycocoll nitrogen. The same amount is subtracted from the figure for the amino acids before calculating its percentage amount of the total soluble nitrogen.

In Experiment 36, the amount of glycocoll nitrogen calculated for 100 c.c. filtrate was 13.9 c.c. N/10. Two series of tests were incubated nine days and three weeks respectively. The increase in ammonia nitrogen is so small as to be negligible, but there is a distinct increase in the amide nitrogen both in actual and percentage amounts. In (2) the amide values of control and glycocoll test are both, unfortunately, too high, as the autoclave was overheated for about fifteen minutes. This does not gravely interfere with the comparative values, however. The amino acid shows a very distinct actual increase in the glycocoll tests with a less marked percentage increase. There is practically no increase in the total soluble nitrogen, so that apparently autolysis has not been more rapid in the glycocoll test.

In 37, after three weeks' digestion, practically the same conditions are found, the percentage amide increase in the glycocoll test is considerably smaller than the actual increase, and is within the limits of experimental error. The same is true for the percentage of the amino acid. Here the total soluble nitrogen is distinctly larger than in the control test.

In 29, after eight days' incubation, there is a very small actual and percentage increase in amide nitrogen. Both Jakoby and Loewi state that they found a small formation of amide or urea nitrogen on incubating glycocoll with liver extract.

The evidence on the whole is in favour of a small formation of amide nitrogen from glycocoll.

CONCLUSIONS

1. No satisfactory conclusions regarding the fate of ammonium salts or amino acids when digested with liver tissue can be drawn without a consideration of the total soluble nitrogen and such fractions as the following:—i.e., ammonia, amide nitrogen and amino acid nitrogen. Both absolute and percentage amounts (of the total soluble nitrogen) must be considered.

2. *The influence of certain factors on Autolysis.*

(a) *Period of incubation.*—The percentage distribution of total soluble nitrogen in fresh liver tissue is characterised by an extremely low ammonia content, and a low amino acid content. After forty-eight hours' incubation the most definite change is an increase in the amino acid fraction at the expense of the undetermined nitrogen fraction. The rate of autolysis reaches a maximum within forty-eight hours, after which it gradually diminishes.

(b) *The effect of reaction of medium.*—Acid markedly stimulates and alkali causes a marked depression of autolysis. Acid and alkali each produce a characteristic nitrogen partition throughout the whole incubation period. Autolysis in presence of acid is distinguished by a lower ammonia and undetermined nitrogen percentage, and a higher amide and amino acid percentage than that of control normal autolysis. Autolysis in the presence of alkali is distinguished from the control autolysis by a higher percentage of ammonia and undetermined nitrogen and a lower percentage of amide and amino acid.

(c) *The presence of putrefactive organisms* in liver digests is characterised by a relatively high ammonia and a relatively low amide percentage combined with a large amount of total soluble nitrogen.

3. There is no evidence of an appreciable conversion of ammonium sulphate or lactate into amide nitrogen when digested with liver pulp. Such differences as were found were within the limits of experimental error.

4. There is no evidence of a liberation of ammonia from glycocoll when incubated with liver tissue. There is a slight actual and percentage increase in amide nitrogen, however.

In view of the fact that the total amount of ammonium is markedly increased when putrefactive organisms are present, conclusions regarding

deaminization by autolytic ferments should be received with caution unless accompanied by figures showing the relation of ammonia to the total soluble nitrogen of the digest. The fact that even at the end of twelve weeks the ammonia shows no increase at the expense of the amino acid fraction is itself an indication that deaminization of amino acids by liver digests can only occur to a very limited extent.

I wish to express my sincerest thanks to Dr. E. P. Cathcart for supervising this research. I am also indebted to Professor D. Noel Paton for his helpful criticism.

The expenses of this investigation were in part defrayed by a grant made to Dr. E. P. Cathcart by the Carnegie Trust.

LITERATURE

1. Bostock, *Bio-Chemical Journ.*, Vol. VI, p. 48, 1911.
2. Lang, *Hof. Beit.*, Vol. V, p. 321, 1904.
3. Loevi, *Zeit. f. physiol. Chem.*, Vol. XXV, p. 511, 1898.
4. Kruger and Reich, *Zeit. f. physiol. Chem.*, Vol. XXXIX, p. 165, 1903; Schittenhelm, *Zeit. f. physiol. Chem.*, Vol. XXXIX, 73, 1903.
5. Benedict and Gephart, *Journ. Am. Chem. Soc.*, Vol. XXX, p. 1760, 1908.
6. Henriques and Gammeltoft, *Skand. Arch. f. Physiol.*, Vol. XXV, p. 153, 1911.
7. Benedict, *Journ. Biol. Chem.*, Vol. VIII, p. 405, 1910.
8. Wolf and Osterberg, *Journ. Amer. Chem. Soc.*, Vol. XXXI, p. 421, 1909.
9. Levene and Meyer, *Journ. Amer. Chem. Soc.*, Vol. XXXI, p. 717, 1909.
10. Henriques and Sørensen, *Zeit. f. physiol. Chem.*, Vol. LXIII, p. 27, 1909.
11. Malfatti, *Zeit. f. physiol. Chem.*, Vol. LXVI, p. 152, 1910.
12. De Jäger, *Zeit. f. physiol. Chem.*, Vol. LXII, p. 333, 1909.
13. Henriques and Sørensen, *Zeit. f. physiol. Chem.*, Vol. LXIV, p. 120, 1910.
14. Simon, *Zeit. f. physiol. Chem.*, Vol. LXX, p. 65, 1910.
15. Salkowski, *Zeit. f. klin. Med.*, Vol. XVII, Suppl., p. 77, 1890.
16. Dakin, *Journ. Physiol.*, Vol. XXX, p. 84, 1903-04.
17. Drjewecki, *Bioch. Zeit.*, Vol. I, p. 229, 1906.
18. Folin and Denis, *Journ. Biol. Chem.*, Vol. XI, p. 527, 1912.
19. Vernon, *Ergebnisse der Physiol.*, Vol. IX, p. 138, 1910.
20. Schwiening, *Virch. Arch.*, Vol. CXXXVI, p. 444, 1894.
21. Biondi, *Virch. Arch.*, Vol. CXLIV, p. 373, 1896.
22. Hildebrandt, *Hof. Beit.*, Vol. V, p. 463, 1904.
23. Hedin and Rowland, *Zeit. f. physiol. Chem.*, Vol. XXXII, p. 340, 1901.
24. Hedin and Rowland, *Zeit. f. physiol. Chem.*, Vol. XXXII, p. 530, 1901.
25. Hedin, *Jour. Physiol.*, Vol. XXX, p. 155, 1903-04.
26. Hedin, *Festsch. Hammarsten*, Vol. VI, 1906.
27. Baer and Loeb, *Arch. f. Exper. Path.*, Vol. LIII, p. 1, 1905.
28. Wiener, *Zentbltt. f. Physiol.*, Vol. XIX, p. 349, 1906.
29. Shryver, *Bioch. Journ.*, Vol. I, p. 123, 1906.
30. Arinkin, *Zeit. physiol. Chem.*, Vol. LIII, p. 192, 1907.
31. Preti, *Zeit. physiol. Chem.*, Vol. LII, p. 485, 1907.
32. Laqueur, *Zeit. f. physiol. Chem.*, Vol. LXXVII, p. 38, 1912.
33. Yoshimoto, *Zeit. physiol. Chem.*, Vol. LVIII, p. 341, 1908-09.
34. Dziergowski and Salaskin, *Centrbltt. f. Physiol.*, Vol. XV, p. 249, 1901.
35. Jakoby, *Zeit. f. physiol. Chem.*, Vol. XXX, p. 149, 1900.
36. Gonnermann, *Pfl. Archiv.*, Vol. LXXXIX, p. 493, 1902; Vol. XCV, p. 278, 1903.
37. Furth and Friedmann, *Biochem. Zeit.*, Vol. XXVI, p. 435, 1910.
38. Samuely, *Oppenheimer's Handbuch*, Vol. IV, p. 522.
39. Brasch, *Bioch. Zeit.*, Vol. XXII, p. 402, 1909.
40. Ellinger, *Ergeb. Physiol.*, Vol. VI, p. 292, 1907.
41. Cruickshank, *Journ. Path. and Bact.*, Vol. XVI, 1911.
42. Navassart, *Zeit. f. physiol. Chem.*, Vol. LXXII, p. 151, 1911.
Navassart, *Zeit. f. physiol. Chem.*, Vol. LXX, p. 189, 1910-1911.
43. Laqueur, *Zeit. f. physiol. Chem.*, Vol. LXXVII, p. 82, 1912.
44. Magnus Levy, *Hof. Beit.*, Vol. II, p. 261, 1902.
45. Wolbach and Saiki, *Journ. Med. Research*, Vol. XXI, p. 267, 1909.
46. Jackson, *Journ. Med. Research*, Vol. XXI, p. 281, 1909.
47. Lindemann, *Zeit. f. Biolog.*, Vol. LV, pp. 37-167, 1910.

THE EFFECTS OF PURINE DERIVATIVES AND OTHER ORGANIC COMPOUNDS ON GROWTH AND CELL-DIVISION IN PLANTS

By N. G. S. COPPIN, M.Sc., *University of Liverpool*.

From the Bio-Chemical Department, University of Liverpool

(Received July 23rd, 1912)

This investigation was undertaken mainly with the object of studying the effect of allantoin on cell growth; this compound having been used with considerable success as a cell proliferant in the treatment of ulcers, burns, etc., by Dr. C. J. Macalister (*Brit. Med. Journ.*, Jan. 6th, 1912). In addition to allantoin, other compounds of the same group, and the sodium salts of some organic acids were used in these experiments, which were carried out on similar lines to those employed by Moore and Roaf (*Bio-Chem. Journ.*, 1908, 3, 279) in their work on the effects of inorganic salts upon the growth and cell-division in plants.

The plants used were a common variety of hyacinth with white florets. They were placed in hyacinth glasses, which were enclosed in blue paper bags, in order to prevent the action of light upon the rootlets. The list of solutions employed was as follows:—Allantoin, sodium huminate, sodium nucleate, guanine hydrochloride, xanthine, hypoxanthine hydrochloride, caffeine, sodium malate, sodium urate, sodium oxalate, sodium oleate, sodium linoleate, and Bovril. Two controls were employed, one of ordinary tap-water, and another to which a trace of sodium hydroxide was added, on account of the fact that certain of the solutions when being prepared were made slightly alkaline to phenol phthalein. The solutions were all made up with ordinary tap-water, and in most cases of three strengths, 0·5 per cent., 0·1 per cent., 0·02 per cent.

Measurements of both rootlets and leaves were taken from time to time, and are shown in the accompanying table.

In general terms it may be stated that in the cases of the 0·1 per cent. and 0·02 per cent. solutions of sodium huminate, 0·02 per cent. sodium malate, 0·02 per cent. sodium urate, and 0·02 per cent. sodium oxalate, the rate of growth was distinctly increased, this increase being most

marked in the sodium huminate solutions; 0.1 per cent. Bovril also stimulated the growth but not to so great an extent as the above solutions. In every other case, however, the growth of the bulb was either retarded or completely arrested.

It is also worthy of note that, with the single exception of sodium nucleate, every other solution of 0.5 per cent. strength which was employed entirely arrested the growth of the rootlets and greatly retarded that of the leaves, and in nearly every case the most rapid growth took place in the weakest solutions.

The rootlets of the bulbs grown in the sodium nucleate, sodium oleate, sodium linoleate and Bovril solutions, although comparatively short in length, were very thick.

ALLANTOIN SOLUTIONS

(Lengths in centimetres)

Strength of Solution	26 Days	54 Days		97 Days		119 Days		
		Roots (only)	Roots	Leaves	Roots	Leaves	Roots	
Control (I) ...	7.5	13.0	3.0	13.0	15.5	14.0	30.0	(flowering)
„ (II) ...	8.0	13.0	3.0	13.0	14.5	13.0	20.0	(flowering)
0.1% (I) ...	3.0	3.5	1.5	3.5	8.5	4.0	19.0	(flowering)
„ (II) ...	1.5	1.5	0.5	1.5	4.5	1.5	10.0	(flowering)
„ (III) ...	3.0	4.0	1.0	4.0	10.5	5.0	21.0	(flowering)
0.2% (I) ...	1.5	1.5	1.0	1.5	4.5	1.5	9.0	(flowering)
„ (II) ...	5.0	5.0	2.5	7.0	8.5	7.0	13.0	(flowering)
„ (III) ...	5.0	5.0	2.5	5.0	10.0	6.0	22.0	(flowering)
0.3% (I) ...	No growth	No growth	1.0	No growth	3.5	No growth	6.0	(flowering)
„ (II) ...	5.0	6.5	2.5	8.0	4.5	8.0	6.0	
„ (III) ...	5.5	8.0	2.5	8.0	4.0	8.0	4.5	
0.5% (I) ...	No growth	No growth	0.75	No growth	1.5	No growth	3.5	(just com-
„ (II) ...	No growth	No growth	0.5	No growth	2.5	No growth	3.0	mencing
„ (III) ...	No growth	No growth	0.5	No growth	2.0	No growth	3.0	to flower)

SOLUTIONS OF PURINE DERIVATIVES AND OTHER ORGANIC COMPOUNDS

Solution	Strength	25 Days		48 Days		68 Days		90 Days		
		Roots	Leaves	Roots	Leaves	Roots	Leaves	Roots	Leaves	
Control (1) ... (Water) (2) ...		cms.	cms.	cms.	cms.	cms.	cms.	cms.	cms.	
		3.0	3.5	4.0	5.0	4.5	11.5	6.0	28.0	
		2.5	3.5	3.0	6.0	3.5	14.5	4.0	30.0	
Control (1) ... (Alkali) (2) ...		6.0	3.0	8.0	5.0	9.0	14.0	11.0	35.0	
		5.0	3.5	5.5	7.0	7.5	15.0	10.0	35.0	(B.)
Sodium Huminate	0.5 %	Not growing	3.5	Not growing	4.0	Not growing	5.0	Not growing	5.0	
	0.1 %	5.0	2.5	12.0	3.5	16.0	9.0	18.0	30.0	(F.)
	0.02 %	7.0	3.5	13.0	4.5	14.0	11.0	14.0	30.0	(F.)
	0.02 %	5.0	4.0	8.0	5.5	8.5	13.0	9.0	31.0	(F.)
Sodium Nucleate	0.5 %	1.5	3.5	2.0	4.0	2.5	5.0	2.5	7.0	
	0.1 %	1.0	3.0	1.5	4.0	2.0	6.0	2.5	27.0	(F.)
	0.02 %	1.5	2.5	2.0	3.5	2.5	6.5	2.5	25.0	(F.)
Guanine Hydrochloride	0.07 %	Not growing	1.5	Not growing	1.5	Not growing	2.5	Not growing	7.0	
	0.07 %	Not growing	2.5	Not growing	3.5	Not growing	4.0	Not growing	6.0	(B.)
Xanthine ...	0.03 %	1.5	2.0	3.5	3.0	9.0	9.0	11.0	13.0	(F.)
	0.03 %	1.0	2.0	1.5	3.0	6.0	6.0	10.0	22.0	(F.)
Hypoxanthine Hydrochloride	0.07 %	Not growing	1.5	Not growing	2.0	Not growing	2.5	Not growing	3.0	
	0.07 %	Not growing	1.5	Not growing	2.0	Not growing	2.5	Not growing	3.0	
Sodium Malate ...	0.5 %	Not growing	2.0	Not growing	2.5	Not growing	3.0	Not growing	3.0	
	0.1 %	1.0	2.0	1.0	2.5	1.0	3.0	1.0	4.5	(B.)
	0.02 %	7.0	2.0	9.0	3.5	13.0	10.0	15.0	30.0	(F.)
	0.02 %	7.0	4.0	8.0	6.0	8.5	16.0	9.0	33.0	(F.)
Caffeine ...	0.5 %	Not growing	1.0	Not growing	1.5	Not growing	2.0	Not growing	2.0	
	0.1 %	Not growing	1.0	Not growing	2.0	Not growing	3.0	Not growing	6.0	
	0.02 %	Not growing	1.5	Not growing	3.0	Not growing	4.0	Not growing	11.5	
	0.02 %	1.0	2.0	4.0	4.5	9.5	11.0	10.5	32.0	(B.)
Sodium Urate ...	0.5 %	Not growing	2.5	Not growing	3.5	Not growing	4.5	Not growing	4.0	
	0.1 %	Not growing	3.0	Not growing	4.0	Not growing	7.0	Not growing	8.0	
	0.02 %	7.0	3.5	9.0	6.0	11.0	16.0	11.0	30.0	
	0.02 %	6.0	3.5	9.0	6.0	11.0	14.5	13.0	27.5	
Sodium Oxalate...	0.5 %	Not growing	3.0	Not growing	3.5	Not growing	4.0	Not growing	5.0	
	0.1 %	1.0	3.5	4.0	3.5	4.0	6.5	5.5	16.0	
	0.02 %	4.0	3.5	5.0	6.0	6.5	16.0	8.0	31.0	
	0.02 %	8.0	4.0	11.5	6.5	11.5	16.0	13.0	33.0	
Sodium Oleate ...	0.5 %	Not growing	3.0	Not growing	3.5	Not growing	4.0	Not growing	4.5	
	0.1 %	6.0	3.5	7.0	4.5	8.5	9.5	9.0	12.5	
	0.02 %	4.5	4.0	7.0	7.0	8.5	19.5	9.0	32.0	
	0.02 %	2.0	4.0	3.0	5.0	3.5	9.0	4.0	12.5	
Sodium Linoleate	0.5 %	Not growing	3.0	Not growing	3.0	Not growing	5.0	Not growing	5.5	
	0.1 %	3.0	3.5	6.0	6.0	7.0	18.0	8.0	27.0	
	0.02 %	2.0	2.5	2.5	3.5	2.5	4.0	3.0	4.5	
	0.02 %	3.0	2.5	7.0	4.5	9.0	12.5	10.0	34.0	
Bovril ...	0.1 %	4.0	2.5	6.0	4.5	9.0	16.5	9.5	30.0	
	0.1 %	3.0	3.0	6.0	7.0	7.5	22.5	9.0	35.0	(B.)

F. = Flowering.

B. = Budding—i.e., floret just making its appearance.

HISTOLOGICAL INVESTIGATION OF THE GROWING CELLS AND DIVIDING
NUCLEI UNDER THE INFLUENCE OF THE ABOVE COMPOUNDS

A few of the ends of the growing rootlets were cut off at various times for the purpose of studying the effects of the solutions on cell-division and nuclear changes. These ends were immediately fixed in Flemming's solution, and sections cut and stained for microscopical examination, of which the following are brief notes:—

Sections of Rootlets cut after Seventeen Days' Growth

Control (Water).—Normal condition but not much cell-division.

Control (Alkali).—Frequent cell-division; much more than in the water control. Cell-division figures very regular.

Sodium Huminate (0.1 per cent. Solution).—Cell-division much darker. Divisions less frequent than in the alkaline control and irregular in form. The nuclei often appear in dark rounded masses with clear spaces surrounding them.

Sodium Huminate (0.02 per cent. Solution).—Cell-division more frequent. Chromosomes of irregular length and in beaded rows; different from the continuous rods of the normal preparation.

Sodium Nucleate (0.5 per cent. Solution).—Similar in appearance to the 0.1 per cent. sodium huminate, apparently indicating the presence of more chromatin. A few cell-divisions which are very irregular, showing the tendency of the chromosomes to shorten in length.

Sodium Nucleate (0.1 per cent. Solution).—Same dark rounded nuclei as in the two previous numbers. Only a few cell-divisions, irregular in form.

Sections of Rootlets cut after Twenty-seven Days' Growth

Controls.—Large amount of cell-division.

Allantoin (0.5 per cent. Solution).—Fair number of dividing cells; divisions regular.

Allantoin (0.3 per cent. Solution).—Very small amount of cell-division.

Allantoin (0.2 per cent. Solution).— " " "

Allantoin (0.1 per cent. Solution).— " " "

Sections of Rootlets cut after Thirty-three Days' Growth

Control (Water).—Not much cell-division occurring. Nuclei elongated in form.

Control (Alkali).—Amount of cell-division considerably greater than in the previous control. Divisions quite regular.

Sodium Huminate (0.5 per cent. Solution).—Cell-division practically absent.

Guanine Hydrochloride (0.07 per cent. Solution).—Degenerating.

Hypoxanthine Hydrochloride (0.07 per cent. Solution).—Degenerating.

Sodium Malate (0.5 per cent. Solution).—Degenerating.

Caffeine (0.02 per cent. Solution).—A fair amount of cell-division taking place; divisions irregular.

Sodium Urate (0.1 per cent. Solution).—Most of the roots degenerating.

Sodium Oxalate (0.1 per cent. Solution).—A fair amount of cell-division; divisions remarkably regular.

Sodium Oleate (0.5 per cent. Solution).—Most of the roots degenerating.

Sodium Nucleate (0.02 per cent. Solution).—Large numbers of nucleoli present. Hardly any dividing cells; such as they are, irregular, and majority of nuclei in rounded, resting form.

Xanthine (0.03 per cent. Solution).—Much the same as the previous number, with perhaps a few more cells in dividing condition.

Sodium Malate (0.1 per cent. Solution).—Only a small number of cell-divisions, regular in form.

Sodium Malate (0.02 per cent. Solution).—A fair number of dividing cells, irregular in form.

Sodium Linoleate (0.1 per cent. Solution).—A fair amount of cell-division, regular in form.

Sodium Linoleate (0.02 per cent. Solution).—Large numbers of dividing cells, very irregular and uneven in form, sometimes nearly all the chromatin passing to one of the poles. Chromosomes of very unequal length.

Sodium Oleate (0.1 per cent. Solution).—Considerable amount of cell-division; divisions regular.

Sodium Oleate (0.02 per cent. Solution).—Less cell-division than in the previous number; divisions regular.

Sodium Oxalate (0.02 per cent. Solution).—Large number of cell-divisions, beautifully regular in form.

Sodium Urate (0.02 per cent. Solution).—Divisions less frequent and somewhat irregular. Nucleoli very evident.

The slides of the 0.1 per cent. and 0.02 per cent. solutions of sodium oxalate were of particular interest on account of the remarkable regularity of the cell-divisions.

CONCLUSIONS

1. The growth of the bulbs is stimulated by dilute solutions of sodium huminate, sodium malate, sodium urate, and sodium oxalate, and to a less extent by Bovril. The increase in growth is more marked in the rootlets than in the leaves.

In most cases 0.02 per cent. appears to be the most favourable strength; the growth is considerably less in stronger solutions, and is completely arrested by a 0.5 per cent. solution.

2. Cell-division is stimulated to a considerable extent by dilute solutions of sodium huminate, sodium oxalate, sodium oleate, and sodium linoleate, and to a less extent by sodium malate and caffeine.

3. Both growth and cell-division are inhibited by stronger solutions of the above compounds, and by all solutions of allantoin, guanine hydrochloride, xanthine, hypoxanthine hydrochloride, and sodium nucleate.

This work was undertaken at the suggestion of Professor Benjamin Moore, to whom, as well as to Dr. C. J. Macalister, I am greatly indebted for advice and assistance on many points in connection with it.

ON GLYCOLYSIS IN BLOOD

By G. SPENCER MELVIN, M.D., *Senior Assistant in Physiology.*

From the Physiological Department, University of Aberdeen

(Received July 26th, 1912)

Despite the work which has been done on glycolysis in blood, there still exists a great deal of confusion on the subject. It would seem to be accepted at the present day, however, that after removal of blood from the body its sugar undergoes destruction, or, at all events, tends to disappear.

In 1855, Pavy¹ stated that from blood removed from the body sugar disappeared during the process of clotting. This disappearance he considered to be the result of ordinary decomposition.² Schenck,³ experimenting with blood to which known quantities of sugar had been added, was unable completely to recover the total amount known to be present. The deficiency he attributed to a combination formed between the sugar and the blood protein. Doubts were cast by Rohmann,⁴ Salkowski,⁵ and Seegen⁶ on the accuracy of these assertions, and eventually Schenck⁷ admitted that his previous results had been based on unreliable methods. Pavy² had determined that the passage through the blood of such gases as oxygen, carbon dioxide, hydrogen, had no specific effect quantitatively on the loss of sugar. Seegen,⁸ however, found that the loss was markedly increased by the passage of air through blood kept at a temperature of 39° C. He ascribed this loss to ferment activity, but was unable to detect any products of such action. Lépine⁹ and his collaborators endeavoured to establish that the deficiency or absence of a glycolytic enzyme was responsible for the development of diabetes following ablation of the pancreas. These workers considered¹⁰ that the ferment was found mostly in relation to the corpuscles, and that it was removed by defibrination.¹¹ In support of this, Sieber¹² and von Schroeders¹³ were able to extract a glycolytic agent from fibrin. Lépine¹⁴ noted in favour of ferment action, that the destruction of sugar in blood was more marked the higher the temperature at which the blood was kept, up to a point (54° C.), at which the loss ceased. Similar results were obtained by Arthus¹⁵ who, however, considered that the ferment was formed post-mortem, and that it was closely associated with thrombin. These latter views were held also by Colenbrander¹⁶ and Rywosch.¹⁷

Arthus held that the glycolytic enzyme was derived from the leucocytes and platelets. Lépine,¹⁸ on the other hand, claimed to have established that the precursor of the ferment was a sugar-producing enzyme, which could be activated artificially by treatment with acid. This extraordinary suggestion was disproved by the work of Paderi,¹⁹ and Nasse and Framm.²⁰ As to the products of this ferment action, different results have been obtained—by Kraus²¹ who found carbon dioxide; by Slosse²² who found lactic and formic acids; and by Seegen⁸ who found neither carbon dioxide nor lactic acid. According to Edelmann,²³ glycolysis in blood kept at 37° C. is slight during the first two hours, but well marked after six hours. It is during the first two hours, however, that glycolysis due to enzyme action would be most marked; and, moreover, it is very probable that blood kept at 37° C. would be no longer sterile at the end of six hours.

The investigations here published were carried out to determine (1) if blood, kept at various temperatures after removal from the body, suffers any loss of its sugar; (2) if there is any destruction of sugar added to the blood immediately after withdrawal from the body; (3) if any glycolytic agent is removed from blood along with the protein or the fibrin.

Throughout the research aseptic precautions were rigidly observed. The blood utilised was derived mostly from the sheep and ox, and in certain cases from the horse and cat.

(1.) As a rule, the blood was defibrinated immediately after its removal from the body, and a definite quantity at once run into excess of alcohol. This portion, along with the remainder of the blood, was forthwith conveyed to the laboratory, some ten minutes' walking distance away. The examination of the first portion was immediately proceeded with, while the rest of the blood was kept under various conditions to be examined subsequently.

For the isolation of the sugar the method adopted was substantially that employed by Bang, Lyttkens and Sandgren.²⁴ The protein precipitated by the alcohol was filtered off, repeatedly washed with hot alcohol, and re-filtered. The filtrate and filtered washings were then aggregated and evaporated to dryness. The resultant residue was extracted with boiling water, precipitated by liq. ferri dialysat. (B.P., 1885) and sodium chloride (saturated solution), and filtered. This filtrate, made up to a definite point with distilled water, was then utilised for the estimation of the sugar. For this, one of three methods was employed—(1) Bang's, (2) Bertrand's, (3) gravimetric. In certain experiments the results appear

to show that there is a slight increase in the amount of sugar when the blood is retained outside the body. In these, Bang's method was employed, and it was noticed that the end point was not definitely precise; so that slight variations in the amount of hydroxylamine solution required, representing appreciable differences in the quantities of sugar therefrom calculated, were obtained even in the same sample. These differences are naturally magnified when the calculation is carried to parts per hundred. The blood which had been retained, and from which the later estimations were to be made, was kept at 37° C., at 15° to 16° C., or at 0° C. In this series of experiments, also, the effect of passing certain gases through the blood was investigated.

No. 1.	Blood from sheep.	Kept at 16° C.	Estimated by Bang's method.
	Estimated	immediately	... 0.04875 gram sugar per 100 c.c.
	"	2 hours later	... 0.05
	"	5½ hours later	... 0.04875
No. 2.	Ox blood.	Kept at 15° C.	Estimated by Bang's method.
	Estimated	immediately	... 0.042 gram sugar per 100 c.c.
	"	4½ hours later	... 0.047
	"	8½ hours later	... 0.048
No. 3.	Blood from ox.	Kept at 15° C.	Estimated by Bang's method.
	Estimated	immediately	... 0.048 gram sugar per 100 c.c.
	"	½ hour later	... 0.048
	"	1½ hours later	... 0.05
No. 4.	Ox blood.	Kept at 37° C.	Estimated by Bertrand's method.
	Estimated	immediately	... 0.031 gram sugar per 100 c.c.
	"	½ hour later	... 0.031
	"	2 hours later	... 0.031
No. 5.	Blood from ox.	Kept at 37° C.	Estimated by Bang's method.
	Estimated	immediately	... 0.053 gram sugar per 100 c.c.
	"	½ hour later	... 0.052
No. 6.	Blood from ox.	Kept at 37° C.	Estimated by Bang's method.
	Estimated	immediately	... 0.031 gram sugar per 100 c.c.
	"	1 hour later	... 0.033
	"	3 hours later	... 0.033
No. 7.	Blood from sheep.	Kept on ice in ice chest at 0° C.	Bertrand's method.
	Estimated	immediately	... 0.023 gram sugar per 100 c.c.
	"	½ hour later	... 0.023
	"	3 hours later	... 0.023
	"	5½ hours later	... 0.023
No. 8.	Blood from sheep.	Kept at 0° C.	Bertrand's method.
	Estimated	immediately	... 0.028 gram sugar per 100 c.c.
	"	½ hour later	... 0.028
	"	3 hours later	... 0.028
	"	4 hours later	... 0.028

According to the foregoing results, there is no loss of sugar in blood kept at various temperatures for periods ranging up to 8½ hours.

In the following set of experiments the blood was defibrinated and a quantity of pure dextrose in solution added. The mixture was then thoroughly shaken, and 25 c.c. of it removed for immediate analysis. Through the remainder of the sample was passed a stream of air or of carbon dioxide, the mixture being kept meanwhile at 37° C. or at 16° C.

No. 9.	Sheep blood.	Kept at 16° C.	Stream of purified CO ₂ passed through.	Bertrand's method.
	Estimated	immediately	...	0.04 gram dextrose per 25 c.c.
	"	½ hour later	...	0.04
No. 10.	Sheep blood.	Kept at 37° C.	CO ₂ passed through.	Gravimetric method.
	Estimated	immediately	...	0.029 gram dextrose per 25 c.c.
	"	1 hour later	...	0.026
	"	2 hours later	...	0.029
No. 11.	As in No. 10.			
	Estimated	immediately	...	0.022 gram dextrose per 25 c.c.
	"	1 hour later	...	0.025
	"	2 hours later	...	0.022
No. 12.	Sheep blood.	Kept at 16° C.	Current of air aspirated.	Bertrand's method.
	Estimated	immediately	...	0.016 gram dextrose per 25 c.c.
	"	½ hour later	...	0.016
	"	2 hours later	...	0.016
No. 13.	Sheep blood.	Kept at 37° C.	Current of air aspirated.	Gravimetric method.
	Estimated	immediately	...	0.025 gram dextrose per 25 c.c.
	"	1 hour later	...	0.021
	"	2 hours later	...	0.026

The foregoing experiments are selected as representative of the results obtained. It would thus appear that the sugar is in no way altered quantitatively by the passage of a gas through the blood.

(2.) In this set of experiments a solution of pure dextrose was added to the blood immediately after defibrination, and 25 c.c. of the mixture examined at once, the remainder, as usual, being retained. All the portions examined were thus drawn from the same stock, so that any deficiency of sugar in the later specimens could be established independently of the absolute amount of dextrose known to be present. A depreciation of the sugar content thus obtained must be due to the destruction of the sugar since the experimental procedure was the same in all cases.

No. 14.	Sheep blood.	Kept at 16° C.	Bang's method.	
	Estimated	immediately	...	0.226 gram sugar per 25 c.c.
	"	2 hours later	...	0.221
No. 15.	Sheep blood.	Kept at 16° C.	Bang's method.	
	Estimated	immediately	...	0.157 gram sugar per 25 c.c.
	"	2 hours later	...	0.156
No. 16.	Sheep blood.	Kept at 16° C.	Bang's method.	
	Estimated	immediately	...	0.04 gram sugar per 25 c.c.
	"	2 hours later	...	0.036
	"	3 hours later	...	0.038

No. 17.	Ox blood.	Kept at 16° C.	Gravimetric method.
	Estimated	immediately	... 0.038 gram sugar per 25 c.c.
	„	3 hours later	... 0.036
No. 18.	Sheep blood.	Kept at 15° C.	Gravimetric method.
	Estimated	immediately	... 0.0355 gram sugar per 25 c.c.
	„	2 hours later	... 0.0355
	„	3 hours later	... 0.0351
No. 19.	Ox blood.	Kept at 37° C.	Bertrand's method.
	Estimated	immediately	... 0.089 gram sugar per 25 c.c.
	„	3 hours later	... 0.088
No. 20.	Sheep blood.	Kept at 37° C.	Bertrand's method.
	Estimated	immediately	... 0.02 gram sugar per 25 c.c.
	„	2¼ hours later	... 0.0195
No. 21.	Ox blood.	Kept at 37° C.	Bertrand's method.
	Estimated	immediately	... 0.136 gram sugar per 25 c.c.
	„	½ hour later	... 0.137
	„	2½ hours later	... 0.137
No. 22.	Ox blood.	Kept at 37° C.	Bertrand's method.
	Estimated	immediately	... 0.036 gram sugar per 25 c.c.
	„	½ hour later	... 0.032

It is evident that the mixture of blood and dextrose solution has suffered no loss of sugar on keeping.

(3.) To determine the possibility of a glycolytic agent removed with the fibrin.

For this purpose experiments were carried out as follows:—fresh fibrin was broken up and thoroughly extracted on a mechanical shaker for three hours with 0.75 per cent. solution of sodium chloride. The fibrin was then removed and to the extract was added a quantity of pure dextrose in solution. The mixture was next made up to 100 c.c., and of this, 25 c.c. were immediately estimated. The remaining 75 c.c. were placed in an incubator at 37° C. for three hours, at the end of which time 25 c.c. were estimated. In all estimations, the gravimetric method was employed.

				Dextrose gram per 25 c.c.	
				Estimated immediately	After 3 hours at 37° C.
No. 23	0.09	0.088
No. 24	0.059	0.058
No. 25	0.03	0.029
No. 26	0.036	0.036

In Experiment No. 27 a different procedure was adopted. Fresh fibrin was placed in alcohol, and retained there for three weeks. It was then removed, and washed for twenty-four hours with boiled distilled water in a sterile jar. These washings were rejected, and to the fibrin was added boiled distilled water. This extraction was allowed to proceed for four days. At the end of that time the extracting water was removed

and replaced by another quantity of distilled water, which was allowed to extract for twenty-four hours (i.e., a fifth day). To both these extracts 10 c.c. of a 1 per cent. dextrose solution were added and the volumes of the mixtures made up to a certain point. They were then kept at 37° C. for three and a half hours in the first case, and for four and a half hours in the second. The quantity of dextrose was then estimated in each portion.

Amount added	0.1 gram dextrose
Portion A = 4 days' extract of fibrin + dextrose.	
Estimated after 3½ hours at 37° C. ...	0.096 ..
Portion B = 5th day's extract of fibrin + dextrose.	
Estimated after 4½ hours at 37° C. ...	0.099 ..

No. 28. Conducted on lines similar to those of No. 27.

Amount added	0.1 gram dextrose
2 days' extract of fibrin + dextrose.	
Estimated after 4 hours at 37° C. ...	0.096 ..

It thus appears that no ferment or glycolytic agent can be extracted from fibrin by such washing.

Two experiments are selected to show the results obtained by testing the glycolytic power of extracts of the protein precipitated from blood by alcohol. The blood was run directly into alcohol and retained there for a time sufficient to effect coagulation of the protein. The coagulum was filtered off, dried at a low temperature (37° C.), and then extracted with distilled water for several hours. The extract was then filtered and to the filtrate was added a definite amount of dextrose in solution. The volume of the mixture was then ascertained, and aliquot portions of it were analysed (1) immediately, (2) after being kept at 37° C. for three hours.

No. 29. Amount actually present	0.105 gram dextrose
„ after 3 hours at 37° C.	0.105 ..
No. 30. Amount actually present	0.047 gram dextrose
„ after 3 hours at 37° C.	0.047 ..

The above method of experimentation postulates that any enzyme will conform to the accepted characters of enzymes, to the extent that alcohol will determine precipitation. The same method is applied in the preparation of thrombin which, presumably, has a disposition similar to that of a possible glycolytic ferment. In none of the experiments done in this line of investigation could there be found any evidence of the working of a glycolytic agency.

From the foregoing results the following conclusions are warranted.

(1.) Blood kept outside the body, at ordinary or body temperature, suffers no loss of its sugar—proper precautions as regards asepsis being taken. It is to be noted that the first estimation has been made on blood in a condition as nearly that of the blood within the body, as is possible.

(2.) If dextrose be added to blood as soon as possible after its removal from the body, and the sugar in the mixture be estimated immediately, and at intervals later, no loss of sugar can be made out.

(3.) Extracts of fibrin possess no glycolytic power even after prolonged extraction.

(4.) Blood protein when coagulated by alcohol yields no glycolytic agent on extraction.

(5.) No evidence has been obtained that the sugar is altered by the passage of a gas through the blood.

REFERENCES

1. Pavy, *Proc. Roy. Soc.*, VII, p. 371.
2. Pavy, *Proc. Roy. Soc.*, XXVIII, p. 520.
3. Schenck, *Pflüg. Archiv*, XLVI, p. 607.
4. Rohmann, *Centralb. f. Physiol.*, IV, p. 12.
5. Salkowski, *Centralb. f. d. med. Wissensch.*, No. 17, 1890.
6. Seegen, *Centralb. f. Physiol.*, IV, p. 217.
7. Schenck, *Pflüg. Archiv*, XLVII, p. 621.
8. Seegen, *Centralb. f. Physiol.*, V, p. 821.
9. Lépine, *Compt. Rend.*, CX, p. 742.
10. Lépine, *Compt. Rend.*, CXII, p. 411.
11. Lépine, *Compt. Rend.*, CXII, p. 1181.
12. Sieber, *Zeitschr. f. physiol. Chem.*, XXXIX, p. 434; and XLIV, p. 560.
13. von Schroeders, *Inaug. dissert.*, Berlin, May, 1904.
14. Lépine, *Compt. Rend.*, CXII, p. 146.
15. Arthus, *Archiv. de Physiol.*, III, p. 425, and IV, p. 337; also *Compt. Rend.*, CXIV, p. 605.
16. Colenbrander, *Maly's Jahres-Bericht*, p. 137, 1892.
17. Rywosch, *Centralb. f. Physiol.*, XI, p. 495.
18. Lépine, *Compt. Rend.*, CXX, p. 139.
19. Paderi, *Maly's Jahres-Bericht*, p. 211, 1896.
20. Nasse and Framm, *Archiv. f. Physiol.*, LXIII, p. 203.
21. Kraus, *Zeitschr. f. klin. Med.*, XXI, p. 315.
22. Slosse, *Archiv. Internat. de Physiol.*, XI, p. 154.
23. Edelmann, *Biochemische Zeits.*, XL, p. 314, April, 1912.
24. Bang, &c., *Zeitschr. f. physiol. Chem.*, LXV, p. 497.

THE REDUCTION OF FERRIC CHLORIDE BY SURVIVING ORGANS

BY DAVID FRASER HARRIS, M.D., D.Sc., *Professor of Physiology*, AND HENRY JERMAIN MAUDE CREIGHTON, M.A., M.Sc., D.Sc., *Lecturer on Physical Chemistry in Dalhousie University, Halifax, Nova Scotia.*

(Received August 28th, 1912)

INTRODUCTION

In 1906 one of us showed¹ that on perfusing the surviving kidney with the gelatine and Prussian blue injection-mass, it was possible to obtain artificial urine in which the pigment was completely reduced to the leuco condition.

We were anxious to repeat this method with the kidney, and to employ it in the case of the liver in order to obtain, if possible, artificial bile, in which some reduced material might similarly be expected. In the first series of experiments we used the surviving liver of the cat just killed by bleeding; and we employed a solution of ferric chloride for two reasons:— (1) Its viscosity is so much less than the gelatine mixture; and (2) Because we had previously shown² that the reductase contained in the press-juice of liver reduced ferric chloride to the ferrous condition.

EXPERIMENTAL

(a) *Cat's Liver*

The technique of one experiment with the liver will suffice to show the method. A fine glass cannula filled with the solution of ferric chloride (0.25 per cent.) was inserted into the portal vein the instant the animal was dead. A similar cannula was tied into the gall-bladder, which contained a little viscous yellow bile. The opened abdomen was kept warm with pieces of cotton wool wrung out of hot water. From a burette, connected with the cannula by a rubber tube, a quantity of ferric chloride solution was allowed to run into the liver, which, in a few minutes, became fairly turgid. Discoloured blood in due time began to flow from the right external jugular vein, and was collected in a small glass flask. After the ferric chloride

1. Harris, D. Fraser, *Bio-Chemical Journal*, I, 355, 1906.

2. Harris, D. F., and Creighton, H. J. M., *Proc. Roy. Soc.*, 1912.

solution had displaced nearly all the blood from the liver, and had remained in contact with the liver tissue for twenty minutes, the liquid was squeezed out of the gall-bladder into the cannula which was removed from the organ, and the entire liver was rapidly excised while still warm. The liver was then cut to pieces in a glass funnel, through which a sanguineous, turbid fluid dripped. While the animal was being bled to death, some of its blood was collected and defibrinated, to be used in the control observations, as detailed below.

The following liquids were examined:—

(1) Drippings from the cut liver (coloured red by blood), amounting, with washings, to 18 c.c.

(2) 2 c.c. of bile from the gall-bladder.

(3) 20 c.c. of blood (considerably diluted with iron solution) from the jugular vein.

Liver Drippings.—Before testing for iron, it was necessary to remove the haemoglobin from the solution, so as to get rid of the red colour. It was not practicable to precipitate the haemoglobin by heating, owing to the fact that, at the temperature of precipitation, ferric chloride is readily reduced by blood to the ferrous condition. In consequence of this, the haemoglobin was precipitated at room-temperature with dilute hydrochloric acid, which also served the purpose of breaking up any iron-protein complexes that might be present.¹ It was found when hydrochloric acid was slowly added to a solution containing blood, that, at first, the dark brown, soluble acid-haematin was formed, and that further addition of acid was necessary to precipitate the haemoglobin and blood-proteins.

To the 18 c.c. of liver drippings, 2 c.c. of dilute hydrochloric acid were added, and the precipitated haemoglobin and blood-proteins separated by filtration. The colourless filtrate was divided into several parts and tested for ferrous and ferric iron. *With potassium ferricyanide the colourless filtrate instantaneously turned to a deep green-blue colour and, after a few minutes, a blue precipitate was noticeable.* On the other hand, potassium ferrocyanide gave only a very faint blue coloration on being added to the filtrate.

As a control, the following experiment was carried out. To 10 c.c. of the defibrinated cat's blood, 1 c.c. of 0.25 per cent. ferric chloride solution was added. The mixture was then placed in a thermostat and kept at 38° for twenty minutes, after which the haemoglobin was precipitated with dilute hydrochloric acid, and removed by filtration. The colourless filtrate gave a deep blue

1. Creighton, H. J. M., *Trans. N. S. Inst. Sci.*, XIII, 61-75, 1912.

precipitate with potassium ferrocyanide, but with potassium ferricyanide the colour was yellow, *without the slightest trace of blue or green*. At the end of three-quarters of an hour the colour was still unchanged, but at the end of one and a half hours it had become slightly green, while after three hours the mixture was distinctly green and a slight precipitate had formed. This control experiment was repeated with the same results.

No ferrous iron was found to be present in the ferric chloride used in these experiments.

Bile.—The 2 c.c of bright yellow, viscous bile, to which a few drops of hydrochloric acid had been added, were diluted to 5 c.c with distilled water, and the solution divided into two parts. These were tested with potassium ferrocyanide and potassium ferricyanide; iron in both the ferric and the *ferrous* condition was found to be present.

Blood from Jugular Vein.—The haemoglobin was precipitated with dilute hydrochloric acid, and, after separation by filtration, potassium ferrocyanide and potassium ferricyanide were added to different portions of the clear filtrate. Both ferric and *ferrous* iron were found present.

(b) *Lamb's Kidney*

The technique for the kidney was briefly as follows:—The kidney was taken from a lamb just killed by bleeding was brought at once from the slaughter-house to the laboratory in the water-jacket of a calorimeter, which was filled with water at 42°. Within three-quarters of an hour of death, we fixed cannulae in the renal artery, the renal vein and the ureter. We perfused ferric chloride solution (0.25 per cent.) with a considerable head of pressure, and obtained a little sanguineous liquid from the renal vein and a large amount of a perfectly clear, pale yellow liquid from the ureter.

The following liquids were examined:—

- (1) Blood from the Renal Vein.
- (2) Artificial Urine from the Ureter.

Blood from Renal Vein.—The blood collected, which amounted to about 5-6 c.c., was treated with dilute hydrochloric acid, and the precipitated haemoglobin and blood-proteins filtered off. Portions of the clear filtrate were then tested with potassium ferrocyanide and potassium ferricyanide. The former reagent gave a deep blue precipitate, and the latter a pale green coloration, thus showing that some of the ferric chloride had undergone reduction.

Artificial Urine.—The artificial urine, which was somewhat lighter in colour than the ferric chloride solution used for perfusing the kidney, was acidified with hydrochloric acid and divided into two parts. On adding potassium ferrocyanide to one part, a deep blue coloration was obtained; while the other part gave, with potassium ferricyanide, a light green coloration, perceptibly deeper than in the case of the venous blood.

CONCLUSIONS

1. The foregoing experiments prove that ferric chloride is reduced to the ferrous condition, both by the surviving liver and the surviving kidney. In the light of our previous work¹ on the reductase of the press-juice of these organs, we believe that reductase is active in these intact surviving organs.

2. The fluid which runs through the blood-vessels of the organs is less reduced than that which is excreted into the gall-bladder and ureter, respectively. This is precisely what, *a priori*, we would expect, since the liquid flowing from the emergent vein has not come into contact with the living cells of the parenchyma, whereas the fluid found in the gall-bladder and the ureter has passed through the living cells of the hepatic tissue and renal tissue, respectively. This latter fluid has had greater opportunities of being brought within the sphere of action of the reductase.

3. The degree of reduction by the living cells is more perfect in the liver (of cat) than in the kidney (of lamb). This may be partly explained by an absolute difference in the intensities of the reduction in these two classes of organs; partly, possibly, by the fact that the liver was that of a carnivore, the kidney that of a herbivore; and partly by the fact, in the case of the artificial urine, that the perfusing liquid passed into the ureter very quickly, in consequence of which it was only for a very short time within the sphere of action of the reductase. From our previous work on the reductase of liver and kidney,¹ we are inclined to think that the supposition as regards the difference in reduction intensity is, in itself, correct.

4. The reductions studied are quite distinct from reductions in the presence of non-living organic matter.

1. *Loc. cit.*

THE ACTION OF THE OPIUM ALKALOIDS

By F. W. WATKYN-THOMAS, B.A., *Trinity College.*

From the Pharmacological Laboratory, Cambridge

(Received September 9th, 1912)

PREVIOUS WORK

Although very complete accounts of the action of morphine have been given by many observers, such as Bernard and Guinard, it is only recently that the action of morphine has been compared with that of the total alkaloids of opium. The action of individual alkaloids, especially narcotine and codeine, has been studied, but the unsuitability of opium for intravenous injection has prevented accurate work on the action of the total alkaloidal content.

In 1909, Sahli¹ prepared a substance which he called 'Pantopon,' and which contained all the alkaloids of opium in a definite concentration and in soluble form. Since then a great deal of work has been done on the action of this preparation. Loewy² has correlated the action of morphine, codeine, and the total alkaloids on the respiratory centre. Wertheimer and Raffalovitch⁹ have investigated the action of the total alkaloids on the circulatory system, Rodari,³ Bergien,⁴ and Dobeli,⁵ have compared the toxicity of morphine and the total alkaloids. An account of its action is also given by Rodolico,⁶ and Cohnheim has investigated the action on the gut. The analgesic and anaesthetic actions of the total alkaloids have been fully described by Grey⁷ and Trotain,⁸ among others.

EXPERIMENTAL METHODS

1. *Animals.* In most cases rabbits were used, as, according to Guinard, in behaviour under morphine they resemble man more closely than do any other animals except the dog. As controls, and in certain experiments for which rabbits were unsuitable, cats were used (Experiments X, XII, XIX). A few experiments were performed on frogs. (Experiments XVIII, XXIII, XXVII). A certain number of experiments were performed on pithed animals (Experiments II, IV, V, VI, XIX, XXI).

A.C.E. alone was used in one experiment (XII), A.C.E. and ether in one. In all other experiments the anaesthetic was a 25 per cent. solution of urethane in Ringer, 6 c.c. (1.5 grams) per kilo body weight administered at body temperature. Half the dose was injected under the skin, anaesthesia was induced by ether, and the other half was injected into the peritoneal cavity.

The ether anaesthesia was usually maintained during the preparatory operation, but no other drug was administered until the animal was under the full influence of urethane. It was thus possible to commence all experiments under an approximately standard depth of anaesthesia, as indicated by dosage, blood pressure, size of pupil, and absence of conjunctival reflex.

Tracheotomy was performed, and cannulae tied in the external jugular vein on one side and the common carotid of the other side. Any special operations afterwards performed are described in the account of the experiment. In all experiments injections were given by the cannula in the external jugular; blood pressures were always taken in the common carotid.

Drugs. Tincture of opium is not suitable for experimental work, as the alkaloid content is variable and the contained alcohol is a possible source of error.⁵

Throughout these experiments a 2 per cent. solution of Sahli's 'Omnopon'*—in which all the alkaloids freed from meconic acids, gums and resins are present as hydrochlorides—was used.

The composition of this preparation is as follows:—Morphine 52 per cent., narcotine 20 per cent., codeïne 2 per cent., papaverine 2.5 per cent., thebaine 1 per cent., narceine 1.2 per cent., other alkaloids 4 per cent., water 8 per cent., hydrochloric acid 9 per cent.

Standard solutions of morphine hydrochloride, narcotine hydrochloride, and codeïne hydrochloride were used. They were prepared on the following basis:—

1 c.c. 2 per cent. omnopon contains 0.0166 gram total alkaloid, 0.0104 gram morphine, 0.0040 gram narcotine, 0.0004 gram codeïne.

1 c.c. standard morphine solution contained 0.0104 gram morphine.

1 c.c. standard narcotine solution contained 0.0040 gram narcotine.

1 c.c. standard codeïne solution contained 0.0004 gram codeïne.

Circulatory effects. The effect of the opium alkaloids on the

* 'Pantopon' is known in this country as 'Omnopon.' I am indebted to Messrs. Hoffman, La Roche, the manufacturers, for a supply of the substance.

circulation is insignificant. Nevertheless, as there are some pronounced differences between the different bodies, it will be advisable to consider them in detail.

Action on vessels. Perfusion experiments were carried out on the frog, Ringer's solution being injected through the peripheral end of the aorta, and the outflow from the great veins estimated. These experiments showed that morphine in doses of 2-4 mgm., thrown suddenly into the circulation—a procedure which gives every advantage to the vessels to show alterations in their calibre—produced practically no effect. If the vessels had been previously acted on by some peripheral vaso constrictor a certain degree of vaso-dilatation was produced. Thus the constriction caused by narcotine could be entirely antagonised by a suitable dose of morphine.

Protocol of typical experiment:—

Experiment XXII.—Frog B. Average time for outflow of 2 c.c. = 2 mins. 30 secs.

4 mg. Morphine perfused.

2 c.c. outflow in 2 mins. 25 secs.

2 c.c. outflow in 2 mins. 30 secs.

2 c.c. outflow in 2 mins. 35 secs.

Experiment XXVII.—Frog A. Average time for outflow of 2 c.c. = 59 secs.

0.4 mg. Narcotine perfused.

2 c.c. outflow in 2 mins. 1 sec.

2 c.c. outflow in 4 mins. 2 secs.

4 mg. Morphine perfused.

2 c.c. outflow in 1 min. 12 secs.

2 c.c. outflow in 1 min. 30 secs.

2 c.c. outflow in 1 min. 29 secs.

Narcotine in such small doses as 0.4 mgm. is shown by this last experiment to produce considerable constriction. This constriction lasts some minutes, and is followed by a very gradual relaxation.

The percentage of morphine in omnopon is, roughly, about the optimum antagonising dose which will annul the constricting action of the contained narcotine. One would anticipate from these experiments that the effect of omnopon on the vessels should not be very pronounced. This was found to be the case: omnopon producing little effect in either direction.

Protocol of typical experiment:—

Experiment XXII.—Frog A. Average time for outflow of 4 c.c. = 1 min. 5 secs.

7 mg. Omnopon perfused.

4 c.c. outflow in 1 min. 9 secs.

4 c.c. outflow in 1 min. 6 secs.

4 c.c. outflow in 1 min. 5 secs.

Action on the heart. None of these alkaloids produce any decided action on the heart in the intact animal in dosage which may be regarded as therapeutically possible. In the isolated mammalian heart, where concentrated solutions can be suddenly thrown into the coronary circulation, it is possible to make comparative experiments on their toxicity. By this means it was shown that 2 mgm. morphine produced little or no effect, whilst 5 mgm. caused decided slowing and diminished systole lasting for many minutes, in spite of the fact that the morphine passed straight through in less than one minute and was then replaced by normal Ringer's fluid.

Narcotine in doses up to 1 mgm. left the heart entirely uninfluenced.

Omnopon in doses up to 2 mgm. causes some increase in the systole, but beyond this dose the systole weakens, and if a dose of 4 mgm. is injected into the coronary circulation weakening of systole and slowing of rate are always pronounced, while the beat may be inhibited for thirty to sixty seconds.

Measurements of the output of the mammalian heart in the intact and anaesthetised animal show that none of these alkaloids, under such conditions, exert any appreciable action on the heart, even in poisonous doses.

It is true that a dose, sufficient to cause a fall of pressure by vasodilatation, causes an increased output from the heart, but this is not the direct effect of the alkaloids but is associated with the vaso-motor fall, and may be produced equally well by suitable doses of some of the nitrites.

Protocol of experiment:—

Experiment X.—Cat 2 kilos. Ether and urethane. Tracheotomy. Cannulae in external jugular and common carotid. Artificial respiration, thorax opened and heart in cardiometer.

1 c.c. Morphine	Slight fall of blood pressure. Some variation in beat of heart.
1 c.c. Omnopon	Fall of pressure. No effect on heart.
3 c.c. Narcotine	Fall and rise to previous pressure. No effect on heart.
3 c.c. Narcotine	Fall of pressure. No effect on heart.
3 c.c. Narcotine	Fall of pressure. Weakening of heart.
4 c.c. 0.25 % Nicotine	No rise of pressure. Heart growing rapidly weaker.

Death.

In none of my experiments has the slightest evidence been afforded that any of these opium alkaloids, or all of them administered together as omnopon, exert any direct action on the heart.

Blood pressure. The action of morphine on the blood pressure is insignificant. Many writers claim that it induces a rise of pressure, and it is true that small doses, injected directly into the circulation, may cause an increase in pressure of a few millimetres of mercury. But I have never obtained the smallest rise by subcutaneous injection. Larger doses, such as 5 mgm. per kilo body weight, in rabbits undoubtedly produce a small degree of vaso-dilatation and some corresponding fall in blood pressure, but it is only by the administration of enormous doses, 10 mgm. per kilo, that a fall of pressure of any moment can be produced. It is hardly necessary to point out that in all experiments in which such bodies as these are injected efficient respiration is an essential for accurate estimation of the effect produced.

Codeine has more action on blood pressure than morphine, but its effect is still insignificant. It raises the height of the blood pressure curve a shade more than morphine, and it is much easier with this alkaloid to produce a marked fall in pressure associated with vaso-dilatation. Codeine stands midway in its action between morphine and narcotine.

Narcotine, in small doses, causes a distinct rise in arterial blood pressure, but when the dosage is increased fall of pressure rapidly ensues. The rise in pressure is associated with vaso-constriction, and it is easy to show that the vessels of the gut constrict more or less in proportion to the rise of pressure. In the same way the subsequent fall in pressure is associated with splanchnic vaso-dilatation. Now, as narcotine is representative of a number of other alkaloids present in opium which in large doses produce fall of pressure and in small doses initial constriction, it will be well to examine the mechanism by which this type of effect is produced.

A large dose of narcotine injected into the circulation immediately produces a maximal fall in blood pressure. Further injections produce no further fall, although it may readily be shown that the blood pressure is capable of a further fall by the administration of a little nitrite. If, after the pressure has undergone this maximal fall, which may occur in a rabbit after the injection of 15 mgm. per kilo body weight, the splanchnic nerve be excited by a faradic current, no response—vaso-constriction and rise of blood pressure—occurs. Nevertheless, such response may be obtained by applying the electrodes to the post-ganglionic fibres. The splanchnic nerve is paralysed and the block occurs in the ganglion cells. This, then, is the explanation of the fall of blood pressure caused by these alkaloids. The sympathetic ganglion cells in the

neck may be paralysed in a similar manner. Using dilatation of the pupil as a test of sympathetic activity, it was found that narcotine paralysed this nerve and that the block occurred in the ganglion cells, the pupil reacting normally to stimulation of the post-ganglionic fibres.

Protocol of experiment:—

Experiment XIII.—Rabbit 1·7 kilos. Ether and urethane. Tracheotomy. Cervical sympathetic exposed. Electrodes between mid- and superior ganglia.

- | | | | | | | | |
|-----|--------------------------|-----|-----|-----|-----|-----|--------------------------|
| 1. | Stimulate. Coil at 20 | ... | ... | ... | ... | ... | Pupil widely dilated. |
| 2. | 1 c.c. Narcotine. | | | | | | |
| 3. | Stimulate | ... | ... | ... | ... | ... | Pupil widely dilated. |
| 4. | 1 c.c. Narcotine. | | | | | | |
| 5. | Stimulate. Coil at 20 | ... | ... | ... | ... | ... | Pupil widely dilated. |
| 6. | 2 c.c. Narcotine. | | | | | | |
| 7. | Stimulate. Coil at 20 | ... | ... | ... | ... | ... | Pupil dilated, but less. |
| 8. | 3 c.c. Narcotine. | | | | | | |
| 9. | Stimulate. Coil at 20 | ... | ... | ... | ... | ... | Pupil unchanged. |
| 10. | Stimulate above Ganglion | ... | ... | ... | ... | ... | Pupil dilated. |

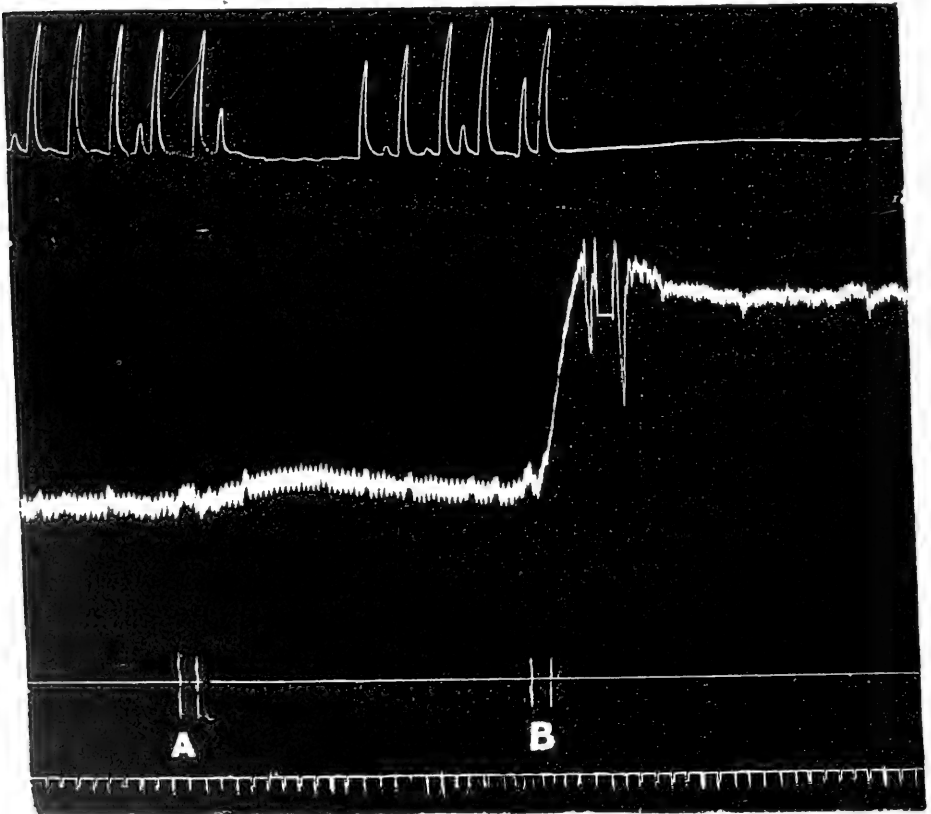

FIG. I.—Cat, urethane. Intestinal movements recorded by balloon. Blood pressure below.
At A—1 c.c. 0·5 % Nicotine injected.
At B—2 c.c. 0·1 % Adrenalin.

In other words, narcotine and its allies should produce their rise, and more pronounced fall in blood pressure, in the same manner as nicotine. The first action of nicotine is to stimulate very powerfully the ganglion cells of the sympathetic system, and, if these are paralysed by narcotine, nicotine should produce no action, which was found to be the case; whilst adrenalin, which is known to act on the end organ, produces its action almost uninfluenced. Two or three points in this type of paralysis are worthy of note. The first is that the paralysis may occur even whilst the medulla is still active, as is shown by natural respiration. This is a remarkable fact, and, so far as I am aware, every other paralysis of this nature—such as that caused by nicotine or by apocodeine—is preceded by complete medullary paralysis.

Protocol of experiment:—

Experiment XI—Rabbit 1·9 kilos. Ether and Urethane. Tracheotomy. Cannulae in Ext. Jugular and Common Carotid.

1. 2 c.c. Narcotine.
2. 2 c.c. Narcotine.
3. 1 c.c. Narcotine:
4. 1 c.c. Narcotine.
5. 2 c.c. Adrenalin ... Marked effect.
6. 2 c.c. Nicotine ... No effect. Feeble respiratory movements continuing.

Secondly, the nerve cells on the course of the splanchnic fibres supplying the vessels of the gut are paralysed before those conveying inhibitory fibres to intestine. Thus an injection of nicotine may fail to cause any rise in blood pressure, and yet inhibit peristalsis (*vide* protocol, Expt. XII).

Omnopon certainly raises blood pressure more than either morphine, codeine, or narcotine, in corresponding doses. In the rabbit, doses of over 15 mgm. per kilo body weight cause a marked fall of pressure with all the characteristics of that described for narcotine, and in sufficient doses will, like narcotine, entirely antagonise the pressor action of nicotine. This is in contradiction to the results of Bergien who claims that blood pressure is not materially affected by large doses of omnopon.

The principal fact learnt from these experiments is that the opium alkaloids exert an initial slight stimulant action on the sympathetic cells, this being followed by depression and paralysis. This is very marked in the case of narcotine, much less for codeine, and least of all for morphine.

Comparison of Respiratory Effects. A requirement in medicine is a drug which, while diminishing cerebral reflexes like morphine, will do

so without marked depression of respiration. This is especially desirable in the treatment of useless cough. Morphine, unfortunately, profoundly depresses the respiratory centre, no doubt by preventing afferent impulses reaching the medulla.

Codeine, heroine, dionine, and other morphine derivatives have been employed as substitutes, and it is generally admitted that they are less depressant to respiration than morphine, while it is stated that they are efficient in relieving cough.

Loewy², Wertheimer and Raffalovich⁹ and Rodari³ claim that the total alkaloids have considerably less effect on the respiratory centre than has morphine.

Loewy has shown that the reaction of the respiratory centre to carbon dioxide is less affected by the total alkaloids than by morphine.

All these observers used 'omnophon.'

In the ensuing experiments the effect on the respiratory reflexes was tested by stimulation of the cut central end of the great sciatic, or of the external popliteal, with induction shocks and a tetanising current. The respiratory movements were recorded by a lever attached to the severed ensiform cartilage.

Protocols of typical Experiments:—

Experiment XVII.—Rabbit, 1.30 kilos. Ether and urethane. Tracheotomy. Cannulae in left external jugular. Right common carotid. 'Diaphragm slip' method of recording great sciatic on electrodes.

- | | | | | |
|-------|--------------------------|------------|-----|--|
| i. | Stimulate great sciatic. | Coil at 20 | ... | (a) Great rise of blood pressure. Traube-Hering curves. |
| | | | | (b) Respiration greatly increased in force and frequency. |
| ii. | 0.1 c.c. Omnophon | ... | ... | (a) Slight rise of blood pressure. |
| | | | | (b) Respiration deepened, but not appreciably slowed. |
| iii. | 0.2 c.c. Omnophon | ... | ... | (a) Further rise of blood pressure. |
| | | | | (b) Respiration slightly slower. |
| iv. | Stimulate great sciatic. | Coil at 20 | ... | Respiratory reflex very feeble. |
| v. | Stimulate great sciatic. | Coil at 15 | ... | Vomiting movements. Traube-Hering waves. Rise of blood pressure. |
| vi. | 1 c.c. Morphine | ... | ... | Respiration slowed and abolished. Drum stopped for artificial respiration. |
| vii. | Stimulate great sciatic. | Coil at 15 | ... | Vomiting movements followed by increased frequency. |
| viii. | 0.3 c.c. Narcotine | ... | ... | Fall in blood pressure. Return to Normal. Respiration more rapid. |
| ix. | Stimulate great sciatic. | Coil at 15 | ... | Response good. |
| x. | 0.6 c.c. Narcotine | ... | ... | Fall of blood pressure. Arrest of respiration. Death. |

Experiment XVIII—Rabbit, 1.5 kilos. Anaesthetics and operative procedure, as No. XVII.

- i. Stimulate great sciatic. Coil at 35 ... Rise of blood pressure. Respiration deeper and more rapid.
- ii. 0.2 c.c. Omnopon Rise of blood pressure. Respiration unaffected at first, and then more shallow.
- iii. Stimulate great sciatic. Coil at 35 ... No effect on blood pressure or on circulation.
- iv. 0.2 c.c. Omnopon Rise of blood pressure. Respiration unaffected.
- v. Stimulate great sciatic. Coil at 25 ... Slight rise of blood pressure. No respiratory response.
- v. Wash out—wait three minutes.
- vii. 0.2 c.c. Morphine Very slight rise in blood pressure. Respiration unaffected.
- viii. Stimulate great sciatic. Coil at 35 ... Absolutely no response in blood pressure or circulation.
- ix. Stimulate great sciatic. Coil at 25 ... Absolutely no response in blood pressure or circulation.
- x. 0.2 c.c. Narcotine Fall of blood pressure. Rate of respiration increased.
- xi. Stimulate great sciatic. Coil at 25 ... Rise of blood pressure. Respiration unaffected.

It was found that morphine always slows respiration and depresses the reflexes. Narcotine at first renders respiration deeper and slower, and if the drug is pushed the movements become more rapid and more shallow. But the most remarkable effect of narcotine on respiration is its depression of the respiratory reflexes.

It becomes necessary to explain the paradox as to how respiration, which is largely a reflex phenomenon, can be stimulated by narcotine whilst the sensory reflexes are depressed. Taken in conjunction with the work of Loewy this suggests that in the respiratory centre there is a different receptive mechanism inducing respiratory activity for chemical afferent nervous stimuli. One explanation which might be offered to account for the difference in the action of morphine and narcotine would be that, while morphine depresses both mechanisms, narcotine only depresses the one; or it may be that the medulla is rendered hypersensitive to carbon dioxide and other chemical stimuli acting directly on its motor mechanism, whilst afferent stimuli may still be blocked on the sensory side.

Omnopon invariably increased the depth of respiration without materially altering its rate. This effect is not very marked, although quite distinct. Large doses, 15 mg. per kilo body weight in a rabbit,

cause a temporary paralysis of respiration. As compared with morphine, then, omnopon must be regarded as less toxic, and much less depressant to respiration.

Nevertheless, it decidedly depresses the reflex response to nervous stimulation, and, therefore, should be greatly superior to morphine in the treatment of cough.

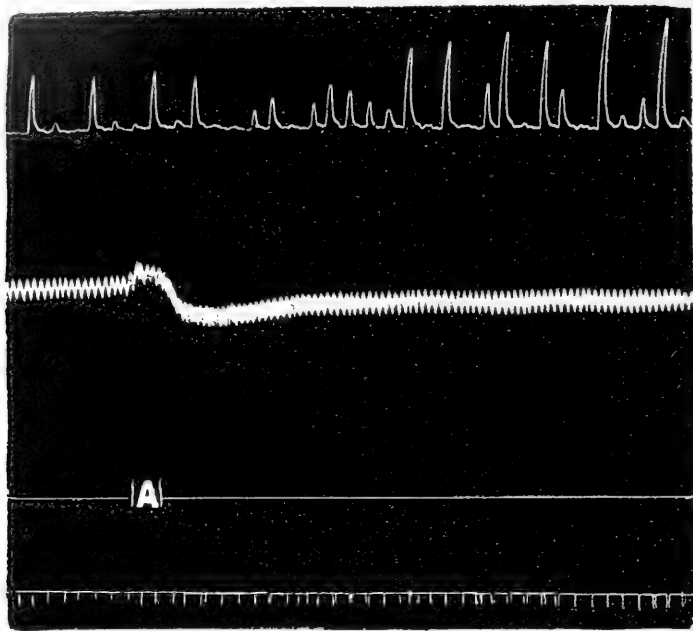

FIG. II.—Cat. Urethane. Intestinal movements and blood pressure. Showing effect of a late injection of 2 c.c. Omnopon at A.

Intestinal Movements. It is well known that morphine, probably during its excretion, influences Auerbach's plexus in such a way as to diminish peristaltic movement. If, however, a large dose of morphine is suddenly thrown into the circulation the first effect is invariably augmented peristalsis, which in the case of man may lead to diarrhoea and vomiting. Narcotine shows this effect in a very much more pronounced way than morphine. This drug exerts no stimulant action on any form of plain muscle or motor nerve ending, but it has a markedly paralyzing action on sympathetic ganglia; hence, it is not unreasonable to suppose that this action is due to depression of the ganglia on the course of the inhibitory nerves to the intestine.

Omnopon, like narcotine, at first increases peristalsis. For the time being, the narcotine overshadows the morphine action. This effect is, of course, followed by diminished peristalsis. But, whether this explanation be correct or not, the important fact remains that omnopon causes at every stage of its action much less effect in diminishing peristalsis than morphine.

Protocol of typical experiment:—

Experiment XII.—Cat, 2.5 kilos. A. C. E. Tracheotomy. Cannulae in left common carotid and right external jugular. Abdomen opened. Incision made in a loop of small intestine, and balloon inserted.

- | | | | | | |
|-----|-------------------------|-----|-----|-----|--|
| (a) | 2 c.c. 'Omnopon' | ... | ... | ... | Great fall in blood pressure. Slight increase in peristalsis. |
| (b) | 3 c.c. 'Omnopon' | ... | ... | ... | Very little effect on gut movements at first, and then increased. |
| | | | | | Artificial respiration.
Wash out.
Wait for respiration to become natural. |
| (c) | 2 c.c. 'Omnopon' | ... | ... | ... | No effect on blood pressure. Gut movements further increased. Respiration natural. |
| (d) | 6 c.c. 0.5 % Narcotine | ... | ... | ... | Great increase in gut movements. Temporary cessation of respiration. |
| | | | | | Artificial respiration.
Respiration natural. |
| (e) | 1 c.c. 0.5 % Nicotine | ... | ... | ... | No effect on blood pressure. Temporary inhibition of gut movements. |
| (f) | 2 c.c. 0.1 % Adrenaline | ... | ... | ... | Great rise in blood pressure. Cessation of peristalsis. |

REFERENCES

1. Sahli, *Therapeut. Monatshefte*, IX, p. 1, 1909; *Munchener Med. Wochen.*, LVII, p. 1326, 1910.
2. Loewy, *Munchener Med. Wochen.*, LVIII, p. 2408, 1910.
3. Rodari, *Therapeut. Monatshefte*, X, p. 540, 1910.
4. Bergien, *Munchener Med. Wochen.*, LVIII, p. 2409, 1910.
5. Dobeli, *Monats. f. Kinderheilkunde*, IX, p. 34, 1910.
6. Rodolico, *Giornale internaz. d. Scienze Mediche.*, Ann. XXXII, 1910.
7. Grey, *Lancet*, p. 673, 1911.
8. Trotain, *L'Etude Therapeutique de l'opium*, Paris, 1911.
9. Wertheimer and Raffalovitch, *Deut. Med. Wochen.*, XXXVII, p. 1710, 1910.

THE DETECTION OF ACETO-ACETIC ACID BY SODIUM NITROPRUSSIDE AND AMMONIA

By VICTOR JOHN HARDING AND ROBERT FULFORD RUTTAN.

(Received September 17th, 1912)

The use of sodium nitroprusside and ammonia followed by addition of an acid insufficient in amount to completely neutralize the ammonia, was first suggested by Le Nobel¹, as a method of detecting small quantities of acetone. The test, of course, is based on the original test of Legal, but as the two tests differ in result, it is proposed to call the former the Le Nobel test and to reserve the term Legal's test exclusively to the action of sodium nitroprusside and potassium (or sodium) hydroxide followed by acidification. The two tests differ in the following points: (a) The Le Nobel test gives with acetone a much bluer shade of purple than the Legal test; (b) The Le Nobel test will detect aceto-acetic acid, as will be shown in this paper.

The two most important variations of the Le Nobel test are those of Jackson-Taylor² and Rothera³. Jackson-Taylor in detecting acetonuria dispenses with any previous acidification, and obtains in presence of acetone a petunia coloured ring. This modification is highly recommended by Saxe⁴ for clinical practice, and is in general use in many hospitals. Rothera recommends the addition of ammonium sulphate to the acetone solution, either in water or in urine, followed by the addition of sodium nitroprusside solution and concentrated aqueous ammonia. Other ammonium salts may be used, and the authors can confirm Rothera's experiments that such a procedure greatly enhances the value and delicacy of the test. Experiments on the Legal test also confirm Rothera's conclusions on the mechanism of the reaction; the condensation of the sodium nitroprusside and acetone by means of alkali giving rise to the production of a compound which acts as an indicator, but which, in the Le Nobel test, is unaffected by a low concentration of OH ions. The authors examined the action of a great number of organic acids in this respect. The method of applying the Le Nobel test was to acidify the acetone solution with the organic acid, add 0.5 c.c.M/10 sodium nitroprusside

(1 c.c. = 0.0298 grs. $\text{Na}_2\text{Fe}(\text{CN})_5\text{NO} \cdot 2 \text{H}_2\text{O}$) and then overlie the solution with concentrated aqueous ammonia. When examining a suspected case of acetonuria, the organic acid invariably used was acetic acid.

When one comes to apply the Le Nobel test to the detection of acetonuria, one meets several anomalies which, so far, do not seem to have been put on record. The difficulties met with may be summarized as follows:—

(1) Solutions of acetone in water and in urine of concentrations similar to those occurring in cases of acetonuria do not give the test as distinctly as the natural cases.

(2) If some samples of urine which give a marked response to the Le Nobel test be distilled with acids, the test given by the distillate, where the acetone is presumably ten to twenty times more concentrated than in the original urine, is usually much less marked. It was a knowledge of these anomalies which attracted the attention of the authors to this subject.

In a paper on the output of acetone under physiological and pathological conditions, Engel⁵ determined the percentages excreted in various diseases and under varied conditions of diet. The acetone was determined by the Messenger-Huppert method, thus the figures given include acetone from aceto-acetic acid as well as free acetone, and are consequently too high. The highest amount of acetone found was 0.076 per cent. The authors, however, have found a much higher percentage of acetone in one case of severe 'diabetes mellitus,' accompanied by 'acidosis.' The percentage of acetone in the twenty-four hour sample, the day preceding death, was 0.134. This was determined by the Messenger-Huppert method. The percentage of free acetone as determined by the Folin method was 0.057. If a solution of 0.134 per cent. acetone be made in water or in urine and the Le Nobel test applied to it, a light purple coloration results at the end of about three minutes, while a solution of 0.057 per cent. acetone will only give a very faint reddish-violet ring at the end of about twenty minutes, a coloration which might easily be overlooked. The 'acidosis' case in question gave a strongly positive Le Nobel test at the end of about a minute. Thus, in this case, the test as given by solutions of acetone in water or in urine of a concentration the same as that occurring in a natural case of acidosis is not as distinct as in the natural urine.

In cases where the Le Nobel test is doubtful, it is always recom-

mended to acidify the urine with either sulphuric or acetic acid and distil, usually taking about 100 c.c. of urine and collecting from 5 to 10 c.c. of distillate, and then to apply the test to the distillate. Such a concentration of acetone would be expected to lead to an intensification of the colour reaction with sodium nitroprusside. In the acidosis case previously mentioned, and also in a second case examined by the authors, such an intensification did not occur. In the first case, the Le Nobel reaction was much weaker in the distillate than in the original urine, while in the second it had disappeared entirely.

It is evident from a consideration of these facts that there must be present in certain cases of acetonuria some constituent or constituents which either of themselves respond to the Le Nobel test or act as intensifiers to the reaction with acetone. Such substances might be ammonium salts, hydroxy butyric acid and aceto-acetic acid. From Rothera's experiments³, it might be expected that the increased excretion of ammonium salts which occurs in acidosis would account for the increased delicacy of the Le Nobel test when applied to a natural sample of acetonuria. That this is not the explanation is easily proved in the following manner. Fifty cubic centimetres of urine, which gave a strong Le Nobel reaction, were acidified with oxalic acid, and gently distilled, the first five cubic centimetres of distillate being collected. The distillate gave a weaker reaction than the original urine, and the residual urine gave a very faint reaction. A second specimen of the urine was then distilled under exactly similar conditions and the distillate added to the residual urine. This mixture gave a very faint Le Nobel reaction, much less intense than the original, thus showing that ammonium salts in the urine were not present in sufficient amount to greatly increase the delicacy of the Le Nobel reaction with acetone, and also that the substance to which the intensifying action was due was destroyed by heat. This was confirmed by boiling a sample of the urine, acidified with oxalic, acetic or sulphuric acid, under a reflux condenser for fifteen minutes, when it was found that an application of the Le Nobel reaction gave a negative result. As the specimen in question contained aceto-acetic acid, the urine at the end of the experiment would contain more acetone than at the beginning, and yet the Le Nobel test failed to show its presence. This pointed to the fact that it was the presence of aceto-acetic acid in the urine which caused the marked Le Nobel reaction. Aceto-acetic acid, however, is stated in the literature to give the following colorations:—

$\text{Na}_2\text{Fe}(\text{CN})_5\text{NO}$	Alkali	=	Reddish-brown, unchanged by organic acids or metaphosphoric acid. ⁶
$\text{Na}_2\text{Fe}(\text{CN})_5\text{NO}$	Ammonia	=	Orange-red.
„	„		Solid ammonium salt.
„	„		Orange-red.
„	KOH	=	Orange-red, unchanged by acidification by phosphoric acid. ⁷

No mention has been found of a violet or purple coloration such as it produced in the application of the Le Nobel reaction to aceto-aceturia. That the violet coloration given by the Le Nobel reaction with aceto-aceturia is due to the aceto-acetic acting independently of the acetone is evident from the following experiment. A natural sample of urine containing aceto-acetic acid was acidified with oxalic acid, saturated with sodium chloride and all the free acetone removed by aspiration by means of a current of air, as in the Folin method of estimating acetone. This was continued for an hour. At the end of that time the free acetone left in the urine was determined by the Folin method and found to be nil. The acetone-free urine, however, still gave a strong Le Nobel reaction, almost undiminished in intensity, which reaction became negative if the acetone-free urine was boiled under a reflux condenser. A solution of aceto-acetic acid was next prepared in the following manner: Thirteen (13) grams of ethyl aceto-acetate were added to a solution of six (6) grams of potassium hydroxide in 240 c.c. of water, the mixture shaken and allowed to remain at room temperature for twenty-four hours. It was then diluted with water to 1,000 c.c., and this solution was used as a solution of aceto-acetic acid. It contains also some unhydrolysed ethyl aceto-acetate and some acetone. If the Le Nobel reaction be applied to this solution, it will be found to give a violet coloration, indistinguishable from that given by urine containing aceto-acetic acid. If the acidification with acetic acid be omitted as in the Jackson-Taylor modification, the coloration appears at the end of a few seconds and is a distinctly redder shade of violet. If the solution is acidified and boiled under a reflux condenser, the test becomes negative; an acetone-free solution, obtained by removing the acetone by a current of air as in the Folin method of estimation of acetone, gives the test with undiminished intensity. Thus there is no doubt in the minds of the authors that the intense violet colorations obtained by the application of the Le Nobel test to urine are due to aceto-acetic acid, and not to acetone. This diminishes still further the value of this test as a

test for acetone alone. The authors, however, are at a loss to explain the results obtained by Rothera⁷, who, by the addition of sodium nitroprusside and ammonia to aceto-acetic acid, obtained an orange-red coloration, a colour similar to that given by ethyl aceto-acetate. If a few drops of our solution of aceto-acetic acid be added to normal urine, such a urine behaves exactly as the urine of a case of aceto-aceturia.

The point next investigated was the influence of other substances upon the test, which were likely to occur in urine, and the influence of acids, other than acetic. The following table shows quite clearly that the test is unaffected by the ordinary constituents of acidosis or diabetic urine.

Substance	Result	Remarks
Creatinin	—	No appreciable effect on coloration
Glucose	—	No appreciable effect on coloration
NaH ₂ PO ₄	—	Coloration as with acetic acid
β Oxybutyric acid	—	Coloration as with acetic acid
Formic acid	—	Coloration as with acetic acid
Oxalic acid	—	Coloration as with acetic acid
Sulphuric acid	—	Coloration not so intense as with acetic acid
Hydrochloric acid	—	Coloration not so intense as with acetic acid

In the first two cases the substances were added to the solution of aceto-acetic acid and the Le Nobel test applied as usual. In the other cases the acids named were used to replace acetic acid in the Le Nobel test. It next became important to compare the delicacy of this test for aceto-acetic acid with that of ferric chloride. The tests were carried out as follows: The urine containing aceto-acetic acid was rendered acetone-free by the Folin method, and the aceto-acetic acid then determined by the Messenger-Huppert method. A sample of the acetone-free urine was then tested by the ferric chloride test and by the Le Nobel at varying dilutions, and the dilutions noted at which the urines just failed to respond to the tests. The dilutions were performed with normal urine. Two cases were examined.

A. Percentage aceto-acetic acid = 0.139.
 ,, free acetone = nil.

Dilution	1 part aceto-acetic acid in	Le Nobel test	Fe ₂ Cl ₆ test
1	720	+	+
1/5	3,600	+	+
1/10	7,200	+	—
1/20	14,400	+	—
1/40	28,800	+ (very faint)	—
1/60	43,200	—	—

B. Percentage aceto-acetic acid = 0.0273.
 ,, free acetone = nil.

Dilution	1 part aceto-acetic acid in	Le Nobel test	Fe ₂ Cl ₆ test
1	3,663	+	+
1/2	7,326	+	—
1/4	14,652	+	—
1/8	29,304	+ (very faint)	—
1/12	43,956	—	—

It will thus be seen that in both the cases examined the limit of detection of aceto-acetic acid in urine by the Le Nobel test is about 1 part in 30,000, whereas the ferric chloride test fails to show aceto-acetic acid when present 1 part in 7,000. The Le Nobel test is thus at least four times as delicate as the ferric chloride test, and the authors feel quite confident in recommending its use as a test for aceto-acetic acid in urine in place of the ferric chloride test.

The delicacy of the test in aqueous solution cannot be easily determined, and the figures obtained would not, in our opinion, be of sufficient interest to justify the extremely complicated processes which would have to be undertaken to obtain pure aceto-acetic acid. As a rough indication, however, a sample of our solution of aceto-acetic acid was rendered acetone-free and the aceto-acetic acid determined by the Messenger-Huppert method, and the test applied at varying dilutions. The experiment indicated that the limit of detection of aceto-acetic acid in aqueous solution by the Le Nobel test is about 1 part in 80,000. The error consists in the presence in the solution of ethyl aceto-acetate, which would make the percentage of aceto-acetic acid appear too high. The limit of detection is thus greater than the actual experimental figures.

REFERENCES

1. Le Nobel, *Archiv. für exper. Path.*, XVIII, p. 10, 1884.
2. Jackson-Taylor, *Lancet*, I, p. 805, 1907.
3. Rothera, *Journ. Physiol.*, XXXVII, p. 491, 1908.
4. Saxe, *Examination of Urine*, Sec. Ed., p. 168, 1909.
5. Engel, *Zeit. für klin. Med.*, XX, p. 514, 1892.
6. Bitto, *Ann.*, CCLXVII, p. 867, 1892.
7. Rothera, *Journ. Physiol.*, XXXVII, p. 492, 1908.

THE FATTY ACIDS OF BUTTER

By IDA SMEDLEY (*Beit Memorial Research Fellow*).

From the Bio-Chemical Department, Lister Institute

(Received September 19th, 1912)

I. THE NATURE OF THE CAPROIC ACID PRESENT IN BUTTER

In spite of the large number of analyses of butter fat carried out for technical purposes, there remains considerable uncertainty as to the constitution of the fatty acids it contains. Even the nature of the lower fatty acids present is not definitely established, for whereas the caproic acid isolated from butter fat is described in most of the standard works of reference¹ as iso-caproic acid on the alleged authority of Chevreul, Lewkowitsch² prefers to regard it as the normal acid from analogy with the other fatty acids in butter. No work on the constitution of the hexoic acid present in fats appears to have been carried out since its isolation by Chevreul³.

In Chevreul's pages no reference to the molecular structure of the acid is to be found, nor was the existence of two isomeric caproic acids established until fifty years after this work was published. The iso-acid was the first hexoic acid to be synthesised; Frankland and Kolbe⁴ saponified the cyan amyl obtained from the amyl alcohol of fermentation and obtained an acid possessing, therefore, the structure



It was not until twenty years later than the normal acid was discovered by Lieben and Rossi⁵, who carefully characterised the normal and iso-acids⁶, the solubility of the barium and calcium salts being especially characteristic. Up to this time, caproic acid had been found in butter³, in cocoanut oil⁷, in the flowers of *Satyrium hircinum*⁸, in the fusel oil of beet-molasses⁹, and in the fruits of *Ginko biloba*¹⁰. In none of these papers is any attempt made to identify this acid as either normal or iso, and, apparently, it is only because the iso-acid was synthesised twenty years before the normal that this error has crept into the literature. Franchimont and Zincke ascribe the normal structure to the hexoic acid obtained by oxidising the hexyl alcohol from Heracleum¹¹, and the caproic acid from the butyric fermentation of sugar was also identified as the normal acid by Lieben¹².

Examination of the data given by Chevreul indicates that the hexoic

acid of butter has probably the normal structure; he gives as the solubilities of the barium and calcium salts:—

100 parts of water at 10·5 dissolve 8·02 parts Ba salt.

„ „ „ „ „ 14 „ 2·04 „ Ca „

Lieben and Rossi⁶ give the following values:—

Normal Acid—

100 parts of solution at 18·5 contain 8·4967 grs. Ba salt.

„ „ „ „ „ „ „ 2·707 „ Ca „

Iso-acid—

100 „ „ „ „ „ „ 34·65 „ Ba „

„ „ „ „ „ „ 11·3 „ Ca „

Chevreul's data appear, therefore, to indicate that the acid which he obtained from butter possessed the normal structure.

The identification of the acid present in natural fats as normal or as iso-caproic acid is one of considerable importance; the existence of iso-caproic acid $(\text{CH}_3)_2\text{CH}\cdot\text{CH}_2\text{CH}_2\text{COH}$ would suggest its derivation from leucin by deamidisation and, hence, might indicate a close connection with protein metabolism. This view was put forward by Felix Ehrlich¹³, who suggested that the caproic acid present in neutral fats and that formed in fermentation, although hitherto regarded as the normal acid, might be mixtures of inactive di-methyl butyric with active methyl ethyl propionic acid, derived, respectively, from leucine and iso-leucine.

Ehrlich pointed out that fatty acids have been observed in the bacterial decomposition of proteins, leucine and caproic acid occurring together¹⁴; whilst the production of dextro-rotatory caproic acid from the decomposition of casein and elastin has also been observed by Neuberg¹⁵; in the former of these papers, however, no evidence is given as to the structure of the caproic acid present.

On the other hand, if the fatty acids which occur in butter and in cocoanut oil containing 4, 6, 8, 10, 12, 14, 16, 18 and 20 carbon atoms, respectively, consist of normal chains and are synthetic products, their formation from some simple starting product by an analagous series of reactions in which at each step two carbon atoms are added, appears probable.

It appeared desirable, therefore, to settle quite definitely the structure of the hexoic acid present in butter. The differentiation of the normal and iso series of acids is conveniently based on the examination

of the amides, those formed from the iso-acids melting at considerably higher temperatures than those which belong to the normal series.

This is shown in the following table:—

Normal			M. Point	Iso			M. Point
Butyric	115°	Dimethyl acetic	128°
Valeric	114-116	Iso-propyl acetic	127
Caproic	100	Iso-butyl acetic	118
Heptoic	96-97				
Caprylic	97-98	Ethyl-butyl acetic	102
Nonoic	99				
Caprin	108				
Undecanic	103				

The isolation of the caproic acid was carried out as follows:—

About 3,500 grs. of pure butter fat* having the constants Iodine value 38·7, Saponification value 232, Reichert-Meissl 29·9, were saponified with alcoholic potash and the fatty acids liberated. The mixture was then steam-distilled until the odour of the lower fatty acids was no longer markedly perceptible in the distillate. The distillates, neutralised with potash, had a distinct odour of the higher fatty alcohols; sufficient was not, however, obtained for further identification. After concentrating to a small bulk, the solution of the soaps was acidified and extracted with ether. 125 grams of acid thus obtained were distilled from a flask fitted with a Young's 8-pear fractionating column and separated into the following fractions:—

Boiling point	Weight	
Up to 160°	24 grs.	
163—168	43 "	Boiling point, butyric acid, 163 (7 mm.)
168—173	25 "	
173—178	10 "	Boiling point iso-valeric acid, 174
178—183	3 "	
183—188	2 "	Boiling point N. valeric acid, 186
188—193	2 "	
193—198	0·5 "	
198—203	2 "	Boiling point iso-caproic acid, 200
203—208	5 "	Boiling point N. caproic acid, 205
208—213	6 "	

The residue remaining in the flask (16 grs.) was then distilled without a fractionating column.

213—218°	1·2 grs.	
218—228	4·8 "	
228—238	2·7 "	
238—248	1·5 "	
248—258	1·7 "	
Residue	4·1 "	Solidified on cooling

Two grams of each of the fractions boiling at 173-178°, 183-188°, 198-203°, 203-208° and 208-213° were then converted by Aschan's method¹⁶ into the corresponding amides. From each of the fractions 198-203°, 203-208°

* Pure butter was obtained from Lovegrove's Dairy, Checkendon.

and 208-213° an amide separated, melting at 96-97°. This was recrystallised from dilute alcohol and, finally, from a mixture of chloroform and petroleum; the crystals melted at 99-100°.

Amides were then prepared from Kahlbaum's normal synthetic caproic and isobutyl acetic acids. After recrystallisation these melted at 99-100° and at 118°, respectively. The melting point of the former was not depressed when mixed with the amide of the caproic acid from butter. The fraction boiling from 198-213° contained, therefore, normal caproic acid, and gave no indication of the presence of the iso-acid.

The fraction boiling up to 160° was now examined for acetic acid. It consisted chiefly of ether, and was neutralised by the addition of 1.2 c.c. N.KOH. On acidifying the solution of the small amount of potassium salt, drops of an insoluble acid with the characteristic butyric odour at once separated, so that the quantity of acetic acid, if any were present, could only have been exceedingly small.

In the above experiment, the steam-distillation was not continued until the whole of the volatile acids had passed over, but was stopped when 4.5 per cent. of the total weight of acid had been received. The proportion of acids present in the distillate examined was approximately:—

Butyric acid	85 gr.	74.6 per cent.
Caproic acid	13 ,,	11.3 ,,
Caprylic and Capric acids			12 ,,	10.5 ,,
Solid acids	4 ,,	3.5 ,,

II. THE EXISTENCE OF UNSATURATED ACIDS IN BUTTER OTHER THAN OLEIC ACID

A careful fractionation of the methyl esters of the butter acids was undertaken in order to obtain evidence as to the possible existence of lower members of the oleic acid series. It is a remarkable fact that whereas the 18-carbon atom unsaturated acid is commonly identified in fats, the existence of lower members of the oleic series has only been shown in cod-liver oil¹⁷. The experiments now carried out appear to indicate the presence of a small quantity of a lower unsaturated acid accompanying the decoic acid present.

The butter used for the preparation gave the following values: Reichert-Meissl 26.84, Iodine 37, saponification 228.

1,900 grams of dried butter-fat were shaken up with 567 c.c. of a solution of sodium in methyl alcohol (4.536 N). The emulsion formed

was allowed to stand overnight and the esters next morning extracted with ether. After drying and evaporating off the ether on a water bath, 1,630 grams of liquid remained.

Examination for unsaturated acids.

The esters boiling above 160° under atmospheric pressure were then distilled under a pressure of from 10-15 mm., in a flask fitted with a Young's eight-pear fractionating column. The fractions were collected at first over from five to ten and then over every three degrees, and the iodine values of the different fractions determined; these are shown in the following table:—

Pressure	Boiling point	Weight of distillate	Iodine value	Saponification number		
15 mm. ...	80—85°	4 gms.	2.9	—	Boiling point methyl caprylate, 83° (15 mm.)	
	85—90	6 "	—	—		
	90—95	— "	—	—		
	95—105	7 "	5.4	—		
	105—110	8 "	10.4	—		
	110—120	10 "	12.5	308.2		Boiling point methyl caprate, 114° (15 mm.) Sapon. No. 302
	120—127	10 "	{ 12.0 11.9 }	307.3		
	127—132	8 "	8.7	282.9		
	132—147	— "	—	—		
	147—151	10 "	4.9	—		Boiling point methyl laurate, 141° (15 mm.) Sapon. No. 262
15 mm. ...	151—152	{ 18 "	{ 7.8	—	Boiling point methyl myristate, 167.8° (15 mm.) Sapon. No. 232	
	152—160					
	160—167	20 "	7.5	256.8		
	167—172	27 "	7.7	240.7		
	172—175	16 "	7.9	—		
	10 mm. ...	165—170	25 "	8.1		—
		170—173	40 "	8.8		241
173—176		16 "	8.0	—		
12 mm. ...	176—180	5 "	8.1	—		
	180—183	14 "	8.8	—		
	183—186	23 "	9.4	—		
	186—189	100 "	17.2	—		
	189—192	120 "	{ 17.5 17.2 }	221		
	192—195	89 "	20.5	—	Boiling point methyl palmitate { 186° (10 mm.) Sapon. No. 208 (196° (15 mm.))	
	195—198	74 "	29.9	215		
	198—201	29 "	37.2	—		
	201—204	68 "	48.5	—		
	204—207	138 "	61.1	196		
12 mm. ...	207—210	215 "	66.6	—		
	210—215	114 "	67.3	—	Boiling point methyl oleate { 205.6° (10 mm.) 212.3° (15 mm.)	
	Residue in flask boiling above 220	215—218	26 "	67.8	—	Boiling point methyl stearate 214.5° (15 mm.) Sapon. No., methyl stearate, 188
			32 "	—	—	
			32 "	—	—	

DISTILLATION OF METHYL ESTERS OF BUTTER-FAT (obtained by Bull's method),
under 10-15 mm. pressure.

Curve showing relation of Iodine values to Boiling points.

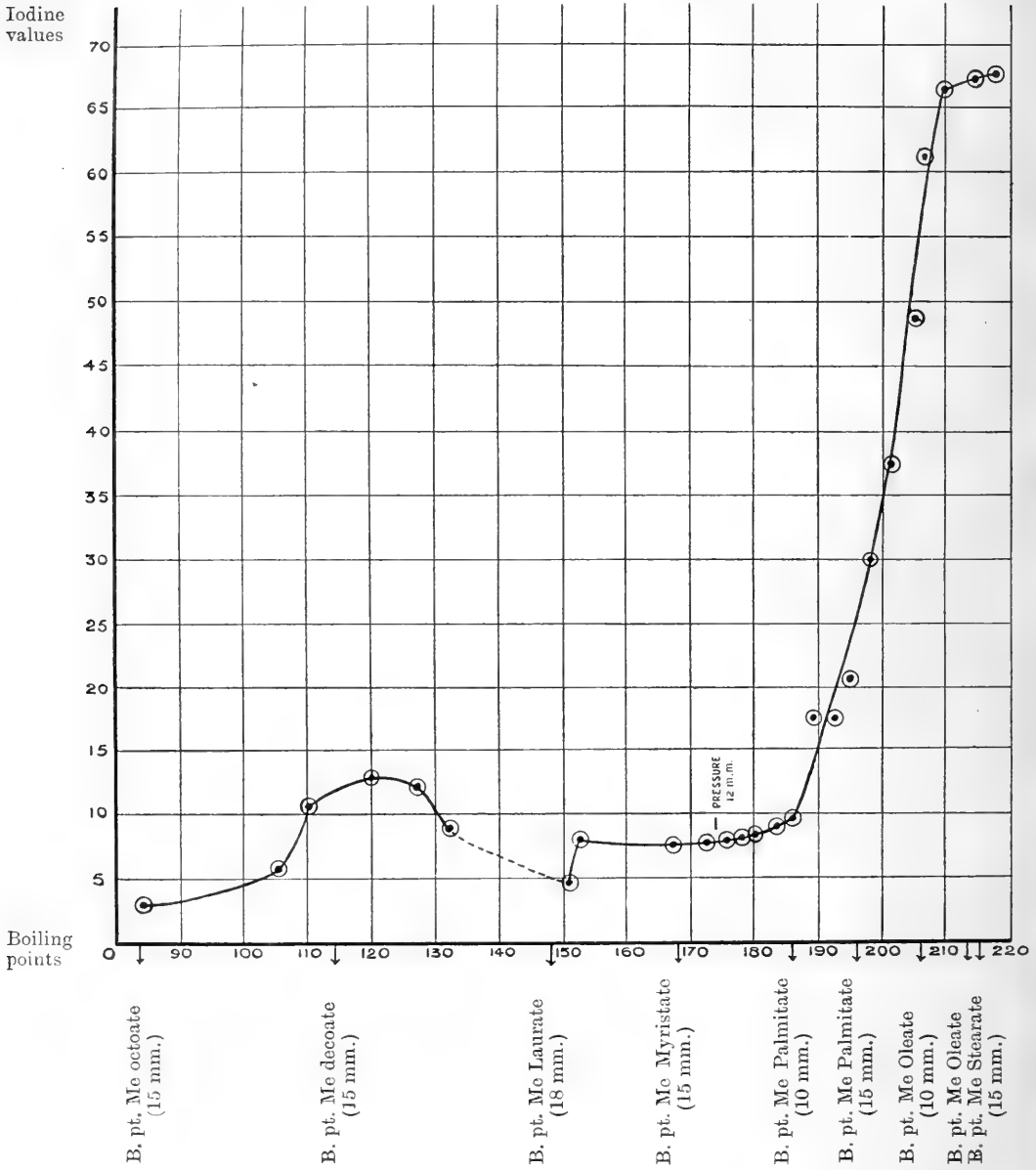

The curve shows a marked rise in the iodine values of the fractions boiling from 105-127°. The marked maximum at 120° is followed by a gradual depression until 150° is reached, the iodine value remains constant whilst the boiling-point rises through 30° C., and then a rapid increase marks the distillation of the oleic acid. So far, attempts (based on the crystallisation of the lead, magnesium and barium salts) to isolate unsaturated esters from these lower boiling fractions have proved unsuccessful. Were oleic the only unsaturated acid present, a steady rise in the iodine value, with increase of boiling-point, might have been expected. The increase in iodine value in the fraction boiling from 110° to 130° appears to the author to furnish evidence of the presence of an unsaturated ester containing a less number of carbon atoms than oleic, possibly a decylenic acid since it passes over with the fraction containing methyl decoate (caprate). It is possible that traces of other unsaturated acids may also be present, and that the iodine values found for the lower fractions may not be due to traces of oleic acid.

Distillation of the ethyl esters.

A confirmatory experiment was carried out in which the fatty acids from the 3,500 grams of butter-fat used for the separation of caproic acid (cp. p. 453) were converted into the ethyl esters by boiling for several hours with an alcoholic solution of hydrochloric acid. After washing with a dilute solution of sodium carbonate to remove free fatty acids, and drying with CaCl_2 , 2,662 grams of esters were obtained, which were distilled under a pressure of 20-30 mm. and divided into three fractions:

- | | | | |
|---------------------------|---|---|--------------|
| (1) boiling up to 200° | - | - | 281 grams; |
| (2) boiling from 200-220° | - | - | 654 grams; |
| (3) boiling above 220° | - | - | 1,727 grams. |

The fraction boiling up to 200° was then distilled under a pressure of from 20-28 mm. in this case a six-pear fractionating column being used. The ethyl esters boil about 20° higher than the corresponding methyl esters. The iodine and saponification values of the different fractions were determined as in the previous experiment; a distinct increase in the iodine value was found in the fraction, the saponification value of which agreed with that required for the decoic ester.

Distillation of ethyl esters of butter fatty acids boiling up to 200° (20-30 mm.); (the more volatile acids having been partially separated).

Pressure	Boiling point	Weight of Fraction	Saponification Number	Iodine Number	
25-28 mm. ...	80—85°	12.8	389.8	0.7	Sapon. No. ethyl hexoate = 388 (caproate)
	85—90	2.3	—	—	
	90—95	2.0	—	1.5	
	95—100	0.2	—	—	
	100—105	1.2	—	—	Sapon. No. ethyl octoate = 326 (caprylate)
	105—110	0.2	—	—	
	110—115				
	115—120	4.0	349.6	2.5	
	120—125	20.0	316.5	3.0	
	125—130				
	130—135	5	—	—	Sapon. No. ethyl decaate = 280 (caprate)
	135—140	5.5	—	6.8	
	140—145	15.5	288.8	7.8	
	145—150	21	282.1	8.7	
* 20 mm. ...	150—155	—	—	—	
	155—160	18	259.4	7.2	
	160—165	9	—	6.8	
	165—170	7	252.8	—	
	170—175	6	—	5.5	Sapon. No. ethyl myristate = 219
	175—180	18	238.9	6.5	
	180—185	3	—	—	
	185—190	8	—	7.4	Sapon. No. ethyl myristate = 219
	190—195	14	222.6	9.6	

The distillation was not further continued.

* Distillation stopped here : continued on the following morning under a pressure of 20 mm.

DISTILLATION OF ETHYL ESTERS OF BUTTER-FAT (obtained by esterification of fatty acid with ethyl alcohol and HCl) under 20-25 mm. pressure.

Curve showing relation of Iodine values to Boiling points.

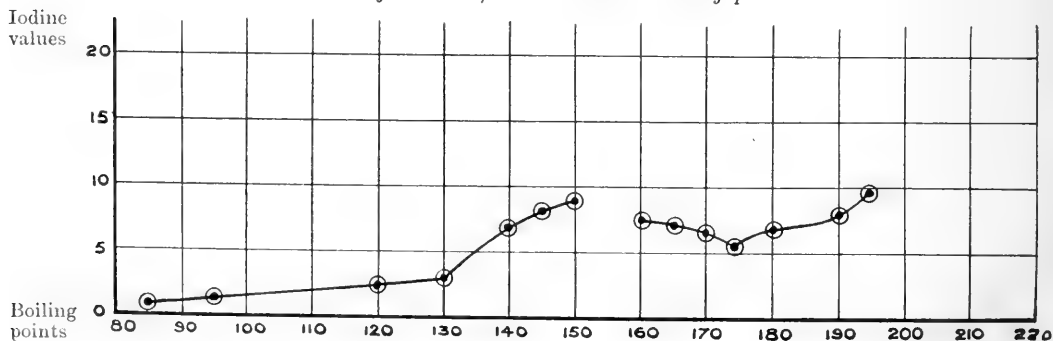

Three other experiments were carried out, in each of which between 300 and 400 grams of methyl esters were prepared and distilled. In every case the iodine values of the fractions corresponding to the decaic acid were higher than those of the succeeding fractions. The increase is not very large, but was present in five different specimens of butter examined, and it may be inferred therefore that it is generally present, and may be regarded as significant. It appears probable that the presence of a deacylenic acid is indicated.

III. ON THE PRESENCE OF STEARIC ACID IN BUTTER

In view of the statements of Lewkowitsch and others (cp. Lewkowitsch, loc. cit.) that, when examined by the ordinary methods used in the examination of butter, only traces of stearic can be found, the higher boiling fractions of the methyl esters were examined for stearic acid. From the fractions in two experiments boiling at 210-215° a solid ester was separated, which, when twice re-crystallised from alcohol, melted at 37-38°, and on saponification gave an acid crystallised from alcohol in plates melting at 69°, and which was therefore identified as stearic acid. The quantity of stearic present was approximately estimated as about 10-15 per cent. of the total butter acids. Lewkowitsch has drawn attention to anomalies observed in the estimation of stearic acid when lower acids than palmitic are present (cp. Lewkowitsch, loc. cit., Vol. I, p. 453). The presence of considerable quantities of stearic acid in butter-fat was also found by Caldwell and Hurtle¹⁸, who state that the oleic acid of butter occurs chiefly in combination as an oleo stearo palmitin.

Reaction with sodium-nitro-prusside.

The distillate, boiling up to 140° under atmospheric pressure, gave a very low iodine value of between two and three units. The fraction boiling from 100-120° was heated with a solution of caustic potash, acidified with acetic acid and a solution of sodium-nitro-prusside and strong ammonia then added; a deep violet colour developed. The same fraction gave negative results when treated with Fehling's solution and with ammoniacal silver nitrate. The sodium-nitro-prusside reaction was obtained in two out of five experiments in which the esters had been prepared by Bull's method; but when the esters were prepared by an acid method of alcoholysis, in no case was the reaction obtained. This

reaction is especially characteristic of aceto-acetic acid and of acetone, and it is possible that these were present in those samples examined which gave positive results. In view of the inconstancy of the results obtained, it is possible that these products had been formed as the result of bacterial action. Further evidence as to the nature and origin of the substances producing this reaction is desirable, as the certain detection of aceto-acetic acid in butter would be a point of considerable importance.

CONCLUSIONS

1. No evidence of the presence of acetic acid was found in the butter examined.

2. The hexoic (caproic) acid present in butter possesses the *normal* structure; no indication of the presence of the iso-hexoic acid was obtained. It seems probable that of all the naturally existing specimens of caproic acid which have been described, only that occurring in the bacterial decomposition of proteins has a branched structure.

3. The proportion of stearic acid was estimated as from 10-15 per cent.

4. Evidence was obtained of the existence of lower members of the oleic acid series; the iodine value of the decoic ester fraction is appreciably greater than those of the fractions immediately preceding or following it. This may be regarded as indicating the presence of a lower unsaturated acid, possibly of a decylenic acid.

5. The sodium-nitro-prusside reaction, characteristic of aceto-acetic acid and of acetone, was given by the butyric ester fraction obtained from two out of five samples of butter, esterified by sodium methylate at ordinary temperature: the remaining three samples gave negative results. The reaction may possibly have owed its origin to the products of bacterial action; it was observed in two cases where Haller's acid method of esterification had been used.

REFERENCES

1. Abderhalden, *Biochemisches Hand-Lexikon*, Vol. I, p. 989; cf. Beilstein, *Handbuch der Organischen Chemie*, Vol. I, p. 432.
2. Lewkowitsch, *Chemical Technology and Analysis of Oils, Fat and Waxes*, 4th Edition, Vol. I, p. 122, 1909.
3. Chevreul, *Recherches sur les corps gras*, p. 134, 1823.
4. Frankland and Kolbe, *Annalen*, LXV, p. 288, 1848.
5. Lieben and Rossi, *Ann.*, CLIX, p. 75, 1871.
6. Lieben and Rossi, *Ann.*, CLXV, p. 113, 1873.
7. Fehling, *Ann.*, LIII, p. 406.
8. Chautard, *Jahresber.*, p. 340, 1864.
9. Müller, *Jahresber.*, p. 499, 1852.
10. Bechamp, *Ann.*, CXXX, p. 364.
11. Franchimont and Zincke, *Ann.*, CLXIII, p. 193.
12. Lieben, *Ann.*, CLXX, p. 89, 1873.
13. Felix Ehrlich, *Ber.*, XL, p. 2547, 1907.
14. Emmerling, *Ber.*, XXX, p. 1863, 1897.
15. Neuberg, *Biochem. Ztschr.*, I, p. 368, 1906.
16. Aschan, *Ber.*, XXXI, p. 2348, 1898.
17. Bull, *Ber.*, XXXIX, p. 3570, 1906.
18. Caldwell and Hurlley, *Trans.*, XCV, p. 858, 1909.





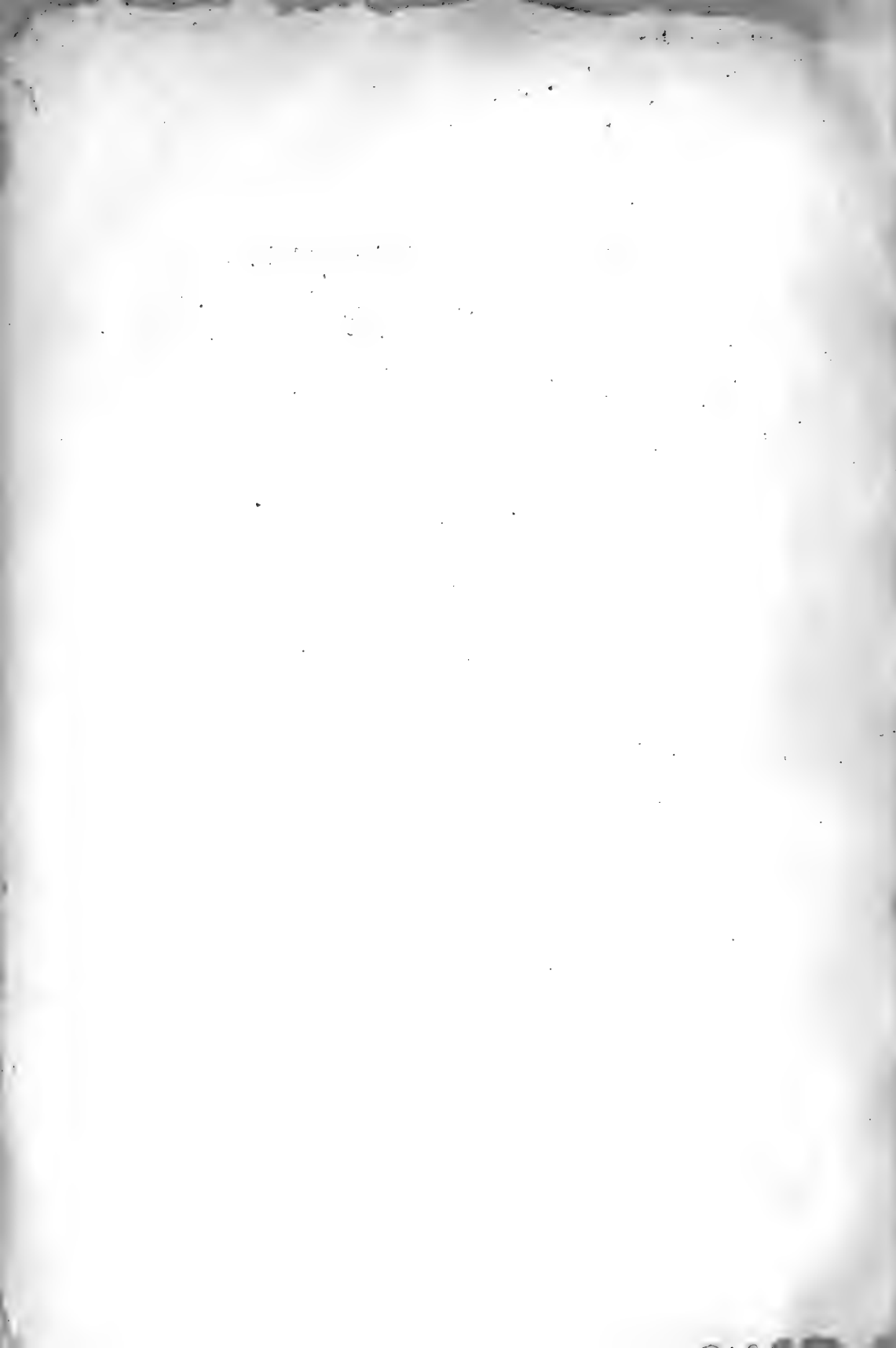



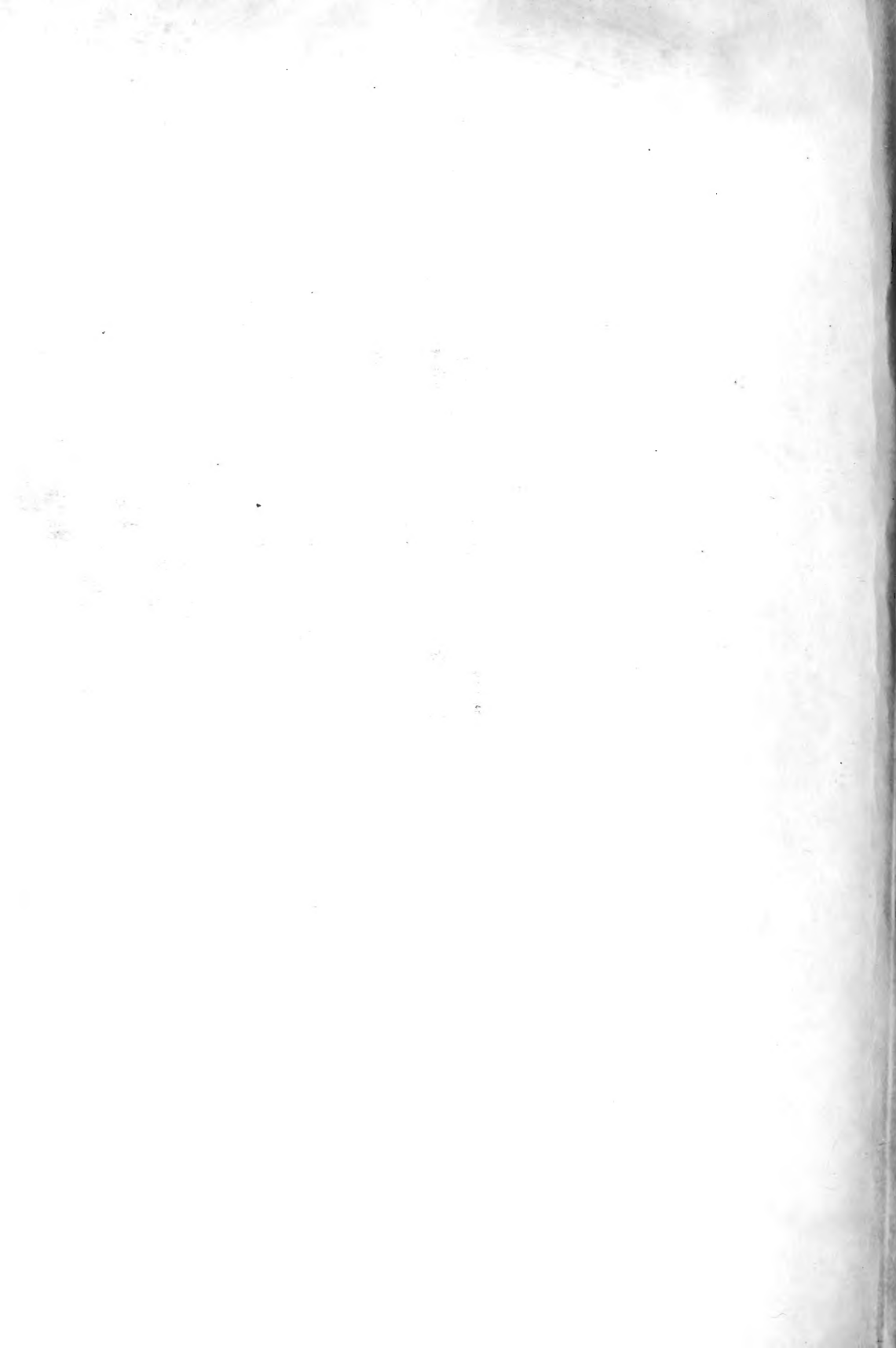

QP The Biochemical journal
501
B47
v.6
cop.4

Biological
& Medical
Serials

PLEASE DO NOT REMOVE
CARDS OR SLIPS FROM THIS POCKET

UNIVERSITY OF TORONTO LIBRARY

STOP & GE

