

★ UMass/AMHERST ★



312066 0333 3273 2



LIBRARY  
OF THE



MASSACHUSETTS  
AGRICULTURAL  
COLLEGE

SOURC



PER

SF  
521  
B7



LIBRARY

---

UNIVERSITY OF  
MASSACHUSETTS  

---

AMHERST, MASS.



THE  
**British Bee Journal,**  
AND  
BEE-KEEPER'S ADVISER.

CONDUCTED BY  
CHARLES NASH ABBOTT,  
HANWELL.

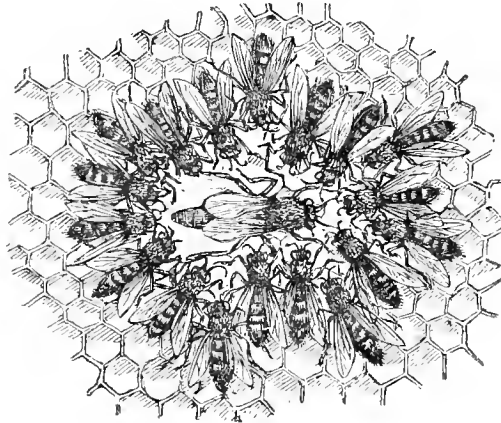

VOLUME II.

1874-5.

PUBLISHED AT THE OFFICE OF THE BRITISH BEE JOURNAL.  
HANWELL, W., LONDON.

AND BY  
JOHN STRANGEWAYS, 28 CASTLE ST., LEICESTER SQUARE, W.C.

# INDEX.

- Abbott, C. N., his exhibits of hives and honey, 90; of bee-furniture, 92; of specimens of the ravages of the wax-moth, 94; his prize Cottagers' hives, 89, 96; his experience with the 'Renfrewshire' queen-cage, 139, 144; his transferring apparatus, 147; his vulcanite feeding-stage, 162; his 'buttons,' 163; his scraper, knife, and feeding shovel, 164; his Improved Cottage Woodbury, 165, 182, 199; his sectional supers, 202; visits to his apiary at Hanwell, 132, 205
- Abbott, J. A., jun., testimony to him as an expert, 117
- Abnormal drones, 43
- Algerian bees, 134
- Alien queens fed by workers, 137
- America, cold weather in, 206
- American opinions of the quilt, 161, 176
- Anderson, D., J., and R., prize honey exhibited by, 90, 91, 101, 136
- Apiarian markets, 145, 146, 162, 189; manipulations, 69, 94
- Apiaries, Rodborough Vale, 38; Mr. Symington's, 57; Mr. Abbott's at Hanwell, 132, 205
- Apiary, removing an, 44; description of an, 65; a model, 139
- April, 197
- Artificial swarming, 3, 4, 42, 158; swarms, 36, 47, 157, 175; pollen, 139, 204, 206
- Aston's bee-trap, 122, 137; his Ladies' Woodbury hive, 88
- August, 53
- Australian meat-tins, utility of, for stands, 25
- Autumn treatment, 71
- Bagshaw, T., his straw super of honey, 90, 91
- Baldwin, S. J., his hive, 89; exhibition of honey, 92
- Balm, 129
- Bar-frame hive, opening, 74; preparing for swarms, 197; living swarms in, 198; driving bees in, 212
- Bar-frame holder, a, 119, 120
- Bar-frames, lateral movement of, 85; advantages of, 78
- Barley sugar, its value to bees in winter, 83, 125, 162, 194; directions for making, 129
- Bee-culture, 63, 83
- Bee-dress, 60, 173
- Bee-flower seeds, 194, 203
- Bee-guild, 87, 145
- Bee houses, 14, 15, 60
- Bee-keepers, experience of, 13, 27; statistics to be kept by, 2
- Bee-louse, 40
- Bee, new works on, 65, 158
- Bee-parasite, a, 40
- Bee-poison, 51; inoculation with, 132, 133
- Bee-quieters, Bligh's, 93, 111, 149, 150; Cheshire's, 93
- Bee society, a new, 165, 180
- Bee-trap, 35, 67, 92, 165
- Bees, swarming of, 3; Ligurian, 6, 27, 90, 99, 103, 104; mortality of, 13, 28; ill-luck with, 17; suspension of breeding, 20; introduction of, to queens, 24; crippled, 37; importing colonies of, 38; management, 39; coloured, 41; black, 47; distinction between, *ib.*; robbing, 47, 74; feeding, 73, 85, 185; uniting, 73; ulterior intentions of, 49; clustering, *ib.*; packing, 52, 178; hiving, 64; eccentric conduct of, 65; stings, 69; absence of young, 71; in Iowa, 98; weight of, *ib.*; age of, how to be reckoned, 100; introduction of, into Ireland, 102; strange freak of, 103; observations on, 112-114; localisation of, in hives, 125; seeing, 129; how best preserved in winter, 129; Carniolan, 134; Algerian, *ib.*; feed imprisoned alien queens, 145; removing from barns, &c., 151, 175; Brazilian stingless, 155, 173; new works on, 158; in winter, 165; after the frost, 167; wintering, 168; sleeping during winter, 169; proposed trial of hives and bees, 175; in an old granary, *ib.*; deserting hives, 184; in Cashmere, 186; water for, 192; Egyptian, 194; renewal of populations of, 197; early development of, 209
- Bell-glasses, 48
- Bennett, F., his balloon hive, 94; wasp's nest, 94
- Berkshire bee-hive, the, 181
- Berlepsch on fertile workers, 7
- Best, the, moveable comb-hive, 120
- Best hive, the, 152, 205
- Bligh, Hon. and Rev. H., his prize honey, 90; his bee-quieter, 93, 111, 149, 150
- Braula ceca, 40
- Brazilian stingless bees, 155, 173
- Brimstone pit, 116
- British Bee-keepers' Association, 19, 33, 52, 70, 88, 96, 105, 142, 160, 195; functions of Committee of, 210
- British Bee Journal, 70, 87, 137, 145, 156, *et passim*.
- Burdett - Coutts, Baroness, encourages bee-keeping, 99
- Buttons, 163, 188
- Caledonian Bee Association, 180, 184, 204
- Carbolic acid, 36, 47
- Carniolan bees, 134
- Carr-Stewarton boxes, 82; hives, 89
- Carr, W., on the Stewarton hive, 9, 10; queen-cage and uniting queens, 14; his plan of inserting queens, 45; on the wax-moth, 49; queen-cage exhibited by, 93; Manchester super exhibited by, 94; specimens of ravages by the wax moth, *ib.*; pen-and-ink drawings of the queen and her progeny, *ib.*; on the extractor, 95
- Cashmirian bees, 186
- Castles, 35
- Cheshire, F. W., his vulcanite feeding-stage, 73; his moveable comb hive, 88; his drone-trap, or five-pin bee-trap, 92, 165; his bee-feeder, 92; his bee-quieter, 93; his dividing frame, transferring board, sugar-can, 94, 111, 112
- Cheshire nucleus frames, 194
- Chevalry, Professor, 38, 39
- Chloroform as a fumigating agent, 86
- Clarke, Rev. W. F., on hives, 158
- Clergy, appeal to the, 92; special efforts of the, 115, 116
- Clip, zinc or tin, 24
- Clover honey, 174
- Collateral hives, 89
- Combs, 112; colour of, 50; irregularity of, *ib.*; relieving overcharged, 54; crooked appearance of, 55; straightening crooked, 85
- Comb-building impulse, 159; effects of checking, 25
- Comet year of 1874, 53, 71
- Coming Show, 62; anticipations of, 63
- Condemned bees, 71, 139
- Condenser, 172
- Condy's Fluid, 36
- Convert to the bar-frame system, 57
- Copenhagen bee exhibition, 131
- Cottagers' classes at the Honey Show, 91
- Cottagers' hives, 88; description of, 96
- Cowan, T. W., supers of honey exhibited by, 83, 90, 91, 133; his honey-extractor, 93; why his supers were disqualified, 124; his system of working the Woodbury hives, 141, 185, 207
- Crooked combs, straightening, 85
- Crown-board and quilt, 144, 187
- Crystal Palace Bee and Honey Show, 4, 51, 115, 156; prize fund, 5, 33, 46
- 52, 87; schedule of prizes, 45; exhibits, 51, 69; judges, *ib.*; operations and operators at, 52; manipulation of bees at, 69, 94; the Manchester Show super at, 69; awards at, 70; its origin and history, 87; its success, 95; an hour at the, 98; suggestions toward a future, 114, 115, 133; commission received on sales at, 146
- Crystal Palace Shows, statistics of, 150
- Danish Bee-keepers' Exhibition, 134, 135; queen-cages, 206; bee furniture, *ib.*
- Deal, the best wood for hives, 193; its balsamic odour, 204
- December, 125, 126
- Discrepancy, where is the? 46
- Disinfectant instrument, 36
- Difficulties, 43
- Doubled stocks, advantage of, 194
- Draining honey, 72
- Driving-sticks, 128
- Driving as at the Crystal Palace, 127, 128; in bar-frame hives, 212
- Driving swarms, 47
- Drones, 47; as fertilizers, 28; produced by an unfertilized mother, *ib.*; abnormal, 43; destruction of, 53; seldom bred during the first season, 159
- Drone-cells, 5
- Drone-comb, 17
- Drone-traps, 53, 92, 165
- Drumming, by finger and sticks, 128
- Drying hives, 144
- Dysentery and foul brood, 107, 126
- Dzierzon's theory, 6, 7
- Early pollen gathering, 171; swarming, 41
- Editorial, 1, 19, 33, 51, 69, 87, 107, 125, 143, 161, 179, 197
- Edwards, C. E., his arrangement for hive dummies, 178
- Egyptian queens, 7; bees, 194
- Entrances to hives, contraction of, 4, 98, 107
- Essays, prize for, 5
- Evans, Dr. C. 21
- Exhibitions, London and Paris, 133, 134; London and Copenhagen, 134
- Exhibitions, judges at, 174
- Experience, 16, 27, 44, 45, 64
- Expert, testimonial to a young, 117, 118
- Extractor. See Honey Extractor.
- February, 161
- Feeding bees, necessity of, 21, 28, 72, 97; spasmodic

- and gentle, 123, 177, 179; stimulative, 161  
 Feeding-bottle, 85  
 Feeding-trough, 56  
 Ferguson, A., of Stewarton, his prize honey, 90, 92, 101  
 Fertile workers, 7, 180  
 Five-pin trap, the, 92, 165, 190  
 Floor-boards, cleansing of, 98, 161  
 Food, quantity required for bees during winter, 150  
 Foreign bee intelligence, 158, 193, 210  
 Foul-brood, prize offered for the cause and cure of, 5; its origin, treatment, and cure, 13, 20, 43, 64, 78, 80, 107, 108, 121, 126, 130-132, 211; experiments on, 132  
 Fox, G., honey exhibited by, 91  
 Frames, standard for width of, 140; spaces above, 143, 204; number of, in hives, 159; depth for, 194; Italian official, 204  
 France, bee-intelligence from, 158, 193, 210  
 Frost, after the, 167  
 Fruit and flower show, 87  
 Fumigators, 15, 25, 26, 93, 211  
 Fungus, the cause of foul-brood, 130  
  
 Garibaldi, a bee-keeper, 158  
 Geddie's patent hive, 64  
 Gentle feeding, 28, 97, 179  
 Germany, bee-flower seeds from, 203; stocks of bees in, 210  
 Girdwoyn, M., his work on the honey-bee, 158  
 Glass hives, 188; observatory, 208  
 Gloves, 74  
 Glucose, 194  
 Goddard, Rev. T. W., inventor of the Sherrington hive, 109  
 Graham, R., honey exhibited by, 91  
 Guide-combs, 39, 85, 198. *See* Wax-sheets  
  
 Hale, Mr., Kedington hive, 89  
 Hanwell apiary, 132, 205  
 Hartleb's 'Commonwealth of Bees,' 64, 151  
 Harvest, the, 102  
 Harvest festivals, bees and their produce at, 115  
 Hayter, Mr., straw bell hive, 94  
 Heather honey, 131, 141  
 Hive shape, philosophy of, 76  
 Hives, and bee-gear, 44, 88, 141, 153, 167, 174, 177, 205; selection of, 1; Stewarton, 9, 101, 136, 157, 159, 194; Octagon, 100, 122, 136, 137, 140; stands for, 25, 193; proper distances to be maintained, 50; cleansing of foul, 37; weight of, 42; variety of, 44; Neighbour's, 44, 89; nucleus, 46; examination of, 67; Mr. Rusbridge's, 84; for depriving and observing, 88; Cottagers', 88; Pettitt's, 88, 89; Ladies' Woodbury, 88; Sherrington, 88, 109-111; Kedington, 89; Abbott's Cottagers', 89, 96; on the storifying principle, 89; Slindon, 94, 120, 153; Observatory, 29, 124; wet, 144; drying, *ib.*; Lanarkshire, 148, 181; number of frames in, 159; circular and octagon, *ib.*; object of, the storing of honey, *ib.*; Improved Cottage Woodbury, 164, 182, 199; locating, passages in, 176; glass, 172, 188; Berkshire, 181; echoes from the, 193, 210; aspect for, 194; placing the, 198  
 Hiving under difficulties, 191; swarms, 198  
 Hodgson, J. F., on the extractor, 95  
 Honey, spurious, 9; utilizing of doubtful, 18; yield of, 68; excess of, in hives, 71; sycamore, 81; at the Crystal Palace, 90; Octagon Stewarton supers, 90; to clarify, 112; yew-tree, 129; heather, 129, 135, 141; ivy, 140, 155, 178; ought to be exhibited in smaller portions, 147; price of, in France, 193; leaking from sealed cells, 194; pure, *ib.*  
 Honey-bee, what it can do without us, 116, 117  
 Honey extractor, 5, 38, 40, 54, 57, 58, 71, 73, 80, 81, 93, 95, 103, 121, 124, 156, 169, 209  
 Honey gathering, 26  
 Honey harvest, 82  
 Honey-market reports, 8  
 Honey-market, 4, 5, 8, 51, 145, 166, 180, 189  
 Honey slinger. *See* Honey Extractor  
 Hruschka, Mr. F. de, his mellipult, 58, 80; presentation of a medal to, 158  
 Humming of bees, 98  
 Hunter, J., on the fertilization of queens, 6; his services at the Honey Show, 91; his collection of queens, workers, drones, &c., 94; his experience with queens and queen-cages, 138, 139, 140; on quilts, 161, 208; criticisms on his opinions on the quilt, 168  
 Hybridized queens, 25  
 Hybrids, 194  
  
 Identifying localities, 40  
 Importing colonies, 38, 39  
 Improved Cottage Woodbury hive, the, 164, 165, 182, 183, 199  
 Inoculation with bee-poison, 132, 133  
 Italian bee-keepers, Congress of, 176; bar-frame, 204  
 Ivy honey, 140, 155, 178  
  
 Italy, bee intelligence from, 158, 193, 210  
  
 Jackson, F. R., his Slindon hive, 94, 120, 153  
 January, 143; its great cold, *ib.*  
 Jones, J. C., his queen-cage, 119  
 'Journal of Horticulture,' 8, 16, 61, 92, 109, 154, 157, 161, 168  
 July, 31, 53  
 June, 20, 33  
  
 Kedington hive, 89  
 Kerr, Robert, his claim to the invention of the Stewarton hive, 10, 136, 152, 157  
 King, Mr., his Sherrington hive, 88, 91, 109  
 Klein, Dr., researches on the typhoid germ, 126  
 Knife for unsealing combs, 56; scraper, 164  
  
 Ladies' Woodbury hive, 88  
 Lanarkshire hive, description of the, 148, 181  
 Langstroth on the fertilization of queens, 6, 7; his hives, 92, 126; on rapid feeding, 97; his three principles of management, 127; his temperatures, 194  
 Langhland, W., honey and bees'-wax, 91, 94  
 Lee, James, his hives, 80, 90; bee-furniture exhibited by, 92; supers, 93, 163  
 Leighton, Mr., honey exhibited by, 91  
 Letter-box converted into a hive, 103  
 Ligurian bees, 6, 90, 99, 197, 205; versus black, 27; price of, 103; gentleness of, 194  
 Ligurian queens, introduction of, 18; uniting to black bees, 61; when to be obtained, 159  
 Ligurian queen-cells, 42  
 Ligurian stocks, formation of, 24  
 Ligurianizing, 62, 84, 86, 104, 177  
 Ligurianizing for ladies, 25  
 Lowe, J., on Dzierzon's theory, 6  
 Lubbock, Sir John, president of the Bee-keepers' Association, 98; his observations on bees, 112-114  
 Lythrum, 83  
  
 Management of bees, 39  
 Manchester Honey Show, 87; super at, 62, 91, 94  
 Manipulation, apiarian, 94, 99  
 March, management of bees during, 179; weather in, 197  
 Martin, W., his honey and bees'-wax, 91, 92, 94  
 May, apiarian work in, 1, 19; weather in, 44  
 Mewe, W., a bee-master, 170  
 Micrococci, its presence the cause of foul brood, 130  
 Model apiary, 139  
  
 Moveable comb hives, 2, 88, 120  
 Munn's, Major, Observatory hive, 29  
 My first swarm, 191  
  
 Nadiring, 41, 59  
 Nalirs, dead bees in, 59; time for placing, 152  
 Naples, congress of bee-keepers at, 158  
 Needles, useful in apiaries, 35  
 Neighbour and Sons' Cottage hives, 89; bar-frame hives, 89; machine for embossing wax-sheets, 94; queen-cage, 137, 154  
 New year, the, 145  
 Nomenclature of swarms, 40  
 Note, a, and a query, 102, 103  
 November, 107  
 'Novice,' suggestion respecting the production of foul brood, 29, 43  
 Nucleus, formation of a, 47  
 Nucleus hives, 46  
  
 Observatory hive, Major Munn's, 29  
 Observatory hives, 124  
 Octagon form of hive, the, 100, 122, 136, 137, 140, 151, 170; and Sir C. Wren, 63; figure of Sir Christopher Wren's, 151  
 Octagon Stewarton supers, honey in, 90  
 October, 97  
  
 Pagden, Mr., his nadiring system, 41, 59, 122  
 Pagden, Mrs., honey and bee-furniture exhibited by, 90, 91, 92; on the use of the nadir, 122  
 Paris Exhibition of Insects, 134; prizes given in the, *ib.*; report on, 158  
 Past month, the (May), 19; (June), 33; (July), 53  
 Past season, the, 46  
 Pennell, Rev. D. W., on the extractor, 95  
 Pettigrew, A., 58, 91, 94, 174  
 Pettitt, Mr., hives, 88; Major Munn's hives, 89; metal-rack hive, *ib.*  
 Phacelia seed, 68, 203  
 Plates for impressing wax-sheets, 203  
 Plumridge, T., honey exhibited by, 91  
 Pollen, 41, 86; artificial, 139, 204, 206  
 Populations of bees, renewal of, 197  
 Present season, the, 39  
 Prize fund, 5, 33, 46, 52, 87  
 Prize honey, 146  
 Puff-ball, 48, 49  
  
 Queen, and her progeny, 56; introduction of, 11, 22, 40, 45, 85, 137, 138; purity and fertilization of, 41; unimpregnated, 62; in a super, 83, 104; production of, 123; conveyance of eggs of, by workers, 176; young to be substituted for old, 185

- Queen-cages, 14, 23, 45, 61, 118, 119, 137, 138, 144, 145, 153, 154, 206
- Queen-cells, 4; transferring, 35
- Queen-piper, the, 176
- Queen-raising, 16, 177
- Queenless stocks, 180
- Queries and Replies, 17, 29, *et passim*
- Quieters, bee, 15, 93, 149
- Quilts, 75, 109, 141, 156, 167, 168, 169, 187, 205, 207
- Quinby hives, 126
- Raynor, Rev. G., super honey from one apiary, 90; his queen-cage, 118, 119
- Readers, address to our, 1
- Regulated feeding, 99; effect of, 240
- Removal of bees, 178
- 'Renfrewshire' Bee-keeper, his queen-cage, 93, 118, 154
- Richards, S., his drone-trap, 92
- Robbery, prevention of, 37
- Rodborough Vale apiary, 38
- Rusbridge, A., his cabinet hive, 89; his wood super of honey, 90; his mode of management, 207, 212
- Schedule of prizes, 87
- Schönfeld, Pastor, on the origin of foul-brood, 126
- Scott, Rev. F. P., his Sibertswold hive, 88
- Scraper, a, knife, and substitute for feeding shovel, 164
- Seasonable hint, a, 490
- Season, the, 1874, 81, 82
- Second swarms, utilising, 101
- Sectional supers, 202, 206
- Selected honey, 166
- September, 70
- Sherrington hive, 88; as it was and is, 109-111
- Shovel, feeding, 164
- Show, preparations for the, 29
- Sibertswold hive, the, 88
- Skep v. moveable comb hive, 157
- Slindon hive, the, 150
- Smith, C. W., his bee-palace, 88, 94; his Carr-Stewarton hive, 89; his Ligurian bees, 90; his bee-dress, 93; his bee-quieter, 93
- Smith, J., on Brazilian honey-bees, 155
- Smoker, a new, 15
- St. Aeddan and his bees, 102
- Stands for hives, 25; separate to be preferred, 193
- Starling, A. J., his honey-extractor, 93
- Stewarton combs, regularity of, how produced, 157
- Stewarton hive and system, 9, 101, 159, 194; mode of introducing queen into, 102; feeding in, *ib.*; width of its bars, 136
- Stimulative feeding, 161
- Stingless bees, 155, 173
- Stocks, dwindling, 28; equalization of, 46
- Storifying hive, 194
- Straw hives or skeps, 2, 16, 136; transference of contents to bar-frame hives, 24; fixing a crown-board on, 47; difficulties of, 53; at the Show, 90
- Sugar, crystallised and loaf, 86
- Supers, selection of, 2; glass, inconvenience of, 21; wood and glass, *ib.*; bell-glasses, 22; for Woodbury hives, *ib.*; cheap, 48; glass, 81; queens in, 83, 104; at the Crystal Palace, 103; for the honey market, 201; sectional, 202, 206
- Swarming, natural, 3; artificial, 3, 36, 42; prevention of, 42
- Swarms, hiving, 3, 198; feeding, 4, 25, 26; weight of, 10, 11, 29, 42, 48; value of, 30; nomenclature of, 40; removal of, 44; young, 53; utilising second, 84; length of their existence, 123; preparing bar-frames for, 198; catching, 199
- Symington, Mr., exhibition of his Cottage Woodbury, 89; his economical hive, *ib.*; his Ligurian bees, 90; his honey, 90, 91; on the extractor, 91
- Syrup, 74; can, 204
- Tasting honey, 124, 133
- Tinkling of bees, 3, 49
- Tobacco-smoke, 86, 127
- Transferring, 47, 48, 49, 50, 68, 124, 177
- Treacle, 159
- Trigona bees, 155, 173
- Tupper, Mrs., 158
- Turner, J. S., his bee-feeder, 92; his designs for bee-houses, 94
- Unicomb hive, bees in, in winter, 124, 209
- Uniting swarms, 47, 73, 97
- Various items, 83
- Ventilation, 107, 140
- Vulcanite, its superiority to zinc, 100; division-beards, 126; feeding-stages, 73, 100, 163
- Walton, J., honey exhibited by, 92; his honey extractor, 93; his bees' wax, 94
- Want and Sale Column, 106, 142, 160, 195, &c.
- Wasps, 74, 190; nests, destruction of, 98, 120
- Wax, bleaching, 98; pure, 169; how produced, 157, 171
- Wax-dust, 50
- Wax-moth, 12, 16; male, female, larva, cocoons, 12; combs destroyed by, 13; young of the, 49
- Wax-scales, 48
- Wax-sheets, 65, 85, 121, 157, 159, 211, 212; plates for impressing, 203
- Wax-smelter, 16, 37
- Wax-worms, how to cleanse a hive from, 86
- Wet hives, 144
- What not to do, 157, 172
- Windows in hives, 195
- Winter, preparations for, 97, 107
- Wintering bees, 161, 168, 187, 188, 208
- Wire-netting for holding pieces of comb, 194
- Wood or straw hives, 135
- Woodbury, Mr., on queen-cages, 154
- Woodbury bars, width of, 123; hives, 22, 135, 136, 164, 182, 199; supers, 22
- Woodpecker, the, its destructiveness of hives, 156, 172
- Would-be regicides, 192
- Wren, Sir C., and the Octagon hive, 46, 63, 170
- Yew-trees, honey from, 129
- Zinc, objections to, for queen-cages, 155

## CONTRIBUTORS.

- Abbott, J. A., jun., 150
- A. D., 152
- Adams, A., 39, 44
- Alpha, 58
- Apis Mellifica, 98
- Armstrong, John, 13, 39, 43, 64, 121
- Aston, R., 137
- A. W., 153
- Bee-Master, 83
- Bennett, D. D., 119
- Bennett, F., 46
- B. H., 192
- Bligh, Hon. and Rev. H., 40, 59, 114
- B. M. B., 157
- Brierley, S., 43
- Broughton-Carr, W., 27, 62, 166, 168
- Busy Bee, 191
- Carr, William, 12, 14, 61, 138, 155, 173, 188, 208
- C. C., 186
- C. E. P., 157
- Cheshire, F., 27, 45, 65, 76, 99, 190
- C. H. W., 43
- C. J. S., 40
- C. L., 64, 103
- Clutton, T. F., 42
- Cowan, T. W., 62, 82, 84, 185, 207
- Cridland, J. R., 11
- D., Deal, 205
- Deborah, 115
- Edwards, C. H., 139, 140, 155, 189, 190
- E. P., 45
- E. W., 141, 169
- E. W. S. R., 44
- F. C., 40
- Fielding, Col. P., 117
- Foreon, C., 57
- Ford, G. M., 209
- Fox, George, 135
- F. W., 139
- G. A. R., 156
- G. B., 84
- G. F. T., 38
- Greggery, R., 41
- Hampshire Bee-keeper, 187, 189, 207
- Henderson, G., 102, 133
- Herford, J. S. A., 155
- Hewson, Walter, 80
- Hodgson, C. H., 38
- Hodgson, J. F., 81
- Hooker, J. M., 133
- Hunter, John, 112, 121, 208
- Jackson, F. R., 120
- J. C., 15
- Jenner-Fust, H., jun., 82, 210
- Jones, J. C., 119, 122, 188
- J. S., 153, 206
- J. W. (Leamington), 60
- J. W. (Rochdale), 63, 156
- Lake Lancashire Bee-keeper, 141, 207
- Lanarkshire Bee-keeper, 9, 15, 60, 171
- Lincolnshire Apiarian, 82
- Lyon, E. D., 122
- Machell, H., 122
- Massey, H. B., 41
- Mechanical Bee-keeper, 120
- Middlesex Bee-keeper, 46
- Munn, C. Augustus, 29
- Murphy, R. R., 206
- North Riding Moors, 102
- Novice, a, 16, 28
- Pagden, E. T., 59
- Partridge, R. W., 210
- Perkins, G. F., 167
- R. W. P., 80
- Questioner, 14, 64, 122, 151, 156
- Raynor, Rev. G., 118, 153
- Renfrewshire Bee-keeper, 10, 63, 65, 84, 101, 102, 118, 136, 137, 154, 157, 170, 176, 191
- R. G. B., 81
- Rusbridge, A., 63, 83, 188
- Saddleworth Bee-keeper, 169
- Sibert-on-the-Wold, 29
- Sic vos non vobis, 40, 83
- South Lancashire Bee-keeper, 189
- Staines, 40
- Symington, R., 8, 9
- T. J., 41
- Torry, Joseph, 167
- Uncle Walter, 116
- Wade, Christopher, 82
- Walker, Geo., 132
- Warwickshire Bee-keeper, 42, 56, 169
- W. D., 46
- Welch-Thornton, H., 83
- Westbrook, 172
- Wood, J. S., 41, 78, 130, 134, 207

THE  
**British Bee Journal,**  
AND BEE-KEEPER'S ADVISER.

[No. 13. Vol. II.]

MAY, 1874.

[PUBLISHED MONTHLY.]

Editorial.

TO OUR READERS.

IN again tendering our services to the Bee-keepers of Great Britain, like a candidate for Parliament seeking re-election, we are fain to hope that the course we have pursued in the past will be accepted in support of our pledges of good faith in the future, and that our supporters will again rally round us, and by their *votes* and *interest* maintain us in the important position we have assumed.

Our *leaf-hive* for the current year differs in some degree from that of the past, in which so many willing workers have stored their knowledge and experiences, but will, we trust, be equally acceptable to bee-keepers generally. We regret our inability to make all the changes so kindly suggested by our many kind friends and advisers; but hope, in adopting those of the majority, we shall not be thought wanting in respect for the wishes of those whose suggestions we have been unable to follow, and that as a whole the improvement we have aimed at in our Second Volume will be accepted as an earnest of our desire to please. Our main object is the advancement of bee-culture, and this we hope always to keep in view; and while our friends support and protect us from pecuniary loss, no pains shall be spared in our endeavours to further its interests. We must, however, remind our readers that this is swarming-time, and as bees throng around their queen, and labour to enable her to increase her sphere of usefulness, so we hope bee-keepers, looking to the *British Bee Journal* as the common centre from which their interests derive the best support and protection, will swarm around us, and aid us in our efforts for the common weal.

MAY.

To the apiarian May is undoubtedly the busiest and most interesting month in the whole year. The winter may be considered safely past, and excepting the probability of a few slight frosts about the full of the moon, and perhaps a little of the boisterous weather which was due in March, but which has not yet paid us its visit in full, nothing appears likely to mar the promise of the year 1874 as one of the most successful in the annals of bee-keeping.

The months of March and April have been unusually kind and genial, and, as a consequence, the fruit-trees have put on their holiday attire earlier than usual, affording abundant pasture for the bees, and preventing the necessity for artificial feeding, except in isolated cases, or where stimulative feeding was thought desirable. Taken altogether, the season hitherto has been most satisfactory; and should there be no check, the crop of bees will vie in value with the grass crop, and, on the principle that

'A swarm of bees in May  
Is worth a load of hay.'

it is just possible that the bees may carry off the palm. There is an old maxim which says, 'Early drones, early swarms;' and as a rule it is correct, but it may happen that early drones are indicative of the presence of an unfertilized queen in the hive, in which case the hopes their appearance gives rise to are not likely to be realized; at any rate not with the hive at which such drones appear.

Every bee-keeper who intends to hive his swarms must beforehand determine on the kind of hive he will put them into, and in the present day while 'the battle of the beehive' is raging with unabated fury, the task of choosing the best is evidently not an easy one. Although fully convinced of the superiority of hives constructed on the moveable comb principle, whether they be wooden hives with the bar-frame arrangement, or straw skeps with open crowns and simple bars, as in 'Taylor's,' 'Fenn's,' and the Grecian hives, we simply argue in favour of the principle, that a hive which gives its owner command of the combs, so that he may see their

condition if he wishes to do so, must be more desirable and convenient than a hive in which the combs are fixed so that a fair view of them is impossible. Many intending bee-keepers seem to dread the adoption of moveable comb hives, because they imagine that in them the bees require much extra attention and manipulation, and thus the fear of being stung while operating prevents them obtaining the advantages accruing from their use; but the facts are otherwise: bees in a moveable comb hive are not likely to require more attention than they would if they were in a hollow log, which is perhaps the most primitive kind of hive known. But, supposing anything occurs to them which renders interference positively necessary—for instance, an attack of dysentery, the loss of their queen, the presence of too much drone-comb, a superabundance of pollen, innovation of the wax-moth, or any other of the ‘thousand natural ills’ with which bees are liable to be afflicted,—surely it will be admitted that in either case it would be more convenient if the hive be not closed against inspection. Again, it is of common occurrence for amateur bee-keepers, when in difficulties, to seek the friendly aid of some experienced bee-master—one who is not afraid to invade a hive and thoroughly examine and report upon its contents; but who can tell the measure of his disappointment, when, upon arriving at the scene, he is shown some straw skeps and asked to give a reason for their condition? He may suspect ever so many causes, but, being unable to inspect their interior, he can only guess at the truth. There are many cases where an experienced bee-keeper would at once see the cause of difficulty, as a physician would pronounce on jaundice, small-pox, measles, or scarlet-fever almost at first sight, but there are others where it would be as reasonable to expect him to diagnose a case in an upper story by looking through the ground-floor window. On the score of expense, the straw skep has been held to be the most economical, but that is now open to grave doubt, as bar-frame hives can be obtained at prices which challenge it to competition. Taking the ‘Pettigrew,’ and the ‘Yates’ skeps, of which we gave engravings in our July Number of last year by favour of Mr. Yates, which hives are the nearest to perfection in size and manufacture of any extant, the difference between them consisting only in the shape of their crowns, one of which, the ‘Pettigrew,’ is flat, while the ‘Yates’ is dome-shaped, it will be found, by comparison, that they are really the more expensive. The advertised prices of these hives vary from 4s. 6d. to 6s. 6d. each, and their floor-boards are quoted at from 2s. 6d. to 4s. each, bringing the hives complete to

prices varying from 7s. to 10s. 6d. each, whereas the last new 10-bar-frame hive for cottagers’ use is advertised in this *Journal* at 7s. 6d. only. Compare these again,—neither of which includes a super or honey-box,—with the Stewarton hive, which has just appeared, consisting of two stock-boxes and one honey-box (but no floor-board) at 12s. 6d., and we think it will be admitted that the moveable comb hive in point of economy compares most favourably with the inconvenient skep. We trust our observations in this respect will not be unfavourably received; we have no interest whatever in any of the hives we have mentioned, and except for purposes of comparison should not have given them what may be thought undue prominence; but, having in view the great exhibition which is apparently destined to make the year 1874 famous in the annals of apiculture, we think we should be wanting in our duty if the question of selection of hives was not fairly brought before our readers. We hope, with the exhibition in prospect, that every bee-keeper will register the date of swarming, weight of swarm, and size and weight of every hive used, so that any deemed worthy of being brought into competition may be fully and faithfully described, that statistics may be preserved which will aid the bee-keeping world in arriving at a fair estimate of the respective value of the various hives and systems in use.

Next to hives the selection of supers is of the first importance, and here again diversity of opinions as to number, size, shape, and material, renders it difficult for the amateur to make a satisfactory selection. It is very pleasurable to observe from day to day the progress of the work in a glass super, and hence the use of supers of that material is much favoured. We do not however recommend bell-glasses, or any that have glass tops, on account of the difficulty which bees have in attaching their combs to them. Supers with glass sides and wooden tops are far preferable to any others; they should also have thin wooden bottoms, to permit of easy removal without the necessity for breaking the combs,—an inconvenience which always occurs when supers have no bottom boards of their own. Those of the kind recommended in the June and January Numbers of the *Journal* may be protected against cold by wrappings of paper round them. When applied to out-of-door hives, in addition to the usual wrapping, an old skep placed over them will afford useful protection, which should also be covered with a protecting roof.

Bees have been breeding very rapidly indeed under the influence of the glorious weather with which we have been favoured during the

past month, and probably ere these lines are before our readers, the merry 'jingle,' which in rural districts is held to be so essential on the advent of swarms, will have been heard in many parts of our fruitful island. Can any one who has been present when the welcome news has been brought that 'the bees are swarming,' ever forget the scene of wild excitement that almost invariably ensues? Every occupation in which the household may be engaged is immediately abandoned, a great rush made for the possession of some instrument with which to 'finkle' them,—poker, tongs, and shovel; preserving-pan, saucepan, and dustpan; all the household gods, and goddesses too, are brought into active use, and the whole neighbourhood is aroused by the Babel of sounds thus suddenly created, while

'Up mounts the chief, and to the cheated eye,  
Ten thousand shuttles dart along the sky;  
As swift through æther rise the rushing swarms,  
Gay dancing to the beam their sun-bright forms;  
And each thin form, still lingering on the sight,  
Trails, as it shoots, a line of silver light.  
High poised on buoyant wing, the thoughtful queen,  
In gaze attentive, views the varied scene,  
And soon her far-fetch'd ken discerns below  
The light labouring lift her polish'd brow.  
Wave her green leafy ringlets o'er the glade,  
And seem to beckon to her friendly shade.  
Swift as the falcon's sweep, the monarch bends  
Her flight abrupt; the following host descends,  
Round the fine twig, like cluster'd grapes they close,  
In thickening wreaths, and court a short repose.'

EVANS.

The tinkling of bees is a very old custom, probably of little use as a means of inducing them to alight near by, but under any circumstances it is harmless; and as it pleases those who resort to it, and affords occupation at a moment when every one thinks he 'must be up and doing,' very little need be said against it. Those who are 'to the manner born,' have the strongest faith in its efficacy in causing the bees to 'settle,' while others have no faith in it whatever, never use it, and are about as successful as those who do.

When a swarm has 'settled,' no time should be lost in hiving it, and placing it upon the stand it is to occupy, if it be near the clustering bees; but if they are to be sent to a distance, it would be well to allow the hive containing them to remain on the ground at only a short distance protecting them from the fierce heat of the sun by a sheet or an awning of some kind temporarily thrown over them. It is not always safe to shake the clustering bees into the hive in which they are to remain, as it is possible to crush the queen in setting it on the ground, or floorboard. The safest plan is that usually adopted when hiving bees in bar-frame hives, viz., set the floorboard on the ground, cover it with a large sheet,—a newspaper will do; place the hive upon the floorboard, and raise the front

of it about an inch, by placing pieces of wood under its corners (if it be a circular skep, it should be set on a *strip* of wood), then take a vessel of any kind, a tin, or galvanized iron pail, is one of the most handy, shake the bees into it, carry them to the hive, and pour them down on the sheet in front of it, when if the queen be with them they will enter in triumph, and in ninety-nine cases out of a hundred will stay there; and any stragglers left near the clustering point, missing their queen, will soon join the main body, attracted thither by their jubilant humming, and when all have ascended and are quiet, the sheet may be quietly withdrawn. Should the queen not have been captured on the first attempt, the bees will return to the tree or shrub, when a second or third attempt will probably prove successful. When a queen is killed in setting the hive containing the swarm on its floorboard, the bees will not immediately leave her, but will remain with her for a considerable time, but they will be sure eventually to desert the hive, perhaps after having built one or two pieces of comb in it, and will return to that from which they first issued.

The natural swarming of bees, although one of the most charming phenomena in the economy of nature, is too uncertain in its operation to be suffered to any great extent by the professional bee-master. Watching, and waiting for the peculiar state of atmosphere which will induce them to come forth, are too expensive and wearisome to him whose time is of great importance, and hence among experienced bee-keepers artificial swarming is generally resorted to; which process not only removes the necessity for watching and waiting, but when properly carried out prevents also great waste of time and labour by the bees, dispenses with after-swarming, and brings the apiary under direct control, subject of course to the variations of the climate, by which everything mundane is influenced. Artificial swarming has been so fully described in former numbers of this *Journal*, that repetition of the whole process would be wearisome; but it may not be out of place to remind our readers that the gist of the whole matter lies in preventing the waste of time usually occupied by individual hives in swarming condition, in raising queens for themselves. In every apiary there are usually two or three stocks in advance of others; and where it is intended that swarms shall be obtained, without regard to breed of the bees, the strongest should be swarmed artificially as soon as drones begin to make their appearance; and about ten or twelve days afterwards, when the number of queen-cells is ascertained, other stocks may be similarly treated; and two days further on, queen-cells should be cut out of the hives first

swarmed, and spliced, one each, into the combs of those last so treated, fixing them in the warmest part of the brood nest.

These operations are not so easily performed, nor are they so likely to be successful, with hives containing fixed combs as with those in which they are moveable, but a sufficient number of queen-cells may be found available amongst the *crookedest* combs of the most inconvenient hives to make them both practicable and profitable.

Hives from which swarms have departed should have their entrances contracted for a few days; as should also those in which new swarms have been hived, so that the heat generated in them may be economised; otherwise, should a few days of chilly weather ensue, the hatching of brood in one, and the secretion of wax for the formation of comb in the other, may be hindered, or prevented altogether, when both will be sure to suffer.

It will be found profitable to feed swarms and casts of all descriptions, to enable them to fill their hives with combs, while they are under the influence of the swarming and comb-building impulse. A swarm which receives a check at this peculiar time, rarely recovers its tone, and is seldom a profitable one to the bee-keeper.

#### CRYSTAL PALACE BEE-SHOW.

THE amount subscribed to the Prize fund of the Crystal Palace Bee and Honey Show has gradually increased to upwards of seventy pounds; but we must remind our readers that to carry out the Show in the liberal spirit suggested in the proposed schedule of prizes, a hundred pounds at the least will be required. The said schedule has been most unkindly reviewed by certain writers in the *Journal of Horticulture*, whose object has evidently been to damage the interests of the Show; but we are willing to believe that their objections, instead of injuring the cause, have had quite the contrary effect.

To a correspondent, whose kind and courteous letter appeared in that *Journal* on the 2nd of April last, we feel that our thanks are due, for the dispassionate way in which he placed the whole matter before its readers. To his objections to the Schedule, which are made in the most gentlemanly spirit, we feel that it would be uncourteous in us not to reply; therefore, taking them in the order in which they appeared, we feel it necessary, in the first instance, to allude to the straw skep, which he 'cannot help thinking . . . is all but thrown overboard.' Now in the Schedule there are six classes for hives, for the most improved of which, in each class, a prize of two pounds and a certificate of merit will be awarded, and

one set of these prizes *must* be won by the 'most improved skep, or box-hive (used) for depriving purposes;' and in the other classes, C, D, E, F, for hives, there is nothing to prevent competition by the straw skep. Straw skeps may be made square, and fitted with bar frames, as in the Sherrington hive, which will be no mean competitor for honours, and which, having a flat top, cannot be objected to by the staunchest Pettigrewian. It (the skep) can be adapted to the storifying principle, and would, if the attempt were made, run hard against the Stewarton, on its merits; it can be used on the collateral system, as many old woodents will prove, and it can be fashioned into the best and cheapest (most economical) moveable comb hive for cottagers' use, and yet we are accused of throwing it 'overboard.' That the straw skep is not 'thrown overboard,' the classes which deal with results will testify. Those for honey are nineteen in number, and excepting one which disposes of 40s. for honey obtained by the use of the extractor, the whole of them are open to be competed for by the votaries of the straw skep, without the slightest attempt at handicapping.

*There is not a single word in the whole Schedule which makes the least invidious distinction between one hive and system, and another; but the object as intended is to bring all of them into one grand competition, and to let results speak for themselves.* Those who complain that the skep is slighted, will perhaps oblige us by showing in what way they would like to see it more especially recognised.

The next objection is, 'With regard to the prizes, I think they are cut up too small,' and here we must beg to differ with our courteous critic; we believe that prizes cannot be sown too widely, and if they be not cut up small it is evident there must be fewer of them. We shall be very glad if those who think the prizes should be larger will help to make them so; but at present the funds do not warrant them being so large. We would remind our friends that the Schedule is based on the assumption that a hundred pounds will be collected; and if we can be shown a better way of distributing such an amount, we shall be exceedingly obliged. We do not think the chance of winning a few prizes of five pounds would induce more entries than will the chances now offered; indeed, we do not attach a vast importance to the prizes at all. They are sufficiently valuable and numerous to pay the expenses of the successful exhibitors, and the honour won will be the real reward, but we pin our faith to the *establishment of a Honey Fair* as the best guarantee of the future success of the undertaking. Pure honey is always in demand; there is plenty of it in the country,



but there is no market where it may be bought and sold in quantity, no regular outlet for it, and, consequently, as a source of income its acquirement is not sufficiently regarded. When once a market is created, we have little doubt but that the demand and the supply will rapidly increase, and the numbers of bee-keepers multiplied manyfold.

Class Q is the next objected to 'for the best exhibition of honey obtained by the use of the extractor,' to which ought to have been added, *the produce of one stock of bees*; and if by the use of the extractor it can be shown that three or four times the quantity of honey can be obtained over what is produced without it, we think its use ought to be encouraged, or, at any rate, that in such an exhibition its merits should be fairly tested. Our respected critic thinks money ought not to be voted from public subscriptions for such a purpose; we reply that the purpose was announced before the public subscriptions were sent, and that a radical departure from the 'programme' may give offence to some of the intending subscribers, and thus prove injurious.

Last, but not least in importance to the bee-culturist, are the 'Essays.' It is admitted that the fertilization of queen-bees by selected drones is a matter of uncertainty, but it does not follow that it will remain so; and if by offering so small a prize, compared with the importance of the object, the minds of skilful observers are brought to bear on the subject, it is possible that a means may be discovered by which the object sought can be attained.

'Foul-brood' is the name given to *the disease* which causes rottenness of the bees while in their embryo condition, and the prize is suggested for the best essay on the cause and cure of *that disease*. We are not so wide of the mark as to imagine that dead and rotting brood can be restored, and do not use the word 'cure' in that sense. Small-pox in humans like foul-brood in bees, is a germ disease, and in both instances it is, perhaps, the best policy to bury the dead instantly, and burn the bedding and clothing of the one, and the *cells* of the other, to prevent the spread of the contagion; but would it not be the height of presumption and folly to forego further investigation of the disease called small-pox, because a *charlatan* chose to say that 'there is no cure for it,' and that 'the cause is equally beyond the ken of mortals?' We have no patience or sympathy with those who believe in 'finality' with regard to things mundane, and who would sit still and endure, rather than strive to better their condition and that of their neighbours.

We must, however, leave the whole question to be dealt with at the meeting of subscribers which it is proposed to hold during the present

month. We respectfully and cordially invite all those who are then subscribers to the Prize Fund to attend a meeting at 168 Camden Street, N.W., near the Camden Station on the North London Railway, on Saturday the 16th instant, at four in the afternoon, when we hope not only to revise the proposed Schedule of prizes to be offered, but to lay the foundation of a National Association for the Promotion of Apiculture.

## THE QUEEN AND HER PROGENY.

In our former article on this subject, we pointed out, that if an egg, in its passage down the oviduct, escaped the influence of the fluid in the spermatheca, it would in the ordinary course become a drone, '*which partaking only of the nature of the queen mother, would be of her standard of purity.*' This, although generally accepted as a fact, is questioned by some eminent apiculturists. It is undoubted that the eggs which are deposited by an impregnated queen in drone-cells, pass the spermatheca in exactly the condition in which they leave the ovaries, whereas those deposited in worker-cells will have almost invariably come into contact with, and have absorbed, some portion of the spermatheca fluid contained in the spermatheca, and hence will become workers. We say *almost invariably*, because very occasionally an egg may be deposited in a worker cell without coming into contact with this fluid, in which case the bees do not remove it, but allow it to develop into a drone, to make room for which they elongate the cell until it is nearly one-half longer than usual.

The theory which explains the wonderful phenomenon is, that the production of drones and workers by fertilized queens, *i.e.*, the determination of their sexes, is purely mechanical, depending upon the sizes of the cells in which the eggs are deposited. Thus a drone-cell is large enough to allow the body of the queen to be inserted into it, and the egg to be deposited, without causing the slightest pressure upon her body through enforced contact with its waxen walls, and hence the fluid in the spermatheca is not discharged against the egg as it passes the orifice in the oviduct, on its way to the point of deposition; consequently the egg is said to be unimpregnated, and can only produce a drone. On the other hand, when the body of the queen is inserted into a worker-cell, the effort made in extruding the egg *does* cause pressure of the body against the sides of the cell, and the fluid in the spermatheca is forced into contact with the egg as it passes along the oviduct, and under its vivifying influence the egg will become a worker, or a queen-bee. The difference

in the sizes of the cells is capitally displayed in the accompanying engraving, which represents

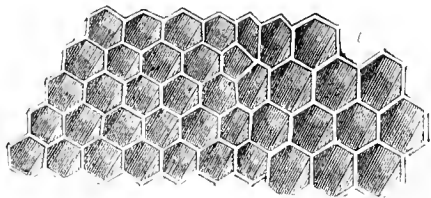

those of both drones and workers (with a few intermediates), by observing which the foregoing statement may be more easily understood. There is, however, considerable doubt in the minds of many observing beekeepers, whether this theory of the production of drones is absolutely correct. If it be, the drones of pure Italian queens would be always pure alike, no matter how they may have mated; but there are few breeders of that race of bees who are perfectly satisfied that such is the case.

Mr. John Lowe, an eminent Scotch apiarian, in his *Observations on Dzierzon's Theory of Reproduction in the Honey Bee*, 1867, gives several powerful reasons for believing that 'Dzierzon was in error in supposing that the drones of pure hybridized queens always partook and followed the race of the mother; otherwise,' says he, 'I could not account for the many anomalies brought out in my experiments.' The question is a very complicated one, because there is no true standard by which the character of drones may be judged. Colour is a fair test of purity in worker-bees, indeed, uniformity of colour, without regard to special beauty, may be accounted conclusive in that respect.

In the proposed Schedule of Prizes to be offered at the Crystal Palace Show in September next, one prize is suggested 'for the most beautiful breed of Ligurian bees, the progeny of the queen accompanying them, the beauty of the queen to be of secondary importance;' and for the latter proviso we have been held up to ridicule; but let us see what Mr. Lowe says on the subject: 'If colour be the expression of purity as regards the queen and drones, I confess my inability, according to my experience, to determine on all occasions the perfect purity of either.' In his experiments with hybridized Egyptian queens, he found they produced drones of varied character; 'some tolerably well marked, and others very badly marked.' Of three hives containing pure Egyptian queens, and then (1867) producing drones, not one produced either male or worker bees equal to the original stock, the drones in some measure corresponding in their markings with the marking and colour of the workers; 'that is, the queen which produced the worst

workers produced the worst marked drones, and the queen which produced the best workers produced also the best marked drones. One of the queens, which had evidently been hybridized by a Ligurian drone, as the workers were very beautiful hybrids, produced some drones almost equal to those of the original queen, some very poorly marked, and some partaking more of the Ligurian character.' Now, if this be so, and no one can for a moment doubt the strict truthfulness and impartiality of Mr. Lowe's observations, it follows that the drone progeny of a queen-*bee* is influenced by the character of the drone with which she may happen to have mated, although the eggs in her ovaries from which the drones are raised have never been in actual contact with the life-giving fluid obtained during the wedding flight, and hoarded in the spermatheca. 'The important fact,' he truly says, 'is, that these pure Egyptian queens, being hybridized, produce hybrid males as well as hybrid females.' This is, indeed, an *important fact*, but one which few, on account of the comparative scarcity of the Egyptian race of bees, have the opportunity of testing. It must be conceded that it is not at all times easy to determine the purity of race in drones, even when they belong to hives containing the purest Ligurian queens and workers, and in this respect Mr. Lowe says: 'I do not well see that perfect accuracy of results, in this question, could be obtained by aid of the Italian bee, inasmuch as the pure Ligurian drone *sometimes* so nearly resembles the English drone, that purity is often difficult to determine.' From this statement, the truth of which must be well known to every breeder of Ligurian bees, it seems absolutely impossible to verify the theory of Dzierzon, the test of purity being so likely to fail; but if we turn our attention in another direction we may perhaps find evidences which will go far to prove Mr. Lowe's deductions.

The great John Hunter quotes from Schirach: 'A young queen lately hatched was put into a hive which had been previously ascertained to contain no drones, and whose queen was removed, and yet the young queen laid eggs;' upon which he remarked, 'There is no mystery in this, but did they hatch?' and taking it for granted that they did hatch, and became living drones, we ask now, Is there any proof that such drones have the power of fertilization sufficiently developed, to render them in any degree serviceable in an apiary? It has long been doubted by many clever American apiarians whether the drones produced by fertile workers have sufficient power to propagate their species, and it occurs to us that the drones produced by unfertilized queens may be equally impotent. Langstroth cites a case (p. 244, note) where some young queens, hatched late in October

1856, had failed to obtain impregnation, although drones continued in existence until after the 1st of November; and when examined on the 21st of February, 1857, they had each *a few sealed drones and larvæ*, while weaker stocks had much brood.' He says, 'These drone-laying colonies were supplied with queens from other stocks, which, when opened, were found to have raised queens in February. One queen was laying worker, and the other drone eggs, and the former must have been impregnated in March, and probably by some of the brood of the drone-laying queens.' 'Probably' is the word here used, but we think it equally possible that some of the drones which existed after the 1st of November continued in the unfertile hives during the winter, and gave their services to the young queens which were hatched as stated in the February ensuing.

The statement that on the 21st of February the unfertile queens had each *'a few sealed drones and larvæ'*, while weaker stocks *'had much brood'*, is so highly suggestive that it deserves considerable attention. In the first place, if fertilization by a drone is not essential to the proper fecundity of a queen, why had not the unfertilized queens, in the case before us, shown equal fecundity with those of weaker stocks *which had much brood?* Why will a fertilized queen commence ovipositing when not more than a few days old, whilst one unfertilized will not do so for some weeks, or months, and then only in a very moderate degree, if at all? We do not go so far with Mr. Lowe as to think fertilization, necessary to the production of drones, but are inclined to think that those produced, whether by workers or queens, without fertilization are abnormal, and have not the life-giving power essential to the propagation of their species. We hoped to have been enabled to experiment in this direction with the eggs and progeny of the fertile worker which we described in a former number; but the fates were against us, for the sharp frosts which occurred in March destroyed not only the drones, but the workers also of the stock, which had evidently become exhausted by its fruitless task of raising them. The fact, however, of a pure Egyptian queen, hybridized by a Ligurian drone, producing hybrid drones, is one which remains to be accounted for; and the endeavour to do so, indeed, the acceptance of the fact itself, necessarily involves a suggestion of a flaw in Dzierzon's theory of reproduction, which is unmistakably based on the principle that the eggs which develop into drones partake only of the nature of the queen mother, and receive none of their vitality from the drone with which she may have mated. Mr. Lowe very keenly observes, that 'if the egg, as asserted, brings the

germ of male life with it from the ovary, and is spontaneously developed into a perfect being, independently of fecundation—for,' says he, 'I suppose a drone, notwithstanding Dzierzon's assertion to the contrary, is as perfect a bee as a worker or female—then the action of the spermatozooids upon the egg must not only incite in it a new development, and awaken therein the germ of what is described as "a more perfect being," namely, a queen or worker, but it must also *destroy* the germ of male life which it originally contained, and put in its stead a new being completely different in size, sex, and character. This, indeed, is a wonderful metamorphosis, but it is one which scientific investigations profess to reveal.'

When it is remembered that in animals impregnation does really effect changes in the constitution of females, we hope we may be pardoned if we believe that similar effects may be so produced in insects. It is on record that a white female pony having borne a foal by a male zebra, afterwards gave birth to others with zebra markings; and it is in the knowledge of most professional poultry-breeders, that a pure white hen which has mated with a cock of black Spanish breed never afterwards produces a brood of pure white chickens. In cattle, dogs, rabbits, &c., the same physiological facts have been observed; indeed, in all animals it is so apparent that breeders look upon those which have been crossed with impure blood as unreliable for future pedigree purposes. Not to dilate on this subject, the mention of which will be sufficient to bring thinking minds to the consideration of the question at issue, we think we may venture upon a hypothesis, that the seminal fluid in the spermatheca of the queen bee, while it quickens herself and conduces to a more perfect development of her fecundity, is in some way absorbed into, or has such subtle effect on her circulation as to imbue her with the nature of the drone whose life was forfeited in imparting it, making the twain one. Except on some such hypothesis it is impossible to recognise the fact set forth by Mr. Lowe 'that a pure Egyptian queen, being hybridized, produced hybrid males as well as hybrid workers,' or to reconcile it with the wondrously beautiful theory of Dzierzon.

---

*Fertile Workers.*—Fertile workers are not usually very prolific, many of them scarcely laying a hundred eggs each in the course of their lives, when placed in the most favourable circumstances. The brood, consequently, is irregularly disposed of in the combs. But Berlepsch says he knows of one instance in which such a worker was highly prolific, the brood filling an entire comb, and being compactly placed in the cells.

## Correspondence.

\* \* \* These columns are open to Subscribers, so that their queries, replies, correspondence, and experiences, may be fully and faithfully recorded; and for the discussion of all theories and systems in the culture, and of the relative merits of all hives and appurtenances, that the truth regarding them may be ascertained. The Editor, therefore, must not be expected to coincide with all the views expressed by the various writers.

### THE CRYSTAL PALACE APICULTURAL EXHIBITION.

I enclose you a copy of a letter that I sent to the *Journal of Horticulture*, in reply to Mr. Bagshaw's letter in the March 26th issue of that publication. A request that no alteration or excision should be made which might change the meaning, sent with my letter, may explain why it was not inserted.

Will you kindly give it publication in your next issue, and also the following correction and addition to my letter which appeared in the *Journal of Horticulture* of March 19th? In last paragraph my words were, 'For the best essay on the cause and eradication of foul brood,' and not as they appeared, 'For the best essay on the cure and eradication (prevention) of foul brood.' I can understand 'cause' being mistaken for 'cure'; but why the word 'prevention' was added I am at a loss to imagine.

My concluding sentence, which was omitted altogether, was: 'I hope there will be still more criticism of the published schedule of prizes for the Crystal Palace Show, but in a better spirit and with more enlightened views than those evinced by your correspondent. It is not captious criticism that is invited, but the criticism of those desirous of seeing the exhibition carried to a successful issue; and for any amount of the latter, I feel sure that the Committee will be thankful.'—R. SYMINGTON.

In reply to my letter in the *Journal of Horticulture* of March 19th, Mr. Bagshaw asserts that his letter was not intended to injure honourable or profitable apiculture—and I never said it was—but I then held the opinion, that his criticisms upon the schedule of the proposed show at the Crystal Palace as published in the *British Bee Journal*, were intended to injure the prospects of that show, by trying to prove it was inaugurated in the interests of fancy hive makers, and dealers in and breeders of bees; and many remarks in his reply confirm that opinion. He may not wish to hinder honourable and profitable bee-keeping as it now exists, but he shows a desire (through ignorance as he expresses it, I have no doubt) to hinder any advancement.

Mr. Bagshaw may be of opinion that straw skeps cannot be improved upon as a means to the greatest success in bee-keeping, but others may differ with him in the opinion he holds; and if men of experience, they may be quite as much entitled to credence and respect as is Mr. B. Why, then, should he dogmatically assert, that he is right and all others wrong?

The offer of prizes for each and every kind of

hive and its product is no doubt intended to bring all into competition, and so give bee-keepers at large the opportunity of judging for themselves as to which hive has, for the present year at any rate, produced the best results. This will make them independent of the many assertions as to which is the best hive and system, as all these will be represented, not by theories, but by facts.

It seems to me, that the schedule as proposed is far too comprehensive for Mr. Bagshaw's ideas, and no doubt he would rather have seen it framed after the Manchester pattern. But as befits the times, its promoters have evidently been desirous of bringing to light every known hive and appurtenance, as at present used in apiculture, so that each may stand or fall by its merits. Criticism upon the schedule certainly was invited, but I imagine that such captious criticisms as those of Mr. Bagshaw were not desired.

Mr. Bagshaw speaks of what can be done with such a handsome fund as 100*l.*, but if he had carefully read the source of his information, he would have learned that the fund, like the schedule, was prospective; and up to the present, barely 50*l.* has been advertised as having been promised.

So far as I can gather, there is not evinced in the published schedule any desire to compel, or even recommend, the use of any particular kind of hive, but only to give the opportunity of deciding upon the merits of all by fair and open competition; and should the straw skep prove itself the best, I am very confident that the honours will be as freely conferred upon that as they would be upon any other.

Mr. Bagshaw cannot say that the straw skep has any hindrance thrown in the way of its competition, and he has the chance, if he has the will and power, to distance all comers, in classes A, B, D, and E, in hives, and in Classes A, B, C, D, E, F, G, H, I, J, K, L, M, N, O, and P, for honey.

Surely, this is a good enough opportunity for ratifying his opinions as to the advantages of straw skeps and brown bees, and one that will carry more weight with it than any amount of published assertion.

I contend that a moveable comb hive of *some* kind combines the most advantages, and, having commenced bee-keeping with straw skeps, have some little experience to guide me. Has Mr. Bagshaw tried moveable comb hives in comparison with skeps? If not (and he does not say he has), what grounds has he for so confidently asserting the immense superiority of the skep? A bar and frame hive is not necessarily a 'fancy hive,' and good serviceable hives can be made for the price he has named as the proper cost of a hive, 7*s.*

What experience has Mr. Bagshaw of Italian queens and bees that he imagines the value of a handsome queen is more than that of a plain-looking one? My experience teaches me that the queen producing the best strain of bees is of the highest value, irrespective of the appearance of the queen herself.

As to my remarks upon bees of any nationality, my omission of the Egyptians was of little importance, as I only wished to show that the words, 'Any nationality,' included all bees under cultivation.

I never asserted or believed, that like did not produce like, excepting as between the queen mother and her progeny; for there is no doubt but that all queens raised from a common mother, although they might differ in appearance, would, 'if fertilization could be controlled,' produce progeny alike in appearance and character. In replying to my remarks upon Class Q Mr. Bagshaw ought in fairness to me to have quoted *in extenso* from the letter he refers to, for I there stated, 'that although not quite so valuable as run honey, the difference being only a few halfpence per pound, the balance was heavily in favour of the extractor.'

In making this remark, it appears, however, that I was mistaken; as I find upon reference to the honey market reports in the last number of the *American Bee Journal*, that extracted honey is quoted in Chicago at 14 to 16 cents per pound, whilst strained or run honey is only valued at 10 to 12 cents. The honey which commands the highest price in the American markets being box honey, or what we call virgin honey in comb.

Mr. Bagshaw might also have quoted what I stated had been done with the extractor, namely, that 600 lbs. had been obtained by its use from one hive alone in 1871.

Has the straw skep ever given such a harvest as that either in this or any other country?

Surely this is a good and sufficient reason for encouraging its introduction and use, by the offer of a special prize for the best harvest obtained by its means.

I *did* conclude that Mr. Bagshaw was against any improvement, or why should he try to prejudice the coming show?

There is no 'puffing off' of any improvements, or anything else, in the schedule, but prizes are offered for the *production of any improvements beneficial to apiculture generally.*

I do not wish to try to teach Mr. Bagshaw anything, as that would be presumption on my part; but if he decide to exhibit his produce at the Crystal Palace in September, no doubt we shall meet in competition, and if he prove with his skeps the better man, I will congratulate him heartily, and shall be anxious that he may teach me how it is done.

Until, however, he *proves* his assertion, he must allow me to doubt the statement he makes.

I think it is only another proof of Mr. B.'s ignorance, that he imagines there is 'only one way, if any at all, of controlling fertilization,' and must let that matter rest there for fear of occupying your time and space.

Mr. Bagshaw has evidently no knowledge of foul brood, or he would know that it *is* infectious; if, however, he desires a lesson upon that point, let him expose a comb of honey obtained from an infected hive to his bees, and it will teach him one he will not soon forget.

In concluding, he invites a public trial on fair and equal terms between his brown bees in Pettigrew's hives and any other nationality of bees in any other hives; and yet he unfairly criticises the means to the end he desires. Why is this?

If such a trial as the show offers him will not suit,

will he accept such a challenge and upon such terms as the one given by Mr. Abbott, in the columns of the *Journal of Horticulture*, to Mr. Pettigrew?

Whilst so strongly upholding the skep against all comers, let me remind Mr. Bagshaw that the prize 'Crystal Palace' at the Manchester show was filled on a bar frame hive, and also inform him that the forty-pound glass super exhibited by Mr. Pettigrew was commenced, and partly filled on a *square box* hive in 1872, and an attempt made to complete it on a straw skep in 1873. He may thus learn that the Pettigrew skep and the box hive are not quite so far apart as he imagines they ought to be.—R. SYMINGTON, *March 19, 1871.*

### SPURIOUS HONEY.

Now that the deceptions at the Manchester show have been pretty well exposed, let me here advise all managers of exhibitions of honey hereafter to hand all future delinquents over to the police or fiscal of the county, as their due deserves; and expel them for ever from every exhibition. And let me here ask the assistance, in their respective districts, of all who have power to detect the adulteration of food, to prosecute any person who may be found guilty of so mean and debased an action, as palming off adulterated honey as genuine. And let me also warn all dealers in honey to be careful of whom they purchase their stock, and to get security that they (the producers) will bear all expenses if adulteration be discovered, for rest assured that it will not be allowed to escape easily. I have already hinted the thing to the proper quarters in Glasgow, and for myself, so far as my supervision extends, I will not allow a single case to escape; yet, nevertheless, I hope that no case of a serious nature will occur, and that the Italian warehouse windows in Glasgow will assume their pristine beauty in 1874, by being well filled with supers of the pure nectar from clover, bean, or native heather, and that *Manchester manufacture* will never cross the Tweed.—A LANARKSHIRE BEE-KEEPER.

### THE STEWARTON HIVE AND SYSTEM.

Having already dilated at full length on the Stewarton hive and system, its origin and manipulation, in the first volume, it is my intention in the second to supply some descriptive sketches of accessories to that hive, such as the original pedestals, and the floor-boards on which my octagon colonies rest, together with the style of hive-cover by which they are protected, and meantime subjoin a sketch of my first design of a cover; but before going into details, would seek to dismiss the controversial matters connected with it, into which I was unfortunately dragged.

After the editorial note of last month, it is with much reluctance I again refer to that controversy, and certainly would not have done so, were it not that your correspondent, Mr. Wm. Carr, seems prone to misrepresent my opinions: a 'shallow six-inch

stock box' I never employed, much less advocated; consequently, his continuous harping on the point is beside the mark. The generally recognised depth of a Stewarton Colony is 18 inches of breeding space; whether the sectional divisions be 2 at 9,

3 at 6, or 2 at 7 inches, with a 4-inch eke, or the combs the full 18-inch deep stretch in one, as is the case with several of mine, is a matter of minor importance, so long as we obtain that full area of comb, the slides throwing the several divisions into one hive.

I do not think your correspondent's prophecy, of my abandoning the octagon for the square form of hive is likely to be soon fulfilled. Having begun with the latter, and finding spring after spring the octagon colonies so much in advance of the

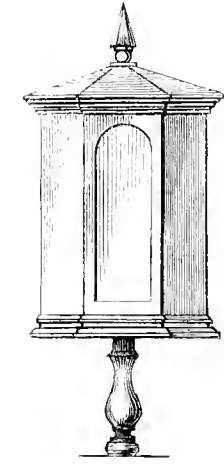

square, these last were gradually consigned to the lumber-room, and are now only occasionally and temporarily employed during the full press of the working season.

That Robert Kerr invented the hive known to us as the Stewarton I had on the best Ayrshire authority before publishing the fact, and on the same page showed I was not ignorant that other and ruder octagon colonies existed more than two centuries ago, and have since abundantly proved that my reviewer was in error in attributing their invention to Rusden, as he did in the December Number; he (Rusden), as I have already shown, was but the dispenser of licenses for Geddie's patent. Neither was the invention that of the patentee, as we have, from the letter of Sir Christopher Wren reprinted by Milton, undoubted proof that the great architect claimed the invention, and had the identical octagons in operation twenty-two years before Geddie obtained his patent, which was subsequently illustrated in Geddie's, Rusden's, and Thorley's works.

Your correspondent, in reply to Mr. Symington, says, 'I cannot see a word in my February note, that complains about anybody using any *nom de plume* they like,' while, with amusing inconsistency, his pen still refuses to write that of the present writer.

I must positively disclaim the correctness of Mr. Carr's inference, that 'In last month's Journal your anonymous correspondent explained why he erroneously made such a personal attack on me,' he seems oblivious to the fact he was the assailant, not I, my duty being simply to defend my position. On the same page with my reviewer's adverse criticism was heralded the advent of a new hive, bearing his name, linked with that of the well-known Stewarton; and although the thought may not have unnaturally occurred to me, as it did to others, the acerbity of this attack on the older hive might be partly accounted for by a paternal interest in his namesake; and the more so, when I found, at page 136, an esteemed correspondent express the opinion, 'And

now we have Mr. Carr condemning the principle of these hives, and trying to palm off an inferior one, as possessing all the advantages of the famed Stewarton's,' which remained unrepudiated by Mr. Carr. It did so look, but remembering the force of our Scottish proverb, that 'Like is an ill mark,' did not give expression to the thought, beyond hinting, that there might be some peculiarity about the 'Carr-Stewarton,' that my reviewer there might expect the bees' instincts, agreeably to his inelegant expression, to 'give the lie to' their previous undeviating procedure. But so soon as it came to my knowledge, that Mr. Carr was uninterested in the new hive, I felt it would be a graceful act, on the part of his opponent, to publicly disabuse the minds of those who had entertained such a suspicion; and I really regretted to find last month, that whatever little generosity there might be in the act, unappreciated by Mr. Carr, and my motive misconstrued by him. All '*personal*' allusions in this controversy I have studiously avoided, as foreign to the subject on hand, and have made no boastful allusions to the extent of my Bee Library, nor have cared to inquire into the isolated greatness of him who is 'perfectly independent of all in every respect.' Whatever may be our respective positions in life, or standing in society, I presume we all meet in the *British Bee Journal* on a common level, and I have no doubt our Editor wishes to treat all his contributors and correspondents with as much impartiality, and place all on as perfect an equality, as the workers of the hive, his interest being chiefly centred in the loads we monthly bring to enrich the common store; and in so doing Mr. Carr is to me, as to the most of your readers, but a Lancashire, and the present writer

A RENFREWSHIRE BEE KEEPER.

#### VARIATIONS OF WEIGHT IN A COLONY.

In accordance with your wish, I beg to send you herewith a copy of the journal in which I have recorded the weights of the hive which I have hung upon a Salter's balance; the swarm, which, as you will observe, came on the 30th June, was a pretty good one, and came from a hive which was doomed—it having foul brood: the swarm, however, has not shown any sign of the disease, but has worked vigorously, having built eighteen combs  $8\frac{1}{2}$  inches by  $7\frac{1}{2}$ , and collected a sufficient supply of honey, although not as much as I had expected. Of course a great quantity of the honey has gone to form the wax-combs; this, I suppose, is the only way to account for the days on which the bees appear to have kept holiday, no increase in weight being apparent. The bulk of their winter provision was collected in about twelve days while the lime was in bloom, and quite immediately afterwards the weight began to decrease.

I shall continue to take the weight with increasing frequency as the season advances, and I shall be very pleased to send you a continuation of the journal if you wish it.

N.B. The empty hive weighed 10lbs. and the swarm placed in it  $4\frac{1}{2}$  lbs., together  $53\frac{1}{2}$  lbs.

Date, 1873.	Weight, lbs.	Weather.	Wind.	Thermometer, lowest to highest, Reaumur.	Prevailing flowers.	Remarks.
June 30	53½	Clear.	E.		Raspberry.	Fed with honey and water.
July 1	—	Rain all day.	"	8° to 10°	Wild Mustard, &c.	" " "
2	—	Rain and thunder.	E.N.E.	8 " 10	with Borago.	" " "
3	54	Hazy.	"	12 " 18		
4	54½	Clear.	S.E.	12 " 20		
5	55	Thunder showers.	S.W.	10 " 15		
6	55½	Hazy.	S.E.	10 " 18		
7	56½	Clear.	"	8 " 22		
8	57½	"	N.W.	11 " 20		
9	59	"	W.S.W.	12 " 25		
10	"	"	"	" " "		
11	60	Hazy.	S.S.W.	10 " 15		
12	60½	Thunder shower.	E.	" " "		
13	60½	Hazy.	"	8 " 20		
14	"	Clear.	S.	8 " 18		
15	"	Rain all day.	N.E.	8 " 15		
16	60½	Showers.	S.W.	" " "		
17	"	Hazy.	W.	8 " 17	Borago and various.	
18	61	Rain.	S.E.	6 " 16		
19	"	"	N.W.	4 " 13		
20	"	Overcast.	Shifty.	4 " 12		
21	62	Clear.	N.W.	8 " 17	Lime blossom.	N.W. storm all day.
22	63½	"	"	8 " 21		
23	64½	"	S.W.	8 " 19		
24	66	"	S.S.W.	9 " 20		
25	68½	"	S.	9 " 20		
26	69½	"	S.W.	9 " 22		
27	72	"	S.E.	" " "		
28	74	"	W.	8 " 28		
29	75	"	E.	8 " 30		
30	75½	Hazy.	"	8 " 26		
Aug. 31	78½	Clear.	S.	" " "		
1	78½	"	S.W.	6 " 19	Borago and various.	Lime ceases to blossom.
2	78½	"	"	5 " 18		
3	78½	Showers.	"	1 " 15		
4	79½	Overcast.	N.W.	" " "	Borago and various.	Drove larvae and drones cast out of the hive.
5	79½	Showers.	S.W.	3 " 13		
6	79½	"	W.	" " "		
7	79½	Clear.	"	4 " 15		
8	79½	"	S.W.	5 " 15		
9	79½	Rain all day.	—	3 " 16		
10	79½	Showers.	W.	" " "		
11	79½	"	"	5 " 15		
12	79½	Cloudy.	"	" " "		
13	79½	Rain and wind.	S.S.W.	3 " 15		
14	79½	Hazy.	W.	" " "		
15	79	Clear.	N.W.	" " "		
20	79½	"	S.E.	4 " 18		
22	79	"	"	" " 19		
24	79½	"	"	5 " 20		
25	79	"	"	6 " 20		
31	79½	Showers.	S.S.W.	5 " 19		
Sept. 1	79½	Clear.	"	4 " 17		
2	79½	"	W.	3 " 18		Windy.
3	79½	"	"	5 " 17		
4	79½	Rain and wind.	S.W.	4 " 13		
5	79	Clear.	"	4 " 15		
6	79½	Showers.	"	5 " 16		
7	79	Clear.	"	6 " 19		
10	79½	Showers.	"	5 " 18		
14	79	Clear.	"	3 " 16		Taken 1 lb. of honey.
22	70½	Rain.	N.W.	12 " 10		
Oct. 7	70½	Showers.	S.W.	" " "		
12	71½	Clear.	"	3 " 12		Filled the unoccupied parts of the hive with hay which has increased the weight 1 lb.
26	73	"	—	0 " 12		Bound a straw mat about the hive which has increased the weight 6½ lbs.
1874.						
Jan. 18	73	Fog.	S.W.	-1½ " +1½		
22	77	"	W.S.W.	+3 " 4½		
28	76	Clear.	N.N.E.	-1½ " +1		
Feb. 1	75½	"	N.	-1½ " +1½		J. R. CHRISTENSEN. Copenhagen.

THE WAX-MOTH. (*Galleria Cereana*.)

(Continued from page 193.)

The male of the wax-moth is distinguished from the female by its smaller size and notched wings, and by the paler thorax, and especially the clear yellowish grey middle portion of the forewings. The head and thorax are pale yellowish grey. The front of the head is very broad, and the hairs which clothe it project unusually far over the front edge, concealing the tips of the palpi, which are much shorter than in the female. The tongue is not developed in either sex, being very minute; so that in its adult stage the moth probably takes no liquid sweets. The antennæ, or feelers, are very slender, thread-like, with a dense tuft of short hairs at the base. The forewings have a clear oval space along the middle of the wing of the same colour with the thorax; the rest of the wing being streaked and spotted with reddish brown. The clear space is also very distinct on the under side of the wing, and throws off slightly brassy reflections. The hind wings are pale at the base, becoming dusky toward the outer edge. The tip of the abdomen ends in a bush of hairs.

In the female, the long and very stout palpi extend beyond the front; and the wings are broad,

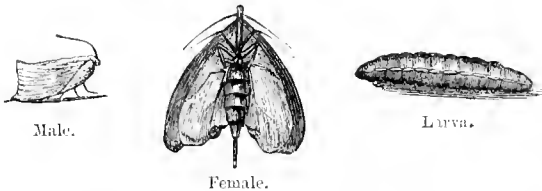

with a slight indentation on the outer edge, and are of a uniformly chocolate brown colour, paler on the under side. The body, like that of the male, is very short, with thick legs; her abdomen ends in a long retractile tube-like ovipositor, so that she can lay her eggs in deep crevices and narrow spaces between the combs. The wings of the male expand a little over an inch and a quarter; those of the female having a little greater expanse.

The full-grown larvæ are cylindrical, very slightly flattened in form, and in colour pale livid, often with a yellowish tinge, and much paler on the under side of the body. The head and the upper side of the first segment of the body are reddish, with a paler line in the middle of the first segment, while the parts of the head near the mouth are black. The terminal ring of the body is reddish, and, with the head, is covered more thickly with hairs than the rest of the body, over which are scattered sparse tubercles, from each of which arises a fine hair. It is about three-quarters of an inch in length.

The chrysalis (*pupa*) is rather short and thick, measuring a little over half an inch in length. The wings are broad, and along the back is a ridge which becomes larger towards the tail, while the whole surface, when seen under a lens, is roughly shagreened. The tip of the abdomen differs from that of most chrysalids in being squarely docked, and ending in an upper and lower horny plate, with points projecting and curved over the edges. It is reddish

brown in colour, paler beneath. When the caterpillar is about to transform into the chrysalis state, it leaves the comb, and spins a tough, white, pod-like cocoon about an inch long, attaching it to the sides of the hive, gnawing grooves in the wood about an eighth of an inch deep, for the purpose of attaching its cocoon more firmly to the sides than it could do when the sides are smooth. In one of the boxes I imported in 1865, one side from the bottom to the top is very much grooved, some of the grooves being as wide as my finger, and very zig-zag, so as to present more angles for each cocoon to be more firmly fastened to the wood, and when fastened they are difficult to pull away.

The females appear in spring and enter the hives at night when the bees are at rest, and lay their eggs; but when the hives are strong they dare not

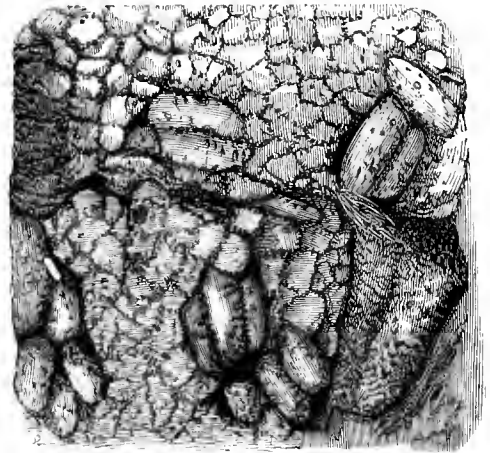

Wax-Moth Cocoons.

enter, so often lay their eggs on the outside, or on the stand. Here we marvel at their wonderful instinct, as if they knew the eggs would by some marvellous way be carried into the hive, the combs being the only place where they can come to maturity. The eggs are covered with glutinous substance, and as the bees return to the hive from the fields, these eggs stick to their feet, and are so carried into the hive. Nay, a wax-moth has been seen depositing eggs on flowers frequented by bees, and after being watched for some time a bee alighted upon the flower, filled her sac, but before she left was caught. An examination with a glass revealed a number of these eggs on her thighs, and thus the bees become the innocent means of their own destruction.

Sometimes the eggs are hatched on the outside of the hive, and the little worm-like caterpillars easily creep through cracks into the hive, or gnaw passages for themselves under the edges of it. As soon as they get upon the combs they begin to spin; and each one makes for itself a tough silken tube, wherein it can easily turn round, and move backwards or forwards at pleasure. During the day they remain concealed in their silken tubes; but at night, they come partly out, and devour the wax within their reach. As they increase in size, they lengthen and enlarge their dwellings, and cover them on the out-



side with a coating of grains of wax, mixed with their own castings, which resemble coarse gunpowder. Protected by this coating from the stings of the bees, they work their way through the combs, gnaw them to pieces, and fill the hives with their filthy webs: till at last the discouraged bees, whose diligence and skill are of no more use in contending with their unseen foes than their superior size and powerful weapons, are compelled to abandon their perishing brood, and their wasted stores, and leave the desolated hive to the sole possession of the miserable spoilers. The rapid increase of these moths when they have obtained a footing in a weak hive, soon makes short work of it, and makes every comb in the hive a mess of entangled webs and their excrement.

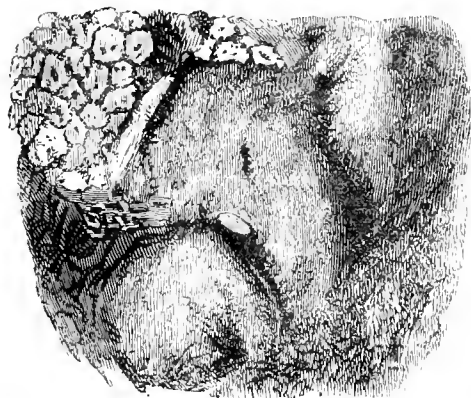

Combs destroyed by Wax-Moths.

Various remedies have been suggested against their attacks, but the only effectual one is keeping the colony of bees strong and vigorous; watching the comb constantly, especially during September when the larva change to chrysalids, to appear in the winged state in the following spring.—WILLIAM CARR, *Newton Heath Apiary, near Manchester.*

#### FOWL BROOD: ITS TREATMENT AND CURE.

I venture to give you an account of my mode of treatment of this dire calamity. Here we do not consider it infectious, and have no scruples in dealing with it, as I think, to our profit. When the disease occurs, we obtain two swarms from our foremost hive (not an infected one): one by natural swarming, the other artificially, and in twenty-four hours we introduce the queen and bees of the fowl brood stock to the hive from which these were taken, and in four weeks we find she is fully prepared to lead off a swarm in the natural way. Any one trying this plan will find it much better than allowing the fowl broody stock to die out, or destroying it. Fowl brood is in the hive, and I don't find the bees carry it with them, so think none need be afraid to adopt this mode of treatment. Now in examining the fowl brood itself, with its masses of putrid matter scattered here and there, we find some young bees coming forth in full health and vigour, and the idea occurred that there might be a possibility of its

cure. Two years ago I lived a swarm in a hive containing foul combs, from which I had cut out the diseased parts, well washing them; but the disease came back in the ensuing spring, so I had recourse to another means, which completed the cure, and up to now the bees are healthy. I recommended the cure to a neighbouring bee-keeper, with a like result as in my own case, and I have no doubt of its complete success. The means are as follows:—Cut out all the comb containing rotten brood; take half a pound of best loaf sugar, and dissolve with boiling water; add half a gill of sherry wine; then pour the mixture on the combs. This will be sufficient for a stock of eight combs, and will astonish those who try it.—JOHN ARMSTRONG, *Stirlingshire.*

#### THE FATE OF A BEE-KEEPER FROM THE FIRST OF APRIL, 1873, TO FIRST OF APRIL, 1874.

I began on the first date with twenty-seven stocks, namely, six Stewartons, one Nutt's, and twenty straw hives, and thinking it was a bad honey season I returned every swarm as they issued but two to the parent hive, thus leaving off with twenty-nine stocks, when I lifted them all, and found what I considered an ample supply of honey to enable them to stand the winter. On a fine day in February the bees came out of all the hives very strong; cold weather then set in, but upon the arrival of some warm days at the end of March I found, to my sorrow, only five hives alive. I should like much to know the fate of other apirians. My apiary during the last thirty years has consisted of from fifteen to thirty-eight stocks.

I have to-day, April 11, been clearing thirteen of my defunct hives. One, a Stewarton, had about four pounds of honey, but not a bee; another Stewarton had a haulful of dead bees, some beautiful white comb in the honey box, but not a particle of honey; out of eleven of the straw hives one had about a stone of honey, but not a bee; and out of the remaining ten only two had dead bees in, but all without honey. In previous years I have found, as a rule, when a hive died of starvation, the bees dead inside, unless when a hive had lost its queen, when of course it gradually dwindled away. The longer I look at my tenantless apiary the more I am at a loss to account for the great mortality. I have usually, when I found a hive light, fed with a bottle at the top, but this year I never dreamt of a deficiency of food, after calculating their weight last autumn. My 'Nutt's' hive is very strong, but in twenty-two years I have only got one box of honey off it, weighing twenty-four pounds; and though I have given the bees the two side boxes and placed a glass on the top, I have never succeeded in preventing them swarming. I have seldom had any difficulty in finding the queen in a first swarm, but in a second, as there are constantly several, one is apt to miss one, and then they probably swarm again next day. This year I shall have to get what swarms I can to replenish my stock.—J. C., *Newton Kyme, Tudecaster.*

## QUEEN CAGES.

Queen cages of perforated zinc should not be recommended without a caveat. Indeed, the propriety of using them may well be doubted, after seeing the evils that have frequently resulted therefrom.

Several years ago we had cages made of the material referred to, and so constructed as to allow of their being inserted and suspended between the middle combs. But whilst approving of a form which we found very convenient, we became prejudiced against the substance, and discarded it altogether. We found it could not be used with safety, unless well rubbed and cleaned; and as this operation was sometimes neglected, the engaged queens were either seriously injured or altogether destroyed. The cause, no doubt, was a poison—the white rust that gathers upon zinc when laid aside for a time after being used.—QUESTIONER.

## QUEEN CAGES AND UNITING QUEENS.

No. 2.

As I promised in last month's *Journal* to describe and illustrate a very simple and perfect queen cage,

that any mere novice can make in a few minutes, by simply bending a piece of perforated zinc of the right shape, and although so simple, no better queen cage has ever been invented and described either in Europe or America. The first queen cage I made, which is described on page 189 of the *British Bee Journal*, took some time to make, and as I constantly had such a number of Ligurian queens to unite to common black stocks of bees, I made a number of these simple queen cages in 1865.

They are made of perforated zinc the same as the others, and measure one and three quarter inches long, one inch wide, and one inch deep: one side of the cage has an opening one inch long and three-eighths of an inch wide, and this is covered with a flat door sliding over it on the inside, with a piece of wire fastened to the top of the door, about twelve inches long to draw it up. (See Figure.)

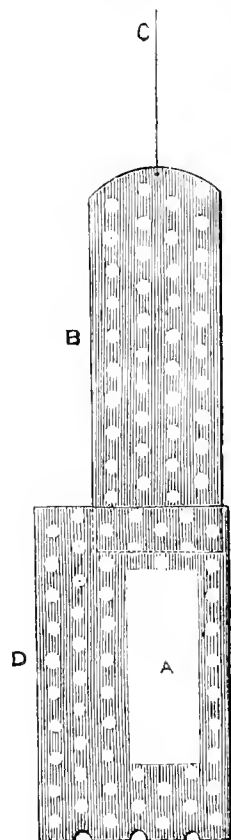

Side of Cage showing the door open.

- A. Doorway into the cage.  
 B. Sliding-door to cover the doorway.  
 C. Wire to draw the sliding-door up.  
 D. Open side of cage pushed into the comb. Scale full size.

When I remove the black queen, I take out one of the centre combs, and having brushed the bees off it I close the hive. Place the comb flat on a table in a room, and push the cage into the comb near the bottom of the honey cells and brood nest to the centre division of the comb. (Mind the cage goes down to the centre of the comb, otherwise the bees will sometimes eat the comb away at the sides of the cage, and release the queen before she has acquired the odour of the bees: they then encase her and she is suffocated.) I then put the queen with her mystical number of seven attendants into the cage through the door at the side, the same as before described, and at once put the comb back into the hive, drawing the wire attached to the top of the slide door through the feeding hole in the cover.

At dark the night but one after, I draw the sliding door up with the wire from the outside, without disturbing a bee, and as before, the queen quietly at her leisure walks out of the cage, surrounded by her loving subjects, and being in the centre of the brood nest immediately commences egg-laying.

The cage may be removed in a few days, when it will be seen the queen has been hard at work, having laid several thousand eggs.—WILLIAM CARR, *Newton Heath, near Manchester.*

## BEE-HOUSES.

‘Under what circumstances should bees be kept from January till January, and should they not be kept at a uniform temperature?’ I think so: or, in other words, should they not be kept warm during winter, and as cool in the stock hive (during summer) as can be done?

Experience can throw some light on these matters where attention has been paid. It is a generally received opinion that bees consume less stores during a severe winter than in a mild one: those who hold to the former opinion will perhaps forgive me when I say I dissent from them: but perhaps they will give their opinion and experience why it is so. In mild winters, such as we have just had, my bees consume less stores, are more healthy than in very cold and protracted seasons; and how can it be else? Cold weather demands more meat to raise heat and keep up animation, consequently, if more meat is swallowed more perspiration takes place, and there is more to evacuate; and when this cannot be done they must hold on longer, which consequently aggravates disease. I do not wish to go farther with this matter at present, but come to the point at once, viz. What is the best protection for bees? In a recent number our editor condemned bee-houses, and quoted the *Handy Book of Bees* in support of his opinion. Now had the author of that *Handy Book* not made a general condemnation in many things that he is ignorant of, but had amplified his cogitations, explaining how this or that could be, the book would have been interesting. For example, if he had illustrated how the bees proceeded to work when they set their eggs; and if no linings were used; and what process they went through when they raised queens from drone eggs; and what kind of

language they used when they were undergoing the taming process; had all this been done, it would have saved much speculation.

But to return to the bee-house, I ask Mr. Pettigrew if ever he saw a bee-house? I question if he has, and warn the readers of this to be careful how they form an opinion. Do not be carried away by the notion that numbers give knowledge. You will find bee-keepers with half-a-dozen hives better able to instruct than others with fifty.

In the first instance I will discuss what is the cheapest covering; in the second, what is the most ornamental; in the third, what is the most convenient; and fourthly, the construction of what is cheapest, most ornamental, and most convenient.

With straw coverings the cost for each hive is usually from one shilling to one shilling and sixpence besides the labour; and this covering only lasts tidily for about six months, not speaking of the untidy appearance the garden is subjected to with loose straws lying about. Now if we compare this cost either with outside cases or houses that can be made at a cost of from 5s. per hive upwards, and which will last a lifetime, no further comment need be made. The tidy and ornamental appearance of neat-made covers on bee-houses over straw, stands so pre-eminent, I consider it only waste of time to say more on the matter.

The most convenient cover for hives is a point which may require more amplification than that of ornament, as many bee-keepers cling to the system of noble houses. In the first place, I may ask, what convenience is required? and in answer may say, to have your hives so that you can regulate the temperature, so that manipulation can be carried on with ease,—feeding the same, in short, everything that is required to be done to hives. The bee-keeper ought to have control without in the slightest disarranging anything to the eye, and this can only be done in bee-houses.

But what is a bee-house? It is not a mere box sufficient only to allow the hives to be jammed close to each other, top, and side, and no more room than allow the hives to stand so jammed, with their mouths close to each other. No, a bee-house must be a spacious structure of sufficient size to allow a lady and gentleman to walk arm-in-arm up the centre after the hives are placed, and no hives to stand nearer each other than three feet from centre to centre; and the hives to be so placed or set, that a hornpipe might be danced on the floor without the bees receiving the slightest shock or vibration; and so constructed that insects shall be unable to molest the hives in any way. Such are a few of the properties a bee-house ought to have; and without them no bee-house can be called a bee-house.

So long as I have kept bees in houses I never had any casualties such as bees fraternising with each other, as described by Mr. Pettigrew, (in fact, it is a delusion to think so; healthy hives will not fraternize with each other, and people who say so have much to learn,) or queens going into the wrong hive, &c.

My intentions with bee-houses of this kind, when I first introduced them, were to have them placed in

a line with a greenhouse, and to enter from the one to the other, and to carry a flue outside, and within two feet of the house, so that a considerable breadth of ground could be heated in front of the hives during cold or snowy weather, only so that bees falling in front of their hives, instead of being chilled, would be strengthened, and more able to reach their hive in safety; and to lead hot water pipes inside the bee-house, so that any hive suffering from damp, or otherwise, could be heated to a moderate heat, and rendered healthy for feeding and breeding. My attention was first drawn to the benefits accruing from the foregoing system twenty-five years ago, (and corroborates the admirable plan of our Editor in resuscitating weak hives in spring by his heating apparatus,) when I had my bees standing near a flue, and there I used to place weak hives without their floorboard at night, for the purpose of inducing them to feed, and put them in a healthy state. I was so impressed with the advantages that I resolved to have my apiary constructed so that they should enjoy them.

But although I have not carried out my ideas with the flues, still my hopes have been fully realised since I introduced bee-houses such as I have described; and not only myself, but many others besides, and those of the highest abilities for bee-keeping; and as these houses are constructed at from 5s. to 10s. (according to architectural beauty) per hive, the cost need be no hindrance to the poorest bee-keeper. But as my time is limited, I am unable to explain every item in connexion with these houses in this paper; but in another letter I will give details for their construction.—A LANARKSHIRE BEE KEEPER.

#### A NEW SMOKER.

Our esteemed friend and correspondent, Mr. F. Cheshire, has hit upon a simple arrangement by which the pipe is made available for smoking bees without any necessity for smoking the operator at the same time.

It is formed of a simple briar-root tobacco-pipe, costing about 6d., which is partly filled with tobacco, rags, or fustian, a lighted fusee such as smokers use is dropped into the bowl, over which a piece of vulcanized indiarubber tube, one end of which is corked and sealed, is placed as shown in the engraving, when, by alternately pressing and releasing the tube in the hand, smoke will be driven out of the pipe in gentle little puffs, which may easily be directed anywhere. Habitual smokers will find a great convenience in using the tubing, as the necessity for reversing the pipe and putting the bowl to the mouth will be thus prevented.

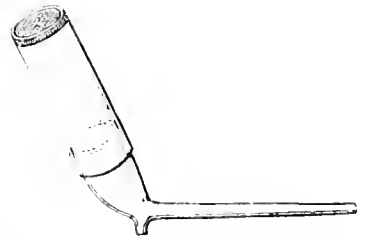

## EXPERIENCE, HINTS, &amp;c.

A HAPPY new year to you and a prosperous! You have well earned, and ought to have, the best thanks and kindest wishes of every individual member of the bee-keeping fraternity for the very valuable information and instruction you have from time to time given to all; and whether, like me, your readers were in their noviciate, or had passed through the trials and troubles that beset the path we all must travel before we attain proficiency, none can have failed to receive benefit who have carefully and attentively studied your columns. I felt extremely gratified the other day by a plainspoken compliment, through me, to you from one of my early club subscribers, who said, 'Ah, sir! if I had not been a subscriber to the *Journal*, I should have had no bees this spring, and I think my subscription has been well repaid to me.' Can a better argument than that be found why you should be in the hands of every keeper of bees?

Well, sir, I did not commence a letter to you with the idea of pushing the *Journal*; but having been for so long a stranger to your columns, I thought perhaps you might like to know how I had been succeeding, and whether I had wintered well. I hardly know how to relate to you my misfortunes and mishaps, or as, perhaps, you may term them, the results of my negligence and ignorance, so will be content to tell that my honey harvest of last year never arrived at all, and, owing to the manner in which I experimented upon my stocks, in the way of queen-raising, Lignurizing, &c. &c., a great many of them were in anything but a good state for wintering, and, as a natural consequence, out of twenty stocks I lost eight, in spite of a liberal supply of glucose manufactured as per Mr. Cheshire's instructions. Many of my hives were kept so long queenless during the breeding months that young bees were at a discount; and these perished in the month of March, although plentifully supplied with stores, and free from any traces of disease. I have, however, the good fortune to have twelve left, and I promise not to do so any more. In one of these twelve hives I was fortunate enough to bring through the winter an unfertilized queen, bred too late in the fall to meet the drone. She commenced to produce drone-brood a month or more since, and her progeny, all male, have now been flying daily for nearly a fortnight. She herself will fly no more, as, with my assistance, she departed this life on Good Friday. On that day I inserted a comb of worker brood from another hive, and to-day (18th April) I found a fine young queen that had been raised therefrom. As there are no other drones in any of mine or my neighbours' hives, I hope to settle the question as to whether drones bred by an unfertilized queen are capable of performing the act of fertilization. Of the result of this, my first experiment for the year, you shall be informed in due course.

The prospects for 1874 are grand; never was such a spring since I commenced bee-keeping. My bees are now gathering honey in excess of the requirements of the hive; and should we receive no check, there will be such exhibits for the Crystal Palace Show as will astonish the weak nerves of our

*friends the Manchester manufacturers.* Hurrah! for our National Show, and may we be able to steer clear of the faults and failings of the INTER-NATIONAL. I hope to be represented at the Palace by the harvest of 'The Slinger,' and if I fail to convince some few doubters of its utility then write me down an — no, I mean a novice.

And now, sir, with all becoming modesty, allow me to suggest two improvements in our *Journal*. Would it not be as well if you were to attach a date to each query and reply, so that we might more readily understand the season for which the advice was given? And as two of the American Bee Journals have copied your idea of query and reply, might you not retaliate by giving, as they do, an index of the contents on title-page of each number? Please to forgive my presumption.

Whilst in this humour, I may as well tell you that I have had a dozen of the new hives as described by you made for me this coming season, and have taken the liberty (pray forgive me!) of improving them. First, I have made the roof narrower and heavier in the centre piece, to avoid curling and forming a gutter to hold the wet, and I have replaced the screws with which you fasten on the cross-bar to honey-board and hold the dummy sides and porch in their places, by a thumb-screw, which screws into an iron plate, let into each part for that purpose, as I found that the screws used by you soon wore out the thread in the wood, and ceased to hold. If I have done wrong, I am very sorry; but I can't help it.

I am rather pleased than not that you have desired an end to the controversy between Messrs. Carr and Renfrewshire Bee-keeper, as to the original inventor of the Stewarton Hive, because I think both those gentlemen can occupy your space with matter of much greater interest to the bulk of your subscribers. Being 'An Anonymous Correspondent,' I am almost afraid to say anything to Mr. Carr, but I *do* want to tell a tale of swarming. Last year a neighbour of mine commenced the year with two stocks of *common* black bees, and they increased to fourteen by natural swarming, and you, sir (Mr. Editor, I mean), bought thirteen of them. Another, who had only one stock, had three swarms from that, called here swarm, cast, and colt; and the swarm threw a maiden swarm, a maiden cast, and a maiden colt, thus increasing after same ratio as Mr. Carr's Italians. These instances can be authenticated.

I notice that Mr. Carr, in one of his letters, states that the Wax-moth is called in America 'the Miller.' He is quite right, and yet he is wrong. 'Miller' is a Yankeeism for moth, and all moths, from the smallest to the largest, are called 'millers' in America; so that in speaking of 'the Miller' they mean simply 'the Moth.'

I am going in for queen-raising again this year, as I believe in the principle of spare queens to be given to hives, directly on the departure of the first swarm; but I have provided all my hives with combs fitted into Mr. Cheshire's twin nucleus frames, and shall raise my queens in nuclei; never again, if I can help it, allowing my full stocks to be minus a queen, even for a day, during the breeding season. You see, experience makes even novices wiser.

In my search for truth, I have been tempted to keep a straw hive or two *à la* Pettigrew, stocked after his instructions, and cross-sticked after the orthodox Pettigrew style. Having read in the *Journal of Horticulture* the other day, how easy it was, with such hives, to drive up the bees with smoke, and then make an examination of the hive, even penetrating the seclusion of the brood nest, I thought I might as well inspect mine. So, acting as per instructions, I made the attempt. I drove up the bees easily enough with smoke, and had there been no cross sticks, I dare say I might have moved the combs aside, and *tried* to see something; but as the sticks were there, there too were the combs fast enough; and for all I could see of what was going on, I might as well have never turned up the hive at all, and I came to the conclusion that had I never got beyond the straw skep, I must of necessity have remained all my life—A NOVICE.

#### A WAX SMELTER.

As bee-keepers' labour and troubles are near at hand, and must be overcome before the time of pleasure arrives for reaping the profits; a few words relative to guide combs may be helpful to many who have little time and convenience for preparing their frames or bars.

There is nothing more unpleasant than to find that the bees have built crooked combs, either from the fact that they have had a poor guide, or that the guide has not suited them, or, as it often happens, the guide comb not having been sufficiently fixed, has fallen, and so caused disorder. Having suffered from all of these caused me two years ago to think over the subject, more especially as I found the ordinary mode of attaching  $\nabla$  strips of wood, or strips of guide comb, was troublesome, slow, dirty and wasteful work, by necessitating the cutting up of useful comb; my thoughts thus led me to construct a small wax smelter of the proportions shown in the drawing,

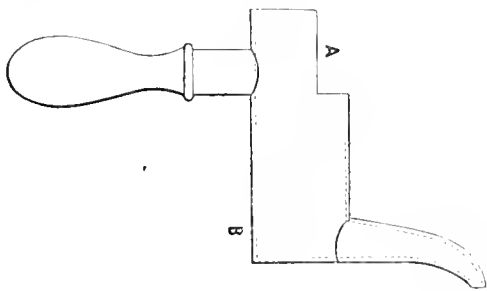

made of one-sixteenth thick sheet copper brazed at the seams, (copper retains the heat longer). The wax to be smelted is put in at *v*, and is melted by holding it over a candle or lamp at *v*; the hole in the spout is a little more than one thirty-second of an inch in diameter.

With this little tool, I found, after a little practice, I could prepare twenty or more frames in the space of five minutes, laying a fine line of wax all round the inside, in the centre of the frame's width, with the greatest nicety, cleanliness and economy. I have

used it without a single failure, and have had many made for my friends, who have expressed great satisfaction after using it, and had good results in the bees following the line laid for them; and one of the finest uses of this little tool is for the purpose of fixing pieces of comb into frames, either after a comb has been broken, or on removing combs from non-bar or frame hives to hives containing bars or frames; by its use all wooden strips, pins or twine, are unnecessary to hold the comb in its position, although as I have many times had, when the comb has been in five or six pieces.

No doubt many of the *Journal's* readers saw the one at the Manchester Exhibition amongst articles exhibited by me.—J. T. WOOD.

#### Queries and Replies.

QUERY No. 91.—Since I wrote 'ill luck' has befallen me, and the bees have all deserted or died in the common skep I applied to you about. I had them on a shelf in an open box without doors until *late* in the autumn, when I moved them into a box which shuts *close* and opens at the back: they were kept covered with a piece of carpeting, and fed this spring in a trough from the outside. They seemed to be numerous, but I doubt not some were robber bees: some time since I did not observe their movements so much as formerly, and on examining the hive only found a few dead and half-alive bees, with one or two which flew off, evidently 'robbers.' We conclude they have *emigrated* somewhere, or the queen-bee died. They killed all the drones at the end of June (an immense number), and were then very strong, and I have all along fed them; indeed, from first to last my bees altogether have not cost less than 7l. or 8l., and I have now nothing to show, for the bar-frame (Neighbour's) is evidently very weak, though they do work in and out with pollen, but not nearly so numerous as they were, though never very strong. A cottager near me has lost three out of four hives with (like mine) abundance of comb, and I hear disasters elsewhere, to be expected where they were *not* fed, from the bad summer and very mild winter. My bees in the 'bar-frame' are feeding, a few at a time, from the trough at the top, and I shall hope still to save them, as there are many trees now in blossom, besides some flowers, for pollen at all events. I hardly know now what to do, though do not like to give up, as I only aspire to watching them and not to their honey produce. The summers are so bad that about here I doubt if they would ever succeed without great help in feeding. A 'delegate' amongst ignoramuses as to simple bee management (like instructions in cookery at the International) would be as useful as those gentlemen are baneful in stirring up strife betwixt employers and labourers, &c. I would, therefore, I think, like to try a hive on a simple principle, which would afford me the sight occasionally of the bees *at work*. I have written more than I ought or need have done perhaps, but it is under sore disappointment, after having wasted pounds of honey and sugar for nought, and feeling something akin to a fool for my pains.—E. S. W., *Bath*.

P.S.—Why should drones be 'trapped' when the bees themselves kill them when not 'wanted?' They must be of some use.

REPLY TO QUERY No. 91.—This seems to be one of those too common cases in which an excessive quantity of drone comb was built in the hive, which being a straw skep it was not easy for an amateur to rectify. The killing the *immense number* of drones in June tends to prove this; but it also argues that the queen was then safe in the hive, and that the

idea of swarming, if ever entertained, was abandoned. It is possible that the queen died during the ensuing autumn or winter, but the probability is that she discontinued breeding too early in the season, and that all the bees were therefore comparatively old ones and unable to exist during a long period of activity, such as from the mildness of the weather the winter has proved for bees. We have many stocks in straw skeps purchased in autumn (to save them from the sulphur pit) to which we then introduced Ligurian queens, which by dint of feeding were induced to raise a batch of bees of their own golden colour in each stock; but at the commencement of March, when strict examination became essential, we could scarcely find one of the black bees in their hives; they had all, or nearly all, died out, leaving only the few Ligurians which had been raised in the autumn, to protect and keep the queens—the beautiful golden queens—alive. These are facts, the record of which is of immense value to apiarian science, yet which are too often ignored by inexperienced writers. The probability is that in the present case the bees simply died out. With food in the hive there is little fear of healthy bees emigrating, except at swarming time; those in an unhealthy condition, suffering from foul brood, the ravages of the wax-moth, dysentery, or starvation, will occasionally desert their hives, and go *en masse* to more comfortable quarters, if they are to be found, but these occurrences are rare. When bees are starving in mild weather, through continued rains, they will sally out as if swarming, but they generally fall to the ground, and form into scattered knots of perhaps a dozen bees each and thus die in company. The 'Neighbour' hive will probably recover, as from the bees carrying pollen freely, it may be safely inferred that breeding is going on, and that their numbers will soon increase. It is rather against the common doctrine for bees in a straw skep to die out, while those in a bar-frame hive remain alive. The past season has been one of extraordinary mortality amongst bees, one gentleman, a correspondent in this *Journal*, a bee-keeper of many years' experience, having lost twenty-four out of twenty-nine stocks. It is a pity to contemplate the giving up of bee-keeping because of the disasters of a year so exceptionally bad as 1873 stands recorded; while from present appearances 1874 promises to be such a good one. Hives in which bees may be seen at work afford very little instruction or amusement, unless they be specially devoted to the purpose as 'observation hives,' in which case no profit in honey or swarms can be expected from the bees in them. A bar-frame hive, with glass sides and top, is the nearest approach thereto for convenience, but when filled with combs and bees very little can be seen of their working. We quite agree with you that drones have a value beyond that with which they are usually accredited; it, however, often happens that drones of a particular breed are not required in an apiary, and in such cases trapping is essential; again, trapping will save the bees an enormous amount of labour when killing-time comes.—Ed.

QUERY No. 92.—I have a Stewarfon body box full of comb, and containing about 15lbs. of honey. The comb

is very dark, and I do not care to eat the honey in it. How can I make it most useful to my bees? It would be a good chance for a Slinger, but there is not one hereabouts. Would it be good to put the box and honey-comb as a super or under to another hive which is short of honey? Or would it answer to put it to a new swarm next month, if I get one?

In short, kindly tell me in what way I can make it most useful.—R. D. F., *Ayrshire*, 17th April, 1874.

REPLY TO No. 92.—As you object to using the honey out of the combs now because of their blackness, and they will not be likely to be improved by the bees in future, it would be doubtful policy to place it on a hive as a super during the ensuing year. Supposing the combs, &c., to be quite clean and healthy, the better plan would be to divide them between two swarms in May, if they can be obtained, placing half the combs in each, in alternate order, an empty bar or frame between each pair of them. This would give them an excellent start, and prevent the necessity for using doubled swarms, but doubled boxes should be given at once. By doing this, the bees will commence breeding immediately, while the interstitial frames would permit them to indulge their comb-building propensity, which (having a good store of honey) they will be able to continue unchecked. If the whole were given to one swarm, they would probably store their honey in it, and, having no brood to attend to, would fill it solid before the queen could occupy it as she ought with eggs, when it would be at the end of the season of no more service to you than it is now. By using it as suggested, guides on the intermediate frames will not be required, as the bees will build their new combs straight between the others. It would be a good plan when placing the combs in the hives for the swarms, to shave off the tops of the sealed cells, so that they may remove and use the honey, leaving the cells for breeding purposes, otherwise they may leave the honey intact, which would defeat the object in view.—Ed.

#### NOTICES TO CORRESPONDENTS & INQUIRERS.

MR. PETTIT BREW, LOCKERBIE.—We are obliged by your communication, but cannot admit anything to our columns which is not authenticated with the name and address of the writer. In any case we should much prefer reasonable arguments to insinuation and lampooning. Why touch pitch unnecessarily?

REV. W. J. F., STAFFORD.—The Index will be forwarded with our next number. Many thanks for your kind endeavours to procure subscribers. Such aid is really valuable to us, and beneficial to bee-keeping generally. We only wish that every one of our subscribers will procure another, and that they will subscribe as early as possible.

JAS. WILKINSON.—Every bar-frame in a hive should have wax guides laid along the centre of the underside of the bar. It does not matter about the wax being dirty-looking.

T. K. B.—It is rather hard to expect us to reply so often, when both stamp and envelope are omitted; once or twice they may be forgotten, but when it becomes customary it is expensive.

J. A. thinks, after a year's happy acquaintance, a little hob-nobbing would be agreeable, and has sent us a pinch of Original Scotch snuff, which he kindly invites us take with him. We do so, and bow, and— and — accordingly.

THE  
**British Bee Journal,**  
AND BEE-KEEPER'S ADVISER.

[No. 14. VOL. II.]

JUNE, 1874.

[PUBLISHED MONTHLY.]

Editorial.

FORMATION OF THE BRITISH BEE-KEEPERS' ASSOCIATION.

IN accordance with the notice and invitation issued in our last Number, page 5, a meeting of the subscribers to the Prize Fund of the Crystal Palace Bee and Honey Show, which is arranged to take place on the 8th, 9th, and 10th of September next, took place at the Lecture Hall, 168 Camden Street, for the purpose of establishing an Association of Bee-keepers, and of revising the proposed Schedule of Prizes which appeared in the *British Bee Journal* of February last. The meeting took place at four o'clock in the afternoon, when business commenced by the appointment of the Hon. and Rev. Henry Bligh, of Nettlebed, Oxford, to the chair, who, having expressed a hope that the business would proceed harmoniously, permitted us to explain the position of affairs, as far as we were concerned, by reading the correspondence which we had had with F. W. Wilson, Esq., the Secretary of the Natural History Department at the Crystal Palace, from which it appearing that the Crystal Palace Company had offered considerable facilities in furtherance of the object in view, that they had appointed the time for the Show, and had promised a subscription of Five Pounds towards the Prize Fund, making a total of Seventy-six Pounds, the meeting expressed its entire satisfaction with the course which had thus far been taken. The business of the meeting then proceeded, and after considerable discussion, in which Messrs. Cheshire, Symington, Hooker, W. Abbott, Hunter, Hale, and Hughes, took part, it was *Resolved*:—

‘1. That the gentlemen now present do constitute themselves a society, to be called “The British Bee-Keepers’ Association,” who should take over from the Editor of the *British Bee Journal* all matters connected with the announced Show at the Crystal Palace; and whose objects should be, the encouragement, improvement, and advancement of bee-culture in Great Britain, particularly as a means of bettering the condition of cottagers and the agricultural labouring classes, as well as the advocacy of humanity to bees.

‘2. That the annual subscription to the Association be five shillings.

‘3. That the following officers of the Association be appointed:—*President*, \_\_\_\_\_; *Vice-Presidents*, the Hon. and Rev. Henry Bligh and R. Symington; *Treasurer*, the Editor of the *British Bee Journal*; *Hon. Secretary*, John Hunter; *Committee*, Messrs. Atlee, Abbott, Cheshire, Hooker, and Turner, with the Treasurer and Secretary, who shall hold office until the first general meeting of the Association.

‘4. That a general meeting of the Association be holden on the 10th day of September next, at an hour and place to be determined by the Committee, when the officers for the ensuing year shall be elected and rules for the government of the Association considered and resolved upon.

‘5. That for the purpose of furthering the good objects of the Association it is considered advisable to enlist the patronage of gentlemen of position interested or skilled in apiculture; and that the Secretary be directed to write to the Rev. Mr. Cotton, Mr. Carr, and others, to obtain their permission to act as Vice-Presidents, and become members of the Association.

‘6. That the subscribers to the Prize Fund announced in the *British Bee Journal* having now constituted themselves “The British Bee-Keepers’ Association,” the Editor be requested to transfer to the Association the funds collected for the purpose of the Exhibition, together with the list of further subscriptions promised; and that future business connected with the announced Show be transacted in the name of the Association.’

The Hon. and Rev. H. Bligh having now vacated the chair (it being near eight o'clock), was accorded a cordial vote of thanks, when Mr. Hooker was unanimously called upon to preside for the remainder of the meeting.

The members then proceeded to discuss and revise the Schedule of Prizes, which were finally resolved upon, when the best thanks of the meeting were given to Mr. Hooker for his courtesies in the chair, and at a late hour the meeting broke up. (For revised Schedule of Prizes, see pages 31, 32.)

THE PAST MONTH.

At the commencement of May the prospects of the bee-keeper were of the brightest; the weather was all that could be desired, drones were plentiful, honey-yielding flowers and blossoms abounded, and swarming had begun in earnest; when, suddenly, the east wind came, and blight and drought destroyed the hopes that the previous continued lovely April weather had engendered. In our own neighbourhood the laurustinus was still in flower, sycamore in full blossom, furze and broom were



in their fullest glory, plum-trees had blossomed, but their beauty had waned, pear-trees and cherries were in their fullest brilliancy of dazzling white, apples were opening their blushing blossoms, and myriads of bees were rifling them of their hitherto hidden sweets, gooseberry and currant-trees were alive with the merry hum of our favourites, and all was well until the east wind came; then, although the blossoming trees continued to shed their beauty on the landscape it was but 'promise crammed,'—beauty there was in profusion, but sweetness was there none, as the poor bees soon found to their cost. On the 4th the horse-chestnut put on its beautiful adornment of white and pink; on the 8th, raspberries vainly endeavoured to entice the bees to their pretty little rosettes; on the 12th, the laburnum, so intimately associated with the poetry of bees, assumed its loveliest aspect; on the 15th, a slight shower of rain raised the hope that a change for the better was about to take place; but the rain gave place to snow, which, although but slight, gave assurance of frost at even, which was followed by a continuance of dry days and cold nights until the 21st, when dense cloudiness, vivid lightning, and distant thunder, heralded, as we fondly hoped, the wished-for change. London was, however, the chief recipient of the rain-storm when it broke, the streets being deluged with torrents of rain; while the thirsty country, but for a tantalising shower barely sufficient to lay the dust in the roads, remained thirsty as ever. Matters continued thus with slight variation until Sunday the 24th, our Queen's birthday, when the wind veered to the south, and the atmosphere became more balmy and genial, but still there was no rain. Nevertheless the change was most gratifying; the bees, which had been cooped up in comparative idleness for many days, were again enabled to indulge in their pleasant labour, and right merrily did they accept the precious boon. But in the meantime what had happened? Swarming, for which the bees had largely expended their stores in preparing by the rearing of drones, was suddenly stopped and the *idea* abandoned; and the drones, both living and in embryo, cast out of their hives; supers which, at the end of April, gave promise of a rich harvest of vernal honey, were deserted, and the delicious nectar stored in them removed for the use of the bees; stocks which were full of promise were reduced to the very verge of destitution; and many which were not originally so well provided, perished outright of sheer starvation. The greater evil during all this time consisted in the fact that the breeding of young bees, so necessary to enable stocks to yield swarms, or store their

surplus of honey when the opportunity presented itself, was, in many instances, almost suspended,—nay, the young brood was consumed or cast out, as portrayed on page 4 of Vol. I. of this *Journal*, where also were explained by anticipation the possible cause, and means of prevention, of the calamity.

### JUNE.

ALTHOUGH April gave promise of early swarms and well-filled supers, the blighting east wind which waited on the advent of May, and continued with her through many of her early days, entirely changed the prospect; and stocks of bees, which showed every sign of the highest internal prosperity, were suddenly reduced to the very verge of destitution. The land was literally *flowing* with honey, but 'the east wind dried up her fruit,' and brought with it a honey famine which, but for the timely assistance rendered by bee-keepers, would have caused the ruin of many valuable stocks of bees, and in some instances have desolated whole apiaries. Many have been the queries which we have received as to 'the cause of the appearance of white grubs on the alighting boards,—piles of undeveloped drones, with light bodies and shrivelled wings,—particles of white meat, like the flesh fragments obtained from a lobster's claw,—and many dead young bees not fully formed, covered with white hair, and apparently dried mucus;'—to the whole of which our replies have indicated the cause to be 'impending starvation.' Who can imagine the sufferings endured by a mighty army of working bees, which had been tempted, by the fineness of the season and the abundant yield of honey, into the extraordinary expenditure of stores consequent on their natural endeavour to multiply their species under such promising circumstances,—suddenly finding themselves cut off from all out-door supplies, and compelled by a bitter enemy to shut themselves up in their fortress for many days together, while every hour is adding its hundred to the already excessive population, and reducing their supply of food, until eventually they are not only compelled to desert their young, but are forced to eat them to live? All practical bee-keepers are aware of the intense love of bees for their brood; how, if a comb containing it in any of its various stages of development be accidentally left exposed outside a hive, they will rather die with it than desert it, which self-devotion is attributed to the marvellously potential influence of maternal instinct. How great, then, must be the force of circumstances which can overcome this great love,—this instinct, which urges its subjects to self-immolation in defence



of their young! And what must be the suffering borne by them ere that other instinct—self-preservation—is aroused, and, reversing the maternal law, induces them to kill, and eat the bodies of those they would in other circumstances have died in protecting!

The remedy for such a state of things is Food, liberally and freely administered, the receipt of which will restore the tone of the hive, and prevent the seeming necessity for further destruction of brood. But how much better would it have been if the mischief had been prevented altogether! In the May No. of the *Journal*, Vol. I., pp. 4, 5, the state of hives checked in May by a return of the rigorous weather of March was anticipated, the symptoms described, and the remedy exhibited.

‘If e'er dark Autumn, with untimely storm,  
The honey'd harvest of the year deform;  
Or the chill blast from Eurus' mildew wing  
Blight the fair promise of returning Spring;  
Full many a hive, but late alert and gay,  
Droops in the lap of all-inspiring May.—EVANS.

Stocks on which supers have not already been placed, should be now supered without delay, for June is the month during which the chief supply and surplus of honey are usually obtained, not only because of its abundance in the flowers, but because also of the immense numbers of worker bees which have nothing to do but collect and store it. During April and May, while the working army was limited in numbers, the food they gathered was very largely consumed in rearing brood, and only in rare instances could a surplus have been stored; but now that there are (or should be) so many bees beyond the number required for the duties of the hive, the quantity of honey gathered is (or ought to be) greatly in excess of their present requirements, in which case it is stored in supers or elsewhere. *Supers* are, however, the most convenient receptacles for honey, and the use of them most in accordance with the habits of the bees, for it is well known, and has been reiterated in these columns by several esteemed correspondents, that bees always store their honey at the farthest point from the entrance of their hive.

Supers entirely of glass are inconvenient for the bees to store honey in, as they have considerable difficulty in attaching their combs to the top, and consequently often build upwards, when, having to stand upon the combs to carry on their work, their progress is slow, and the danger of collapse great, from the wax being necessarily warm, and the clustering bees heavy upon it. It is therefore advisable in selecting, or making supers, to determine on such as shall have conveniences for the bees to cling to on the underside of their crowns, so that they may cluster in the natural way, and build their

combs downward from the top, in which case, as the attachments will be firmly made, and will be widened and lengthened in proportion as the combs are deepened, there will be no danger of collapse, and the work will proceed right merrily. Supers of glass, glass shades, &c., are usually furnished with a perforated zinc tube, called a ventilator, the sole virtue of which lies in the fact that it is a means by which the bees may cluster while forming their attachments to the glass top; for as a ventilator it is absolutely useless, since the bees fill up all the perforations with wax or propolis, before commencing any other kind of work upon it. A very nice super may be made of wood and glass, in the following manner:—Take a piece of thin board, of any size determined on (say ten inches square), and cut holes or slits through it to correspond with the perforations in the crown, crown-board, or adapting-board of hive; then procure four pieces of wood, about one inch square,

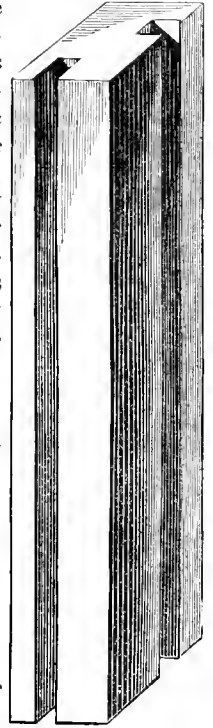

Fig. 1.

and make saw grooves on two of their adjacent sides, as shown in figure 1; or if a carpenter's plough can be obtained, a long length of stuff may be prepared in a few minutes by ploughing the grooves as shown above, when the short lengths may be cut off as required.

These short lengths should be fixed one at each corner of the square piece, as shown in figure 2, when slips of glass should be slid into the grooves to form the sides of the super, which will then

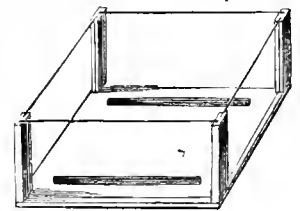

Fig. 2.

appear as above, and may be finished by placing a second square of thin board on the top, or it

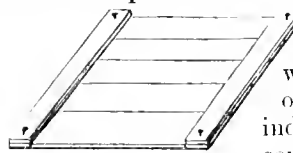

Fig. 3.

may be furnished with bars, each of which should be waxed on the under side to induce the bees to build combs at the required distances. In making

these bars we usually use strips of thin deal, about two inches wide, five of which will cover the super to the fullest extent; these strips are placed across the super, resting on the glass sides and tops of the corner pillars, and are

held together by two other strips, which clamp their ends; they are kept in position by nails driven one each into the tops of the pillars through both layers of the thin strips. Practically we never drive nails so far into the wood as to make it at all difficult to withdraw them, as we look upon supers as merely temporary receptacles (for honey) which should be capable of easy dissection and separation, so that the honey-comb may be easily comestible for use, and that, too, without injury to itself, or the super from which it is taken.

Where bell-glasses are used for supers, a famous enticement for the bees, to induce them to work therein, is formed of two very thin sticks, tied in the form of a cross, one of which reaches from the top to the bottom of the super, the other from side to side, the cross piece being near the top, and furnished on both its ends with pieces of nice clean comb, in the manner shown in accompanying engraving.

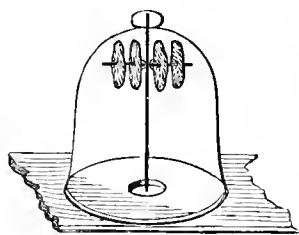

Fig. 4.

It is better not to fix the comb to the cross stick, as the bees, finding it secure, may neglect it; but if it be left hanging loosely (and right way upwards of course), the bees will take any

amount of trouble to make it safe to cluster in, and having spent some time with, and about it, will be most likely to continue their attentions and go on filling it with honey. The pieces of comb should be so placed on the cross stick as to nearly touch the top of the super, that the bees may be tempted to lengthen them upwards and form attachments to the glass; a second cross stick at right angles to the first with other pieces of comb upon it would afford additional temptation, and would aid the bees in their endeavours to find storage-room for their surplus honey, besides saving them the trouble and expense of making combs anew. All supers which have glass in their construction should be carefully protected against the vicissitudes of the climate, as warmth is most essential where comb-building is going on, and its escape from want of outer protection is often the cause of bees deserting their supers and carrying the honey from them down to the hive below.

Those who intend to use supers of about the same size as their hives,—for instance, the Woodbury super, on the Woodbury hive,—would do well, when they remove the crown-board, to make it form the crown of the super. Woodbury supers are formed very much in shape like figure No. 2, but are much more expensive. Woodbury hives, having space

above the frames, which is almost certain to be filled with comb and honey before swarming or supering time arrives, present surfaces of bleeding honey when the crown-boards are removed, the scent of which surfaces often causes the commencement of robbing, and usually leads to wasting of comb, for in most instances the crown-boards are set aside for the bees to clear up the running honey upon them, and the fragments of wax are thrown away, whereas by placing the crown-boards with their waxen foundations upon the crownless walls of the supers, the honey and wax are both saved and preserved to the hives to which they respectively belong, the bees adopt the foundations already then formed to attach their super combs to, and loss and robbing are prevented.

The introduction of queens is one of the important features in advanced bee-keeping, about which there is more uncertainty than with any other branch of the science, the fertilization of a queen not excepted, for that is intrusted to the instincts of the bees in their normal condition; whereas the substitution of one queen for another is eminently unnatural, and savours so strongly of coercion that the bees are almost sure to resent it, and hence the many failures which occur, causing much vexatious loss and disappointment. Having occasion to introduce a batch of queens to some stocks of bees in straw skeps, and knowing the difficulties and dangers which attend the operation, we hit upon the idea of caging each queen upon the piece of comb which was sent with her in the box containing herself and attendants, and are glad to be able to report successful results. Those who have received imported queens are aware that they arrive with a few attendants, in small boxes about six inches long, four inches high, and four inches wide, which are furnished with one or two small frames, containing a few square inches of comb, part of which is filled with honey, the remainder being simply empty cells for the bees to congregate upon. An old plan of introduction of queens is, after removing the old queen, and receiving the new one in the box as above mentioned, to remove the bottom of the latter and put perforated zinc in its place, then to stand it on the feeding aperture, so that the bees could, perhaps, make the acquaintance of their newly-imposed queen from below, and after a few days to remove the zinc and allow them free access to her. This plan is successful occasionally, but is far too dangerous to be followed by one who has had any experience, hence a better method was sought and adopted. The problem was to remove the black queens, and introduce Ligurians to stocks in straw skeps, some of them having no super

or feeding hole in their crowns, and this we have in our own case successfully solved. It is generally believed that the odour is the distinctive feature in each hive, and acting upon this belief, assimilating the odours of bees to be united, and rendering them unable to recognise any distinction, the union is generally effected in a most peaceful way. Various methods are adopted to produce this sameness of odour amongst bees, sprinkling with scented syrup being one of the most common; the smoke of tobacco, rags, corduroy, and touchwood, are often used, as are also the fumes of burning puff ball, as recommended by the Rev. G. Raynor; but all these interfere, in greater or less degree, with the comfort and vitality of the bees, and if they can be avoided it is undoubtedly wiser to avoid them.

The plan which we adopted in the case referred to, was first to drive out the bees, and capture the queen, a proceeding, it will be said, not calculated to delight them, but which has at least the merit of being perfectly harmless; we then opened the box containing the Ligurian queen, lifted out the frame of comb on which she was surrounded by her attendants, and carefully placed a cage of perforated zinc or wire over her, enclosing also several of her subjects to attend her and ensure that she would be kept clean.

Our queen-cages are usually made thus: Take a riband of perforated zinc, one inch wide and six inches long, and mould it round a block of wood, one and a half inches square, fastening the two ends, by sewing them, through the perforations with fine copper or brass wire; then cut a piece of fine wire-work, one and a half inches square, and sew that on to one end of the zinc square in the same manner, and the cage will be complete.

Having enclosed the queen and attendants, press the cage down until its cutting edges reach the centre of the comb, to prevent the outside bees from undermining it to get at her; then tie a piece of string round the cage and comb, as shown in engraving No. 5, to prevent the weight of the bees, which will cluster upon it, from forcing it away. The bottom of the box must then be removed, and the bottom-

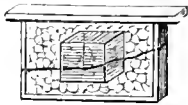

Fig. 5.

less box itself fitted to the top of the hive under operation. If the hive be a flat-topped one, little alteration will be needed; but if a round-topped one, some parts of the bottom rim of the box must be cut away, to enable it to fit comfortably; which being done, the hole in the crown

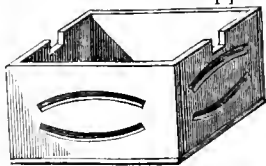

Fig. 6.

of the hive is opened, the box replaced, and the comb containing the caged queen placed in it, the ends resting in the notches, as exhibited in the engraving No. 6, when a piece of glass to form the cover or lid of the box will complete the arrangement. Before, however, the lid is placed upon the box, the bees which were driven out when the queen was found, and which will have remained huddled together in the skep to which they were driven, should be poured into the box at the top, so as to fill it, and create a warmth, also that they may acquire in some degree the odour of the box itself: the glass should then be put on, the whole carefully covered and kept warm, and the work will be (thus far) done.

Now if the movements of the bees be watched, it will be found that they will run down into their hive, leaving the caged queen almost alone, hence the necessity for husbanding the heat ascending from the hive by warm wrappings round the box; but in the course of a few hours they will have missed their queen, and in searching for her will have found the new one, and woe betide the poor sovereign if she be not carefully caged, for they will strive by every possible means to get at her to destroy her.

After a few hours' ineffectual endeavours in this direction, the odours will have become assimilated, the bees having removed every available particle of honey from the box, which being highly aromatic (usually Swiss mountain honey), will have changed the odour of the hive, while the ascending air laden with the scent of the hive, will have toned down the stronger odour of the Ligurian queen; and after about thirty-six hours the chances are that the bees, finding their attempts to release the queen ineffectual, will have almost deserted her, and gone below to raise queen-cells from their own brood; and it is at this moment the queen should be released, which is done by removing the glass, cutting the string, and pushing the cage off the comb, but replacing the glass to prevent her majesty flying away. It will then be observed that a bee will begin to overhaul the queen and thoroughly examine her, and perhaps offer her food, but more often he will get on her back and feel her all over, making a demonstration which will soon bring other bees to the scene, and in a very few minutes she will be safely escorted into the hive, and joyously received.

With a hive having no feeding-hole in its crown we have adopted precisely the same measures, except that the box containing the caged queen was placed against the entrance, the lower parts being cut out to permit the bees to pass through it to the entrance of the hive.

They were thus obliged to pass through the box every time they made a journey; they also cleared out all the Italian honey from it; all the odours of the hive came through the box, because they could not escape elsewhere; and in thirty-six hours, or thereabouts, the queen being carefully released, was joyfully received, and safely conducted to her future court amidst a general hum of satisfaction from her delighted people.

In transferring the contents of straw skeps to bar-frame hives it often happens that the combs of the former are sufficiently large to fill the frames of the latter without patching or piecing out, in which case having been fitted into the frames, they simply require holding there until the bees attach them firmly. For this purpose strong tape or wire is often used, sometimes laths are nailed or tied across the frames, and sometimes pins of wood or iron are driven through them and into the edges of the combs; but either of these, although they do fairly well, are liable to damage the combs or brood, or irritate the bees, to avoid which as far as possible a better means if presented should be adopted.

In such cases we have always found slight clips of tin or zinc to be the most serviceable; they are made of narrow ribands of the metal about three inches long, which are bent into the form

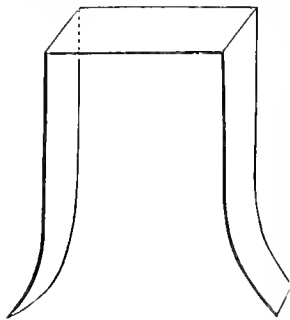

Fig. 7.

illustrated by being moulded on to the top and sides of the frames round which they are to clip, so that when placed in position they shall grip the comb and frame on both sides and keep them in their respective positions until the bees have united them, which they will usually

do in about twenty-four hours, after which the clips may be removed, and the operation will be completed.

We have recently adopted a method of forming Ligurian stocks which has answered so well that we think a description of it may be acceptable to our readers. Having some black stocks near swarming condition, also some Ligurian queens which were not 'bespoke,' we determined to reverse the usual order of things, and instead of introducing the queens to the bees, we introduced the bees to the queens. Possessing some nice frames of comb which had been used in nucleus hives last year, we furnished some Woodbury hives with them, and caged the queens, one in each, on combs which contained liquid honey, we then drove artificial swarms from the black stocks, found

their queens, and returned them (the queens) to their hives which were immediately removed from their stands to strange positions. The Woodbury hives containing the Ligurian queens, were then put in their places and the driven bees introduced to them, each swarm on the stand to which it had been accustomed. As may be imagined, such a sudden change of quarters was anything but agreeable to the bees; they had lost their queens, their brood, and their stores, and the nature and appearance of their domicile were greatly altered, so it was not to be wondered at if they appeared rather unhappy. It is true they found a queen within their hive, but she was engaged so that mutual aid or benefit was out of the question, and finding that they could not release her and had no means of raising another (having no eggs or brood in the hive) they were soon reduced to a despairing condition, as might easily be inferred from their melancholy hum. If they had any spite against the queens thus rudely thrust upon them, it soon gave place to other feelings, for the bees quickly found that on them (the queens) and their restoration to liberty, depended the existence of the newly-formed colonies. Twenty-four hours after the forcible union had been effected, the hives were examined; the bees appeared to be in a state of the greatest consternation, running about the combs in the most anxious way, a few only hovering near and about the cage, one of which we presently saw offering her majesty food through her prison bars, which was kindly accepted, satisfying us that loyalty had taken the place of resentment, and that regicide was out of the question. We therefore removed the cage and allowed the bees to make more intimate acquaintance with *their only hope*, when it was really astonishing to see how soon the agitation of the distressed bees subsided.

The exterior of the hives from the time of union had been a continuous scene of bustle and excitement, bees rushing in, out, and about the entrances in a most excited manner, flying wildly hither and thither, attempting to enter other hives, from which they were rudely repulsed, or instantly slain; yet in one hour after the release of the queens, perfect peace and harmony prevailed, and the next day the bees were working briskly and carrying pollen as if their very lives depended upon their so doing.

We would not recommend any one to attempt this mode of Ligurianising whose stocks are in close proximity to each other. Our experiment was made upon three skeps which were standing under a fence on separate stands about four feet asunder; and on displacing the skeps and placing Woodbury hives in their stead, the bees in their wild excitement entered them promiscuously,

which caused a loss of some two or three hundred of them through the fighting which ensued. This, however, was a small matter compared with the experience gained, for by these means several swarms of black bees may be taken from one skep during a summer and Ligurianized instantly, to be afterwards built up into stocks by the addition of combs of brood, or by feeding them to enable them to increase without the usual amount of labour.

Our cottage friends may like to be told of cheap stands for hives, of which we have several in use; they are neither more nor less than four Australian meat-tins placed upright under the floor-boards, the solid ends standing downwards, so that they cannot sink into the earth. They are neat in appearance and have the great advantage of being low (about seven inches); and from their size are not likely to be blown down, or, for greater security, they may be filled with earth to increase their stability. They are at present a drug in the market, being considered valueless.

Swarms, whether early or late, should be fed every night for the first fortnight, and every day also on which they cannot gather honey, so that they may fill their hives with comb while the comb-building impulse is upon them; otherwise it is possible they may be obliged to relinquish their operations until a more favourable season, when they will be almost sure to build drone-comb only. Allowing the comb-building impulse consequent on swarming to be checked has caused the ruin of many a swarm which would otherwise have become a valuable stock.

#### LIGURIANIZING FOR LADIES.

A Lady subscriber has purchased a swarm of pure Ligurian bees, and wishes us to give such instructions as will enable her, with the assistance of her gardener, to Ligurianize all the other stocks which she has in her apiary; and we are to be very careful to make everything quite plain and simple, so that the whole process may be readily understood, and success made a matter of certainty. There must be no stinging, nor must there be any difficulties; there must be nothing left to private judgment, because both the lady and her assistant profess entire ignorance of bee-management, and are somewhat afraid of the bees, although they are exceedingly fond of them, and greatly admire their wonderful sagacity and apparent wisdom.

We are quite willing to undertake this pleasant task, as far as it is possible of performance; but as there are certain features in the process which are uncontrollable, we

cannot guarantee the absolute certainty of results concerning them; and therefore, in the first place, think it well to show in which direction failure is within the bounds of possibility. Firstly, it is just possible that the young queens may be lost when seeking their drone partners; and, secondly, *their choice* cannot be controlled, so that, even though successful in their matrimonial ventures, their progeny may not be equal in beauty or docility to those of their imported queen mother. These are chances which must be risked on every occasion when young queens are brought into existence, the former fatality being possible with every hive which has sent out a first swarm, and with every cast which afterwards issues, while the latter more particularly attends the endeavour to multiply the beautiful Ligurian or Egyptian races of bees, or, at any rate, it is more noticeable, as constituting a failure in the object desired. It is, however, admitted on all hands (the most ignorant excepted) that the offspring workers of hybridized Ligurian queens are greatly preferable to any others for honey-gathering and general profit, and therefore, even should the latter contingency occur, the gain in value in the respective stocks will have well repaid the labour involved in the experiments.

Commencing, then, with the receipt of the Ligurian swarm, we would recommend that on its arrival it be placed on the stand it is to occupy, which should be several yards distant from any other in the apiary. It should be carefully tended, and fed nightly until its hive is filled with combs, which should be in about a fortnight. In the meantime preparations should be made for effecting the object desired, which we propose should be by the fumigation of both the Ligurian and the black bees, and while in a state of insensibility that their hives should be transposed, so that the Ligurian bees should take possession of the combs of black brood, while the black bees, having been first deprived of their queen, should have the Ligurian brood committed to their charge, so that they may raise a queen of their own from its larvæ. The only mechanism required is a fumigator (see engraving on next page), by means of which the fumes of burning puff-ball may be injected amongst the bees in the hives, which will cause them all to fall asleep and tumble out of the combs in a state of insensibility, during which the queens may easily be found and removed or not as occasion requires. The smoker requires little or no preparation beyond being filled with the dried puff-ball, and lighting, when the fumes may be blown out of it, either by the mouth, or by the insertion of the nozzle of a bellows at its open inlet, A. Previous to lighting it, the hives

to be operated on should be made ready so as to prevent any hitch in the proceedings, which need not occupy more than half-an-hour, but which if not carefully timed may be disagreeably protracted.

One hour before sunset, a little smoke of tobacco or rags should be blown into the black stock, to drive the bees up amongst the combs, the hive should then be lifted from its floor-board and an inverted empty hive of similar size placed under it; the puff-ball in the fumigator should then be lighted and the delivery end thrust into the entrances of the hives (which should be placed together for that purpose), its point being turned downwards so that the heated fumes may be directed into the empty hive below, whence they may rise up amongst the combs and bees, without burning or overheating either the one or the other. In a few seconds a quick buzz of alarm will be heard; and if the ear be applied to the outside, the bees will be heard dropping like shots out of the combs into the hive beneath, and in less

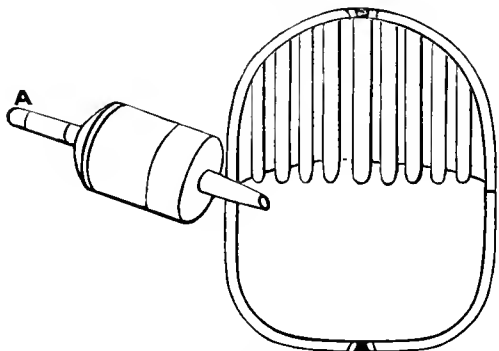

than five minutes the whole of them will be found there insensible, when the queen may be easily picked out from amongst them, and should be put away in a small box with a little honey-comb and about a dozen workers as a reserve in case of accident with any other stock. The hive containing the bees thus fumigated should now be placed, still in its inverted position, on its original stand, that by exposure to the air they may recover from their insensible condition; but the hive of combs from which they were driven should be taken into a warm room to prevent the brood from becoming chilled through the absence of the bees. The black bees being thus powerless and their queen removed, we next proceed to treat the Ligurians in a similar way, with this exception, that as the queen will not require removal, the fumigation need not be so long continued as in the other case where it was determined to render the bees entirely powerless; but as soon as they have tumbled out of the combs, the hive containing the latter should be removed, and placed on the inverted hive in which

the black bees are slowly recovering, so that they may take possession of the Ligurian brood at once and raise a queen for themselves from its larvæ, while the Ligurian bees should have the hive containing the black bees' combs placed on the hive into which they have been precipitated, that they in turn may take possession of them and fill them with Ligurian brood. As it is probable that some hours will elapse before the whole of the bees will have ascended to the combs above them, it would be well to leave them as they are upon their own stands until the next morning, when the lower and now empty hives may be removed, and the full ones set down on their floor-boards. By these means the bees will retain their accustomed stands, the Ligurian queen will deposit eggs in the combs formerly belonging to the black bees, while the latter will be raising queen cells on the combs in the hive lately occupied by the Ligurians, and thus a pure-bred Ligurian queen will certainly be hatched there.

Ten days afterwards, when the eggs of the black queen will have become too old to be raised into queens, and the Ligurian queen will have deposited many thousands of eggs from which pure queens can be raised, the operations above described may be repeated, a second black stock being brought under the influence of the Ligurian queen and bees in the same order of sequence, without any fear of failure except from causes at present beyond human control; and thus, by the repeated exchanges of hives of combs, and causing those of the black bees to be successively filled with eggs by the Ligurian queen, from which eggs the stocks of queenless black bees must raise Ligurian queens, a whole apiary may in a short time be entirely Ligurianized. One great advantage of this plan of exchanges of populations and brood-combs is, that when the young queens hatch out, they often lead off swarms, so that stocks may not only be Ligurianized, but the process often leads to multiplication in what may be considered a natural way, although the condition of things leading up to it has been artificially brought about.

*Honey Gathering—Feeding.*—The number of days in a season in which bees gather more than is consumed in breeding, or by young bees, which gather nothing for about the first ten days of their existence, is more limited than most persons suppose. Some seasons it is less than a fortnight. Feeding swarms, which are weak in stores, to enable them to pass the winter in safety, should be done as rapidly as possible after the queen has ceased laying in October, otherwise they will consume much in rearing young, when their population may be already sufficiently strong. By feeding regularly and sparingly, I have kept young queens laying, more or less freely, until the middle of November.—E. PARNLY, *New York*.



## Correspondence.

\* \* \* *These columns are open to Subscribers, so that their queries, replies, correspondence, and experiences, may be fully and faithfully recorded: and for the discussion of all theories and systems in Bee-culture, and of the relative merits of all hives and appurtenances, that the truth regarding them may be ascertained. The Editor, therefore, must not be expected to coincide with all the views expressed by the various writers.*

### LIGURIAN VERSUS BLACK BEES.

The weather during the past month has not been such as to raise the spirits of the apiculturist; and, since in times of depression, it is well to have our minds diverted to such remembrances as may tend to revive our hopes, I answer to the challenge of our Editor thrown down some two months since in reference to my experiences with Ligurians. Having promised, late in 1871, to give a lecture on the honey-bee for the benefit of the funds of an institution, our Editor generously put his resources at my disposal, and sent me, among other things, a really splendid super, the like of which may we see in serried ranks at our coming Show. The sight of it, eclipsing as it did so completely anything that I had hitherto produced with my black stocks, led me to reflect that perhaps different results were not exclusively caused by variations in locality and diverse methods administered with unequal experience and attention, but that race in the bee might have much to do with the matter.

In consequence, in the spring of 1872 the first Hanwell swarm (fine Ligurians), which came off on April 28th, reached me at night in an ordinary Woodbury hive. The weather almost immediately set in wet, and rain poured down daily and almost ceaselessly for more than a fortnight, while the temperature was unusually low. I fed, however, every night, and so not only supplied the large amount of sugar necessary to the wax-workers in order that the wax might be secreted, but kept up the comb-building impulse, which is, perhaps, even more important; for when the fine weather set in much comb was complete, and all were in a fit mood to take every possible advantage of it. The result is soon told: on July 15th, *i.e.* in eleven weeks, the swarm had not only completely filled the hive, but had also thoroughly filled and sealed a large super with beautiful comb. It was on that day removed and found to weigh 44lbs. net. A smaller super of glass was now put upon the hive, and on August 15th removed, containing 10lbs. net; making 54lbs. net from a swarm which was left with a hive so full of store that stimulative feeding in 1873 was prevented, as it would have crippled breeding. The bees came out to swarm on May 1st, the following spring, but lost their queen and returned, unfortunately or fortunately I will not now determine; for nine days after came their first, the following day a second, three days more and a third issued, and now last, and this time least, on the morrow their fourth issued. The fun of the thing, as the boy says, induced me to hive it. The poor mother hive some would have thought by this time must have suffered too serious a depopu-

lation to allow it to do anything; but I, dreading a further instalment of bees, and being incapable of cutting out queen-cells, as the combs had not been built quite straight, clapped on a super, and in this I removed in the autumn between 20 and 30lbs. of honey. To return to my swarms: the first three succeeded well, the first making about 1400 inches of comb, but giving no surplus; the second filled a Woodbury and gave about 10lbs. in a glass super; the third built about 1200 inches of comb. The first and third I divided into three, all of which were left strong in the autumn. The fourth was reserved for experiment, and had four different queens during the summer, and all the brood was at one time destroyed in an attempt to feed with artificial nitrogenous food, which it was hoped might answer as a substitute for pollen. It has, nevertheless, pulled through, and is now ripe for swarming, and all the others have wintered as well as could be desired. The total comb built by the four swarms made into five stocks could not have been less than 36 superficial feet, and that during an exceedingly bad year. This success is, I think, due in considerable measure to the highly prolific queen which accompanied the early swarm of 1872. This opens up one of the most important and interesting questions in apiculture, namely, that of race. Upon this matter I shall ask permission at a future time to offer some remarks.—  
F. CHESHIRE, *The Avenue, Acton, W.*

### EXPERIENCE OF A BEE-KEEPER.

In forwarding my subscription for Vol. II. of the *Bee Journal*, allow me to congratulate you on the completion of your first year of office in the cause of apiculture.

I am sure your subscribers must feel that much has been done in your columns to disseminate a love for this most delightful of all 'hobbies.' I have felt both pleasure and pain on reading the contents of this month's Journal—pleasure at the hearty 'hurrah!' of 'Novice' and his account of 'grand prospects;' but I *do* hope he will not have to be 'pulled up' for 'shouting before he is out of the wood.'

I write this in a more northerly latitude than, I presume, he occupies; but regarding my prospects, I can only say, these cold winds have completely stopped work in my apiary (except pollen-gathering), and I have had to re-commence feeding a few of my stocks, though they are all strong in bees. Of course a day or two may alter this state of things, so let us hope 1874 may prove as good a year as you appear to think it will.

I wish some of your scientific readers would try and give us an explanation of the excessive mortality which has prevailed among bees in many districts.

I thought myself badly off in having lost seven stocks out of nineteen, but when I read the account of your unfortunate contributor, 'J. C.,' and also heard that whole districts in Ireland had been completely depopulated of 'honey-gatherers,' I am fain to think my dozen really good stocks make no bad show after all; and if our friend, 'Novice' can shout 'hurrah!' with such gusto, seeing that he and I are about equal in misfortune, I'll join in his cheer, and

hope he may astonish us all, and *I astonish him*, in September.

I have been quite unable to account for one case in which a stock looked quite strong in bees and honey, last March, and yet has dwindled away since. Of course I set it down as 'queenless;' but, judge my surprise, when, seeing it was being robbed, I turned it up and found the queen just within the entrance, as if she had attempted to crawl away from the scene of pillage going on in her domicile. There were a dozen or two of dead bees on the floor-board; and it seemed as if the bulk of what bees were left alive had attempted to enter the adjoining hive, as a good number of dead bees were scattered in front of it; and it was not near enough to cause the robber bees to disturb it. The poor queen, however, was nearly dead, and there was, as far as I could see, not a particle of brood in the hive; so what has caused the disaster I am utterly unable to tell, as I have never had a similar case in my experience, and I am curious to know if you can explain it. I send the queen for your inspection. By the way, I think she is two years old; and the stock, of which she was the head, did very well last summer.

I should have been delighted to assist at your meeting on Saturday next, but a journey of a couple of hundred miles is no joke; and as I hope to have the pleasure of making that journey in September, to see our 'Show' at Sydenham, I must be content in hoping you may have as many present as will suffice to lay the foundation, on a solid basis, of our new association, and that *harmony* and good fellowship may prevail. Wishing you and the Journal every success.—W. BROUGHTON CARR, *Higher Bebington, Cheshire.*

P.S.—The hive on which I have asked your opinion had unfortunately 'fixed combs;' indeed, I am sorry to say, most of my hives are little more than improved 'straw skeps;' but I am decidedly of opinion that 'frame hives' are the best.—W. B. C.

[It is quite unnecessary to trouble any of our scientific friends to explain the cause of the fearful mortality which has visited so many apiaries throughout the land, since so long ago as August last we foresaw the danger and warned our readers against it. If our esteemed correspondent will refer to Vol. I. page 67, published September 1st, he will find '*the red light*' conspicuously displayed, which, if regarded, would have prevented the wreck of many apiaries; yet, when we turned it on, Mr. Pettigrew, in the *Journal of Horticulture*, condemned the course we recommended, and assured the apiarian world that it was not 'advanced bee management.' We said in effect (considering the season, 1873), that if late autumn breeding were not encouraged by gentle stimulative feeding, that the bees then in the hive (September 1) would all be comparatively aged before winter actually set in, and that in spring, when they should be breeding most rapidly, they would be dying off, unable to maintain the heat necessary to life; and we finished the paragraph with a quotation many have since unwillingly made in describing their losses, '*that after passing the winter well they come to grief in the spring, with plenty of food in the hive.*' We do not like '*prophesying after the event*,' but will remind our friends that, in many instances, breeding was discontinued in August of last year, and consequently, before the beginning of December, the bees must all have been two months old. The life of a bee is very short during the active period of its existence; and, as during these two months it could hardly be ex-

pected to be idle, a great deal of its vitality and strength was expended before it went into winter quarters. It is easy then, with these facts in view, to see how, and why, the 'excessive mortality' occurred; primarily, it was caused by the season; secondly, being preventable, it was by the default of the bee-keepers, who did not adopt the means of prevention; and thirdly, it was through the uncertainty which must have existed in the minds of bee-keepers as to which of two professed leaders they should follow or be guided by. We claim, however, that we forewarned our readers of the probable effects of the untoward season, 1873, and pointed out the means of preventing the mischief likely to ensue; and fortunate were they who followed *our* advice thereon.—Ed.]

#### DRONES AS FERTILIZERS: ORIGIN OF FOUL BROOD.

As promised in my letter to you, which appeared in your first Number of the new volume of the *British Bee Journal*, I now wish to give you my experience of the value of drones, the produce of an unfertilized queen, as fertilizers.

My young queens, two in number, were hatched out respectively April 16th and April 23rd; and as the weather from the 16th to the 30th of April was everything that could be wished from a bee-keeper's point of view, and as on each day between those dates the drones from the hive containing the unfertilized and drone-producing queens were flying in great numbers, there was no reason why my young queens should not have been fecundated, and have proceeded to produce young worker-bees in the usual way. *Such, however, was not the case.* On 28th of April I made an examination of the hive containing the young queen hatched on April 16th, and found eggs laid in quantity. All right, thinks I, abnormal drones are useful after all, and for the future I know how to raise pure queens early in the season. Imagine my disappointment, when on May 10th I made a further examination and found that all the cells occupied by eggs had been elongated by the bees, and that all the brood was undoubtedly *drone* brood. Thinking, perhaps, that, as sometimes is the case, the queen had commenced by producing drones, but would, after all, proceed as a properly fertilized mother, I waited until May 20th and made another examination, and finding that no change in her production had taken place, I officiated as executioner, and off came her head. The queen hatched on April 23rd proceeded exactly in the same manner, and I 'rubbed her out' on May 27th; and have no hesitation in recording my conviction that, as *fertilizers*, the drones produced by an unfertilized mother are not only positively useless, but may prove an injury in an apiary where they are allowed to be produced during the time that queens are seeking impregnation. I found this latter opinion upon the fact that my first hatched queen commenced to lay eggs and filled her combs just as a properly fertilized queen would have done, and am of opinion that she had mated with one of my abnormal drones, and considered herself properly 'married.' The later hatched queen did not lay anything like the same quantity of eggs, but acted exactly as a queen would do who had never been fertilized, and only deposited a few, which she appeared to know were not properly



fecundated; and she, in my opinion, having been born a week later, had not taken her flight for impregnation purposes until the weather had changed colder, and she had not succeeded in meeting even an abnormal drone. These are my decided opinions, and you, of course, will take them for what, in your consideration, they are worth.

Thus ends my first experiment for the present season; but, Mr. Editor, I have another in contemplation, and as it has connexion with that subject of vital importance to all bee-keepers,—foul-brood,—I will first give you my ideas with regard to the production of that malady, hoping that you will not hold me up to ridicule if my opinions run contrary to any generally accepted belief.

My decided belief, formed on actual experience, is that foul-brood originates in the death of the brood at a certain stage in its existence, which I will define as the 'skin-and-squash' stage, that is, just after the sealing over has been accomplished, and when the larva presents the appearance of an overgrown maggot, having not the slightest resemblance in form to the insect that it is in future destined to become. I believe that at this stage, should death occur, the bees are unable to ascertain the fact until the time when the perfect insect should emerge, and by which time the cell is occupied only by a putrid mass of matter. This the bees will not remove, but allow it to remain, only to still further increase the evil by the pestilential vapour exhaled from the rotting remains of the grub. Brood that dies before sealing over is removed at once, as is also that which having reached the imago state can be taken from the cells whole.

In proof of this notion there is the fact that a small hole is punctured in the covering of the cell by the bees, to ascertain the state of the contents of the cell that fails at the proper time to send forth its occupant to increase the population of the hive.

These, sir, are my ideas upon the matter. Crude as yet, but which it is my intention to verify or refute, by the simple experiment of starving to death the whole of the brood of a hive, which I shall then return to the bees, and at the end of the season mark the result; and as a single instance proves nothing, I ask some few of our bee-keeping brethren to assist me by performing the same experiment, and reporting the result at the Crystal Palace meeting in September next. And I hope that many will be found willing to risk the loss of a single stock in elucidating the great mystery of 'the origin of foul brood.' We will then turn our attention to the matter of next greatest importance, 'How it can be eradicated.'

I would proceed to adduce arguments as to how this fell disease is produced in apiaries where natural swarming only is practised, but fear to trespass too much upon your space. At some future time I will give you my ideas upon this matter also. At present I will refrain from further remark; but in conclusion will earnestly ask those amongst us who have the interest of apiculture at heart to assist me to the utmost in the investigation by devoting at least one hive to the experiment. Deprive it of its

living and moving occupants, let the brood die from lack of warmth, and then returning the bees, see whether or not the *whole* of the dead brood is removed, or whether that, in the stage I have described, is allowed to remain and create the germs of a disease which is, and has been, the only bar to success in apiculture, and they shall each and all have the warmest thanks of your correspondent,—NOVICE.

#### PREPARING FOR THE SHOW.

I had a very large swarm of bees brought me last evening by the head gardener of the Waldashare Park Gardens, weighing  $5\frac{1}{4}$  lbs., and therefore, as we suppose, containing at least 26,000 labourers. I put them at once into a ten-framed hive of my own invention and construction, called the 'Sibertswold Hive;' and I hope to exhibit it, with a super of the same dimensions, at the Crystal Palace Show in the month of September. There was one swarm in this village on the 16th, which was the first in this neighbourhood, and I had one brought me on the 19th.

I was exceedingly sorry not to be able to attend your meeting on Saturday, the 16th of this month, and I am all anxiety to know what was done in reference to the list of prizes.—SIBERT-ON-THE-WOLD, near Dover, May 23, 1874.

#### MAJOR MUNN'S OBSERVATORY HIVE.

In reply to Query No. 89 I beg to inform you that my father was in the habit of putting warm wax along the *inside* of the frames for the comb, which he found made the bees build straight, so that the frames could be raised for inspection when required. Last year he was most successful in having the sets built straight. Had his life been spared he would have completed a still further improvement. My mother thought you would be glad to know these particulars, as the paper had been kindly sent to her.—C. AUGUSTUS MUNN, *Churchill House, Dover, April 22.*

### Queries and Replies.

QUERY No. 93.—Given, a swarm of bees, weighing eight pounds at the time they are hived, what will be the weight of the swarm at the end of three days' *confinement* in the hive, and when they have expended the food that their honey-bags contained when they emerged from the parent hive? Is it not a very fair way to sell swarms by *weight*, especially where the purchaser cannot inspect them—and are they often so sold? If so, what is the average price per pound? I suppose an eight-pound swarm would be a very large one, would it not? I saw drones at one of my hives yesterday; it is one that I headed with a Ligurian queen last autumn. I never saw drones at any of my thriving stocks of bees so early before, and it gives me great encouragement.—J. ENOCK, *Sibford, Gower, near Banbury, April 4, 1874.*

REPLY to No 93.—An eight-pound swarm of bees would be a very large one indeed. One pound

of bees (avoidupois) contains about 5000, therefore an eight-pound swarm would consist of near 40,000 bees, a number much larger than the whole population of many a good colony. We have no experience of the loss in weight which would occur in swarms confined for three days after hiving, but should estimate it at least at one-half. You will find a most interesting register of the vicissitudes of weight in a colony weighed every day, from the time of hiving, in No. 13 of the *Journal*, p. 11, carefully taken by a most painstaking apiarian in Copenhagen, in which it will appear that, although fed for the first three days, it only increased half a pound in weight.

When the purchaser *cannot inspect* the swarms he buys, he is liable to be much imposed upon, as weight may be fraudulently added either to the hive or its contents, and consequently must, in a great measure, trust to the honour of the seller, which he might more gracefully do in the first instance—taking the swarm on the recommendation of the latter as a *good one*. The value of swarms consists, in a great degree, on the youth and vigour of the queen and bees; an average swarm of three and a half to four pounds, all young and vigorous, being far more valuable than a much larger one with an old and nearly worn-out queen. Such a swarm of three pounds, at the end of April, tickled along with a few ounces of syrup daily, will outstrip one of double the size coming at the end of June. Ligurian swarms are sold at from two to three guineas each, averaging 10s. 6d. to 12s. 6d. per pound weight, for few are sent out exceeding five pounds, and such a weight is exceptional; but as before said, so much depends on the time, place, and season, and on the age and quality of the queen and bees, that no standard price per pound can be given.

English black swarms usually sell at from 2s. 6d. to 7s. per pound, the price varying from 10s. 6d. to a guinea. Your drones are exceptionally early—we should think the first normally produced in this country this year.—Ed.

QUERY No. 94.—Late last season I had a few bees in a Woodbury frame-hive, and by way of experiment tried if I could keep them through the winter; of course I fed them both late and early. I looked them carefully over about three weeks since, and found four frames about half full of comb; and, as I thought, enough honey in two of the combs to see them through. This morning I looked at them again, and found them dead. Of course there is a lot of brood comb. I am expecting a swarm from an old straw hive; would you advise me to put it into the frame hive? If so, am I to cut the brood comb out, or leave it for the bees to do as they like with it? An answer will oblige.—ROBT. NICHOLSON, May 16.

REPLY TO No. 94.—We would cut out all the parts of the combs which contain brood or larvae before admitting the swarm to them, as if any of it be rotten or rotting the bees of the swarm will be unable to remove it, and if left in the hive it may cause disease.—Ed.

QUERY No. 95.—Will you kindly give me your advice about the following?—I am in doubt, now that the time for swarming approaches, what course to take with my apiary. My difficulty is preventing some of my hives from being attacked and robbed in the autumn by my other hives. Last year I lost several hives in this way,

after trying every thing to stop their being robbed. Should you keep so many together (say about fifteen hives or so), or as they swarm place them some little distance away, about 200 yards? My hives are the Woodbury and straw, the latter I cannot prevent swarming. I do not devote as much time to my apiary as I should wish, business preventing; but notwithstanding this I am just as much interested in them as ever. I am also much pleased with your monthly *Journal*, which evidently seems a great success. Kindly send me a line at your earliest convenience.—J. N. B.

[In reply we asked for further particulars as to location of hives, the kind of stands, distance apart, &c., and received the following.—Ed.]

April 20.

I am much obliged for your reply to my note, and will now inform you of the position of my hives, so that you will be better able to judge before giving your opinion as to the cause of fighting, &c., last year. My apiary consists of about twelve hives. They are placed nearly two feet from each other, on separate stands, in a straight line down the garden, nearly south aspect. The stands are very firm and cannot be shaken by passing winds. All face the same way, and have a hedge three feet behind them. I shall be glad to hear what you think respecting the best thing to do with them. I have a Woodbury hive very much behindhand: what would you do with it? My other hives are doing well, and I do not wish to join them on account of disturbing them. The Woodbury hive has a queen, and when last I opened the hive found a fair amount of brood.—J. N. BOWER, *Knowle*.

REPLY TO No. 95.—Your trouble in autumn arises from your hives being too near each other, and consequently being liable to be mistaken for each other by returning bees. During the summer, while returning wanderers come laden, they are welcomed anywhere, and thus acquire the odour of hives to which they do not belong, which goes on until the identity of individual hives is destroyed, and the stocks get on visiting terms with each other. This is all very well while each returning bee brings in a load of bread or honey; but in autumn, when neither can be found, the question arises amongst them which is to be the general storehouse, and then each begins to defend itself, and attack the others, and there is soon a general disturbance, which is sure to end in the destruction of some of the stocks.

The best course to adopt is to scatter the hives—remove the pair of hives at each end of the row a few inches per day, until they are at least twelve feet from the others, and each two, four feet apart. At the same time Nos. 4 and 9 should be advanced obliquely outwards until they clear the fronts of the first-named pairs. Nos. 6 and 7 should also be advanced direct to the front, as far as permissible, and gradually set further apart, and this will completely break the line, and doubtless prevent robbing in future. The Woodbury hive appears to require stimulative feeding only, to enable it to keep up its breeding.

The days are early yet, and one swallow does not make a summer; neither do a few sunny days. We shall have some such weather as made the swallow in the fable die on the ground ere May has passed, or this will be the most wonderful season we have ever known.—Ed.

Covers for Binding the BRITISH BEE JOURNAL, Lettered Backs, 1s. each: with Number containing Index, 1s. 6d.

# British Bee-keepers' Association

(INSTITUTED MAY, 1874)

For the Encouragement, Improvement, and Advancement of Bee Culture in the United Kingdom, particularly as a means of bettering the condition of Cottagers and the Agricultural Labouring Classes, as well as the advocacy of humanity to the industrious labourer—the Honey-Bee.

*The Association will hold their First Great Exhibition of*

**BEEES AND THEIR PRODUCE, HIVES, AND BEE FURNITURE,**

AT

**THE CRYSTAL PALACE,**

**SEPTEMBER 8th, 9th, and 10th, 1874,**

BEING THE DAYS OF THE AUTUMN FRUIT AND FLOWER SHOW.

## SCHEDULE OF PRIZES.

CLASS	HIVES.	PRIZES.
1.	For the best Hive for Observation purposes ... ..	2,0,0 and Certificate.
2.	For the best Skep or Box Hive for depriving purposes, for Cottagers' use, that can be supplied for 3s. exclusive of floor-board ... ..	2,0,0 and Certificate.
3.	For the best Moveable Comb-hive, for depriving purposes ... ..	2,0,0 and Certificate.
4.	For the best Hive, for use on the storefying principle ... ..	2,0,0 and Certificate.
5.	For the best Hive, for use on the collateral principle ... ..	2,0,0 and Certificate.
6.	For the most Economical (best and cheapest) complete Hive on the moveable-comb principle, for Cottagers' use ... ..	2,0,0 and Certificate.

### B E E S.

7. For the most beautiful breed of Ligurian Bees, *i.e.* a Queen, accompanied by her progeny, the beauty of the Queen to be of secondary importance... .. 2,0,0
- The Bees to be exhibited in Observatory Hives.

### HONEY.

	1	2	3
8. For the largest and best harvest from one stock of Bees, under any system or combination of systems, the same to be declared on exhibition ... ..	3,0,0	1,0,0	10,0
9. For the best Exhibition of Super Honey from one apiary ... ..	3,0,0	1,0,0	10,0
10. For the best Straw Super of Honey, net contents above 20lbs. ... ..	2,0,0	1,0,0	10,0
11. For the best Straw Snper of Honey, net contents not under 14lbs. nor above 20lbs. ... ..	1,0,0	12,6	7,6
12. For the best Straw Snper of Honey, net contents not under 10lbs. nor above 14lbs. ... ..	15,0	10,0	5,0
13. For the best Wood Super of Honey (or wood in combination with glass or straw), net contents above 20lbs. ... ..	2,0,0	1,0,0	10,0
14. For the best Wood Super of Honey (or wood in combination with glass or straw), net contents not under 14lbs. nor above 20lbs. ... ..	1,0,0	12,6	7,6
15. For the best Wood Super of Honey (or wood in combination with glass or straw), net contents not under 10lbs. nor above 14lbs. ... ..	15,0	10,0	5,0
16. For the best Glass Super of Honey, net contents above 20lbs. ... ..	2,0,0	1,0,0	10,0
17. For the best Glass Super of Honey, net contents not under 14lbs. nor above 20lbs. ... ..	1,0,0	12,6	7,6
18. For the best Glass Super of Honey, net contents not under 10lbs. nor above 14lbs. ... ..	15,0	10,0	7,0
19. For the best Glass Super of Honey, net contents not under 6lbs. nor above 10lbs. ... ..	10,0	7,6	5,0

CLASS	HONEY (Continued).			PRIZES.		
				1	2	3
20. For the best display of Honey in comb for table use ... ..	2/0/0	1/0/0	10/0			
21. For the best exhibition of Run Honey in glasses of from 5lbs. to 10lbs. each, net contents, the produce of one apiary ... ..	1/0/0	12/6	7/6			
22. For the best exhibition of Run Heather Honey in glasses of from 5lbs. to 10lbs. net contents	1/0/0	12/6	7/6			
23. For the best exhibition of Honey obtained by the use of the Honey Extractor from one colony	1/0/0	12/6	7/6			

*Cottagers' Classes, open only to those who work for daily hire.*

CLASS	PRIZES.					
	1	2	3	4	5	6
24. For the largest and best exhibition of Super Honey in Comb, gathered by one stock, or united swarms of Bees, the property of exhibitor ... ..	3/0/0	2/10/0	2/0/0	1/10/0	1/0/0	10/0
25. For the best exhibition of Honey in Comb, produced in one apiary without the destruction of the Bees ... ..	2/0/0	1/10/0	1/0/0	10/0		
26. For the best exhibition of Run Honey, in glass jars containing from 5lbs. to 10lbs. each ... ..	2/0/0	1/10/0	1/0/0	10/0		

*All the Honey and Comb exhibited in the above classes must be bona fide the produce of 1874, and gathered by the Bees in the natural way in the United Kingdom.*

MISCELLANEOUS.

27. For the best and largest collection of Hives, Bee Furniture, Bee Gear, and Apiculturists' Necessaries, no two articles to be alike ... ..	3/0/0	2/0/0	1/0/0			
28. For the best Drone-trap ... ..	1/0/0					Certificate
29. For the best Bee-feeder, the invention or adaptation of the exhibitor ... ..	1/0/0					and Certificate.
30. For the best appliance for introducing alien Queen Bees to Stocks ... ..	1/0/0					and Certificate.
31. For the best Bee Dress ... ..	1/0/0					and Certificate.
32. For the best method of Quieting Bees during Manipulation, with appliances shown ... ..	1/0/0					and Certificate.
33. For the cheapest and best Supers for General Use in an Apiary ... ..	1/0/0					and Certificate.
34. For the best Honey Extractor ... ..	2/0/0					and Certificate.
35. For the best Machine for Embossing Wax Sheets for Guide Combs, with at least six sheets manufactured by it ... ..	1/0/0					and Certificate.
36. For the best Exhibition of Pure Bees'-wax, the produce of 1874, in cakes of not less than 1lb. in weight ... ..	10/0	7/6	2/6			
37. For any new invention calculated in the opinion of the Judges to advance the Culture of Bees	Extra Prize					
38. For the best Glasses for storing Run Honey ... ..	Certificate					
39. For the best Essay on the means of obtaining the fertilization of Queen Bees by selected drones (proved to be practicable to the satisfaction of the Judges) ... ..	3/0/0					
40. For the best Essay on the cause, prevention, and eradication of Foul-brood ... ..	5/0/0					

Every intending Exhibitor must register his name with a fee of One Shilling (which shall be the entry-fee for one exhibit in any class) by July 1; any additional number of entries may be afterwards made on or before August 15 on payment of an additional fee of One Shilling each.

EACH EXHIBITOR WILL HAVE FREE ENTRY TO THE SHOW.

It is intended, if facilities can be arranged, to give a practical exhibition of manipulating with live bees, such as driving, making artificial swarms, transferring combs and bees from straw skeps to frame hives, finding queens, &c.—several experienced Bee-masters having tendered their services.

Donations in aid of the Prize Fund will be thankfully received.

JOHN HUNTER, Hon. Sec.

*Eaton Rise, Ealing, Middlesex.*

THE  
**British Bee Journal,**  
AND BEE-KEEPER'S ADVISER.

[No. 15. VOL. II.]

JULY, 1874.

[PUBLISHED MONTHLY.]

Editorial, Notices, &c.

BRITISH  
BEE-KEEPERS' ASSOCIATION.

THE Committee of the Association held a meeting at the Crystal Palace on June 6th, when they satisfactorily arranged with the managers many details for the forthcoming Show. Space for the exhibits is allotted in the nave alongside of the flowers and fruit, and will extend into the adjoining courts if necessary; in addition to which an exterior balcony, 100 feet long by 30 feet wide, has been placed at the disposal of the Association, in which the exhibition of bee management will take place. This balcony will be divided down the middle by a glass screen, from behind which the general public will be enabled to view, in perfect safety, all the operations, such as driving, transferring, &c.

The Committee will also arrange facilities for the sale of exhibits, whenever wished by their owners; and in order to lay the nucleus of a 'Honey Fair' will book orders for honey for any member who can ensure its delivery.

*Eaton Rise, Ealing.*

JOHN HUNTER,  
*Hon. Sec.*

\* \* We are glad to add our testimony to the readiness with which the managers promised the facilities requested for the exhibition. We have made a great effort to establish a Beekeepers' Association, and a Bee and Honey Show, which shall be worthy of the times in which we live; the objects in view in their establishment have been fully set forth, and are identical, the advancement of bee-culture as a means of improving the condition of our rural population being the most prominent.

The Honey Show must essentially depend upon the weather, for unless that be favourable, an extensive exhibition can scarcely be expected, but in all other matters success will entirely depend upon the efforts of bee-keepers themselves. That the weather has *not* been favourable hitherto must be patent to every candid mind, yet the interest evinced by the intending exhibitors, under such adverse circumstances, sufficiently justifies our most

sanguine hopes and anticipations. It is evident, except in very isolated cases, that the idea of exhibiting supers must be bred of Hope, the sister of Faith; relying on the olden promise that, summer and winter, seed-time and harvest, shall continue; for up to now there is very little sign of surplus, the bees being scarcely able to procure sufficient honey for their existence. In the face of such discouraging appearances, we think the date for declaration of entries should be extended, and at the next meeting of the Committee shall urge the same as forcibly as possible. With the other features of the Exhibition the weather has nothing to do, except in so far as it may militate against the manipulation with live bees, which however, taking place, as it will, on an extensive covered balcony, will not be much affected. Here is a field for operations, which may be made of sufficient interest to ensure the stability of the Association, and the establishment of the Exhibition as an annual one. Let our bee-masters, who write and tell the world how easy it is to manipulate with bees, come forward and *show how it is done*, and we feel confident the interest in our favourites will be increased tenfold, and a repetition of performance will be most anxiously looked forward to.

The Association, we are glad to say, is going on well, members daily joining from all parts of the kingdom. The Prize Fund also continues to increase, and, taking things altogether, we are very hopeful that the Apicultural Exhibition will be a grand success. Members of the Association and Exhibitors have free admission to the Palace Show.—ED. B. B. J.

THE PAST MONTH.

Although the month of May was so untoward, it nevertheless did not pass quite away without one rainbow of promise, for on the 25th the storm indicated on the previous day burst upon us, and rain, with hail, came down in torrents. Meteorologists often compute the quantity of rainfall due; and although we cannot say that our due was paid in full, we record that in our neighbourhood two inches of water fell in a few hours, and gave the earth and its fulness a

refresher which was most gratifying to all the 'culturists' who depend on the weather for the increase so kindly and willingly yielded by our great Mother, always big with lovingkindness, and only waiting for opportunity to lavish her secret treasures. After the storm, we were favoured with two or three days of sunshine, during which the chestnut blossoms, having fulfilled their mission in everything but their honey-yield, gradually resolved themselves into berries, bearing witness that the marriage of flowers does not depend wholly upon the attractions offered to the bees by the nectar they usually yield for its consummation, pollen alone being apparently a sufficient inducement.

In the meantime bees were busy upon the opening beans, and all the *brassicas*; and clover now began to decorate the fields with its 'honeysuckle,' while the hedgerows became brilliant with the wild honey-yielding roses of the briar, but still was there no sign of honey-gathering. On the 3rd, a slight and partial shower gave us a refresher, and for three days a little honey was obtainable. On the 6th, at even, a tremendous storm of wind and rain visited us, two and a half inches having fallen into a tin which was accidentally left in the apiary. Fine weather was now the order of the day until the 12th, when a sharp frost visited us, cutting down the early potatoes and runner beans, and causing the bees of weak stocks to desert their side combs and cluster together for mutual warmth and protection, leaving the brood to become chilled; and, if 'Novice's' theory is correct, to degenerate into foul brood. Since then the weather has been exceedingly cold, except on the 15th and 22nd of the month; and although the fields, commons, hedges, and waysides, have been glistening with white clover, wild roses, and myriads of other flowers always welcomed by the bee-keeper, the bees, except in very strong stocks, were weather-bound and inactive, and in many instances barely able to obtain a livelihood.

### JULY.

THE SEASON.—This being a very late season it is very probable that swarming will be protracted until the commencement of this month, and although the old adage says, 'A swarm in July is not worth a fly,' it may, in many instances, be thought desirable to keep such for increase of stock. In these cases it would be almost absurd to expect any surplus honey, since the greatest care will be necessary to enable the bees to furnish their hives with sufficient comb, brood, and stores, before the honey-harvest is over and preparation for winter commences. The great secret of success with swarms is in keeping

up their natural comb-building impulse until their hives are completely filled. Naturally bees will not swarm until there is such an incoming of honey as will guarantee them against all probable risk in their endeavour to found a new colony; yet it often happens that through some unkind change in the weather their income is cut off, their 'bank' is broken, and they are reduced to a state of comparative poverty. The first effect of this is a cessation of comb-building, and consequently of breeding, for if cells be not built eggs cannot be deposited; and if matters become no worse it will be evident that the prosperity of the new colony must be materially interfered with. But the cause of the evil may continue, and complete destitution ensue, which will cause the bees to destroy or consume the brood already within the hive; and if aid be withheld they will perish. Supposing, however, that the evil does not proceed so far—that the bees simply receive a check which prevents the continuation of their building operations—it may be taken for granted that those operations will not be resumed under any circumstances until room is required for honey-storing, when they will build drone or store-comb only. A sudden check at this time causes the stock, even though afterwards built up to an enormous weight, to be comparatively valueless for stock, on account of the small quantity of worker-comb which the hives will contain, and the utter inability of the queen to deposit sufficient eggs in worker-cells to create a population capable of storing honey, whilst raising such a large supply of drones as would be sure to be produced if the supply of stores warranted the production of brood beyond the limited circle of the original brood-nest; and if it did not, it is manifest the stock must always remain puerile and useless. It should therefore be the first care of the bee-keeper to feed his swarms on all occasions when they are unable to gather honey, until their hives are completely furnished with combs. At this time of year this duty is more imperative on account of the waste of time and energy which must ensue if the bees are compelled to extra labour to obtain the needful supplies, for it must be borne in mind that the natural life of a bee is not a question of time, but of labour; and, therefore, the saving of labour to the bees of a swarm prolongs their existence and increases their aggregate value, since it enables them to continue strong in numbers until their brood begins to hatch; and, as a consequence, more brood will have been brought to perfection than could have been developed under the adverse conditions mentioned, which are so often allowed to waste the vital energy, and reduce the population of newly-founded colonies.

CASTS.—On page 128, Vol. I., there is an account of 'What may be done with a cast;' and where stock is wanted we recommend bee-keepers to do likewise.

Casts are composed of almost all young bees, the majority being not more than a week or ten days old; and although accompanying a young, unfertile queen, they always build worker-combs exclusively until they have made their brood-nest as large as they are capable of attending to. Being all young bees they live much longer than those accompanying the old queens with first swarms, and are capable of more continuous labour without the waste of life which usually occurs with the latter; hence a fair-sized cast, even in the middle of July, if aided occasionally with a bottle of syrup, and provided its queen is successful in her mating tour, may become a valuable stock before the cold weather sets in, and will have the advantage of the youthful and vigorous queen. When casts are small it is well to add them to other casts, or to return them to the parent stocks, unless combs can be given to them, when it often happens that they go on increasing so rapidly as to form good colonies. A youthful, vigorous queen, and bees that are not likely to die of old age for some time, are not to be despised, even though they be comparatively few in numbers; and when stock is wanted it must be the fault of the bee-master if they do not prosper.

The mortality of the past winter, and the cold, uncannic weather of the spring, have made bees so scarce that every attempt will be made by bee-masters to increase their stocks as much as possible, and, considering the value of those possessing young queens, it will be worth attempting to build up all the casts that come to hand.

BEE-TRAP.—Notwithstanding the unprecedented bad spring of 1874 there are cases in which strong stocks have stored surplus honey in supers; and if the weather will permit the limes and white clover to yield their abundance, there is little doubt but that a goodly show will be made at the Crystal Palace after all. Many find a difficulty in clearing their supers of bees; but by the aid of Aston's bee-trap, or some similar contrivance, the matter may be very easily accomplished. It is only necessary to fit one of them to a large box, close to and even with the floor, that its passage may be found without labour by the gorged bees. When supers are removed, they should be placed in the box in such a way as will permit the bees to escape from them, and the lid should be shut down. There need be no watching or waiting about; the trap is bound to act; and the bees, finding themselves in a somewhat unusual locality or habitation, will rush to the

light to ascertain their whereabouts; and once outside, return will be impossible. It is immaterial how many supers are stowed in the box: they are sure to clear themselves unless the queens are in them, in which case they should be replaced on their hives, and left there until the brood (if any) is hatched out. Many bee-keepers, finding brood in their supers, are in the habit of cutting it out and throwing it away. This is very wasteful and should not be done, as the brood is really of more value than the honey, and costs more to produce; consequently, it should not be wasted. By returning the super to the hive, the brood will hatch out naturally, and the bees will fill the cells with honey, so that, instead of loss, there will be a double saving.

TRANSFERRING QUEEN-CELLS.—Amateurs raising young queens are often in a difficulty about transferring queen-cells from their queen-raising hive to those requiring them. It is not always safe to introduce queen-cells immediately on depriving a stock of its queen, as the bees will often destroy them. Twenty-four hours should be allowed to elapse between the one operation and the other, and even then sometimes the queen-cell will be destroyed.

In cutting out queen-cells for transferring, a portion of comb should be cut out with them; it is usual to cut it in the shape of a V, with the queen-cell upon it, the bottom of the cell being at the bottom of the V; but the shape is quite immaterial, the main object being to cut far enough round the cell to avoid even the slightest damage to its walls, as a slight indent would be almost surely fatal to its occupant. Having cut out the cell (or cells, for it often happens that two or more are built so close together as to be inseparable), the next proceeding is to graft it into the comb selected from the stock it is intended for, which may easily be done by making a corresponding hole and pressing it into it. There is an advantage in the V-shaped arrangement, as if the hole be cut slightly too large the pressure necessary for fixing the cell can be obtained by forcing it gently downwards as a wedge into a cleft, when a couple of needles may be thrust diagonally through the top corners into the comb, and the fixing will be complete so far as the operator is concerned; but the bees will finish the work and join the edges of the adjacent cells, so that the queen-cell will appear to have been originally formed there. Needles are very useful in an apiary, and should form part of the stock in trade of the apiarian. They should be stout and long so that they may be thrust into the wood, if necessary, without breaking, or through a number of cells when it is requisite to fasten the queen-cells with them. They are particularly useful when combs require straight-



ening, as is often the case; for by their aid erratic combs may be held in position by the needles being stuck along their sides into the edges of the frames, or by the use of a fine awl, they may be passed through the centre of the frames, and along both sides of the central division, or foundation of the cells. Almost every one knows that the cells of a comb are built on a common base, from which they point outwards, but it is not generally known that this base is of much stronger material than the walls of the cells, nor that, being corrugated and supported by the walls of the cells, it will stand a very much greater strain than the front edges of the cells themselves; but being so, it affords an easy means of correcting crooked combs, as the needles may be placed close alongside it through the bars, and will in no way interfere with the usefulness of the cells which they pierce, even when allowed to remain in them.

This central base, shown in the engraving in its natural zig-zag, is the part which should always be longitudinally and perpendicularly central in the frames; and therefore, when pieces of comb are being fixed into them, as in transferring, these central parts are those which should be placed in that position, without reference to the length of the cells on either side of them; for it often happens that the cells on the opposite sides of a comb may greatly vary in length; and if in transferring the base or centre is not kept in the centre of the frames, one side of the comb will be rendered useless for breeding, and the other inconvenient.

**ARTIFICIAL SWARMS.**—There seems to be a general complaint of the difficulty experienced in making artificial swarms, by a driving or a drumming, as the queens will not leave their brood-combs; and we are fain to acknowledge that this year we have found them particularly unwilling to do so. Our custom has been when wishing to extract a queen from a skep or box, to drive a moderate quantity of bees in the usual manner, and as a rule, we have found her majesty with the first batch, in fact, so generally was she to be found with them, that we had almost believed the notion that she led them there; but this year's experience is convincing to the contrary, for sometimes the queens will not appear until the fourth or fifth batch of bees have been driven up into the skep. This unwillingness to leave the combs cannot arise from any extraordinary love for the brood, for in most instances there has been very little of it, besides, as a fact, it is fear which causes both bees and queen to leave their hive when

drumming is practised. It is therefore probable, as the combs are light (containing little brood or honey), that the jarring has not the same effect upon them, that the queen, being also light and nimble, is not influenced by fear to the same extent as when her body is fully distended with eggs, and that she is content to seek safety between empty combs at the bottom of the hive, which is seldom beaten in driving; and as a matter of safety to the combs, never ought to be. As it is, however, never safe to make an artificial swarm without combs of brood, without being quite sure of the presence of the queen, it is best to persevere in the drumming until she is found, or if she *will* not come she should be fumigated, and if she does not tumble out of the hive, she should be taken out with a feather.

**DISINFECTING INSTRUMENT.**—In examining and cleaning out old combs in which bees have died during the winter of dysentery, or any other disease which leaves the combs in a doubtful condition, it is advisable to disinfect them; but how to do this with any degree of certainty is a puzzle to most amateur bee-keepers. There is, however, a means to the end, invented for an entirely different purpose, but which answers exceeding well,—driving the disinfectant in the form of spray into every cell, crack, and crevice in the hive, and its appurtenances, to which it may be directed. The instrument, the invention of Dr. Siegel, is here exhibited, it is made of brass, and is

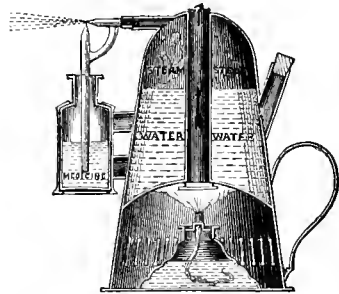

furnished with spirit-lamp, flame-disperser, boiler with funnel through it, steam chamber, and glass jet. This jet is very fine at its nozzle, which points horizontally, the steam passing over a similar tube at right angles perpendicular to it; this second tube dips into a bottle containing the disinfecting fluid, which may be either Condry's Fluid or Chloralum, either of which is innocuous. In operation, the boiler should be nearly filled with water, the bottle with the disinfecting fluid, and the lamp with spirit, and placed a light under the boiler, and in five minutes a jet of steam will be seen issuing from the horizontal tube, which, passing swiftly over the perpendicular one, *will* create a vacuum therein, and cause the fluid in

the bottle to rise up to the top of the tube, where, coming into contact with the steam jet, it is simply pulverized and blown forward in the form of spray. The instrument was invented to blow medicated spray down the human throat, and, as is often the case with scientific machines, its operation being once observed, it soon rendered itself *necessary* for other purposes. The steam spray as it leaves the glass tube, being directed against the bulb of a thermometer, raised the mercury to 146° Fahr.; we, therefore, tried it against the sinuous web of the wax-moth in an old comb, and found it answer exceedingly well; the white worms, where able to do so, making their exit to the other side of the comb, where, to use our assistants' expression, 'they hung gasping.' We have not tried the effect of the spray upon combs affected by foul brood, but do not see why they should not be rendered perfectly sweet and wholesome by its means. We do not go so far as to expect the restoration of combs containing the actual rotten brood; but we do not see why those from which the remains of the brood have been removed, or which are simply infected through being in a foul-brood hive, should not be perfectly disinfected. The rotten brood would, of course, require the disinfecting agent to be thoroughly incorporated with it, which it is not professed the spray produced will do; but where simple surfaces only require the application, the machine will do its work well. The cells of a comb are formed of simple surfaces, yet it is most difficult to bring them into contact with a disinfectant by washing, or immersion, they seem too small to allow liquid to get in to drive the air out of them, and the air in them forming one globule, fits the cell too tightly to lift itself out through the liquid in which the comb may be immersed. Carbolic acid, used instead of the before-mentioned disinfectants, would form an excellent means for the prevention of robbing, as its fumes might be directed across the mouth of the hive attacked, so that while those within would be safe from its immediate effect, the robbers would get the full benefit of its disagreeable odour.

**WAX-SMELTER.**—The repeated inquiries made of us respecting the wax-smelter, described by Mr. Wood of Nyborg, Denmark, page 17, have led us to the manufacture of a small article, which may be fairly described as one teapot within another. It will be easy to gather an idea of it

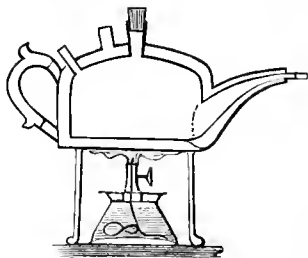

by reference to the engraving, which shows

it in section. It is made of tin; and from the simplicity of its construction almost any tinplate worker could make one. Its dimensions are of no consequence, all that is necessary being, that the wax holder shall be within another vessel intended to contain water, as in the ordinary glue-pot, with the exception that it has not an open top like the latter. Our mechanical friends will, perhaps, remember the oil can used by engineers, which has a valve upon which the thumb is pressed when it is intended that oil shall run out, and in which, when the pressure is removed, the valve closes and the oil ceases to run. It occurred to us that melted wax is, to all intents and purposes, oil; at any rate, we determined to treat it as such, and hence our smelter. The wax is put in, in small pieces, at the centre opening, care being taken that no foreign substance is mixed with it which would be likely to stop up the delivery orifice. When sufficiently charged with wax, the cork is inserted in the opening, and water (if hot so much the better) is poured into the other opening (which must not be corked), until the inner vessel is surrounded. The whole is then set upon a wire trivet, and a lighted benzoline lamp, which may be purchased for sixpence, is placed under it, and in a few minutes the wax will be melted and fit for use. By reference to the engraving it will be seen that the central hole being closed, the inlet for air, without the admission of which the melted wax could not run out, is through a thin tube near the handle of the smelter, and is so placed that the application of the thumb will at any moment cut off the supply of air to the wax-holder, and consequently bring the flow of wax through the delivery pipe (or spout) completely under the control of the operator. The end of the spout is so arranged as to form a gauge, if required. The advantages in this form of smelter consist in the fact, that the wax cannot be burned, that it will keep hot for a very long time, that it is thoroughly heated up to the point of delivery, and that it is under simple and easy control.

*Crippled Bees.*—Crippled and disabled workers are not tolerated in the bee commonwealth. They are at once condemned and ejected by the community, as not only useless, but injurious members, for whom no compassion is felt, and no mercy is in store. Crippled queens are reserved and cherished, though when become superannuated and unproductive they, too, are discarded.

*Foul Hives.*—Mr. Kark, of Settin, advises that a hive which contained a foulbroody colony be thoroughly washed with a clear solution of chloride of lime; and then well dried, set open in an airy place, and kept unoccupied by a swarm for at least one year.

## Correspondence.

\* \* \* These columns are open to Subscribers, so that their queries, replies, correspondence, and experiences, may be fully and faithfully recorded; and for the discussion of all theories and systems in Bee-culture, and of the relative merits of all hives and appurtenances, that the truth regarding them may be ascertained. The Editor, therefore, must not be expected to coincide with all the views expressed by the various writers.

### A RODBOROUGH VALE APIARY.

I commenced bee-keeping in April 1871, purchasing one hybrid stock in a box-bar hive and five in common straw hives. After swarming I transferred them into ten-frame Woodburys. I purchased eight imported Ligurian queens and joined seven successfully to the English stocks (I sent the best of these to a flower show, the bees were confined, and the heat melted the combs, and I lost it entirely); lost two more during the winter from weakness and starvation, and commenced, April 1872, with two hybrids, four Ligurians, and two English. I increased these during the summer to seven and eight; drove two English stocks for a neighbour, keeping the bees, which I put into Woodburys with comb, and fed; but they both died, one lost its queen and the other lingered till spring. I commenced April last year with six hybrid, and eight Ligurians, purchased six English stocks. I commenced feeding in September, gave about two pounds of sugar syrup once a-month to April this year; two hybrids lost their queens, were robbed and died, but one I neglected, thinking it had plenty, and began this last April with nine Ligurians, eleven hybrids, and five English (since Ligurianised), twenty-five stocks after making four into two last autumn (these are two of my strongest stocks now). After transferring the English into Woodburys, I exchanged the combs of two of them with two Ligurian stocks, destroying the English queens. I removed, April 23rd, my best Ligurian stock, first taking out a suitable brood comb and placing it in a four-frame nucleus with three empty combs, which I put in its place. The returning bees filled the nucleus, they rose ten queen cells. I gave two each to the other three English stocks, first removing the queens, afterwards the nucleus swarmed naturally. I put the swarm into a three-frame nucleus, but, in examining it afterwards, killed the queen (crushed between the bottom bar and the hive—I mean to do away with the bottom bars, as you recommend), and the bees returned. I have since transferred them into a full-size hive, and they are doing well. One of the English stocks lost its queen on her wedding trip, and I supplied them with a hybrid from a weak stock, putting them into a four-frame nucleus to raise queen cells. I have since made another (three-frame nucleus) from my best Ligurian, and shall try to keep a spare queen or two in hand. This stock far surpasses any other I have, I took an artificial swarm from it, 15th May, last year, it filled up in fourteen days afterwards; filled two supers with comb when the honey season suddenly stopped, and the supers were partly filled with

brood; I intend to breed from this one as much I can.

I have not had much experience, but such as I have had has taught me, I think, this much, that to be successful in bee-keeping the first thing to be kept in mind, *à la* 'Langstroth,' is to keep your stocks strong, and one means to attain this end is perhaps not sufficiently alluded to, viz., to remove all excess of drone-comb. (A case in point, I have one imported queen which has given me neither honey nor increase, and I have fed it each winter; the combs were so badly built I was afraid to tear them to pieces until this month, when I find, say half of them drone-comb. I have now given them worker comb and shall note the result.) Would it not be desirable to remove all drone-comb from hives kept for honey, putting one or two drone combs into a hive or two at the proper time for queen-rearing?

In rearing queens I think they are finer raised in a nucleus full of bees, and more of them, than in one-half full, as, if the weather be at all chilly, they cannot keep up the requisite heat to have fertile queens on hand, for the mother stocks in artificial swarming is a great advantage.

I purchased a honey extractor in 1872, but so far I have had but little use for it; I extracted about seventy pounds last year, and saved my super comb which I am now using, but so far the increase of stocks is all the profit. I hope we may have a favourable season this year.—G. F. T., Gloucestershire, May 26th.

### IMPORTING COLONIES OF BEES.

As some account of my experience in importing hives from Tessin, Switzerland, through Professor Chevalley, may be of service to other persons who are contemplating such a thing, I am induced to send you this letter.

Early in April I sent the Professor an order for a couple of Ligurian hives by way of experiment. This order was executed with all reasonable despatch; they were sent off on the 19th of that month, and reached Erith on the 24th. The weather at that time was extremely warm, and I had some misgivings as to the safety of the bees, especially as no guarantee is given by the Professor for any period subsequent to March, I think. The first appearance of the hives was disappointing; they were simply two boxes fastened together with pieces of wood, through which strong nails had been driven; and I experienced so much difficulty in detaching these pieces of wood, that, in fact, a corner of one of the boxes got also detached, and a large number of bees issuing from this with great rapidity, glad to escape no doubt from a long confinement, made it extremely troublesome; but being in an apiary, I closed the window, and thus prevented them from being altogether lost; and having detached the two boxes I stopped up the hole as quickly as I could.

I noticed that the boxes were extremely light; although the bees inside them appeared to be vigorous enough. The places of entrance seemed to be all round the box. I only uncovered one, which, perhaps, was a fortunate circumstance, having regard to the extreme cold that followed within a

day or two afterwards. The escaped bees could not return to the box, there being no means whatever of opening a communication, so I joined them to a weak hive, and the only inconvenience resulting from this was that the box from which they had escaped had less occupants than its fellow. I was satisfied that there could be but little food in the boxes—this was apparent enough to any one lifting them—and as week after week of cold weather followed on, I became apprehensive that the bees might be starved, and finally determined that I would transfer them to other hives, more worthy of the name than the Professor's so-called hives.

I found some difficulty in accomplishing this, because the tops of the boxes—the only part that I could venture to remove, had been firmly nailed down; and although the Professor had recommended me to use smoke when transferring his hives, I did not do this, there being really no occasion. On removing the top of the weaker hive I was much dismayed to see a quantity of dead bees matted together with the web of the wax-moth grub; but this I disregarded for the present, and proceeded to examine the combs of the hive. I found these to consist of black comb, set in the roughest of all possible frames, made simply of four pieces of wood of equal size, nailed together at the corners to form a square of 10 inches or thereabouts (there were four of these squares in each box). The difficulty of removing these was very great, they being secured by pieces of wood nailed inside the box on each side; so that it was utterly impossible to raise them without breaking away one side of the hive itself, and using the screw-driver as occasion required. On examining the combs I found brood in various stages in two of them, in the remaining frames no brood at all; and I am satisfied that if all the food in the entire hive had been collected it would not have filled a teaspoon. How the bees managed to live at all will always be a mystery to me. The same remark would apply to each box. I ought to mention also that in one of the frames *two* pieces of comb were roughly tied together, one of them upside down; while in every instance the combs had been prevented from tumbling out of the frames by five or six pieces of string. To get both these colonies, one of them into a Hüber hive, and the other into a Woodbury, was a work of great difficulty, occupying many hours; but I succeeded in this, and having well strengthened each hive with plenty of honey-comb, and restored the brood-comb, they are now doing well; and instead of being gentle, as they were when nearly starved and infested with wax-moth, they are now vivacious to a degree—almost too much so—for after a fortnight I opened one of the hives, without taking the precaution of smoking it, and in a very few minutes had forty bee-stings in my right-hand glove; whereas when transferring the bees in the first instance not one of them attempted to sting.

With reference to the wax-moth, I may state that I never in my life saw such grubs as those in the Professor's boxes; and I do not exaggerate, I am sure, in stating that some of them were three-quarters of an inch in length, and stout in proportion. The ravages these pests would have created had they

been suffered to continue, may readily be imagined. The conclusion to which I have come is, that it would be unwise to import the hives in the form now sent by the Professor, unless the purchaser is prepared to transfer the colonies to other hives as soon as the bees have become familiar with the locality; and this opinion I have already given the Professor in a private letter to him.—C. H. HODGSON, *Erith, Kent*, June 8, 1874.

#### THE PRESENT SEASON.

I hope the bees are doing well now that the weather has changed, for although windy it is better than frost. Our bees have suffered severely in May this year. There was one season near the same as this about thirty years since, and there have not been so many bees in this locality since that time. These are almost the worst seasons that I remember, as I have had bees these thirty-seven years, and at that time I purchased my first hive (a first swarm), at the end of the season, with all it had made for one shilling, and the bee-keeper thought he was threepence to profit at the money. We will not despair, however, although we have to feed with Greenock-crush. Please ask the 'Renfrewshire Bee-keeper' to tell us where we can get some sheets for guide-comb about here, as it is of great advantage to bees to have them.—JOHN ARMSTRONG, *Plen Mill, Dumfries Quarry*, June 8, 1874.

#### MANAGEMENT.

I now try to redeem the promise made in my last letter in January No., which was to give you full particulars about my bees in April. I am happy to tell you I have been so far successful as not to lose but one stock. It will be remembered in the November No. I stated I had in all eleven stocks, six in frame-hives, two of condemned bees in common skeps, three of Italian bees in frame-hives headed by young queens hatched on the 22nd of July last as before stated in my first letter. I ventilated all my hives in November last, as recommended by you in answer to my query; only instead of carpeting I substituted bran sacks (as I had no carpeting). Towards the end of February, I removed the sacks, &c., from all the hives, and put on the crown-boards and found the bees all right, except one stock in frame-hive, and that was attacked with dysentery—was very weak and short of food, although it had as much food as most of the other condemned stocks given to it. As soon as the weather would admit, I opened one of my strong stocks, and took out a comb containing honey, and gave to the weak stock, and fed it beside, using the bottle for the purpose, but could not save it, for on April 27th it left the hive. About half the bees returned in a short time, but not the queen; neither could I find her, although I saw her but a short time before she left. I then gave the comb containing brood and bees and another containing bees to one of my strongest stocks—as the brood appeared healthy—have examined them since and found nearly all the brood hatched out. I have fed my lightest stocks all through April, and all my ten stocks are

now going on quite satisfactorily to all appearance. They have had no swarms as yet, but there have been two April swarms in this neighbourhood.—A. ADAMS, *Melksham, May 1874.*

#### A BEE PARASITE.

I hasten to send you a little insect, apparently a red spider, which I took off one of my black queen-bees this afternoon. She had been dethroned to make room for a Ligurian, just sent to me, and was released in a queenless hive into which I had introduced her on Saturday last. I opened the hive to-day to find out whether she was alive and well, and found her with this little creature on her back. For a long time I was unable to remove him, as he was quite indifferent to the pokes I administered with a little piece of grass, and hid himself under her wings; so I was obliged at last to capture her majesty, and in the safe retreat of my study remove this too faithful attendant with a pair of tweezers. I found only two grubs in royal cells. Probably the presence of the spider and the cold weather had interfered with breeding.—HENRY BLIGH, *Nettlebed Vicarage, Henley-on-Thames, May 6, 1874.*

[The insect was sent to an eminent authority connected with the British Museum, who writes: 'The insect sent is known as the bee-louse of Europe, and in some parts of the Continent is not uncommon; in fact, it is a nuisance, as many as 50 to 100 being sometimes found on a single bee in *Italy*, &c. It is a wingless dipteran, allied to the forest-fly, "*Hippobosca*;" it is named *Braula cæca*; the young are said to be produced in the pupa state; it lives by sucking the bees. No doubt more are to be found in the hive whence the specimen sent was obtained: if so, a specimen or two would be acceptable for the Museum Collection. It is not frequently found in England, except in imported swarms of the Italian bee.'—ED.]

#### IDENTIFYING LOCALITIES.

I should recommend you to avoid one great fault in information about bees, which I frequently see in various garden papers, and also in your sample number. The omitting to put in *the place* where correspondents reside takes off half the interest of many communications.

Where does 'Novice' refer to? Where does 'J. J. Wood' reside? I dare say he supposes every one knows; but depend upon it, however well known he may be in the 'Bee' world, very few of your readers have any idea whether he lives in Cornwall or Durham. The value of information about bees depends very much on knowing whether it relates to somewhere near where one lives, or 200 or 300 miles off in a totally different climate.—F. C., *Ashdell, Alton, Hants.*

#### EXPERIENCE WITH THE EXTRACTOR.

Having found a stock of bees queenless early in the season, I joined them to another, and took away four combs filled with honey. These I at once put into one of Starling's honey extractors which I had

just received from him, and the result was most satisfactory. In a few minutes the combs were empty, the honey ready for table, and the combs given to another colony to be filled with brood. The machine did its work very well indeed, and I most strongly recommend it to all bee-keepers as a most useful article.—STAINES.

P.S.—I am quite willing that you should give my name and address to any lady or gentleman applying, and I shall be happy to show the machine to any one wishing to see it.—*Berkshire, May 23, 1874.*

#### INTRODUCING A QUEEN.

My first queen-bee safely arrived on Saturday night, and this morning I united her with a stock which I had transferred from a straw to a bar-frame hive. I forced them all out, took their queen from them, well deluged them with scented syrup, and added the new queen and her guard scented also, mixed them all up, and put them into the hive. I have lost some hundreds of bees in the process, and chiefly young ones, too; but it was a very strong lot, and four of the combs were nearly filled with sealed brood (also some drone brood sealed and not), so that the hive will soon be populous again. I will let you know the result of my first experiment in due course. There were as many bees as would fill a gallon measure, and only five combs in the hive, which was only half full. I operated thus: I put perforated zinc at entrance before they were about in the morning; carried them into a closed room, where I smoked them well; made them nearly drunk; forced the hive off the footboard, and there they were all crawling, one over another, in a confused heap; searched for the queen, but could not find her amongst them; so emptied them into the bar-frame hive, into which I had previously placed six empty combs; took out the five combs out of their own hive and found the queen among the bees there; removed her and the bees, and cut away all the comb with brood (half of it sealed) in it, and filled the four empty frames, and placed them on one side; drenched the bees in the empty space in the hive, and the new bees with the scented syrup, mixed them up together, when I replaced the brood combs in the hive and put on the cover. In the afternoon I had the satisfaction of seeing the bees in their new hive working vigorously, and carrying pollen freely. I think it will be a success.—C. J. S., *Stroud, April 27.*

#### NOMENCLATURE.

I HAVE made inquiries again about the seven swarms in one year from one stock, about which I wrote in the March number of the *Journal*, as doubt has been thrown by Mr. Carr on the statements which I made therein. Will you allow me to say that it was the Cannock Chase tenant-farmer himself—not, as I thought, a friend of his—who owned this prolific stock? He affirms distinctly—and I have no reason to doubt his word—that the bees threw the swarms I enumerated. As the event happened only four or five years ago, he cannot well have forgotten the details of the

circumstance. I also made a slight mistake about the nomenclature which he used. He calls the third swarm a 'bunten,' the fourth a 'spindle;' not the third a 'spindle,' and the fourth a 'bunt,' as I stated. Another cottager in the same locality gave the same name, 'bunt' or 'bunten;' another gave me 'spindle' when I inquired if there was any special designation for a third swarm. Your correspondent must remember that N. Staffs. is not S. Staffs., and that words may very well obtain in the latter, with which he has not met in his long experience of the former.—*Sic Vos non Vobis.*

#### EARLY SWARMING.

Having had a fine swarm of bees yesterday, the 26th of April, and not having observed more than one drone until to-day, I thought it might not seem out of place to inform you of the fact. I shall, according to all appearances, have two more to-morrow. Wishing you every success with the *British Bee Journal*, which I read with great interest.—H. B. MASSEY, *Spalding, Lincolnshire, April 27, 1874.*

#### COLOURED BEES.

Yesterday, just as the mail was about to leave here, I caught a bee and posted it to you, which I hope reached you safely.

My bees are of the common black or brown kind. I never observed any difference in their colour until this spring, and now many of them are quite yellow, the one forwarded to you is *not* a good specimen, having only commenced to change, but some are *completely yellow from head to tail*. I thought at first that they had been rolling in pollen, but such is not the case; will you kindly say in the next number of the *Journal* the cause of the said change?—ROBT. GREGGERY, *Braunton, May 12.*

[The colour on the back of the bee is caused by its having buried itself in pollen until the grains, which are scarcely perceptible to the unassisted eye, but which under the microscope appear like fine gravel, have been so ground and grimed into the base of the hairy portions of the thorax and abdomen that they appear to form portions of them; the microscope, however, reveals the deception.—*Ed.*]

I will endeavour to catch another yellow bee and examine it, as you have advised; still, it does seem strange that these yellow bees *come out of the hive as yellow as they enter it*. I have hitherto understood that when pollen is plentiful, bees, in order to carry a great quantity, roll themselves in it; and that when they arrive within the hive the pollen on their bodies, as well as that on their legs, *was lodged there*. My bees, however, must, according to what you say, bring a part of their load out with them from time to time.—R. GREGGERY.

[It is believed by many bee-keepers that bees roll themselves in pollen, as our correspondent suggests, and the appearance of the bees apparently warrants the conclusion; but the pollen on their backs is invariably there accidentally. The available pollen is carried on the hind pair of legs, and when a bee enters a hive thus laden she repairs to the cell in which it is to be deposited, and holding on just above it with her front and middle pairs of legs, she curves the hindmost ones and discharges the

pellets into it, disengaging them by rubbing her legs against each other. She then enters the cell head first, and arranges the pollen to her satisfaction, apparently butting at it with her head until it is pressed firmly against the bottom of the cell, or against that already stored there. If a full cell of pollen be cut into longitudinal sections it will be found to consist of laminae of different colours arranged perpendicularly, each perfect, distinct, and without the slightest admixture. The pollen on the backs of the bees will soon wear off, or may be removed by others when they are not so busily engaged in gathering.—*Ed.*]

#### QUEENS: PURITY AND FERTILIZATION.

By this day's post I forward a dead queen, which I purchased for a pure Ligurian. Not having seen a pure Ligurian queen, I shall feel obliged by your examining it, and favouring me with your decision. Also, if you would oblige me by forwarding it to J. Hunter, Esq. (who in your *Journal* has asked for such), with a wish that he would give his opinion if it has been impregnated. Excuse me giving you, or rather asking you, to take so much trouble; but the solution of the above is of great interest to me in more senses than one. I am willing to pay any charges you may make, or expenses you are put to, on account of the above.—J. S. WOOD, *Nyborg, Denmark, May 11.*

[The dead queen arrived quite safely, although shrunken, as is usual in such cases. There is no reasonable room to doubt her genuineness as a pure-bred Ligurian, but of course her purity as a *mother* must be judged from her worker progeny. Our esteemed scientific correspondent, John Hunter, Esq., in reply to your query, has kindly forwarded the following as his opinion after having subjected her to *post-mortem* examination. He says, 'I have carefully dissected her deceased majesty, and found abundance of spermatozoa in her spermatheca, so that without doubt she had been impregnated. Her ovaries seemed much smaller than usual, although the eggs were well developed. If I might hazard a surmise, it would be that her breeding power was becoming exhausted; but this is only a *surmise*, which the age of the queen, if known, would tend to strengthen or dismiss.'

The doubts implied by Mr. Wood lead us to record a small experience in the same direction. We received a 'colony' of bees from Switzerland a short time since; there were four 'frames' of combs, in two of which were patches of brood in apparently the normal condition. We transferred the combs and bees to a bar-frame hive, and have carefully tended them, but now at least half the new sealed brood in the hive is drone brood in worker cells. We have never before had a case of such sudden decline in fertility, and can only imagine *that the great excitement caused by the transport of a breeding colony, has unduly affected its queen, perhaps conducing to partial paralysis of some of her functions*. It is evident that *now* she is comparatively valueless, although when sent from Switzerland she was forwarded as a specimen of Ligurian beauty and fertility. We mention this because it may have some bearing on the question at issue, and may perhaps remove groundless impressions of dishonesty in the sender of the queen alluded to.—*Ed.*

#### NADIRING.

If you have any time I wish you would write us an article on 'Nadirs.' I myself have proved them to be the most useless and fatal affairs possible. According to the recommendation of the late Mr. Pagden, I purchased a good many with  $\frac{1}{16}$ th of an



inch slits. These I found perfectly useless, as the bees died in them by scores; and even when I altered the size of holes to go down there were lots of dead bees whenever I looked under. My notion is that there is not sufficient air for them, or it is too hard work to get up again through the mother hive. Certainly with supers they do good work, though even with them I don't think the  $\frac{3}{8}$ -inch slit is the best. If this weather continues it will be a wonderful honey year I should say; the bees seem to be building comb rapidly. I hear most people in this neighbourhood have lost many hives.—T. J., *Hereford*.

#### ARTIFICIAL SWARMING.

Last Friday night I tried to drive the bees out of a straw skep,—*à la Pettigrew*—the size of which I will give first: it is 16 in. in diameter and 10 in. deep inside measure, with a flat top; I think I got about three parts of them in the top hive; and as I wanted the swarm to be put into a bar-and-frame hive, I placed that with a stone under one edge to keep the bottom off the board, and then pitched the bees on a sheet on the ground so that they might run under the hive. Well! into it they accordingly went, and appeared to be settling themselves down all right. I moved the old stock a little to the right, and put the swarm to the left, and disguised the old hive, but, some way or other, most of the bees went back to the old stock. It came on cool in the evening, and a lot of them stopped in the new hive, and I thought they were all right; but they did not seem to act like my other swarms that I drove: they did not go to work, but were very vicious if any other bees or myself went near them. I forgot to mention that I gave them a bottle of syrup the first night and every night since, as it has been so cold. They did not go off like the other stocks, but remained dodging about the entrance, a few of them fanning as though it was all right; so I blew in some smoke and looked at the comb that they had built, and found it was all drone comb and mostly stored with syrup. To-night I thought I would give them two or three frames of worker-comb without brood or eggs, which I had by me, that I thought of using for second swarms, &c.; and when I went to put them in (I should have said that I shut them up last night with about five frames, and put some partition boards on each side of them) I looked at the said piece of comb and saw they were constructing queen-cells upon it. I thoroughly examined it, but there were no eggs to be seen in any part. Now if the queen had been with them I expect they would not have built drone-comb for a start; then if she was not with them she must have been lost, for to-day I have found two young queens thrown out of the old stock, so that when I swarmed them they must have been preparing to swarm naturally. After all this bother I went and took a frame of brood out of another Ligurian hive and gave it to them, so that in a few days, all being well, if they construct queen-cells in the frame that I have just put in, it will be evident they have no queen. Now, then, the question arises, if they were building queen-cells as I men-

tioned in the first place, where could they get the eggs from?

In your letter of yesterday you say there is no honey; well I suppose there has not been much this last week, but there has been some about, and my bees have had a good fair share of it, I can tell you. The weight of my hives tells me that quite plain, but they have crammed it into the body of the hives. I have some hives with thirteen frames, same depth as yours, only they are but about  $13\frac{1}{2}$  in. long instead of 17 in. like yours; and this hive that I took the brood out of has got a rare lot of honey in it. I have also two stocks of hybrid Ligurians that have nine frames in them, and I put another box on the tops of them and frames of drone comb with here and there an empty frame, these frames are the same size as those in the stock hives. Well, the bees have stored up a fair amount of honey, and some of it they have quite sealed over; and where the empty frames were put in they have built worker combs, and the queens have been up and breeding in them. This is the reason why I asked you how you got on with the Extractor. I may say that I have been doing everything that I could to prevent swarming with all the others but the Ligurians; and the cold weather this last few days has stopped them. I must not forget to tell you that I had good success in my first attempt at introducing Ligurian queen-cells to three stocks of black bees. The queens are breeding fine; but I am half afraid they mated with black drones.

I am glad to hear that we shall be likely to have a good show at the Crystal Palace. All being well I hope to be there; and now allow me to say that I have read, with great pleasure, the letters of a 'Renfrewshire Bee-keeper,' and shall be glad to see them continued.

If you can find space in our *Journal* to insert this, without casting aside more valuable matter, you will oblige.—A WARWICKSHIRE BEE-KEEPER, *Weston, Leamington*.

[If the queen had been with them they would have gone to work in the usual way, and there would have been no difficulty. Another time, if uncertain of the presence of the queen, give the swarm a comb of young brood at first starting: it will not prevent their building drone-comb, if the queen be not there, but it will enable them to declare their condition by at once raising queen-cells. The raising of queen-cells, on drone-comb, was but a despairing effort in the direction in which lay their only possible hope, the absence of the necessary eggs alone preventing its fulfilment. There is no doubt but that the queen was left in the old hive; and we have every confidence that the swarm will raise young queens. What a pity not to have made sure of the queen being with the swarm—the queen-cells in the old stock would have been most valuable. Your storified stock ought to yield largely by aid of the 'Extractor.' Why not try one? In our locality we are obliged to resort to feeding, to enable the bees to exist: there is a complete dearth of honey.—ED.]

#### LOSS OF WEIGHT IN SWARM.

Thinking, perhaps, you would like to know what is the decrease in weight of swarm of bees confined to live three or four days, I beg to give an instance of my experience in that respect (not but what is it



like sending coals to Newcastle), and trust by so doing I shall do no harm. At noon, on the 26th ult., a swarm of Ligurians was hived and weighed (immediately) 3¾ lbs. It travelled 200 miles, and reached its destination late in the afternoon of the 29th; and although it was nearly 'done for,' weighed 3¼ lbs. It was confined the whole time and had nothing. My friend who sent them feared they would 'waste' much more.—T. F. CLUTTEN, *Norfolk*, May, 1874.

[It must be remembered that in the case above quoted the bees were in constant commotion, consequently had no time or opportunity for the conversion of their honey into wax: what passed away must, therefore, have evaporated in the form of perspiration.—Ed.]

#### ABNORMAL DRONES.

My experience as to the usefulness of drones bred by unfertilized queens is scarcely encouraging, as when I had gained the same position exactly, and in the same way (or perhaps I should say by the same means) as your correspondent, 'A Novice,' only that instead of having one young queen I had three, raised from the brood of a pure queen, each in separate hives; and here I may mention that two hatched out on the sixteenth day and one on the fourteenth; but the weather was so very cold and wet in the end of April and beginning of May that all three of the queens were lost. One I had opportunity of observing closely at any time I chose, as she was in a bell-glass with only a single comb, and I noticed she continued to move amongst the workers and drones contentedly and as one of themselves, apparently without being particularly noticed by them until the nineteenth day after being hatched, when she appeared restless and moved more quickly about the combs occasionally coming down on to the floor-board and returning, and two or three times I noticed her stopping if she met with a drone, and she seemed to caress him with her antennæ. This excitement continued from between eight and nine o'clock in the morning till after midday; the last time I saw her was about one o'clock, just before going to dinner, and after which meal I looked again, but she had left the hive; and as she was a very beautiful queen, both in size and colour, I looked out most anxiously for her return, but in vain, and I suppose the other two were lost in like manner, as they disappeared about the same time.

I wonder if the queen 'Novice' raised was a pure Ligurian or a common one, and what kind of drones are they that he has from the unimpregnated queen? \* If I knew who he is I should feel inclined to transgress rules and write to him.

The fine weather and abundant honey-gathering of a fortnight since led us to expect early swarms. Alas! for the change.—S. BRIERLEY, *Knowle*, May, 1874.

\* [They were all Ligurians—if you send us a letter it shall be forwarded.—Ed.]

#### FOUL BROOD.

In reading over the *Journal* I find that none of our great Bee-masters have given their opinion on this fearful calamity that befalls our bees; but our

intelligent friend 'Novice' has given us his opinion, and his remarks on the subject are made in a frank manner and very correct. But in his novel mode he proposes to *produce* it. As a well-wisher, I would not advise him to try such a method, for he will but lose his hive and not obtain the object he has in view. Unless the seed of the disease is in his hive he will not obtain it, but if he pays strict attention to his apiary he will in due time find it in its true form. Now, 'Novice,' when you come to deal with it practically you need not be afraid to use it to your advantage, as there is no infection in it unless in the hive that it originates in, as the honey is good for use, and what you cannot get out of the combs let your bees take it, as I can assure you it can do them no harm, as it has no origin in the flowers of the field. When it occurs with me I take what I can and give the rest of the honey to the bees, and it does them no harm, neither causes foul brood. But as I have succeeded in making one cure I will try again; and I am very proud my hive is doing well, and at the point of swarming.—JOHN ARMSTRONG, *Stirlingshire*.

[We have not the least doubt but that this letter was written in perfect good faith, but we trust none of our readers will be any the less careful in guarding against the disease mentioned. That foul brood *is* infectious we have the united testimony of the first bee-masters of both Europe and America, and must therefore suppose our correspondent is, happily for him, unacquainted with the true disease. Honey from an infected hive given to other bees will be almost sure to cause their hive to become affected also. If our correspondent's bees had the disease as described, and he has fed their honey to his other stocks, the effects will be most certainly found in his ruined apiary. Many affect to disbelieve in foul brood altogether as a disease, but they cannot disguise the fact that certain apiaries never produce any honey or swarms, but are always unprofitable.—Ed.]

#### DIFFICULTIES.

I am exceedingly obliged to you for your very lucid letter as to my queries and 'sighs' about my lost skep of bees. I hear on almost all sides three out of four is the average of defunct hives; but I am promised the gift of a black swarm by a friend whose servant has been very successful in saving his bees in ordinary skeps, and who lives so near that they may be hived and brought here without the slightest risk. I have no doubt my moving my skep into the closed box from where they stood against the wall (near, though it was) caused the beginning, at all events, of the disaster. We had some wonderful fine sunny days about that time, and I was delighted to see the bees about seeking their old home, but as they appeared to me returning to their skep in the box. Floods of rain came afterwards, and we could not feed from the outside of course, and did not like to cut the skep then on the top, and so they were put on the *qui vive*, and probably sought food without in vain; or as you state, the queen-bee might have died also, but they were very numerous before. My factotum, quite accustomed to bees in Devon, and 'turning them,' examined the inside of the hive and felt its weight as very considerable. I think I would prefer to give up (on your advice) any fancy hive on

the viewing principle, and have one which is most simple for feeding on the top, examining hive, or extracting comb, if required or ever made. I do not feel inclined to give up yet, though I fear our hill here is not favourable for flowers in general. Fruit trees have been in full blossom in my garden and around, but as usual it has been too cold and wet for a bee to go forth. The reason I have saved the 'Neighbour,' no doubt is, I have always been able to give some food at top; and as a few go in and out with pollen, if we could get a little sun, weak though they are, I think I should save them; sufficient, perhaps, for my amusement for watching them. If I get up my stock enough to be scientific, I shall ask you to send me a 'drone-trap,' to be used, I conclude, when the bees are beginning to kill them; as before, they must be of some importance I imagine in the hive, in spite of their idle eating of food? It certainly seems fully proved that 'Ligurians' are far hardier than our common bees, but then their sting is far sharper, and they are less amenable to liberties being taken with them.

Which of all the numerous hives do you recommend me to try? Stewarton, Carr, Woodbury, &c., &c., seem all well spoken of in the *Bee Journal*. My 'Neighbour' has straw sides, which I deem better than wood. Simplicity and suitability for the comfort and working of the inmates are the main points for ordinary bee-keepers like myself; as like the gentleman fisherman who, with his fine London-made rod, flogged the water long in vain; and when he did succeed in hooking a fish, the complication of reel and 'patent' rings, &c., &c., gave way, whilst a countryman, with little better than a long hazel switch, landed his basketful. Surely, the bee-keeper you mention as losing twenty-four out of twenty-nine stocks must have managed very badly in some way or other. I must not attempt 'Ligurians' yet; indeed I am told they are better workers, but also better stingers and fiercer; and therefore, unless I could watch them close enough to see them bring in pollen, &c., I should lose more than half the interest. These finer days I find my 'Neighbour' bees bringing pollen five or six together at a time, which looks well for their recovery. I hear good accounts from my friends of Great Bookham, that their four stocks are strong and doing well—an exception certainly to the general rule nearly everywhere. I wrote the beginning of this some days since, waiting to see if anything especial turned up and how my 'Neighbour' fared with some sunshine. I enclose P.O.O. for *Bee Journal*.—C. H. W., Bath.

#### THE WEATHER IN MAY—REMOVING AN APIARY.

Would you kindly give me the benefit of your experience and observation on what I have this day noticed in my apiary? On going out this morning all the alighting-boards have more or less pupæ or brood on them, some all white and others more advanced. This is also the case with three Woodbury hives, as well as with three straws. They apparently have been turning out brood for some weeks back; for I have, from time to time, noticed white maggots on the alighting-boards, but still

only one or two, not many. What ought I to argue from that, and what had I better do?

Last week I weighed all my hives; and of the three Woodburys one weighed 21 lbs., the next 28 lbs., and the third 18 lbs. net. I fed all my hives, Woodburys and all, with the bottle at top, containing three or four ounces of syrup, every other day, from the middle of February till within the last fortnight, when this unprecedented fine weather set in; and I concluded that they could gather sufficient honey, as they came in loaded. Ought I to have continued feeding them? I observed drones issuing out of the three Woodbury's several days last week.—E. W. S. R., *Bishop Stortford, May, 1874.*

[In reply we referred the writer to pages 4 and 5 of Vol. I. of the *Journal*, urging immediate attention, and in a few days received the following.—Ed.]

I cannot sufficiently thank you for your valuable assistance, as a friend in need is a friend indeed. I deferred my answer for a day or two, in order to see the effect of the feeding; and it is marvellous. I gave them a good feed the night before last and yesterday. The hives were wonderfully active; in two of them the drones were out in the middle of the day in wonderful numbers, whilst all the hives brought in pollen, &c., in great quantities.

And now I am about to trespass on your valuable time for advice on another point.

Within these last few days I have received notice which compels me to move my quarters to a house some *half a mile* from here. I have to move on the 24th June. What I propose to do is to let all my stocks swarm, and as they swarm transfer them to my new garden, which is very much smaller than this one; and in this I do not see that there will be much difficulty: my quandary is how I shall be able to move my old stocks. What is my best mode of procedure if the worst comes to the worst? I trust, however, that I shall be able to induce my successor to allow them to remain till the autumn; but it is best to know what one should do in an emergency.

I am truly sorry to be so constantly trespassing on your good nature and much-occupied time.—E. W. S. R.

[Our advice, which may be useful to others, was to allow the bees to swarm naturally, to place the swarms on the stands occupied by the parent stocks, so that the flying bees of the latter might join the swarms, and to remove both to their new locality, during the same evening, when they were all quiet. Swarms may always be removed with safety to short distances; and as all the foragers would have joined them, there would be no loss of bees from the old stocks, as all in them would be young bees which, not having flown, would know no locality but the new one. This method was successfully adopted.—Ed.]

#### EXPERIENCE.

I should feel obliged by your forwarding the Club Woodbury Hive, as swarming-time has now come in earnest, and I hope to find the hive useful. I am happy to tell you I have had a very fine swarm of yellow bees, headed by one of my young queens, which I reared last July. I have also three stocks working in supers; one began May 25th, the next May 31st, and the third June 3rd. I shall enter

my name as exhibitor at our coming show in due course. Did you forget my last letter? I felt rather disappointed at not finding it in this month's number. Will you kindly reply to this and the following question in next month's *Journal*? I made an artificial swarm about a week ago, according to instructions in *Journal*, but found the bees left in old stock (I mean the queenless half) would not work, and on examining them I found nearly all the bees returned to the old place; so thinking the brood would be chilled I transposed the hives, putting one in place of the other, when I found nearly all the bees left the swarm and returned to the old stock; seeing which, and thinking there would not be bees enough left with the queen to carry on business, I have put them as in the first place on Saturday last, and find the bees more equal in each hive; but the old stock as before will not work—there are plenty of drones and plenty of bees, so that I am at a loss to find the cause. They are in frame-hives, and I put the queens and the two other brood combs into an empty hive when I divided them.

If this requires an immediate answer, please write, and I will remit you stamp for it.—A. ADAMS, *Melksham, June 8th.*

[As you will see by enclosed proof your letter was printed and will appear in next month's *Journal*. The Index crowded out a great deal of matter, but it is well worth the space it occupied. You did not quite adopt the means advised in *Journal*, p. 7, May, 1873, as every precaution was there given to prevent the desertion of the brood. In the first place, you should only have taken one comb with queen, instead of three; and, in the second, if the brood was deserted, or had insufficient bees left, the hive should have changed places with a third stock. You must not be surprised at the old queenless stock not working for a few days: all its workers having gone to the hive containing the swarm.—ED. *June 9th.*]

### QUEEN INSERTION.

I am happy to inform you that I have been successful with both the Ligurian queens; and I think that driving the black bees is better than fumigating. I drove mine, and knocked about half of them out upon a large slate, and found the queen immediately. My cages I make of cardboard, with  $\frac{1}{8}$ -inch slits, and lengthways; the bottom to fit on as the lid of a pill-box, with a wire attached so as to push it off when required to release the queen.—EDWD. PRINGLE, *Northallerton, June 11.*

P.S.—How do your drone-catching friends get on? I should like to have some to catch.—E. P.

### EXPERIENCE IN INSERTING QUEENS.

The many excellent plans for inserting queens to alien stocks which you and our collaborateur, Mr. Wm. Carr, have detailed in our *Journal* seem to leave but little to be desired; and were they fully studied but few queens would perish in the cruel embrace of their rebellious daughters-in-law. I have united a considerable number of imported and other queens this season, and to the present time have had no failure; but on one occasion I came so near to it, under circumstances not unlikely to arise in an unfavourable season like the present, that I am

impelled from the influence of that classic sage whose acquaintance I made in youth, and who said *experientia docet*, to give you an outline of the case. Having the misfortune about the middle of April to lose from one of my best stocks a fine imported queen, I was tempted by the then exceptionally fine weather to remove two black queens from stocks which had about a fortnight before been received from Leicestershire, and transferred from skeps to bar-frame hives, in order that by inserting queen-cells from the Ligurians, then raising them, I might on the one hand prevent the appearance of the hated and dreaded black drone, and on the other possibly obtain pure Ligurian queens for the only blacks I have in my apiary; but a geographer, with whom I am unwilling to enter into dispute, says, 'The climate of England is variable.' The queen-cells, indeed, were duly hatched on the 28th of April, but on the 30th, the weathercock—here the synonym for uncertainty—went round to N.E. and cold and wretched weather, although it did not, as I had subsequent evidence, prevent my princesses from flying, yet it kept my comfort-loving drones with their noses near the warm honey-cells. Three weeks thus passed, and knowing that further delay was useless, as impregnation had to all appearance not taken place, I determined to insert the imported queens. I found, after some hunting, one of the princesses, and removed her; but the other hive I examined 'o'er and o'er' without success, until, supposing that the lady must have been lost in her attempt to secure the responsibilities of maternity, I caged in the usual manner the Ligurian queen, hoping she would soon be received. After twenty-four hours, beyond which I very rarely keep a queen confined, I found the bees unfriendly, and then caught sight of the princess. I adopted the precaution of walking with the frame upon which I saw her some twenty yards, and then searched amongst the bees, which were clustering very thickly, but without success. I placed the frame in an empty hive, and returned to the stock. Another long search, and she was again found, having returned to the hive, with which her flights had made her well acquainted; but so lithe and so secretive was she that I failed in grasping her, and she flew into the air. After another search she repeated the trick, when I opened a penknife and hunted the hive for another glimpse, which obtained, the knife severed her thorax. The hive was closed, and in twenty-four hours the attempt at releasing the queen made, but she was instantly and savagely caught. With my smoker in hand (I am always thus prepared when removing the royal box) I gave a smart puff, driving off the bees, and re-inclosed her ladyship. (Let me here, by way of parenthesis, suggest having a bowl of water at hand, when, if the bees seize the queen, she and they together may be thrown into it. She escapes with a ducking.) Twice more I made the attempt, but with the same result. The bees seemed to have become at home with an unimpregnated queen only, and hardly seemed to know of her disappearance, as no alarm was visible in the hive, and hence I believe their prolonged dislike. Once more I freed my Italian pet, she seemed dubiously accepted, but opening the hive a

few minutes after to watch how all progressed, she was found densely encased. In many families a storm accompanies the introduction of a mother-in-law, but I moralised that perhaps some common trouble might divert all from over-indulged antipathies, and so resolved to 'steep them in forgetfulness.' My smoker (a pipe in part) was filled quickly with puff-ball, and soon all were huddled together in a slightly trembling heap. They, in the evening, were all agreed to submit to the inevitable, and the hive has prospered well.

Puff-ball I do not recommend. It is undoubtedly injurious. It was only used in small amount, one bowl-full, but here it was useful. It was the desperate remedy which a desperate disease sometimes demands.—F. CHESHIRE, *Acton, W.*

### THE PAST SEASON.

I received your specimen number of the *British Bee Journal* for May, and am much pleased with it. You will please enter me as a subscriber to it. In this locality the past winter has been the hardest on bees I have seen for many a year. I blame the mildness of the winter for it, the bees being more than usually awake, and eating much more than in a cold, severe winter; at all events, not more than *one hive out of four* has come through the winter alive within a radius of ten miles from me. I cannot speak of other quarters. I have some hives ready for swarming.—W. D., *Kerriemuir, June 8.*

### THE PRIZE FUND.

Will you allow me to suggest the comparative ease with which the 100*l.* to be expended in prizes at the forthcoming Exhibition might be raised, if each secretary would endeavour to obtain subscriptions from the members of his Club?

I enclose you list of subscriptions and cash received myself, and trust that others may be stimulated to exertion by the success which has resulted from a very slight effort on my own part.

I have lately also met with several bee-keepers in this neighbourhood who, though deeply interested in the subject, had yet not heard of your publication; and I think if you would send a printed fly-leaf to the secretaries, for distribution amongst the lovers of bees, setting forth the aim and object of your valuable *Journal*, it would not only greatly increase its circulation, but awaken a deeper and more general interest in this delightful, and (if properly managed) profitable pastime.—F. BENNETT, *The Grove, Shifnal, June 25.*

### WHERE IS THE DISCREPANCY?

In Milton's *Practical Beekeeper*.—'a new edition,' &c. published in 1851, in the introduction, the author says:—'Amongst these old English writers I was agreeably surprised to find the name of our great architect, Sir Christopher Wren, who was a contributor to the general information on the subject, and kept bees in a hexagon hive while he resided at Oxford.' Can this 'Milton' be the author of the Milton's *Practical Beekeeper* quoted by

'A Renfrewshire Bee-keeper,' p. 174, vol. i. of our *Journal*, wherein Sir Christopher Wren is accredited with being the author of the *octagon* hive, to his admiration and love of which, is, apparently, attributed 'the octagonal arrangement of the piers' in St. Paul's Cathedral, which is therein described as being as 'beautiful as it is novel' and one of the 'happiest parts' of the structure? Surely there must be something aslant about this, either there is a want of identity of the 'Miltons' who were 'practical bee-keepers,' or the 'Renfrewshire Bee-keeper' has, as did the 'Times Bee Master,' confounded the terms hexagon and octagon. I shall be glad if this subject (which, after all, may be a 'mare's nest') may be ventilated in the *Journal*.—A MIDDLESEX BEE-KEEPER, *June 24, 1874.*

## Queries and Replies.

QUERY No. 96.—Two questions. 1st, Suppose I exchange the positions of a weak and a strong stock, what will be the result? Would not the weaker, with their queen, be destroyed by the returning bees belonging to the stronger? 2nd, Suppose I form a nucleus, by taking two bars of brood, without bees, from a strong stock, and placing it on the stand of another stock. I understand that the returning bees will raise a queen in nucleus; but when she is hatched out already, how am I to raise this nucleus to a good stock, seeing that if I introduce new combs of brood the workers will be too few to nurse the grubs?—C. W. S., *Herts, May 2.*

REPLY TO No. 96.—Before transposing stocks for equalization, they should be made to acquire the same odour. If kept in bar-frame hives, the queens should be caged on the combs for forty-eight hours, to ensure perfect safety. The work should be done early in the morning before the bees fly abroad, so that all of them may be influenced by the scent administered, which as being least likely to cause robbing by other stocks, should be that of tobacco-smoke. The equalization of stocks in hives with fixed combs is always attended with some slight danger to the queens unless they be first driven out and caged (see Mr. Carr's queen-cage, p. 189), but a copious smoking will reduce it to a minimum. During the height of the honey season hives may be transposed with comparative impunity, as returning bees, even though coming to a wrong hive, will come laden, and will be welcomed rather than otherwise, but it will be found safer to smoke them as directed.

2. If you take two combs of brood from a full stock and put them in the place of another full stock, there will be sufficient bees come to them from the latter to make a good swarm; but while raising the queen-cells, &c., they will build only drone-comb, which perhaps may be an advantage, when enticing bars are wanted for supers, as they will be perfectly white, and almost free from pollen; of which bees carry very little when queenless, but the plan in other respects is not a good one. Nucleus hives are more generally used to enable the few bees placed in each of them to hatch out queens from cells which have been raised in strong colonies (p. 184); and the present time is a good one to establish them, as when the first swarm has issued from a stock, queen-cells will be found in abundance, and after the lapse of a

few days will be fit for transferring to nuclei or to stocks from which swarms have been driven.

To strengthen nuclei and build them up into stocks, combs of ripe brood should be given, from which the bees are hatching out, not such as require attention. These will not only add to the heat of the hives, but will enable the queens to breed more rapidly, as all the young bees hatched will be able to act as nurses, for which they seem better qualified than old ones.

If a nucleus be formed as suggested in the query, there will be no young brood left in the cells by the time the young queen is brought to perfection, but there will be many young bees which will have hatched from the combs first given to it; hence having no brood of their own to attend to, there need be no fear but that they will hatch the brood out of as many ripe combs as they can cover, and speedily become a strong stock.—Ed.

QUERY No. 97.—Are there any signs by which it may be known that a bee entering a hive is laden with honey? The conveyance of pollen is manifest: are there any means by which the conveyance of honey can be detected? Ask the writer on the 'reflex action' as the motive of the bee in opposition to instinct, to continue the subject. If you do not care about the old stock, would it do, so far as the driven swarm is concerned, to drive before the appearance of drones?—F. W., *West Bromwich*, May 21, 1874.

REPLY TO No. 97.—It is almost impossible, unless by dissection, to distinguish between honey-gatherers and water-carriers; they are both liable to greater or less distension of the abdomen, and both being on business bent, make the best of their way into their hives. We know of no means by which busy bees may be distinguished from idlers, except in the case of pollen-carriers, unless by their distension of body, and their earnest, unloitering manner. We have applied to Mr. Cheshire to continue his article on 'Consciousness in Bees,' which he will willingly oblige by doing.

Artificial swarms may be made without regard to the presence or absence of drones, the *desulcerata* being, plenty of bees, plenty of forage, and fine weather. Drones are not necessary to the swarms, but are indispensable to the eventual existence of the stock hive, as without their influence the young queen would be only a drone-breeder.—Ed.

QUERY No. 98.—I have the offer of some early swarms of May last, but unfortunately they are in common skeps with a peg in the centre, and cross sticks to hold it in its place: could you inform me if there is any means of cutting a hole in the crown and fixing a crown-board without bringing the bees to grief? Hoping you will excuse the trouble I am giving.—N. NADIN, *Burton-on-Trent*, June 8.

REPLY TO No. 98.—There need be no fear of damaging the combs of the hives in cutting holes in their tops, if you do not press upon them. You will find champagne nippers about the most useful tool for the purpose, as if in good order you can nip the cane-sewing with them, and afterwards the straw.

First give the bees a little smoke, just to frighten them, then nip in twain every bit of sewing as far round as the hole is to be, take a pair of pliers and

pull each piece of cane out of the straw, as gently and steadily as possible, undo the straw and nip it off quietly until you have removed sufficient for your purpose, then take plaster of Paris and neatly fashion the hole and the bed for your adapting-board. Put some nails or screws in underside of adapting-board, and also in the top of the hive, so that when bedded in the plaster they shall hold firmly together; and in half-an-hour they will be fit for use.

We had much experience with these things before bar-frame hives came into use, now, as a rule, we ignore them.—Ed.

QUERY No. 99.—If you could answer the following query in the *Journal* it would greatly oblige. For three days one of my stocks of bees has been fighting with strange bees, and are so spiteful I can't go near without getting stung. Under the mouth of the hive are hundreds of dead bees, like the shining black ones, and a few of the brown ones: I have sent some of each. The brown ones are like those at work in my hives; but I don't know what sort they are called. Are the black bees another sort come to rob my hives? and, How can I stop the fighting? They did just the same last year to one hive, and I got very little honey from it.—F. L., June 8.

REPLY TO No. 99.—The above contained neither name nor address, and the writer is evidently contented to wait over three weeks for a reply, which, when received, may be utterly valueless. The robbers sent are the blackest English bees we have ever seen, being uniformly jet all over and polished in the highest degree. The disparity of numbers in the slain proves that they are getting the worst of the battle, and perhaps finding it to be so they will desist. Whenever we have any cases of robbing we sprinkle the front of the hive with diluted carbolic acid, which effects an immediate cessation of hostilities. Nothing is more noxious to bees than carbolic fumes, and a slight sprinkle on robbing bees sends them home in quick time, where they are about as welcome as a hunter *foiled by a skunk* would be to a select drawing-room assemblage. Its ultimate effect we cannot describe, but its application effects an immediate clearance. The black bees are evidently of a different race to the ordinary English brown bees; possibly they are wild bees, driven to your cultivated apiary by stress of weather. We shall be greatly obliged if you will send us some perfect specimens, in a small box, which will not be damaged in transit.—Ed.

QUERY No. 100.—The *Journal* having come to hand and been carefully perused, I now want, first, to tell you how I have got on with the driving and uniting; and, secondly, to have some further advice as to transferring and uniting the two straw stocks.

I must first tell you that the weather here has for the past month been very fine and favourable; the bees, from their warm and sheltered position, have scarcely lost a day—they have been fed night and day—in fact, they consumed exactly 30 lbs. of best loaf sugar in the month past. Well, on 26th ult. I drove a swarm, according to your directions, from each of my stock straw hives, and united them in my Woodbury box. Fortunately they had but one queen; for the first swarm came off, as I afterwards found, and left the queen behind through my not drumming quite long enough, though I did it for fifteen minutes. I placed the Woodbury on their old stand in the window, and removed the other two straws to another

empty room window, some yards further off, with roses and honeysuckle outside. The double swarm at once settled down, and were busy at work the next morning. I constantly feed them; they seem to be very strong and active. We have glorious weather, and, from careful watching, they seem to be bringing in lots of honey; but they now take their syrup very slowly compared with the first week: Is not this a good sign? The two swarms when put into the box seemed to half fill it (it was upside down): Do you think that sufficient for two swarms? I have no Salter strong enough to weigh them, but I lifted them last night with difficulty; they are so heavy. I guess them at between 50 and 60 lbs. gross weight; so allowing 15 lbs. for the box, and 6 lbs. more for the bees, it would give between 30 and 40 lbs. for comb, pollen, honey, &c. in eleven days. The stock-box should be full before we put on a super, I suppose? What is the average weight when full? Now, when may I do that and cease feeding? I noticed several small bits of white wax on the floor-board outside this morning: what is that a sign of? I shall fit up my bell-glasses in the way shown in our last *Journal*; but I am going to put on a wooden super first, which I have made out of a Brown and Polson's corn-flour box.

Now for the two straw hives. The larger of the two has a queen and plenty of bees, and seems busy hatching out and breeding, but not doing much work out-of-doors yet—it is constantly fed. The smaller, which I call No. 3, was rather weakly at first for a few days, did not take much syrup, and some scores of young bees got down on the floor of the room, crawling about, and would there remain spite of all my repeated endeavours to put them back, and so they slowly died, though several of their nurses attended them. However, the hive is evidently stronger, for there are lots of young bees hatched out very lively, and they take a much larger quantity of syrup than either of the others,  $1\frac{1}{2}$  pints in 24 hours yesterday, and as I was afraid they were storing it in their empty brood comb, I paused feeding for twelve hours: Was I right? But I found at the end of the pause a *young dead bee at the door with a white body*: Is that accidental, or is it a sign of want of food?

May I conclude that No. 3 hive has made a queen-cell and is hatching out a queen by the usual time, twenty-one days?

You will remember that you advised me to transfer and unite these straw stocks into my other Woodbury at the end of twenty-one days. But as I have a queen in No. 2, and the season now is so favourable for honey-gathering, would it be better to transfer them at once, or let them complete their work in No. 3? There will be the risk of the fertile queen being killed in the fight by the young unfertile one; there will also be the risk of her loss or non-fertilization. Will you please advise what had best be done? The only other thing to be said in favour of waiting another ten days is that the bees in No. 3 are larger and more energetic, though far less numerous, than those in No. 2, and their queen, No. 3, will be much better than that in No. 2, which I fear, from the size of the bees, may be an old one. In transferring had I better cut out *all the drone* comb, put in all the *brood* comb on the six centre frames, and the pollen and honey, or worker comb, on the other outside frames? Or had the pollen comb better be cut away, as it may be old? We cannot get any *puff-ball* here, though a chemist has sent to his London agent for it. Would you kindly send me a small quantity, for which I will send stamps?

I fear I have asked you too many questions; but I am very anxious not to make any mistakes at first starting, and I have no one here to aid me. Replies to all my queries will give me a good start for the season; which will be much looked for by your very obliged.—J. W., *Leamington*.

P.S.—My next step will be Ligurianizing; but as my bees have already cost me twice as much as I can afford,

I must wait until they have repaid me somewhat, which I fear will not be till the end of the season.—J. W.

REPLY TO No. 100.—It is a good sign when bees neglect their syrup food under the circumstances you state, as it indicates that there is an abundant yield of honey. A Woodbury hive half-filled with bees in a non-clustering state would be good, as when inflated, as they usually are when clustering for comb-building, they would quite fill it, which is all that is required. The weight of a set of full-breeding Woodbury frames should be about 35 lbs. net; but of course such weight is not an actual criterion, as there may be more or less sealed honey or unsealed larvæ and hatching brood, either of which latter will weigh less than honey or newly-sealed brood. It is manifestly of no use to offer bees food if they will not take it; they may therefore be supered at once, and before you apply the super, shave off the ends of all the sealed honey-cells you can find, give the bees a nice lot of tempting comb in the super, and they will soon go up and fill it. The boxes you name will make excellent supers, but are not smart enough for some bee-keepers. We, however, believe that in bee-keeping for profit 'what will do well is good enough,' and have no sympathy with those who cannot supply a super under a half-guinea. Those we described last month can be made for about eighteen pence, and are quite equal for all purposes to those sold by great firms at fifteen shillings each, and are much more convenient.

The small bits of wax are the wax scales which bees secrete while comb-building; they occasionally drop some of the scales, which immediately get hard, and once solid and cold they will not make use of them again.

It is not reasonable to expect the same amount of bustle and activity in a garrison after an army has been sent out of it as there was before, nor will there be much doing until recruits come in; and with bees, when a swarm has left, all its worker population will have gone away with it, consequently, until its numbers are recruited by the hatching out of brood little activity will be exhibited.

When you find young or chilled bees which persist in crawling away from the hive, pick them up and put them into a feeding-bottle, which invert over the feeding-hole, withdrawing the zinc so as to admit of others coming up and their going down; the warmth will thus soon restore them and bring them to a better state of mind, and their lives will be saved.

You were quite right to cease feeding the stock which is not breeding; they cannot want it with the weather as you describe.

The young dead white bee was probably one of some chilled brood which became so from insufficient bees being left in the stock after driving. This is an error into which many amateurs are led, being tempted to make *fine swarms* from stocks which cannot afford the number of bees required. The young queen will be hatched out by the sixteenth day at furthest (as a rule, perhaps, earlier), she will not probably begin laying until about the twenty-first day. As you intend Ligurianising in autumn, perhaps it would be better to run no risks now but to transfer at once; the possibility of losing your queen will thus be avoided, and breeding will go on as



rapidly as possible. Puff-ball is not plentiful *here*, but we send you sufficient to clear the hives of the bees left after driving. Do not cut away all the drone-comb, keep all the brood combs together as nearly as possible as you find them in the hive from which you take them.

You will find honey and pollen in same combs as brood, which will show that bees like to have it 'all over the shop,' giving a hint which ought not to be disregarded. In transferring, fill completely all the frames you can, and use no more string or tape than is necessary; keep all the combs with their cells right way upwards; let the central divisions between cells always be in centre of frame-bars, so that all the pieces of comb shall be united thereby.—Ed.

QUERY No. 101.—I read in the *Journal of Horticulture* of April 15th, 'Before a swarm leaves its hive the bees select or fix on a place to alight upon, and they are uninfluenced by stupid people making stupid noises. The question arises in the minds of many sensible, thinking bee-keepers, Why a swarm alights on a bush or branch of a tree, on which it never can find a home or do any good, and on which it never remains long? If it remain there many hours scouts are sent out to seek a more comfortable and convenient dwelling-place. If not hived it will not remain long on the branch of a tree. Why it alights there at all is probably a question which no one can answer. Some one has dropped the idea that the bees congregate there with ulterior intentions, settle there for a time before they go to a more abiding habitation, in a house, or wall, or hollow of a tree, which has been previously chosen for their abode. I do not believe that the bees have "ulterior intentions" when they swarm on a tree.' This is signed 'A. Pettigrew,' who declines to give 'valid reasons' for his unbelief, because he prefers the profitable and practical part of bee-keeping 'to the theoretical and fanciful.' As this subject is most interesting at this season, please give us your opinion in the next number of your invaluable *Journal*.—A MIDDLESEX BEE-KEEPER, June 1.

REPLY to No. 101.—Remembering Mrs. Tupper's observation that 'bees do nothing invariably,' we think it would be unwise to attempt to lay down any rule on the subject. The laws which govern swarming, like those which govern the weather, are so little understood that one can only deal with probabilities. It is easy to *prophesy after the event*, and give reasons why such and such things were; but no one can tell at what time a swarm will rise or settle, any more than he can say when the next rainbow will appear, yet after these things have occurred it may be easy to give valid reasons why they should have taken place. The 'tinkling,' or as some call it, the 'ringing,' of bees, allusion to which has already been made in this *Journal*, is a time-honoured custom, as to the value of which there is much difference of opinion. We do not believe in its efficacy as a means of inducing swarms to settle; but that is no reason why those who think otherwise should be 'stupid people.' It is well known that occasionally a swarm will leave its parent hive and go straight to the place which is to be its future habitation, without having previously settled anywhere, which seems to favour the idea of selection beforehand, although not in the sense of the letter quoted; which, as we take it, means that the bees select the particular branch, tree, or shrub, on which, with *quasi* intentions, they will first alight and form their cluster. This, we think,

is exceedingly probable, as it is well known that bees will cluster under the swarming impulse, without the queen being present, and after being hived will return again and again to the selected spot, and eventually return to their hive; while the queen, with perhaps half-a-dozen attendants, may be upon the ground unable to reach the appointed spot through previous injury to her wings, or from the weight of the eggs in her ovaries making it impossible for her to fly so far. This at once suggests a reason for their clustering in the vicinity of their hives. What we submit is neither theoretic nor fanciful, but will commend itself to the minds of thinking bee-keepers. We therefore venture an opinion based on the foregoing fact, that the reason why swarms of bees first cluster near their hives is that they may be sure of the presence of their queen before commencing their migratory flight. We have little doubt but that they *have* ulterior intentions when they swarm on a branch of a tree, and cannot see how this conclusion can be avoided unless on the assumption that what is instinctive in the creature cannot be the result of intention on its part, but this would be mere quibbling. As a rule swarms do always so cluster on leaving their hives, as we believe, for the purpose above mentioned; but it must never be forgotten that '*bees do nothing invariably*.'—Ed.

QUERY No. 102.—Will you kindly answer the questions on the enclosed sheet? I hope the answers may also be useful to others. 1. When examining one of my frame-hives I saw a few small white caterpillars, about a quarter of an inch long. They lay concealed between the top board and the box, where the wood had warped: one or two lay round the cover of the feeding hole. I have since discovered more concealed in some old comb I had forgotten to melt up. Are these the young of the wax-moth, and how am I to get rid of them? 2. One of my stocks (in frame-hive) thrived well till March, when, in spite of feeding, hundreds of bees died, and were thrown out. At last the box seemed almost deserted: now it has somewhat recovered. To-day, at 1 p.m., I counted the entries per minute, and found them from ten to fifteen. A little pollen was being carried in. This evening a few bees are standing at the entrance fanning, which I have not noticed before. Dead bees are still thrown out; possibly bodies of robbers, as I have seen some fights. A quantity of wax dust has been brought out, apparently held in some web. I enclose a fragment for examination. I intended to send more, but a gust of wind has taken it away. If this weakness is not caused by wax-moth, would it be best to leave these bees alone, or to give the comb to a swarm I am expecting?—W.

REPLY to No. 102.—The worms are undoubtedly those of the wax-moth, particulars of which will be found on reference to index of last volume, where they were ably described by Mr. Carr. The only way of exterminating them is by constantly watching for and destroying them. If allowed to gain headway the moths will become a perfect nuisance, and will eventually cause the ruin of the stocks. Your stock in frame-hive evidently felt the pinch of starvation in March; and your feeding was only just in time to save a remnant, which appear to have been able to pull through the terrible month of May. The dead now thrown out are probably those of the young bees which died in the cells when almost hatching out, but which from the sparseness of bees have been allowed to remain in the hive. The fan-



ning at entrance indicates either prosperity and superfluous heat, or, as is very probable, an unhealthy state of the hive from dead and rotten brood. The nostrils applied to the feeding-hole at top of hive will afford some criterion, but the safest way will be to open the hive and examine each comb separately, and so ascertain for certainty the state of the hive. The wax dust sent is about as is usual at this time of year. Bees, in clearing their combs for extension of breeding space, or in removal of dead bees or old pollen, cast down a great deal of dust and wax chips; the web is the web of wax-worms, which, being unable to reach the combs, have grovelled on the floor-board among the *débris*, which the bees are now dragging out.—Ed.

QUERY No. 101.—Is it desirable to remove an old store of bees from present hive, where they have been three years, into another hive? if so, the best way it can be done? The present hive is in a very dilapidated state, and the comb inside quite black. They have just swarmed.—APIARIAN, *Petworth, June, 1874.*

REPLY TO No. 101.—There ought not to be any necessity for interference with the combs of a stock which is only three years old, and which has just swarmed, unless it be for the purpose of fixing them in a more convenient hive. The colour of the comb is no criterion of its usefulness, its blackness being perfectly natural after being used for breeding for one or two years. It is not impossible to transfer the contents of one skep to another, especially when the combs have a number of sticks through them, which will enable them to stand alone, as by removing the old hive piecemeal, cutting off the projecting ends of the sticks, and placing another and slightly larger hive over the combs, the thing may be considered accomplished. The plan would be, about a fortnight after swarming, when the young queen will have been hatched, turn up the hive and ascertain in which direction the combs run, and whether they have sticks through them which will support them. Some combs are very irregular, as

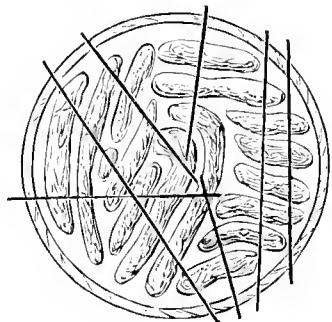

indicated in engraving, while others are straight, and sticks at right angles through them ought to hold them steadily. If they are irregular, sticks should be thrust through the hive in various directions as indicated, so as to prevent any of them from falling. A new floor-board should be provided and sufficient of the lower parts of the hive removed to permit the bottom edges of the comb to rest upon it; the hive should then be replaced in its position, to enable the bees to fix the sticks in the holes that have been made, and to fasten the combs down on to

the new floor-board, so as to make all as solid as possible, and in after operations the greatest care must be exercised to prevent damage to these fixings. Drumming the hive must not be thought of, indeed it would be impossible, unless the crown of it were removed, as the floor-board would be attached to the combs and would be required to remain there.

Three weeks after swarming, the hive will contain little or no brood, and it is at this time the transferring should be done, as the combs will be lighter than at any other time, and there will be no brood to injure. All being in readiness, fumigation should be resorted to, to quiet the bees and cause them to fall amongst the combs, and then, with a pair of sharp nippers, the hive should be gradually and quietly cut away, first clipping and removing the sewing material, and then the straw, but no violence must be used or the whole may collapse.

Two or three persons may aid in removing the straw, which, after clipping the sewing, will come easily away, and when all is removed the ends of the sticks should be gently cut off, the stupified bees brushed on one side, and the new hive, which should fit the mass as nearly as possible, should be placed over the whole, resting upon the floor-board and touching the combs at some of their ends, when the remainder of the work may be left to the reviving bees, who will speedily make all fast and comfortable. As a rule this kind of operation had better not be attempted by an amateur; if the hive was in sufficiently good condition to yield an early swarm, it ought to be allowed to remain, unless it is wished to transfer the combs to a moveable frame hive. The dilapidations of the hive might be cut away or mended; if near the floor-board a coating of mortar, or cowdung, might be plastered round it, or the whole coated with the latter, and an ornamental case put round it. Cowdung, although not a tempting material to choose, is, nevertheless, very useful for the purpose, as it is very tough when dry and becomes as white and weatherproof as ordinary mortar. If the injury is in the crown, a crown-board fixed on with plaster of Paris would give additional strength and accommodation for supers, and the outer case would hide all imperfections.—Ed.

#### NOTICES TO CORRESPONDENTS & INQUIRERS.

E. T. GRAYS.—We are thankful for the interest taken by yourself and so many others, and have taken your advice. The *Journal* will in future be published by John Strangeways, 28 Castle Street, Leicester Square, and may be had through all booksellers.

J. G. R.—The *Journal* may be had for sixpence per number; but if you wish to have the benefit of immediate replies to your queries, you must pay us a 'retaining fee' of 10s. 6d. per annum, and the *Journal* shall be sent for nothing, post free.

Can any of our readers inform us where the seed of Tansy-leaved Phacelia can be obtained in quantity?

\* \* \* We beg to notify to subscribers that Vol. I. is completed, and that subscriptions for the current year are now due. Those who are in arrear will oblige by kindly forwarding them at their earliest convenience.

We regret that through great pressure several important communications must stand over until next month.

*Covers for Binding the BRITISH BEE JOURNAL, Lettered Backs, 1s. each; with Number containing Index, 1s. 6d.*

THE  
British Bee Journal,  
AND BEE-KEEPER'S ADVISER.

[No. 16. VOL. II.]

AUGUST, 1874.

[PUBLISHED MONTHLY.]

Editorial, Notices, &c.

CRYSTAL PALACE SHOW.

We have much pleasure in announcing that, in deference to the expressed wish of many intending exhibitors, who up to the time first named as the latest at which entries could be received without additional charge had no idea that they should have anything in the way of bee-produce to exhibit, the time is extended to August the 8th; and we sincerely trust that every bee-keeper who has a super to dispose of will enter it, not only for competition, but to increase the show of honey, and thus aid in making the Honey Fair attractive and worthy of repetition. We are continually being asked to recommend a market for bee-produce; and the question is constantly recurring, 'Of what use is bee culture if there is no demand for the honey produced?' Our reply has been invariably, that there is a demand, and a very great demand too, for honey in its native purity. Up to now a few London merchants have had the trade in their own hands; they would give as little as they could for the article, and charge as much as possible; honey in the comb often being ticketed at 3s. 6d. per lb.—perhaps we ought not to say *per lb.*—but we have repeatedly seen small pieces of honeycomb of not *greater* weight, marked at the price named. Now such being the case, can it be surprising that honey has not a ready sale? It has never been placed before the London public in bulk, that they might choose for themselves, and make their own terms with the *producer*; it has usually been looked upon as a *curiosity*, and consequently being at a prohibitory price, there has been little demand for it as an article of general consumption.

The stuff usually sold as honey (Heaven save the mark!) by grocers and chemists is, as a rule, simply filth; a conglomeration of honey, bruised and broken comb, smashed bees and larvae, mixed often with the stinking residue of foul brood; or it is a manufacture which, to use the words of Langstroth, may be pronounced by the best judges 'one of the most luscious articles (*sic*) they ever tasted'—free

from that smarting taste which pure honey often has.' Is it then surprising that honey, pure and simple, has not become a staple article of food? or that, being robbed of its medicinal virtues, or substituted by a spurious combination of *palatable* articles, it is not appreciated by the public? We say, No! and aver that until bee-keepers take some pains to put before the public *the genuine article*, it will not be appreciated as it deserves to be.

We therefore join with Mr. W. Broughton Carr in the hope that honey in bulk will be sent to the Show, if only to prove to the public that it is a *native* product, and that it may be obtained at prices which bring it within the reach of all.

JUDGES.—Next to the appearance of a large number of exhibits, the selection of Judges is of the first importance, and throws an onus upon the working committee, which may possibly bring them into disfavour with some of the exhibitors. Individually we are in favour of the appointment of a Committee of Judges selected from all parts of the United Kingdom, that there may surely be some well acquainted with every description of hive, appurtenances, and system; and that there may be no suspicion of favouritism or prejudice, as is sometimes the case when one or two judges only are deputed to make the respective awards. For instance, a straw-hivist would naturally lean to the skep; a bar-framer might consider the skep beneath notice; a storifier would perhaps agree with neither of the others; and a nadirer might think no other system of any value whatever.

In judging supers opinions will probably be as various as tastes, and who is to lay down the criterion? Are supers to be judged by their beauty, the material of which they are made, their cheapness, their simplicity, or by the happy way in which some clever bee-master has arranged the whole design to produce some sensational effect? Shall the palm be awarded to the work of the bee-master, or to that of the bees—to the rich exhibitor, who having the means at his disposal, is able to *procure* the handsomest super; or to the one who, by dint of application and attention to the wants of his bees, has enabled *them* to produce the largest

quantity or best quality of honey? These are questions which ought not to be left to the judgment of individuals, but should be the work of a body, who should decide beforehand on the rules by which awards shall be decided.

OPERATIONS AND OPERATORS.—The Crystal Palace Company having set apart a large space wherein may be witnessed sundry operations with live bees, it will be necessary to determine who shall be the operators, what operations shall be performed, and whence shall come the bees to be manipulated. As regards operators, the intention is not to bring bee-masters into rivalry with each other, but to secure a competent staff who will be able to show the public at large how easily bees may be handled, led, or driven; and that operations, the contemplation of which frightens the nervous amateur, are quite easy of performance when practised with a firm and patient hand. We shall be glad to be furnished with the names of gentlemen willing to take part in these operations, and of others who wish any operations to be performed with their bees. Essentially, the transferring of stocks from skeps to bar-frame hives must take place on the first day, to give the bees time to re-fix the combs, and make all snug in their new domiciles before being removed from the Palace. These operations involve driving (or drumming), and possibly fumigation, and may be made to include the introduction of alien queens, either by fumigation, frightening, or the queen-cage, the latter being the most reliable process. The straightening and rectifying of crooked or irregular combs in a bar-frame hive would be an interesting operation to witness; and we hope to be favoured with a *subject*, as we do not happen to possess one.

The second day could be made amusing and instructive by an exhibition of bees and their manipulations in bar-frame hives, showing the advantages of the moveable-comb principle. A little practical work with the Honey Extractor would be interesting; although, from the lateness of the season and its taking place out of doors, it might cause undue excitement amongst the bees; but, perhaps, this may be guarded against. The examination of the transferred stocks would also be interesting, to show how quickly our ingenious artificers can repair damages: and to make amendments on the disposition of the combs, if necessary.

The third day would be devoted to the liberation of queens, if accepted, the exhibition and the packing of the bees in the bar-frame hives for their journey from the Palace, the occasional use of the Extractor, and such other manipulation as may be expedient.

There is one stipulation which must be attended to, which is, that the *bees sent must not be swarms of the current year*, since their combs,

being new, there would be considerable danger of the whole collapsing, either on the journey, or during manipulation.

Directions for packing bees have been given in Vol. I. of *Journal*; but the whole question will be reconsidered in our next number.

PRIZE FUND.—The Prize Fund has reached the sum of 88*l.*, leaving a deficit of 12*l.* on the amount proposed to be given in prizes; which sum we hope will be made up during the present month, that the Committee may not find their hands tied on a question forming the very groundwork of the Show. Like a new vessel, our Bee and Honey Show is nearly ready for launching. There is plenty of room and every convenience in the dock which is engaged for her at the Crystal Palace; and there is an 'Association,' at present consisting of about a hundred gentlemen, good craftsmen, who are willing to take charge of her when she is fairly afloat. As some guarantee of a successful first voyage more than one hundred ladies and gentlemen (bee-keepers) have paid the initiatory entrance fee of 1*s.*; and from the interest in it which has been exhibited since the honey harvest, which came upon us so suddenly, we expect to see that number doubled. What the number of 'exhibits' will be we cannot hazard a surmise, but have every reason to believe that the Show will be a *grand* one. We earnestly hope that every subscriber will forward to the Secretary, Mr. Hunter, 5 Eaton Rise, Ealing, W., the amount promised; and that an effort will be made to make up the deficiency. If a large amount was required many times twelve pounds would possibly be subscribed, but being so trifling a matter there is danger that every one may leave it to his fellow, and that its liquidation may not be effected before the Show takes place.

BEE-KEEPERS' ASSOCIATION.—A list of the ladies and gentlemen forming the British Bee-keepers' Association, is elsewhere given, and since it comprises so many distinguished names, we think there can be no doubt of its thoroughly permanent establishment, and trust that bee-keepers of every class and grade will rally round and give it their very best support. It is not the offspring of a clique, established in a corner to further the ends of a prejudiced few, but comes boldly forward to assert the right of Apiculture to a place with its sister Sciences, Agriculture and Horticulture, and to claim fellowship with their Associations; and we trust that as they have caused the advancement of the sciences they so worthily cherish, so may our Association of Bee-keepers, by uprooting prejudice, breaking down superstition, disseminating truth, and thoroughly exposing the charlatan trickery of dishonest traders, achieve for Apiculture a similar result.

## THE PAST MONTH.

The weather on the 1st of July was of the same variable, dull, and disagreeable character as that which prevailed throughout the latter half of June; and gloomy, indeed, were the anticipations indulged in. But on the 2nd day of the month the entire aspect of things changed, and the gloom was entirely dispelled. On that glorious morning the sun rose like a giant refreshed, and most zealously and perseveringly did he put forth his powers for the benefit of mortals in general, and bee-keepers in particular. Never, in our experience, have we had such a sudden glut of honey as set in on that day. Some of our stocks which, to the end of June, had been fed to preserve them alive, increased in weight nearly 50 per cent; others took immediately to their supers, and did well until they swarmed, while the majority were content to fill the combs in their lives with honey, to which many of them had been comparative strangers for many weeks. The limes and the white clover were yielding abundantly, and well did the bees take advantage of the opportunity; and for about three weeks they wrought 'from early morn to dewy eve' right merrily, bringing enormous quantities of purest nectar from the clover, and the blackberries which were just showing in blossom. On the 4th there was some distant thunder, and a little rain; the evening then became sultry, and honey almost flowed from its sources. On the 5th the comet first became visible in the northern heavens, and whether it had any influence we cannot say; but during its stay above the horizon, we were favoured with weather of uninterrupted splendour, which singularly, and we say it regretfully, departed with it. During those three weeks of fine weather one of our stocks in a Quinby hive filled two Carr-Stewarton bar-frame stock-boxes, which we had used as supers, sealing them out and out; and they are up in the honey box, which we should, of course, be glad to see filled also, but fear the uncomfortable change in the weather will preclude its possibility: still, we will hope. The white clover and blackberries are yet in flower; and a copious rain, which fell on the 25th, may enable the former to continue to bloom, more especially when, having been cut early, the second crop of honeysuckle has appeared.

## AUGUST.

Although swarming may now be considered over yet it is possible that some stocks, intoxicated with the spoils of the past month, which has indeed yielded a harvest of honey to those whose bees were sufficiently numerous to collect it, may send forth swarms as if it were now

in the month of June; but in all such cases they should be returned to their parent hives on the evening of the day on which they issue. With shortening days and lengthening nights, which increase in coldness, the chances against the well-doing of young swarms render it unadvisable to risk their separate hiving.

Such being the case, and drones not being required, drone-traps may be put on, that those idle consumers may be dispensed with wholesale. If this be now done, the bees will be saved all the labour necessary in their individual destruction, and the possibility of their joining other hives will be prevented.

Those who have no fears of the effects of the fumes of puff-ball will find in fumigation a ready means of capturing the whole of the drones at once; and every hive in an apiary of forty stocks may thus be cleared in one (dull) day, when there are none on the wing. On page 26 is shown the method of stupefying the bees; and it is easy to understand that when the whole of them are in a state of insensibility in the lower hive, a sheet of perforated zinc laid between it and the full one above, would effectually entrap every drone in the colony. Before this is done, however, the queen should be picked out from the insensible mass, and placed in the upper hive amongst the combs, since apertures which will restrain the drones will also prevent the egress of a queen. The zinc should have perforations of barely three-sixteenths of an inch diameter, through which the bees alone, as they revive, will be able to pass; the drones may then be again fumigated, and when insensible destroyed.

Before undertaking the destruction of all the drones, the safety of the young queens raised after swarming should be ascertained. In moveable-comb hives this is of easy performance, since even though their majesties may not be personally observed, there will be no difficulty in determining their presence by their works. Many amateur bee-keepers search a hive over and over again to find the queen, and at length give it up in despair. We are always satisfied in this respect if we find evidences of her presence in the form of eggs or larvæ. Straw-bivists, who use hives containing fixed combs, profess the ability to see into the cells in their hives and to discover their contents; but how this can be done, considering that the cells are at acute angles with the passages between the combs down which the observer looks, passes our comprehension, and argues an obliquity of vision both mental and physical which we do not wish to possess. It is easy to observe sealed brood when there is any in a skep, but eggs and young larvæ

are always hidden by the walls of the cells, and to see them one must be able to look round a corner. Stocks which have failed in obtaining fertile queens after swarming, will, during the past honey-month, have become almost if not *quite* equal in *weight* with those possessing fully-qualified matrons; but it is manifestly absurd to suppose such capable of existence during the ensuing winter. In all these cases new queens should be immediately given; but the doing so will be comparatively useless unless some of the honey be drained or extracted from the combs, so as to give space for oviposition. Last year the loss of many stocks was occasioned by the scarcity of honey causing a suspension of the queen's prolific powers at such an early date as left the hives without young bees when they went into winter quarters. This year a similar result will be brought about through an *excess* of honey, which in many instances has completely stopped breeding; all the cells in the hives being filled (and the majority sealed) with the delicious liquid, leaving neither space nor opportunity for the queen to exercise her delightful matronly prerogative.

As a means of relieving overcharged combs the Extractor ranks first, as the business can be done in a few minutes without danger to the brood; failing this, the practice of draining the combs by opening the cells and laying them on a trivet or grating, so that the honey shall drop out of the cells by force of gravitation, must be adopted. This should be done in a warm room or hothouse; and when all the honey has run out of one side of the combs they should be turned over, that the other side may be likewise relieved; after which they should be returned to their hives to be re-used by the queen and bees. These operations are only possible with moveable-comb hives; with straw skeps the combs must be cut out, and the stock broken up to attain the same result, since when combs are cut from hives of that description there are no means of replacing them. It must not be thought on this account that combs so cut out are valueless, since if the directions given in Vol. I., under the heading 'Transferring,' be adopted, and the combs fitted into bar-frames, there need scarcely be an atom of waste, and great gain will have resulted in having the stocks in more convenient hives.

### THE HONEY EXTRACTOR.

This invaluable aid to the bee-keeper has, during the past month, had a really fair trial; and its capabilities and action have surpassed our most sanguine expectations. Believing in the reports on its merits, published in the

*American Bee Journal*, from many of the high-class bee-keepers of that great country, with scarcely a dissentient voice there raised against it, we have repeatedly agitated for its adoption in England, from a firm conviction that its principle of action and the theory of its use were correct; but, until near the middle of the past month, we have had no real opportunity of testing its value as an apiarian adjunct. Every bee-keeper is aware that sometimes bees cannot be induced to enter and work in supers, even though honey may be abundant and close at hand; and this being the case with some of our own stocks, an examination was made, and it was discovered that the bees had stored their honey in the cells in the breeding apartments of the hive, instead of carrying it aloft and storing it in the supers, and this to so great an extent that, in some of the stocks, scarcely an egg or unsealed larva could be found, and the few there were of these were dotted about in a singularly indiscriminate manner; the very opposite to the beautifully regular way in which the previous set of eggs had been deposited, as was evidenced by the outer rings of the sealed brood, which preserved the continuity in a form so pleasantly indicative of perfect healthfulness. Some one has suggested that 'when a new idea occurs, the proper course is to *stick a pin in it*;' and we hope to be excused for here digressing to say, that this dotting about of the eggs, under the circumstances named, will account for the irregular and alarming appearance which is often so puzzling to the observant apiarian, filling his mind with fearful visions of that terrible scourge, foul-brood, one of the first symptoms of which is the appearance of *scattered sealed brood-cells*.

But, to return; we found some of the hives almost destitute of brood in any form, the sudden glut of honey having enabled their occupants to gather the coveted liquid so very rapidly that they had filled every available cell before they appeared to think of providing storage for it in the supers. It being evident that stocks in this dyspeptic condition could not possibly continue in existence, we prescribed as a remedy a dose of centrifugal force to be applied to either side of the combs alternately, after carefully shaving the heads of such cells as required special treatment; and it affords us the very greatest pleasure and gratification to be enabled to report that the operations were markedly successful.

The Honey-slinger is a *perfect cure* for *laziness* in bees when honey abounds; in *plethora*, it is of inestimable value, affording instant relief; it is a great aid in preventing *paralysis* of the queen's powers of oviposition; and in *dysenteric disease*, brought on by acidity, or the fermentation of the honey in the hive, it will

be found a most useful machine for its removal from the combs. Our first essay with it was on the 13th July, when from three small nine-framed Woodburys we extracted 42 lbs. of purest nectar; on the 15th we tapped six hives, and extracted 125 lbs.; on the 18th two were operated on, and 45 lbs. were obtained; on the 20th four were cleared, and 98 lbs. of pure clover honey left the cells, and delighted the eyes of all beholders. These operations were performed without the loss of twenty bees per stock; the brood was quite uninjured, except through an accident when shaving the heads of some honey cells, which was not, from any fault of the machine, but from the carelessness of the operator; the combs were, in many instances, considerably improved by the revolutions they had undergone, and in no single instance were they injured. Practical bar-frame hivists are aware that the combs in their hives, although built fairly along the underside of the frame-bars, and well within the frames, sometimes present a crooked appearance, when viewed from above. The removal of the quilt (for we have tabooed the crown-board as an abomination, and use quilts only) often reveals the appearance here portrayed, the frame-bars perfectly straight and with their edges well defined, but the combs as here shown in dotted lines, looking as crooked as rams'-

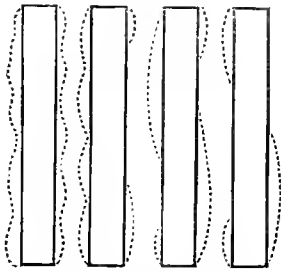

horns, yet having a well-defined division between them to enable the bees to pass along them. These protrusions are removed in the slinging operations; and many pits, hillocks, and dells in the body of the combs get removed altogether, the outward pressure, when the force is applied, being sufficient to flatten them against the wirework of the revolving part of the machine. Some one may here quibble that a comb cannot be so flattened without distorting, and consequently injuring, some of the cells—and this may be true; but we hold that any trifling injury to the cells, caused in thus rendering the comb flat, is far outweighed by the increased value of the comb itself when flattened, and contend that such combs are, for all purposes of convenience, improved instead of injured.

Our readers are, doubtless, familiar with the outward appearance of an Extractor; but, pos-

sibly, as many may not know how it is constructed internally, nor how it is worked, a short description of that we used may not be uninteresting. It is composed of a wooden frame, 22 inches square and 40 inches high. The corner-posts are turned somewhat similar to those of a bedstead; and the floor, upon which the *can* rests, being about 15 inches from the ground, heightens the similarity. The can is a straight-sided, cylinder-shaped reservoir; it is 20 inches in diameter and 24 inches high, slightly dished at the bottom, and has an outlet, with treacle-valve attached, which, acting as a 'tap,' permits the extracted honey to be drawn off at pleasure. At the risk of being charged with puffery we feel it incumbent on us to give place here to what has so often appeared in our columns for advertisement, the

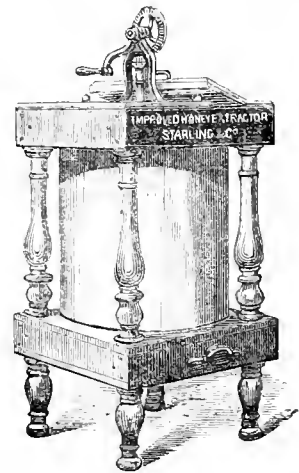

engraving of the first Extractor on the American principle (which differs somewhat from the original pattern) ever manufactured in this country. To give credit, where it is due, it may here be said that the invention came originally from Germany, and was the result of much careful thought by one '*Hruschka*,' whose name, in connexion therewith, will never die while bee-culture is practised.

The revolving portion of the machine, by which centrifugal force is brought into operation, is merely a light wooden framework, two sides of which are covered with woven wirework. The illustration simply shows the shape of the framework, which is slightly smaller at the bottom than at the top; each of its sides leaning outwards, so that the frames of comb put into it shall (in position) be out of perpendicular, and lean against the wirework above mentioned. This is an important feature—which our artist has not faithfully copied—as but for it the combs inserted into it would fall about, or would require special means for fastening them in position; not during extraction, for the centrifugal force applied would

then prevent them falling, but during the short periods of insertion and removal, while the machine is at rest. This framework has a

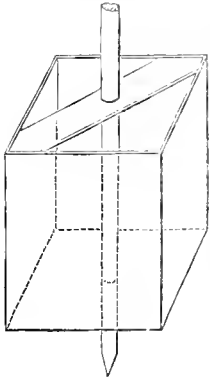

spindle running through its centre, the bottom end of which is pointed, and works in a thimble; its upper end being fixed into, and acted upon by threefold gearing, so that great speed may be attained when desired. In operating the combs are moved from the hive singly, with the usual precautions, the bees are brushed off them, and they are carried to the place of operation, which may be a room, washhouse,

or greenhouse; or, if honey is abundant, the operations may be conducted in the open air. If any of the comb contains sealed honey, the lids of the cells should be shaved off, and if there are any irregularities in the combs, such as are hinted at above, they should be sliced off, so as to cause them to lie flat against the wirework of the revolving cage, touching it at every possible point. It is necessary to guard against the combs strutting at foot of cage, as, if kept away from the cage wires, the centrifugal force will cause them to be broken out of their frames, and would do much mischief. It is also necessary in placing the combs in the cage to place the bottom bar of the frames in such a position as shall ensure its going forward when revolving. The reason of this is, that as naturally the cells point upward, so when the frame of comb is placed on its end in the position named, they shall point backward, that when revolving the honey may the more easily escape from them and be left behind. The machine is constructed to contain two combs at the same time, and it would be unwise to operate on single combs, as without a counterbalance great strain would be put upon one side of the cage, and unless held very firmly the whole machine would commence waltzing about, through the unsteadiness of the revolving weight within.

The combs having been placed in the cage—if they are not new, and contain no brood—they may be sent round briskly; and three or four turns of the handle will send the honey flying against the sides of the *cage*, like large drops of rain against a window-pane, leaving the outer sides of the combs perfectly dry, and every unsealed cell empty; but should there be brood in the cells the handle must be turned more slowly, or the brood will be displaced. Having cleaned one side of the combs, they should be reversed, still keeping the cells in the before-mentioned position, and the turning

repeated, when in a few seconds they will be quite free from honey, the whole of which will be found in the Extractor. When unsealing the combs a bent knife of the form here shown



is used; there should be two at hand, standing in a vessel of hot water, so that when one becomes cloyed it may be put into the water, and the other warm and clean brought into use. Care must be taken to keep the edge of the knife very sharp, and quite free from wax in any form; or, instead of cutting, it will drag off the lids of the cells, causing gaps in the comb, which may perhaps be attributed by on-lookers to some fault of the machine. To those who have the advantage of a heather district for their bees the Slinger must be a great acquisition, as if used aright it would more than double the quantity of available honey, since there need be no expenditure of labour, time, or material in the formation of comb by the bees. The proper system of management, with its aid and advantages, is as practised by the best Apiarists in America. There, when the honey season arrives, they double their stocks, placing one hive upon the other, so that immense populations are formed; and as the brood in the upper one hatches out the bees store it with honey, which is immediately available for extraction. The hives selected for upper stories under this system are those which contain the straightest combs, so that there is never any difficulty in that respect; and as the yield is large and continuous (as in our own heather districts), and the bees have no combs to build, the quantity of honey taken from such stocks is simply enormous.

Our own experience is by comparison very small indeed. We had up to the 2nd of July not one honey day, after the lovely but delusive weather of April; indeed, during nearly the whole of May and June we were obliged to feed the majority of our stocks, to enable them to exist and keep up their populations. Notwithstanding these drawbacks we are thoroughly convinced of the inestimable value of the machine, and have little doubt but that ere long it will be recognised as an indispensable implement in Apiculture.

*Feeding-Trough.*—One of the most ingenious feeding-troughs is a French invention. It is formed of about eight hundred small cylinders of thick cartridge-paper, about two-thirds of an inch deep, closely applied together, each standing on its end, thus forming a mass similar to honey-comb. The food being poured into a vessel with upright sides; this artificial comb is placed in it, and the bees are able to feed almost in their natural state.



## Correspondence.

\* \* \* These columns are open to Subscribers, so that their queries, replies, correspondence, and experiences, may be fully and faithfully recorded; and for the discussion of all theories and systems in Bee-culture, and of the relative merits of all hives and appurtenances, that the truth regarding them may be ascertained. The Editor, therefore, must not be expected to coincide with all the views expressed by the various writers.

### A VISIT TO THE APIARY OF R. SYMINGTON, ESQ.

Having read with great interest the letters of Mr. Symington on 'the management of bees' in our *Journal*, I have been anxious to see his apiary; but, having no business in that direction, I determined to ask him if he would allow me to pay him a visit. I received, in reply, a most cordial invitation; and went, accordingly, on the 4th of July. I got there about 10 o'clock a.m., and looked around the apiary, which is nicely arranged in a circle or oval, with the hives facing all round, outwards. There were many stocks of beautiful Ligurians, all in full work, though the weather on that day was rather showery, and very windy, as which it had been for a week past, as I knew, to my cost, by the work performed in my own apiary. About 11 o'clock my host came home, and took me into his large extracting-room, where, looking at the things, I should think almost everything requisite to manage an apiary in first-rate style might be found. We then donned our veils, and Mr. S. opened a great many hives; and we examined the queens, brood, &c., and found one hive that contained a fertile worker. We took this, hives and bees, &c., to the far side of the orchard, and removed all the frames, &c.; then took the empty hive back to its original stand, leaving the frames and bees behind: the bees were then brushed off, and the frames returned to the hive. This proceeding leaves the fertile worker out in the cold; and not having flown she will not be able to return to her own hive, unless accidentally; and if she attempts to enter another hive she will surely be killed. We were now joined by Mr. G. R. Symington, who, like myself, was rather afraid of his hands: and together they then began preparations for using the 'Honey-Slinger' or 'Extractor,' and I considered myself very fortunate in being present on the occasion, as I had long wished to see a little performance by the machine. Well, at it they went: they blew some smoke into the top of the hive, took off the cover, and, after that, took out two frames at a time, and carefully brushed or winged all the bees off, and then took them into the extracting-room. Any cells that were sealed over were uncapped with a knife, and the frames put one on each side of the cage: Mr. S. then gave a few good turns with the handle, then loosed it, and round it flew. He then stopped it, and showed me the combs: they were cleaned out beautifully. I could not have thought that it would do it so quickly, nicely, and cleanly. I can tell you that I quite fell in love with it. Well, I think they extracted about between 10 and 12 lbs. of white clover-

honey, which, considering the bad weather of the week previous, was good, as it had been very windy, with black clouds at times, driving the bees home with only half loads. Mr. Symington showed me a lot of glass jars of honey that he had extracted from the same hive. I believe he had taken near 70-lbs. weight from that hive before I went, on some previous Saturdays, his usual extracting days.

Well, I had written to Mr. Starling about an 'extractor,' or parts of one; but, as I told him I thought I should not want one this year, I suppose he did not care to write to me on that account; but after seeing Mr. Symington's do the work it did, and our Editor's recommendation to have one, I have got one on the way; but think of having the wheel and strap, like a sewing-machine, to work it. I have got the can and frame made, and will let you know in due course how I get on.

After going over some nucleus hives, and others, I departed for home; and I may say that I have never enjoyed a bee-day more in my life, thanks to the extreme kindness and hospitality of Mr. Symington. I got home about nine o'clock, well tired, but very pleased with my first inspection of the 'Yankee Honey Slinger' at work.

I had nearly forgotten, among so many things, to mention that I saw the new 'frame-bar hive' stocked with bees, and consider that it is a first-rate hive. No bother of having to cut comb, &c., off the tops of the frames, that the bees will persist in building again and again. I have come to the same opinion as others, that the Woodbury hive is not large enough for an ordinary prolific Ligurian queen.

I hope, some time this autumn, to give you a line or two on 'bar-frame hives and good management' versus 'straw hives and the let-alone system,' as I have had a good insight into the two systems this year.—A  
WARWICKSHIRE BEE-KEEPER, *Wetton, Leamington.*

### A CONVERT.

A few weeks ago I made it my business to pay a visit to the apiary of your correspondent, R. Symington, Esq.; and through his kindness and courtesy I was both instructed and delighted with his system of management, he having kindly taken the trouble to show me several very fine stocks of Italian bees, besides explaining a host of little matters in connexion with their management. I have become quite a convert to the bar-frame system; for it is evidently the most perfect one, giving the greatest control over the bees and their produce.

May the *Journal* go on and prosper. I have proved the value of its teachings. Every person that keeps bees should read it; and after reading it I feel sure they would practise the improved methods there so clearly written; more care would be bestowed on those industrious little creatures; more love for the pleasure they give, as well as for the profits they bring; and then will the hateful sulphur-pit be abolished, and bee-keeping be—what it ought to be—a scientific and profitable amusement for the leisure hours of our rural population.—C. FORCES, *Croft, Hinckley.*

## HONEY-EXTRACTOR AND BAR-FRAME HIVES.

Will you kindly allow me space in the pages of 'Our Journal' to correct a few mistakes into which Mr. Pettigrew has fallen in the pages of the *Journal of Horticulture* of May 28th, concerning the Honey Slinger, and in which he so far misrepresents my experience with that useful apiarian appliance as to convey a wrong impression to his readers, and to the prejudice of the interests of bee-keeping to those who may happen to accept his theory.

While thanking Mr. P., through your pages, for the courtesy with which he received my visit as an amateur bee-keeper, I trust he will take as kindly as it is meant my correction of what may be the result of a failing memory and a *wee* bit of *prejudice* against bar-frame hives and all their appliances. But as I was one of the first to have a Honey-slinger made in this country, and had used it and written my experience to your pages before the end of July last, but which through press of matter was deferred until the issue for September, with your kind permission, as Mr. P. has referred to my visit to him, I will place my *experience* in opposition to his *theory*. I should have done so in the pages of the *Journal of Horticulture*, but from the experience of one of your correspondents I feared that it might not be given there *intact*.

He stated, referring to me,—'He had made a slinger, or extractor, and had tried it. It did not act satisfactorily, inasmuch as the young combs were cast out of the bars by the motion, or centrifugal force of the machine,' and asked, 'Has any one been more successful with the slinger in this country?' Now, sir, as I certainly did not tell Mr. P. that it did not act satisfactorily, not having once entertained that opinion, but quite the contrary, I cannot see how anything short of prejudice could construe a mere admission that comb *not properly attached to all sides of the frame* was liable to be broken out by rapid motion, into evidence of its unsatisfactory use: for as I only used one comb not securely attached to the frame, and as all the rest endured the ordeal without any injury, my experience, instead of being used to the prejudice of the Slinger, only teaches, that comb of that description should either not be used or only with a slower motion. Mr. P. says, 'I have been looking out and listening for evidence of the practical utility of the Extractor amongst English bee-keepers; so far I have been unfortunate, for I have not heard of one instance of success.' If Mr. P. means that he has not met with one instance of the successful use of the 'Honey Slinger,' I fear it is because he has not listened at the right door, or looked into the right field. My own testimony to him was decidedly in its favour; and if you will kindly send him, on my account—as a small token of my remembrance of his courtesy—copies of this *Journal* for August, September, and your next issue, if you find space for this, he will then have the written testimony of three witnesses: of yourself, sir, the gentleman designating himself 'Novice,' and your humble servant, 'Alpha;' and, doubtless he will conclude that in the mouth of three witnesses *their practical experience* establishes

the fact of its utility against *his mere theory* in the *absence of any experience*. But, if Mr. P. means by the 'successful use,' the taking of immense quantities of honey from the hives by the use of the 'Slinger,' he has already given the answer, for the bad season which disappointed him of his 'supers,' for the Manchester Show forbade the taking of large quantities by the 'Slinger.' So far as I was concerned, having fairly tested the machine by taking about 20 lbs. of honey out of two hives, the season being unfavourable for honey, and my aim being the increase of stocks, I was content to let the bees have all, besides what they had gathered, concluding that I had not done amiss by increasing four stocks and a small swarm of Ligurians to twelve stocks, seven of which were Italianised. Mr. P. seems to think that the bees gather more farina in England than in America, and that is a reason that the Honey Slinger will be of less service to English bee-keepers; and afterwards asks, 'Does the "Slinger" invariably cast the honey out and leave the brood undisturbed? or does some of the brood and farina go off at a tangent with the honey?' In answer to his inquiry, allow me to say, that whether there be much or little farina, it will be altogether unaffected by the revolution of the machine. Nor would Mr. P. be able to fling it out, unless he first broke the cells to pieces, it is placed too securely by the bees, and smoothed down so nicely in the cells that no motion of the machine is likely to shift it; but for clearing those combs that have both farina and honey in it is just the thing, taking all the honey clean out, and leaving all the farina safe in. But in reference to brood, as I used the machine very rapidly, with some brood-combs that were not sealed over, and although watching for its effect on the brood, could only discover that in the case of a few *unsealed drone larvae* they were thrown out, I think I may safely say that with a little care, by a less rapid motion, unsealed brood may be revolved without either being cast out or injured; and that the motion required to throw out the eggs, or brood, is *much more* than is required to throw out any honey while still in a fluid state. And I would advise Mr. P. to make haste to get some bar-frame hives and a Honey-slinger as the best means of removing his scepticism.

Mr. P. finds an imaginary difficulty in paring off the sealing of the honey-cells on the ground of the combs not being quite level. But we may remind him that we have far more flat combs in the bar-frame hives than he will find on the average in the old skep, and we found no practical difficulty. A sharp knife made hot in water, and a steady hand, cleared them of the sealing in about as little time as it would take him to prepare the comb to be drained in the ordinary way. He also anticipated much difficulty from the bees having too much farina in their combs if not often removed. But as we neither kill bees nor destroy farina, the bees use it for the purpose for which it was gathered; and if they have plenty of it and a sufficiency of honey, they will begin to breed earlier, and more largely. I opened a hive on a fine day, the 26th of Jan. and found sealed brood in good quantity. And more, I have found but little difficulty with the *old dried pollen*,

for, having purchased some combs from hives in which the bees had starved to death—perished for lack of knowledge on the part of the bee-keeper—and finding some of it filled with such pollen, I set the bees to do what I could not do without destroying the comb, and soon found they had covered the floor-board with the *debris*, and in a few days her majesty was using them to deposit her eggs in. If Mr. P. only had a fair opportunity of witnessing what may be done with the bar-frame hive in the management of bees he would be likely to express his astonishment, as two experienced bee-keepers, on a large scale, of forty years' standing each, have done when visiting my apiary.

And, lastly, Mr. P. refers to something I said about cheap bar-frame hives, for those to whom the expense would be a consideration; and before drawing to a close, allow me to say that after what has been said in the pages of our *Journal*, your readers will not need any instruction from me in the making of hives. But where the expense is an object, my experience may be of some service. I began by purchasing some rice-starch boxes; I now use a larger box, such as biscuits are sent from the manufacturers in, and carefully pulling one to pieces, and nailing strips of lath—sawn lath—round the edges of the sides of another, after having first taken the top and bottom off, I then nail the sides of the divided box on the *outside*, place the ends *inside*, and thus have a box with double sides and dead-air spaces at what is with me the front and back of the hive, the ends not having dead-air spaces. Then nailing tin angle-plates on the corners, making my frames of sawn laths, and my top and bottom either of the tops and bottoms of the boxes or of some larger box, I have a bar-frame hive that will last twenty years; and although not quite so cheap as Mr. P. intimates, at less cost for the materials than an ordinary straw hive, and at about a third of the price that Mr. P.'s hives are sold at. And any cottager that can get a few tools, and has skill enough to make himself a decent rabbit-hutch or hen-coop, may make himself good and useful hives; and by the directions contained in the pages of the *British Bee Journal*, secure, at the outlay of a little labour and skill, and the price of a common straw hive, a good bar-frame hive by which he may keep bees as bees should be kept, allowing man's reason to make the best of their habits and instincts.—ALPHA, *Boston, Lincolnshire, June 25th.*

#### NADIRING.

I am sorry your correspondent, 'T. J. Hereford,' has written in such a *very condemnatory* way on the subject of my late husband's plan of 'nadiring,' and venture to send you my experience of this season. When the bees showed symptoms of swarming in May, a nadir was put under a stock hive; three weeks after I discovered, by having it held over a looking-glass, that it was full of white honeycomb, with numbers of bees at work. Since that the bees have again shown symptoms of swarming, and were quieted by having a 'super' put on the stock hive: this they are now filling.

At the beginning of June three other restless

stocks, which had nearly filled their supers, were provided with nadirs, and quieted down in like manner. These nadirs have been examined, and are also full of honeycomb, with bees busily working, so I hope to get a good store of honey from the nadirs that have given so much offence to 'T. J.'

Care should be taken that one set of the three-sixteenth-inch slits be placed at the back of the entrance to the stock hive, and then there will be no dead bees, as the light from the entrance will show them their way up. Room for the exit of one bee at a time may be cut in the hasp at the bottom of the nadir, to expedite their departure from it. I hope you will kindly insert this in the August number of your *Journal*.—E. T. PAGDEN, *Aljriston.*

#### DEAD BEES IN NADIRS.

The remedy for your correspondent's difficulty is a simple one, but at the same time completely effective. Let him bore a small hole in the bottom of the nadir, large enough for one or two bees to pass out, and he will not be annoyed by finding any more dead bees in it. When they descend into the nadir and cannot find their way back, owing to the number of bees clustering over the slits by which they gained admission, they are very apt to worry themselves to death. I met with the same difficulty myself, and this was the remedy which the late Mr. Pagden prescribed. I am very much inclined to concur with his opinion, that nadirs as honey-boxes are of great value.

He was most successful in producing a great quantity of honey, which, after all, is the great test of skillful bee-keeping; and one of his strong points was, the nadir-honey box. He maintained that its use is a great preventive to swarming; and I believe he is right. I have tried it during the present season, in connexion with three different sorts of hives, and with marked success.

The only straw skep which I still retain stood upon a nadir-box, into which I had accidentally left the communication open during the winter, and which, quite early in the season, I discovered to be half full of comb. The bees have since filled two hexagon supers of about thirteen pounds each.

The second case is that of one of your hives, with its eight large frames. One of your glass and wood oblong supers was put on about the 22nd of May, and on Whit Sunday the bees took possession in force. The following Thursday they occupied the second, and on the Sunday following two more, placed on the top of the two first. These four, which will contain about 14 lbs. of honey a-piece, were quickly filled up with comb; but the bees still clustered about the outside of the hive; and on Monday, June 8th, I added two more of the same boxes (intended for supers, but placed as nadirs), in a box attached to the sliding floor-board of the hive. These were almost immediately filled with bees, and comb-building vigorously commenced, and my prospects of a large harvest from this hive very encouraging; but, alas! a frost on the 11th of June, which was the prelude of more unfavourable weather, stopped their work, and they have done but little since; so that, instead of six, or eight, or fourteen boxes of honey, I must

content myself with four finished, and two unfinished. I am, however, very strongly convinced that the swarming was prevented by the timely addition of the nador; and that, had the favourable weather lasted, my produce in consequence might have been very large.

The third case was that of a Proctor's drawer-hive, in which the eight 4-lb. drawers were all filled with bees at work, and beneath which, to avoid swarming, I placed an old wine-box, capable of holding about 40 lbs. of honey. This was at once almost filled with bees, and soon after with honeycomb, whilst the work above still went on merrily; and I shall have ten or twelve drawers filled with honey.—HENRY BUGH, *Nettlebed Vicarage, Henley-on-Thames, July 16th, 1874.*

### A BEE DRESS.

I have tacked a piece of stout net (called fountain-net by drapers) about 18 inches square on to a wooden frame and placed it between my two hives; it is as high as the window is kept open, and this appears to be an effectual barrier, keeping each hive to itself with its own saucer of pebbles and water. I am happy to be able to tell you also that my troubles as to the *tapes* are over.

I have again opened the hive and found all securely fixed by the little workers, so that I could remove all the tapes from all the frames except one, the same that fell out last time I tried to free it, this I have left again for the present. I think I told you that I had made the frames of both my hives fit up close to the crown-board, and had also done away with the bottom bar and rack.

On opening the hive I was glad to find it appeared to be answering admirably; the bees had not stuck down the crown-board, but were lengthening their combs downwards below the side ends of the frames. This being the case, and finding they have plenty of unsealed stores in their cells, I have ventured (with the *wind west*) to put on a super.

I am now going to trouble you with the description of a *bee-dress*, which so well answers the purpose intended that I cannot refrain from telling you about it. At my first operations with the bees I had only a circular veil of tarlatan secured under a buttoned-up coat and felt hat. This I found so heating that I have had made what I will now describe:—A book-muslin kind of Garibaldi shirt, circular, with wide sleeves (to wear without coat or waistcoat), elastic at the wrists and at the top for springing over the brim of the hat (also made of muslin stretched on wire).

Exact dimensions of shirt are these:—two 45-inch breadths of strong book-muslin 40 inches long; the breadths to be sewn together leaving an opening, to commence about 2 inches from the bottom, of 21 inches, which gives a 42-inch arm-hole. This is essential in order to put it on and off with ease. Put in a sleeve 26 inches long and the width of arm-hole, but 9 inches wide at wrist, into the hem of which run a piece of strong cotton elastic the size required. In the centre of the front of the dress, about 5 or 6 inches from the top, insert a piece of black Brussels net about 17 inches wide by

9 inches long, and cut away the muslin at the back of it. Run an elastic into the top hem to go over the crown of the hat, and  $\frac{1}{2}$ -inch wide tape into the hem at the bottom, beginning at centre of front. Care must be taken to draw the dress when on well in at the waist and tie securely. The elastic wrist goes over stout cloth gloves, or rather gauntlets, along the back and fingers of which are puffs of white muslin sewn, so that no harm can come to the bees or to oneself. I have found this dress perfectly cool and protective, giving full liberty for manipulation, &c. In the open air jaconet might be used instead of muslin, and white net instead of black, it could then be sent to the laundry to be washed and got up as often as desired.

The brim of my muslin and steel-framed hat was  $4\frac{1}{2}$  inches deep, so that the dress hangs straight down from the hat to the shoulders.

I herewith enclose stamped envelope, with many thanks for your ready help in my difficulties.

Let us be of good cheer! I trust the worst is past. The weather here is delightful!—J. W., *Leamington.*

### BEE-HOUSES.

In my last letter I promised to give a description of the construction of bee-houses. I may, however, before doing so advert to the fact that bees are more forward in spring when kept in houses than when kept outside, arising no doubt from the economising of the heat, and as a rule I always find my bees in the house about two weeks in advance of those kept outside; besides weak stocks can be better attended to—in fact, bee-houses possess so many advantages that it becomes almost impossible to enumerate them, and these advantages can only be learned by bee-keepers adopting houses of a proper construction, of which I will give a brief description of the most inexpensive, leaving decorative and architectural beauty to those who have a desire for such-like.

And, first, let me here say that although any handy person can easily build a house, it is at all times better to employ a tradesman, as he will not only make a better job, but will be more able to cut the wood to advantage, thereby lessening the expense.

The wood commonly used for this purpose is common  $\frac{3}{4}$ -lining, tongued and grooved, this answers for nearly all the outside casing; for the interior some scantlings  $4 \times 1\frac{1}{4}$  in. will be required. The size of the house and the number of hives to be kept must now be determined on, and in all cases no hives should stand nearer to each other than 3 ft., and the boards should be so placed that the entrance to each hive should be in the centre, and such entrance should be a half circle 5 in. in diameter, with an alighting board (moveable) attached to the house, with a ring of wood placed round the circle about 1 in. broad and  $\frac{5}{8}$  in. thick, and better if every entrance be different in colour, or have some distinguishing mark. I have almost omitted to remark that floor-boards for such houses require either to have moveable or shifting alighting-boards, thus adapting themselves to the entrances in the bee-

house. For simplicity of construction the span-roof with projecting eaves ought to be adhered to. As I have already stated the size of house and number of hives to be kept must be known. The builder will, in the first place, make a pair of sides in plain door fashion, having the lining with V-joints nailed firmly to the scantlings already mentioned; next make a pair of gables or ends, and in either one of the sides or the ends mark off the doorway, so that it will separate at the joints and between the upper and lower bar. After this and the entrance to each hive have been cut, they are ready for joining and fitting at the corners, fastening together with corner-clasps or butt hinges, but in such a manner as to be portable. The next thing to be done is the roof; purlins, 4 x 2 in., are fitted into the gables, coming flush to the top, and then covered with the same size of lining as the sides, fastening the roof to the sides in the same manner as already described for the walls. The whole outside may now be painted with lead mixed with turpentine and raw oil, the roof when wet to get a coat of Portland cement dusted over the entire surface, the whole structure may then be placed upon square boxes about the depth of the base, and these placed into shallow troughs filled with some liquid to prevent insects creeping into or upon the house. The next thing to do is the floor, the sleepers to rest upon two strong beams supported from the boxes at the corners. The floor may then be laid and fitted either close, or leaving a small space round the walls, to suit the hives as they may be placed; or, in other words, if the hives are supported from the walls the floor must not touch them, but if they are supported upon pedestals (which latter plan is the best), then the floor may go close to the walls. It must be observed that the hives may be either in one row or in two, but in no instance should one hive stand directly above another, zig-zag fashion is the way. The floor now completed the fixing of pedestals comes next, they may be either metal pipes (fire-clay) or wood; if the former, a plug must be put in the wide end, on this you fasten a resting-place for the hive, coming close to the house, the pipes or pedestals must not touch the floor, and ought to have a guard filled with liquid to prevent insects getting up. The foregoing instructions attended to keep your beehouse comparatively free from insects, and the house can be entered at any time without in the slightest disturbing the bees; in fact, as I have already hinted, a dance might be indulged in and the bees would hardly know that any disturbance was taking place.

Although the foregoing embraces the most that is required, yet there may be some minor details not thoroughly explained. Should any think of building such a house and require further information, by enclosing a stamp for reply and addressing to me under cover to the Editor of the *Bee Journal*, their letter will then be transmitted to

A LANARKSHIRE BEE KEEPER.

[We shall be glad to learn the actual dimensions of a house capable of containing, say twelve hives, with the bill of quantities and estimate of cost of the same. Also why it would be better if every entrance be different in colour?—Ed.]

## EXPERIENCE IN UNITING LIGURIAN QUEENS TO ENGLISH OR BLACK BEES.

On page 45 your clever correspondent, F. Cheshire, Esq., details the strange conduct of bees in accepting an alien queen. Why a stock of bees sometimes will not accept a stranger queen, when they have no other in the hive, and the alien queen has been caged in the hive for forty-eight hours, and has in that time got the same scent as the bees, formerly seemed to me a mystery; but I have since come to the conclusion that it was with disturbing the bees when opening the queen-cage, as now I never have a queen encased by using my improved queen-cages

In the *Journal of Horticulture*, of November 15th, 1864, I described a singular case of antipathy, of a common stock of bees to an imported Ligurian queen, similar to that of our scientific correspondent, Mr. Cheshire, so I think we cannot do better than reprint part of the article, as it shows that certain queens seem to be obnoxious to a stock of bees, when if another queen be given to them they are all love and affection, accepting her as their beloved sovereign at once.

‘In uniting queens there is always a risk, and I cannot (1864) find out the mystery (*but have since*) why the bees will not accept a queen that is given to them, yet after they reject her, if she is given to another stock, they receive her joyfully. Again: the same stock that rejected the first queen will gladly accept another queen, if given to them almost immediately afterwards. A short time since I had a case that illustrates the point.

‘Having imported direct several of the most beautiful, pure, fertile Ligurian queens to be found in Europe, I placed one over a stock for some hours, that had its black queen removed two days before. I then admitted one bee at a time, and they behaved very well until half-a-dozen had been admitted, when they seized and attacked the queen, and I could not separate them without taking the queen up in my fingers and actually pulling the bees from her. This took place four times, when seeing that the bees would not accept this queen, I put her over another stock, and when I admitted the bees they received her joyfully.

‘I then gave the stock that had rejected the queen another of the imported Ligurian queens, and when admitted to her, they received the queen in a friendly way, and conducted her in triumph into the hive.’

If Mr. Cheshire and all other bee-keepers will adopt my ‘Improved Queen Cages,’ which I fully described in Vol. I. page 188, and Vol. II. page 11, of the *British Bee Journal*, for their benefit, and now made by Mr. Aston, at only one to two shillings each, they will have no further use for their ‘smoker in hand’ when uniting Ligurian queens: as I quite agree with Mr. Cheshire, and stated in the *Journal of Horticulture*, of November 8th, 1861, in an article on uniting bees, ‘That after having injured the health of stocks of bees for a number of years by fumigation, I found it was quite unnecessary in any operation with bees; and that all fumigation, of whatever kind, was more or less injurious to the health of the bees.’

Bees take little notice of an unimpregnated queen. When in the hive, instead of making way for her majesty, as the bees do when she becomes a mother, backing out of her path when perambulating the combs in search of cleaned empty cells in which to deposit eggs, with their faces turned to her loved and sacred body, the bees allow a virgin queen to scramble as best she can from one part of the comb to another, and when she is removed or leaves the hive, the same as described by Mr. Cheshire, the bees hardly seem to know of her disappearance, and give but little signs that she is missed.—WILLIAM CARR, *Clayton Bridge Apiary, Newton Heath, near Manchester.*

#### LIGURIANISING.

On the 15th of June I successfully introduced a Ligurian queen to a stock of black bees in an Observatory hive, and the first young Ligurian crept out on the 4th of July, being nineteen days from the day the queen was released from her cage. On the 5th of July I accidentally killed the queen, and on the 7th I caged another Ligurian with a few workers, at the same time cutting out two queen cells. On the 8th I cut out four queen cells; on the 9th five; in the morning and in the afternoon the queen was released. The bees were not friendly towards her, and she was stung under one of her wings. I then caught her, removed the sting, and caged her. On the morning of the 10th cut out three queen cells, and in the afternoon the queen was again released, but was attacked as before, whereupon I again caged her, and released and caged her every afternoon up to the 16th July, when the bees seemed more friendly towards her. On the 11th five queen cells were cut out; on the 12th six; on the 13th four; on the 14th two; on the 15th three; and on the 16th two; making a total of thirty-six queen cells. Since she has been released I have removed three, and there are at present two more commenced. The queen commenced laying on the 19th, and although the bees persist in building queen cells they seem at last to have taken to her. I have never before had such trouble in introducing an alien queen, nor have I ever cut so many queen cells out of one hive; from eighteen to twenty-five being the most. In my apiary I use the Stewarton and Woodbury hives. With some improvements I have succeeded in heading artificial swarms of black bees with Ligurian queens, in the following manner:—A brood comb is removed from a populous hive of black bees, and a Ligurian queen is caged upon it, and it is placed into an empty hive, the vacant spaces being filled up with frames prepared with impressed wax guide-sheets; then the stock hive, with the black queen and bees is removed to a new stand, and the hive with the caged Ligurian queen is put in its place, and two days afterwards the queen cells are cut out and the queen released, who is generally accepted by the swarm. I do not close the entrance of the stock hive, as the old queen being with the young bees breeds rapidly, and the hive is very soon strengthened. I tried some frames in one of my hives without a bottom bar, as recommended in the *Journal*, but in one case I found the bees were not satisfied to com-

mence comb-building from the top, but actually built from the bottom. In the second case the comb was fixed to the floor-board; and although it was loosed from that, owing to its being insecurely fixed to the sides, it dropped away from the frame. The comb weighed 7 lbs. For many years I have used the impressed wax-sheets for guides; I find them far preferable to waxing the bars. There ought to be no complaints now of bees not storing honey, as they have certainly quite made up for loss of time last month; one of my Ligurian swarms of the 21st of May having not only filled its hive, but produced nearly 90 lbs. of super honey.—THOS. WM. COWAN, *Horsham, July 20th, 1874.*

#### THE COMING SHOW.

I WRITE in what I believe to be the interests of our new Association and the coming Show, when I would urge intending exhibitors to send their produce to the Crystal Palace, even though it be far from first-rate, because it is by this time very plain to all bee-keepers, that the honey-season of '74 will be but a moderate one. Of course I cannot judge of the whole United Kingdom, but the tone of your article in last month's *Journal* leads me to think your prospects in the south are far from brilliant; and my own experience, so far, is much the same, and those of us who fondly hoped to send up supers weighing 40 or 50 lbs. will be wofully disappointed.

Now my idea is, that we should have a *full show* of supers, &c., even if of moderate quality, in preference to a few very first-class ones. I am well aware many would be tempted to smile if I calculated on my contribution to the Show beating all before it, or even winning prizes; but if I send the best I have, and all our members do likewise, we shall at least learn something by being able to compare notes regarding the season in different counties; besides, if we have done our best, we may be sure our little 'assistants,' the bees, will have done *their* best; and if the season is against us, no one can be to blame. So the Exhibition may be just as pleasing and instructive if the tables are well filled, as if monster supers were the order of the day. Speaking of 'monster supers,' I shall look with great suspicion on any like the one which literally took away my breath at the Manchester Show last year, and concerning which I remarked to a bee-keeping friend who accompanied me, '*That's too good.*'

Yes, Mr. Editor, here let me say, I hope our Association will set down a firm foot against 'doctoring' or 'feeding up;' for competition to be a source of pleasure must be *honest*, and I consider it mean in the extreme to have recourse to any 'dodge' in order to complete a super, even though the Show 'cannot wait,' and the supers 'must be filled.' I should say, let them be empty, if they cannot be filled in the natural way.

In conclusion, I hope we shall see the members of our Association well to the fore, and I hope none of them will be induced to keep their honey at home because they are not proud of it, for they will have the consolation of knowing, if they have failed, it is through no fault of theirs, and they should think

as I do regarding what I hoped would have been a first-class super—' Ah, well ! if I had chosen to rob my other stocks to "finish" that, I could have shown something, but—better luck next time.'—  
W. BROUGHTON CARR, *Higher Bebington, Cheshire.*

#### ANTICIPATIONS OF THE COMING SHOW.

I now send you my subscriptions for the *Bee Journal* for the Show, and as an exhibitor. I do not think I can come to the Show, but should very much like to do so, and will try if the fare to London is reasonable. If I do not come I will send a super of honey, which will be safe in your care I have no doubt. I fully expected seeing you in Manchester last year. My bees have done well so far. I have had seven swarms here and in Devonshire, natural and artificial. I like the artificial swarming well, and think it should be encouraged as much as it can well be, as it is so much better for cottagers. I think it will be a treat in London to see the experts operate on the bees. There will doubtless be some clever men there. I hope my friend, G. F., of Kingsbridge, will be there. If I do not come to London I shall hope to meet you at the next Manchester Show.—J. W., *Rochdale.*

#### BEE CULTURE.

Bee-keeping is becoming very popular with all classes, and, like everything else in this essentially progressive age, is making rapid strides. I have devoted some little attention to apiculture, making various experiments with the object of attaining that desideratum—how to obtain the maximum yield of honey at the expense of the minimum of care and attention, and I believe the method I have worked out and perfected solves the problem to admiration, as the following results testify :—

My first supers were placed on the stock-boxes on the 25th of May, and the busy little bees—busy indeed,—filled one of them in the incredibly short space of eighteen days, with 35lbs. of pure 'maiden' honey in combs, on bars,  $2\frac{1}{2}$  in. thick. Since then I have taken two other supers, weighing 35 lbs. and 38 lbs. respectively, which, together with the former (35 lbs.), gives a total of 108 lbs. ; all of which were collected in less than three weeks. Read, mark, learn, and inwardly digest this, ye slow-paced adherents of the old 'smotheration' school. The stock-boxes, three in number, measure 14 in. by 12 in. ; the supers to ditto, 14 in. by  $7\frac{1}{2}$  in., inclusive. The latter are fitted with six moveable bars (not bar-frames be it noted) on the top ; where more bars are used, as is generally the case, brood-comb is inevitable. Where bar-frames are used the combs for the most part are taken out in what in vulgar parlance would be termed a 'state of smash,' when the super is filled. Zinc slides are inserted which cut off all communication between it and the parent stock, and a stop is removed from the super, through which aperture, as there is no other mode of egress, the bees make their exit, until in the course of an hour or so, provided the day be fine, every bee has vacated it, and it may then be removed at pleasure, without the slightest danger of molestation. Another space-box is then

put on, the slides withdrawn, when the bees at once ascend and commence afresh, unconscious apparently of the deprivation. One of the supers for the second time this year is already more than half-filled with comb and honey ; the others are progressing favourably, so that, should the latter half of the season be as favourable as the first, it is not too much to assume that the above quantity may be doubled. When the top-box is removed full of bees it irritates them beyond measure ; as we know from experience, and bee-temper must of course be understood and duly respected. With straw hives, or hives partly composed of straw, I have nothing to do, beyond keeping one for stock purposes. Boxes properly made and furnished with slides, &c., enable one at all times to have the bees thoroughly under control. The expense of wooden boxes, doubtless, has something to do with preventing many from adopting this method in preference to the old ; but then, on the other hand, it must be borne in mind that the difference in price is more than counterbalanced in the end by the durability of the article. Placed out of the reach of the wet and the direct rays of the sun a box would outlast two generations. Not long since the writer had the opportunity of inspecting a bee-house and boxes made nearly half a century since, and the whole apparatus was as sound as ever.—  
ALFRED RUSBRIDGE, *Silllesham, Chichester.*

#### THE OCTAGON HIVE OF WREN.

According to your correspondent, 'A Middlesex Bee-Keeper,' to quote from an author entails responsibility for the discrepancies that may appear in subsequent editions of that author's works, and implies an ignorance sufficient to 'confound the terms Octagon and Hexagon.' Such is the 'mare's nest' your correspondent has discovered, and which he seeks to ventilate in this *Journal*.

The following is the passage to which I referred, taken verbatim from my copy of Milton's *Practical Bee-Keeper*, page 3, published in 1843 :—

'Upon looking over a very old book on Bees, purchased at the late sale at Strawberry Hill, I was agreeably surprised to find that our great architect, Sir Christopher Wren, was a contributor to the subject, if not the inventor of a beehive, of which he has left an illustration and description. I have printed in this work a copy of his letter. It appears to me that Sir Christopher's hive is the original of one attributed to Mr. Thorley, who lived at Oxford a century after Wren.'

Neither here, nor yet in Wren's letter, does the word 'Hexagon' appear. On the contrary, in the two editions of Thorley's work I possess—the one published in 1744, the other in 1765—I find in both the *octagon* form of hive insisted upon as follows :—

'An octagon, being nearest to a sphere, is the best form, since as the bees in winter lie in a round body in or near the centre of the hive, a due heat is conveyed to all the out-parts and the honey kept from candying, which, in a square, would not be so effectually prevented, and is many times prejudicial to the bees, and sometimes proves their ruin.'

After perusing the above extracts the most superficial critic could not fail to perceive that the word 'hexagon' was a most palpable error which had crept into, what I presume to be, a subsequent edi-



tion of Milton's work. It is to be regretted that Milton stupidly failed to reproduce 'Wren's drawing of his Three-storied Transparent Beehive,' probably thinking this unnecessary, as he distinctly states it was the 'original' of the one attributed to Thorley, while he (Thorley) does not claim the invention, but attributes it to Geddie.

I have already pointed out, *ad nauseam*, that Rusden, who sold licenses for Geddie's patent, owned that he and Geddie were but improvers of the 'transparent hives first showed to us by Dr. Wilkins, late Bishop of Chester.' The Bishop was Wren's early patron, which accounts for his possession of the hives.

Geddie obtained his patent for 'His New Discovery' (!) in 1675; owns to have had experience of it but for seven years previously (1668). Wren's letter is dated 1654; he had his hives peopled in 1653, twenty-two years before Geddie obtained his patent, and fifteen years previously, on his own confession, to his having had any experience of the hive, which, if we can rely on Milton as to the illustration, was the identical one invented by Wren and pirated by Geddie, and whose very drawing was successively made available to embellish the works of Geddie, Rusden, and Thorley respectively. We have, consequently, the strongest presumptive evidence that the first designer of the Octagon Hive and storifying system was none other than the world-renowned architect of St. Paul's—Sir Christopher Wren himself.—A RENFREWSHIRE BEE-KEEPER.

#### THE OCTAGON HIVE.

Who was the inventor of the Octagon hive? In Hartleb's *Commonwealth of Bees*, published 1655, a description is given, says Wildman, 'of a beehive made of boards of an octagon form, with a glass window on the back-side of it for the observation of their works.'—QUESTIONER.

[This question may be said to be conclusively answered by 'A Renfrewshire Bee-keeper' in preceding communication.—ED.]

#### FOUL BROOD.

My last letter on this subject was written in all good faith, and it is the result of my own personal experience and observation on my own and my neighbours' bees, and the practical training I got from my bee-masters in my youth; and if it be the teaching of American and European bee-masters that foul brood is infectious, then, happily for me, I knew nothing of their error, or I should have been sore beset with the Ligurian queen I purchased three years ago, as the hive I put it into turned out to be foul-broody in the following May. But as I knew how to act it did not put me much about, only I got no returns the first year. They, however, yielded me a surplus of honey last year, and I have the prospect of large returns this year. I have now a queen of her progeny, hatched from a worker's egg, in the midst of foul-brood corruption, and she is of the first-class type, but has no foul brood. If it be infectious it must be by engrafting a piece of foul brood comb into a healthy hive, for no other way

will do it; and I plainly tell the bee-masters of America and Europe that they have promulgated a delusive error. There is no infection. Its origin and its cause have taught me, and my bee-masters before me, that it is not infectious. I at once admit that it is a disease, and at the same time my opinion is, that it is a disease not natural to bees, but caused by some substance or material; that it is not natural to them in their wild state; and viewing it in this light I came to the sure and firm conclusion that it is not infectious, having proved it to be harmless to my own satisfaction.—JOHN ARMSTRONG, *Stirlingshire*.

#### EXPERIENCE.

In sending my second subscription for the *Bee Journal*, I may give you a few particulars of my limited experience as a keeper of bees. I purchased my first hive in the spring of last year, and a second in May—both in straw. I gave the first ample room, and it did not swarm. The second gave a fine swarm, which settled on a bush near the hive. I imprudently left the bees to make their way into a box hive placed near them; and they soon took wing a second time and entered the chimney of one of my neighbours. I almost gave them up as lost; but was delighted, in a short time, to see them clustering inside an attic window. From this I brushed the greater part of them into a straw skep, including, fortunately, the queen. I placed the skep on a chair in the room, swept most of the remaining bees into a bowl facing it, when a good number were collected to the mouth of the hive, when it was amusing to see the haste they made to enter. When nearly all were thus collected I left the hive in the open window, and by evening the whole had settled in it. A considerable number, of course, were killed; but the swarm was very strong.

I got no honey off any of the three hives; but as the season was so unfavourable I was glad to find, on weighing them, that they appeared to have sufficient food for winter. More fortunate than many bee-keepers last winter my hives got through all well. I was not anxious for swarms, and gave them plenty of room by putting ekes below the hives. One of them has swarmed notwithstanding, and the other two seem likely to follow its example. Though very late, the heather season is still before them; and, when the weather is favourable, it is pretty good here. Learning, from last year's experience, the danger of delay in hiving, on this occasion I cut the bush on which the swarm settled, and shook the bees into a Stewarton hive of two boxes lashed together, taking care, in placing it temporarily on a chair, to put two or three small sticks under it, to avoid crushing the bees. They soon settled quite comfortably; and I am feeding them with barley-sugar, made as directed in the *Journal* for November.

A neighbour last summer had a swarm from bees that had previously taken possession of old comb between the ceiling of a room in his house and the flooring above. Two casts afterwards came off, but one of them returned; the other was hived alone, and perished during winter.—C. L., *Fort-William, N.B., 15th July*.

## EMBOSSSED WAX SHEETS.

In reply to the query of Mr. John Armstrong, I am not aware of any one supplying the above most valuable aids for supers and stock-boxes, saving Messrs. George Neighbour and Sons, 127 High Holborn, London, or their provincial agents, one of whom is Messrs. Austin and M-Aslan, Buchanan Street, Glasgow.—A RENFREWSHIRE BEE KEEPER.

## NEW WORK ON THE BEE.

All true lovers of the apicultural art will hear with pleasure that shortly will be published in Paris, by Monsieur Girdwoyn, a native of Poland, a work treating of the anatomy and physiology of the bee, which promises, at least in its illustrations, to distance all previous attempts in this direction. Our Editor and myself have been favoured, and much delighted, with a view of the original drawings, lithographs of which to accompany the text are now being executed. They are 24 in number, of large size, finished with great skill and marvellous care, and represent the wondrous organs of the mature bee, and of the brood in various stages. Monsieur Michel Girdwoyn displayed the drawings, before referred to, at the Vienna Exhibition, and was there awarded a silver medal. He has been occupied no less than two years in their execution, which has required the continuous use of the microscope. The price at which the whole is to be published is not yet determined, but having ordered a copy, I will, upon receiving it, give some further particulars.—F. CHESHIRE, *Acton, June 26.*

## Queries and Replies.

QUERY No. 102.—Again I feel that I must trespass upon your good nature, encouraged as I am by the benefit derived from my former application to you and the excellent advice obtained. Let me give you some description of my apiary, my mode of proceedings, and the eccentric conduct of my bees.

1. A Woodbury bar-frame on a separate pedestal. This hive, which presented by no means the earliest indications of swarming (for there was no great clustering nor an undue amount of drones), nevertheless was the first to swarm—viz. on the 17th of May. Notwithstanding that it fell on Sunday I followed your directions and transferred both stock and swarm (afterwards to be described) to my new residence. I fed this hive with syrup for a week or a fortnight, and at the end of the three weeks I put on a Woodbury bar-frame super, with two pieces of guide-comb, indeed, they were pieces left on the bar from last year, and one had some honey sealed up in a few of the cells. Now in this hive the bees have made not the least progress in the super, the guide-comb remains in precisely the same state, and on observing it from time to time only a few bees are to be noticed in it.

2. An ordinary old-fashioned straw hive (swarm 1873). This hive formed one of four in a bee-shed, now discarded. After some weeks clustering a fine swarm was thrown off on the 2nd of June. These were also transferred to my new place the same evening. As I want to see the effect of large hives (18 in. diameter) I soon after nadired this hive; that is, put the old hive on the top of the larger hive, which said hive had a hole four inches diameter in the crown of it, and was furnished with six cross sticks. The bees in this hive seem to have become

reconciled very soon, but I cannot say that I have examined the lower hive to see whether they are working down into it.

3. Another old-fashioned straw hive, composed of two united casts, joined together in October, and fed very highly. This hive threw a swarm on the 3rd of June, and was treated after the same fashion as No. 2.

4. A Woodbury bar-frame hive purchased in March, 1874, and transferred to my late garden then. This hive never evinced any strong indication of swarming, so little so, that they did not attempt to cluster till the beginning of June. (I must at this juncture mention that I moved into my new residence on the 11th of June.) Well, I waited a fortnight in the hopes of the hives, remaining in my late garden, swarming, but then it became such a trouble to have to look after them so constantly, that I determined to move them then and there to their new quarters, which I accordingly did. A few for the next two or three days continued to go back to their old abode, but I placed a small hive each day and brought the wanderers back to their parent hive each evening. Before the end of a week they became established and have not attempted to wander back since. Last week as the bees began to cluster outside very much, and to be very busy out-side, I put on a super, so as to prevent them swarming.

5. A 'Marriott's' straw observatory hive, containing the swarm thrown off from No. 3 (3rd June). This hive, as all the others as well, was placed on a separate pedestal, and according to rule, fed for the first fortnight. They have proceeded to fill the hive very slowly indeed, but at the same time surely I trust. Last Saturday I made an examination, and comb could be seen attached to all the three windows; I infer from this that they have nearly filled the hive, but I am at a loss to know whether I may put on a bell-super (even a small one) at this late season of the honey in-gathering by the bees.

6. A very old common straw hive of the general size, containing a stock purchased at a sale in July, 1873, and transferred then to my late residence. This hive was one of the most eccentric in its movements. For weeks and weeks it kept on clustering, and there were a good many drones, but I should mention that from its not having been fed so much it was much later in its signs of swarming than most of the others. Day after day went on, and it never swarmed up to the 3rd of June. Well, when the other two (Nos. 2 and 3) threw off their swarms, I came to the conclusion that it would never do to let it remain alone in the bee-shed in which all three (Nos. 2, 3, and 6) stood. Again I should mention that on examination I found that they had commenced building between the bee-shed and the hive. Some of my friends had visited 'Marriott's' and asked advice at the Crystal Palace, when they were informed that this last coincidence was brought about by the hive being kept too hot. Accordingly, on the 3rd of June, I placed this hive on another straw one (Pettigrew's medium size), and transferred them to my new quarters, keeping them in for the next day, and removing the perforated zinc from the outlet the following evening. I have not yet examined this one to see if they are working down into the nadir hive.

7. An ordinary straw hive containing strong swarm, 1873. Before I was in the least aware that I should have to change my house at all, I wanted to prove the system of nadiring as well of larger-sized hives. I therefore very early in April placed a new board (24 in. square) under one of Pettigrew's medium-sized hives, 18 in. diameter, and stood the hive on this nadir hive. For weeks and weeks I fed this and was rewarded by seeing them very busy in every way. Just as I moved my goods in June I must needs give way to curiosity; so one evening I got two men to lift the two hives (they were too heavy for one to lift by himself) and the lower hive was pronounced to be half full of comb. But now comes the most provoking part of it. The men could not have placed the floor-board securely on its pedestal, for the next day the whole concern toppled forward, and of course the hives were dis-

lodged. The men who were employed in moving my furniture, immediately on the accident, donned bee-dresses, and set the hive and case all right. The honey ran out for the rest of the day from the entrance, and for days the bees were occupied in bringing out the broken comb, dead bees, and other *impedimenta*. Leaving them until I made the last move of hives in the middle of June I brought them up to this garden where they seem to have been going on pretty well. Should I disturb them any more by examining this hive before the proper time of taking off the original hive as a super?

8. A Woodbury bar-frame hive, in case, containing a swarm from No. 1 on the 17th of May. When brought to its new quarters, this hive was regularly fed every night for the first fortnight. They proceeded to build comb very slowly, but when one evening I perceived that they had built between the bar-frames I placed on a super about the middle of June. They have done little or nothing in the super, but the last few days more bees are to be seen in it.

9. A 'Nutt's Collateral' hive, containing a swarm from No. 2 (2nd of June, 1874). This hive was furnished with two pieces of guide-comb, one on each side of the hole in the crown of the (middle) stock-box, and was fed regularly for the first fortnight. Curious to say they seem, as far as can be judged from the window at the back, to have built their combs from corner to corner, instead of from back to front, as the guide-combs were attached. Last week, as the stock-box appeared to be very full, I placed a small bell-glass in which was a perforated zinc tube, and the glass is covered with green baize in addition to being enclosed in a box. For some time there was no indication of their working up into the bell-glass, but within the last day or two they have been observed to have commenced working *upwards*.

10. A Woodbury bar-frame hive, purchased in March, 1874, and then transferred to my late residence. This hive has caused me much anxiety and given more trouble than all the rest put together. In the first place it was the very earliest hive in which drones appeared, and it was the first to cluster outside very strongly. Notwithstanding all these signs it has continued to cluster day after day without the least attempt at swarming. I kept a man, after I had left my late home, in the garden watching for three weeks, and yet no appearance of swarming. They congregated in vast numbers between the case and hive (the space between being much less than an inch). At last I got tired of waiting, and one evening my gardener removed it to my present residence. For the next few days I placed a hive to collect the stragglers back, and each evening restored them to the parent hive just as I did in the case of hive No. 4. This last week I placed supers on Nos. 4 and 10, and so mean to leave them to do what they can during the honey season.

Now I fear that I have intruded too far upon your good nature and much occupied time: but still I have thought it better to put you in the full possession of the facts. If you will kindly give me the benefit of your observations on each hive (I do not mind what amount of censure I receive, as I am but a young practiser). My wife fancies that the hives that have been nadired should be deprived of their top hives so that the bees can work fully in the larger hives. Is this a correct idea, and if not, when should they be taken off? Again, ought there to be an examination of each hive? for it is difficult to know what to do in each case, as they might vary. One more question, and I will conclude. Is there any case for Vol. 1. of the *Bee Journal*, and if so, where can it be procured? All my numbers are complete, but I have hesitated to have them bound up as I have waited to see if any tidings of a case were mentioned in the numbers of the new Vol. (II.). If you could let me have an early answer to these my interrogations, it would be gratefully appreciated by

SPORR.

REPLY TO No. 102.—Hive No. 1, which swarmed May 17th, ought not to have been left so long without examination. It is possible the young queen, which ought to have replaced the old one which left with the swarm, has been lost on her wedding trip, and that the apparent paucity of bees is due to their dwindling away. The weather was very unfavourable during May, and the much-abused, but at times, all-important drones, were but little on the wing, preferring rather the snug warmth of the nursery. Nos. 2 and 3 were not happily treated. If your object was to test the 18-inch hives, the swarms should have been placed in them, not the old skeps on top of them. The swarms would have built largely under the swarming and comb-building impulse, and probably have furnished their domiciles; but now comb-building will be only slowly carried on, and only in accordance with the demand for space from the newly-hatched bees; and as near three weeks will elapse before any additional brood will be produced, and during that time the bees can and will deposit their honey in the top hive, from which brood will be daily hatching, there is little hope of much comb-building going on below; besides which, if they do build, their labour will be comparatively useless, as they, being queenless, will build drone comb exclusively. Watching and waiting for swarms is wearisome work. The difficulty might have been overcome by driving, leaving the driven lot on the old stand for *one day only*, during which time wanderers would have joined the swarm, and would have 'stuck' to it even after removal. Regarding No. 5, it would be well to put on a super if the hive is full; if the hive is what it promises to be, there ought to be no difficulty in taking or making *observations*, and arriving at a correct diagnosis of the colony's condition. There can, however, be no harm in putting on a super. No. 6 began building in the bee-shed because it happened to be convenient to them, and because they were not ready for swarming. They clustered outside for the usual reason (overcrowding), and finding space available, used it. It was not good policy to fasten the bees in their hive, and scarcely likely to add to their love of the nadir. No. 7 having been so roughly handled, the combs are probably broken down, which will cause them to lean against each other, rendering them useless to a very great extent, as where they touch each other, the bees will gnaw away the ends of the cells, and thus render them too shallow for breeding. Probably the best course now is to wait until the harvest is over, and then break up the stock, placing the available parts which contain brood or pollen into bar-frames, and running the honey from the others. Regarding No. 8 we can only suppose the bees, in consequence of the bad weather, were not sufficiently numerous to approach the super. Nutt's Collateral was evidently not placed correctly on its stand, but had one corner highest. The bees consequently began there, and built towards the lowest corner. Bees often insist in building upwards in glasses, even when their supers are furnished with tubes; one reason is, that the tube seldom reaches to the feeding hole, and the other the absence of the almost essential attraction combs. Bees cannot hold on to the glass, nor can they easily reach the tube if it is too short to reach down to the hive. No. 10 appears to be another

case of wearisome watching for swarming. Driving, or artificial swarming, would have cured them in quick time. The queen on one frame of brood, placed in another hive, and stood in the place of the old stock, would have been all that was necessary. The removal of the upper storeys of nadired hives is unnecessary, so long as the bees have space for work and storage. The probability is that there is still brood in them, which had better be left to hatch out. The stocks should stand until the honey harvest is over. There ought to be a thorough examination of each hive at least twice a-year, so that the condition of every comb may be seen. It may happen that some of them are overcharged with pollen, others may have too much drone comb, or there may be a dozen things discovered in examination which were not dreamed of before. We examine hives always, both before and after supering. If we did not we could not know if anything was going wrong. If stocks are fit for supering and, being supered, bees do not work on them, there must be something wrong; for it is against the nature of bees to omit a chance of storing. If however, from any cause, they store in the body of the hive instead of the supers we bring the Extractor into use and relieve the dyspeptic hive. We have taken over a hundredweight of pure nectar from five of these self-willed stocks during the present week. Covers for *Bee Journal* may be had, see pages 30 and 50.—ED.

QUERY No. 103.—I am almost out of heart with my bees, as there is always so much trouble in manipulating with them. On examining the bees in my new hive on Wednesday I was so perplexed to find they had united their combs together on the top and a good way down the hive between the frames, so that I had to sever them with a knife to take them out, and the honey ran out of the hive in a stream. I fumigated the bees with tobacco-smoke before I commenced operations, but while examining them there were hundreds of them down on the ground and a great many drenched with honey. I thought it was all over with the bees in my new hive, but by the evening they nearly all got up into the hive again, so that there is not more than about a half hundred lying about on the ground dead. The under sides of the top bar of the frames are chamfered away according to drawings given in the *Journal*, and a line of wax put all along the centre of the bar, but they have not built their comb on it all the length of the bar. I have thought the bars would be better not chamfered at all, but left to remain flat, as I never had so much trouble with them before, and had it not been for the dummies I could not have possibly got the frames out at all. I put them in the hive on the 23rd of May, and examined them on the 6th of July. They have made six combs out of the eight and a good bit of honey. There is not so much brood in the combs as I think there ought to be. Is it owing to the queen getting old? I should like to know the plan adopted, and the best time of the year for raising and uniting young queens. I suppose they are raised in nucleus hives, but I don't understand it exactly. I should like a little further explanation on that subject if you will kindly give it. You will remember I wrote you before putting my best stock of bees in my new hive, and I received your very kind reply and adopted the plan suggested by you, taking all the bees out of one hive and putting them in the new hive, and putting the new hive in the place of the deprived stock, and putting the deprived stock on the stand of another stock, while No. 3 should be moved to another place in the garden. I wrote you again stating as it was rather late (about five o'clock) when I put the deprived

stock on No. 3, that I drummed No. 3 hive before removing it, so that a great many bees came out, and when No. 3 hive was removed and No. 2, or the deprived stock, was put in its place, they went into No. 2 hive. The bees in No. 3 hive did not work for more than a week. I wrote you again about that matter, and your kind and prompt reply was, that the queen and working population of No. 3 having been given to No. 2, No. 3 was probably raising queen-cells. I thought No. 2 was over-crowded with bees at the time, and the hive handled very heavy. About three weeks ago I put a super on No. 2 hive, but they would not work on it. I took it off again on the 9th instant and put it on No. 3 hive, and they crowded it at once. This hive has wonderfully increased, and is full of bees to overflowing; I dare say they have raised a young prolific queen. They seem to be doing the very best of the three hives I now have, and if they work according as they have commenced I may have a super to send to the Exhibition. I have sent in my name as an exhibitor. I intend, if I have time, to send a bee-trap and board for emptying supers, &c. If I have not time to make it, I don't see why you might not send in the one I sent you, as it tends to expense in carriage. I don't want to make them for sale, only exhibit them for any one to take a pattern from if they feel disposed to do so; and should I have a super worth sending on, the expense of sending it up and bringing it back again, and the probability of the combs being broken up and the honey wasted, would be a great consideration. A few hints about packing, &c., would be very desirable in case I should send anything. I received a circular from Mr. Hunter respecting the Association. Is the object of the Association to raise funds for an annual exhibition? I have not sent in my name as a subscriber, but if this is the object I may yet do so. I have sown some phacelia seed in the garden and it is now in full bloom, but the bees don't seem to care near so much about it as some borage I have in the same garden. How do your bees answer in the new hive? Do they build straight combs and attach them to the centre of the bar? How often ought bees to be looked to? Could they be prevented from building their combs together by looking to them oftener?—S. RICHARDS, *Par Station, Cornwall*, July 10.

REPLY to No. 103.—We have delayed replying to yours because we wished to examine our hives, into which we put swarms only last week, to see if anything was amiss with them, but we found them (we have only two in the new hives) building perfectly straight and true. We cannot account for your mishaps unless on the supposition that the hive is not properly placed. It should be thus:—First fix it quite level, then place a brick-flat under each hind leg of the stand, when the bees will begin at the back and work forwards. You must admit the value of the moveable side-pieces, and that they answer well. It was bad management cutting the combs and setting the honey running. The hundreds of bees on the ground were caused by your over-smoking them. It is not necessary to *poison* them with tobacco; just a puff to alarm them and cause them to gorge with honey is all that is necessary. The scarcity of brood is probably due to the flush of honey now so general, the bees thinking more of the latter than the former, and crowding all the cells with it as fast as they become vacated by the young bees hatching out.

We are glad to find our replies to your queries have proved so correct and useful. Doubtless when you drummed No. 3 the queen was driven up with the bees, and was put into No. 2, leaving No. 3 almost tenantless until young bees hatched out;

and now you find the value of the young queen which has filled the hive with eggs, as if she loved the fun of depositing them, consequently the bees must either swarm again or take to the super so timely offered to them. No. 2 having the old queen and not much brood, is probably content to store its own hive, which will thus further lessen the action of the queen: and how then will they stand the winter, overcrowded as they will be, and with few, if any, young bees? There is one feature of hope, the queen, having a cessation of egg-laying forced upon her, will be the more fitting to begin early in the new year, and will probably do so if allowed: but in our opinion this is a case for the use of the Honey-Slinger, to clear out all the combs and set the lazy rascals to work again.

Your drone-trap and super shall be exhibited as you wish. There need be no calculation of cost for bringing the super back; it will certainly be sold if too much money is not asked for it. In packing so much depends on whether the honey can *run out*. If in vessels—glass supers, for instance—from which the honey cannot escape, they should be packed wrong way up in bran or hay, in boxes or hampers. All others should be put into vessels, or boxes, from which honey cannot leak, if by accident the combs get broken. Do not make the parcels too heavy, and put convenient handles to them by fixing ropes in convenient places. Half the damage done to parcels is occasioned through the clumsy character of the packing-case or hamper, which is often so formed that no one can catch hold of it to carry it, so it gets luddled over and over. The objects of the Association are those stated, and undoubtedly an annual exhibition will be held. Phacelia-seed does not seem to suit all soils so well as borage, but it is a great favourite with us. Our bees are doing wonders. The combs in the frame bar-hive are where they were intended to be, straight as lines can be. We can look when we like, we have only to turn up the quilt and there they are. Undoubtedly bees can be prevented building crookedly by careful daily examination and guiding, and when the quilt is used it is particularly easy: a tin staple, somewhat like that illustrated on page 24, Vol. II., but with parallel sides, being thrust between the frames at those points where the tendency is to join the combs or build out of the line is all that is necessary.—Ed.

QUERY No. 104.—1st. Having a large quantity of honey to dispose of, I want a market. Can you help me? and say what price I should expect and get for best super honey—drained, I suppose?

2nd. How most expeditiously and effectually to drain the above?

I have been for many years an experimental apiarian, but never sold a pound of honey; but I must confess I have never succeeded with any system as I have with Langstroth's; even last year (when I had only three of his boxes) I succeeded with his management, when Woodbury and Pettigrew did not even support themselves, having had respectively in the three boxes, with swarms of 1873, supers of 42 lbs., 28 lbs., and 23 lbs. The box from which I took a 74-lb. super, a fortnight since, has a 25-lb. super box just full, and has commenced in another larger one.—G. A. P., *Pullamelan, Clonmel, Ireland*.

REPLY TO No. 104.—I cannot tell you of a better market for your honey than that we have striven so

hard to establish at the Crystal Palace, a Honey Fair being one of the chief attractions to the great Bee and Honey Show which will be held on the 8th, 9th, and 10th of September next. Super honey in the comb will (or ought to) fetch at least 2s. per lb. if *pure* and white. Run, or drained, honey is often looked upon with suspicion from the fact that it is often adulterated and realizes less money. Supers, we know, are sometimes manufactured and filled with spurious honey, hence the above stipulation that they must be *pure* to obtain good prices.

In draining supers it is usual to crush the comb and strain the mass through a fine hair sieve, or flannel bag. The best plan is to have two or three sieves or bags, and as the comb is cut out of the supers to separate it according to its colour. White clover honey is the best, and is white as water; lime honey is dark and greenish, and there are sundry shades between, and some occasionally beyond, being almost black. After straining, the *débris* may be placed where the bees can obtain access to it, and they will clear up the sweets that remain, so that the wax chips will be dry and pure. We quite agree with you that Langstroth's system of bee-management is the best.

Your honey results are most encouraging, and ought to tempt you to send such splendid supers to the Crystal Palace Show.—Ed.

#### NOTICES TO CORRESPONDENTS & INQUIRERS.

SEVERAL CORRESPONDENTS.—The engraving of the central base of the comb was accidentally placed upside down.

J. E. C., Market Drayton.—There is little difficulty in transferring bees so soon after swarming. Twenty-one days is the time which should be allowed to elapse, as then, except some ripe drone brood, there will be little besides eggs in the hive. In your case, should you kill any larvae in cutting out the combs, they would not be liable to decay and cause foul brood, because the bees would suck up all the liquid portions of their bodies and throw the remainder out of the hive.

The Sale-Column is open to subscribers. There need be no expense incurred unless a sale is effected, when the goods must be sent from the vendor to the purchaser. We know nothing of the goods and never see them. We are simply the media of communication.

We cannot tell you the value of bees in your neighbourhood. Here such a stock as you describe would be worth about four guineas. Please consult the Index on the former queries.

J. T. W., Denmark.—Many thanks for the samples of seeds. We have sown the two 'strangers' and they are just coming up.

QUESTIONS AND REPLIES.—On the average we do not publish more than one out of every fifty. Many correspondents find it easier to refer to us than to their Journal, even though it has now a copious index. If we publish all, as you suggest, the *Journal* would be filled with them, and the repetitions would be wearying.

ENQUIRER, Wolverton.—The bees sent, if the progeny of your Ligurian (?) queen, prove that she has mated with an English drone. A pure Ligurian mother is incapable of producing a black worker-bee. Sometimes the pure drones are as dark as their English brethren.

We regret, through great pressure, to postpone a paper by Mr. Cheshire on the 'Philosophy of the Hive Shape,' and other important communications, until next month.

THE

# British Bee Journal,

AND BEE-KEEPER'S ADVISER.

[No. 17. Vol. II.]

SEPTEMBER, 1874.

[PUBLISHED MONTHLY.]

## Editorial, Notices, &c.

### THE CRYSTAL PALACE SHOW.

The Crystal Palace Show is now almost an accomplished fact, and promises to be an extraordinary success, paling every attempt of the kind which has hitherto been made in Great Britain. We are indulging in no stretch of imagination in reporting that the number of exhibits in competition will exceed three hundred, including, we believe, every imaginable necessary in bee-keeping. It would be manifestly unfair to analyse the entries before competition, or to give any data by which the possible chances of success might be gauged or guessed at; and we therefore content ourselves with the avowal of the fact that they are beyond our most sanguine anticipations. One of the most interesting objects in the Exhibition (not competing) will be the big super of 87 lbs. which took the first prize at the Manchester Show of last year, about the genuineness of which so many doubts were raised in this *Journal*, causing the sore discomfiture of those engaged in or cognisant of the means by which it was *manufactured*.

The live bees for manipulation will form a distinctive feature in the Show; but as there will be no competition amongst the bee-masters who are willing to show their amateur brethren how some of the operations, necessary in scientific bee-culture, are performed, we trust there will be no attempt to exhibit any sensational feats of daring in their proceedings. It is a well-known fact that bees will sometimes sting; and although an expert may know how to prevent this disagreeable exhibition of power on their part, we think it would be unwise to lead amateurs to believe protection to be unnecessary. 'He laughs at scars who never felt a wound,' and it is easy for one who is so saturated with bee-poison as to be comparatively invulnerable to stings, to laugh at the idea of protection against them; yet, inasmuch as the most sting-proof amongst us would not care to have a bee in his ear or nostril, or by an accident (to which the most careful are liable) to have his face made the target for the reception

of perhaps a hundred stings, we think it better to advise that the proceedings in public shall be conducted as nearly as possible as they would be in the private gardens of the operators, so that there may be no possibility of a sensation beyond that which will be most certainly awaked when it is seen how easily and SAFELY the various operations, so often described, may be performed.

Another feature of some interest will be the table of articles exposed for sale. There are many bee-keepers who do not care to compete for prizes, yet who have supers, or run, or extracted honey, or other articles, for which they would be glad to find a market; and as this is one of the declared objects of the Exhibition we hope to see it well patronized. The commission to be charged on all sales effected during the Show will be at the rate of one penny in the shilling, as previously announced, which we cannot but believe will be considered sufficiently moderate to warrant the expectation that large consignments of goods will be forwarded for sale, and that the importance of the Show will be thus very greatly increased.

There is one matter connected with exhibits which must not be lost sight of, and it is with respect to those articles, whether hives or other bee-gear, which require description: it is possible that say a hive, super, or bee-trap, may contain some special advantages, which may not at first sight appear, and hence it is thought that every exhibit, of a technical character, should have a descriptive label attached, that the judges may at once acquire a knowledge of the advantages which each exhibit is supposed to possess, and may therefore form their opinion, and make their awards. The advantage to amateur bee-keepers of this arrangement will be immense, as, if carried out, every one will be enabled to follow the judges, and form his own opinion on the merits of each particular article exhibited.

The list of judges is, we rejoice to see, a most comprehensive one; and we have little doubt but that their awards will be fully endorsed by public opinion. Amongst the list will be found the Rev. Wm. Chas. Cotton, of Frodsham, Cheshire; William Carr, Esq., of Newton Heath, Manchester; the Rev. George Rayner, of Mal-

don, Essex; C. W. Smith, Esq., of Totteridge, Herts; the Rev. D. W. Pennell, of Boston, Lincolnshire; Captain E. D. Lyon, of Sunninghill, Berkshire; the Rev. F. T. Scott, of Sibertswood, near Dover; J. Anderson, Esq., of Dalry, Ayrshire; Henry Morrison, Esq., of Hounslow, Middlesex; George Fox, Esq., of Kingsbridge; Alfred Neighbour, Esq., of Reigate, Surrey; J. Desborough, Esq., of Stamford; and J. F. Newland, Esq., of Wandsworth, Middlesex; all of whom have cheerfully accepted the onerous duty of judging, and whose awards, who shall dare to gainsay? Several other gentlemen of eminence as apiarians were applied to, but for various reasons they declined to act on the important occasion.

We are glad to observe that the British Bee-keepers' Association is increasing in numbers and funds, and trust that at its general meeting on Sept. 10, after the Show, such a code of rules, &c., will be formed for its governance as shall insure for it a long and useful existence.

We have been requested to state that a catalogue of exhibits and awards will be published within the Palace, which it is thought will form an excellent medium through which exhibitors can advertise their wares. Considerable space is already taken for this purpose, and those who wish to secure a notice of their specialties, should communicate *at once* with the Hon. Secretary to the Association, J. Hunter, Esq., 5 Eaton Rise, Ealing, who will state the terms, &c., on which the announcements may be ensured.

We regret that it is necessary to remind our readers that a few pounds are still required to complete the sum of One Hundred Pounds proposed to be given as prizes; we would also remind those who have promised donations, that now is the time for payment of the same, and we respectfully hope that those outstanding will be forwarded to the Hon. Sec. without delay.

This is the last opportunity we shall have before the Show takes place of calling the attention of bee-keepers and the public generally to the untiring zeal exhibited by the Committee of the British Bee-keepers' Association in promoting the establishment and furthering the interests of this great undertaking.

We are proud of the fact that the first Crystal Palace Great Bee and Honey Show has been brought about solely through the influence of the *British Bee Journal*. To the donors of the Prize Fund the thanks of all British bee-keepers are due, as to them is mainly to be attributed the inducement to enter exhibits for prizes, which is the main-spring of the whole affair. In one short week the Show will be held, and we do most sincerely trust that every bee-keeper in the United

Kingdom will consider it his duty by every means in his power to strive to make it a great and glorious success; and so we most heartily wish it God speed.

#### SEPTEMBER.

This is the month in which the skill and knowledge of the bee-keeper are more severely tested than in any other throughout the year; as during its thirty days all the necessary preparations for the coming winter must, or rather ought to be, completed. Before proceeding further, we recommend every bee-keeper to re-read the instructions given on page 66, &c. of Vol. I. of this *Journal*, as there will be found much to refresh the memory that is thoroughly practical and useful. Last year, to which the directions then given were particularly applicable, was so radically different from this year of grace, that some reference thereto, and comparison therewith, may not be uninteresting. That year, as a bee and honey year, was the very worst we have ever known. Many good stocks, which had yielded no profit whatever to their owner, either in honey or swarms, were found in August to be at starvation point; the weather having positively prevented them gathering sufficient for their own maintenance; and then it was we gave the invaluable note of warning against the practice of rapid feeding in autumn, which is too generally recommended. We pointed out that inasmuch as the scantiness of the honey yield had induced a cessation of breeding at an earlier date than is usual with bees in autumn, it would be specially unwise at such time to give the bees large quantities of food, and thus cause them to fill their cells and prevent oviposition by their queen; since the bees then in existence being all comparatively old and worn, would be unable to exist during the winter then ensuing, and urged the necessity for gentle feeding, on the ground that young bees being essential to the well-being of a hive during the long winter months, it was necessary that the queen should be stimulated to activity, and a late batch of brood procured. It is very probable that the labour of feeding and tending the young brood would exhaust, and cause the death of, many hundreds of the already half-worn-out nurses; but inasmuch as the same labour would be necessary later in the season, when breeding recommenced, when they would be still less able to endure it, and when probably no assistance could be given to them, the advantage to the stock by the substitution of young bees for old ones (even supposing there should be *no increase*) would be incalculable. There are doubtless many places in England similar to that described by Mr. H.



Jenner Fust, in a letter to this *Journal*, where drought and cold have prevailed to an extent that has precluded the possibility of honey-gathering; and in such cases the advice contained in the article to which the foregoing alludes is peculiarly applicable.

In the vast majority of cases, however, the results have been agreeably different, and such as to make the 'Comet' year of 1874 an epoch in the annals of Apiculture. The general complaint now is not of empty cells and starving populations, but of hives so crowded with honey as to render the existence of stocks during the winter doubtful in the extreme. In our own apiary, as described on page 54, we found, whilst using the Extractor, that many of our hives contained scarcely a particle of brood, and in some cases neither eggs nor larvæ; the bees, in their eagerness to secure the honey which was so temptingly abundant, having filled every available cell, and thus absolutely prevented the deposition of eggs by the queen, and the consequent production of the all-important *young bees*, so positively essential to the existence of a colony during winter. Bee-keepers of the old school are aware that bees which have gathered enormously from the heather seldom winter well, and attribute the fact to the excessive labour which they undergo in their arduous task of ingathering: and, doubtless, as the life of a bee does not depend on the number of its days, but on the amount of labour performed by it, there is a slight show of reason in the argument; but the true cause of the falling off of such stocks is *the absence of young bees* when they are put into winter quarters, from the enforced idleness of the queens through repletion of the hive, as before described.

In hives with fixed combs this excess of honey becomes an incurable disease; and it is really not surprising, considering the slight knowledge of the habits of bees which it was possible to attain when straw skeps only were used, that it was thought better to destroy the few old bees which were left in such stocks after the labours of the autumn, and appropriate the honey, than to leave them to perish inevitably, or be plundered by other less wealthy but more vigorous stocks, which having continued their breeding contain plenty of young bees, and are capable of offensive as well as defensive operations.

**AUTUMN TREATMENT.**—Bees in hives, on the movable comb principle, even though their queens may have been kept out of their nurseries for several weeks, through an extraordinary ingathering of honey during such period, may by careful treatment be induced to recommence breeding, and invest the hive with sufficient brood and young bees, late though they be ('and the later the better'), which, not having

had opportunities for labour, will ordinarily live during the winter, and be enabled to rear sufficient brood ere spring arrives to ensure the advent of early swarms, or good results in well-filled supers. By the aid of the Honey Extractor, as shown last month, the whole of the honey from a hive may be readily removed, and breeding space at once created; but inasmuch as this instrument is not everywhere at hand, other means, such as draining, must be adopted. In looking over the combs of a frame hive it will be easy to distinguish those in which brood exists, even in the smallest degree, and these must *not* be subjected to the draining process, since it occupies considerable time; and the brood, if kept out of the hive for any lengthened period, will be sure to perish. The combs that should be operated upon should be worker combs, and a thin hot knife should be used. The sealing of the honey cells should be shaved off, and the combs laid flat on a trivet, in a warm room, that the force of gravitation may cause the honey to leave the cells. The outflow of the honey may be increased if the combs be put in motion, after the manner of a child swinging; or if placed in a suitable vessel and swung round the head. In either case it is necessary that they should be supported on wire framework, or the swinging motion will cause them to break. When as much honey has run out as will readily leave the combs, they should be returned to their hive, being placed alternately between others that contain eggs or brood, when the bees will immediately clear out all the cells; and if the season is not too far advanced, the queen, under the influence of the excitement thus caused, will fill them more or less with her eggs, and so ensure a late but invaluable batch of brood; besides which, comfortable space will be created, in which the bees may cluster and form their winter's nest.

Bees in straw skeps, or in any other hives with fixed combs, whose nurseries are filled with honey instead of hatching brood, &c., are really in a hopeless condition as *stocks*, and it would be sheer folly to attempt to winter them, yet there is a disposition amongst amateur bee-keepers which will induce many to '*try the experiment.*' In these cases the only wise course is to break up the stocks and remove the honey—operations usually involving the loss of the bees, comb and pollen; or, if an attempt is made to save the bees, it is usually done by placing them in an unfurnished hive, and feeding them, to enable them to build (and store) new combs in which to pass the winter,—an experiment which usually fails, and is never profitable.

**CONDEMNED STOCKS.**—We wish we could persuade those who intend to 'take up' their stocks with a view to the appropriation of their

honeyed treasures, to utilize the bees, brood, and pollen combs, instead of throwing all or either of them away. Many we too well know *will* persist in the use of the hateful sulphur pit, and thus destroy their *bees*, and render the brood and pollen combs useless. Others fumigate the bees, and unite several families into one great swarm, which they place in an unfurnished hive, and expect them in a few weeks to build a new set of combs, and gather at the *end* of the season sufficient pollen to enable them to pass the rigours of the approaching winter with safety. Surely when it is remembered that many early swarms are unable to do this during a whole summer, it is *not* surprising that the experiment generally ends in disappointment. We cannot too often repeat that the life of a bee is measured not by days, but by the amount of labour it has performed; and although these united bees may, and probably have, a liberal supply of food given to them wherewith to make their combs, the great physical labour and wear and tear of nervous power involved in its digestion, the secretion of wax, the building of the combs, and the rearing of brood at a time when pollen is scarce, are too exhaustive to be long endured; and after a very short time the bees will have become *old* and worn out, and unable to survive the inclemencies of the four or five months of winter weather they are usually called upon to endure; and it will seldom be found that a sufficiency of young bees has been produced to enable the stock to continue in existence.

The system we adopt, and most strongly urge as the best, is to drive out as many bees as possible, by the drumming process, and to fumigate the remainder, so as to cause them to fall out of the hive, or, at any rate, to remain quiet while the combs are being cut out of it. In doing this we do not use the honey-knives usually sold for the purpose, as, instead of *cutting*, the hooked one *tears* the comb, and is consequently a delusion and a snare. We therefore prefer to cut the skep in twain between the combs, so that with an ordinary table-knife they may be *cut* out without difficulty, and almost without breaking a cell or causing a drop of honey to bleed from them. They are then laid upon a transferring board, the cells uncapped, and the protuberances of the comb removed, after which they are placed in the Extractor, and the honey removed, when they are fitted into frames, placed in a bar-frame hive, and the bees restored to them.

In these cases *there is no loss*—the honey has simply been removed for the use of man, the brood is all preserved, the combs, being in a moveable comb-hive, have increased in value, and all the spilled honey (if any), and that which may have run on the boards or be left in the caps of

the cells which have been shaved off will be re-collected by the bees, and joyfully carried to their new domicile. Stocks thus treated suffer scarcely at all from any excess of labour, except such as may be caused in the rearing of an additional batch of brood, which, as shown before, will be a great advantage, and which under the influence of the excitement caused by the clearing up and repairing of their combs will be almost certainly produced.

In the absence of the Extractor, the brood-combs, *i. e.* those *containing* brood, should first be attended to, to prevent its (the brood) becoming chilled. It is probable that in many skeps there will not be a square foot of brood altogether, in which case it should be carefully cut out in squares, so as to fit nicely into and quite fill, from top to bottom, one or more of the frames, and when tied in it should immediately be placed in the new hive and the bees added, to keep it at its proper temperature, while the combs charged with honey and pollen are being unsealed and drained. During the process of draining care must be taken to exclude all bees from the operating room; or, attracted by the odour of the honey they will besiege the place and take it by storm. Those only who have witnessed this kind of attack can form any idea of the perseverance of the bees; and how, having once obtained access to the sweets, they will return again and again, not only to the same window or lattice, but to any other near by which may be open, to the great annoyance of the household. The drained combs will be found to contain large quantities of pollen, which, had the combs been *crushed* and *pressed*, would have been mingled with the honey, and would thus not only have been lost to the bees, but would have spoiled *its* (the honey's) purity and flavour. When the draining is completed the combs should be arranged in the frames of the hive and carefully tied in, or the lath which forms the temporary support to the combs may be propped up with corks (see page 25, Vol. I.), and the pieces of combs kept in position with tin clips (see page 24, Vol. II.).

FEEDING BEES.—When feeding is necessary, and in the best-managed apiaries there will be sure to be some stocks which more or less require artificial aid of this kind, we repeat our conviction, expressed last year, that it cannot be too deliberately proceeded with. Rapid feeding may get the work over, but the injury to the bees, through the sudden influx of a glut of syrup, may in some measure be calculated by the effects of the great inflow of honey during the Comet month of July last, which caused the bees to act in the most suicidal way, stopping their breeding, and, metaphorically, choking them. The bottle is the best kind of feeder, as the bees are enabled to take the food

without leaving their cluster, and since the introduction, by Mr. Cheshire, of perforated vulcanite, which is a perfect non-conductor, in lieu of perforated zinc, which is one of the best conductors of heat known, the food may be thus administered without the slightest chill or condensation, and from the arrangement of the perforations the quantity presented to the

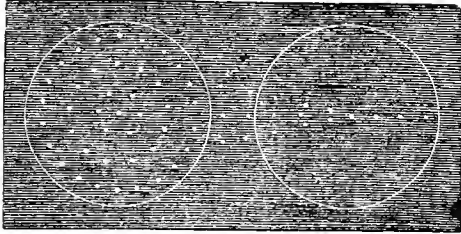

bees may be regulated with the greatest nicety. The vulcanite employed is not thicker than zinc, and may be perforated with a hot knitting-needle, or hair-pin. The principle employed by Mr. Cheshire in his arrangement of the perforations is that of the wedge, the *thin end* of which is so well known as a bugbear, but which for the purpose here intended is invaluable as a governing mechanical power. The whole matter is very simple, as will be seen by the engraving; the bottle is supposed to be standing upon the vulcanite, exactly over the feeding-hole, and the vulcanite being moveable the wedge may be 'driven,' or 'withdrawn,' to suit the necessities of any particular stock to which it may be applied. Another method, and one which perhaps is more easily manageable, consists in giving the wedge a curved form, mechanically called a 'snail,' as illus-

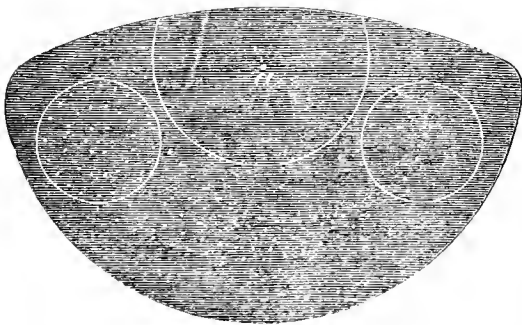

trated. It is moveable on its own centre *a*, through which a small tack or screw is driven, and accordingly as the disc is moved to the right or left under the bottle, the supply of food, through few or many of the perforations, is controlled. The vulcanite is so perfectly smooth in itself that it is necessary to roughen the under side of it, or the bees would be enabled to hold on and might be starved, and this may be done by scratching it with the

point of a penknife, or slightly excoiating it with a hot wire.

UNITING BEES.—A knowledge of the best means of uniting bees is useful at all times, but at this particular season when stocks are being prepared for the winter it is more especially necessary to understand the principles upon which bees of different communities may be safely united, and made to live together as one family, under one queen, and having only one common interest. The safest means of uniting is the reducing of the stocks, swarms, parcels, or remnants to be joined together, to a common level of poverty, by the temporary removal of all their riches, so that they may have literally *nothing to defend*; they will, then, if put together, amalgamate peaceably and rejoice in the increase of their numbers, as offering the readiest means of recovering, by renewed industry, their lost position as wealthy citizens. When the first buzz of excitement or alarm is over their combs may be returned to them, or they may be placed in a hive containing combs, on the stand formerly occupied by the stock to which the additional bees have been given. It is always unsafe to attempt to unite stocks which have been standing in different parts of the apiary, without first bringing them gradually together by very short stages, so that when united their joint home may be as nearly as possible on the spot to which they have become accustomed. In many cases it will be necessary to unite the bees of several of the skeps, which have dwindled through the early discontinuance of breeding, of which we wrote last month, in order to make up a reasonably sufficient number of bees to form one colony *seemingly* capable of enduring the winter; and when this is necessary, a hive containing the largest proportion of empty comb should be devoted to the united bees to give space for breeding, and stimulative feeding should be resorted to to develop and encourage the queen in her pleasant task of egg-laying, so that as many young bees may be produced as is possible. The uniting of bees is really a very simple affair: in straw skeps they should all be driven by drumming, as if forming artificial swarms, in separate empty skeps, and then the whole of them should be tumbled into one large skep and hustled and shaken together, so that they may become well mixed, when they may be all put into the hive of combs they are to occupy. Uniting the bees of bar-frame hives only requires that the combs of brood and honey should be first removed from all those to be united, when they may be put together with perfect safety, and in a few minutes such combs should be returned to them as contain brood or eggs.

Stocks from a distance may be brought to an

apiary and united at once, by observing the foregoing directions, and leaving the bees, already in the apiary and to which they are to be united, with nothing to defend or fight about.

**ROBBING.**—This may be immediately prevented, or stayed, by the use of a little carbolic acid. A handful of wet hay laid lightly across the entrance of a hive with a few drops of the acid sprinkled on it is a panacea for robbing. Some of the acid thrown upon a sack, and the latter laid over the front of the hive, acid inwards towards the entrance, will also stop the plundering.

**WASPS.**—These pests should be trapped, wine-bottles containing a little beer are sufficient as traps, but the best course to rid the place of the sneaking rascals is to attack their stronghold, putting a little turpentine into their nests, which will quickly destroy the whole of them.

#### OPENING A BAR-FRAME HIVE.

By particular request we describe the process of opening a bar-frame hive, for the purpose of examination. There are some preliminaries to this kind of operation, which the amateur should always bear in mind, for on them, in a measure, depends the success of the operation. We will *suppose* that the combs are straight, and well within the frames; for unless they be, the operation will hardly befit a novice, but will require a more practised hand for its fulfilment. We will also *suppose* (by request) that the moveable comb hive is a Woodbury of the true pattern, and that the bees are, as bees often are, of uncertain temper, and not to be trusted; in fact, the intention in the request is, that an amateur in his novitiate may learn 'how to proceed in what seems a very formidable business.'

Having regard to the causes of offence to bees, and with a view to imparting confidence to the operator in case of accident, he should be veiled and gloved; the veil should be of stiff material, otherwise the wind may blow it against the face, while the bees, perhaps offended with the breath of the operator (for one can never be quite certain on this point), may be endeavouring to get at him, in which case the veil would probably be riveted to the check in a painfully sensational way, and without the slightest warning. The gloves should be furnished with gauntlets of holland or calico, with elastic run in the hem, to grasp the sleeve and prevent inquisitive bees obtaining access to the hands or wrists by the back way. Many gentlemen, when operating, doff their coats for greater freedom; but we strongly advise no one to do so whose under-sleeves are of flannel, as bees are apt to sting it most bitterly. This is not because of an antipathy to flannel, but

because, as with the human hair, they get their feet entangled, and in their alarm they 'rouse the garrison,' and bring against the unfortunate garment a host of venomous darts, some of which may prove that flannel is not invulnerable. Those who object to being stung about the legs should wear a short pair of knickerbocker gaiters, or should pull open the tops of their socks and wear them gaiter fashion, outside of, instead of under the trousers. Being thus protected a novice has no cause for fear; the bees will be quite unable to get at him; and their hum, however noisy and threatening, is only *hum* after all, and cannot do any mischief. Therefore, he may proceed to open the hive, which should, nevertheless, be done with the greatest care, so as to avoid, as far as possible, all offence to the bees; for every bee that uses its sting loses it (as a rule), and with it its life—not, as many suppose, from being killed on its return to the hive defenceless, but because the tearing of the sting from the body tears also a large portion of the bee's intestines.

*Supposing* the bees to be excitable, and perhaps vicious, the first thing to do is to subdue them, for which purpose the smoke of tobacco, rags, corduroy, or touchwood, may be employed, or, as was used more than 1800 years ago, the fumes of burning ox-dung (dried). The use of the smoke is to frighten the bees and cause them to gorge themselves with sweets; but it sometimes happens that the hive contains little or no honey available, from its being sealed or from actual deficiency of it, and therefore the bees cannot obtain a supply; under which circumstances, as the effect of the smoke quickly passes away (unless they are almost suffocated with it), they become more irritable than otherwise. The operator must therefore weigh in his own mind the probabilities of the sufficiency of the honey supply, or, as is perhaps the wisest and safest course, take it for granted that the quantity is limited, and provide an artificial supply in the form of sugar-syrup, which for convenience should be in a bottle, the cork of which is notched so that bees cannot enter, but by means of which the syrup may be ejected or spurted over the bees and combs as soon as the lid, or crown-board, is removed. This bottle arrangement is on the plan of the vinegar-bottle used on oyster-counters in many parts of England, and must be too well known to need further description.

All being in readiness, a little smoke should be blown into the entrance, and the screws or other fastenings of the crown-board withdrawn, the screw-driver should then be inserted between the crown-board and the hive, and gently prised upwards about an eighth of an inch, through which crevice a little more smoke should be ejected to cause the bees to

descend amongst the combs, while the crown-board is being prised up and removed. If, as is often the case, the space between the tops of the frames and the crown-board contains honey-comb, which will necessarily be torn and broken by the removal of the latter, sprinkling with syrup will not be necessary, but the crown-board should be placed near the entrance of the hive, that the alighting bees may get the best chance of having what belongs to them; or, being simply lifted off, it may be allowed to rest above the hive, supported by two or three pieces of stick, and a cloth thrown over the whole until the bees have cleaned up the running honey, which they will do in about five minutes, when it may be taken away, and the invasion of the hive proceeded with.

The frames resting in notches, it will be necessary to raise them from their bed, into which they are usually found firmly glued by the bees with propolis, for which purpose the screwdriver will be again required as a lever. The chief difficulty then will be to remove *one* of the combs; for even though straight and well within their frames, there may be protuberances which, in raising a comb upward, would graze against the combs on either side of it: therefore it will be necessary to create space by moving each of the combs laterally as far as is possible from both sides of that selected for extraction, which should be the thinnest, straightest, and truest in the hive. The lateral movement of combs for the purpose of creating space is obtained by raising each comb out of its notches, beginning at the outermost, and pressing it just a little nearer to the sides of the hive. The first thus raised will not bear displacing more than say an eighth of an inch, the second may go a quarter, the third three-eighths, and so on; so that if combs be thus displaced on both sides of the selected comb there will be fully an inch more space given from which to withdraw the latter, which may be accordingly raised for examination.

Being out, what is to be done with it while the other combs are being overhauled? We would suggest that two nails or screws should be driven into one side of every Woodbury hive, or hive of similar pattern, to rest the first extracted comb upon, since otherwise it may be necessary to place it upon the ground, when it may be kicked against by the foot or blown down by the wind, and possibly a queen injured or destroyed, to say nothing of probable injury to comb and brood or the bees attached to them.

The first comb being thus disposed of, the others may be examined seriatim, due care being exercised in returning them to their individual positions, otherwise they will be mismatched, and cause much inconvenience in the hive; besides, in such cases, the endeavour to

find out the error and re-match the combs may lead to greater confusion. To prevent this, the front ends of the frames should be numbered to prevent misplacement, and the chance of their being accidentally turned the wrong way round, which would add considerably to the difficulty. The combs having been examined, will, except that first extracted, be replaced in the hive, and now, by a repetition of the first arrangement of the combs, space must be created for its restoration, which having been done, and the latter replaced, all the combs must be restored to their original notches; a series of operations requiring great care lest some unfortunate bees should be crushed, and, emitting their sting poison, cause a cloud of bees to rise and attack the operator. In replacing a comb in a Woodbury hive there are three notches into which it must be guided, the most tiresome of all being that in the bottom rack, which, being of thin material and supported only at the ends, yields to the pressure put upon it in the endeavour to find the notch in it, and often releases some of the frames already in their places, throwing them out of plumb and disorganising the brood nest, for in such cases the combs disarranged must, some of them, be too close together, and others too far apart. There now only remains the crown-board, most probably covered on its underside with rows of comb, or propolis; and what is to be done with it? We strongly advise every amateur who has once got his Woodbury crown-board off his hive *never to put it on again as such*, but to adopt that best of all arrangements, the quilt. If the crown-board be replaced without cleaning, numerous bees will be crushed among the ragged portions of comb between it and the frames; if it *be* cleaned, the bees will set to work immediately and build anew, so strongly do they protest against that curse to bar-frame hives, the space above the frames. Ever since we have adopted the quilt as a covering for the frames, &c. of a hive, we have been convinced of the uselessness of crown-boards for the purpose intended. Quilts are beyond question the best possible coverings, and this must be admitted by all who use them. Our quilts are simply squares of old Brussels carpet, the wrong, or under side, being laid close upon the frames; on these we lay 'blankets,' composed of squares of old felt carpeting, which we use two or three folds thick, and over these a crown-board, if one pleases to so call it, it being a board with a large hole in the centre, and a rim nailed round it, which rim lies downward upon the edge of the quilt, pressing it close on to the walls of the hive, and keeping the board clear of the quilt and blankets, so as to permit the ventilation which passes through them to escape through the hole in its centre.

## Correspondence.

\* \* \* These columns are open to Subscribers, so that their queries, replies, correspondence, and experiences, may be fully and faithfully recorded; and for the discussion of all theories and systems in Bee-culture, and of the relative merits of all hives and appurtenances, that the truth regarding them may be ascertained. The Editor, therefore, must not be expected to coincide with all the views expressed by the various writers. All Correspondence is addressed to the Editor.

### PHILOSOPHY OF HIVE SHAPE.

I have been reading, or rather re-reading, with much interest and profit, the valuable communications of your experienced correspondent 'A Renfrewshire Bee Keeper,' who puts before us, with singular happiness of manner, the excellencies of the Stewarton Hive and System, which he evidently treats *con amore*. Of course, some of the advantages enumerated are not exclusively possessed by the Stewarton Hive, but are common to many rival competitors for fame and honour. By example—'the plan of admitting only the honey-gatherers of the end combs to the supers, to the exclusion of the queen, the nurses and the pollen collectors of the centre,' is claimed for the Stewarton Hive as being one of its 'most valuable features;' but, since the idea is denominated 'ingenious and original,' no doubt we are only to understand that it was first introduced into the Stewarton, although now possessed by almost every storifying or supering hive worthy of adoption by the advanced bee-keeper. Here, then, and in some other instances, those who virtually advocate rectangular hives by using them, may be congratulated upon their ability to show that they run in no uneven race; but your esteemed contributor, while summing up the whole matter, puts the question of shape in such a way as to force those who adhere to the rectangular form, either to tacitly yield the palm, in this particular, to the Stewarton, or to contest the absolute validity of the argument adduced. At p. 54, vol. I. of the *Journal*, in the article referred to, we read,—'I should like to recapitulate some of the advantages of the Stewarton to the practical bee-keeper, over more vaunted and fanciful hives. First, then, as to form, all the best of the old writers on the subject are agreed that the nearest approach to a sphere (an octagon) is the most suitable shape; and certainly in my experience I have found that in such, the heat is more concentrated than in square hives, where it evidently must be weakened by being dissipated in the corners. In the latter I used always to be obliged to remove the outer combs to prevent mouldiness during winter.' Here then is a direct issue, and while venturing to offer a few suggestions in this regard, may I be allowed to say that I do so in no partizan spirit, but with the idea expressed by yourself in the prospectus of the then proposed *Journal*, that by friction of thought truth may be eliminated. The question is one of great interest to all true lovers of the science which we desire to see advanced and is of the greatest importance at the present time, when most bee-keepers, worthy of the name, seem to have

made up their minds as to the vast superiority of the bar-and-frame principle, and so many are bending their energies either to modify existing hives, or devise new ones truly in accordance with the instincts and requirements of the bee, while affording the greatest possible facility for all the varied manipulations of profitable bee-keeping or scientific investigation. A question seems to me to underlie the matter of hive-shape, which will repay a little thoughtful consideration. I refer to the shape of the cluster, for if we can satisfy ourselves as to the reason of bees hanging as a swarm, and clustering for comb-building in a mass approximately globular, we shall possibly have advanced a step in determining to what extent it is necessary or desirable that the hive should conform to its outline.

If a contention arise in our streets, and the disputants be surrounded by onlookers, these latter will arrange themselves in a ring, simply because each new arrival on inquiring 'What is the matter?' will seek a point where he may stand nearest the centre of attraction, and get the best opportunity of seeing for himself. The result is, that additions to the crowd are always made where it has its least diameter, so that the effort of each individual to get to the centre obliges the mass to be circular. Transfer in imagination our crowd from the street, where it can collect only in one plane, to the air where this restriction would be removed, and we see at once that for the same reason it would have impressed upon it a globular form; and can we be wrong in concluding, that during swarming the instinct of each bee impelling it to identify itself as closely as possible with the general mass, is the presiding cause of the spheroidal shape which every swarm assumes; and that the necessary high temperature for wax-producing, driving the bees towards each other for mutual warmth, produces the same result in the cluster? Both the swarm and the cluster should theoretically be perfect globes, but, in the one case, the form is always elongated perpendicularly by the action of gravity, while, in the other, the support given through the solidity of the mass by the combs almost preserves it from this interference. If here we look through our bees beyond them, can we avoid reflecting how truly is all nature one? The soap-bubble owes its sphericity to the mutual attraction of the particles composing its pellicle. The rain-drop takes its form from a similar cause to that which shapes the burning sun, the silvery moon, the twinkling stars, and the earth on which we tread.

We now ask, Is this globular form the best? or, in other words, does the blind instinct of the bee lead to that which a perfect knowledge of the laws of nature would dictate? The answer is an undoubted, Yes! In No. 2, Vol. I. of the *Journal*, the interesting fact is explained that the bee builds its comb with the least possible amount of material, with the greatest possible strength, and in the least possible space; that the most accomplished mathematician reaches with labour what the bee does blindly and at once. But are we to suppose that in the matter of comb-building alone, instinct is a perfect guide? Assuredly not! Nor is it difficult to discover advantages in the form of the cluster which no other shape could supply. By example,—if we



ask, 'How shall bees be arranged to enable them to shelter the largest amount of brood, to cover the greatest surface of comb, or to retain their temperature with the least loss of heat either by conduction or radiation?' The answer in each case must point to the sphere as yielding these advantages in the highest degree.

Let us now submit these assertions to the rigid test of calculation, which we will uniformly refer to a hypothetical hive-population filling 1000 cubic inches. The most dense and compact rectangular form is the cube, and if its content be that indicated above, its edge will measure 10 in., while its sides, of which there are six, will each have an area of 100 square in., making the total area 600 in. This mass of bees, however, if spherical, would have a diameter of  $12\frac{2}{3}$  in., and the surface of such a globe, found by multiplying the circumference into the diameter, would be only 483 in.; and as 480 is exactly  $\frac{2}{3}$ ths of 600, we might roughly say that the loss of heat from a cubical and globular mass of the same solidity, *i. e.* containing the same number of bees, would be represented by 5 and 4 respectively; or, in other words, *ceteris paribus*, 5 lbs. of honey would be required as heat-forming food in the first case, where 4 lbs. would be sufficient in the second.

Nor does this loss of heat and consequent loss of food at all represent the whole of the disadvantage, for in the cube the corner bees would stand at  $8\frac{3}{4}$  in. from the centre, while in the globular form the outside ones would occupy a position no more than  $6\frac{1}{2}$  in. from it. These, or similar considerations, together with the observation that never in an open space is a cluster other than convex in every part, have led, probably, to the idea that the hive ought to have the same model; and so it happens, as a 'Renfrewshire Bee-keeper' says, that 'all the best of the old writers on the subject are agreed that the nearest approach to a sphere (an octagon) is the most suitable shape.' Your contributor is undoubtedly, as his letters testify, an acute observer, and here he wisely does not give us the opinion of the old writers, even though they be the best, as a finality, but adds his own experience, together with a statement that in square hives the heat 'evidently must be weakened by being dissipated in the corners.' It is to this statement that I venture to take exception, leaving the old writers, who give us no reasons for their opinions, to those who lean upon the opinions of others, since they have none of their own.

Probably the square hive to which reference is made, was upon the bar-frame principle, and had, as was universal, a space between the crown-board and the bars. If so, this radical defect, as damaging as it is unnatural, must plead guilty to having caused the dampness of the corners. But since I dilated at some length upon the evils resulting from this most crying error in the ordinary bar-frame hive in a recent number of our *Journal*, the arguments there adduced may be understood as expressed here, while we may devote ourselves to some other points not as yet debated.

If a straw skep be turned up in the winter, the bees will generally be found congregated in from two to four seams, the collective width of which will almost always be found less than their length.

The circular form is not now retained, for the obvious reason that the combs on the sides of the cluster give a most effective shelter, whereas the edges of the seams are fully exposed to the cooling effects of the circulating atmosphere. The marvellous protection that the side combs afford, we shall the better understand if we remember that the individual cells are either filled with air or with store. If the first, the narrowness of the cells prevents anything like a free circulation of the air they contain, and its high non-conductivity makes the loss of heat through the combs from the outside seams extremely small. If the second, the bees are as well secured, as honey thickens with a low temperature, and can only be heated by what is technically called convection, *i. e.* each particle taking up its caloric for itself and then rising to be replaced by some cooler portion. But, further, if bees receive any check in comb-building by a cool atmosphere forcing them to contract the field of operation and hang more closely to each other, we find that they subsequently become more willing to increase their combs in length than in number, because they are now laterally protected. This abandonment of the circular form in winter, and often during comb-building, for one approximately elliptical is clearly justified by the considerations just given, and at least tends to throw doubt upon the suitability of the hexagonal form.

But in giving preference to the regular polygon, has not the fact been overlooked that bees are not stationary in the hive during the winter, but make a slow progression towards the bulk of their stores? Apianians well know that the cells as well as the spaces between the combs are filled in winter by bees, and that they lie in a densely congregated mass in close contiguity to their honey, which is kept warmed by heat slowly diffused from the cluster. During long-continued cold, the consumption of food, as indicated, gives the mass of bees new cell-space into which to thrust themselves, so that they gradually gather up, as it were, on the one side and move towards the reducing stores on the other, and then usually draw from the mouth of the hive towards its back. If then the winter cluster be elliptical rather than circular, and this ellipse move along in the hive in the direction of its longer axis, it cannot be claimed that the Stewarton in any sense fits the mass of bees, nor can it afford them any better all-round protection than an oblong or square hive. In a correctly planned hive the heat gains no access to the corners except the bees occupy the outer interspaces, and then the elevation of the temperature of the store near the corners follows as a matter of course, and is also highly important. The heated air should rise from each seam of bees and fill the space between it and the hive roof, by which means the honey will be kept warm and ready for immediate consumption. Cogent reasons can be given for not having this space too deep, quite apart from the extreme weight of the combs being sufficient to break them down in warmer weather; those who have seen bees building in roofs and wide open spaces, testify that their combs are usually very long in comparison with their depth or number.

The shortness of the central bars in the Stewarton



appears to me to be a grave objection, because the store in such spells of cold as are not uncommon in the north get consumed in the combs covered by the bees, while the very power which they possess of husbanding heat will keep the outer ones which might be filled with purest honey so icy cold that the bees will be unable to touch them, and they may then starve close to the abundant spoils of their industry. Not long since a comb had inadvertently been omitted from the centre of a prosperous hive too late in the year for the bees to resupply it. They wintered on one half the store, which they completely consumed, and then died within a few inches of abundance, contact with which would have chilled them to death. Is not the cause of bees apparently starving, when, as we often read, the hive contains plenty of honey, frequently the one indicated? In conclusion, when we consider that rectangular bar-frame hives are cheaper, more easily constructed, and of greater strength than others, and that they give greater facility in management on account of the interchangeability of their frames, stronger reasons than any I have been able to imagine, alone can render it advisable to adopt either the hexagonal or octagonal form.—F. CHESHIRE.

#### FOUL BROOD.

There are times when circumstances prompt us to cry and laugh at one and the same time, and this feeling is almost felt on reading our Stirlingshire friend's correspondence on the above subject; and hope no offence will be taken when I venture to ventilate the subject a little more.

In the first place, he alludes to foul brood as a fearful calamity. This it truly is. Secondly, he speaks of the seed of the disease, but does not give the characteristics of this seed; thirdly, there is no infection unless it has originated in a hive, and that the honey from such infected hive can be used without fear, giving as the key to this assertion, that foul brood does not originate in honey from flowers of the field; fourthly, he has succeeded in one cure, but does not enlighten us fellow-workers how he accomplished this cure. This was the substance of the first letter; and in a note our able Editor politely, wisely, and in time, gave a word of caution.

In the second letter he states that American and European bee-keepers are in error, and he was ignorant of their error of teaching that foul brood is infectious. He then proceeds to relate concerning a Ligurian queen, but does not enlighten us regarding which month the year before he gave her to the hive alluded to, but that it turned out foul in the following May; and here he at once knew how to act. Further on he alludes to a queen of her progeny, but neglects to state if the hive spoken of is the same as that in which the original queen was in, or if the leader of a swarm, natural or artificial. All these statements are, perhaps, clear to his own mind, but, I must confess, appear very unsatisfactory and unintelligible to us outsiders, and so far have only interest for himself. But what is this for an expression that follows—'if it be infectious?' Surely this is confession of a doubt in his own mind that it is infectious, more especially by stating that it can

be engrafted by foul comb put into a healthy hive. The word 'piece' is used in his letter; but if a piece will have the effect surely a whole comb will, stating at the same time it cannot be infectious in any other way.

In the next sentence he makes a lynch law, harsh and unwarrantable accusation, against American and European bee-keepers, which is not worth more than silent contempt. Next, after having stated his doubt of infection he boldly states there is no infection. Its origin and cause (would that he had or would explain what these are!) have taught him and his masters that it is not infectious, but a disease caused by some substance or material (probably alluding to the seeds spoken of before); and after viewing it—but, perhaps, not experimenting—in that light arrived at the conclusion that it is not infectious, but harmless, and this to his satisfaction. But, I must confess, the word 'harmless' does not correspond with the opening sentence—'fearful calamity'—or what he relates about the yield of honey the first year.

Our friend says that if 'Novice' will pay strict attention to his apiary he will in due time find it in its true form. Now it would be interesting to know what is meant by 'strict attention,' as also a description of the 'true form.' Therefore, as a beginning, I will, as far as my observation and experience has taught me, give a description of the true form of foul brood, that others may judge if they have it in their apiary or not.

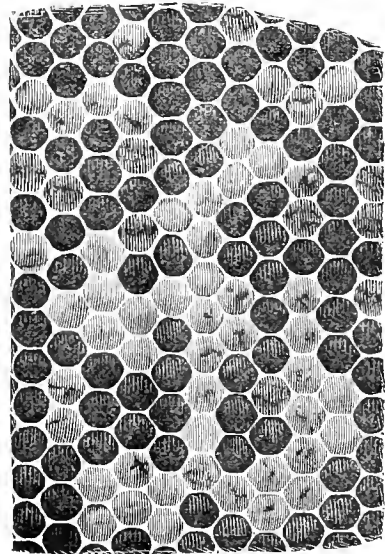

Foul brood may be known by the comb being, here and there, black on the surface, and having a peculiar offensive smell; secondly, the first stage is known by the cells containing a whitish-brown sticky matter, which in time partakes of a dark brown colour; and on stirring it with any small pin it can be drawn out in a long fine thread, and is exceedingly tenacious and elastic. The cells containing this matter may be distinguished by the covering being sunken with a small hole in the centre of the cover.

In most instances, where these cells are found, by examination it will be found that larvae, from one to six days old, lay dead and rotting in the surrounding

cells, and often the older larvæ are only distinguishable in the form of matter as above mentioned. This matter quickly dries and forms a hard black scale which adheres fast to the underside of the cells, and often, like the matter, defies all efforts of the bees to remove it, and has to my observation and experience proved highly infectious; and it has not come under my observation that the queen has from this stage deposited eggs in such cells, but that they have been filled with honey by the bees, and this honey in turn used by the nurse-bees for feeding the larvæ, which is the stage of life that infection and destruction take place. The covered cells with holes in are, I believe, six days' larvæ that have died while, or directly after, covering.

The seed of the disease is here generally considered to be a fungus (*micrococcus*), the reality of which I have not seen for certainty under a microscope; but that there is to be found, at the bottom of every cell where a rotting (brown) dead pupa is taken out, a small white substance which, when examined under the microscope, appears to be a fungoid growth not to be found in healthy hives.

After careful observation it would appear that foul brood can be propagated by too much exposure of the larvæ to cold, either from a continuance of severe weather after a warm period, which has induced the queen to lay eggs in proportion to such warmth and the number of bees sufficient to nurse them; and then the alteration of temperature compelling the bees to cluster again for their own safety, leaving the larvæ to their fate for so long time that decomposition takes place, and so fouls the cells to begin with, and lays the foundation for an unhealthy colony. In most cases the time is so short that the bees destroy the larvæ and suck the juices; or a warm period returns early, and the bees distribute themselves and clear the cells before such decomposition take place.

Another mode of propagation is probably a too frequent examination of the interior of the hive in early spring-time, and unnecessary long exposure of combs containing larvæ; and the hive losing its temperature at the same time compels the bees to cluster as before to raise the necessary warmth; and as a bee's activity at this period being far from what it is later on, some time elapses before they recover, perhaps, in time to save the larvæ perishing, more especially should unfavourable weather set in after or during such examinations. In both of the above the construction of hive has great influence, the best being those that resist the influence of cold when closed, and not allowing the warmth to escape when open; for this reason, it may perhaps be attributed that seldom does foul brood exist in the straw skeps in proportion to its prevalence in frame-hives.

Foul brood may be proved to be infectious by placing a virgin comb, with eggs, into an infected hive. Such comb will, without fail, soon show symptoms; and how can this be otherwise than that the nurse-bees infect the larvæ through the honey they feed them with, or that the effluvia of the hive produces the same sickness in the larvæ in the new comb? And that there is an infection in such a hive may be proved by placing a natural swarm from a clean hive into a hive that has contained foul brood pre-

viously; whereas, were such swarm put into a clean empty hive, that is, one in which no combs or frames that had been previously used in any foul hive had been put in for such swarm, but that they be allowed to build all, in the first case there would be, in a short time, foul brood, in the latter a healthy stock would be the result; and whereas, the same swarm put into a new hive, with combs free from honey, foul-brood infection would, in a short time, show signs. I, therefore, look on these trials as proof of infection from contagion with foul comb, from contagion with foul hive and contagion from honey.

There is also another mode by which a bee-keeper may obtain foul brood in his hives (I had nearly said without knowing how), and which occurred with two hives of mine in May-month, this year, as follows:—A neighbour, who had a hive severely smitten with foul brood, had his attention called to the fact that his bees had left their hive and settled in a garden near at hand. He immediately prepared, and succeeded in replacing them in the hive again. They settled for that night; but, on the following day, left the hive again and flew over to mine, and divided themselves over two hives, causing considerable slaughter to take place at first; but the inmates of the two hives finding their visitors, to all appearance, well supplied with honey, at last made no resistance, but in a manner welcomed them, flying about the whole day holiday-making; but at night all was quiet again. The next morn a little stir and all was in order again. The result of this little affair was foul brood in a mild form in both the visited hives.

Many have put the question, If foul brood is infectious, how is it that a natural swarm does not carry it with it when put into a new hive? Such is difficult to answer; but my opinion, given as answer, is as follows:—It is well known that when a natural swarm leaves the parent hive the bees leaving take, according to estimation, a supply of honey for two or three days' consumption. This being the case, if such swarm is put into a hive with ready-built combs, the queen commences to lay as soon as possible, and the honey brought is deposited in cells, and with other used for feeding the larvæ; and this honey, having been contaminated in the foul cells of the parent hive, infects the young brood of the new swarm. Whereas, when a swarm is hived in an empty hive the greatest amount of this honey goes to the production of wax for the new combs; and by the time the cells are complete for the queen's use the greater portion of such honey from the parent hive is consumed; so that the chance is small, as quantities of a pure supply are brought from the fields for the young's supply.

As a proof of infection it may be stated that the use of a foul comb three years since has been the cause of that hive being unsound up to the present time to a slight degree. The method used to eradicate the disease this summer has been to set apart one of the three hives as an hospital, and at every examination of them to remove such combs as were affected in the other two into the hospital, at the same time cutting out such portions of covered cells as showed the unmistakable sunken lid and small hole in centre, at the same time clearing out single

cells of matter in a comb with a plug of cotton and filling such cells with powdered loaf-sugar, as also a thick sprinkling on all adjacent parts where pieces were cut out; and as a necessary aid to the cure allowing the inmates to raise new queens, by which time all the young have been out, and the still-occupied cells been cleaned, or cut out, and treated with sugar. So far a very satisfactory result has been obtained, and many of the smitten combs not having shown signs of disease since; but a good conclusion cannot be arrived at before the coming spring.

It would be interesting if some of our observant bee-keepers would give us their experience on the subject of foul brood, as relating to the parent stock and swarms from the same; also their opinion of foul brood by generation.

While speaking of swarms many complain that after they have set a hive over them, and the bees have gone up, they have left the hive again. An almost sure remedy for this is not to wait until all the bees have gone up, but as soon as a considerable portion (for the queen generally early avails herself of the offered refuge) remove the hive and set it on a bottom-board, with pins to keep it about half-an-inch up, and the whole on a chair or other stand close under or near to where the swarm settled; in a few minutes shake or disturb the original cluster, when it will be found that they soon play follow-the-leader into the hive. The probability is, that bees clustering in a bottomless hive feel no more security against their enemies and cold, than a newly-married couple would feel comfortable from intruders and the weather if placed in a backyard open to the heavens.  
—J. S. WOOD, *Nyborg, Denmark.*

#### THE AUGUST NUMBER.—FOUL BROOD.

The August number is to hand, and is pregnant with matter for thought to the practical bee-keeper. Now don't think me pedantic, but I wish to make a few plain remarks upon it.

To our Editor, I would suggest that he be careful how he advises emptying with the Hruschka, before the honey is well sealed over. I do not say every cell must be entirely sealed, as there are always a few round the edges which the bees seem very reluctant to seal: but by far the greater part should be sealed. I know it seems a waste of time to the inexperienced to have to wait a few days, or a week, right in the honey harvest; but a little experience with sour, watery honey, will teach him patience another year. The first year (1870) I used the Hruschka, being a good year; and having but few stocks, like all other boys with a new toy, I was never content except when playing with it. The stocks so treated gave me an average of 72 lbs. per stock, of what I vainly supposed to be honey, but which proved to have 25 per cent too much water. Such honey will not keep; so bee-keepers should have a care, lest by doubling the quantity raised they glut the market with an article which will give all extracted honey (though pure and bright as crystal) a bad name. Do not think I disparage the use of the Extractor; for, in my humble opinion, next in importance to Langstroth's frames, is Hruschka's Mellipult. I would advise Mr. P. to purchase or borrow one,

and give it a fair trial. I am sure all his apparent doubts would vanish at once—no farina; no smashed, putrefying larvæ, would then taint his honey. I dare say, as a bee-keeper of great experience, he knows how to drain his honey, so as to have some pure samples; but by using the Extractor all our take is pure and bright. Mine has done service five summers, and gives perfect satisfaction; but having no gearing, simply a line round the shaft (in the manner of a boy's humming-top), the centrifugal motion is kept up with considerable labour. The framework has moveable wire-cloth sides, against which the combs rest: this I find very convenient, as in case of their becoming clogged with particles of wax, or (as will sometimes happen in emptying brood-combs) unsealed larvæ, the sides can be whipped out and cleansed in a moment, causing no delay. There are several essential features, which I need not mention, as doubtless we shall have the *ne plus ultra* at the Crystal Palace. I hope also to see there some convex uncapping knives.

That Octagon hive question has been pretty freely discussed; and I think may as well now be allowed to drop, to make room for weightier matters.

Next year, I hope our friend, J. W., will be able to manipulate without his bee-shirt. Bee-keepers may soon learn how to handle bees, so as not to irritate them; when they have done that, they can give their bee-dress to a more timid brother.

By far the most important article in the August number is that by Mr. John Armstrong, on 'Foul Brood.' He makes very light of this which has caused the ruin of scores of bee-keepers, in the destruction of their apiaries. Its dreadful ravages, its contagion, its incurability, push it to the front, and make it the most important question in apiculture. Of all troubles and dangers which beset the path of the bee-keeper, not one is worth the name compared with this. What are unfavourable seasons, frost, dampness, and wind; mice, millers, and dysentery; all combined cannot make one foul brood. I could give such a doleful account of its ravages in my apiary during this last six years, as to fetch a deep sigh from the heart of even our Stirlingshire brother.—WALTER HEWSON, *Wickham, Sandwich, Kent, Aug. 21st.*

#### THE EXTRACTOR.

To your courtesy I am indebted for the opportunity of witnessing the interesting operation of 'honey-slinging.' The facility and expedition with which honey can be obtained from the comb by the use of the 'Extractor,' and with—what is most important—an entire absence of injury to the comb itself, is very satisfactory; and, probably, soon an apiary will be considered wanting if it does not reckon an 'Extractor' amongst its implements.

This machine must be likely to aid in extending the modern system of bee-keeping; and from the fact that it renders such valuable assistance in emptying combs made in bar-frame hives, powerful and additional testimony in favour of the use of these hives, instead of the straw skeps still so tenaciously and unwisely cherished by many prejudiced and old-fashioned bee-keepers, will be afforded.

*Lincoln's Inn.*

R. W. P.

## THE EXTRACTOR.

For years past, like a cricket before fire-grates were made, have I experienced the want of some device to extract honey; and when I saw the account of the Honey-slinger in the *Journal*, and its representation therein, I felt sure the supply of my want was at hand. I used to operate in a large, white washhand-basin; and with bare arms and hands mash up together the beautiful white combs, and then drain the whole through muslin; the residuum being a ball of wax, as big as a cricket-ball, comparatively valueless. Besides that, a good deal of bee-bread *would* get mixed up with the honey, although I had taken every precaution to avoid this. This year, however, Mr. Starling having allowed me the *trial* of a Honey-slinger—(for, after Mr. Pettigrew's 'hesitation' on the subject, I preferred to 'try before you buy')—*nous avons changé tout cela*—I cut out the combs from all my supers, together with several frames that could be spared from stock hives; and in my study, and assisted by three daughters, commenced operations in accordance with the direction given in the last number of *Journal*. The combs were delightfully shaved by their delicate hands; we had relays of hot knives; and presently the rapid gyration commenced. The honey was slung out in no time, and not one comb was even injured by the operation. These were all then committed to those clean 'kitchen-maids'—the bees, who very soon set all square, restoring every comb as dry as a bone. I purpose bringing a lot of them to the Show, for they are, independently of the 'Extractor,' really most beautiful objects in themselves. I also intend bringing a sample of very simple glass super, which I have been using this year, yielding an average of 11 lbs. I have also been very successful with discarded lamp-glasses (used for gas-lights) placing the larger opening on the adapting board, and using them mostly on the top of other supers. I sold the

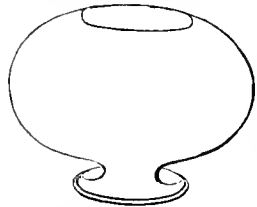

contents (about 3 lbs. 12 ozs.) on the average for 5s. each. My purchasing friends were very pleased with them, putting them on their breakfast-tables, cutting out the honey as required, and returning the glasses to me when emptied. Three complete *fat* combs were generally built in them.

There are only two things I seem to desiderate in the Honey-slinger, viz.: 1st, that it does not slope at bottom towards the exit-pipe; and, 2nd, from the account given, I expected to find a *strainer*, and a *stop-cock* of some kind. Neither can I fancy combs so *long* as are provided for, while such provision obviously increases the bulk of the machine enormously. I have one box twelve inches in *depth*; of course, it would not accommodate the frames therein, so I had to cut them out and divide them. I had last year five boxes made according to your original directions, with thirteen frames in each box, but of less length than you ultimately resolved on, and they have answered admirably. In no case have the bees fastened their combs to the bottom board, whilst the top and sides of frames give abundant support. I have,

however, made *one* improvement, viz., discarded the 'bevil' \* on the underside of top bar, preferring them



flat and sawn through, so as to admit (after Mr. Cowan's plan) a bit of impressed wax-sheet, which *does*, as he says, ensure combs in *centre*. I have two Woodburys, which do very well, but still encumbered, as I found, with every one of the annoyances and inconveniences you pointed out; and invariably leaving half an inch between the bottom of comb and lower bar of frame.

My eldest daughter, smitten with my success, has bought a swarm this spring, May 2nd. She has paid herself already the purchase money, and pocketed 14s. besides; and the bees are as strong as even in original hive. She purposes transposition to a bar-frame box—J. F. HOBSON, *Vicarage, Horsham, August 12th.*

## THE SEASON, 1874.

I have finished taking my honey, and the result pleases me pretty well; from four stocks, not in first-class order in spring, I calculate I shall extract about from 150 to 180 lbs. net honey. I have split them all in half, and my stock for the next year will, I hope, be ten, which makes my house fall. A friend of mine whose bees I look over a good deal, has had two beautiful bell-glasses of honey from one stock about 10 lbs. a-piece, and from another stock over 60 lbs. of honey, all *bonâ fide* collected in 1874; the third stock did no good. I believe the cause is that she overfed them to such a degree that the queen has not had any opportunity to lay eggs. I opened it the other day and found that the combs were nearly all sealed up with honey in great measure collected from the sycamore-trees; and as the weather was such that my bees got no honey from that source this spring, I naturally concluded that her stock had no supply this season also; nevertheless, I took away quantities of honey, and now they promise well with lots of young brood.—R. G. B., *Wrexham.*

My experience in this neighbourhood has been very different from what you describe in the *Journal* (Vol. ii. p. 53). The spring was very early, indeed March and April were lovely months, and bees increased and stored honey rapidly. Drones made their appearance in my apiary on April 12th, and an artificial swarm driven on April 29th, has done very well. May was cold and unpropitious, but by the beginning of June most of my stocks, which had been somewhat thrown back while being Ligurianized, were strong and had well-filled hives; but all through the latter part of June and the whole of July, they only clustered outside the hives, refusing to take to the supers, and apparently waiting for the honey season, which however never came. The drought which began in April, continued till the end of July, everything was parched and burnt up, the old pas-

\* Although I waxed them, the bees would always begin (provoking creatures!) on the sloping side of the bevil.

tures with which this neighbourhood abounds contained no flowers, and although at times the weather was hot enough to raise fears in my mind of melted combs, there seemed no honey to be gathered. Now, moreover, that rain has come, cold has also come, and instead of any surplus honey we shall be lucky if we have not to feed extensively.—H. JENNER-FUST, Jun., *Morton Grange, Thorbury, Gloucestershire, Aug. 10.*

I began the winter with thirteen stocks of bees, most of them wood boxes, and found one dead in the early spring; and several of them, very weak, began to feed on the 1st of March with small quantities of sugar syrup, and continued until the first week in May, when the weather seeming fine, and bees busy, I discontinued feeding, but was sorry to find after two or three weeks my bees were no forwarder than when I gave up feeding; the consequence has been, I have not had one swarm, and only one glass of honey, about 5½ lbs., and others partly filled with from 2 to 4 lbs. I have one consolation, my hives seem to be well stocked with bees and honey for passing the coming winter.—A LINCOLNSHIRE APICARIAN, *August 6th, 1874.*

With the season and its prospects respecting honey, I am far better satisfied than for many years past, considering that my stocks have done well, thanks to the care I took of them in spring. I commenced the year with five stocks: and in order to be intelligible I will number them.

Nos. 1 and 2 in Carr hives, swarmed naturally on the 26th of June, and having a very large bar-frame to hive on Mr. Pettitt's plan, full of comb nice and new, I hived the two swarms together, and they have done well, as I can see through a small circular window at the back, that all the combs in sight are sealed over, and about ten days ago I placed a Carr-Stewarton box over the united swarms, and they are now constructing comb therein, though I don't expect they will do much more, as the white clover in this locality (there being no heather) is nearly over.

This stock I mean to plunder, and I wish I had an extractor that I might thereby save the combs for another year.

No. 3, a Carr's hive, swarmed July the 5th, hived into a Payne's straw hive full of comb, and are now filling a 12 or 15 lbs. super.

No. 4, a Carr's hive, I prevented swarming, as it early showed symptoms of having a prolific queen, so I concluded to gratify her by placing a super on the 21st of June, another Carr's hive of exactly the same size as the stock, containing about one quarter full of comb of last year, which was taken to at once and soon filled with sealed-up comb; in fact, I may say it was nearly complete on the 10th inst., when, fearing they would swarm, I placed one of the Carr-Stewarton boxes on, in which, if I may judge from the heat of the glass, they are working. Were I a little nearer London I should like to enter this super for exhibition at our forthcoming competition.

July 6.—Nos. 1 and 2, each threw a cast, and as I wished to oblige a young friend who was wishful

to commence bee-keeping, I joined the two and put them into a Payne's straw hive, and they are doing well.

Same day.—No. 5, a Payne's hive threw a swarm which was hived into a Carr hive full of comb, which is fast increasing in weight. This was placed on the stool of the stock until evening, which has prevented it throwing a cast. Such are my results so far—the harvest has yet to come.

I may here say that the  $\frac{3}{16}$ ths of an inch slits in the adapters do not seem to have entirely kept drones out of the super of No. 4, having seen a few, but only a few in it. I trust her majesty has not got through.

I am much in love with the Carr-Stewarton boxes, and so is a friend of mine, who says he will adopt them as soon as circumstances will allow; he has nearly 20 stocks at present, but in almost as many different domiciles.

The reversible adapter with the four slides I think a great improvement.

Myself and friend purpose being at the Exhibition, and shall be happy to make your personal acquaintance. Meantime I fear I have spun a yarn too long for your patience.—CHRISTOPHER WADE, *The Park, Kirkby, Liverpool.*

#### THE HONEY HARVEST.

Having seen some letters in the *Times* by Mr. Thornton and 'A Bee-master' in allusion to this year's good honey harvest, and as Mr. Thornton seems to think so much of a bell-glass of 29 lbs. and 'A Bee-master' of an Ayrshire super of 20 lbs. (which, by the way, he describes as hexagonal instead of octagonal), I am induced to send you a report of the honey harvest here, which has been very good. Had I only got 29 or 20 lbs. from one hive, as the largest produce, I should have thought it indeed a very bad season; and I do not consider a hive of bees at all up to the mark unless it can produce, in a season like this at least, a super of 30 lbs. of honey. The average of 12 hives, that I have supered this year, is 59 lbs.; the largest amount from one hive being 120 lbs. and the smallest 34 lbs. of pure honey. The quality of the honey varies very much, some being very white, while some, in the same supers, is quite dark, owing to the quantity of honey-dew about here in July.

The following are the weights of the supers taken from the 12 hives:—

1. 10-frame Woodbury . . . . .	76 lbs. in 1 box
2. Stewarton . . . . .	62 " in 3 boxes
3. Circular wooden hive . . . . .	60 " in 3 "
4. Neighbour's single-box hive . . . . .	52 " in 3 "
5. 10-frame Woodbury . . . . .	120 " in 3 " and 5 glasses
6. " " . . . . .	36 " in glass
7. " " . . . . .	45 " in 1 box
8. " " . . . . .	83 " in 2 boxes
9. 13-frame hive . . . . .	55 " in 1 box
10. 10 " Woodbury . . . . .	44 " in 1 "
11. 13 " hive . . . . .	40 " in glasses
12. 10 " Woodbury . . . . .	34 " in glass

Total . . . 707 lbs.

or an average of 59 lbs. per hive.

I have, besides, extracted the honey from many of the side frames in stock hives.

The above results are obtained by inducing the queens to breed very early in the season; so that by May, when the honey-gathering commences, the hives are very strong and are able to send out a large staff of workers. As my system of working the Woodbury hives varies slightly from that usually pursued, if you think it will be interesting to your readers I shall be pleased to give a description of it in a future number.—THOS. WM. COWAN, *Horsham, Aug. 22.*

[We reprint the letters from the *Times* referred to in the preceding communication.]

It may possibly interest your agrarian readers to hear that the honey harvest in this locality has proved good.

Starting in the spring with 15 hives, I have, without in any way interfering with their inmates, appropriated 400 lbs. weight of superb virgin honey. One 'Bell glass' alone weighed 20 lbs. net.—H. WELCH-THORNTON, *Beauvepaire Park, Basingstoke, Hants, Aug. 17.*

I think the honey harvest will be above the average this year, notwithstanding several weeks of ungenial weather. The blossoms on fruit trees have been frost-bitten in this district to a very great extent, and therefore during the spring the apiarian workmen made little progress in accumulating stock. But the heath and the tiny flowers that spring up in succession in the midst of the heather have attained unprecedented luxuriance, and have been musical with the song of bees from sunrise to sunset. I have been greatly pleased with a flower I imported from Sutherlandshire, called lythrum—so called in the Highlands. It has spread rapidly along the piece of ground behind my hives, and it has for six weeks been covered with bees, and contributed greatly to my stocks. It is a beautiful flower, and is worth cultivating in the south as a honey-yielding plant. I find the Ayrshire hexagon box most popular with my bees this season, and last week I removed a super from one of them which weighed upwards of 20 lbs. weight, and contained richer honey than any of my hives this season.

In some districts there is deficiency, and to make sure of success in 1875 I would advise feeding where there is any suspicion of weakness or deficiency; and for this I do not know any artificial food so popular with the bees, and so easy and quietly applicable, as the bee-barley sugar to be had in Kilmer's confectioner's shop, in Hanway Yard, Oxford Street. I have much practical experience of its value. The flat sticks may be quietly introduced into the hive, whatever its construction may be, and with so little disturbance of the inmates. I think my recommendation to poor curates to add to their income by keeping bees, several years ago, has not been in vain. Their employment of spare hours in this will add to their income, and create an interest far superior to that which arises from tapers, triangles, and chasubles. Bees are eminently Protestant, and prefer fresh air to incense, which they hate, and results to robes and gaudy dresses, with which they have no sympathy at all. The queen bee is a model archbishop—never meddling with her ministers when in the right, and always correcting them when in the wrong.—A BEE-MASTER, *Tunbridge Wells, Aug. 18.*

## VARIOUS ITEMS.

I left the Honey harvest in full swing on the Staffordshire Common where my bees pasture, and came into Essex to find it quite over. I immediately went to see a bee-keeping friend, who has a large number of hives, and works them successfully, if not very scientifically, as you would call science. He did not consider this a good honey year, June having been so adverse, and June being a great month in this place, where many flowers are grown for the London seed-market. However, I saw four large nadirs belonging to him yesterday, at a farm where they had been left for about three months, and each of these must have some 30 lbs. net of honey, so I think he will do pretty well after all. He told me a curious thing about a super which he took off last week. Three swarms had got into one hive, below which there was an open nadir. Next morning one of the queens was found dead in the nadir. The bees did not work in this, but preferred a super which had also been offered them; and this super they filled with honey. When, however, it was taken off, they were two days before they would leave it, and then the master found a fine queen and two or three bees still left in it. The comb (which I saw) was all beautifully white; there was not a trace of brood. My friend's conjecture is that one of the queens had, while quite young, got up into the super (which was barred by  $\frac{3}{16}$ th slits from the live), and remained there unwedded and unmolested by the other queen, who performed her regal and maternal functions in the hive below. Do you think this possible, or in what way do you account for the presence of a queen in a well-filled super of pure virgin honeycomb? Of course the stock hive was a straw skep, or he might have examined it to see if there were a second queen. The one found in the super was put back into the hive yesterday, with what result I do not yet know.—SIC VOS NON VOBIS, *Aug. 23rd, 1874.*

[It is just possible that the queen found in the super was frightened by another queen into passing the slits, and that terror deprived her of the power of oviposition. It is usually supposed that queens are quite eager to attack each other, but we have seen young queens in supers rushing about in the wildest possible way, evidently under the influence of fear from the presence of a rival. Speculation in the present case would, however, be idle, since there are no means of authenticating any surmise which might be made.—ED.]

## BEE CULTURE.

On reading my communication in last month's Number of 'our Journal,' it seems that one or two matters therein need a little explanation. With regard to the number of bars to be used I should have added that six bars are sufficient for a super of 14 inches square, five bars for a super of 12 inches square, and so on. It is advisable to encourage bees to build deeper cells for deprivation, besides which the liability of brood in the comb is lessened. My experience with the  $\frac{3}{16}$ th inch slits has not been very encouraging. I find that from  $1\frac{1}{2}$  inch holes on the top of the stock are much to be preferred,

besides being handy to cover with inverted glass tumblers during the winter to draw the moisture from the hive, which, as all bee-keepers know, is really indispensable at that season to preserve the bees in health.

I began bee-keeping about twelve years ago, commencing with a set of Nutt's boxes, each measuring 14 inches by 12 inches, in a bee-house—an eight-guinea affair—and for several successive years all my inducements in the shape of tempting pieces of honeycomb in the side-boxes were of no avail; the bees seemed determined not to leave the parent stock in any number except to swarm. I then made a separate stock of each and began supering, which has answered remarkably well, so much so that the average yield from each for the last five years is upwards of 35 lbs. of honeycomb. Moreover, they have never swarmed. This season the yield is much greater. I have removed four supers from two of the boxes weighing 35, 38, 34½, and 26 lbs. respectively. The third one perished during the winter of 1872 from neglect in feeding, and it is now tenanted by a small second swarm. To the best of my recollection, this is the first stock I have had the misfortune to lose since I began. Another stock-box, apart from the rest—eight years of age—in eighteen days stored 35 lbs. of honey in the super; and I have since removed two large bell-glasses from it, the last on August 8th, weighing 6 lbs., the two combs, semicircular in shape, measuring 4½ inches thick at the widest part.

As far as appearances go the honey season is now past. In this district not one hive out of fifty has swarmed, while at least one out of five perished last winter. Possibly my success in apiculture may be partly attributed to the care I take in keeping the wet out of the boxes; they are so made that not a drop of rain ever enters or soaks through at the junction of the hive with the floor-board. The bee-house is well painted twice every year, in March and October; in the latter case to render it thoroughly waterproof for the ensuing winter, and internally every alternate year; turps, of course, is but sparingly used in the paint. This has a tendency to keep it free from insects, especially the dreaded wax-moth, which I am happy to say I have never seen in my apiary.

To the statement by a 'Lanarkshire Bee-keeper,' that 'bees are more forward in spring when kept in houses than when kept outside,' I can give a ready acquiescence. As a rule the supers in the house are half-filled before there is any sign of commencement in the other outside.

Unfortunately I disposed of my three earliest supers before I had any knowledge of the forthcoming Exhibition, or of the Association. Still I have one on hand that will answer the purpose very well.

As the inventor and maker of a hive of entirely new design, on the storifying system, I shall attend the Palace during the Exhibition, to explain its merits. Besides other qualifications (success ranking first and foremost) it is very easy of management, and by a simple process the honey-box is freed from bees without removal.—ALFRED RUSBRIDGE, *Siddlesham, Chichester, August, 1874.*

## LIGURIANIZING.

In my last letter to you on the above subject, owing to a mistake in the punctuation, my meaning is not correctly conveyed. The passage should read thus, 'In my apiary I use the Stewarton and Woodbury hives, with some improvements.' Then 'I have succeeded,' &c. I have also, since then, examined all the frames without the bottom bar; but in no case have I found them fixed to the floor-board, and have, upon examining the comb, with which I had a mishap, come to the conclusion that, owing to the intense heat at the time, it must have dropped from the frame, and had not been securely fixed to it when it was removed.

I have tried introducing Ligurian queens with Mr. Carr's cages, as described by him in the *Journal*, and, with the exception of two failures, have been successful, and think they are very useful, and are certainly safer and give much less trouble than the ordinary cages.—THOS. WM. COWAN, *Horsham, Aug. 21.*

## UTILISING SECOND SWARMS.

Some apiarians are prone to look upon second swarms somewhat in the light of nuisances, and exert all their ingenuity to prevent their exit, by cutting out royal cells, and setting the prime swarm on the site of the parent stock, while the latter is moved to a new position in the apiary.

This line of action is never adopted by the cottage bee-keepers of our district. Second swarms are invariably hived singly, and are chiefly depended upon, from their possessing young queens, as the favourites for standing over as stock hives, while the prime ones are, with the heavier old stocks, sold, or their contents run for the market, which form the profit of the season; while, I am happy to add, the brimstone pit has become obsolete, the driven bees minus their queens, being added to adjoining stocks.

In my own apiary, consisting chiefly of strong, non-swarming, or doubled prime swarm octagon colonies, I am not troubled with many second swarms, saving from the few hives reserved to swarm, and which form feeders to people fresh colonies projected to be established, while the queens of such second or third swarms, if the progeny of a pure-bred Italian mother, are set over these new colonies, or supply the place of superannuated queens of older stocks.

On Sunday, 12th July, two second swarms emerged simultaneously; and very sensibly amalgamated while on the wing, settling and being hived together; the one having proceeded from a black, the other from a hybrid stock. Their queens were rated at comparatively little value. As none of my colonies were in want of these bees, the question arose, what was to be done with them? How could I utilise them, so as to most expeditiously glean the white clover honey then abounding? and I fell on the following expedient:—

On the following day, Monday, I swept the imported Italian queen and her offspring from a 7-inch octagon frame hive, which had been employed all the season in raising swarms for nuclei, into a similar



empty hive, the vacated box was at the moment fully combed and richly stored with sealed brood and eggs, into which the conjoined seconds were put after their surviving queen had been destroyed, and free access from two drawn slides on either side, to a couple of octagon full-sized supers at once given; as I know full well that ere they could raise a young queen, and she fertilised and begin egg-laying, the harvest would be over. Comb-building went on rapidly in both, and as the young Italian hatched, the crowded state of the hive called for a third, and subsequently a fourth super was set over the first two. By the time the queen began laying a second breeding-box was given below: the combined seconds now form a most promising colony for next season, having a valuable first-cross hybrid queen at their head, and have yielded so far a frame, with four royal cells for other colonies, just the lowest, and then the next, 20 lb octagon super, together 40 lbs. of the finest honey-comb, thoroughly sealed out: and are at present (22nd Aug.) busily combing out their lower box, besides storing honey from the bind-weed and more distant heath in the two remaining supers.—A RENFREWSHIRE BEE-KEEPER.

#### QUEEN INSERTION.—FEEDING.

From the description given in the *Journal* for giving hives an Italian queen, I thought I should like to try my hand at that work. Consequently, having an Italian queen, I obtained one of Carr's Bee Cages, and having opened the hive (one of your new bar frame), I seized hold of the English queen, then placed the Italian queen in the cage with seven bees. I inserted the cage between the combs, and allowed it to remain quiet for thirty hours. I then let her out quietly, but on looking into the hive about a quarter of an hour afterwards, I found her completely surrounded and covered with bees, and was afraid they meant mischief, therefore I immediately pulled them off her, and put her into the cage again for half a day. I then let her out to take her chance, and half an hour afterwards I drew out the bottom, or alighting board, and found her with the bees around her on the board. I concluded all was right, and left her. Looking in a few days afterwards I found she was all right. I now find, on looking into the hive, a great many beautiful Italian bees. It is just a month to-day since she was liberated, and the Italians have not yet done any outside work.

Some of your correspondents must have good pastures.

I think a good feeding-bottle is wanted. What do you think of this? Have a piece of wood screwed on to bottle-neck, upon which fasten a piece of perforated zinc; then have another piece of zinc to slide on the top of that, so that by sliding for the sixteenth of an inch, the perforations come exactly over each other; and when drawn back again the perforations in the first piece of zinc are covered.

I don't know whether or not I have explained myself sufficiently. I would sign myself 'Novice,' but the Novice is such a clever fellow, I should be thought aspiring.—G. B., *Middlesborough, Aug. 7th.*

## Queries and Replies.

QUERY No. 105.—What am I to do to prevent my bees carrying out their economical instincts to such a state as to fill up with comb the spaces between the frames of hive? I have some of Lee's, with moveable-distance pegs. I opened one last night, and as the spaces were filled with comb, it was impossible to move the frames *laterally*: so having run a knife down the side of the selected frame, I endeavoured to lift the frame, and the comb got broken off. A reply in the next *Bee Journal* would greatly oblige.—A. C., *Market Drayton.*

REPLY TO No. 105.—On pages 52, 99, and 115 of Vol. I. we gave expression to our views on the desirableness of providing means by which the combs in a bar-frame hive should be rendered capable of lateral movement, so as to facilitate their removal without the necessity for crushing them or crowding them together, as, in the generality of existing hives, is now the case; hence our adoption of the movable-side dummy, as a positively necessary principle in all bar-frame hives of the future. Bees seldom build more than small pillar-like attachments between combs, as if for the purpose of steadying them; but they often build their comb in a serpentine form, and sometimes on the very edges of the top bars, instead of well under the centre of them, thus bringing one side of the top of the comb into full view between the frames, and this we strongly suspect has been the case in the present difficulty. In the serpentine form of comb, so often built when guides have not been used, or when the hive has not been correctly placed, one comb may embrace three or four frames; and any attempt to get it out of a hive, when lateral movement is impossible, will probably cause the crushing and fall of the whole mass of honey or brood therein contained.

The remedy consists in removing the whole of the frames of comb and fixing them correctly before returning them to the hive.

The best preventive is to have the frames properly provided with wax-guides before the swarm is placed in the hive, and to set it in a position tilting forwards, but perfectly level across the front. Much of the mischief is created by allowing hives to remain too long on the ground when the swarms are first put into them; and when they are thus often carelessly placed, and the bees having arranged themselves to build from the highest corner downwards, and probably laid their foundations before being placed on their proper stand, continue their operations, which will be most certainly irregular. This idea may solve a great many of the enigmas, why bees often build crooked or uneven combs.

Guide combs almost infallibly ensure straight combs, if the hive be placed in a reasonably correct position; they are fastened on to the frames, by waxing their undersides, and placing a hot iron thereon, so as to melt the wax and heat the frame-bar: the guides, formed of horizontal strips of comb about an eighth of an inch in thickness, are then laid on the hot waxy bar, and pressed down until united thereto.

Transferring and straightening crooked combs are treated of on pages 79, 95, 199, &c., of Vol. I. of *Journal*.—Ed.

QUERY No. 106.—1. Is it any good to add to a stock of bees the bees only from another hive when they are taken in the autumn? (I could get bees from cottagers when they take their stocks in autumn.) 2. Would not white crystallized sugar, such as can now be bought at 4*l.* per pound, be as good as loaf-sugar to make syrup for bees to winter upon? 2. Is chloroform or tobacco-smoke really injurious to bees, when used in operating upon them; does it shorten their existence? 4. In one of my hives the bees have built three drone-combs, do you advise me to replace them with worker-combs?—H. F., *Broad Oak, Breda, August 12.*

REPLY TO No. 106.—Undoubtedly it is beneficial to strengthen a stock of bees in autumn. Many hands make light work; consequently, individuals have not the same labour to perform, nor, as a whole, is the same exertion necessary to keep up the heat of the hive; and, therefore, the production of young bees is more likely to be proceeded with. The addition of a few old bees from a dwindling stock will not be likely to effect much good, since they will so speedily die out; but when taken from full and flourishing colonies, there will usually be a good number of young bees, which are really the mainstay of the bee-keeper, as in all probability they will live throughout the winter. The question, young *versus* old bees, is of the highest importance in bee-keeping; its neglect having, doubtless, been the cause of much ill success in wintering.

The best loaf-sugar makes the best and cheapest syrup, since, when purchased, it contains comparatively no water. Crystallized sugar, on the contrary, contains a large proportion of water, called, in fact, 'the water of crystallization;' hence it will be found that much more of it will be required to form a thick syrup than if the 'baked' loaf-sugar were used. For use as bee-food, syrup, made from either or both, would do equally well.

We have a special aversion to chloroform as a fumigating agent, and never now use or recommend it; its volatile nature rendering it uncertain in its action. Whatever may be said by other writers to the contrary, we believe that the vapour of chloroform and the fumes of puff-ball are both injurious, and shorten the life of the bees; but of the two, we think the latter the less dangerous, and capable of greater control. Tobacco-smoke, if administered in large doses, has a prejudicial effect on both bees and brood; indeed, we have a grave notion that it has some influence in causing foul brood. It is a remarkable fact that where it is *not* used the disease seldom makes its appearance.

The presence of a small quantity of drone-comb in a hive undoubtedly adds to its security; but all excess may be removed, and if practicable replaced with brood and pollen-comb obtained from the same source whence it is proposed to obtain the 'condemned' bees for uniting with weak stocks, implied in the first query.—Ed.

QUERY, No. 107.—(1) My bees lately have carried in an immense quantity of pollen; if they can store so much, does it not show a deficiency in honey? (2) From ten-framed Woodbury hives can bees in an ordinary year spare any frames of honey? (3) I have three times tried to find a black queen, and failed. Can I Ligurianize by turning all the black bees out of their hives and the Ligurians into it?—W., *Leominster, Aug. 26.*

REPLY TO No. 107.—The carrying of pollen does not indicate a deficiency of honey, it is the result of a plentiful supply which the bees cannot resist, pollen being as useful and necessary to them as honey. When pollen is stored freely, breeding is generally going on briskly, which is good at this season, young bees being absolutely necessary for the welfare of stocks in winter.

A ten-framed Woodbury can well spare one frame from each side of the hive. After removing the fragments of comb, &c., on the crown board, clear all off the tops of frames, and wrap carpeting over and even round the sides of the remaining frames; cover with several layers of felting, or any porous material, and put on the roof, not the crown-board; and the bees, as a rule, will winter well, if there are sufficient young bees.

There is no better way of Ligurianizing stocks than that you propose: it is a system which is without any risk if carefully managed, and one we have tried hard to persuade amateur bee-keepers to adopt, but many will insist on trying experiments, to their cost. See 'Ligurianizing by Small Swarms,' in Vol. I., pp. 15, 16, 72.—Ed., *Aug. 26.*

QUERY No. 108.—I am obliged to you for the letter you wrote me respecting the wax-smelter, and now am again troubling you for advice about some empty combs I have.

Last autumn the bees died in one of my Woodbury hives, which I cleaned out and pasted up to take care of, intending to put a swarm to them this spring, but upon opening them I find moths had attacked them, which I killed, and more have since appeared (this is some months back). Now the question is, May I venture to use them? They are good combs, and *very straight*, which makes me loth to destroy them. Would it do any good to pour hot water over them, or expose them to the fumes of chloroform?—C. H. G., *Eastgate Street, Stafford.*

REPLY TO No. 108.—To clean old combs of vermin we find the best thing is the fumes of puff-ball. If there are any wax-worms they will soon turn out, or fall into the receptacle beneath.

You will of course be able to see whether there are any of the sinuous, webby tracks or tunnels of the worms. If there are, they should be ferreted out, as bees are very much irritated by their presence, even though there be no worms.

There need be no apprehension as to the bees repairing the combs, they will surely do it the more easily for the webs being out of it. Hot water would destroy them.—Ed.

#### NOTICES TO CORRESPONDENTS & INQUIRERS.

E. W. K.—Queens cannot be expected to travel safely by post, as they are liable to be suffocated in the waterproof bags. We usually send them by railway, and, properly labelled, there is seldom any difficulty.

STAFFORDSHIRE.—We cannot possibly give a full description of Langstroth's hive and system in any one *Journal*. The system we have been all along inculcating is essentially Langstroth's system, and all bar-frame hives are modifications of the hive he invented. The main difference between the Langstroth hive and the Woodbury is in size, the principle is otherwise the same.

NOTE.—We regret that want of space compels us to defer the publication of many important communications.

THE

# British Bee Journal,

AND BEE-KEEPER'S ADVISER.

[No. 18. VOL. II.]

OCTOBER, 1874.

[PUBLISHED MONTHLY.]

## Editorial, Notices, &c.

### THE GREAT BEE AND HONEY SHOW AT THE CRYSTAL PALACE.

This wonderful exhibition, which has formed the chief topic for discussion in the *British Bee Journal* during several past months, was duly held on Tuesday, Wednesday, and Thursday, the 8th, 9th, and 10th of September last, and in its result was most eminently successful. No such exhibition has ever before been attempted in the United Kingdom, and its promoters have every reason to congratulate themselves on the apiarian wisdom which induced them to project so extraordinary an undertaking. The idea, first sown in the columns of this *Journal*, quickly took root, and grew and flourished, until it spread its influence throughout the land, linking together bee-keepers of all classes without distinction, and embracing them in a common brotherhood with avowedly but one object—the *general common weal*.

In the first number of the *Journal* ever published a far-seeing correspondent (H. W. T.), at a late hour, suggested the formation of a Bee Guild for England; and the subject was considered of sufficient importance to warrant its publication in a supplemental form, so that it might be brought before the public at the earliest possible moment: but, although it was fairly and freely discussed in subsequent pages of the *Journal*, it languished from the want of a leader; or rather, perhaps, from the want of an organization requiring such a head; and not until after the Manchester Bee and Honey Show—which created so unpleasant a sensation amongst bee-keepers at large—was any positive endeavour made, or step taken, to bring about a general meeting of apiarians. Exactly a year ago to-day the first suggestion of an open meeting of bee-keepers, to take place at the Crystal Palace, was made, when it was thought that over that *sine qua non* a dinner bee matters might be discussed in a friendly spirit, and great good result. Not much progress was made during the then current month of October, 1873; but in the November *Journal* the idea was enlarged, and it was 'hoped that

an exhibition of hives and bee-gear might be arranged to take place at the same time, in accordance with the spirit of the suggestion of our earnest correspondent, H. W. T., in his proposition for the formation of a Bee Guild' before mentioned. This led to somewhat more tangible results, and to some promises of pecuniary support, provided a meeting of bee-keepers could be organized; the Hon. and Rev. Henry Bligh, of Nettlebed, Oxford, being the first to tender a guinea as a 'nucleus,' which might be (and was) added to, and built up into the equivalent amongst bee-keepers of a *large and powerful stock*, but which, in this particular instance, assumed the form of an equally powerful Prize Fund. Such was the force of example, that in a few days the nucleus had increased sixteenfold, as was duly announced in the *Journal* for January last. Prior to this, however, an application had been made to the Crystal Palace Company, through the courteous Mr. Wilson, their Secretary to the Natural History Department there, for permission to hold the meeting and exhibition; and after a consultation with our esteemed friends and fellow-workers, Messrs. Cheshire and Symington, it was arranged to take place on the occasion of the Autumn Great Fruit and Flower Show, just passed, when the products of *apiculture* were so happily associated with those of its sister sciences—a poetical triplet being thus formed without either of which neither can be considered perfect.

The next step was the production of a (proposed) Schedule of Prizes to be awarded, and here was recognised the necessity for the utmost liberal-mindedness. Every hive of every kind, every system, every description of super, every appliance for use, and every novelty which could aid in the culture of bees, were recognised, and prizes offered for them according to their merit, each in its class, subdivision, or section; and the result was the stirring of the genius of bee-keepers, inventors, adaptors, and *cumulators*, to an almost inconceivable extent. So truly was the cosmopolitan spirit of the Schedule entertained and recognised that, before the end of March the Prize Fund was nearly quadrupled, having reached a sum exceeding sixty pounds; and now it became necessary, seeing that the

rolling ball was assuming such large proportions, to organize a power to guide and govern it. Naturally, the Schedule did not please everybody, and a few unskilful lances were directed against it; but these were easily turned aside, or from having no point, and being harmless, were allowed to fall where they listed: while preparations were making for the establishment of a Bee-keepers' National Association; and in the *Journal* for May a public meeting of the Subscribers to the Prize Fund was called for that purpose, and held at 4 p.m. on the 16th inst. (May), at the Lecture Hall, 168 Camden Street, N.W., where the necessary steps were taken for the formation of what is now known by the proud title of 'The British Bee-keepers' Association.' The report of the proceedings of this meeting will be found in the *Journal* for June last. Suffice it now to say that the chair was taken by the Hon. and Rev. H. Bligh, that a Committee was formed to hold office until the 10th September last, and that the proposed Schedule of Prizes was discussed and revised under the presidency of J. M. Hooker, Esq., of Sevenoaks, the Hon. President, Mr. Bligh, having vacated the chair after four hours of tedious labour. The revised Schedule appeared also in the *Journal* for June last, during which month it occurred to us that if some exhibition of manipulation with live bees could be organized a double interest would be thrown into the movement, and an impulse given to improved bee-culture, which would necessarily be permanent; and to this the Crystal Palace Company also cheerfully lent their aid, setting apart about 100 feet of open balcony for the purpose, and promising ample protection for the public by the erection of glass and canvas screens, as was notified in the *Journal* for July last, when 'bee-masters who write and tell the world how easy it is to manipulate with bees' were invited to 'come forward, and *show how it is done.*'

In the meantime, donations to the Prize Fund were cheerfully subscribed, the amount required being furnished before the Show commenced; the judges, upon whom so much devolved and whose names appeared in the *Journal* for September, expressed their willingness to act; the staff of assistants to aid the Committee were appointed, and on the 8th ultimo the British Bee-keepers' Association's first great Bee and Honey Show, their Exhibition of Hives and Bee Furniture, and of the Manipulation of Live Bees, were, after the ordeal of judging had been gone through, thrown open to the public, and created a sensation such as had never hitherto occurred in the history of apiculture.

The visitor, proceeding from the railway station towards the tropical end of the Palace,

where the Show was held, was first confronted by an elegant bee-palace, Class 37, in competition exhibited by C. W. Smith, Esq., of Totteridge, Herts, as a specimen of the way in which bee-houses may be constructed to combine usefulness with a tasty appearance, at a comparatively moderate cost. It was much admired; but opinions as to its merits as a bee receptacle were varied and opposite.

The classes in competition were forty in number; for the first of which,

Class 1, For the best hive for observation purposes, there were six entries, including those usually exhibited with live bees in them at all similar gatherings; but from some unexplained cause the judges withheld the prize offered.

Class 2. For the best skep or box-hive for depriving purposes, for cottagers' use, that can be supplied for 3s., exclusive of floor-board, brought out seven exhibits; of which a Woodbury hive, with ten frames, intended for use with the quilt and blankets, exhibited by ourselves, without floor-board or crown-board, gained the prize of 2*l.* and certificate; this hive is described in another column.

Class 3. For the best moveable comb hive, for depriving purposes, brought forward twenty-five exhibits, including all the old and several new patterns, some of which were very meritorious; the judges awarded the prize of 2*l.* and certificate to the double-cased improved Woodbury hive exhibited by our esteemed friend and correspondent, F. Cheshire, Esq., of Acton, W. Of this hive, a full description will be given in our next; suffice it now to say, that it is an excellent hive, and contains almost all that is best in others, with some new features of Mr. Cheshire's own. Singularly, however, it was exhibited without the depriving appliances, the supers.

The Sibertswold hive, exhibited by the Rev. F. T. Scott, and valued at the prohibitory price of twenty guineas, was an excellent specimen of Mr. Pettitt's workmanship; and to its inventor, 'Sibert-on-the-Wold,' a *nom de plume* which very thinly shades the clever introducer of the elongated top bar of frames, of which Mr. Pettitt is the not unsuccessful exponent.

Mr. Aston's Ladies' Woodbury is a pretty hive, and attracted much attention; but the judges turned a deaf ear to everything not of palpable utility.

Mr. King's 'Sherrington' is an excellent hive; the straw-work is vastly improved, it is made no longer square, but longer from front to rear than from side to side, which gives larger frames. The frames, instead of fitting into rabbets, which made them difficult to handle, now rest on back and front of hive, as in our hive, being kept in position by pins, which

keep them together, and on removal allows of side movement. A neat, projecting cover protects the straw-work from the weather, and gives to the whole a snug, comfortable appearance.

Mr. Hale, with the Kedington hive, committed the grave error of hinging his crown-board, which, in closing, comes direct upon the frames, whose surfaces would cause the crushing of bees when the crown-board is closed down. This is quite a new feature in his hives, which are otherwise commendable both for their cheapness and appearance.

Neighbour and Sons exhibited their latest bar-frame hive, which is a kind of hybrid between the Langstroth and the Woodbury. It is beautifully made (by Lee); but its metal rack with notches, its space over the frames, its ungainly appearance, and its price, are very much against it.

Mr. S. J. Baldwin, a sergeant of police at the Palace, exhibited a hive which, although unnoticed by the judges, attracted a great deal of attention; in its manufacture it embodied many of the principles enunciated in the *British Bee Journal*, and obtained a cheerful purchaser at three guineas.

Mr. Pettitt exhibited a Major Munn's hive, claimed by our late venerated friend to be the first bar-frame hive invented: it was, doubtless, a wonder in its day, when it was thought *penal* to invade a hive; but, nowadays, precautions to prevent the flight of bees under examination would seem puerile. Mr. Pettitt also exhibited his metal-rack hive, the offspring of the Sibertswold, an excellent hive, but troubled with the notches which prevent immediate lateral movement of the frames, and consequently it passed unnoticed by the judges.

Mr. Lee, of Windlesham, exhibited a couple of excellent hives, of splendid workmanship, and very cheap.

Mr. Symington exhibited four hives, two of which were our own first pets, the Cottage Woodburys, and being well made, double-walled, with dead air space between, double-floored, the floor-board being also reversible, they are, after all, not to be despised, the price complete, with super, being 25s. only.

Our own latest efforts in hive-making, in this class, of which we exhibited two specimens, were also passed by the judges without remark; and holding the position we do we feel bound to accept their decision.

Taken altogether, the class for hives of this description was exceedingly well filled.

Class 4, 'For the best hive for use on the storifying principle,' elicited eleven exhibits; and in this the newly developed Carr Stewarton hive was awarded the palm with 2l. and certificate. It was manufactured and exhibited by

Mr. Lee, of Windlesham, and as a specimen of excellent workmanship could not be surpassed. The Carr Stewarton was designed by C. W. Smith, Esq., of Totteridge, Herts; it partakes of the character of both the Carr and the Stewarton hives, and hence its name; and it has a very chaste and ornamental appearance. Strictly speaking, it was the only storifying hive exhibited, the remainder belonging to the ordinary class of supering hives. No one could complain of this award, but we should have been better pleased had there been a real competition. Where was its grand-parent, the far-famed Stewarton? It was a pity that this hive, which enabled Ayrshire to send such a marvellous display of honey into the Show, should have been otherwise unrepresented.

In this class was exhibited a Cabinet Hive, by A. Rusbridge, Esq., which, says the catalogue, 'will be patented,' not for sale, but made to pattern for 4l. 15s. This hive showed a great deal of inventive genius on the part of the exhibitor; but its merits were entirely overlooked, probably through an apparent want of simplicity in detail. Mr. Rusbridge was, however, indefatigable in his endeavours to explain its working, and from his ability as a writer and bee-keeper, his hive will doubtless become better known.

Prockter's 'King's Patent-safety Hive,' the principle of which consists in drawing out the supers when filled, lacked the moveable-comb arrangement which is now thought so essential in all improved hives, and hence was nowhere. Sadler's Berkshire hive is another of the same class, but is less than half the price of the Prockter; and if fitted with bar-frames, or any other moveable-comb arrangement, it would, for its size, be a difficult hive to beat. It is even now a great favourite with ladies; it is composed largely of glass, with nicely fitted shutters, has two supers with glass and shutter fittings, and is on the whole a cheap and well-made article. Neighbour and Sons' Cottage Hive also competed in this class, but upon what grounds it is not easy to imagine.

Class 5, 'For the best hive for use on the collateral principle,' was represented by five exhibits; but, as in Class No. 1, the prize and certificate were withheld, although on what ground we are totally at a loss to comprehend. However, as we had hives of our own in this class, to prevent misconception, we forbear comparison; nevertheless, we hold that prizes having been offered for the best hives of any kind, the prizes at least, should have been awarded, even supposing the certificates were withheld.

Class 6, 'For the most economical (best and cheapest) complete hive, on the moveable-comb principle, for cottager's use,' brought forward

six competitors, at prices varying from 3s. to 12s. 6d.; the latter a capitally made hive, by Lee of Windlesham. Our own hive, at 6s. 6d. a description of which will be found elsewhere, was held by the judges to answer the required stipulations, and received the award of 2l. and certificate. This hive, which was closely run by that exhibited at the same price by our correspondent and brother committeeman, R. Symington, Esq., of Little Bowden, has created quite a sensation amongst straw-hivists, who see in it, aided by that most terrible *argument*, the Honey-Extractor, the destruction of the idol they have so long worshipped, and the complete uprooting of what Langstroth calls 'old-fogey' bee-keeping.

Class 7, 'For the most beautiful bees of Ligurian breed, *i.e.* a queen accompanied by her progeny; the beauty of the queen to be of secondary importance,' called forth seventeen exhibits, of which the bees belonging to C. W. Smith, Esq., of Totteridge, gained the 2l. award. These bees were exhibited in an elegant Carr-Stewarton hive, with glass sides and top, which was sufficiently an *observation hive*, as regarded the bees; but, as the class was intended to show that the beauty of Ligurian bees does not always depend upon the marking of their queen-mother, who in this instance could not be seen, the object was in some degree defeated. The largest exhibitor in this class was Mr. Symington, whose bees attracted marked notice. Next came our own, of which we will be content with others' opinion, being satisfied with the fact that the queen whose progeny took the prize was one of our own importing.

HONEY.—We now come to the honey classes, and here the exhibition was delightful and astonishing; the only drawback to its greater splendour consisting in the large number of wonderful supers which, from being damaged in transit, were unfit for exhibition, and were, consequently, not shown. The pride of the Show came from Ayrshire, in Octagon Stewarton supers of about 4 inches depth; and truly it was a pleasure to look at them, a treat in itself to see how the art of the master could induce the bees to build their combs so beautifully straight, so symmetrical and even on both sides, and so perfectly finished, that one could have declared they were cast in a mould to pattern; and who could fail to admire the perfection acquired in the art of packing by the Ayrshire gentlemen, who brought their immense harvest over 400 miles of railway almost without breaking a single honey-cell, and certainly without destroying a single comb? whilst scarcely one of the damaged supers above mentioned had one-fourth of the journey to undergo.

Truly, honey-exhibiting is an art; it is not

the collection of it by the bees which makes it so, but the forcing them to store it in such convenient receptacles, where not only may every comb be carefully supported during its journey, but when on view all the combs may be seen, and all doubts set at rest as to the character of the cells of which they are formed. Such an exhibition to an amateur was worth a journey to Ayrshire, if only to learn the art of packing; and, individually, we are greatly obliged to those Ayrshire gentlemen for their kind explanations of the seeming mystery.

The first class in honey, Class 8, was 'For the largest and best harvest from one stock of bees under any system or combination of systems, the same to be declared on exhibition;' for which there were nine competitors: the prizes amounted to 4l. 10s., which was divided between Mr. A. Ferguson, Ayrshire, the Hon. and Rev. H. Bligh, and the Editor of the *British Bee Journal*. Mr. Symington competed in this class with nearly two hundredweight of honey obtained from his single stock by the use of the Extractor; but his exhibit was apparently overlooked—why, we cannot say.

In Class 9, 'For the best exhibition of super honey from one apiary,' there were three prizes offered amongst nine exhibitors, but only one was awarded—viz. to the Rev. Geo. Rayner, 3l. Why, we cannot say.

In Class 10, three prizes were offered 'for the best straw super of honey, net contents above 20 lbs.' For this there were only two exhibits, yet both obtained prizes.

For Class 11, 'for the best straw super of honey, net contents not under 14 lbs. nor above 20 lbs.' there was only one exhibit; and Mrs. Pagden, of Alfreton, took first prize.

Class 12, 'for the best straw super of honey, net contents not under 10 lbs.' nor above 10 lbs. received only three exhibits in competition for three prizes; one only was, however, awarded, which fell to the lot of Mr. T. Bagshaw, of Longnor.

It is most remarkable, considering the much-vaunted virtues of the 'idolized' straw skep, that for the nine prizes above offered only six straw supers could be brought into competition, of which but four were thought worthy of prizes: as Artemus Ward would say, 'This is where the laugh comes in.'

Class 13, 'for the best wood super of honey, (or wood in combination with glass or straw) net contents above 20 lbs.,' seems to belong to another era, and here the competition was remarkable, there being no less than twenty-eight entries, the supers varying in weight from 28 lbs. to 76½ lbs. net. The first prize was awarded to W. H. Clark, Esq., of Morton Abbey, Surrey; the second to Mr. J. Anderson, of Ayrshire; and the third to Alfred Rusbridge, Esq., of Chichester.

Neither of these supers approached the weight, nor, excepting in the second case, the beauty of the magnificent supers exhibited by T. W. Cowan, Esq., of Horsham, whose description of them in the *Times* a short time since quite startled the bee-keeping world, and many were the shrugs and winks implying doubt of their existence, yet here they veritably were, in all their pride and beauty; but the judges disqualified them because they could not taste them!

Class 14 was for a similar super to the foregoing, 'net weight above 14lbs. but under 20lbs.,' and for this there were twenty-three entries. This was the keenest competition of the Show; there were only three prizes, but six of the exhibits were declared of equal merit, thereby reducing the money value of the prizes to so low a pitch as to render them almost unacceptable under the circumstances. In such a case we think it would have been well, and certainly politic, to have added some of the monies withheld in other cases, to the general fund of the class. The six exhibitors on an equality were Messrs. W. Sword, J. Anderson, R. Graham, R. Anderson, D. Anderson, and A. McCrone, all of Ayrshire, who each received the sum of 6s. 8d.

Class 15, 'For the best super of similar kind to the foregoing, net contents not under 10 lbs. nor above 14 lbs.,' brought forth eleven entries, and resulted in the first prize being awarded to Mr. J. Anderson; the second to Mr. R. Anderson; and the third to Mrs. Pagden.

Class 16, 'For the best glass super of honey, net contents above 20 lbs.,' elicited twelve entries, the supers varying in weight from 21 lbs. to 50 lbs.; the latter, the property of George Fox, Esq., of Kingsbridge, taking first prize; the second fell to T. W. Cowan, Esq.; and the third to Mr. S. Thorne, the last-named being a glass of the same pattern as that which took first prize at Manchester last year, but was not equally filled.

The Manchester super, of 84 lbs., was here exhibited by the Rev. William Charles Cotton, and received a great deal of attention; but was not in competition.

In Class 17, 'For the best glass super of honey, net contents not under 14 lbs. nor above 20 lbs. weight,' there were eight exhibits, the winners being Mr. T. Plumridge, first; T. Bagshaw, Esq., second; and Mr. W. Martin, a cottager, third.

In Class 18, 'For the best glass super of honey, net contents not under 10 lbs. nor above 14 lbs.,' there were five entries for three prizes, but only two were awarded, the first going to Mr. S. Thorne; the second to Mr. D. King, of Odiham.

Class 19, 'For the best glass super of honey, net contents not under 6 lbs. nor above 10 lbs.,'

produced nine entries, all of which were very good; the judges giving the prizes to Messrs. Plumridge, Lighton, and Bagshaw, in their order of sequence.

Class 20, 'For the best display of honey in comb for table use,' brought six exhibitors to the fore, but only two prizes were awarded; the first to Mr. J. Anderson, and the second to Mr. D. Anderson, both of Ayrshire.

Class 21, 'For the best exhibition of run honey in glasses, of from 5 lbs. to 10 lbs. each, net contents, the produce of one apiary,' brought out seven exhibitors; the first prize, however, was 'a gift' to the Editor of the *British Bee Journal*, whose Extractor put his exhibit a long way a-head; Mr. J. Anderson came second; and Mr. W. Laughland, third.

In Class 22, 'For the best exhibition of run heather honey, in glasses of from 5 lbs. to 10 lbs. weight each,' there were only two exhibitors, each of whom was awarded a prize; Mr. D. Anderson being first; and Mr. John Armstrong second.

In Class 23, 'For the best exhibition of honey obtained by the use of the Honey Extractor from one colony,' there was no exhibit, our own name was entered as a competitor, and by some curious error a prize was awarded to an exhibit supposed to belong to us; had the extraordinary harvest reaped by Mr. Symington from his single colony been exhibited in this class, it must have taken a prize, as it was, it quite escaped the notice it deserved.

COTTAGERS' CLASSES.—The third division of prizes was offered to cottagers; and, lest there should be any doubt as to the meaning of the term, it was defined as 'open only to those who work for daily hire,' a definition at which few could cavil, since it rejected all those who, otherwise well-to-do, enjoy the pleasure attached to the *cottage ornée*, and who from no lack of means might be enabled to drive the cottager out of the field. The necessity for this saving clause was particularly exemplified during the time that entries were making, since one self-styled cottager was cleverly detected by the energetic secretary, Mr. Hunter, who, discerning something in the style of entry not quite usual with cottagers as specified, made application to the rector of his parish, and from him ascertained that the intending competitor was a small landowner and farmer, a surveyor, and clerk, which naturally caused his disqualification. The first class for these was No. 24, 'for the largest and best exhibition of super honey in comb, gathered by one stock, or united swarms of bees, the property of the exhibitor.' In this class there were six prizes offered, ranging in value from 3l. to 10s., it having been deemed advisable to tempt the cottager by offering



really valuable prizes; yet, singular to say, in the first instance only two of the prizes were awarded, the first falling to Mr. H. Withmal, and the second to Mr. S. J. Baldwin. The judges were, however, induced to amend their awards, and the other four prizes were given to Messrs. A. Fergusson, W. Martin, L. Reed, and T. Austin, in the order in which their names appear.

In the second class for cottagers, No. 25, four prizes were offered 'for the best exhibition of honey in comb, produced in one apiary, without the destruction of the bees;' and here, again, two prizes were withheld, but afterwards awarded, Messrs. Fergusson, M. Freeman, S. J. Baldwin, and W. Martin, being the winners, in this order.

In the third class for cottagers, No. 26, 'for the best exhibition of new honey in glass jars, containing from 5 lbs. to 10 lbs. each,' four prizes were offered, and there were seven entries; yet here, again, the inexplicable policy of withholding was pursued, but afterwards amended, the prize-winners being respectively Messrs. Martin, W. Scorer, Mr. J. Stephenson, and Mr. J. Walton.

We confess to some disappointment at the smallness of the number of cottager competitors, the total entries being only twenty-two; but, perhaps, it is simply what might have been expected at a first show, but we have full assurance that this class will be much more largely represented on future occasions. The presence and anxiety of the country clergy, and the eager interest they showed in everything that appeared likely to aid in promoting the improved method of bee-keeping as an aid to their cottagers' industry fully warrants this assertion. Once get the clergy interested in the movement, and it must progress. Centres of intelligence, each in his own sphere of usefulness, they are banded together in a brotherhood, whose influence is all-powerful wherever brought to bear, and, Heaven knows, none are more ready than they to promote, both by example and precept, every movement calculated to improve the moral and physical condition of the labouring poor in their pastoral charge; and we, therefore, accept as a happy omen the appearance of so many of their body at the Show. With bar-frame hives, which can be supplied as cheaply as the old skep, and whose advantages render them ten times more valuable; and with the Honey-Extractor exhibited in action, and its *modus operandi* explained under their very eyes, we shall be greatly disappointed if they do not now effect the radical change in the method of bee-keeping, for which advanced apiarists have so long striven. The *Journal of Horticulture*, after the Crystal Palace exhibition, acknow-

ledges that the 'old close skep,' like Nutt's collateral system, 'is doomed;' and to the clergy we look to effect 'a consummation so devoutly to be wished,' and thus for ever remove from England any excuse for the use of the abominable sulphur-pit.

In the Miscellaneous Classes some very useful inventions were brought out, great ingenuity being displayed.

Class 27 was 'For the best and largest collection of hives, bee-furniture, bee-gear, and apiculturist's necessaries—no two articles to be alike.' There were three prizes offered, but two only were awarded, equal first being given to Mr. James Lee, of Windlesham, and to the Editor of the *British Bee Journal*. These two exhibits were of entirely different character, Mr. Lee's being by far the best as an exhibition of the most beautiful workmanship, while ours was the largest and most varied; perhaps not the most useful, but interesting, nevertheless, from its historical connexion. Hives of all kinds, from Langstroth's first to the improved hives of the present day, being on view. We exceedingly regret that Mr. Lee's name appeared in the *second* place in some of the leading newspaper reports of the Show; we willingly give him *first* place, and are glad to be in such good company.

Mrs. Pagden, of Alfriston, also exhibited in this class a collection of hives, supers, and naders, showing 'How I make 70% a-year by my Bees.' As straw skeps they were of excellent make, and very reasonable in price, being within the reach of the most humble.

Class 28, 'For the best drone-trap,' there were four exhibits, of which that of Mr. F. Cheshire, of Acton, was declared the best, probably because of its extraordinary simplicity, it being easily adaptable and not likely to get out of order. Mr. S. Richards, of Par Gate Station, Cornwall, exhibited a very useful trap, applicable to any kind of hive, the principle being that the front of the hives should be raised sufficiently to allow the workers to pass either way, while the drones, if they ventured forth at all, would find themselves trapped most certainly. Aston's celebrated trap was also there; but the judges preferred the new one.

Class 29, 'for the best bee-feeder, the invention or adaptation of the exhibitor,' produced ten exhibits, the best of which, in *our* opinion, was that exhibited by F. Cheshire, Esq., which consists of the bottle and shovel, illustrated in the *Journal* for May, 1873, with his improved vulcanite plate, by which the rate of feeding may be regulated to the greatest nicety. The judges, however, thought differently, and awarded the prize and certificate to the top feeder exhibited by J. S. Turner, Esq., of Totteridge, which supplies liquids and barley-sugar at one

and the same time, and is, we believe, available when not thus required, as a small super.

For the best appliance for introducing alien queens to stocks, Class 30, there were five entries, that of the world-renowned 'Renfrewshire Bee-keeper,' exhibited by Mr. J. Anderson, bearing off the palm. It is a neatly made article, intended to slide down between the combs after the manner of that shown by W. Carr, Esq., and lately illustrated in this *Journal*. We confess to having had no experience with cages of this kind, being always fearful that the queens confined in them might possibly be starved to death, since they contain no honey or other provision; and it is singular that bees which would instantly kill the caged sovereign if they could get at her, should be expected to feed the usurper through the bars of her prison; yet the principle being set forth on the authority of the 'Renfrewshire Bee-keeper,' and W. Carr, Esq., must be considered indisputable.

Another cage, exhibited by Mr. Carr (also applicable for covering sealed queens' cells to prevent their destruction), appears to us to be more nearly what is required, although there are few of us who know anything of bees who care to trust to the rule laid down by Mr. Carr, that after the queen has acquired the odour of the hive by thirty-six hours' confinement, she may be set at liberty in safety; when we know that often after several days' confinement in a hive, the bees will sometimes immediately slay a newly liberated queen, it makes one anxious to know the state of affairs before so doing. Mr. Carr's cage (No. 2) is undoubtedly a good one. It is illustrated in the *Journal* for May 1873, where a description of it will be found. The judges evidently halted in their opinion as to which of the two was best, but having decided, they unanimously gave that of Mr. Carr '*Honourable Mention*.'

'For the best bee-dress' (Class 31) there were eight entries, but the palm was borne off by C. W. Smith, Esq., of Totteridge, his being the most complete. It consists of simple veil and gloves, which are so much to be preferred to the more elaborate and expensive bee-dress proper.

Class 32, 'For the best method of quieting bees, with appliances shown,' there was a smart contest between Messrs. Smith and Cheshire, and the Hon. and Rev. Mr. Bligh. Mr. Smith's paragon-smoker consists of Indiarubber-bag, with brass fire-box and tube, which makes it just a little heavy and unsteady in the hand when in use. Mr. Cheshire's has been for some time before the public, and illustrated in *Bee Journal* for May; it consists of an ordinary pipe and piece of Indiarubber tube, which fits on the bowl, and which simply requires pressure to eject smoke from the mouth-piece of the

pipe. Mr. Bligh's smoker is a lively little affair—a small bellows with wooden nozzle, the large end of which will hold sufficient tobacco for any ordinary hive, and the bellows having an inside spring, it is an easy thing to work. It soon became a favourite, and many orders were taken for them at 2s. 6d. each; but the judges, taking price into consideration as well as efficiency, awarded the prize to Mr. Cheshire.

Class 33, 'For the cheapest and best supers for general use in an apiary.' Mr. Lee, of Windlesham, beat all comers for quality of workmanship; but 5s. 6d. is a good price to give for the *cheapest*, as well as the best super.

The next class, 34, 'For the best honey extractor,' caused no end of excitement. There were four exhibits—one by Mr. Walton, of Leamington, one by T. W. Cowan, Esq., of Horsham, Sussex, and two by Mr. A. J. Starling, of Tottenham Street, Kensall Road, who has been so long before the public as a manufacturer. First in order comes that of Mr. Walton, and between his and Starling's the judges must have had a hard struggle to decide, both having so many similar points, yet being dissimilar in others. Walton's is an unobtrusive-looking machine, fitted internally in the same, or very similar manner to Starling's; the latter has a multiplying cog-wheel gearing, rather noisy in its operations, while the former has a kind of lathe-strap motion equally multiplying, but perfectly silent. Starling's has a hinged door, which it is possible may shrink, and allow of access to bees. Walton's has a sliding door, slightly tapering, like a tailor's sleeve-board, which can always be forced into tight-joint. There was only one thing in which the Starling had the advantage, and that was in the delivery of the honey. In Walton's the honey would be continually running from an open spout beneath the machine, whilst in Starling's it could accumulate in the 'hold' of the vessel, and might be drawn off at any moment, or in any quantity, by means of a close fitting treacle-valve let into the bottom edge of the cylinder. The plan of operations is similar in both these machines, which are constructed on the principle lately described in *Bee Journal*, Vol. ii. p. 54, so that between them there was just a choice of conveniences. Mr. Cowan's machine was of a very different character; the cylinder was similar, and it was mounted on the cylindrical framework, but the internal economy of the thing was differently arranged. Instead of the combs of honey standing at right angles with the radii of a circle (as with the others), and forming two sides of a square within the circle in which they revolve, and which necessitates the reversal of their positions, as each side of the

comb is operated upon, they stand perpendicular as radii from the centre of the machine in the same plane with its spindle; and the argument appears to be, that inasmuch as the cells point slightly upwards towards the top bar of the frame of comb, if the frame is placed on end with its top bar outermost, the cells will have their inclination outward, and at the angle which most facilitates the escape of the honey from them. There is little doubt but that the Walton and the Cowan machines will be heard of again; but in the present instance, and perhaps because one of Starling's was at work within the building, and *known* to be effective, it was awarded the prize and certificate.

Class 35, 'For the best machine for embossing wax sheets for guide-combs,' there was only one exhibit, the prize being a gift to Mr. Neighbour—for certainly a very effective pair of plates, with chequers corresponding to the bases of honey-cells, by which imitation foundations may be made in wax, which the bees accept and work upon.

'For the best exhibition of pure bees'-wax' (Class 36) there were nine exhibits for three prizes, the first of which fell to Mr. W. Martin, the second to Mr. W. Laughland, and the third to Mr. J. Walton.

There was only one other class (No. 37) which attracted any entries, if an essay by the 'Lanarkshire Bee-keeper,' which came too late and without formal notice, be excepted. This class attracted twelve entries. A skep by F. R. Jackson, coated with what appeared to be Portland cement, stood first on the list, its recommendation being that it was weather-proof and moth-proof; but it was heavy, and its price condemned it. Mr. Smith's beepalace has been already noticed; it was passed by the judges without special remark. Mr. F. Bennett, who exhibited his balloon hive, was also passed by. The Rev. Mr. Hayter exhibited a straw bell, the crown of which was covered with zinc, as a 'cover for flat-top skep,' but as the price was 5s. while the 'skep, or box-hive' (Class 2) was only to cost 3s., it was also suffered to pass unnoticed. The only awards made for inventions in this class, were given to Mr. Cheshire, whose dividing frame, transferring board, sugar can, and pin drone-trap, were each thought worthy of special note. The first and second taking 1l. each, and the fourth 10s., each also obtaining a Certificate of Merit. These articles will be more fully described in our next number.

Not for competition, there were exhibited by J. S. Turner, Esq., a series of designs for beehouses, in which, as in the beepalace exhibited by Mr. Smith, the endeavour seems to be the attainment of the maximum of elegance and

ornamentation at a minimum of expense. Exhibit 302 was the Manchester super, attributed in the Catalogue to W. Carr, Esq., of Clayton Bridge, Newton Heath, heretofore supposed to belong to the Rev. W. C. Cotton. Mr. F. Bennett exhibited a wasp's nest under glass shade, by which it might be seen how differently the nursery cells of wasps and bees are constructed, the former being vertical, while the latter are nearly horizontal. John Hunter, Esq., the Secretary of the Association, exhibited a most interesting collection of queens, workers, drones, and combs, with queen-cells in all stages of progress and after-demolition. Specimens of the 'ravages of the wax-moth' were exhibited by W. Carr, Esq., and the Editor of the *British Bee Journal*. Mr. Carr also exhibited some enlarged and cleverly-executed pen-and-ink drawings showing the anatomy of the queen and her progeny, which entitle him to many thanks. Many other exhibits, 'odds and ends' of bee-culture, if they may be so called, were placed on the tables, but not being catalogued were, in many instances, passed unnoticed, simply from the want of some means of identification or explanation. A small jar, containing about half a pound of honey, was on the third day set upon one of the tables with a written card, which described it as a refutation of Mr. Pettigrew's 'theory of evaporation,' but, except to the initiated few, it was simply Greek, and quite incomprehensible; doubtless, however, it will *cause* some notice, if it then attracted none; but there is as little doubt but that Mr. Symington, who it appears was the exhibitor, will explain his object if called upon to do so. Last to be noticed, but *not* least in the estimation of amateur and intending bee-keepers, was the exhibition of manipulation of live bees, held in the north corridor, where might be seen performed almost all the operations essential in modern bee-culture. Driving or drumming, to make artificial swarms, transferring the contents of straw skeps to bar-frame hives, fixing the combs in the frames, so that they should thereafter be moveable, uniting stocks, introducing queens, opening bar-frame hives, finding queens and caging and releasing them, opening and examining the boxes, in which several dozens of beautiful Ligurian queens, each accompanied by her bodyguard of about fifty workers, were brought into the Palace and exhibited, showing the method of finding, caging, and introducing them. These and many other operations and performances such as frequently occur in an apiary were gone through over and over again, until the poor bees seemed almost to know what was required of them, and to do it accordingly without the slightest attempt at resistance. Poor things! it grieved

us exceedingly to see the waste of bee-life which was caused during these three days' manipulation, not only because the loss was nearly all our own, but because of the very wrong impressions which might be formed by onlookers of the value of these operations by those who profess to 'never kill a bee.' Lest this might be the case, we mention that the bees were taken to their stations on the Saturday prior to the Show, and immediately released; and during Sunday, Monday, and until noon on Tuesday, they were flying abroad, and gathering pollen merrily, having, as is usual, become immediately acquainted with the new locality. There had been, however, one cause for fear for the safety of the public; the floor of the corridor was open, similar to that in the principal transept;—and it was found that the bees, if they fell on to the ground-floor, would crawl down the openings and under the glass screen, and, thus perhaps getting on the wrong side, might alarm the lady visitors; to prevent which, *the mistake* was made of laying cocoanut matting on the floor of the operating-room, to prevent the bees getting down the cracks (or openings), instead of its being laid on the visitors' floor to prevent them *coming up*. Every bee-ing knows that his pets have a hooky-claw at the end of each of their feet, and cocoanut matting being essentially fibrous, those which from any cause alighted, or were tumbled, upon the floor, failed to extricate themselves for some time, and of course ran all the risks attending their position. With only the operators in the room, these risks would have been very small, but as it presently became the rendezvous of all who wished to show their contempt for stings, the slaughter of the innocents was really dreadful. What could we do? We had invited aid,—we had asked bee-masters to help in showing how the operations are performed; there was no distinctive badge to show who were operators and who were not, and, as a consequence, 'one had as much right inside the room as another'—at least it was said to be so—and at their first show, amidst the hearty congratulations of all the visitors, how could the committee say otherwise? how restrain the curiosity the show was intended to excite? how prevent the trampling to death of thousands of our poor bees? We deeply grieve for them, but, after all, it was only the price of SUCCESS.

'They say it was a shocking sight,  
After the field was won,  
For many a thousand bodies there  
Lay rotting in the sun;  
But things like that, you know, must be  
After a famous VICTORY.'

Chief among the attractions in the operating-room was the Honey-Extractor at work. After

all that has been said of it *pro* and *con* by those who *did*, and those who *did not*, know its power, and the ease with which it could be used, there it was, the 'Monarch of all it surveyed;' and in the hands of a skilful operator its title none dared to dispute; or if any lingering doubt existed as to its capabilities, how quickly were they dispelled. The tests the machine was put to were many, but not once was it at fault, and the easy confidence with which the combs were handed out of it for public inspection, after a few revolutions in its interior, afforded proofs almost as convincing as the work itself of its thoroughly practical character. In the first number of the *Bee Journal*, May 1873, letters appeared from Messrs. R. Symington and W. Carr; the former strenuously advocating the use of the machine, the latter giving some account of the wonderful results obtained by its use; since then the Rev. D. W. Pennell, and latterly the Rev. J. F. Hodgson and others, have given indisputable evidence of its value as an apianian appliance. For the present, perhaps, it will be sufficiently indicative of the conviction the machine earned for itself when we state that every extractor in the building was sold, and many more were ordered; and we do hope that they will all be properly managed, for some of them have gone direct into their enemy's camp.

Time and space must now bring our long description to a close, but before we conclude let us see what has been done. We have gone through the long list of exhibits, and have praised or blamed as seemed right; and we hope if any deserving exhibit has been unnoticed, we shall be forgiven, for it is pretty generally known that our occupation was more with the bees than their domiciles or produce; and this must be our excuse. We must, nevertheless, congratulate bee-keepers at large upon the re-union of bee-masters which took place on the occasion. Everybody who is anybody in the bee world was there, with, to the best of our belief, three notable exceptions, viz. the Renfrewshire and the Lanarkshire Bee-keepers, and Mr. A. Pettigrew; had these gentlemen not been unfortunately prevented attending, we could have said in the words of the Clown in the *Pantomime*—Here we are!!

Never before has there been in England such a general introduction of bee-keepers to each other as took place during the three days of this great Show; and happy will it be for the welfare of the common cause if the kindly feeling then generated survives, and bee-keepers generally, avoiding the well-known causes of offence to bees and to each other, adopt the gentle measures in all their apianian movements which render the use of the sting unnecessary.

Before closing this article we must remind

all those who feel an interest in the advancement of apiculture, that to the unparalleled exertions of John Hunter, Esq., the Honorary Secretary of the Association, the wonderful success of this great undertaking is mainly due. Without assistance, except of his own procuring, his pen and ready hand have removed all difficulties, and his patient firmness and perseverance to the very last, entitle him to the hearty thanks of the whole bee-keeping community. He was, and is, 'the right man in the right place;' and long may he adorn the position. The members of the committee, J. M. Hooker, Esq., R. Symington, Esq., F. Cheshire, Esq., and J. Smith Turner, Esq., laboured hard and incessantly; and upon them, with such aid as we individually were able to afford, fell the principal burden of staging the exhibits, and only those who have been similarly engaged can form an idea of the labour involved in this proceeding. That everything was not perfect is not to their discredit; it was a new work, without a precedent, and completeness could not fairly be expected, but with the experience gained, similar imperfections will in the future be well-nigh impossible.

We cannot close this article without alluding to the good service rendered by the Vice-Presidents, many of whom were also judges during the whole show. At the operations with live bees, W. Carr, Esq., Rev. D. W. Pennell, and Geo. Fox, Esq., with the indefatigable and ubiquitous committee-men, Messrs. Symington and Cheshire, rendered conspicuous service by delivering intermediate lectures, describing the various operations performed, and thus rendered intelligible what would otherwise have been 'dumb-show;' for, owing to the care taken to protect the public from the bees, it was almost impossible for those within to be heard through the glass screen by the spectators outside, who were really those in whose behalf the exhibition was mainly promoted.

At the close of the Show, a general meeting of the Association took place—the Hon. and Rev. Henry Bligh in the chair—at which all the matters connected with its formation were discussed and approved, and the Rules and Regulations for the guidance of the Association adopted. See page 105.

After the meeting, the first dinner of the Association took place, and was numerously attended. The Hon. and Rev. H. Bligh was again in the chair, in the absence of the President, Sir J. Lubbock, who was prevented by an accident to Lady Lubbock, from attending. Various toasts and compliments were passed to the committee, the judges, and the visitors, to which suitable responses having been made, the party broke up at an early hour.

### THE COTTAGERS' PRIZE HIVES.

These hives seem to have created quite a sensation amongst bee-keepers, from the reports concerning them which have appeared in the daily press; and lest there should be any misapprehension regarding them, we here present illustrations and descriptions of them.

No. 1 was in competition in Class 2 (*For the best skep or box-hive for depriving purposes, for cottagers' use, that can be supplied for 3s., exclusive of floor-board*), and being fitted with bar-frames, which render combs moveable when properly arranged, it was unanimously voted the prize. Like the old straw skep, it is not a complete hive: it has neither floor-board, adapting-board, super, nor roof, and its frames are intended to be covered with a quilt composed of old carpet, surmounted by sundry thicknesses of sacking, druggeting, old matting, or anything porous, non-conducting, and convenient—a waterproof roof covering the whole. It was put forth in direct opposition to the skep; it met it on its own ground, and it has beaten it at all points—on the score of economy, convenience, and comfort for the bees, and their profitable management. Like the old skep in other respects, it needs protection, which may be afforded by either of the means usually adopted in its behalf.

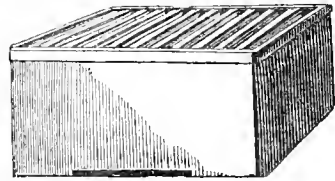

Cottagers' Hive, No. 1.—Price 3s.

The hive is made of half-inch yellow deal, nailed together with French wire nails, which are put in at opposite angles to each other so as to form dovetails in themselves, which from the proper distribution of their powers of resistance, will not draw out, as the common dovetail sometimes will. The front and back are  $14\frac{1}{2}$  inches long and  $8\frac{3}{4}$  inches wide, the sides are  $15\frac{1}{2}$  inches long and 9 inches wide; and when fixed together, the front and back being nailed *between* the sides, the hive becomes  $14\frac{1}{2}$  inches square inside, which is exactly the size of the Woodbury.

It will be seen at once, taking the measurements into account, that the sides of the hive are a quarter of an inch higher than the back and front, which leaves space on the top of the latter for the frames to hang upon, and yet be flush with the top of the sides. The top bars of the frames are of exactly the same length as the sides of the hive, consequently they reach to the full extent of it, and are kept from longitudinal movement by strips about  $1\frac{1}{4}$  inches

wide and  $\frac{1}{4}$  of an inch thick, nailed along the front and back, which form those parts into rabbets, similar to those in which the ends of the frames usually rest, but without the inconvenient notches. Keeping the top bars of frames flush with the top of the hive is a great improvement on the old plan, in which the ends of them are sunk into notches cut into the rabbets, as they are so much more convenient for handling, being capable of immediate lateral movement, so that when examination of combs is necessary, nine of them may be brought slightly closer together by simple pressure, and without any wrenching, to make room for the extraction of the tenth. A cottager who can afford to buy a skep can afford one of these bar-frame hives; it will take no more wood to make a floor-board for one than for the other, or for a roof either, which is by far of the most vital consequence, dryness being an absolute essential, especially during wet and cold weather. The floor-board sent out with the hive in its more complete form is made out of a piece of board 33 inches long, 9 inches wide, and half an inch in thickness; for cutting, a line is set off across the board from a point  $15\frac{1}{2}$  inches from one end to another point at a similar distance from the other end in a diagonal direction; it is then sawn through, and the two pieces put together, the long sides touching each other, and forming the floor, which will then be 18 inches wide; strips are then cut, one from each of its outer edges, of  $1\frac{1}{4}$  inches width, which are nailed on to the under side as ledges to hold the two parts together, and the floor-board will then be complete, as shown in engraving. The roof is made of two pieces of board, each about 20 inches long, 9 inches wide, and  $\frac{3}{8}$  of an inch thick, which are nailed to two triangular pieces, as indicated in engraving, the junction at top being covered with a fluted piece about an inch square, which effectually keeps out the wet; and to enable it to be serviceable for many years, it only requires to be occasionally painted or tarred.

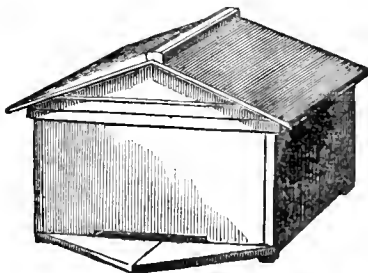
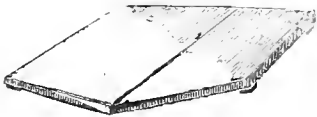

Cottagers' Hive, No. 2.—Price 6s. 6d.

It is not claimed for these hives that externally they are either perfect or complete, but they require nothing to be done to them which the commonest cottager is unable to perform. In sunny weather they require shading, and in very cold weather they may require a little extra protection either from old sacking, or a few hay-bands bound round them (as with the straw skep), or their sides may be thickened, or rendered double by means which will easily suggest themselves, and of which description would be tedious. Internally these hives are complete improved Woodburys, and we have little doubt but that their introduction will lead to a more general adoption of the bar-frame moveable comb system of humane bee-culture.

#### OCTOBER.

During this month, and as early as possible, the bee-keeper should take every possible precaution, and adopt every known means, to ensure the safe disposition of his stocks for the winter. The exact condition of every stock should be carefully ascertained, and if any show the slightest symptoms of foul brood they should be deprived of their queens, which may be given (unattended by workers) to queenless stocks. This is a safe proceeding, as it is well known that bees do not convey the infection, except by means of the honey they carry with them and deposit in the cells of the hive into which they may be introduced, and as the queen does not deposit honey, her introduction (alone) is unattended with danger to the stock to which they may be given. Bee-forage may now be considered exhausted, and it will therefore be evident that where stocks are weak in stores, feeding should be proceeded with without further delay. This should take place only at night to prevent the danger of robbing, which the scent of bee-food, and the excitement occasioned by day feeding, are likely to occasion. Those who have adopted the gentle system of feeding, which we have all along most strenuously recommended, in preference to the rapid system which previously obtained, through the advocacy of former bee-masters, Langstroth included, ought now to have their stocks in perfect condition for wintering, with plenty of (sealed) food, brood, and young bees. Stocks that, through neglect or queenlessness, are weak in bees, should be united. Uniting bees at this time of year, by means of scented syrup, is often provocative of robbery, and sometimes causes the destruction of the united stocks; it will therefore be prudent to avoid its use, and adopt the measures suggested on page 73 of the *Journal* for September. Taking a hint from bees themselves is sometimes good practice: we

lately found a hive the entrance of which was almost entirely closed by a curtain or wall of propolis; the bees had evidently fortified themselves against the ingress of both cold weather and insect enemies, leaving only two small holes, near an inch apart, for their own convenience. Neither of these holes would permit of more than one bee passing at a time, which we consider a mistake on the part of these wonderful architects, for sometimes it may be necessary for two to pass one way, as when a live bee carries out a dead one. When practicable all hives should be lifted from the floor-boards, and the under edges of the hives cleared from the vestiges of wax-moth which may be found there, the floor-boards should be thoroughly scraped; and where so contrived as to be capable of reversal, they should be turned bottom upwards, that the bees may have the comfort of a clean floor and no vermin in their winter quarters. Destroying wasps' nests now will prevent the formation of many hundreds of them next year. It is a pity that these pests, which are at their strongest now, should be allowed to exist until their queens for next year have hibernated, as then the nests can only be accidentally discovered, while the queens may live to establish each a new colony next year. A vigorous raid upon the wasps now that their nests may be easily discovered, might lead to their extermination. The latest method of destroying them is by the introduction of a strong solution of cyanide of potassium, which may be injected into their nests, or laid upon lint at their entrance. Cyanide of potassium is a deadly poison, and its fumes should not be inhaled. Spirits of turpentine injected into a nest will destroy all the wasps: it is less dangerous, more easily procurable, and is a very inexpensive material; and being so every bee-keeper should, by its means, endeavour to rid his neighbourhood of these persevering pests.

*Bleaching Wax.*—Wax is bleached by remelting it and running it several thin sheets or cakes, suffering it to cool and exposing it to the influence of air and sun.

*Weight of Bees.*—In one pound avoirdupois or sixteen ounces there are five thousand bees. From fifteen to twenty thousand bees constitute a strong swarm, that is, four to five pounds in weight.

An Iowa bee-keeper travelling through that state recently remarks: 'A few Italian stocks which I chanced to find worked busily on the flowers of the western prairies. I counted twenty-six varieties of flowers visited only by the Italian bees.'

The indefatigable hive-bee, as she flies from flower to flower, amuses the observer with her hum, which, though monotonous, pleases by exciting the idea of happy industry, that whiles the toils of labour by singing. When she alights upon a flower, and is engaged in collecting its sweets her hum ceases, but it is resumed again the moment she leaves it.

## Correspondence.

\* \* \* *These columns are open to Subscribers, so that their queries, replies, correspondence, and experiences, may be fully and faithfully recorded; and for the discussion of all theories and systems in Bee-culture, and of the relative merits of all hives and appurtenances, that the truth regarding them may be ascertained. The Editor, therefore, must not be expected to coincide with all the views expressed by the various writers. All Correspondence is addressed to the Editor.*

### AN HOUR AT THE CRYSTAL PALACE.

With shows of horses, donkeys, birds, and babies, we have become familiar, but now we have had quite a novelty, a show of *Bees*, a very small but not unimportant live stock in the country. By bees many a cottager pays his rent, and many more might do so and put aside a surplus against a rainy day. The British Bee-keepers' Association has but been lately established by a few philanthropic gentlemen, who are now headed by that busy man of science and of commerce, Sir John Lubbock, to prominently bring before the old race of bee-keepers the error of their way, and to lead them into new paths, flowing, if not with milk, yet certainly with honey.

The cultivation of fruits and plants, birds and beasts, has without doubt derived immense benefit from science, aided by the skill and busy brains of thoughtful men; and the British Bee-keepers' Association say that much wants doing in the same direction in the cultivation and improvement of the bee and its domicile. Unquestionably, looking at the Exhibition in question, the proof is incontestable. Enthusiasm in bee-keeping is immense. All parts of England and Scotland send their quota to the Show; and as honey-comb is a fragile article, and bees are ticklish customers to confide to the tender mercies of railway companies, in most instances the exhibits are accompanied by their owners. One honest hard-working Scotchman, reputed to be the best judge of honey in Scotland, whose heart is in the business, came all the way from far-off Ayrshire at his own expense to act as one of the judges, and, maybe, give or take a useful lesson to or from the Southerner. Another ardent lover of the bee brings a pattern hive from Denmark, from which a wrinkle may be gained towards perfection.

Sixty different kinds of hives were exhibited of qualities various, pretty, useful, cheap, and strong, and all, in the opinion of their respective inventors, perfection. If bees cannot be happy and healthy in some of these abodes of luxury, they ought to be pitied, for no pains seem to have been spared to make them so. Many patterns show a great stride in the direction of profitable bee-keeping, which will hence become popular.

And then the honey!! The tons to be seen on the tables, and such honey! Would not our olive-branches lick their mouths at the sight of it? Who would eat butter and its abominations if honey were on the table as a substitute?

Seriously the display was magnificent, and all for sale at prices moderate. One gentleman, happily domiciled in a beautiful part of Sussex, sends to the



Show the magnificent harvest of 700 lbs. of honey gathered by twelve stocks of bees,—not the thick, murky, easily covered stuff, generally sold as honey, but pure, white, and delicious, fit for the table of the Queen. Honey as generally sent to the market, although pleasant to the palate, is not the pure and wholesome stuff it should be. Cottagers, by whom nearly all the English honey is supplied, seem to act upon the principle that ‘what the eye don’t see the heart don’t rue,’ for when the time to *take up the bees*, as it is technically called, comes round, they, cruel, unthrifty, and unwise, by fire and brimstone take the lives of the poor bees who have worked so hard, and the fine, full white maggots not yet arrived at bee-hood, they—well, they are very juicy, and the greater the bulk the more the honey weighs! A little science and good teaching here applied, such as this Show has set before the world, will enable the bee-keeper to send to market a pure delicious article, and manifold increase his harvest. We don’t cut down the trees to get the fruit, nor kill the hen to get her eggs, why then slaughter the bees to take their honey? Let them live to work another year; appropriate their stores if you will; sugar is cheap; a few pounds of which will quite content them for their winter provender.

The wealthy and great buy a great deal of honey, but they always buy it in comb and pay for quality. Super honey, clean, white, and delicious, a first-class West-end house sells at from 2s. 6d. to 3s. 6d. per lb., whilst honey out of the comb may be had for a third of this. Not that strained honey cannot be had pure, but people are suspicious, and prefer to buy it undisturbed as stored by the bees. A magnificent display of supers was exhibited; upper stories added temporarily to the hive, which in good seasons are filled by the bees in addition to the hive, their dwelling-place and nursery. No breeding takes place in the super; it is honey of the very finest quality, the thought of which is enough to make one’s mouth water. The net contents of some supers here displayed weigh nearly 100 lbs., gathered, be it remembered, by a single hive of bees! Think of that, ye bee-keepers of the olden style! A swarm of bees, ordinarily costing not more than 17s., to return in a single year ten times its value; if this is no uncommon result, what other live stock can compare with bees?

That great and good lady, the Baroness Burdett Coutts, who seems never to miss an opportunity of doing good, has for some time past been setting an example how the rich may help the poor by starting them with a hive of bees, conditionally, that they return the first swarm, to form the nucleus of another start to the next recipient; and why cannot others do likewise?

Apparently bees thrive well even within scent of London smoke, for one exhibitor, whose apiary may be reached in a decent morning’s walk from Hyde Park, contributed two or three hundredweight of honey to the Show.

Among the principal objects of interest are the Ligurian bees,—a variety cultivated principally in Italy, which for some years have been making fair way in England as an improved breed; and, like the Norway rats, bid fair to drive the aboriginal black

race into oblivion. If beauty is a test of value they certainly far surpass their rivals. This variety was some years ago sent from England to Australia where they safely arrived and have thriven well. America’s contribution to the Show is a new machine called the Honey Slinger, by means of which honey may be extracted from the combs without bruising the latter or interfering with the brood and so ensuring a product almost as fine as from supers. Another great feature of the exhibition was a public and practical demonstration of apiarian manipulations in which experienced bee-masters exemplified how their bees could be made to swarm at their owner’s will, how queens could be found, and if necessary bred in any number, and many other astonishing operations. We have shown how easy it is to take out what honey may be spared without harming the bees, and in fact how the whole inside of the hive is as come-at-able and the bees as tractable as the cattle in a farmyard. Behind the protection of a glass screen provided for the public we watched and admired the operations, not forgetting to appreciate the quietude, coolness, and courage of the bee-masters who without any protection whatever calmly proceeded with their work, undismayed by the hundred thousand little armed warriors, each on the *qui vive* to attack a nervous enemy, could such be found; but no, the masters appear to have left their nerves at home, and the little warriors finding them invulnerable lose heart, and tacitly acknowledge the power of man.

The Association has started well, and has a grand career before it. Its committee (of workers) act in the interest of philanthropy, and well do they merit the support of all who feel an interest in our rural population and its pursuits: and who will begrudge the member’s fee of five shillings per annum which will enable him to participate in so glorious a cause as the emancipation of the working bee?

The ‘Holiday Act’ of Sir John Lubbock has wrought the emancipation of many thousands of hard-working men at certain seasons of the year; and why should not they, believing as they must, in *his* desire for the welfare of the industrious classes, join the Association of which he is the distinguished President, and determine that in this enlightened country apiculture shall be respected and bee-murder cease, and thus show their regard for their good friend and fellow-worker, the *honey bee*?—**APIS MELLIFICA.**

#### REGULATED FEEDING.

Winter is now drawing towards us with unpleasant rapidity, and the better our stocks have been prepared for its advent the less will be the loss during its continuance. Last spring found too many bewailing their unhappy case:—their lives without a single living tenant or so far weakened as to be practically useless. Surely the sad mortality which notably then prevailed is not in any way inevitable, but may by wise forethought in the vast majority of instances be prevented. Where neither foul-brood nor dysentery have appeared, the absolute decease of a colony whilst wintering, or its rapid dwindling just when spring promises its return, when brood is

being matured and quiescence is giving way to activity, may, I fully believe, be explained in nineteen cases out of twenty by the fact that no bees were bred so late in the autumn that no demand could be made upon them for labour for the common weal. We must remember that *the age of a bee is not reckoned by number of days but by amount of service.* The little insect produced in the summer, surrounded by all the circumstances which stimulate to the highest activity, passes 'a short life and a merry one,' in the very limited period of six weeks, which is sufficient to wear out of it all the forces with which it left its cell, but just such another bee with no greater initial power, if hatched late in the autumn and lulled at once by coming winter into the restful repose to be found in the cluster, will respond to the gentle call of returning spring with all the gushing activity of youth. It has still life before it, and is worth for work and service a dozen such as have only a residue of their days. Half-worn-out bees, rousing themselves to the labour of nursing, and having to endure the trying work of pollen-gathering with it, may be, a low temperature and a driving wind, die so rapidly that the colony, if destitute of inhabitants in the highest vigour, must, as multitudes unhappily did in the opening of this year, succumb through constant depletion. My opinion will show how fully I endorse as timely and wise the warning now long since given by our Editor, which warning must have done much in preventing disaster; but I still feel the vast importance of carefully studying all the conditions of perished stocks, so that something like definitive conclusions may be reached in respect to them. Let me, as a reader of the *British Bee Journal*, therefore ask those who would advance bee-culture to place any instances of misfortune not absolutely clear upon the dissecting table, as it were, by giving an account as exhaustive as possible, so that an exact diagnosis may be made, advice for the future given, and all benefited by the mistakes or disasters of the few.

While insisting upon the importance of late breeding, the question naturally arises how is this result the best to be secured, which brings me at once to the object of my writing. The principle may be broadly laid down that *bees do not so much arrange their household expenses according to that which they have laid by as according to income.* Hence a hive with a superabundance of stores will leave off breeding as supplies fail just as promptly as one that is almost destitute. The bee-master, taking advantage of this fact, may cause the first-mentioned to continue in activity by removing and returning its honey, while in the second, and indeed in almost every case, the winter may be virtually shortened by feeding. But most have felt that all systems hitherto suggested have lacked the gentle regularity of the natural inflow of Nature's sweets. The bottle, the only really good and simple plan of feeding, has the disadvantage of giving to the bees so rapidly that they, in their greed and excitement, fill 'up' the cells of the brood-nest, and before the stimulus for ovipositing has really taken possession of them the supply is gone. To overcome this difficulty I have used, in lieu of perforated zinc, plates of vulcanite, having holes pierced in them according to the wood-

cut. Vulcanite is smooth and flexible, quite incapable of being chemically acted upon by any bee-food as zinc may be, and, above all, is an extremely good non-conductor of heat. The plate is fixed upon the hive-board by a screw (A), to receive which a hole is first made in the vulcanite with a red-hot wire. The central circle represents the feed-hole of the crown-board, which should be situated exactly between the screws A and B, the latter,

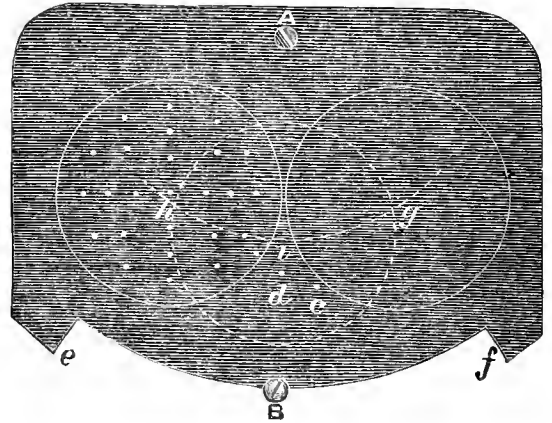

a locksmith's-screw, is placed so that its head laps over the edge of the plate and holds it in position while it permits its rotation as far as the stops *e* and *f*. The plate is pierced, as per pattern in figure, by a heated knitting-needle, the burrs removed by scraping, and the under-side roughened by a sharp knife, so that the bees may have foothold. If the whole has been arranged as described, and the feeding-stage turned until the stop *f* touched the screw B, the circle on the right will be over the aperture in the crown-board, and as this circle contains no holes, the bees, although the bottle may be on, will get no food. But if the stage be now slowly turned back again, the hole *c* will pass first over the feed-hole, allowing one bee to regale herself at a time; a further movement, and *d* is reachable from beneath; next, the hole near the edges of the left-hand circle allowing two and then three bees to sip at our sweets, and, as the plate turns, hole after hole comes into position, until the maximum is reached, when the stop at *e* arrests the revolution of the vulcanite.

The effect of slow but regular feeding is most remarkable. The supply, though scant, continues, and the bees soon come to trust in it as in a perennial spring. The brood-nest is kept clear, ovipositing commences, and as the stock gains strength, empty frames may be placed in the centre of the hive, which will quickly have combs built in them as beautiful and regular as if the work of a spring swarm, while, so far as my experience as yet this autumn is concerned, not a drone cell will appear. I have nursed up into an extremely strong colony a single Woodbury comb, with its handful of bees, from a dividing-frame nucleus, with the assistance of two other combs (one on each side of the first, to retain heat), and constant and very slow feeding. It has at the present time nine complete frames, the tenth in course of building, abundance of

brood in all stages, and as many bees as any stock I possess. Looking into a hive on Saturday, September 12th, I found a good supply of bees and stores, and the centre of the hive prepared for wintering, but not a single egg or any sign of brood. The outside frame was then removed, an empty one placed in the centre, and syrup feeding through two holes commenced. On the Wednesday following a considerable batch of eggs had been laid and a piece of comb about five inch square built, all worker and, with the exception of three or four cells, without store. It may be justly argued that this enforced labour for the bees will tend to make them aged, and produce the very result I deprecate. I reply, it is an experiment, and that it is my intention to see how far I can replace the whole population. Lest I weary, let me draw these remarks to a conclusion by saying that, in removing stores by the slinger or otherwise, where they are superabundant, and feeding slowly, regularly, and naturally, both in spring and autumn, the great secret lies of obtaining from bar-frame hives a harvest which the advocates of the skep can not only never attain, but of which they do not even dream. F. CHESHIRE.

#### THE OCTAGON FORM OF HIVE.

I perused with much interest your scientific and talented correspondent, Mr. F. Cheshire's contribution in the September Number on the 'Philosophy of Hive Shape,' and regretted to find the general scope of the article rather tended to disparage my favourite hive the Stewarton.

Coinciding with another contributor, Mr. Walter Hewson, who remarks in last No. 'that Octagon hive question has been pretty freely discussed; and I think may as well be allowed to drop,' I would only seek to reply shortly to one or two points; and in so doing will try to avoid all pedantry, remembering many of your readers are plain working men, consequently I would seek to avoid any unnecessary irritation of the 'pellicle' of their craniums.

First, then, it affords me pleasure to learn that that feature of the Stewarton Hive, admitting the honey-gatherers of the end combs to the supers, is now generally adopted in the hives of the advanced bee-keepers in the south, as in the days of my noviciate I failed to find the plan referred to in any work I could lay my hands upon, and felt complimented when one of the most experienced and thoroughly practical of English apiarists thanked me in the then *Cottage Gardener* for making it first known to him.

Your correspondent's comparison of the clustering bees to a crowd is exceedingly beautiful and good, while his figures surely do not bring out the superiority of the cubical form of hive. But the main point where it would appear my unfortunate experience does not square with his philosophy is, with reference to bees wintering better in octagon than in square hives; and to which point I would seek to address myself.

Shortly after the commencement of my apiarian career, feeling annoyed, at the early spring examination, to find the end combs of my square hives damp and mouldy, I complained to one or two leading southern

apiarists; and it was rather soothing for me to find I was not singular in my experience; I was recommended to do as they did, and remove one or two outer combs on either side, at beginning of winter, which plan I adopted, but unfortunately these removed combs, carefully wrapped up in paper, got brittle and easily broken, mice gnawed them, and moths found in them a congenial rendezvous into which to deposit their eggs; and then my poor favourites had such a cold blank look on either side their works, so much so I meditated cutting grooves at back and front inner side of their cages, to hold thin moveable partitions of wood. But how was it my Octagon hives did not show an equal amount of dampness? I never required to remove a comb from them, I could not saddle the blame on the crown-board with the intervening space between it and the bars, as your correspondent seems led to suppose, as that was a description of hive I never cared to adopt, back being top, exactly alike with slides only. I know the apiarist fathers laid down the law as to the superiority of the Octagon to the square form, to prevent the honey in the outer combs crystallising, with consequent deleterious effects following thereon. But what did occur to me at the moment as a plain common-sense solution, seeing both descriptions of hive were of one depth, as well as width at their greatest extremity, with this difference that these outer corners were cut off in the Octagon form, reducing the internal dimensions by a good many cubic inches, into a considerably smaller domicile, that, assuming the population and store were equally alike, on the principle that a certain amount of fuel will make warm and comfortable a small room, while the same quantity must necessarily fail to heat to the same temperature the extreme corners of a larger apartment, hence, as a sequence, the better kept combs in the Octagon, and the earlier commencement of breeding, which proceeding thereafter at an ever-progressing ratio, with consequent better results at the season's end, caused me ultimately to abandon the square, and adopt the octagon form of hive.

I liked the Stewarton Hive, too, from its freedom of any arbitrary dimensions, I could super and nadir it *ad infinitum*, in keeping with the wants of the season and the several queens' productive qualities, thereby preventing swarming; rarely did my colonies require feeding, in the very worst seasons there was always some honey, in the good ones a very great haul.

In conclusion, I regret very much to learn that the bee-keepers of the cradle of the Stewarton Hive, Ayrshire, failed to combine to send up their finest Octagons to the Crystal Palace Show, supposing their works of high art would be better appreciated at local competitions, and find a readier market near home; and I therefore feel all the more indebted to two of their number, Mr. Jas. Anderson of Dalry, and Mr. Alex. Ferguson of Stewarton, who at considerable sacrifice of time and expense did take up what they had, to give our southern brethren an opportunity of inspecting some fruits of the Stewarton Hive and system, and convince them that the benefits derivable therefrom are a reality and not a myth.—A RENFREWSHIRE BEE-KEEPER.

## THE HARVEST.

I have just brought my hives from the moors. I have two 'Ligurians.' 1. One in a Woodbury, which threw off its first swarm about the 20th of July: it was a large swarm, and this weakened the stock, no doubt. I put on a box super (to the stock), but they have done nothing in it. The hive weighs, however, about 4½ stone. Last year this was a young swarm; and on its return from the moors *all* the combs got shaken down. This is my great objection to these loose bars, that I cannot secure them properly for a journey of six or seven miles over bad moor tracks. In this hive I have the old combs lying quite across as they fell, and new ones built down to them.

2. My second is a Ligurian swarm in two Stewarton boxes. I fed them before I sent them up to the moors for two weeks; but the first two very wet weeks of August must have tried them severely. I was away from home and could not help them. They, however, weigh nearly 3 stone, which is about 2 stone of bees and honey. They have the top box full of the most beautiful comb; but have done nothing in the lower.

3. Then my third is an old common swarm in a Stewarton. They had a quantity of honey over from the winter, and when I took them up to the moors I put a third box on below and a super on the top. They now weigh 6½ stone. I have this morning taken the super nearly full of beautiful honey, and am in doubts which to take next; but I think the top box, which seems full of honey, not the lowest; for the lowest is not quite full: but yet the two lowest together will give plenty for the winter, though, of course, the lowest is new comb and fresh honey, the other old. For this hive I want a Ligurian queen. I do not quite know how I can insert a queen-cage between the Stewarton bars. What method would you recommend? In what way, too, do you feed in the Stewarton hives? Last winter I withdrew a sliding-bar half way, covered the vacancy over with a strip of carpet, leaving only room enough to put an inverted tumbler of candy-sugar, with a stick in it, just in the centre of the hive; this did very well, but is clumsy.

Bees have done very well on the moors this time, notwithstanding the first wet fortnight. There has been plenty of honey sold at 1s. per lb.—I see you speak of 2s.; but the Crystal Palace is so far off, and, besides, we are only taking our cages now, too late for the Show and sale.—NORTH RIDING MOORS, *Yorkshire, Sept. 23*

[The queen-cage invented by a 'Renfrewshire Bee-keeper,' the able exponent of the Stewarton hive and system in this *Journal*, should be the cage, *par excellence*, for the Stewarton Hive. Feeding must be either by the bottle over a partly withdrawn slide, or with syrup in a comb laid under a Stewarton super, slides being withdrawn on both sides to give the bees access.—*Ed.*]

## UTILISING SECOND SWARMS.

As a sequel to the case narrated last month, page 84, in addition to the couple of 20-lb. supers there alluded to—which, I believe, have since helped to grace the first prize table display of honeycomb at the

Crystal Palace—I have harvested the third super weighing 15, and the fourth but 8 lbs.—A RENFREWSHIRE BEE-KEEPER.

## A NOTE AND A QUERY.

Giraldus Cambrensis, in his life of St. David, bishop of Menevia, narrates a singular story respecting the introduction of bees into Ireland. A disciple of St. David, by name Mandabnaucus, indulged in the luxury of bee-keeping. On receiving an appointment in Ireland, he disposed of his hives and bees. But when he stepped on board the vessel which was to bear him to his new home, he found that his bees, disinclined to detach their fortunes from those of their former master, had followed him to the ship. The holy man, desiring to act honestly to those to whom he had disposed his stock, returned to the shore, and restored the bees to their proper owners. But the same haying happened a second and a third time, this persistence on the part of the bees was interpreted to be a message from on high which ought not to be gainsaid or withstood; and therefore, with many prayers and blessings from the holy brethren, the bees were permitted to accompany their beloved master. And so it came about that bees, which had never before been seen in Ireland, were miraculously transferred to that land. They took kindly to the new soil, and flourished abundantly, but in Menevia from that time bees have been wanting.\* In course of time Mandabnaucus returned to Menevia, and was made bishop of that place: he was known there by the name of Aeddau. He flourished in the beginning of the sixth century.

The Rev. Robert Williams, in his life of St. Aeddau, as given in the *Biographical Dictionary of Eminent Welshmen* (Llandoverly, 1852), thus adverts to the preceding narrative:—'Giraldus relates a marvellous story of the manner in which St. Aeddau carried over a swarm of bees into Ireland; for such creatures were never seen in that country before, *and have never been seen in Menevia since.*' Not being

\* Cum autem discipulus idem post annos plurimos circa patrem et obedientie regulis instructus fuisset, et vite meritis illustratus, cum Hybernicam insulam de patris licentia petere jam parasset, mare ingressum cuncta apum examina, que Menevia vel in ejusdem confinio fuerant, ipsum usque in navem ipsam sunt secuta. Ipse enim inter fratres huic specialiter operi indulgebatur, quod alvearia ad nutriendos apum fetus per examina disponebat. Quo viso, nolens fratres possessionis sue damno fraudare, ad terram rediit, patremque David revisitavit, apibus ad sedes suas indeque reversis. Ad navem autem secundo reversus, apes cum undique sequentes denuo conspexit. Iterumque ad terram revertebant sicut primo sic et secundo sunt secuta. Patrem autem et fratres jam tertio repetens, quoniam suis eos utilitatibus nullatenus sponte fraudare, sed ipsos potius indennes esse volebat; tandem piis fratrum orationibus et patris benedictione Deo commendatus, transfretandi licentiam una cum apibus communiter accepit. Ex quo factum est, ut apes, que nunquam antea in Hybernia, ut fertur, vise fuerant, ab eo quo tam miraculose per ipsum transvectæ sunt tempore ibidem abundare, in Menevia vero ab illa semper hora deficere consueverint.—*Opera, ed. Brewer, tom. iii., De Vita S. Davidis Menev. Archiep., lectio vii. p. 396, 397.*

acquainted with the district of St. David's, which corresponds to the ancient Menevia, I am not aware whether the compiler of the dictionary from his personal knowledge of the locality endorses the statement of Giraldus respecting the absence of bees in Menevia, or whether, as is more probable, it has come down to him diluted through some historian of the life of the Welsh saint. But as it may possibly conduce to elucidate a question in the natural history of our 'little favourites,' I should be glad if any of your readers could favour me with the information whether there is at the present day any marked absence of bees in the district of St. David's, Pembrokeshire; and if this is answered in the affirmative—which for the sake of the inhabitants of that part I trust it will not be—I should also be obliged by being informed as to the nature of the local obstacles to their existence there.

It may possibly interest some of your readers to learn that Giraldus, in his *Topog. Hibern.* dist. i. cap. 6, mentions another claimant to the honour of the introduction of bees into Ireland,—namely, St. Dominick of Ossory. On the other hand, Giraldus states that it has been asserted that bees object to Ireland so much that even to sprinkle their hives with sand from that country will cause them to quit their combs.\*—G. HENDERSON, *Ealing*.

#### STRANGE FREAK OF BEES.

About the middle of July a hive in this neighbourhood swarmed. The swarm were duly hived, and the bees appeared to take kindly to their new quarters. On examining the hive in the evening, however, it was found to be empty, and no trace of the bees could be obtained. Next day their owner heard that a swarm of bees had, on the previous day, been observed passing a place fully two miles off. They were followed for some distance but were lost sight of. On the third day, some person went to post a letter in a roadside letter-box, and found it occupied by bees. No doubt could be entertained that they were the missing swarm. The box was quite three miles from their original *habitat*. The owner of the bees, unwilling to disturb them in their self-selected abode, obtained permission to remove the letter-box, replacing it by another. The bees are now diligently working in it in his garden. In this case we cannot help admiring the instinct of the bees in selecting a place on the whole so suitable for their residence, since they were not satisfied with that offered them. But is it to be supposed that before swarming they had become acquainted with a place at so great a distance from the hive, or is it more likely that they merely fell in with it during their wanderings, and adopted it as suiting their wants?—C. L., *Fort William, N.B., August 14, 1871*.

\* Verisimiliter autem dici potest, tempore Bedæ nonnullas forsitan in insula vineas fuisse, et longe post Solini tempora, sanctum Dominicum Osseriensem, ut asserunt quidem, apes in Hiberniam detulisse. Ceterum ipsos in hoc excusabiles vix invenio, quod adeo apibus inimicam hanc terram asserunt, ut advectos etiam inde pulveres seu lapillos si quis alibi intra alvearia sparserit, examina favos deserant.—*Opera, ed. Dimock, 1867, v. 5, p. 29.*

## Queries and Replies.

QUERY No. 109.—On examining yours and Mr. Symington's frame hives at the Crystal Palace show, I was surprised to notice several of them without supers. May I ask if you advocate supers, or simply one large hive, allowing room for the bees to store surplus honey (for depriving purposes) as well as for breeding purposes?

If some one would introduce a good useful honey extractor at a moderate price, say under 20s., I think it would be a great boon.

Can you also suggest why Ligurian queens and swarms are still so expensive to buy? They do not seem to me to be cheaper than they were several years ago, and yet they are said to breed and multiply more quickly than the common black bee. I am anxious to try them, but cannot afford 2l. for a swarm, and am not clever enough to venture in introducing a queen to any of my stock.—A. T. W., *Kenley, Surrey, Sept. 14, 1874.*

REPLY TO No. 109.—Excepting the hives in Classes 2, 6, and 27, there was not a single hive exhibited by either of us which was not properly furnished with either supers or their so-called equivalent collateral boxes. Class 2 was in competition with the skep, which has not a floor-board, roof, or super belonging to it; Class 6 was for the best and cheapest hive, 'on the moveable comb principle,' nothing being said of the means of 'depriving,' and hence supers were not stipulated for. In the collection, Class 27, supers were made separate exhibits, and as with hives, &c., in the other competition, after the public had had half-an-hour amongst them, they were 'all to pieces;' and the way in which some of them were jumbled together in the attempts of the uninitiated to put them together again, was most ludicrous to behold. We may safely answer for Mr. Symington, as well as ourselves, that the supering system is the best for obtaining pure virgin comb honey in boxes or glasses.

The Extractor will doubtless be made cheaper than it is at present when its value, as an appliance, becomes more known, and better appreciated by beekeepers, because then the demand will be greater, and they will be machine-made in a wholesale manner like clocks and watches, instead of in the present limited way. Besides it is not certain that the best form for an extractor has yet been shown, and during the long winter evenings ensuing, many intellects will be brought to bear on the subject with doubtless beneficial results. A tin dish, covered with a piece of wire-work, and having a string at each corner, makes a useful slinger, but it is excessively hard work to sling it round the head, and few would care to use such a 'machine;' its cost is, however, merely nominal.

Ligurian queens and swarms are much cheaper now than they were a very few years ago. Our first Ligurian queen cost ten years ago 30s., and some years afterwards they cost little less than a guinea; of late the standard price with monopolists has been about 15s., but through the *British Bee Journal* introducing the producer to the customer, prices have found a much lower level, queens being obtainable through its office at about half the money. Swarms which used to be from four to six

guineas each, and many ridiculously small at that, may now be had for a couple of guineas, and perhaps next year may be less. It must be remembered that the Ligurian bee has been introduced under great difficulties from the prejudices of certain writers; like the bar-frame moveable comb hive, and its giant helpmate, the Honey Extractor, it has been forced upon the notice of the bee-keeping public, and like them has come at last to be recognised as absolutely essential to profitable bee-culture. The consequence has been that the *demand* for both queens and swarms has increased a hundred-fold, and it can fairly be attributed to the prolific powers of the Ligurian queens, that the *supply* has kept pace therewith; while at the same time the money value has been lessened. Those who cannot afford to purchase Ligurian swarms, and are afraid of the risk of introducing queens, should either adopt the course recommended on pp. 15, 17, and 72, of Vol. I. of *Journal*, or they should send their stocks to a competent bee-master, who for a fair consideration, say once and a half the cost of a Ligurian queen, would take all the black bees away from them, and stock them with Ligurian bees, giving, in fact, a Ligurian swarm in exchange for a black one, the consideration being simply the value of the better queen, and her extra half cost for the labour.—Ed.

QUERY No. 110.—I shall be thankful if you will tell me how to proceed in the following case. On the top of a round cottage hive I placed a super which the bees have partially, indeed nearly, filled this season. I have attempted to remove the bees from it on several different occasions, but on account of the queen having taken possession, and the consequent presence of brood, I cannot induce the bees to leave. What shall I do? Can I make two stocks in any way? I fear not, as I have no extra queen. Shall I rob the hive and leave the best of the honey in the super for the bees? Your help out of this—doubtless to you—small difficulty will be much appreciated.—W. T. B., *Chichester*, Aug. 25.

REPLY to No. 110.—We almost think it would be better to leave the super on the hive until the brood has hatched out. It is evidently spoiled as a super for exhibition purposes, since if the brood combs be cut out of it, and it be replaced, it is not at all likely that the bees will fill it at this late period, unless the locality and the weather are very favourable indeed.

The pith of the matter lies in the fact that the hive from some reason or other is incapable of affording the cell accommodation the queen requires, and being so constructed as to be incapable of examination internally, neither cause nor remedy can be displayed. It may be that the hive is too small, or that the cells are overcharged with pollen, or it may happen that the combs are full of sealed honey, in either of which latter cases the queen cannot of course use them for breeding purposes. Now if you remove the super and destroy the brood, as is usually done in such cases, the sacrifice of the young bees will be a most serious loss to the colony. If you leave the super as it is, as at first suggested, the brood will hatch out, and as the weather becomes colder the queen will leave the upper story altogether, but in the mean time the bees will have removed every drop of the *unsealed* honey to the

lower hive. They will not touch the honey that is sealed until from some sort of scarcity below they are compelled to do so; and as this cannot possibly happen until long after the brood has hatched, you will be able to appropriate that portion of the store in the usual way. If you wish to obtain the honey *immediately*, the best course will be to remove the super, drive out all the bees from it in the usual way, as if making an artificial swarm from it, fumigate the few which remain, cut out all the comb, and carefully remove all the portions which contain brood or eggs, which should then be placed on the top of the hive in their several respective positions, and a small bell-glass or box placed over them, so that the bees may have access to them and hatch out the young bees now in embryo. This latter should be done quickly so as not to allow the brood to become chilled, and may easily be done if you provide a board thus,—*a* is the feeding-hole through which bees can get up from the hive, the other small holes are for the insertion of pegs somewhat like pencils; *b*, *c*, *d*, are combs of brood standing on the board kept up by the pencils, which being  $\frac{3}{8}$ -inch wood keep the comb the correct distances apart. A bell-glass placed over them, and kept very warm, will be all that is required, the bees will do the rest. The number of pencils would only be one at each end of the combs, the number of holes is to be governed by sizes of comb.—Ed.

#### NOTICES TO CORRESPONDENTS & INQUIRERS.

TO BEE-KEEPERS.—At the Palace Show two of Mr. Cheshire's 'transferring-boards' were exhibited: one was purchased by a gentleman named Jackson; the other was taken away by some one without authority. There being only two of these articles in existence, there can be little difficulty in identifying them; and if the latter is seen in use, or should be offered for sale, it is hoped that information thereon will be immediately forwarded to F. Cheshire, Esq., Avenue House, Acton, W.

R. S.—We have seen the protest of one 'Beaten but not Dismayed,' in the *Journal of Horticulture*. His *nom de plume* should have been 'Scotched, but not Killed.'

REV. W. T. G. KING'S Sherrington hive has been engraved, and will be illustrated next month.

\* \* \* We most earnestly beg that all those who wish to see their exhibits illustrated in the *British Bee Journal* will immediately send us either samples or photographs of their various parts, with a full (and fair) description of their merits. Doubtless many things were exhibited of great merit, which have passed unnoticed from the impossibility of such a description as would be necessary being appended to them, in a form such as the Judges could readily comprehend, and from the absence of 'Commendations' their merits otherwise will not be made known to the bee-keeping world. We should prefer samples when it is convenient to forward them, that visitors to our apiary may see them, in acknowledgment for which we will forward the engraved blocks for illustration in their inventors' catalogues.

We very much regret that owing to great pressure of matter, many interesting articles must stand over until a future occasion.

Those who wish for the Cottagers' Prize Hives are requested to send us their orders at once, as from the impossibility of providing storage for the number likely to be wanted in the spring, there may then be some difficulty in supplying them.

# RULES AND REGULATIONS

OF THE

## BRITISH BEE-KEEPERS' ASSOCIATION,

AS AGREED UPON AT THE FIRST GENERAL MEETING

HELD AT

THE CRYSTAL PALACE, SYDENHAM,

SEPTEMBER 10, 1874.

THE HON. AND REV. H. BLIGH IN THE CHAIR.

I. That the name of the Association be the 'BRITISH BEE-KEEPERS' ASSOCIATION.'

II. That its objects shall be the encouragement, improvement, and advancement of Bee-culture in the United Kingdom, particularly as a means of bettering the condition of cottagers and the agricultural labouring classes, as well as the advocacy of humanity to the industrious labourer, the Honey-bee.

III. That its officers shall consist of a President, Vice-Presidents, General Committee (from whom shall be selected an Acting Committee not exceeding seven), Secretary, and Treasurer. The whole of whom shall hold office for one year, and be eligible for re-election.

IV. That the management of the Association shall be vested in the Acting Committee, of which the Secretary and Treasurer shall be *ex officio* members.

V. The Annual Subscription of Members shall be Five Shillings, due and payable on the first day of May.

VI. The Committee shall cause to be held an Annual Apiarian Exhibition at a time and place they may deem most suitable to the interest of the Association and its objects, and adopt all such things as they believe will most conduce to extend and improve a knowledge of Bee-keeping, so far as the funds of the Association will permit, provided always that they shall in no case contravene a rule made in General Meeting.

VII. That an Ordinary General Meeting shall be holden once in each year, when the Officers for the ensuing year shall be elected, and questions of government of the Association be discussed and resolved upon. An Extraordinary General Meeting may be called by the Acting Committee at any time, and shall be called by the Secretary within fourteen days, upon receipt of a requisition signed by any ten members of the General Committee, stating the nature of the business for which the General Meeting is to be called.

VIII. That as soon, and so far as the funds of the Association will permit, the Committee will endeavour to carry out the objects of the Association by means of lectures, meetings, the circulation of suitable books, certificating and sending out experts as qualified teachers and examiners of apiaries, exhibitions, and circulation of hives and apiarian apparatus, &c., to spread a knowledge of all improvements and best

possible methods of Bee-keeping, and of the most profitable use and disposal of Bee produce; also to establish a model apiary and an apiarian museum and honey market, assist in the formation of Provincial clubs affiliated with the Association, and generally to do all in their power for the advancement of apiarian science.

The code of Rules having been completed, the Meeting proceeded to the election of Officers, and it was thereupon resolved:—

That Sir JOHN LUBBOCK, Bart. M.P. be President.

That the following gentlemen be requested to act as Vice-Presidents:—

Lord CLIFTON.	Sir R. BRISCOE, Bart.
Hon. and Rev. H. BLIGH.	Hon. and Rev. A. LEGGE.
Hon. R. C. TROLLOPE.	F. SMITH, Esq. F.L.S.
Rev. D. W. PENNELL.	Rev. P. V. M. FILLEUL.
Rev. G. RAYNOR.	Rev. W. C. COTTON.
Rev. W. J. STRACEY.	Rev. F. T. SCOTT.
Rev. J. D. GLENNIE.	R. W. PARTRIDGE, Esq.
R. SYMINGTON, Esq.	S. G. LITTELJOHN, Esq.
E. MELLADEW, Esq.	C. E. FLETCHER, Esq.
C. W. SMITH, Esq.	W. CARR, Esq.
S. HOLMAN, Esq.	D. BREEN, Esq.
C. ATLEE, Esq.	W. ABBOTT, Esq.
T. W. COWAN, Esq.	J. M. HOOKER, Esq.
F. CHESHIRE, Esq.	J. SMITH TURNER, Esq.

That the Acting Committee have power to add to the above list any gentleman of position who would be likely to further the objects of the Association.

That the following gentlemen be the Acting Committee, viz.:—

C. ATLEE, Esq.	J. M. HOOKER, Esq.
F. CHESHIRE, Esq.	W. ABBOTT, Esq.
J. SMITH TURNER, Esq.	T. W. COWAN, Esq.
E. MELLADEW, Esq.	

That the President, Vice-Presidents, Treasurer, and Secretary, form the General Committee.

That C. N. ABBOTT, Esq., be Treasurer.

That JOHN HUNTER, Esq., be Hon. Secretary.

That the best thanks of the Meeting be given to the Committee, Treasurer, and Hon. Secretary for their untiring assiduity in the service of the Association, by which its present success has been achieved.

With a cordial vote of thanks to the Hon. and Rev. Chairman, the Meeting separated.



## OUR SALE COLUMN.

—o—

This column is open to Subscribers only, to enable them to dispose of surplus apicultural property.

There will be no charge for advertising, and if the articles be not sold, the advertisement may remain for three months, after which it must be withdrawn, or the prices of the articles reduced.

The names of advertisers will not appear.

All monies must be deposited with the Editor, who will communicate with the vendor, when, if a sale be effected, one penny in the shilling will be charged on all amounts not exceeding one pound, and one halfpenny additional will be charged on every shilling beyond that amount, and the balance forwarded to the vendor.

Should no sale take place, the money deposited will be returned to the depositor, less a uniform charge of fourpence to cover postage.

The carriage of all articles sent must be paid for by the depositor, and if not equal to the description given, the advertiser must pay the cost of their return.

No advertisement must contain more than sixteen words. P. O. Orders to be made payable to C. N. ABBOTT, office of *British Bee Journal*, Hanwell, W., London.

No.	s. d.
20. Glass preserve jars for storing honey or feeding bees, hold one pound, per dozen ... ..	6 6
22. A useful bee house, to hold three hives, in good condition, top lifts off ... ..	24 0
31. Two square wooden hives, 11 by 12, window and feeding hole, price 3s. each, the two ... ..	5 6
35. Very fine Ligurian Stock, imported Queen, straight combs, well painted Woodbury hive, complete ... ..	73 6
36. Plain Quinby box hive, 8 frames, floor and crown board ... ..	8 6
38. The Cheshire twin nucleus frames, the half-dozen pairs, packed ... ..	4 0
39. The Cheshire nucleus hive, thrice painted, fitted with nucleus frames ... ..	6 0
40. A 13-frame Quinby hive, with collateral space, hinged-top and stand, 5 coats of paint ... ..	30 0
43. Mahogany observation hive, suitable for exhibition, holds three frames, double glazed, perfect repair ... ..	30 0
44. Fumigating apparatus, bellows, &c., from International. Been used ... ..	5 0
46. Dwarf feeding bottles, hold a pint each, per half-dozen ... ..	5 0
47. Tough old combs, excellent for guides, per half-square foot (72 inches) ... ..	1 6
48. Four second-hand Woodbury hives, complete, with moveable floor-boards and legs, as new hive, each ... ..	18 0
49. 'Guinea set,' American nest hives, only large one used that has window added and improved ... ..	15 0
50. 'Neighbour's Apiary and Bee Culture.' Published at 5s., nearly new, post-free ... ..	3 6
51. Cheshire nucleus hives, double cased, hinged covers, well finished, 5 coats of varnish, each ... ..	14 6
52. Woodbury, well painted, with distance tacks instead of racks ... ..	10 6
53. Woodbury, with hay-rick wintering case and stand complete ... ..	24 0
54. Hybrid queen, Ligurian mother ... ..	4 6
56. A six-framed double-walled hive, frames Woodbury size ... ..	6 0
57. Neighbour's improved Cottage hive, complete, in first-rate condition ... ..	18 0
58. Large Observatory Unicomb hive, with venetian blinds, both sides holds six frames Woodbury size ... ..	35 0
59. Mahogany Unicomb hive holding three Woodbury frames ... ..	25 0

## SALE COLUMN—CONTINUED.

No.	s. d.
60. Bee-house to hold two hives, folding-door at back ... ..	18 0
61. Addy's ten-frame super ... ..	5 0
62. Glazier's diamond—very good one ... ..	10 0
63. Bee-house for 6 hives, divided into 3 compartments, with hanging doors ... ..	60 0
64. Stock of pure Ligurian bees, in Woodbury hive ... ..	80 0
65. Five dozen queen-boxes, with frame in each ... ..	15 0
66. The Abbott-Quinby hive, double-cased, glass front, 13 frames, two division-boards, in good condition ... ..	15 0
67. Rough, unplanned box-hive, Woodbury size, 10 frames, useful for transferring contents of skeps to, each ... ..	5 6
68. Nucleus hives, for Cheshire twin frames, each ... ..	4 0
69. 'Tayler's Manual of Beekeeping' ... ..	3 0
70. 'Neighbour's Bee-book' ... ..	2 6
71. 'Huish's Bee-book' ... ..	2 6
72. 'The Female Monarchy.' By Rev. John Thorley ... ..	2 6
73. 'Bevan on the Honey-bee,' last edition ... ..	5 0
74. Muphey's Honey-extractor, imported from America ... ..	80 0
76. The Woodbury hive, with outside cases, super and cover complete ... ..	20 0
77. A new frame hive, with five supers, to be exhibited at the International Show, ... ..	24 0
78. A Honey-extractor, lately received from America, similar to those sold by Neighbour at four guineas, price. Staines ... ..	50 0
79. Abbott's new frame-bar hive, reversible floor and crown boards, super cover and roof—no supers ... ..	30 0
80. A Huber leaf-hive, 12 frames, all hinged back and front, tunnelled floor-board, glazed ends, best make, been in use but sound ... ..	42 0
81. A Pettigrew hive, quite new, 18 in. dia. ... ..	4 0
82. Some beautifully white honey-comb of this year, per lb. Exeter ... ..	1 6
83. Levett's 'Ordering of Bees.' Sm. 4to. morocco, 1634, in good condition ... ..	50 0
84. A stock of hybrid Italians, in Woodbury hive, with glass double windows ... ..	30 0
85. A ditto, ditto, in straw hive, with hole in top, two years old ... ..	20 0
86. Four hives of pure Ligurian bees, from 50s. each to ... ..	63 0
87. Seven bell glasses, 8 in. London ... each	1 6
88. Super-honey from Palace, run into jars, any quantity, per lb. Droitwich ... ..	1 6

**PRIZE** awarded Mr. ALFRED RUSBRIDGE, at the CRYSTAL PALACE GREAT BEE AND HONEY SHOW, for a splendid Super of Honey in Class XIII. the produce of bees under his system of management. The average yield from each hive during the past season is upwards of 58lbs. of pure white honeycomb. Judge of the merits of a system of management by the results obtained.

Box-hive (14½ in. square × 12 in. high), with super to match (to contain 30lbs.) sent to any address, free of railway charge, on receipt of P.O.O. for 21s. Best materials only used. Every article of the highest finish, well painted, and warranted to last a lifetime.

A Complete Set, comprising three boxes furnished with every requisite, and moveable roof, well painted, and oak stand, for 44s., delivered, carriage paid, to any station on the London and Brighton line.

Additional particulars on application. Address,—  
ALFRED RUSBRIDGE, Inventor and Manufacturer,  
Sidesham, Chichester, Sussex.

Now ready, 8vo.

**THE FIELDS OF LITERATURE.**

An Allegory. By ALFRED RUSBRIDGE. Plain, 1s.; cloth gilt, 2s. 6d.; per post, 1d. stamp extra.

'This little work is very well and cleverly written, and is calculated to promote the end for which it is designed. As an allegory it is necessarily an effort of the imagination, but it affords us a sensation of pleasure as we follow the leading idea to its goal.'—*Civil Service Gazette*.

THE

# British Bee Journal,

AND BEE-KEEPER'S ADVISER.

[No. 19. Vol. II.]

NOVEMBER, 1874.

[PUBLISHED MONTHLY.]

## Editorial, Notices, &c.

### NOVEMBER.

Now that bees have retired to winter quarters, it behoves the bee-master to take all possible care that their domiciles are well protected from the inclemencies of our variable climate, and prepared to withstand the effects of the forthcoming wet and stormy season. Stands should be thoroughly examined, or, through the silent effects of time, they may be found not sufficiently strong to withstand the effects of the winter blast, and stocks may thus be thrown to the ground during a hurricane, and so damaged with cold, and rain or snow, as to become worthless afterwards. Roofs also should be looked to, that there may be no cracks or crevices through which the rain may find its way down into hives, chilling their inhabitants, causing the combs to become rotten and mouldy, and laying the foundation of disease which may destroy entire colonies. Entrances to hives should be narrowed to protect the bees against enemies, and to keep out as far as possible the winds which are likely to prevail, and which might carry the snow or rain with which they may be charged into the interior, and thus lower the temperature in an excessive degree. It must, nevertheless, be borne in mind that air is necessary to bee-life, and that in an unventilated hive, narrowing the entrance interferes very much with its ingress, and at the same time hinders the egress of that vitiated by the bees through their natural breathing; and consequently during such weather as may confine the bees within their domicile, or prevent their adopting their usual method of ventilation, viz. by fanning at the entrance, *upward* ventilation is indispensable. In a bar-frame hive this is best effected by removing the crown-board, clearing the tops of the frames of the honey or wax which may be found there, and placing in its stead a covering of porous material which is usually called a 'quilt,' through which the heated watery vapour given off by the bees may escape, and not, as is otherwise usual, find its way to the cooler parts of the hive, and there con-

densing cause a moisture, which is the almost certain forerunner of dysentery.

*Dysentery and Foul-brood* are diseases which are so closely allied that we hope to be pardoned for here expressing our conviction that they both have the same origin. Dysentery attacks and destroys the adult bees; foul-brood attacks and destroys the larvæ in the cells, and in both cases the poison is known to be in the food. The bees partake of the food, and are attacked by what is equivalent to diarrhœa; and if, from stress of weather they are unable to take their necessary cleansing flight, they burst and die on the combs, causing a stench which permeates the whole hive, and appears to create a kind of typhus in the colony, which rapidly depopulates and brings it to ruin. The condition of hive, which renders the food sufficiently poisonous to cause dysentery and death amongst the adult bees, does, in our opinion, if the evil be not checked, render the food so much more poisonous that its partial digestion by the nurse-bees fails to remove the virus, and the larvæ die in their cells through being fed upon the unwholesome chyle administered to them by their foster-mothers. It is well known that amongst animals, improper food taken by the mother may cause disease or death to her young, either before or after birth, and we believe the cases are sufficiently analogous to warrant the deduction arrived at. Dysentery, however, is now our subject, and how to prevent it is what we are most anxious to point out, since it is the only really serious disease to which bees are liable during the cold months of winter; but being possibly, and as we firmly believe from much experience, the breeder of the worse disease foul-brood, the 'question how to prevent it' is of really vital importance to an apiary. Dysentery is more easily prevented than cured; and if we look for some of the causes which produce it, and, when recognised, endeavour to avoid them in the future, we shall really be adopting the very best means of prevention.

One of the most fruitful sources of the disease is the practice which so generally obtains, of rapid autumn feeding, thereby filling the hive with an excess of moist food, often consisting of common brown sugar and beer, which

most of our readers will agree may be kept very well when bottled and properly corked, but which is anything but agreeable after a few hours' exposure. The bees would bottle it in their cells and seal it if they had time to do so, but such a quantity as is sometimes administered it is impossible for them to deal with; and it becomes sour and stale, and perhaps, being in contact with pollen, fermentation commences and spreads throughout the hive, or, containing as it does the elements of fermentation in its own body, can it be surprising that the bees that partake of it become distended and dysenteric, or that the usual consequences ensue as above stated?

A second cause may be the collection and storage of a large quantity of thin and watery honey, at a late period in autumn, when indeed it is too late for the bees to evaporate it and seal it over; this, then, is liable to become sour, or if not, the bees in consuming it take larger quantities of water into their systems than they require, which must either be turned into vapour by their clustering, or, if confined to the hive by bad weather, the bees will become unhealthy.

A third cause, and a common one, consists in the folly of building hives with open space above the frames. The bees constantly protest against it, and cram it with honey-comb or propolis, yet the bee-keeper will not take the hint, but every time the crown-board is removed prefers to cut away and waste the labour of many days; which the bees, as soon as the crown-board is replaced, spend much time and material in replacing. Sometimes, so thoughtless are bee-keepers that they remove all the comb, &c. with which bees fill up this obnoxious crown space, at a period when it is too late for comb-building, and as a consequence the heated vapours from the clustering bees become diffused under the crown-board, where they condense, and, forming large drops of dew, fall into the bees or combs, rendering the whole, damp, cold, and unhealthy. The bees in such a hive from constantly losing the heat generated, find it necessary to consume more food to keep heat and life within them; and if cold weather should continue, dysenteric distension and death will most certainly ensue, the bees often bursting in the hive and smearing the combs, brood, and other bees with a foul yellowish-brown mucus, which emits a filthy stench, which soon taints the whole contents of their domicile, causing the disease to assume its worst form, and the hive to become a mass of pollution.

There are other causes of dysentery, but enough has been said to show its virulent nature; and perhaps a few words to describe the symptoms by which it may be known to

exist in a hive, may not be out of place at this moment. In cold weather, it is not easy to detect the disease, as the bees will be up amongst the combs in the brood nest, and it is therefore a good plan to make a daily search over the floor-board, with a wire bent at one end in the form of a hook, to ascertain if there are any, or many dead or dying bees lying thereupon, and if more than three or four be found at each visitation, the existence of disease should be strongly suspected.

In some cases, symptoms of the disease are exhibited by one or two distended bees crawling to the entrance of the hive, moaning audibly, and evidently wishing to fly; yet deterred by the weather, they creep about in an undecided way, evidently ill at ease, repeatedly visiting the entrance, and perhaps occasionally one may attempt to take wing, but probably will fall to the earth; occasionally one may venture sufficiently long on the wing, to discharge itself, but the mucus being of a tenacious character adheres to its body, and is brought back to the alighting board, where it clings, when the bee releases itself, and re-enters the hive. The appearance of mucus on the alighting board, or about the entrance of the hive, suggests an unhealthy condition of the inmates, but is not always a positive sign of active disease within, nevertheless it ought not to be disregarded. The most certain sign of dysentery is the repeated appearance on the alighting board of numerous dead and dying bees in a state of distension, which have been thrust just outside the hive. If these be disregarded, the entrance will be shortly blocked with them, and suffocation will put an end to the colony. The course of treatment usually recommended is to exchange the floor-board, giving a clean, dry, and warm one in lieu of the foul one, and to give the bees some fresh, wholesome food; and this would be a very good thing if the bees could be persuaded to take it, and if it would counteract the poison in the food remaining in the hive, which it will not do, and therefore it would appear necessary that the hive should be invaded, and the combs operated on with the extractor so that all *unsealed honey* might be removed. This may appear a desperate remedy, but we are convinced that it is the only safe one. In almost all cases of dysentery, the combs and hive will be found to be wet and perhaps mouldy, and it will hardly be necessary to suggest that after 'slinging,' a few sealed cells should be opened, the combs put into a clean dry hive, and the bees permitted to take possession.

The fact asserted that the poison is in the food, is best proved by another fact, that as soon as bees can be induced to take food in the form of freshly made syrup, or honey from other

hives, the disease is at once stayed, and the surviving bees recover. That the disease is generated within the hive is also proved, because it does not make its appearance until the bees are confined by stress of weather, and forced to cluster in their winter's nest so that they cannot renovate the air in the hive, nor get rid of any disagreeable matter that may offend them.

Taking all these matters into consideration, we affirm that if rapid autumn feeding be avoided,—if late watery honey be extracted,—if the open spaces in the hive and above the frames be dispensed with, (and we would also prevent the escape of heat round the ends of the frames),—if a proper system of upward insensible ventilation be secured, and if the hive be well protected from cold, rain, and snow, dysentery will be impossible.

The *Quilt* properly applied is of all crown covers for hives the very best for winter use, because it permits the escape of all noxious vapours from the hive, as soon as they are generated. The quilt arrangement comprises a piece of carpet or other material of hard texture, with a hole in the centre for feeding purposes, two or three thicknesses of felt, flannel, or other porous materials, each also having a hole in its centre of similar size as that on the carpet, a piece of perforated zinc or vulcanite as a feeding stage, a pad like a kettle-holder to lay upon the vulcanite, and a folded sack, blanket, or rug laid upon the whole, after which the roof may be put on, and should be fastened to prevent it blowing off. We have had the quilt arrangement in use during the whole of the past season, we have not now a single bar-frame hive without it, and we never intend to use a crown-board again. We assure our readers that during the whole of our experience with this 'new invention,' we have not had one article of the 'bedding' attacked by moth, nor during the whole period has the slightest inconvenience arisen through using them.

If *closely* covered, the whole arrangement will become 'sopping-wet,' simply because the vapours *cannot escape*, but this only proves its value when properly disposed, as it shows that the vapours would escape *through* it if permitted to do so.

#### THE SHERRINGTON HIVE AS IT WAS, AND IS.

This excellent bar-frame hive was illustrated and described in its original form in the *Journal of Horticulture* of January 11, 1872, and from a communication which appeared in that journal a fortnight afterwards, its invention appears to be due to the Rev. T. W. Goddard of Sher-

rington, whence the hive takes its name. The inventor says (quoting from the above), 'Since the time when Mr. Golding said, "without bars there is something wanting, something wrong," everyone must have desired a bar hive. I have used for some time frames let into round straw hives, somewhat after Mr. Taylor's plan; made cheaply enough by the village carpenter, but the result has not been satisfactory, in that the bars of one hive would not always fit the niches of another. I have, therefore, schemed a square straw bar-hive, and I am glad to be able to recommend it as combining three great advantages:—1st. The frames with ordinary care last a lifetime, and the straw-work can be renewed from time to time at an expense of 2s. 6d. or 3s. by any local worker in straw, the hive becoming indestructible. 2nd. The hives can be used in the open air, as well as in a bee-house. 3rd. The price of the hive is only 10s. It is impossible (continues the inventor) in a few words and without drawings in detail to describe the little contrivances which make the whole so complete; but no one, I am sure, will regret the experiment of procuring one from King & Son, Stoke Goldington, near Newport Pagnell, who make them. I hope this will help to bring bar-hives within the reach of cottagers for whose instruction alone I was some years ago induced to keep bees.'

When the foregoing was written, the Sherrington hive was a plainly made article, the top and bottom edges, consisting of square-framed wooden rims supported and kept in position by iron rods firmly screwed at each angle, which formed the skeleton of the hive. Its sides were ingeniously filled up with twisted straw-work made in the ordinary form of 'bands' such as trusses of straw are bound up with; and sewn together with cane, as in the ordinary straw skep, the chief feature in which consisted in the fact that the angles were kept square inside, no easy feat to accomplish, one would think, with twisted straw bands. Even in its first form it was a good hive, but whether from want of appreciation by the cottager, or from the improvements effected in it rendering it more expensive, we cannot say, but it speedily assumed the form shown in the engraving, No. 1, measuring 14½ inches in width, 14 inches from front to rear, and 12 inches in depth, the price being 16s. Internally it was fitted somewhat like the Woodbury hive, having ten frames, but its designer very sensibly dispensed with the notched rabbets and the bottom rack, usual in the latter, which are such great hindrances to manipulation; the rabbets were there, but they were simple and plain, and sufficiently shallow to permit of the top surfaces of the frames remaining flush with

the top of the hive, an arrangement, that for use with the quilt, that best of all crown coverings, was unexceptionable. We have just had an opportunity of inspecting one of these hives, which had been occupied by bees for a period of two and a half years, a swarm having been placed in it in May 1872, and from the quantity of honey with which it was stored, the straightness of its combs, and the quantity of bees and brood in the hive, we have no hesitation in saying that as a bee domicile the Sherrington Hive is second to none. During

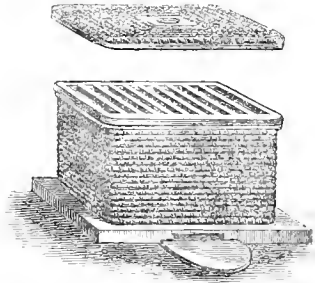

No. 1.—Sherrington Hive as it was.

the year 1872, it appears no honey was taken from the hive, it being considered sufficient only for the winter use of the bees. In the following year, a large super, 14½ square and 6 inches deep, was placed upon it, but, through the ungenial weather, no quantity of honey was stored in it, although a considerable portion of comb was built, and its owner considerably left its contents for the use of the bees. This year results have become different, and the colony attained great weight; hearing of which, we volunteered to remove the super and to extract the honey from the stock hive, having a great desire to see how the Sherrington had behaved in the hands of an amateur. On removing the super, the straw crown cover (which, by the way, was constructed to leave an air space of about an inch above the frames) was found to have sunk down in the centre, so that it actually rested upon the frames, except near the walls of the hive, but left a hollow vacancy between it and the bottom board of the super that weighed upon it, which vacancy the bees had closed with a curtain of propolis, and so formed a means of passing to and fro, between the hive and super. This sinking of the crown of the hive was doubtless a good thing, having regard to the stock apartment, as it prevented the heat of the hive from dispersing above, and over the frames, but it showed a defect in the construction of the crown cover, which ought not to have existed.

On removing the last named article, the space above the frames, near the walls of the hive, was seen to contain combs filled with honey (as is usual), and the frames were found running

across the hive instead of from front to rear. With many persons this may appear of little moment, but it proved, in this case, to have been very inconvenient to the bees. On attempting to move the frames, it was found that they had been made a little too large, for they almost fitted the inside of the hive, and nearly reached the floor-board, leaving no room for the bees to pass either round or under them, and consequently every one of them was glued fast with propolis to such an extent as to render their removal a work of the greatest difficulty and danger to the bees, to say nothing of its irritating effect upon all concerned. The ten frames were, however, removed, and eight of them were found to be filled with sealed honey (and pollen), the other two containing large patches of brood in all stages. Between the combs at the back of the hive, masses of dead drones were found, which, from the frames running across the hive, and being so close to the floor-board, the bees had been unable to remove, and as is customary with bees, not liking loose lumber in the hive, they had propolized them together in rolls of the size of one's finger, as they lay on the floor-board between the bottom rails of the frames; where they had become quite dry and brittle.

The combs were built straight and well within the frames, except at one corner of the hive, where two were, as it would seem, whimsically joined, one end of the ninth comb from the front being suddenly widened, sufficiently to fill both its own and the tenth frame at that point, and to cause some trouble in separating them. Some of the combs were damaged in removal, so severe was the wrenching necessary to get them out, and after 'slinging' and being nicely refixed, it seemed almost a pity to replace them in the hive, to be subject to like treatment on a future occasion.

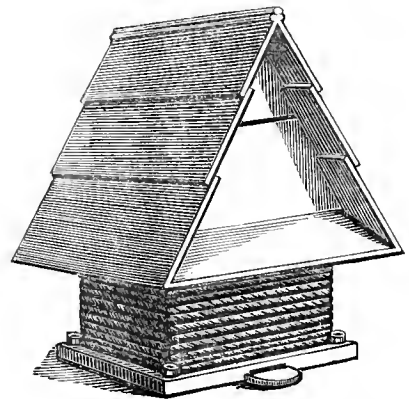

No. 2.—Sherrington Hive as it is.

The yield of honey was, however, very large, and but for the inconvenience in manipulation little need be said against the hive, since

the wrong direction of the frames, and the consequences arising therefrom, were the result of an error on the part of the 'helper,' who placed the swarm on its stand.

Turning now to the Sherrington 'as it is,' we have the greatest confidence that in future all these evils will be avoided, and it affords us unmingled pleasure to be enabled to point out the improved features which will render it a hive, capable of easy management and manipulation, and will prevent the waste of bee labour in producing so large an amount of propolis, as was necessary in the old pattern to stop up the crannies into which the bees were unable to creep. First, then, the crown-board is *improved* off the hive altogether, and the hive adapted for the use of the quilt, and the rabbets on top of back and front are also dispensed with, and the walls are kept perfectly smooth and level on the top, the frame-bars are made of the pattern indicated in the *Journal*, and as shown in engraving, keep their own distance; they are further improved by the absence of the bottom rail, so that they cannot be glued to the bottom board of the hive; the *ends* of the frame bars

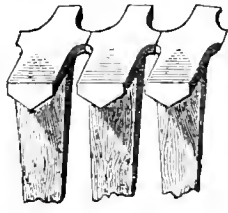

are tapering as indicated, and due regard being had to the necessary space between *them* and the front and back of the hive, there will be no propolis beyond what generally takes place in straw hives, through the irregularity of their surfaces. For keeping the frames in their places, they are furnished with a stud

at each end, which, working in grooves at the back and front of the hive, prevent longitudinal, without impeding their lateral mobility. As they do not rest on rabbets, but fairly on the back and front of the hive, they are kept in their places laterally by moveable strips of wood, one on each side, which are laid upon the side walls, and by an ingenious arrangement of brass hooks and eyes are easily, and well, and firmly fixed, so that the frames become perfectly rigid, yet by the removal of the side pieces, a little lateral movement is permitted, which is one of the greatest necessities in bar-frame hives. The hive is now furnished with a tunnelled floor-board which projects sufficiently all round to receive an outer case, should the hive be taken to a situation where such protection is deemed essential. It is kept down on the floor-board by four clips which may be unscrewed from

above, and so ensure its being rain-proof. It is surmounted by a weathered roof, which, while it will keep the hive snug and dry, will form also a *super* story, capable of receiving a pile of those pleasing evidences of profitable bee culture, in anticipation of which an adapting board is provided, which will take the place of the quilt, and being slotted affords all the necessary accommodation.

### THE BEE QUIETER.

This smart little affair attracted considerable attention at the Crystal Palace Show, and, although it did not obtain the prize, it has become a general favourite as a 'smoker.' It is the invention of, and was exhibited by, the Hon. and Rev. Henry Bligh, of Nettlebed, Oxford, whose lively interest in all that pertains to bee-culture is so well known to readers of this *Journal*. Since its first introduction it has been improved by the introduction of a wire grating to the inner end of the nozzle, as shown in illustration, which grating turns upon a pivot; and while permitting the introduction of the 'smoke-ing' agent, prevents the possibility of its being drawn into the bellows, as *was* just possible in the original pattern.

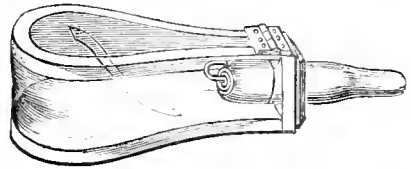

When an article has been brought before the world with a specific intention, it is sometimes both astonishing and amusing to see how it is seized upon as the very thing which has long been wanted for an entirely different purpose, and so the Bee Quieter will become a Vermin Asphyxiator and gardener's friend, for which purpose as a smoke-producer it appears to be well adapted.

It has just the kind of bellows arrangement which is required for bee-fumigation, as the fumes discharged from it, passing twice through the lighted 'agent,' become saturated to the fullest extent with its 'quieting' essence, and may be said to be undiluted, and consequently most effective. An addition in this respect is, we believe, contemplated: but as it is, it can be adapted to the ordinary tin fumigator.

### MR. CHESHIRE'S TRANSFERRING BOARD.

This invention, for which an extra prize of 1*l.* was awarded at the late Crystal Palace Show, is well worthy the attention of all those who intend to transfer their combs from straw

skeps to bar-frame hives. It was repeatedly exhibited in operation at the great Show, where many stocks were successfully transferred. The bees are first driven from the skep, which is carried into a closed room, the latter is then cut in twain between the combs, or the sides are cut away, leaving the combs standing on the crown of the hive; the combs are then cut out clean and whole, and laid upon the teeth of the apparatus, a frame is applied, the comb trimmed to fit it, a piece of lath is placed at the bottom of the comb, and tapes are passed under it between the teeth, and tied round the comb and top bar of frame; the apparatus is raised up so that the teeth become perpendicular, which of course raises the frame also, and the latter is placed in its hive without the comb having been disturbed or in the slightest degree damaged after being first laid upon the transferring board.

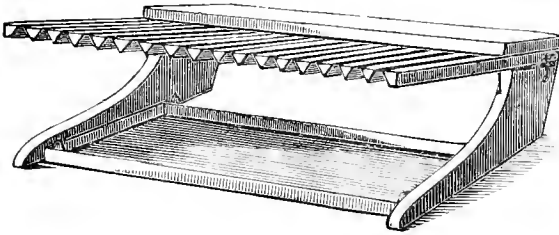

The apparatus includes a square zinc dish which lays under its teeth to catch any bleeding honey which may drip from the combs, and altogether it is a neat and handy tool.

If it had been made rigid as it appears, and as it is when in use, it might be objected to as being an awkward thing to carry about; but, on the contrary, it is exceedingly portable as the feet fold inwards close up under the teeth, and the dish being furnished with wire loops, which fit on to the upper side of the teeth, the whole may be condensed into a package only one inch and three-quarters in thickness. We cordially commend it as a most useful apicultural appliance.

*Combs.*—The cells of the combs, as built by the bees, have all a slight inclination upwards, the better to retain the honey stored in them in its liquid state. In attaching guide-combs to the frames, care must therefore be taken, especially when broad pieces of comb are employed, to give these the proper adjustment; that is, to preserve the upward inclination of the cells in each piece. This will greatly facilitate the further extension of the combs by the bees. The bees will, indeed, use combs improperly adjusted in this particular, though with some reluctance evidently; and there is always more or less tendency to irregularity.

*To Clarify Honey.*—Honey may be clarified by placing the vessels containing it in hot water, and skimming it as long as any scum rises.

## Correspondence.

\* \* \* These columns are open to Subscribers, so that their queries, replies, correspondence, and experiences, may be fully and faithfully recorded; and for the discussion of all theories and systems in Bee-culture, and of the relative merits of all hives and appurtenances, that the truth regarding them may be ascertained. The Editor, therefore, must not be expected to coincide with all the views expressed by the various writers. All Correspondence is addressed to the Editor.

### SIR JOHN LUBBOCK'S OBSERVATIONS ON BEES.

I make no apology for bringing under the notice of the *Journal* readers an abstract of the paper of Sir John Lubbock to the Linnean Society on Bees and Wasps, a copy of which has been kindly furnished to me by its author. Premising, then, that the object of Sir John seems to have been to ascertain what, if any, power of communicating intelligence one to the other is possessed and used by bees, also their power of distinguishing colour and sound. In experimenting to determine these problems some very interesting facts came to light. The observer procured an observatory hive, which, in addition to the usual entrance, had a little postern door which could be closed at will. The hive was placed in the window of the room. A little honey was then exposed on a table in the room close to, the postern door opened, and a marked bee, No. 2,

At 7.0 came to the honey: 7.5 went back to the hive.

7.12	"	7.22	"
7.24	"	7.30	"
7.42	"	7.46	"
7.52	"	7.57	"
8.5	"	8.9	"
8.15	"	8.20	"
8.26	"	8.30	"
8.40	"	8.44	"
8.55	"	9.0	"

Closed the door till 10.15; however, she came round to the honey through an open window, but could not find her way back, so was put into the hive.

10.15 back to honey: 10.17 she went back to the hive.

10.20	"	10.23	"
10.30	"	10.33	"
10.50	"	10.55	"
11.1	"	11.6	"
11.17	"	11.23	"
11.33	"	?	"
11.45	"	11.50	"
12.0	"	12.3	"
12.10	"	12.15	"
12.24	"	12.30	"
12.37	"	12.43	"
12.52	"	12.56	"

Similar observations and tables are recorded with other marked bees, and it was noticed that scarcely any unmarked bees came to the honey. The author remarks that in these cases, the postern being small and on one side, was not very easily found. If the honey had been in an open place, no doubt the sight of their companions feasting would have attracted other bees; but the honey was rather out of sight,



being behind the hive entrance, and moreover only accessible by the narrow and winding exit through the little postern door. However exposed the honey might be, similar results were found, unless the bees were visible to their fellows. The following table, amongst others, tends to show that bees which have found a supply of sweets do not tell their fellows of the discovery :

9.45	bee No. 10	came	9.50
10.0	" 10	"	10.3
10.18	" 10	"	10.21
10.26	" 11	"	10.30
10.30	" 4	"	10.35
10.36	" 7	"	10.45
10.46	" 4	"	10.52
10.49	" 7	"	10.52
11.0	" 7	"	11.9
11.5	" 4	"	11.9
11.11	" 7	"	11.16
11.21	" 7	"	11.29
11.22	a strange bee	"	"
11.26	bee No. 4	"	11.31
11.30	" 7	"	11.39
11.30	" 10	"	11.36
11.40	" 4	"	11.45
11.45	" 7	"	11.50
11.47	" 10	"	11.59
"	another strange bee	came	"
12.1	bee No. 4	came	12.6
12.2	" 7	"	12.8
12.3	" 3	"	12.7
12.4	" 10	"	12.7
12.14	" 7	"	12.18
12.17	" 4	"	12.21
12.24	" 7	"	12.31
12.30	" 10	"	12.33
12.36	" 7	"	12.46
12.37	" 4	"	12.44
12.37	" 10	"	12.40
12.45	" 10	"	12.49
12.50	" 7	"	12.54
12.50	" 4	"	12.54
12.53	" 10	"	12.56
12.57	" 7	"	1.0
12.57	" 4	"	1.2
1.0	" 10	"	?
1.2	" 7	"	1.6
1.9	" 4	"	1.12
1.10	" 8	"	1.16
1.10	" 7	"	1.16
1.16	" 4	"	1.19
1.17	" 5	"	1.21
1.20	" 7	"	1.24
1.20	" 8	"	1.25
1.21	" 4	"	1.24
1.23	" 5	"	1.27
1.29	" 4	"	"
1.29	" 7	"	"

While the marked bees came regularly, only in two cases did any unmarked bees come to the honey.

We are in the habit of concluding that bees seldom lose themselves, but Sir John's observations tend to show to the contrary. He notes as an instance:—

Aug. 8.—At 6.50, a bee came out through the little postern door. After she had fed she evidently did not know her way home; so she was put back.

At 7.10, she came out again. Was fed and put back.

At 10.15, came out a third time; and again had to be put back.

At 10.55, came out again, and still did not re-

member the door. Though the observer was satisfied that she really wished to return, and was not voluntarily remaining outside, still, to make the matter clear, he turned her out of a side-window into the garden, when she at once returned to the hive.

At 11.15, she came out again; and again had to be shown her way back.

At 11.20, she came out again, with the same result.

When, however, at 11.30, she came out for the seventh time, after feeding she returned straight to the hive.

At 11.40, the same result.

At 11.50, she came out, fed, and returned straight to the hive; she then stayed in for some time.

At 12.30, she came out again, but seemed to have forgotten the way back. After some time, however, she found the door and went in.

Similar experiments were recorded; and it was even observed that those who seemed to know the postern, if taken near the window, flew to it and appeared to have lost themselves. From these experiments an inference is drawn that bees do not communicate the intelligence of food to be had, or bring other companions to help to gather in the prize; but she is no idler herself, making a journey about every thirteen minutes for five or six hours at a stretch, a little over four minutes being occupied in gorging, the remainder, in travelling, and disgorging—food being close to home.

Sir John does not express a favourable opinion of a bee's intelligence when in a difficulty; one placed in a bell-glass, 18 inches long and 6½ in diameter, placed with the closed-end to the window, found a secure prison for a whole hour, the bee being unable to discover an exit; some others, however, in a similar predicament found their way out in a much shorter time. The difficulty here encountered being, doubtless, the inability of the bee to comprehend that a transparent substance like glass could be a barrier, as it was accustomed to find a free passage to the light. If the closed-end had been darkened, without doubt the bee would at once have turned 'to the right-about face,' and joyously flown home.

The patient experimentalist, in the course of his inquiries, came to the conclusion that bees were much less clever in finding things [food] than he had expected; a saucer of honey put between flowers, on which bees were busy, being unvisited, although honey put on the flowers was eagerly taken. Honey in a room, 3½ feet from a window, on which bees were numerous, being unvisited—the latter I understand, the bees being bewildered from their inability to get out; also, perhaps, the bees were already filled to repletion; but I cannot understand the former, nor what follows: honey placed in a hollow in the garden-wall, 64 inches from the hives, not being found by the bees the whole day. On three other days the experiment was repeated with the like result.

I have occasionally found the same indifference, but rarely. As a rule, if I walk into the garden with honey or syrup in my hand, the bees plague me by their eagerness to begin the feast; and on a fine day I don't think I could hide an open vessel of honey anywhere in the garden without finding the

bees regaling on it within an hour, and probably much less. I must say that I find Ligurians much better foragers than the English bees—nearly always being first to begin.

The experiments made to ascertain if bees can distinguish colour I look upon as very interesting. Sir John comes to the conclusion that they certainly can. He placed some honey on slips of glass, resting on black, white, yellow, orange, green, blue, and red papers; a bee, which was placed on the orange, returned twenty times to that slip of glass, only once or twice visiting the others, although the position and also the honey were moved. The next morning two or three bees paid twenty-one visits to the orange and yellow, and only four to all the other slips of glass. The glass was then moved, after which, out of thirty-two visits, twenty-two were to the orange and yellow. That they can distinguish blue was indicated by the following experiment:—

The colours were ranged in a line, with blue at one end. It was a cold morning, and only one bee came; she had been several times the preceding day, generally to the honey which was on the blue paper. This day, also, she came to the blue; the blue was moved gradually along the line, one stage every half hour, during which time she paid fifteen visits to the honey, in every case going to that which was on the blue paper.

A single experiment, standing alone, is not worth much; and Sir John does not say this was corroborated by the actions of other bees. This question of colour-perception is an investigation easily carried out; and I commend it to the observation of our lady bee-keepers, who are generally blessed with plenty of patience.

A little dab of water-colour, put on with a pencil on the insect's thorax or abdomen, will be found an efficient mark, and not difficult to apply when the bee is engaged feeding.

The sense of hearing Sir John does not deny is possessed by bees; but he tells us that, with the utmost efforts, he could make, with tuning-forks, whistles, violin, or shouting close to the head of a bee, and even at night, when all else was quiet, he never could obtain the least indication that the sounds were heard. Truly the evidence seems pretty strong that, at any rate, the bees under experiments were 'hard of hearing,' if not deaf!—JOHN HUNTER, *Eaton Rise, Ealing.*

### THE CRYSTAL PALACE SHOW.

Our great Crystal Palace Show has come and gone; it has afforded satisfaction and amusement to hundreds and thousands; it has demonstrated to the uninitiated facts which it would have been very difficult to have persuaded them to believe; it has been instructive to numbers of amateur bee-keepers; and, lastly, it has doubtless advanced to a very great extent the cause of improved bee-management throughout the length and breadth of the country.

I think the British Bee-keepers' Association is to be congratulated on the happy issue of their efforts; but I think also that special thanks are due to yourself, Mr. Hunter, and the working committee, to whose untiring exertions our success is to be attributed.

As I have said before, the Show of 1874 has come and gone, and I think it is not too soon to be thinking about the future, and to be making our plans for a still more successful Show in 1875. If we would accomplish this object, we must remember two Latin words *experientia docet*, and be careful that the 'experience' which we have already gained is fully used for the purpose of 'teaching' us how to improve for the future. It seems to me, therefore, that it might tend to promote the success of our cause, if those who were exhibitors or careful observers at the Show were just to write down some of the thoughts which have occurred to them, whilst thinking over all they saw and heard during those pleasant three days at the Crystal Palace. This is my apology for writing to you now, and I trust that I am not assuming a right to criticise in a manner unbecoming a bee-keeper of very short experience.

I will not occupy your space with many remarks upon the 'dead stock' department. Results alone can be the true test of the superiority of any particular hive or article of bee-keepers' apparatus; and I trust that no exhibitor who may have been disappointed in not gaining the prize, will cast any blame upon the Judges, whose task was a most difficult one, if not impossible, to say which was the best and most practically useful hive or apparatus. Results in time will give their verdict in favour of that which proves itself to be the best, and therefore results should be carefully borne in mind, both in arranging the Schedule and also in adjudging the prizes. But more on this subject presently. I turn to the honey exhibition, and my first feeling is one of regret that neither Mr. Cowan nor Mr. Symington (whose achievements seemed to deserve that they should hand-and-hand have headed the list of successful exhibitors) should have obtained a first prize. Nobody appears to blame, for Mr. Cowan was disqualified by an accident, and Mr. Symington seems to have entered his honey in the wrong class. But at the same time, Mr. Cowan showed us what a large amount of beautiful honeycomb may be produced from a limited number of hives; whilst Mr. Symington fully justified the expectations which have been raised in favour of the American Extractor.

Now for a criticism. I cannot refrain from criticising the large number of prizes, and amount of money awarded to what may be termed in the honey trade fancy goods. Out of sixteen classes, ten are devoted to single supers or thirty prizes, and an amount of 22*l.*, whilst to a general exhibition from one apiary, four classes, twelve prizes, and an amount of 12*l.*, but to the best harvest from one stock only two classes, six prizes, and an amount of 6*l.* 10*s.* I call single supers fancy goods, for I contend that they are not a demonstrative proof that the exhibitor is a skilful bee-keeper at all points. The only skill shown is in the preparation of the super. Put a nicely made super with guide-combs or wax-sheets over any hive you please, and if the stock is strong and there is plenty of honey, the result will most probably be the same.

But who is the most skilful bee-keeper? and who deserves the best prize at the Show? Is not the producer of the largest and best harvest from one stock?

Is not this the aim and object of every bee-keeper, whatever may be his method or system? I would propose, then, that there should be a class which should, as it were, be the centre point of the whole Show. There should be six prizes, 5*l.*, 4*l.*, 3*l.*, 2*l.*, 1*l.*, and 10*s.*, and the following should be the description of the class:—'For the largest and best harvest of honey in the comb, from one stock of bees under any system or combination of systems, provided that it be exhibited as nearly as possible in the position in which it was produced on a fac-simile of the hive, and provided further that there should be a legibly written explanation of the method adopted, the locality, pasturage, dates of swarming, supering, &c., &c.'

Here at once you have a crucial test as to who is the best bee-master, which is the best bee-hive, and what is the best system of management.

It may be objected that the number of prizes, and consequently the number of entries for single supers, will be reduced, but probably the additional entries in this class would more than compensate for this loss. It may be objected, again, that there is no chance for the 'Extractor' which some think is to revolutionize the whole system of bee-management. To this I would answer, honeycomb is the legitimate produce of the bee-hive, but at the same time there should be a special class in which good and substantial prizes should be offered for the best harvest of extracted honey from one hive.

The advantages are manifest. In the first place, a stroll through this part of the Show would prove an immense advantage to those who are to be judges of the hives. Results would most materially assist them in arriving at a just and fair judgment.

Further you would not only provide interest and amusement for the general visitor, but give the most instructive and demonstrative lesson to the whole brotherhood of bee-keepers.

I will only add that it might be worth consideration, whether it would not be better to substitute gold and silver medals instead of money for the first and second prizes; the holders of which would be fairly entitled to the first honours of the show.—HENRY BLIGH, *Nettlebed Vicarage, Henley on Thames, October 19, 1874.*

#### SPECIAL EFFORTS OF THE CLERGY.

It may be assumed, I take it, that the work of the first year's mission of 'our *Journal*,' and the important bee movement, of which it is the exponent, culminated in the 'grand success' of the Crystal Palace Show. And now we are not only launched, but well under weigh for another year's trial trip. From the first you have strenuously solicited the co-operation of the clergy in the humane cause in which you are embarked. And in your own columns, and in those of many other journals of the day, who gave to the world at large such pleasing accounts of the Bee Show, the remark was elicited that a large number of clergymen were present, and conspicuous among the bee-manipulations on each of the three days of the Show. We certainly were there in tolerable force; and, as you are aware, a large proportion of us not as mere novices, but as those who

had been, in their respective spheres, practical and exemplary *bee-keepers*, and had often added pleadings in the cause of bee-humanity to those of their higher advocacy of Christianity:—may I not say, who had been in the habit of making the one the true basis on which to rest the other? I can answer for two, who, twenty-five years ago, set down fresh from the university in country parishes, and scarcely knowing a live-bee from a humble-bee, or a drone from a blue-bottle, embarked in the cause of the busy little workers at their cottagers' doors, and, after for twenty-three years having lost sight of each other, met again and fraternised as old bee-keepers at your Crystal Palace Show. And here comes in the value of the Association to us, and to the cause through us. Hitherto we have had to form *ourselves* into bee-centres, necessarily of small radii, and, excepting here and there, have looked in vain for another centre, whose influential circumference shall reach our own and afford us moral countenance and support. But now you have invited us to gather ourselves together and unite our strength with yours for mutual co-operation; and I have little doubt that my brethren feel as I do, rejoiced that we have so attractive and well-adjusted a centre round which we with our smaller orbits may revolve. For of this fact I deem the gathering of clergy at the Crystal Palace, already alluded to, a sufficient index. Doubtless, too, many of them came away from that show with an increased desire to encourage right methods of bee-keeping, and with better hopes of seeing the system of annual bee-slaughter eliminated eventually from Christian England. For myself I felt the young vigour of twenty-five years ago re-kindle. 'Je reviens à mes premiers amours.' And so I *have* begun afresh. And my object in recording to you my feelings and the consequent action they put me upon, is to afford a suggestion as to a method of which others of our clergy might feel disposed to avail themselves, to promote the humane treatment of bees among their parishioners. What I did was this. On the occasion of the recent decorating of our church for the annual Harvest Thanksgiving with corn, fruit, and flowers, I presented at the west end two supers and a glass of honey, of aggregate weight more than half a hundredweight, themselves adorned with the flowers from whose nectaries the produce had come. And in my sermon on the occasion, I referred to this as an unusual feature in our decorations, but one that was far from being out of place, inasmuch as in the language of Scripture that land which was signalled as blessed of the Lord was said to 'flow with milk and honey.' That one of the purposes in the ordering of Providence of the placing of honey in the nectaries of flowers was to entice bees and other insects like them to the flowers to fructify them, and secure to us the production of the very corn and fruit for which we were now rendering praise and thanksgiving. That besides presenting this 'honey and the honeycomb' as a token of the bounty of our Heavenly Father, I had done it as a kind of protest against a barbarous and inhuman, if not unchristian custom that prevailed among us of destroying the lives of the insects that collect these stores. Well knowing that the bulk of those

who generally owned bees in these parts, had either lost all last winter, or had saved but so few—and those in such poor condition—that all they could do was to endeavour to re-establish their colony by them, without any idea of a honey harvest this year, I assured them that this had been a most prolific year for honey throughout the land, by which all who *preserved the lives of their bees* had largely profited, while at the same time. I was fully aware that in our parish (6 by 4 miles) tons of honey had been produced by a Benevolent God which had never been gathered, for the simple reason that the only insects that *could* gather in that harvest had been systematically *destroyed*. I then briefly alluded to the effort which we, as an Association, to whose assistance the clergy had specially been called, were making to remove the scandal which such a barbarous custom placed on a Christian land; begging all to give the movement their deep attention, and offering myself what further information and advice I could give.

Attention thus drawn to the subject, backed by the stubborn facts of my supers *in esse, versus* no honey-harvest for themselves *in posse*, has stirred inquiry and promoted discussion. Already the effect has been decidedly good. I know of several doomed hives which have been saved; two of our more influential people have declared for conducting their apiaries for the future on the depriving system; the schoolmaster of the parish has started bee-keeping within the last fortnight, to be carried on, of course, on the same principle, and has had his first lesson in transferring from skep to bar-and-frame hive. Those who had already 'put down' (burned) their bees, seem conscience-stricken with the light that has been thrown upon their deed of darkness. To follow up the agitation thus begun, I, as the prime mover, felt I must do something in the way of progress too; and so, finding that the education of bees has been gradually advancing with that of the rest of our population during the past twenty years, while in my own apiary it has been almost standing still, I immediately sent my leading stock to study Italian, under your genial tuition at Hanwell, and I am glad to say that they are now re-established in my garden humming that language with the purest accent. It is their intended mission to teach this new accomplishment to all their bee-fellows in the coming Spring. Then also I hope to add a little Arithmetic chiefly in Multiplication of Stocks, and in the rule of Profit and (*not*) Loss, which must produce Interest in the course of study.

As a result contributing in a small degree to the good of our cause generally, you, Mr. Editor, have two or three more subscribers to the *Journal*, and 'the Association' has two new members from this parish. So that, altogether, you will believe me, and forgive me if I go as far as to say that, in this matter, we, as a parish, are in a sort of Bee-attitude. Of course all are not at once rendered passively quiescent in favour of departing from the time-honoured good (?) old custom, but some raise their voices loudly against 'Christian pity' having anything to do with 'brimstone pit:' and one man on being consulted as to a stock which had given out two swarms this year, was most decided in his

opinion, 'Yer *mun* put *them* beys down, they be grown too *large* to do any good; never mind what t' parson says about young Queen, her be an old un, and a large un too, put 'em all down.' This authority I need hardly say, is a 'scholar.' Another (an *inharmonious* Blacksmith), who, not attending church himself, heard of my advocacy of deprivation without sacrifice of the bees' lives through a third party, met what was told him by saying, 'He be a miracle man, but you may tell him I've put down my beys and mean to go on so.' However, I trust we may get such persons as these into such a minority soon, that their very isolation will effect an influence for better things upon them.

But there is still another small section of our community, unfortunately from among the better informed, who affect the opinion that your humble servant has recently got a bee in his bonnet, and think they find corroboration of their view in the fact that he has so many communications with Hanwell, where they have heard there is an Asylum for persons of that sort.

So you see, Mr. Editor, that this, like every other good cause has among us, as elsewhere, its opponents, and their methods of opposition take varied and often unexpected forms. Still on the whole I feel I have struck upon a vein, which, if worked to its legitimate extent, may tend to effect a decided inroad with considerable prospect of success upon the ignorance and cruelty of the majority of bee-owners in this country. And I throw out the suggestion for others to improve upon. If I have not tired you out, I still have a word or two for some future occasion, as to some other subsidiary means of promoting the same good cause.

And now I must own I have a *penchant* (one of your correspondents might probably translate this 'a sneaking propensity') for the shelter of a *nom de plume*; and so, in raising my voice in advocacy of 'her who speaketh' lessons to us by her acts of industry and providence, and yet fails by the same exemplary conduct to plead successfully for her own life, I will adopt the speaking name by which she was known in 'the land flowing with milk and honey,' and sign myself in her behalf—DEBORAH,—A Voice from Staffordshire.

#### WHAT THE HONEY BEE CAN DO WITHOUT US.

After inspecting the very many and clever contrivances at the Crystal Palace, in the past Exhibition of Apicultural Appliances, and seeing the great yields produced by several experienced apiarians, it may not be uninteresting to give an account of the harvest I took out of an old house, where *no* assistance had been given to the bees.

In the village of Ruislip, Middlesex, lives a Mr. James Jackson; his house is an old one, the north-east front of which is constructed of lath and plaster or the inner and feather-edged boarding for the outer sides, and having stout oak plates to carry the floor-joist of each room. The feather-edged boarding in course of time had become warped, so that bees could take up their abode behind the boarding at any time, which has been done very much to the

discomfort of their landlord, who, having heard that I was willing to take the honey if I could have the bees for my trouble, thought it rather a good joke to invite me to take *his* bees—and I could not only have the bees but their produce also—anything to get rid of them. Little thinking what was in store, I commenced operations 2nd September; and about 17 feet from the ground I found, after pulling away the boarding, a fair stock of bees, with an immense comb, very thick, measuring 42 inches in height and 15 inches in width. I had got it nice and clear to view, determined to exhibit it at the Palace by placing it on a board; but in that I was disappointed, as in taking it down a piece of about 4 lbs. fell off. Much of the comb was unsealed, and its great weight broke it across the middle; the other combs were not so large, but had to be cut to be taken out, and the bees were difficult to hive. I managed to get the queen and about three pints of the workers; but while engaged in capturing the bees the old boarding gave way, and let my ladder through (not into the house, but) into another stock of bees, causing some little confusion; and darkness coming on I covered the second stock up and left them for a future occasion.

They turned out to be a strong stock, with plenty of honey and a little brood, but no leviathan comb. These bees were easily secured; and my work seemed at an end when, on removing a weather-board over the window, a number of bees were seen going into small holes on the underside of the oak-plate, which told plainly that there was another stock inside, under the bed-room floor, between the joists. The first board taken up displayed five beautiful straight combs. We removed more boards, till we had no less than a mass of thirty-one combs side by side, each  $7\frac{1}{2}$  inches deep,  $7\frac{1}{2}$  inches long on top side,  $10\frac{1}{2}$  inches long at bottom, and measuring 5 feet 2 inches from the two outside combs. They were all full of honey, except a very little in the centre, which contained, perhaps, 200 cells of sealed brood. The outside combs were not quite full at the edges; but such a sight was never before seen in Ruislip, and probably never in England. Several neighbours were called in to witness its removal, and the transferring of the bees, *à la* Crystal Palace bee-masters, into a hive by Hobbs, of Hanwell. As at the Palace, of course the country folk were much astonished to think that bees could be *taught to behave so well*, and of course, as per usual, by my not making a noise on being stung, they thought I had used some preventive, and had escaped without the (to me) familiar salute. I had many inquiries for the dead bees, but could not find a dozen in the room.

Having to cut some of the combs to make them fit the frames, and for want of convenience in this rural district, we could not weigh the bulk; but three average combs weighed  $16\frac{1}{2}$  lbs., or  $5\frac{1}{2}$  lbs. each, supposing a gross weight of  $170\frac{1}{2}$  lbs. of honey and comb from the one stock. The total return for this little venture was as follows:—

- 1st Stock.—About 3 pints of bees, with a queen, and 33 lbs. run honey.
- 2nd Stock.—A fair stock of bees, and 54 lbs. of honey, part in comb.
- 3rd Stock.—A large stock of bees, and  $170\frac{1}{2}$  lbs. of honey and comb.

In obtaining this produce there is nothing to boast of, I am aware, as the honey bee did it without our aid, without feeding, supering, or using the Honey-slinger. The first and second stocks do not afford results to call for special remark, but the third and its box-like hive is unusual; yet, probably, some of your readers will tell me I don't know how many stocks perished in the winter while these three only lived, or that the bees have never yielded profit to their owner, or that I have calculated all the contents of the hive without leaving any provisions for the winter; all of which will be correct.

I never yet have tried a hive on the collateral principle; but next year, if I live, I shall do so, taking the dimensions of space occupied by the comb of third stock, the one under the floor-boards, as my guide—5 feet 2 inches long,  $7\frac{1}{2}$  inches deep, and 9 inches from front to back, all inside measurement—an alighting-board the whole length of the hive, and many holes, about large enough for one or two bees to pass in or out at a time; my idea has been that the many holes, and their being small ones (thereby preventing robbing), has had much to do with the large harvest. Of course I do not intend to open all the holes in my hive at first starting, as in the house; but I shall protect all the front with a *feather-edged board* from end to end, and down to within a sufficient space from the alighting-board, letting it overlap and stand out from the holes in the hive. I mean the top to be made of a succession of bars, so that by easing the comb from the sides, if I can make the bees build comb to my guides, I shall be able to get at them occasionally. But *what shall I do with them in the autumn?* I fear the large outer surface, exposed to the cold atmosphere, and only the thin long body of generated heat inside, will much affect my stock during the winter.

I dare say my nephews and nieces will pull me and my hive to pieces, but if they don't like it they have only to say it's—UNCLE WALTER.

#### TESTIMONIAL TO A YOUNG EXPERT.

I cannot allow your son to return home without a line to tell you how well he has done his work here. Though you mentioned him to me as a lad only aspiring to becoming a bee-master, it appears to me that he has already acquired all the knowledge and skill in bee-management that are requisite to be up to the mark of the present day, entitling him to call himself a first-class bee-master. I am sure it would be a very great benefit to persons like myself, who have bees and are anxious to learn how to manage them, if some experienced bee-masters were available to give practical and ocular instruction. If such men were available, they might advertise their visits to certain districts, conditionally on receiving commissions to inspect apiaries in that district in sufficient number to repay them at so much a day; or, perhaps better, at so much per hive. There are, doubtless, many individuals like myself who often wonder why their numerous hives produce so little honey. In my case it has been accounted for, with regard to many hives—some had foul-brood, some had fertile workers, one required combs full of honey

to be replaced by empty ones, to prevent disappointment next year, and another was infested with wax-moth. I write this to you on the chance of your thinking the hint I have thrown out to be worth consideration.

During the few days that your son has been here he has been called to extract a colony of bees from the wall of a granary, which he did successfully, saving the bees and bringing away some 30 lbs. of honey; also two colonies from cottages, one of which he was able to get at. This will show that there are other inducements for a visiting bee-master to make a trip besides the inspection and putting to rights of established apiaries.—P. FIELDING, Colonel, *Sturford Mead, Warrminster, Wilts*, Oct. 3, 1874.

N.B.—You can make any use you think proper of this note.

### THE RENFREWSHIRE QUEEN CAGE.

Before referring to the subject-matter under the above heading, the present writer cannot but express his regret, that engagements elsewhere prevented his being present at the late Crystal Palace Exhibition, to make the personal acquaintance of 'Our Editor,' and the numerous staff of his able coadjutors, besides losing the opportunity of inspecting the large collection of most ingenious apicultural appurtenances.

In the February Number in a contribution on 'Introducing Queens,' I threw out some suggestions for the formation of a queen-cage, so simple that without the smallest agitation of her future subjects, by a touch merely, her majesty might be permitted to pass forth amongst them, and at the same time expressed the hope that 'some such little contrivance may appear at the coming great Crystal Palace Honey Show, win the prize, and become generally adopted.'

In the April Number, your correspondent, Mr. W. Carr, followed suit with a description of his conception of a cage, and kindly favoured us with drawings of it; but, unprejudicedly, thinking there was a greater simplicity of design in my own original idea, and in case any of the hive-makers might not act on the hint, I commissioned Messrs. Rowat of Glasgow to prepare a few, which order they executed with considerable neatness; and my good friend, Mr. Anderson of Dalry, kindly consented to exhibit them; and to allay his fears that our Southern brethren might not comprehend his Northern dialect in their description, I had a quantity of slips printed similar to that appended hereto for distribution; but he, unfortunately, quite lost sight of the parcel,—I dare say, holding in sovereign contempt all such gimcrackereries of the Exhibition, his interest being chiefly centred in the practical results of a hive and system such as that of the Stewarton, capable of yielding honey in wholesale quantity and of the correct placing of supers so near perfection that two or three drone-cells or the slightest tint of difference in shade, imperceptible to the experienced eye, would be all to guide his impartial decision.

I was gratified to find the Judges confirmed my prediction in awarding this cage the prize. It is formed from wire net, it is two inches deep by  $1\frac{1}{4}$  wide, and  $\frac{3}{8}$ ths in thickness, the top of the same material,

and projecting  $\frac{1}{8}$ th part all round as a flange to prevent slipping too far between the combs; the door of wire forms the bottom of the cage, and is opened and closed by means of a wire passing up either corner in front, and wrought through the top. In some there was a circular hole on top with moveable cover, for introducing the queen to the cage. But to any, saving the merest nervous novice, the space between the wires at bottom is amply sufficient for the admittance of the royal person. Some were circular for bung-holes in common straw skeps; but I give the preference to those of the flat form, as they fit the exact space between the combs of any hive. Some, for appearance sake, were constructed of copper wire net; and some, to prevent the rusting of the iron wire, were japanned: but the makers inform me, that were they required in quantity they could specially galvanise wire net for the purpose.—A RENFREWSHIRE BEE-KEEPER.

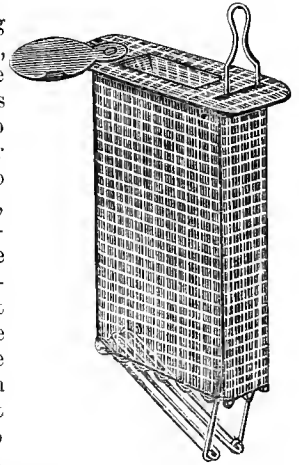

'ADVANTAGES.—From its thickness it fits the unvarying width of space between the combs of all hives alike. The flange portion on top, resting on the frames or bars, prevents it slipping into the hive. In hives possessing slides it is only necessary to divide a central one, drawing the outer portion sufficiently to receive the cage. The queen is to be admitted to the cage through the aperture between the central wires at bottom, while the operator holds it inverted, with the door open, in his left hand, the forefinger and thumb of which cuts off her retreat sideways; she is then shut in, and the cage suspended in the hive. On the lapse of the requisite time (third day) the queen is liberated by simply pressing the top of the wire downwards, which throws the door open, converting it into a gangway by which she walks forth to meet the attendants who have been feeding her, and are familiar with her presence; they form her body-guard, and the risk of encasement is reduced to the minimum. With all cages stuck into the combs, the queen can only be set free after the hive has been opened up, and the workers, being newly and thoroughly disturbed, are in their most irritable mood. Should the pipe-cover cage set in a bung-hole be employed, it is requisite to draw it out and invert it, the attendants clinging to the bottom of the cage are transferred to the outside of the hive, and the queen is forced to stem the upward stream of stranger bees trying to force their exit. This cage permits the queen to be liberated without the smallest disturbance to the hive generally. Unlike cages of zinc, the material of this gives forth no poisonous or deleterious exudations. The simplicity of its arrangement and the inexpensiveness of the material of which it is made, recommend its adoption by apiarists generally.'

### QUEEN-CAGES.

Having successfully introduced to hybrid stocks the eight Ligurian queens received from you at the Crystal Palace Show, also four more which you sent me subsequently, by means of the queen-cage I exhibited at the Show, a short account of the *modus*

*operandi*, and a description of the cage, may prove interesting to your readers. The accompanying engraving represents a front

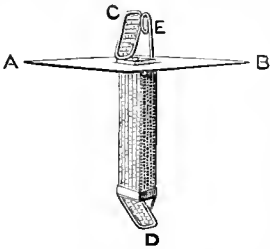

is a square piece of perforated zinc, to a hole in centre of which the cage is fitted, and by which it is suspended through the central orifice in the hive. C is a door opening at the top, and D a similar door at the bottom of the cage. By means of the

wire E, the lower door is opened and shut at pleasure.

I claim no originality for the design. Your able correspondent, 'A Renfrewshire Bee-keeper,' suggested it, with the exception of the upper door, in your February number, page 161, adding, at the close of a most interesting article, 'I trust some such little contrivance may appear at the coming Crystal Palace Honey Show, win the prize, become generally adopted, and save the life of many an aspirant to the hive throne.' Taking the hint, I procured several cages of the above pattern, which I exhibited at the Show, and which I should not have done had I known the intention of a 'Renfrewshire Bee-keeper' to construct and exhibit them himself. My coadjutors, in judging, awarded him the prize, which was perfectly just, his being the original idea.

My hybrid stocks being in bar-frame hives, the queen was taken from each stock, the hive closed, the cage inserted through the centre hole, and the old queen placed in the cage, through the upper door, where she remained about six hours. She was then liberated, and the Ligurian queen, by means of the upper door, without any disturbance of bees or cage, took her place. After an imprisonment of twenty-four hours the new queen was introduced to her new subjects by means of the lower door, again without the least disturbance—in most cases *after dark*. On the following day each insertion was verified; and the thrill of pleasure on beholding twelve new monarchs in succession, safely enthroned, perambulating the brood-combs of large and populous bar-frame hives—such monarchs, too, for size and colour!—will be better realised by old bee-keepers than described by me.

Notwithstanding 'Renfrewshire Bee-keeper's' strictures on fumigation, I still practise it in fixed-comb hives, and have never lost a queen out of many insertions, nor have the bees been in the slightest degree injured by the process:—albeit I have learned at last to 'drive.'

The cage being made of fine wire, in my opinion, has a decided advantage over those made of perforated zinc—allowing much freer communication between the alien queen and the bees, greater warmth, and the more free absorption of the odour of the hive.—GEORGE RAYNOR, *Hazelleigh Rectory, Malton.*

#### QUEEN-CAGE.

The queen-cage I sent you yesterday you will find combines all the advantages of the various methods of introducing queens now in vogue. It may be used as a simple cage, but with this addition, the

queen may be liberated without disturbing the bees around or upon the cage. This you are aware cannot be done with the ordinary piper cover, as it must be pulled out of the comb before the queen can be let out.

You will again find a great advantage in having the sliding door and grooves made of plain metal. There is no danger of cutting off the legs of either the queen or workers, as must be the case where one piece of perforated zinc is drawn over another. The sides of the cage, too, are made of a sufficient depth to allow of their being pressed well down into the comb, and still leave plenty of room for the door to

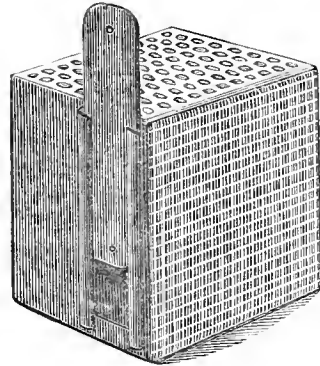

work freely up and down without the edge of it cutting into the comb. The front being made of wire-cloth, admits of a much better view of the inside of the cage than if made of perforated zinc.

For those bee-keepers who have sufficient confidence in their bees to liberate the queen without at the same time observing their behaviour towards her majesty, the cage will be equally useful with those now in the market, as a wire may be attached to the door, and drawn through the feeding-hole, and the door raised—or the cage may be fixed with the door at the bottom, and the wire put through a small hole made with a bradawl in the side of the hive.

I have been very successful with it this autumn, and much prefer it to any I have yet seen. I shall feel obliged if you will try it and give me your opinion.—J. CLEVERE JONES, *Market Drayton.*

#### A BAR-FRAME HOLDER.

I enclose a very rough sketch of an invention which for want of a better name might be called 'The Bar Frame Holder.' Its use will be apparent at a glance,—it is to hold bar-frames when taken out of a hive for inspection. Working on a pivot when one side of a comb has been inspected, the other may be immediately brought into view by gently swinging the machine round. Thus the operator has both hands at liberty. It may either be placed on top of the hive under inspection, on top of an empty hive, or even on a table. I may state that I have found it of the greatest service when searching for the queen-bee. It is the invention of a friend of mine, R. V. De Lisle, Esq. of St. Brelade's, Jersey, and so far as I am aware one in his possession and one in mine are the only two in existence.

I cannot now give dimensions not having mine



here, but it is wide enough to take two combs abreast, and high enough to allow  $\frac{1}{2}$  to  $\frac{3}{4}$  in. under the frame.

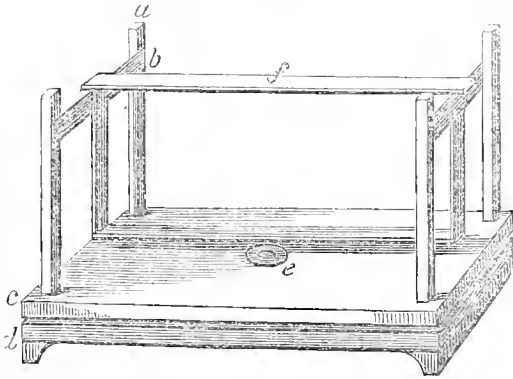

I should be happy to give you any further information about it. I have never known it upset with a comb, and have never seen a bee killed in swinging it round, as they cannot get between the two parts of the base.—D. D. BENNETT, *Bishop Auckland*.

*a* Uprights to support frame.

*b* Thin brass plates fastened to uprights for ends of bars to rest upon.

*c* Base for side supports.

*d* Base resting on hive or table *c*.

*e* Pivot which enables the upper part of machine to move freely upon *d*.

*f* Bar-frame suspended.

N.B.—Washers should be put between *c* and *d* to allow them to swing freely.

#### THE BEST MOVEABLE-COMB HIVE.

It has always appeared to me that the moveable-comb hive, to be perfect, should possess the following necessary requirements:—

1st. The means of fully inspecting the bees and their operations at all times, without disturbing them, by opening the crown of the hive.

2nd. That when requisite to open the hive for any purpose, it should admit of only that portion of the crown being raised where it is intended to operate, so as to disturb the bees as little as possible.

3rd. It should not offer facilities for fixing the bar-frames by propolis; and that the frames should, by their form, provide for the more secure holding of the combs, in case of their slipping from insufficient fixture by the bees, or from heat.

4th. Lastly, that the hive should be adapted for occupation by the bees all the year round.

I accordingly set to work to construct a hive which should possess these qualities; and I think that the one (Class III. No. 31) exhibited by me at the recent Crystal Palace Exhibition of Bees, Hives, &c., attains this end, which is set forth in the subjoined descriptive notice affixed to the hive exhibited:—

'Ten bar-framed hive, with double-glass front and back, top in four sections; three of glass, one of wood, with hole for feeding-shutters and reversible dead-air floor-board. Any comb slipping from insecure fixture by the bees, or from the heat, will be held more firmly by the shape of the frame; and any frame can be taken out, with but a small portion of the crown of the hive being opened, thus afford-

ing most easy means of manipulating the bees; while by the glass at front, back, and top, perfect inspection of the occupants and their operations is secured.'

Now, it must be admitted that no other hive intended for occupation, at present in use, provides these advantages; in my hive all that is necessary beyond the shutters, in winter and early spring, is a quilt of Japan or Indian grass to be placed under the shutter of the crown—carpet for the purpose is objectionable, as it holds and retains moisture much longer than the grass, besides attracting the moth. A most inexpensive quilt of dried bracken, in paper or linen, passed through a mangle, to flatten it, may also be used with advantage, the bracken being proof against moth and all other insects, which never infest it.

No doubt many who are wedded to the system of dark hives will object to a hive which at all times, and without disturbing the bees, exhibits them and their operations; they will urge that glass is too cold for bees in winter, but I maintain every hive should be so constructed as to admit of fully inspecting the interior at all times, without opening the crown, and that in the hive I have constructed the bees are as warm in winter as in any ordinary wood or bar-frame hive. The subject cannot be too much ventilated; and I predict the time is not far distant when my plan will be generally adopted.—F. R. JACKSON, *Slindon, Arundel*.

#### TO DESTROY WASPS' NESTS.

According to promise I send you an account of how I destroy wasps' nests. I have tried turpentine, gun-cotton and safety fuse, and damp powder and safety fuse, but neither has been half so effectual as sulphur powder, nor so inexpensive, as it can be purchased for about 3*d.* or 4*d.* per lb., costing not a  $\frac{1}{2}$ *d.* per nest. I take a piece of brown paper, or rag about 4 or 5 inches square, and fold it up corner-ways. I then take one ounce of sulphur brimstone, and pound it up a little, and put it into the paper, and fold up the other corner. I then melt some brimstone on a slow fire in an old vessel,—a crock if you please,—and dip one end into the melted brimstone, just holding it up for a minute until it sets; and then dip the other end. I fix a fumigator on the nose of a bellows made of sheet-iron, and brazed (not soldered, as it will go to pieces with the heat). I go at day-time, and just look at the nest, and put a mark as near as I can to the place; I go again at night, or just after it gets dark; I carry a lantern with me, and generally an assistant. I untwist the sharp end of the packet of sulphur and light it; I then insert it into the fumigator and close it, and put the nose of the fumigator at the entrance of the hole, and blow the fumes of the brimstone into it, taking care that the brimstone is thoroughly lighted. Before commencing to blow into the hole, I give it a few puffs and see that the smoke issues freely; or else it is likely to get the wasps out about pretty thickly. The nose of the fumigator should not be pushed too far into the hole, as the nests are sometimes above the hole, and at other times below, or they may be to the right or to the left; so by putting it just at the

entrance, they are sure to get the fumes. After blowing till all the brimstone is burnt away, I sometimes dig it out at once, at other times I close up the hole, and next day go and dig out the nest, which is often quite in a different direction to what I expect to find it, and sometimes in the hedge further than I can reach with my arm. Sometimes I find a great many around the nest that did not happen to be in the night previous; I generally put on my dress and gloves, and make myself secure: and after digging out the nest, if there are many wasps about, I light a piece of paper previously dipped in melted brimstone, and put it into the hole. I have this season destroyed thirty nests, and hundreds of thousands of wasps and larvæ.—A MECHANICAL BEE-KEEPER, Cornwall.

[Those infested with wasps will do well if they destroy the nests now, as by so doing they will prevent the birth and fertilization of many hundreds of young queens, each of which will otherwise become the foundress of a colony next spring.—Ed.]

#### WAX-SHEETS FOR GUIDE-COMBS.

Admiring the regularity of the combs from Ayrshire exhibited at the Great Show, which were said to have been attributable to the artificial combs used as guides, I bought a pair of plates. Having got so far I shall feel obliged if some one, who is acquainted with the *modus operandi*, will give me instructions, through your columns, how to make the sheets, of which I am in total ignorance.—JONX HUNTER.

[Wax-sheets may be made of any thickness (or thinness) by dipping plates of glass, slightly oiled or soaped, in melted wax. The gauge of the wax plates will be governed by the heat of the glass when dipped, how long it is held in the wax, whether dipped more than once, and the heat of the wax itself. Experience must teach the rest.—Ed.]

#### FOUL BROOD NOT INFECTIOUS.

Notwithstanding your modest hint that I may not be acquainted with this true disease, I can assure you that I have contended with it twenty years ago; and, as I am anxious, I will here use Mr. Hewson's words that it ought to be 'pushed to the front, and made the most important question in apiculture.' Without at present saying a word about those bee-masters who believe foul brood to be infectious, the very honey in the hive contaminated, and even bees from a neighbouring hive alighting on the comb will carry the contagion into their own clean homes, with your permission I will, in a few plain words, state my experience and what I have done. It is now nearly twenty years since I first contended with foul brood, and I was then, and often since, successful in saving my bees by driving them into a clean hive.

Examining the foul-brooded hive, often I saw nothing wrong with the honey; I gave it to the bees; it had no injurious effect upon them, neither did it cause foul brood. Since that I have hived my bees artificially from foul-brooded hives, afterwards giving these bees the honey of the foul-brooded hive from which they were driven, and no disease followed these experiments. I have also put foul comb on

the alighting board of my bees at nights for the bees to take this contaminated honey, as it is called; it was taken, and no infection appeared.

Now here is another voucher for those who believe that all inside of a foul-brooded hive is contaminated:—I have put the honey and the putrid matter of foul brood floating on its surface into the inside of my hive twenty-three days after hiving, and foul brood has not made its appearance after keeping the same hive for three seasons. I trust that those bee-masters holding opposite opinions may state to you their experience in clear and plain words, so that all, and more especially working men who perhaps are not over well learned, may thoroughly understand.—JOHN ARMSTRONG, *Stirlingshire*.

[Langstroth, on the 'Diseases of Bees,' pp. 256, 257 (*The Hive and Honey Bee*), admits that there is a kind of foul-brood which is non-contagious; and this, we suppose, is the disease our correspondent has had to deal with. We trust our readers will not repeat his experiments with the honey from foul-brood stocks.—Ed.]

#### EXTRACTOR, &c.

It is a common saying, that 'the beauty of any invention lies in its simplicity,' and it is certainly applicable in the case of the Honey Extractor.

Curiosity and partly necessity (fancied or real, it matters not) induced me to invest in one; and I must say that I do not repent of my investment.

Unfortunately, it arrived rather late in the season for me to properly test its capabilities; but I saw enough of its 'way of doing things' to convince me, that to the practical (bar-frame hive) bee-keeper, it is a 'host in itself.'

It is a step—aye, a huge stride—in the right direction; but, although generally doing its work well, I find that heather honey, when beginning to cool down, and consequently to thicken, is above its ability,—it will not throw it out. By the way, I wish that some of your esteemed and very able correspondents would show how to bring back 'heather honey' (I can manage the clover) without softening the comb so much that it would get damaged in the 'machine.'

In some minor respects it, in my view, requires improvement. I intend to improve the noise out of my own, in the first place, as, when inside of a house, it has got all the talk to itself, and if on a deal-floor it makes silence with a vengeance.

But the position of comb is a more serious matter; and I think that neither at right angles to centre, nor in the radial line, is the proper one. For the comb is pressed just a little too severely against the frame wires, in the first instance; and it seems to me that, in the other, centrifugal force will not act, or that very feebly, in throwing the honey out of cells, or they will have more upward slope than ever I happened to see in any comb.

I think, however, that there is an angle to find out yet, at which to set the comb, so as that the honey may be properly discharged, with the minimum of damage to surface comb.

Now is there no danger (it may be asked) of the brood getting chilled by such a stream of cold air as must of necessity be brought in contact with the

surface of the comb? and if so it will (according to the theory of one of your correspondents) be a fruitful source of foul brood.

Since the long nights are now at hand, and bees are at their quietest, I hope that some of our long-headed bee-keeping brethren will devote some of their attention towards improving the position of comb in this machine, the latest, and I believe the greatest, acquisition to the advanced apiarian, whether they may be advocates of the square bar-frame or famed Stewarton.—OCTAGON HIVE, *Whiting Bay*.

### THE OCTAGON HIVE.

The able advocacy of the 'Renfrewshire Bee-keeper,' backed by the splendid supers from Ayrshire, exhibited at the Crystal Palace, has no doubt made the 'Stewarton hive and system' famous over all England. But from the account given by that gentleman in the *Bee Journal*, which I read only a short time ago, I should say *he* is much more entitled to be regarded as the inventor of the system and an improver of its boxes than Robert Kerr, of whom I know little or nothing.

But it appears Kerr was an enthusiastic bee-keeper; and I would ask, Is it likely that a Scotchman apiarian could be interested in our common hobby and not be acquainted with the work of Robert Maxwell, where we find a complete description of the way to make octagon—shall I say 'Stewarton'—boxes, with single sliders, to enlarge, contract, or entirely shut the communication between them? Was it from finding a single slider unsuitable that the idea occurred to him to employ several?

As to the inventor of the octagon boxes, I am satisfied so far with the 'Renfrewshire Bee-keeper's' answer. But I would like if he had passed beyond 'strong presumption,' or the strongest, and said, without fear of contradiction, that 'Christ Wren' was the inventor; that the old book, purchased by Milton at Strawberry Hill, was 'The Reformed Commonwealth of Bees, presented in several letters and observations to Samuel Hartlibb, Esq.,' and contains Wren's letter to Hartlibb, with the figure and description of the transparent bee-hive.

The late Mr. Woodbury described this so-called transparent hive, after perusing Wren's drawing and description, as consisting of 'a set of three octagonal boxes, placed one on the other,' and is scarcely to be distinguished from the modern Stewarton hive, except in respect to the means of intercommunication between each, which consists of a central aperture, instead of bars.

The  $1\frac{1}{2}$ -inch bars, for brood-combs, as employed by Kerr, having been wisely reduced by the 'Renfrewshire Bee-keeper' to  $1\frac{1}{8}$  inch, appears to leave nothing that can be claimed by Kerr but the slides; and therefore, like his English namesake, I only look upon him as an improver, with this difference, that his improvement is universally approved of by all sensible apiarians.—QUESTIONER.

### SPASMODIC FEEDING.

I have a Ligurian swarm of this year (date, 15th July) I have been feeding quietly (with a float-feeder)

for the last month, in order to increase the number of bees, as they are not very strong. Two examinations, one ten days ago and one on Saturday, have shown me that I have quite failed in my object—not a particle of brood in any form, and the syrup all placed in the brood-nest. I saw the queen both times: she is a very fine one, and looks very brisk and lively. I wish to try Cheshire's method, as per *October Journal*; do you think it would suit my case?—J. CLEVERE JONES.

[NOTE.—In reply we forwarded some vulcanite plates, with the assurance that all that was needed to ensure the raising of brood, and possibly the building of comb, is what we have for some years insisted on—viz. *gentle, continuous feeding*.—ED.]

### GENTLE, CONTINUOUS FEEDING.

I have tried the plates you sent me on the 3rd, and am agreeably surprised to find the change that has come over my dwindling Ligurian swarm. As I told you, I had used a float-feeder for some weeks, giving a quarter pint of syrup every night, and only succeeded in blocking up the brood-nest with unsealed food, without causing a particle of brood to be raised. I put the plate and bottle on the hive on the 5th (giving two holes only), and when I examined the hive again to-day I found plenty of brood in all stages—the bees sealing up the food they had formerly left uncovered, and a large piece of new comb built, and all this in spite of the cold, wet, stormy weather of the past week.—J. CLEVERE JONES, *Marley Villas, Market Drayton*, Oct. 12, 1874.

### ASTON'S BEE-TRAP.

Since I received one of Aston's bee-traps last year I have invariably used it to empty supers, and with unvarying success; but a few days ago I took off a fine super, placed it, as usual, on the floor-board, with Aston's bee-trap attached, and left it for several hours. When I returned, observing a large collection of bees round the trap, I watched the openings carefully, and was, indeed, astonished to see the bees had discovered a way to dodge the trap and enter, one bee always remaining half out till another got half in. Their cleverness was so great that I stood for more than ten minutes watching them going in and out; I then blew smoke into the trap, and made all secure, and waited. In less than a minute I saw a little head popped out, instantly three or four bees flew to the spot, and two entered while the trap was held open by the outgoer. I lost nearly half my super, but I could not be angry, it was taken so cleverly; I also received a lesson—Not to leave my supers for the future.—E. D. LYON, *Staincs*.

### THE 'PAGDEN' NADIR.

Allow me to suggest to Mrs. Pagden that her instructions on Nadiring, in a late No. of *Bee Journal*, be added to those in her published book, as, had full particulars been there given, I should not be regretting the loss of many thousands of bees which I have just now sustained, owing (it would appear) to their omission.—H. MACHELL, *Euston Cottage, Oxton*.

## Queries and Replies.

QUERY No. 111.—(1). How long will a hive of bees thrive which is never allowed to swarm? (2). Can a new queen be produced at any season of the year if the old one dies or disappears?

In 1871, there was a first swarm taken in a box hive, without frames, and worked on the Stewarton plan. In 1872 a good quantity of honey, of fine quality, was taken away from it in supers; and by giving room below it was not allowed to swarm. In 1873, the same system and results; and in autumn it was a *very strong* hive, with plenty of food. It was not fed during autumn, nor in spring of this year, when it seemed very strong and in excellent state. About the end of March I observed something was wrong, and in May drones *only* were very abundant, and it gradually dwindled down. On examination I found nothing but drone-brood. In July I united a second cast to it, and did not lose a single bee; but next morning I found a queen lying dead on the front-board. They worked well for a time; but they gradually dwindled down. Fearing there was some disease I committed them to the brimstone pit, and found a large store of honey; but I could see no cause for their having gone wrong.

I have two hives just now—first swarms of 1872—treated in precisely the same way, and at present in a very vigorous state; but I dread a like failure, if it arose (as I imagine it did) from swarming being denied, and the original queen dying of old age, or becoming useless in producing worker-eggs.—BUM BEE.

REPLY to No. 111.—The existence of a hive of bees, in which swarming is prevented (as presupposed) must depend, in the first instance, upon the existence of its queen, and the production and fertilization of her successors; in the second, upon the chances of the seasons, whether they permit the bees to increase and multiply their species, and gather stores for their winter supply; thirdly, upon the continued suitability of the combs for brood-raising, and of the hive itself as a bee-domicile; and fourthly, upon freedom from disease and accidents.

When all these matters are favourable, a colony of bees may exist for an indefinite term.

It is, however, as useless to speculate on the possibility of a continuance of such favourable conditions as it is to suggest the ability on the part of the bee-master to govern the swarming propensity and impulse of the bees.

There will be, almost certainly, during the first two or three years of a colony's existence, some necessity for the interference of the 'master.' No one can tell what may be the particular ailment, whether the loss of the queen and failure in obtaining a successor properly fertilized; the imminence of starvation through unfavourable weather, and the consequent hindrance to breeding; the choking of the combs with honey, or pollen, to the exclusion of brood, through a sudden glut of those necessaries; the inexpansive nature of the hive, which will not permit the continued building of new combs, and therefore necessitates the occasional excision or removal of old ones; either several, or all of these, may interfere with the well-being of a colony, and prevent its longevity.

The swarm of 1871 built itself up, so as to become a large colony. In 1872, under the same or similar

treatment, it yielded a honey surplus; and hence it is claimed that, 'by giving more room below, it was not allowed to swarm.' It is probable that giving increased space rendered swarming unnecessary in the present instance; but the same treatment might, in every other of ten cases, have been perfectly nugatory.

*The swarming impulse cannot (at present) be controlled.* In 1873, similar results attended similar treatment, and it was pronounced 'a *very strong* hive,' with plenty of food; and thus it seems to have continued up to the spring of this year, when the abundance of drones present, and the sparsity of the worker-element, proclaimed something to be wrong. The probability is that the queen perished at a time (in autumn or winter) when there were no means of fertilization for her successor, and hence her progeny were drones only; or her queenly successor (if one was produced) was lost on her wedding-tour, and the prerogative was assumed by a 'fertile worker,' which was, of course, a drone-producer only. The addition of a cast, with a young queen (which was killed by the nimble worker-'pretender'), patched up matters for a time, and the hive seemed flourishing; but, *from there being no recuperation of the 'worker' element*, the colony dwindled away, leaving a large store of honey in the hive. Similar occurrences are common in hives containing fixed combs; their state cannot be judged except from symptoms; there can be no examination, dissection, or diagnosis, until after death, and then it is always too late to offer a remedy, and often impossible to form a correct estimate of the causes of disaster.

A new queen cannot be produced, under any circumstances, unless there be eggs or young larvæ in the hive, which, in the ordinary course, would become worker-bees; and it is possible (and probable) that, in the present instance, the queen died in the winter of 1873, or spring of 1874.

It may have happened that a swarm 'stole away' in early spring (1874), and that owing to the coldness of the succeeding weather, the newly-produced young queen perished on her fruitless wedding flight.

The dread of these results would be prevented by the adoption of the moveable comb-system, as the true state of the case could at any time be ascertained, and the necessary remedy prescribed, if any were required.—ED.

QUERY No. 112.—While at the Apicultural Show, Crystal Palace, the other day, I noticed that the great display of honey from Scotland, in the Stewarton hives, was all contained in comb made in bars *double* the width of the bars in the ordinary square Woodbury hives; and considering the combs in the Woodbury bars are almost (if not always) made so wide by bees as to overlap the width given, to make them approximate to the combs they are in the habit of building in straw-skeps, and that the combs I noticed in Stewarton hives did not, in any instance, project beyond the width of bars, I should be very glad to know the reason why Woodbury bars are not made as wide as the Stewarton bars (*i. e.* 2 or 2½ in. wide).—F. R. L. *Pinlee*, *Staines*, Oct. 5, 1874.

REPLY to No. 112.—The reason the combs and frames in a Woodbury hive are only about 1½ inches from centre to centre of each other is, that that distance is exactly correct and in accordance with the ascertained habits of bees, which always build their

combs at that distance apart, except when they are storing honey. The Stewarton hive measures  $13\frac{1}{2}$  inches across, and contains 9 bars or frames, the same distance from each other as the frames in the Woodbury; but in the Stewarton *supers*, there are only seven bars or frames, each occupying near upon 2 inches of space.

The Ayrshire bee-keepers procure straight combs in these by fixing sheets of wax, impressed like the foundations of combs, along the centre of the bars, which the bees adopt and work upon.

The Woodbury-hive arrangement is for breeding. We remember a case when a gentleman, thinking his bees had not sufficient space between the combs (they always seemed so crowded), gave them an inch and a half additional, so that they might have plenty of room to work; and the result was, that they did well, whereas before they had not done so. He did the right thing, as it *happened*; but the bees did not want the spaces, so filled them with new comb, which enabled them to breed more freely, and to use up some of the store of pollen with which the other combs were more or less choked.

If you examine the combs in a skep you will find they average about  $1\frac{1}{2}$  inches from centre to centre of each other; while those in a straw super will be of various shapes, and thicknesses, and subject to no rule.—Ed.

QUERY No. 113.—I put a small first swarm into a six-frame Woodbury Observatory hive, double glass sides, 15th June. I fed them soon after, and they have increased very fast, and two combs which they seem to keep to (I put small combs on each of the six frames, but they have only, notwithstanding the regular feeding built out too fully) are crowded with bees. I allowed rather too much space between the frames and the glass, and they cluster on the two combs, and have built here and there pieces of honey-comb against the glass. They have lately built three or four queen cells; but they are, I believe, untenanted and unfinished. And last week I noticed some fifty or sixty drone-cells sealed, and the queen is still very busy laying in all the empty cells she can find. They fill nearly one-half of the hive, but have not finished out the lower comb, but hang down over it. Is it not extraordinary late for drones to be hatched? The hive is in a warm, unoccupied room, used as a honey-room. Would it be safe to leave them to winter in the hive? If so, would it be well to have a fire in the room occasionally in cold, damp weather?—G. F. T.

REPLY TO No. 113.—It will be almost useless to attempt to keep the bees in the unicomb hive through the winter with any idea of profit. If kept warm by artificial means, they will be active and continue breeding, or at least will try to do so, and this will necessitate an occasional cleansing flight, which under bad weather preventing will probably cause dysentery, and consequently the hive will become filthy. Good weather is, however, possible, and the bees may pull through; but the chances are much against its being so, and therefore the safest course will be to remove the bees and combs from the unicomb to a hive suitable to their requirements. Observatory hives are not intended for the reception of swarms, and except in extreme cases, when one is determined to see what bees do (under circumstances, be it remembered, almost sufficiently disagreeable to drive them to despair) at the commencement of their

'house-keeping,' they are never properly so used. The true use of an observation hive is the reception of a number of frames of comb with bees from a populous colony, but supposing you had placed six full combs in the hive under discussion, the result *now* would have been much the same, *i. e.* the bees would have slowly dwindled until there would be barely sufficient to cover two combs; and, furthermore, they would gradually die out. That all is not well with those in question is evidenced by the queen-cells raised and the drone brood also, both of which simply show the abnormal condition of things within the hive.—Ed.

#### NOTICES TO CORRESPONDENTS & INQUIRERS.

W. A.—It appears the supers exhibited by Mr. Cowan were so arranged that they could not be tasted, hence they were disqualified. This was an arbitrary proceeding, and a great hardship on Mr. Cowan, since no intimation of the necessity for the honey being exposed had appeared in the Schedule. Some nicer means of tasting the supers should be devised than was adopted at the Palace, it is not every one who would care for honey after another's fingers had been thrust into it.

J. H. E., Norwich.—The stock being a swarm of this year in a straw skep will not be likely, under ordinary circumstances, to die of starvation if it weighs 20 lbs., if not, it should be fed until that weight is attained. The best time for transferring combs in spring is 21 days after the bees have swarmed. The best way of preventing the bees swarming at unseasonable times, is to adopt the system of artificial swarming now so common. 'Driving' is the best and safest method, and the best mode of driving was that adopted by us at the late Crystal Palace Show, a full description of which will shortly be given.

F. H. F.—We have never heard of bees or humans suffering from the effects of honey obtained from yew-trees; and as for box, why it is one of the earliest and best honey-yielding shrubs to which bees have access, and coming as it does when provender is otherwise very scarce, we have always given its pretty white blossoms a hearty welcome.

OCTAGON HIVE.—Is it implied that heather honey is so much like glue that it will not move out of the cells? How then is it *drained* out?

MANCHESTER MAN.—It matters little what verdict the gentlemen arrive at with regard to the Honey Extractor on the 31st October, since its value and importance as an implement of apiculture are too well established. If the intention is to report on a machine on a new principle, well and good; but if it is intended merely to prove that it will not extract honey when it has become *solid* from *cold* or from *the effects of time*, they might save themselves the labour, and the chance of their motives being misjudged. If there be any reason why heather honey cannot be got out of the comb, except by crushing and *pressure*, we can quite understand that such honey is not marketable. It never was pretended that the machine *could* extract honey which is too solid to drain out, as probably some of the contents of old straw skeps may be; but that points to the desirability of adopting the moveable comb system, so that the honey may be *extracted by the machine* whilst in a perfectly liquid state, and, if necessary, before the bees have had time to 're-swallow' it.

\* \* \* In consequence of extraordinary pressure articles on the Honey Market, 'Driving' as at the Crystal Palace, The LATEST Hive, and various contributions, are postponed.

# British Bee Journal,

## AND BEE-KEEPER'S ADVISER.

[No. 20. VOL. II.]

DECEMBER, 1874.

[PUBLISHED MONTHLY.]

### Editorial, Notices, &c.

#### DECEMBER.

During this month bees, if properly prepared for the winter, will require little or no attention beyond the care ordinarily necessary to prevent the entrance of their hives being choked with snow, dead bees, or *débris* from the combs; nevertheless, there will be some who, from causes beyond their control, will have been unable to attend to their stocks, and, as a consequence, some of their bees must be in very poor condition. To such we would say, Do not by any means feed your bees with liquid food, for now that cold weather has set in, there will be no possibility of its being sealed over, because the bees will be unable to evaporate it to the proper consistency, and it will be liable to turn sour and breed disease. The best winter food for bees is barley-sugar, if properly made; and elsewhere in these pages will be found directions which, if carried out, cannot fail to produce the desired article. In feeding bees it should be remembered that they do not always make their winter's nest in the centre of their hive; indeed they seldom do so, unless very strong. Weak stocks usually congregate against the warmest and driest side or corner of their hive; and in either of these positions it must be manifest the central hole, although intended for feeding, can be of little use for the purpose. Under these circumstances the quilt arrangement will be found most advantageous, as without any disturbance, but by simply turning up its corners or sides, the whereabouts of the bees may be easily discovered, and food, in the barley-sugar form, administered, if required. Barley-sugar may be given, in a bottle over the cluster, where means are available, or it may be thrust between the combs under the quilt, giving a small quantity at a time to each seam of bees. In skeps it must be either put in at the feeding-hole, or thrust up from below, in which latter case it will probably fall on to the floor-board and deliquesce; but where, as often is the case, the bees are not immediately under the feeding-hole, and food is required, the hive should be

taken into a warm apartment until they are rendered sufficiently active to attack the food placed there, after which there is little danger of their leaving its immediate neighbourhood, while the supply is kept up.

Hives which have been found strong in autumn, both in bees and stores, have been known to perish during a protracted frost, through having eaten up the stores on one side of their hive, and being, through the continued coldness of the weather, unable to cross to the other. As is generally known, strong stocks store their honey on both sides and at the back of the hive, and make their first autumnal nest near the front, evidently with a view to be near, and guard their entrance, although it is a question whether the heat of the sun, acting (usually) upon their front side or end, may not make it the more comfortable. There is, however, no known law which governs their localization in the hive, as may be proved by the examination of a number of stocks during the winter, when they will be found occupying various positions, no two being alike. As before said, the bees of strong hives store their honey on both sides and at the back of their hives; and in the circular, or, its nearest approach, the octagon form of the hive, the globe of bees, as they cluster, move gradually on their stores during winter, and thus revolve, as it were, round the inner surface of their hive, making a complete circuit, and clearing the combs of food as they do so; and this probably forms the chief advantage which the circular form of hive has over the parallelogram; for, as will be observed, the stores being packed in the form of a crescent, the bees begin at one of its 'horns,' and may continue in contact with their food until the whole is consumed. Now in bar-frame hives, when no regard is had to shape, this happy circuit cannot always be made, since they are oftentimes so shallow from front to back as to make it impossible, unless the bees in their cluster assumed an unnatural form, for honey to be stored in any quantity at the back of the hive, and consequently its bulk will be found at the two sides only. Now it will be easily seen that if the bees of a prosperous stock move in one direction on their supplies, they must be

moving equally far from their other base, and consequently when the store on one side becomes exhausted there is danger of the stock perishing through utter inability to move *across* the cold empty combs, and thus they may die, victims to 'hive shape,' which has no 'philosophy' in it. It is amusing to find how glibly our esteemed correspondent, 'Uncle Walter,' proposes, p. 116, to make a hive with somewhere near thirty combs of small dimensions, set side by side. What would be the result in a protracted season of cold, if the cluster of bees worked its way from near the centre to the other end, and found itself without food? Would it not inevitably perish? And of what service would the central feeding-hole be? These questions point to one theory, that when the circular, or its nearest approaching, form of hive is departed from, the proper shape is that in which the frames are longer from front to rear, as in the admirable Quinby and Langstroth hives, so that as bees consume their stores from the front they simply draw back upon their reserve, moving all the while *between* the same combs.

**VULCANITE DIVISION-BOARDS.**—The intense coldness of the weather during the latter part of last month set us devising some means of internal protection to bees, so as to render unnecessary the outer wraps which otherwise are required to thin hives; and, thanks to the introduction by our scientific friend, Mr. Cheshire, of vulcanite (as a feeding-plate), which is an exceedingly good non-conductor, but in the form of sheets is little known to the world, we have been very successful. Almost all bee-masters using the bar-frame hive recommend the use of division-boards, and it occurred to us that the sheet vulcanite, being so good a non-conducting material, might be rendered serviceable; as, in addition, it is non-absorbent, non-condensing, elastic, and withal takes up very little space, and when placed in hot water, may be moulded into almost any form. So believing it to be the very thing required, we obtained a supply, and have had much satisfaction in using it for the purpose. For enclosing weak stocks between a limited number of combs, it is invaluable; as, when cut into sizes about an eighth of an inch longer than the hive and sprung in, it holds itself in its place by its own elasticity, and may be made to fit a hive to the greatest nicety, by simple filing. It is a thin material (No. 16 wire-gauge), but is much thicker than that used for the feeding-plates, and fitting closely is not likely to be propolized; and even supposing it should be, being elastic it can be shortened by bending, so that it can always be removed without trouble or difficulty. The chief advantage in

its use consists in its causing every hive wherein it is used to become at once double-sided, with dead air-space between, and an inner surface which, as we have just proved, bees will cluster against, with the thermometer at six degrees below freezing, and this too when they have plenty of room *between* their combs. After this, we are convinced that vulcanite will be largely used in hive construction, notwithstanding its expensive character, as being non-absorbent it can be easily cleaned, and cannot retain infection. For runners, in lieu of metal for frames to rest on, it must in future take precedence.

**FOUL-BROOD.**—This question may now be considered before the bee-keeping world, and the able contribution to the knowledge of its nature which will be found in this *Journal*, translated for its pages by an eminent Danish authority, is sufficient proof of the interest taken in the subject by our Continental neighbours. It is written by Herr Pastor Schönfeld, of Teutschell bei Liegnitz, Schlesien, and taken in conjunction with the result of 'Dr. Klein's researches on the typhoid germ,' to which (says the *Linton Medical Record*, Nov. 11th, 1874) 'Professor Tyndall has prominently directed public attention,' it would appear that our suggestion in last month's *Journal* that dysentery and foul-brood are allied, is not very wide of the truth. The presence of micrococcus in foul-brood, its power to kill when applied to healthy brood, and its recognition as the typhoid germ, seems only to want one connecting link, and that is, the presence of micrococcus in dysenteric discharge, and this is now being made the subject of experiment. If it should prove to be correct, as may reasonably be surmised, that the dried remains of dysentery throw off self-germinated spores capable of producing the terrible disease, then the mystery will be solved, and the means of prevention arrived at. In addition, if dysentery *does cause* foul-brood, and we have never known a severe case of the former which has not eventually terminated in the latter, how easy it will be to trace the introduction of the disease to the importation of stocks from a distance, which in a majority of instances acquire dysentery through excitement and confinement on their journey. Truly if our theory proves correct, many mysteries regarding the introduction of foul-brood to apiaries will be cleared up, not a little to the satisfaction of those who to our knowledge have been charged with sending out infected stocks, when at the same time they were ready to make official declaration that they had not, nor ever had, a sign of foul-brood in their apiaries.



## DRIVING AS AT THE CRYSTAL PALACE.

Amongst the many attractions at the Crystal Palace, on the occasion of the great Bee and Honey Show in September last, few things created more interest than the exhibition of manipulation with live bees which took place on the north corridor; and amongst all the operations which were there performed, there was nothing which so astonished the on-lookers as the simple and easy method of 'driving' which was so many times successfully repeated. It was quite amusing to hear the speculations of the visitors outside the glass screen, as they guessed at the measures which they supposed had been adopted to render the bees passive under the extraordinary treatment to which they were being subjected; and there were few who would believe that their own bees could be handled with the same facility and safety. 'Them's charmed bees,' said one. 'No, I know what they've done,' says another; 'they've rubbed themselves all over with creosote, and that's frightened the poor things—they can't abear the smell of creosote.' A third knew (?) 'they must be bees that had been tamed for the purpose, and knew the operators; and that was the reason they would not sting.' But very few of the throng that flocked to see the performance could believe that the whole mystery consisted in the fact that the bees had been merely *frightened*, and had consequently gorged themselves with honey, in which condition they seldom attempt to sting. Langstroth's three principles of management are thus expressed: First, '*A honey-bee when filled with honey never volunteers an attack, but acts solely on the defensive.*' Second, '*Bees cannot under any circumstances resist the temptation to fill themselves with liquid sweets.*' Third, '*Bees when frightened immediately begin to fill themselves with honey from their combs.*' And these facts, if properly taken advantage of, will enable the bee-keeper to perform most of the feats one reads of. It was, nevertheless, difficult to believe, that bees, which carry with them such terribly offensive weapons, could be so easily controlled; and not until the public exhibition at the Palace, which was repeated during three consecutive days, had there ever been an opportunity afforded to bee-keepers generally of verifying these statements; but after witnessing the performance, many have been enabled to say with our reverend and esteemed contributor on page 119, 'Albeit I have learned at last to drive.'

Driving is one of the most important and necessary operations in bee management. It has been practised from time immemorial, and in the earliest works on the subject, appears to

have been made use of more as a means of obtaining honey from hives, without destroying the bees than, as now, for the purpose of what is termed artificial swarming. Driving was originally performed by the aid of smoke alone, produced from various materials; and in the days of Columella, eighteen hundred years ago, an instrument was used of similar description to the *fumigator* now in ordinary use, p. 26, through which smoke was blown, to *drive* the bees from those parts of the hive from which the honeycombs were to be excised; and in later times to drive the bees entirely from the hives, so that the honey might be removed more easily, and without danger to the operators. In this latter operation the hive was inverted, an empty hive was set upon it, smoke was blown up through a hole in the crown of the inverted hive, and the bees were thus driven from the combs to seek shelter in the vacant hive above—which process, however, could scarcely be satisfactory, as a little too much smoke would cause the bees to fall back again amongst the combs, and thus defeat the object in view, and too little would be otherwise ineffective. Driving by drumming was next introduced, in which operation the hives were placed as before stated, and every possible means of exit closed, the sides of the hive were drummed or beaten, with the hands or some sticks, the bees being thus driven for refuge into the upper hive. This plan has been practised for many years, indeed is that usually followed; but at the Crystal Palace Show, the measures adopted, although not new, were far superior to any of the foregoing, and in fact were the best that have hitherto been discovered. As before stated, the whole secret lies in frightening the bees, to cause them to fill themselves with honey from their cells; it is possible to effect this latter object by other means, but as a rule the frightening process is the best, as the bees get less excited, and are more manageable than if supplied with food from outer sources. It may here be said that some bees are so gentle naturally, as not to require the 'sedative' recommended, which we gladly admit, as we have often found pure Ligurians positively unwilling to use their stings, indeed, in some instances, they may be treated as if they did not possess those dreaded weapons; but as a rule the process indicated should be followed. To frighten bees, nothing more is necessary, or more effective, than a *puff of smoke*. Any kind of smoke will answer the purpose, but as tobacco-smoke is usually more easily, and often more willingly, provided, it is generally recommended. Just one puff—no more—directed into the hive will create such a consternation amongst the bees as will cause the suspension of the whole of the operations of the hive, and

every bee will endeavour\* to fill its honey-sac with honey, as is usual when preparing for a general exodus. While this is going on the hole in the crown of the hive should be carefully stopped with a close-fitting bung, or the queen may find an aperture in which to pack herself with her retinue, and by remaining there, thwart the intention; the hive should then be inverted, and placed on a chair or stool in such a position as will cause the *ends* of the combs, near which the bees are most numerous, to be raised as high as is convenient, somewhat indeed as if it were placed upon a sloping writing-desk. A slight sprinkling of simple syrup now applied would facilitate their gorging, and in the meantime an empty hive should be fixed in the position indicated in the engraving (Fig. 1), like an open watch, the *hinge* being at

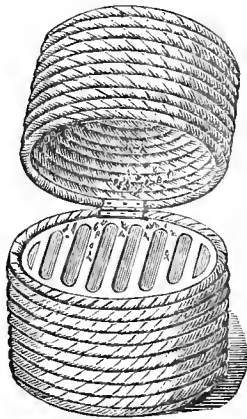

Fig. 1.



Fig. 2.

the highest point on the lower hive (a direction too faithfully followed by our artist), and all will be ready for the *drumming*. The means of fixing the upper hive in its position need not be expensive, as four stout hair-pins will form an excellent hinge, two being thrust upwards into the upper hive, and two others through their loops downwards into the lower hive, linking them firmly together; and one or two sticks, each about eighteen inches long, forked at one end and pointed at the other, the forked ends resting on the rim of the lower hive, and

the pointed ends thrust into the crown, or fixed to the inner front of the upper hive, will fully answer the purpose.

In drumming we generally use our bare hands, as the force thus applied can be most easily governed, but those who wear gloves, and do not wish to knock them to pieces against the hive, would do well to use driving sticks of the form shown in the engraving (Fig. 2), by means of which any reasonable amount of vibration may be communicated to the hive and combs without the 'thud' usually given when a solid stick is applied, and little or no damage will be done to either. At the first application, whether of the hands or sticks, the blows should be of the gentlest, applied simultaneously to both sides of the hive, when the bees will appear to be confounded, and will rush about the combs in the utmost terror; and as the dreadful '*earth-quake*' continues, they will eagerly seek for some means of escape from the tottering walls of their city, which, it must be remembered, is now *topsy-turvy*, and every thing in it upside down. It is singular, and scarcely credible, that at this time, amidst all the dangers that surround them, they never attempt to escape by flight. The popular idea is that, under such circumstances, the bees will rise *en masse*, and attack their 'tormentor;' but, although furnished with wings and stings, they do nothing of the kind. After rushing about the comb for a short time, they appear by common consent to make for the upper hive, and with a loud buzzing, which almost amounts to a roar, they commence climbing into its walls and roof, which, being less influenced by the drumming, and free from the dangers attending the tottering of the combs, affords shelter for the time being, in which they can cluster until the danger is over-past. There is a popular, but erroneous idea, that the queen always leads the bees in swarming; but in these cases, as in natural swarming, she seldom makes her appearance until about two-thirds of the bees have left the hive, when, finding herself comparatively deserted, she rushes after the main body, and may easily be caught, as, under the instinct of self-preservation, she hurriedly *waddles* over the clustering bees in her endeavour to reach the place of safety.

This method of open driving, as it is called, has many advantages over the older methods, one of the chief being, the facility with which a queen, whose presence with an artificial swarm it is essential to determine, may always be observed and captured if required. A second advantage is in the facility with which the lower hive may be emptied of bees, where excision of combs, or 'transferring' to bar-frame hives, is contemplated; in the old close method of driving, both hives touch each other

\* It would be well here to note that sometimes there are very few honey-cells available in a hive, so that it would not be possible for a whole population to share the coveted honey: for instance, when no honey gathering is going on, a hive may contain twenty thousand bees, yet there may not be five hundred unsealed cells containing honey; in which case it would be well, after introducing the smoke, to invert the hive, and sprinkle its combs with syrup, so that all the bees may get a supply before the drumming commences. Artificial swarming should however only be practised during the ingathering season.

all round, and the bees, to escape from the danger below, rush into the upper hive at all points, whence many of them are knocked back by the drumming, until, not knowing which way to go, they sometimes form a cluster on the centre on the upper edges of the combs, which after a time they become too stupid (being gorged and tired) to leave, and too densely packed to be removed. This is extremely likely to happen in hives through which sticks are thrust at right angles to each other, as at the point where they cross there is an amount of rigidity which prevents vibration of the combs, and affords a comparatively safe retreat to the bees, whereas in the open method there is only one point of junction between the upper and lower hives, and to this, being the highest, the bees will invariably rush; so that, excepting at the point of contact of the two hives, where it is probable a few bees, forming the lower part of the cluster, will be found, the whole hive will be cleared, and even those may be dislodged by smartly reversing the hives, and brushing them out with a feather. It may, therefore, be considered proved that the open method of driving bees from skeps, is best for finding queens; best for artificial swarming, because the queens may be observed on their way up to join the swarms; and best for clearing the hives of their population, when it is intended to appropriate their honey, or transfer their combs to hives of other descriptions.

#### TO MAKE BARLEY SUGAR.

Break up three pounds of loaf sugar, place it in a saucepan or preserving pan, and pour half a pint of cold water upon it, and half a wine-glass full of vinegar—these are all the ingredients required. Prepare a fire in a grate, the top bar of which will let down in a similar way to that in an ordinary kitchen grate, taking care, however, that at the commencement of the operation the bar is up in its place, and the grate *full* to the top, with glowing cinders or wood embers, so that a great heat may be obtained without any flame. Take the saucepan containing the sugar, &c., place it upon the fire, and stir it *without ceasing*. In a few minutes it will begin to assume the character of dirty broth, which will have anything but a nice appearance, but presently a thick scum will rise, and the mass will try to boil over. As soon as this is observed, the saucepan should be removed from the fire until the ingredients have cooled a little, when it should be set on the grate again in such a way that only a small part of it is over the fire; the boiling will then go on on the exposed side; and as the ebullition takes place, the scum will be forced to the side *not* over the fire, whence it may easily be removed with a spoon. Thus, the saucepan is held in the left hand, the spoon in the right, and the saucepan being on the left-hand side of the grate, with its right side

exposed to the action of the fire, the scum will retreat to the left or cooler side, and will be in the handiest position for removal, as will be evident in a few minutes to any one trying it. After a quarter of an hour of this treatment, the mixture will have become in a great degree clarified, when it should be removed from the fire, while the top bar of the grate is let down so as to permit of its nearer approach to a greater heat. Should there be any irregularity of the fire it should now be corrected, but flame should be prevented, as the mixture having parted with its water will be liable to take fire if brought into contact with flame. It will be well here to remark that so long as the scum remained on the syrup, there was a tendency in the whole to boil over since the water evolved in the form of steam while the boiling was going on, accumulating in a body, would lift the scum above the saucepan to enable it to escape; but when the scum was *gone*, the water would be evolved in bubbles of steam, which would *crackle*, but not boil over unless a very intense heat were applied. The duration of the boiling of the clarified syrup before it becomes liquid barley sugar will depend upon the amount of heat, and the consequent evolution of the water, to which it is subjected; but trials may from time to time be made by dropping a little on some cold surfaces to see if it becomes brittle, and when that state is arrived at it is done. Last year in giving directions, we suggested that the barley sugar should be poured into bottles and sticks inserted, but some correspondents complain of the difficulty of preventing it deliquescing under these circumstances, as the sticks will not permit of the insertion of corks, and consequently the barley sugar absorbs moisture from the atmosphere, and therefore it would perhaps be well to pour it into a tin dish, set it in a dry, cool place until it becomes hard, and then by striking the tin on its underside, the whole of the barley sugar will be splintered into fragments when it may be placed in bottles and corked up for use as required.

There is little art required in this mode of manufacturing an article which is almost unobtainable, since the barley sugar sold by confectioners is often of a nature, that when given to bees it becomes sugary and granular so as to be unfit for their use, and consequently they carry it largely from the hive, and it is wasted. The principal attention should be directed to the clearness of the fire, the skimming off of the scum, and the constant stirring of the syrup to prevent burning.

*Balm*.—The smell of balm is very agreeable to bees, and it is well to have this fragrant plant growing in the neighbourhood of the apiary.

*Bees Seeing*.—Bees see best in broad daylight; less distinctly at dusk; and, according to some observers, not at all in the night—the antennæ, as is supposed, then supplying the place of eyes.

The experience of later times has taught that bees are best preserved in winter by a general restraint from the open air, that they may pass the time of no gain in sleep and slumber with little waste.—BUTLER.

## Correspondence.

\* \* \* These columns are open to Subscribers, so that their queries, replies, correspondence, and experiences, may be fully and faithfully recorded; and for the discussion of all theories and systems in Bee-culture, and of the relative merits of all hives and appliances, that the truth regarding them may be ascertained. The Editor, therefore, must not be expected to coincide with all the views expressed by the various writers. All Correspondence is addressed to the Editor.

### THE CAUSE OF FOUL BROOD.

Perhaps few English bee-keepers are aware of the many long scientific discussions and experiments that have from time to time taken place on the Continent to get to know the cause and means of cure of foul-brood, and, by so doing, mitigate the enormous loss and damage that this fatal disease is ever inflicting.

Therefore, as one of the latest of the many series of experiments to solve this question, the following appears the most conclusive and interesting. It is from an acknowledged source, a Dr. Schönfeld of Germany, and, as will be understood, is the continuation of a long series of past disputes. Herr Schönfeld says:—

‘As is known, Dr. Preusz, at the Apianian Exhibition (Vandreforsamlingen) at Kiel, after continual study, made publicly known his considerably altered theory of foul-brood, and, at the same time, expressed the hope that this theory might now gain general acceptance, as, without his having worked in that direction, it must reconcile all the various views of the subject. This hope, however, was not fulfilled, as his old opponents stood firm and prepared for a fresh combat, inasmuch as the one declared that it was impossible, above all, that the fungus (*Micrococcus*) could be found in the atmosphere; others reiterated to excess that it might be the result, but not the cause, of foul-brood.

‘Contradiction was explicable, as there lacked real and palpable proof that the fungus from the dried decomposed brood separated itself and was carried away in the atmosphere; also, that when its spores came in communication with healthy brood that they grew and multiplied until they killed the larvæ, and by this means were the cause of foul brood.

‘I offered therefore to produce that proof, if I could only from one place have sent me a real infectious piece of foul brood, and declared without reserve the method after which it (the proof) should be established, so that others also could make the trial; but there was no foul-brood sent me, neither did any one else try to produce the proof, a sufficient evidence of how few believers the theory of Dr. Preusz had found.

‘Dr. Dzierzon therefore proposed, by the wish of the editor (of *Bienen-züchtung*), at the last (Vandreforsamlingen) Exhibition at Saltsborg, the following question:—“What is to be looked upon as decided relative to foul-brood, both as regards theory and practice, and what remains now undecided?” But, although he laid all his views and his name’s influence in the balance in favour of the correctness of the Preuszian theory, he must still acknowledge that the incontestable proof was wanting, as at the conclusion of his answer he declared, “If also the theory brought forward by Dr. Preusz should prove correct, yea, even if it is the most probable, so is yet the question—cause, the sickness’s real nature—even now enveloped in ob-curity.” Thus we stand in relation to the problem which I previously stated:—

‘Firstly, it must incontrovertibly be proved that the

spores of the fungus leave the dried-up foul-brood, and they must, inasmuch as they float in the air, be able to be caught.

‘Secondly, it must next be shown that such fungus-spores, that are caught in the atmosphere, when placed on healthy larvæ, can grow and increase to an uncountable number until at last they kill the brood, and so prove themselves the cause of the sickness.

‘Although the problem appeared difficult, I went even confidently to the work. I wrote immediately to Herr Locher in Sigmaringen, and asked him for a little foul-brood. The 18th of June I received, enclosed in a letter, so much as I could form into a ball about the size of a pea. The substance was very dark, nearly black, moist, and tenacious, and its odour was exceedingly disagreeable. A careful examination under the microscope proved the presence of fungus of the same form as *Micrococcus*. Had I, after having solved my problem, begun first to show that the spores could escape through the fly-holes (entrances) of hives containing foul-brood, it would have been necessary for me (in order to have obtained such a hive) to dissolve the infectious substance in water, and therewith sprinkle a comb containing healthy brood. It is most probable that such a proceeding would have failed, as the bees would most surely have cast out the dead larvæ and pupæ before the artificially produced sickness had had time to develop itself fully and infect the whole hive. In every case there would have gone a much longer time by that means before I had arrived at the result. I had not, however, in the meantime the opportunity, as I already wished to discuss my experiment at Halle. I therefore immediately made the experiment to catch the spores that were escaping, and were floating in the atmosphere, from the infected substance that had been sent me, and thereafter use them for infecting healthy brood. For this purpose I constructed the following apparatus:—On a smooth-planed board I placed a bell-glass, in the top of which was a round hole; in this I fixed a glass tube 2 feet long; there was also fixed a similar glass tube in the board. In the top of the uppermost tube was fixed a plug of cotton-wool, as also in the under end of the bottom tube, and the wool was not pressed tight, but so that the air could circulate freely through both tubes. The foul-brood substance that I had received from Herr Locher was now placed under the bell-glass on the 21st of June, and left to dry slowly. If then, the assertion that the spores escaped in the air when the substance was dry was correct, then it was only necessary for me now and then to place the apparatus by the window in my study, and expose it to the full influence of the sunbeams, as if the air in the bell-glass, by the power of the sunbeams, was warmed up to 40°, it must, by a well-known physical law, escape through the uppermost tube, while the cooler air from the floor of the study must enter the bell-glass through the bottom tube, and at the same time it was quite as certain that therewithal the spores of the fungus, that were carried by the upward current of air, would be caught in the wool above.

‘On the 5th July, on which day the substance was quite dry, until the end of the month, I got four plugs of wool, each of which had served as the top plug for about eight days; besides these I had two pads of wool, each of an area of about 4 square inches, which I had placed inside at the top of the bell-glass.

‘Had the spores from the substance really been escaping? and had the wool caught them as they were coming out into the world? All rested on the answering of these questions, and examination gave the following results:—

‘(1.) When quite a small portion of the wool was washed in distilled water and thereafter a drop of this water placed under a microscope, it showed a considerable quantity of the fungus *Micrococcus*.

‘(2.) If a plug of wool, as large as a pin’s head, was laid dry on a piece of glass thereafter moistened with distilled water, and placed under the microscope, the

Micrococcus could be seen partly in the water, and partly adhering to the threads of wool.

'(3.) If the wool was examined dry it was difficult to see the Micrococcus, and it could only be seen by aid of the strongest lens, and through three objectives.

'(4.) Of gun-cotton, of which I had two plugs, which were prepared with water as sub. 1 and 2. Micrococci were to be seen in still greater quantities than in the ordinary wool, probably because the one is finer and better suited to retain the spores.

'Thus, by a practical method, I have solved the first part of my problem; and it is without a doubt proved, though in an unequal degree, that the spores of the fungus from the dried-up matter escape, and are borne away by the atmosphere.

'Therefore there cannot be the slightest doubt of the fact, that in consequence of the bees ventilating so strongly as they so often do, that the spores must be driven out of a severely infected hive in very large quantities.

'When V. Molitor-Mühlfeldt, in order to refute this assumption, declares that there is no circulation of air in a bee-hive, but that, owing to the motionless air the spores must sink down, and not pass from cell to cell, it sounds almost as if he had no idea of ventilation being caused by the bees, and as if he had not read paragraph III of Von Berlepsch's *Der Biene*. When Günther has succeeded in working a small windmill of paper by placing it at the entrance of a hive containing a strong stock, then it is evident that the circulation of air produced in the hive by the bees must, in proportion, be a much stronger hurricane for these light spores than any such hurricane von Molitor-Mühlfeldt has witnessed on the earth. And when the same opponent declares on the whole that the atmosphere cannot be the bearer of the infection, so has that invalid assertion been so thoroughly refuted by Dr. Ule, of Halle, that I will not waste a word on the subject.

'It is quite certain that it is not over all, and at all times, that the atmosphere will contain such a quantity of seed-germs, and Dr. Preusz goes too far when he declares that the atmosphere is *everywhere loaded* with these germs. If such was the case, foul-brood infection would appear in every district where there are bee-keepers; but there can be shown many districts where this disease is quite unknown: as in my district, up to the present time it has not appeared.

'I certainly succeeded in producing a whole comb of dead, rotten, and stinking brood: but although I experimented with this comb in the most various ways, placed it at the fly-hole at the open door, and exposed to the sun's warmth and the atmospheric currents about my pavilion, I, after examination, found no more fungus than Fischer, who never had anything to do with foul-brood.

'*Where there is no fungus present, there can never arise infectious foul-brood.*

'Herewith we have approached nearer to the solution of the second part of my problem.

'It next requires to show, and afterwards to prove, that pure fungus collected from the atmosphere by means of the cotton-wool, has the power to kill larvae, and by so doing cause foul-brood. To do this, I took, on the 30th of July, a comb with brood from a first swarm, brushed off all the bees, and covered about one hundred larvae with wool, which was made fast by means of some thread. The comb was hardly replaced again before the bees attacked the wool, and commenced casting it out in small pieces. On examination of the comb on the 1st of August, it showed that all the larvae that had been covered with the wool were cleared away by the bees. Three larvae above the previously covered cells died shortly after the bees had sealed the cells which they were in. The cell-covers were sunk, and the well-known small hole was in the centre.

'After this, about one hundred other larvae were covered

with wool, but again, as also a third time, the larvae and wool were torn out. I had nearly lost my patience, and I had only now two plugs and one of the squares left, which should be used for other experiments.

'I now rather anxiously, for a fourth time, covered a brood-comb, and this time, fortunately, the bees let most of the brood remain in the cells. After an interval of four days seven larvae died. An instantaneous and conscientious examination, by aid of the microscope, revealed the presence in their bodies of immense numbers of Micrococci.

'Unfortunately, I was obliged now, on the 12th of August, to defer my experiments, as I could not postpone for a longer time a Bath tour on which I should have started at the beginning of the month. I forgot now to slide in a wire netting to prevent those larvae that remained being torn out by the bees, but on my arrival at home from the Baths I found all in the best order.

'Still the fact that Micrococcus possesses an enormous power of infection, and that it also attaches itself to perfectly healthy brood until it kills them, cannot longer be denied. As incomplete (which I myself acknowledge), as the above proof turned out, owing to the scantiness of material that I had at my disposal, and the haste with which I was compelled to operate, as strikingly and as unrefutably have I succeeded by another process to prove it.

'As I at once saw beforehand that under the circumstances before mentioned, and the well-known strong propensity of every strong hive of bees to remove as quickly as possible every sickly or dead larva from the hive, it would be extremely difficult to arrive at a complete and satisfactory result, so the idea occurred to me to try the experiment of infection on the larvae of other insects, which it would be possible to observe without obstruction.

'As specially adapted for the purpose of this experiment, it occurred to me that the larvae of the blow-fly would be the best, as these larvae especially possess an extraordinary vitality, that notwithstanding its voraciousness, it suffers hunger and thirst, and in defiance of its nudity, can withstand cold and heat most astonishingly; and besides the above, this insect resembles the bee in its development, inasmuch as it is as larva fourteen days, and it is as pupa about the same length of time. I could, without difficulty, procure and nourish these larvae, and, what at that time was of most importance, I could take them with me to Johannisbath, and there comfortably observe them under the ordeal.

'I therefore, on the 11th of August, laid a juicy piece of meat in the window, and a fly of metallic lustre, desirous of laying, soon deposited a heap of eggs on it. The next day about one hundred were hatched, and these grew with their well-known rapidity. The second day of my stay at Johannisbath, to where of course, besides these larvae, I brought my microscope, some of the wool that contained the fungus, and also a few bell-glasses, under which latter I placed three separate sets of larvae.

'The first and second had each ten, and the third the remaining larvae. The larvae under the first bell-glass on the same day, together with the meat which was their resort, were covered with wool. Six days after this the larvae attained their normal size, and this without my being able to detect the slightest unhealthiness; on the same ten larvae, under the same bell-glass, and on the top of the wool I laid a fresh piece of meat, which, together with the wool, was well saturated and smeared with the excrement of the larvae.

'Two days afterwards seven of the larvae were dead; some lay on their backs, others on their sides, but all were stretched out. The others lived and transformed after one, two, or three days' interval.

'A very careful microscopical examination the next day of a dead larva showed that the whole surface of its

body was covered with Micrococci. I might wash any portion of the larvæ and examine the water; I might place the minutest piece of the skin under the objective and then moisten it,—but always the same result, Micrococci in innumerable numbers.

As the remaining six larvæ soon decomposed, three of them were dried on a piece of wadding, so that they could at a later date be used for experiments of the same kind. Again, two were examined while decomposing, and were found full of uncountable Micrococci, and these last were spread on a piece of meat and given as food to the ten larvæ in the second bell-glass, which up to this time had not shown signs of transformation. While we for the present leave these ten unfortunate victims to their fate, let us turn to the three pupæ, which to all appearance fortunately have transformed, and whose cocoons gradually get of a darker colour. Our first closer examination convinced us that they were dead, as the cocoons here and there were sunken in. Two of them that I cut through the middle in the direction of the length revealed such large quantities of Micrococci fungus, as they, without a doubt, must be acknowledged as the cause of their death. The third pupa, like the three before-mentioned larvæ, was reserved for future experiments.

When I to the above add that the ten larvæ from the second bell-glass died before transformation after a few days' interval, being the result of having eaten their fungus—containing sisters; that one larva that I examined before its death already contained an enormous number of fungi, and that all the others after death proved to be full of fungi inwardly, more especially in the intestines; while the larvæ in the third glass transformed, and came into existence as flies; that I for many days in succession bent over the microscope and had examined more than 100 pieces; so there can be no longer doubt of the fact that Micrococcus also infects perfectly healthy larvæ, and in the end kills them.

This result, willingly and without opposition, will be accepted by the scientific, as there is nothing to find therein that is opposed to experience or research.

Herr Molitor-Mühlfeldt rightly enough declares in answer to my earlier articles that no fungus-spores can take root on the undamaged skin of healthy animals, because the main principle, the suitable underlayer, is wanting, and such underlayer is only found when the animal is unhealthy, or when about and unnoticeably has already begun to decompose or dissolve; and this assertion does not allow of scientific proof. And even if it was correct, Dr. Prenz's theory is by no means refuted thereby, or even threatened, as in reality every larva that is seized by infection finds itself in an extremely sickly state, which may be traced to another cause.

In general, the larva dies soon after the cell is closed, and before it envelopes itself as a pupa, during the time that the larva changes to a pupa; not alone the skin of the larva decomposes, but the larva certainly as the result of the natural metamorphosis, finds itself in a sickly condition, and is to every deadly attack peculiarly and specially adapted for infection.

We could, therefore, if we might allow Mühlfeldt's assertion a little attention, very easily say, at the sickening time of preparation for transformation, and during transformation, the dying and decomposing skin of the larva is in the very best and most suitable condition for the support of the fungus's growth, so that it multiplies at a rapid rate and kills the larva before transformation is at an end. Therefore, since Dr. Prenz and Vogel at Saltsborg have given the decided assurance that there are always found Micrococci in foul-brood, and since I have practically proved, that healthy brood can be infected by Micrococci, so can there no longer be doubt that where foul-brood appears as an epidemic, there the infection is produced and carried to effect by Micrococci.

Every bee-keeper whose apiary has suffered from

foul-brood, after reading the account by Herr Schönfeld just translated, must acknowledge the truthfulness of his arguments and the conviction his experiments carry with them of the nature and cause of foul-brood.

For my own part, although only a novice in bee-keeping, I can confirm Schönfeld's assertion relative to the infection after the decomposed mass has dried up, and the non-infectiousness while in a moist tenacious state; not only have some of my own hives been saved by the removal in time of the decomposed larvæ while as a brown, sticky, stinking mass, when the hives have at once recovered their usual healthy state, but I have also seen it confirmed in a neighbour's hive, while another neighbour has this autumn had to destroy numbers of his hives, all of which have been sacrificed through want of precaution in the removal of the matter in the spring before it dried. On examination of my hives, I find only one of my stocks now afflicted, which I have removed into quarantine, that is to say, to a distance, as I wish to experiment with it in the spring. In my last remarks on foul-brood I mentioned using sugar, my idea was that it might have as beneficial an effect on the decomposed mass, as when placed on a foul wound, but, by Schönfeld's simply beautiful experiments, how easily can I see of what little avail it was, and what radical means should be adopted instead. Cut out, take away, and destroy; rather forfeit a hive to-day than try to save a comb by letting it remain until to-morrow.—  
J. S. Wood, *Nyborg*.

#### INOCULATION WITH BEE-POISON.

Some six years ago, when I first began bee-keeping, I managed my bees according to the directions laid down in Wood's book upon bees.

The part of this work which struck my fancy most, was not that which describes in glowing terms the golden harvest to be reaped from a few stocks of bees, but that which speaks of the probability of protection against their stings by a process of inoculation. For a long time, I confess, that I did not care to try the experiment; my hives were few, and as they were the old straw hives, I only got stung once or twice, when I took the supers in the autumn.

However, when my bee-ardour was stimulated some two years ago, I had fully determined to try the experiment, but several things prevented me, and it was not till last October that I summoned up courage for the ordeal.

On Oct. 3rd, I went to see the Hanwell Apiary, and being much struck by the way in which our Editor managed his bees, I asked him how long it would take to render any one sting-proof, as, although he was stung once or twice, the stings seemed to have no effect upon him. He told me that his son had only been a short time working with bees, and that he was quite free from any of the usual effects of bee-stings.

This circumstance brought back to my mind the experiment which I had long wished to try, and when I got home I commenced at once.

Referring to my diary, I see that from Oct. 3rd to Oct. 10th I was stung eight times.



The *modus operandi* was as follows:—I went to one of my hives, caught a bee, placed it on my wrist, and allowed it to sting me, taking care that I received the largest amount of poison, by preventing it from going away at once; then I let the poison-bag work, which it does for some time after being separated from the bee: the first day I only stung myself twice. A bee-sting has always had a very bad and injurious effect on me, inasmuch as it has always caused a great amount of swelling and of pain; in fact, once when stung on my ear, the part became so painful and swollen that I hardly got any sleep the following night, and it was three days before I recovered.

The first few stings I got during this experiment had the usual effect; the whole of my fore-arm was affected with a cutaneous erysipelas, and, in the words of surgical works, there was disorder of the muscular nerves, accompanied with heat, redness, swelling, pain. This attack lasted till Tuesday, and on Wednesday (Oct. 7th) I was so far recovered that, following the same plan, I stung myself three times more, also on the wrist. The attack of erysipelas this time was not nearly so severe, but as before I felt a stinging sensation as far up as my shoulder, and I noticed that a lymphatic gland behind my ear had increased considerably in size, the poison being taken up by the lymphatic system.

On Saturday, Oct. 10th, I again treated myself to three stings, and the pain was considerably less, though the swelling was still extensive.

At the end of the next week (Oct. 17) I had had eighteen stings, then I stung myself seven times more during the next week, and I reached the number thirty-two on Oct. 31; the course of the experiment having lasted very nearly four weeks.

After the twentieth sting there was very little swelling or pain, only a slight itching sensation, with a small amount of inflammation in the immediate neighbourhood of the part stung, which did not spread further.

I do not wish to draw any definite conclusions from this experiment, though I may mention that I stung myself on Nov. 8, without its having any effect on me; but I should like to know the experiences of others on bee-inoculation; and if some of your readers would amuse themselves with trying the same experiment, we might from a great many cases arrive at some definite results.—GEO. WALKER, *Cottentham, Wimbledon, Nov. 16, 1874.*

#### CRYSTAL PALACE SHOW.

I have read with pleasure the letter of the Hon. and Rev. Mr. Bligh in the *Journal*, and quite agree with him, that all those interested in the success of the Association and its annual exhibition should help the Committee by throwing out such suggestions as they, as lookers-on, may deem necessary or desirable; these, added to the experience gained at the Crystal Palace, will form good aids at starting, for the consideration of the Committee in framing the schedule of prizes, as well as the rules and stipulations for the guidance of the judges in awarding them. These rules appear to me most essential, as in the case of

Mr. Cowan's beautiful supers, which were disqualified in a manner that every one must regret. He had carefully, and in my opinion very properly, put a few small screws into the frame of the glass cover, which did not in the least obstruct the view, but kept out the dust, and prevented the judges from getting their fingers into the honey-comb to taste it. There was no stipulation that the judges should have the option of tasting the honey, and that the supers should be left open, or Mr. Cowan could have had the screws removed until after the judging. In the absence of any rule I think the judges exceeded their legitimate powers in disqualifying this splendid collection of supers, and evidence of skill on the part of the exhibitor. There could not be a reasonable supposition that it was not what it professed to be, and of this there is no pretence: any practical eye could see to the contrary, without tasting it. It was an arbitrary decision; and as they could have had the screws removed in two minutes, I cannot in this agree with Mr. Bligh, that it was an accident, and that nobody was to blame. Do judges at fruit-shows think it necessary to taste pines, grapes, peaches, pears, &c., before awarding prizes? Certainly not, or they would have few exhibitors. Every society must have a beginning, and in judging honey-comb and hives there were few precedents—hence the importance of rules.

In the production of so large a quantity of honey from the number of stocks, Mr. Cowan has shown himself to be a thorough bee-master, and I am sure we should all be glad to see in the *Journal* a description of his *modus operandi*, if you, Mr. Editor, can prevail on him to give it us in detail. How he prepares his bees for winter, starts them in the spring, and the after management, would be most interesting.—JOHN M. HOOKER, *Sevenoaks.*

#### THE TWO EXHIBITIONS: PARIS AND LONDON.

It may be deduced from the intelligent criticism in the November Number of the Hon. and Rev. H. Bligh on the Bee Show at the Crystal Palace, that the arrangements of the Exhibition, though marked by much practical knowledge and enlightened judgment, and attended with remarkable success, cannot be considered to be absolutely perfect, and that if any suggestions can be derived from any quarter, they would be entertained by the Committee of the Bee-keepers' Association

I would desire, therefore, briefly to refer to the exhibition which has recently been held in the Orangery of the Tuileries, in Paris, which bore a striking resemblance to that of our own Bee and Honey Show. This French Exhibition was, however, on a broader basis than ours, seeing it included all useful and injurious insects. Amongst the former, the bees, their products and appliances, as might be expected, occupied a prominent place. And as this was the fourth exhibition of the kind, we may conclude that the conductors have attained a considerable amount of experience since its first institution.

So far as apiculture is concerned, the principal



results of the French Exhibition have been the constitution of a central market for producers and consumers, and the stimulus it has afforded to bee-keepers in the prosecution of their favourite pursuit. The wax and honey exhibited sold readily at prices far above those usually obtained. Many persons desirous of being purchasers were obliged to be content with obtaining the addresses of those who could produce what they required. The lovers of Italian bees had been led to expect that they would have been brought in contact with those who traded in those bees. But they were doomed to disappointment. Neither the bee-traders nor their bees were present. There were only some hybrid bees born in France. They were in some degree compensated by being brought into acquaintance with bees from Carniola and Algeria. Three stocks of Carniolan bees had been forwarded by M. Ambrozie, of Moistrana, Austria; one had perished in the transit, and the others were considerably damaged by the length of the journey. They were, however, pronounced to be almost as pleasing to the eye as the Italian bee. The Algerian bees also attracted much attention. They had a Creole air, and they gave evidence that they had not left their thievish propensities at home. The Austrian and Algerian importers of these bees received for their enterprise in bringing them to Paris, the former a silver medal, and the latter a medal of the first class.

In looking over the prizes awarded to exhibitors, we are struck by several marks of contrast which the French Exhibition presents to that held at the Crystal Palace. 1st. There is a marked absence of money prizes,—the awards consist of diplomas of merit, medals of various classes and of different values, honourable mentions, and special marks of distinction, these last being decreed to the originators or conductors of the Exhibition. 2nd. The cottager does not appear to be brought in any way to the front, nor is any visible encouragement given to him (possibly this may not be the case, as the judges may have taken into their consideration the conditions and circumstances under which the articles shown were produced). 3rd. Prizes are given not only to the successful exhibitors, but also to those who show zeal in, or devotion to, apiculture in the districts in which they respectively reside; and 4th. Besides prizes being given for honey, wax, hives and bee-appliances, they are granted to those who exhibited spice-cakes, confectionery, syrups, cordials, wines, &c., in the composition of which honey enters as an ingredient.

The reports of the judges will be published *in extenso*; and I venture to suggest that they should be carefully perused by the Acting Committee of the Association; and I feel assured that if any lessons are to be gathered from the experience of our Continental brethren, they will not fail to take advantage of them.—G. HENDERSON, *Eating*.

#### THE BRITISH AND DANISH BEE-KEEPERS' EXHIBITIONS, 1874.

Having this year had the privilege and pleasure of being present at the Annual Exhibitions held at the Crystal Palace, London, and Rosenborg

Castle, Copenhagen, it may interest some of the readers of the *British Bee Journal* to have a short account of their main differences.

The object of the two societies is the same, viz., the encouragement, improvement, and advancement of bee-culture; and their Annual Exhibitions are the great stimulus leading to the accomplishment of these objects.

I will, as far as possible, make my remarks as follows,—

The holding of the Annual Exhibition as regards the Danish.

The general arrangement.

The classification of the exhibits.

General remarks relative to the articles exhibited, and judging of the same.

At every Annual Exhibition of the Danish Society, it was decided at the directors' meeting where the next Annual Exhibition was to be held; and at an appointed meeting held in the following spring—May—it was decided who shall be on the Arrangement Committee and have the entire arrangement of the Exhibition, such committee appointing their own foreman. At this meeting is also decided the day on which the Exhibition shall be held; in the meantime those members who have questions of importance that they wish to hear discussed at the discussion meetings, held during the days of Exhibition, send such questions in writing to the secretary, who makes them known in the last issue of the *Journal* before the Exhibition takes place.

The Copenhagen Exhibition was held in a large saloon in the grounds of Rosenborg Castle; the room was very tastefully decorated with wreaths, flowers, and evergreens, as also tropical and other plants; the tables were covered with clean paper, which extended over the edges, so as to cover all unsightly parts of the underwork, cases, &c.

The exhibited articles were arranged neatly; all run or extracted honey in glasses together, as also articles in the other classes were together, each in its class, so that while examining any article you had the whole of that class before you. This was a notable difference in the two Exhibitions; as also the exhibition of honey, that in Copenhagen being exhibited almost entirely in glass jars, as run or extracted honey; whereas that at the Crystal Palace was mostly in the comb, and which would, as a rule, have shown much better off had the combs been laid on clean dishes, as at the Copenhagen show, the dishes being borrowed for the purpose; there was also to be seen run honey at the London show exhibited in large chemical bottles or glasses, which by no means looked tempting.

Another feature in the Copenhagen show was that ample room was allowed for each exhibit, so that visitors could easily examine the article without moving it; whereas the articles in London were so closely packed, that to examine without touching was difficult, and such close packing results in the unpleasantness, that visitors remove them, causing disorder in replacing.

It would also be preferable if only one article of the class for each exhibitor was on the table, and the surplus for sale at another place in the room. Again, the charge of one shilling for each exhibit

may certainly prevent cottagers from coming forward with many exhibits. Would it not be also preferable were those articles that are exhibited to infuse knowledge, collected in a class at one place in the exhibition, thus forming a sort of museum by themselves? The exhibition of live bees I much prefer as at the Copenhagen show, where there was no glass to confine the view, but free and open all round, where the public could form a ring, and the queen, in a cage, &c., could be shown round some distance from the hives; a queen, in a cage or under a glass globe, with a few followers, as also a comb containing honey, pollen and brood might be sacrificed for the purpose of showing round, and the exhibition of finding queens, driving, transferring, accomplished at fixed times; and Nature's carpet of grass or gravel preferable to the unfortunate fibre matting.

In arranging the classes for prizes, the two Exhibitions differed as regards the honey more especially; in the Crystal Palace the classes were arranged according to the size of super and quality; whereas at Copenhagen the classes were arranged according to quality, and the flowers from which the honey was gathered. There were other minor differences, but to give an idea of the extent of the exhibits the following shows the number as nearly as possible arranged in corresponding classes,—

CRYSTAL PALACE.			COPENHAGEN.		
Class	Exhibits.		Class	Exhibits.	
1-6	58	corresponding to	1b	in which	43
" 7	6	"	" 1a	"	8
" 8-26	153	"	" 3	"	215
" 27-35	47	"	" 1c and 2	"	84
" 36	9	"	" 3c	"	28
" 37-38	0	"	" 0	"	0
" 39-40	0	"	" 5	"	2

Or, in other terms, the Copenhagen consisted of 43 empty hives, 8 hives with bees in, 12 articles of invention, 72 articles of bee furniture, 582 glasses of honey, 25 combs of honey, 28 pieces of wax, and the following prepared with honey:—349 bottles of mead, 21 glasses of fruit preserved, 5 glasses of fruit jelly, 11 bottles of fruit juice, 20 bottles of fruit cordials, 6 bottles of honey wine, 100 bottles of honey champagne, and 6 lots comprising some hundreds of cakes.

The great difference in hives exhibited consisted in the construction being high and low, or, in other words, the frames in the majority of hives at the Crystal Palace were to lift out from the tops; whereas at Copenhagen the frames were to take out sideways and endways,—the low hives differ in the large area compared with the high, which is the most advantageous.

It is to be regretted that the honey which took the first prize at Copenhagen was exhibited in an earthenware jar, thus it lost a deal of its beauty, and could have given rise to a doubt of its uniform quality. There were also exhibited at the Crystal Palace glasses of almost black honey (to all appearance aphide, or, perhaps, from the sycamore), which were really more suitable for an apicultural museum. Many samples of honey seemed to lack the peculiarities one would expect to find, knowing the district from whence they came, and a few were not free from fermentation. A doubt was also excited relative to the purity of some of the samples of wax,

such as their not being quite free from colouring matter.

There was a remarkable absence at the Crystal Palace Show, but which were so well represented at the Copenhagen, namely, the various delicacies in which large quantities of honey are used in their preparation, some of which I have already named.

The question of judgment now arises. Is it preferable to judge by the quantity and quality alone as classified at the Crystal Palace, or is it preferable to take into consideration the source from which the honey has been gathered, as it should be borne in mind that an exhibitor whose apiary is surrounded by heath, who exhibits his purplish and viscid honey, the exhibitor of buckwheat honey with its brownish colour and rank flavour, the exhibitor of clover honey with its beautiful amber tint, or lime-tree honey with its greenish hue, can never equal the beautiful white, limpid honey gathered from the fruit tree blossoms of surrounding orchards.

With the exception of a few imperfections as before alluded to, the products at both exhibitions were excellent, as also the collection of hives; whereas in extractors the London exhibition was decidedly behind, both in numbers and construction. But taking both exhibitions in a general view, they were all that could be wished, and reflect great credit on the gentlemen who undertook their management and arrangement; and had a committee of judges been appointed to visit both, it would have been indeed difficult to say which should bear the palm of superiority; but one fact must not be overlooked, viz., that the Crystal Palace Show was the first of its kind held in England, while the one in Copenhagen is the sixth show of the Danish Beekeepers' Society.—J. S. Wood, *Nyborg*.

### WOOD OR STRAW?

The question at issue is, which are best,—boxes or straw hives? And it is a question most difficult to answer satisfactorily. We have, in our apiary, pitted one against the other, year after year, and have obtained *equal* results from wood and from straw, that is, so far as honey in *supers* is concerned. Now what is the object desired in bee-keeping? Undoubtedly the principal one is a large produce of honey, chiefly in the comb, but also to some extent as drained honey, especially now that there are such facilities for 'slinging' the comb and returning combs thus emptied to the hive. We must bear in mind that it is only recently that the facilities for extracting honey from the comb have been so great, so that the question as to the arrangement of hive in which the combs *may be removed* is of vast importance. Can this be effected in the case of cottagers' ordinary straw hives? Certainly not. Can it be effected in the neat, square straw hives, the 'Woodbury,' &c.? Well, yes, perhaps, for a few years, whilst the hives last and as long as they retain their shape, but straw is a perishable material. This brings us to the question of durability: one of no small importance. Wood is here undoubtedly preferable to straw. Then there is the important point of the health of the community.

Until lately I had an idea that straw was certainly the best material and most conducive to the general well-being of the bees, upon the ground of greater freedom from moisture internally, which also means freedom from dysentery, &c., but my views have been modified somewhat since the tops of boxes have been 'improved away' throughout the autumn, winter, and spring months, and 'quilts' substituted, —a move which I have not been slow to adopt, with, so far, a satisfactory result. I should now have no hesitation in saying that boxes, properly protected, are excellent for winter quarters; and I would here just state that the delightfully rough condition, externally and internally, frames and all, in which some boxes are sent out, instead of carefully-planed surfaces, are quite a treat to the bees.

So far we have only been considering the *stock-hive* as a *depriving hive*, whereas the question of surplus honey in *supers* is of more importance. Now which is best, straw or wood? I really don't know. For facility of working supers on boxes may be better than on common skeps, but a little ingenuity will overcome this. In my opinion both are good, that is, when properly managed. For instance, 1874 gave me the Crystal Palace glass globe of 50 lbs. net, worked on a common cottage straw hive. Another gave me a super of 53 lbs. net. Some few summers since a cottager's straw hive gave me a super of 112 lbs. net. The same season a box gave 109½ lbs. net; the result being that as much honey in supers has been yielded by straw as by wood. We have purposely omitted referring to the sizes of hives, but it does seem curious that, whenever a fine super has fallen to my share, it has been worked on hives of very moderate capacity, either straw or wood. We may try larger hives; not 20-inch 'Pettigrews,' or boxes exceeding the Crystal Palace hive, which appears to combine, with cheapness, all the requisites of a thoroughly good moveable-frame box-hive.—GEORGE FOX, *Kingsbridge, Devon.*

#### THE OCTAGON HIVE.

It affords me satisfaction to congratulate your correspondent 'Questioner' on being the first (if we except Mr. Wm. Carr's futile attempt to elevate Rusden into undue prominence) who has responded to the appeal made by me in the third number of this periodical for aid to elucidate the origin of the above hive.

Although possessing a tolerably extensive collection of works upon bee-keeping, and several of considerable antiquity, I regret that the number does not include 'The Reformed Commonwealth,' nor yet Robert Maxwell's book, and consequently anticipate with pleasure 'Questioner' laying before your readers the data by which he appears to be able to prove that the first named volume *was* the old book purchased by Milton at Strawberry Hill, and by reproducing 'the figure and description of the transparent bee-hive' of Wren for comparison with what Geddie laid claim to have invented, and for which he obtained his patent from Charles II.

I, however, regret very much to find that your correspondent, fresh from a perusal of the late discussion, has found my contention in favour of

Robert Kerr's claim to the invention of the Stewarton hive and system of bee-keeping so ineffectual, that he appears to coincide with the view enunciated by my opponent,—beyond the slides there is little or no credit due to Kerr, and rates him as an individual of whom 'he knows little or nothing.' It was for that very reason I was desirous to prevent the name of Kerr sinking into oblivion, by recording what his hive and system had done for bee-keeping in the opening volume of the *British Bee Journal*; that is best judged by its results; and should 'Questioner' chance to be 'a brother Scot,' he will possibly excuse the national habit of answering one question by asking another,—Would your correspondent kindly point out, where in the writings of Wren, Geddie, Rusden, Thorley,—and may I venture to add Maxwell, too?—is any, the most distant, reference made to those 'splendid supers,' which so delighted your correspondent, and which, to use his own expression, 'has no doubt made the Stewarton hive and system famous over all England?' Are they not the 'separate honey condensers,' as I put it, which place the name of what Kerr did for bee-keeping on a par with that of Watt for steam?

Suppose, for the sake of argument, that several bee-keepers, each possessing one of the above writers' works and no other, and guided by it alone, determined to come forward with the fruits of their several octagon colonial systems to the late Exhibition to compete, and where would they have been against Mr. Jas. Anderson's first prize table display? He very probably never read any of the above treatises, his knowledge being acquired in early youth by oral instruction from the lips of Kerr, who made his first boxes; the produce of the older Octagon hive would simply be the blackened distorted brood-combs of no better than three Pettigrewian big skeps in wood set upon one another, 'the single slider' communication being exactly similar to what we usually meet with in divisional communications in poultry-houses.

The opinion of the late Mr. Woodbury, that the hive of Wren 'was scarcely to be distinguished from the modern Stewarton,' only went to prove that that distinguished apiarian knew little of the more modern hive, and less as to its manipulation. When doing the bee editorial of another journal, he owned as much in correspondence, sending the present writer the queries connected therewith for replies.

If your correspondent, 'Questioner,' casts his eye on the opposite page from where his last interesting communication appeared, and note the very pertinent query of F. R. L., as to why the bars he saw in the Stewarton supers at the Palace were so much wider than those of Woodbury supers, he would, from my stand-point, reply, that the bee, invariably storing honey in the upper portion and outer combs, to economise space and material, increases there the depth of the honey-cells; consequently, for this reason, and the richer and more massive appearance of such combs, the bars of supers and sides ought to be much wider than those in the breeding department. Despite Mr. Woodbury's superior culture, light of later improvements, and familiarity with 'modern German thought,' Kerr, with probably little else than the habits of our little favourites to guide him,

judged merely by the supers our departed brothers have respectively left behind them, comes out the abler apiarian of the two.

'Questioner' has been kind enough to give me credit for effecting improvements in the Stewarton hive, these I have all along felt to be subsidiary to the first principles of the hive as I found it,—mere finishing touches, if I may use the expression to gratify a desire for completeness of things in my own apiary. Not being numbered with the busy throng, who have something to 'push,' I felt when first I beheld the trophies of the Stewarton system, what I dare say many a fellow-apiarian did on gazing at the first and second table displays at the Palace, that, notwithstanding a pretty good acquaintanceship with bee literature, I had something yet to learn of which it did not treat. I went to Ayrshire, and assiduously acquired the lessons most fraternally afforded by the brotherhood there. The result far exceeded my most sanguine expectation; and since, my pen has been ever ready to champion the good cause; and, as a result, one maker thankfully wrote to me, that he now turns out as many as one hundred sets of boxes in a season, thus showing that others are now freely sharing the benefits experienced by —A RENFREWSHIRE BEE-KEEPER.

#### ASTON'S BEE-TRAP.

I am sorry to hear that my trap after the successful run it has had, has at last yielded to the cunning of the bee. But there is consolation in the fact, that it is a solitary case, as far as I know, judging from the testimonials I have received, and the praise my trap earned at the Crystal Place from gentlemen who had tried it.

When I first made the trap, it was on the same principle as the 'Prize Trap' at the Crystal Palace, and I found it a very common occurrence for the bees to get back again to the super. To prevent that I added partitions to it with a fall to each (purely my own invention), which, as far as my experience goes, has had the desired result. I next brought it before the public; and out of the hundreds that I have sold, Capt. Lyon's is the first complaint I have been made aware of. Nothing is more easy than for bees to get back to a super if there is no other preventive than the falls, as I have found out from experience; and for that reason I believe mine, with the partitions, to be the most effective article of its kind ever offered to bee-keepers.—R. ASTON, *Upper Bar, Newport, Salop.*

#### QUEEN-CAGES FOR INSERTING LIGURIAN QUEENS.

The 'Renfrewshire Bee-keeper' has made a mistake on p. 118; as he there states, 'With all cages stuck into the combs, the queen can only be set free after the hive has been opened up, and the workers being newly and thoroughly disturbed are in their most irritable mood.' Now I beg to call 'Renfrewshire's' attention to a queen-cage Mr. Carr described and illustrated last May, p. 14, in the *British Bee Journal*, for the benefit of bee-keepers. This cage is inserted into the comb, and the queen can be set

free without opening the hive again, and without disturbing any of the bees that may have been clustering round the cage for forty-eight hours. There is no necessity for removing this cage, or opening the hive for weeks after the queen is first put into the cage.

Mr. Carr states in that article that this cage he made in 1865,—and I made these cages five months before 'Renfrewshire's' statement appeared. These cages can also be used to protect young Ligurian queens, when hatching in the hive, so that any one, with a stock of pure Ligurian bees, may have from eight to a dozen Ligurian queens at one time hatching in the hive, to place at the head of as many swarms from common black bees whenever they wish to make them.

These queen-cages I consider are the best without exception. They are made of perforated zinc, and of wire cloth, at 1s. each.—R. ASTON, *Upper Bar, Newport, Salop.*

#### QUEEN INTRODUCTIONS AND QUEEN-CAGES.

My attention has been drawn to the point, as to whether, with the new style of queen-cage, it has ceased to be necessary to disturb the hive, to excise any royal cells which had been formed during her imprisonment. Of course this is imperative with every description of cage; but some time after the commotion has subsided, she then can be liberated without the risk attendant on her regaining her freedom during the excitement consequent on opening the hive.

In the *resumé* of the exhibits at the Crystal Palace Show, October No., 'our Editor,' in alluding to queen-cages, says: 'We confess to have had no experience with cages of this kind, being always fearful that the queens confined in them might possibly be starved to death, since they contain no honey or other provision; and it is singular that bees which would instantly kill the caged sovereign if they could get at her, should be expected to feed the usurper through the bars of her prison; yet the principle being set forth on the authority of the "Renfrewshire Bee-keeper," and W. Carr, Esq., must be considered indisputable;' and in a private note, the Hon. Secretary, Mr. Hunter, in discussing the same point, says, 'I always choose a place to fix it [the cage] on where there is honey, and I scarcely believe the bees who are enemies will feed the stranger.'

Mr. Alfred Neighbour, the talented author of the 'Apiary,' in a correspondence I had with him a few years ago, held exactly the same views, and at his urgent request tried one of his firm's zinc cages stuck into a comb, and had the mortification on setting her free to find my fine imported queen pinnioned and killed before my eyes, and I never repeated the experiment.

I must confess there is considerable force in the reasoning of 'our Editor' and Messrs. Hunter and Neighbour, to those who have never made the experiment; but that stern teacher 'Experience' has many years since convinced me of the fact, that workers invariably do feed imprisoned alien queens;

and during the last dozen years can only recall a couple instances where they failed, which only went to prove the rule, as on these occasions a severe night's frost either chilled the captive sovereigns, or the workers shrunk downwards on the combs, resigning them to their fate.

In referring to the correspondence of ten years since, I find in a letter of the late T. W. Woodbury, Esq., dated 14th February, 1864, he says, 'I send a tobacco pipe-cover, which I have recently used, to the exclusion of all others. If pressed into the surface of a comb until it come into contact with the "partition-wall," it will confine a queen with tolerable, but *not with ABSOLUTE security*. I therefore mostly use it fitted on a piece of perforated zinc. I have tried to sketch the apparatus in its place on the top of one of my hives, and occupying the two-inch hole in the crown-board.'

The *italics* were his, the word *absolute* being doubly underlined. So placed in what in another place he calls his *thick* crown-board, it is impossible the queen, as in my own case, could feed herself, consequently *must* be fed by the workers; and the late Apiarian's most extensive queen-introduction experiences place the point at issue beyond a doubt.

Of the new style of cage sent by me to the Exhibition, there were two patterns—the flat form, as sketched in last month's Number, and the other circular, on exactly the same principle; the former, I must say, from the facility with which it could be inserted between any frames or bars without cutting, was my first favourite. However, I regret very much to hear reports of some mishaps with the flat form, in one presented to 'our Editor,' and another to the Hon. Secretary. The former found a queen caged therein dead the following morning, and so did the latter; and on a second attempt, Mr. Hunter was equally unsuccessful. Not having received the remains of these queens for microscopic examination, I am very much puzzled to account for these misfortunes. In an isolated case, a fagged, tired-out queen will die in a cage equally with the little box that brought her; but then we have the repetitions. These presentation cages were heavily japanned, to improve their appearance and prevent rusting, still I cannot think the coating would prove so deleterious as to destroy life. Theoretically so perfect in design, that although utterly neglected by workers, projecting so far into the hive, if covered above in ordinary weather it was impossible the queens could be chilled, or get starved, having on either side a choice of honey within easy reach. Then, were they stung? This the microscope would have at least revealed, but Mr. Hunter says, 'I never saw a worker sting a queen,' and I generally agree with him, except they are fairly roused, striking out furiously right and left without respect of persons; and I can hardly think that the wider gauge of the wire-net would prove a temptation to destroy the life of a queen, when, if so disposed, there was ample space to thrust through their sting between the wires of the old pipe-cover. But I can well see the angular form of the flat cage does prevent the workers grouping round the sovereign, as in the pipe-cover, where, encasing its sides, they could expend the full force of their regicidal fury. There may be more in the circular

form of hive and cage than your contributor, Mr. F. Cheshire, dreamt of in his 'philosophy;' at all events I regret exceedingly that the advanced period of the season, and scarcity of queens after hearing of these mishaps, prevented me experimenting to ascertain exactly the cause of these misfortunes, as I yet trust to be enabled to do.

In my own apiary I caged three queens in the above flat exhibition cage; and on the morning of the third, so confident was I of complete success, and being hurried at the time, I was not even at the trouble of raising the cages to ascertain the condition of the queens, but merely pressed down the wire; and on hearing of the above mishaps, searched two of the hives, and found both queens all right, one busy laying at the moment; the third stock was awkwardly situated and without slides, and had to be disturbed before the queen was liberated, and in this case alone I failed to find her.—A RENFREWSHIRE BEE-KEEPER.

### QUEEN-CAGES AND UNITING QUEENS.

Your correspondent on page 118 makes two mistakes. First he says, 'Your correspondent, Mr. W. Carr, followed suit with a description of his "conception" of a cage, and kindly favoured us with drawings of it.' Now on page 188, Vol. I., I say, 'In November 1864, I at once set to work and made a queen-cage; drawings of which I sent to some of my correspondents; and as your contributor wishes for a successful queen-cage that can be opened when inside the hive without disturbing the bees, I send you a drawing and description of the one I made in 1864 for the benefit of bee-keepers.' This identical cage was exhibited at the Crystal Palace, and has been in use for ten years, and was not the conception of 1874. Perhaps your correspondent had seen some of the drawings and description of my queen-cage that I had sent to my friends, as his conception in the February number of the *Bee Journal* is almost identical with the one I made in 1864.

Again he says, 'With *all* cages stuck into the combs, the queen can only be set free after the hive has been opened up, and the workers, being newly and thoroughly disturbed, are in their most irritable mood.' Now on page 14, Vol. II. (six months before this statement appears in the *Bee Journal*) I describe a very simple square queen-cage, a number of which I made in 1865, and one of which I made in that year I exhibited at our great Bee Show at the Crystal Palace. This cage is pushed into the honey-comb in the bottom of the cells; there is a sliding door at one side, which can be drawn up when desired with a wire passing through the feeding-hole, without disturbing the bees clustering round the cage, and the queen walks out of the cage at her leisure surrounded by her body-guard.

This cage our esteemed Editor says, on page 93, 'appears to us to be more nearly what is required for introducing alien queens,' as the cage is pushed into the honey-cells, and the bees can always get to feed the queen. With the long queen-cages he says, 'We confess to having had no experience with cages of this kind, being always fearful that the queens confined in them might possibly be

starved to death, since they contain no honey or other provision; and it is singular that bees which would instantly kill the caged sovereign if they could get at her, should be expected to feed the usurper through the bars of her prison.' I think our Editor forgets (but he is so very clever that there are few things that he does forget) that I said on page 189, 'During the confinement of the queen, she can pass from one end of the cage to the other, which touches the *honey-comb* at each side near the top from which the bees can get food when required, and the cage reaches down to the very centre of the brood-nest, which is the warmest part of the hive.' As I never run any risk of the bees not being able to get to the food, so I pour a few drops of sugar syrup down one side of the cage every twelve hours, the bees in the cage with the queen fill their honey-bag with this syrup and are constantly feeding the queen from that store, as it is well known that a bee will give to its beloved queen the last drop of honey stored in a hive, and perish of hunger itself. What a lesson this is to teach young people to succour and help their parents, who have done so much for them!

Mr. Raynor, on page 119, is also mistaken in ascribing to a 'Renfrewshire Bee-keeper' the invention of queen-cages for introducing alien queens to hives without disturbing the bees, as I understand 'Renfrewshire' to say on page 118, he had never made one until about April this year after my queen-cage made in 1864 was illustrated in the *Bee Journal*.

I do not know with what material the cages are made 'Renfrewshire' has sent to Mr. Hunter and Mr. Abbott, but it is a very remarkable thing that two of our cleverest bee-masters should both of them find the Ligurian queens dead in them the first time they used them, as I have never once lost a queen in my perforated zinc or wire-net cages, and I have united thirteen queens all successfully in one night, but my cages are more than double the length of 'Renfrewshire's.'

Mr. Hunter, our clever and honorary secretary, in a letter to me says, 'The "Renfrewshire Bee-keeper" kindly sent me one of his cages last week, and I immediately made use of it, but found the queen dead next morning, and on mentioning the subject to Mr. Abbott, singular to say he had met with the same experience.'

Hundreds of my queen-cages have been made since April, as the instructions I gave for making them were so very clear and simple that any one could make them for the benefit of bee-keepers; and they have saved the lives of numbers of Ligurian queens this autumn.—WILLIAM CARR, *Clayton Bridge Apiary, Newton Heath, near Manchester*.

[Our valued friend facetiously gives us credit for good memory. Well, we do not forget that the space naturally left by bees between honey-combs, such as are usually found on the top of hives, is barely a quarter of an inch; and that, consequently, when a cage of three-eighths thickness is thrust into it, some of the cells must be broken, and the honey set running, and that such running honey will often cause the death of both the queen and the bees confined with her; they get choked with the sweets they cannot remove from each other. Supposing, however, that the cage be so placed that the queen, or her accompanying bees, can get at honey through the

bars or holes in their cage—should it be forgotten that bees will not tolerate a crevice or space in a hive, into or through which they are unable to crawl; and that, consequently, wherever the cage is made to touch the comb, the bees immediately claim a 'right-o'-way' round it, and cut down and shorten the cells until such way be made? And in this case what is to become of the queen? We do not forget that, as a rule, bees will part with the contents of their own stomachs to feed the queen; but in introducing alien queens from a long distance, it often happens that the accompanying bees are too dysenteric to be of service either as attendants on her person, or as caterers to her appetite. This may often be seen, when queens are first caged, on the combs, after a short absence from their boxes; for they will in such cases dive headlong into the open honey cells, and help themselves, notwithstanding the popular notion (now exploded) that queens cannot feed themselves.

Our esteemed correspondent seems, however, to be aware of this, and cautiously administers food during the queen's incarceration; and so, while ensuring that she shall not *starve*, aids in rendering her acceptable to her future subjects.—*Ed.*]

### CONDEMNED BEES.

A neighbour who kills his bees at the fall for their honey, at my request gave them to me instead this year.

I put them, Sep. 29th, into a bell-glass observatory hive in my dining-room. I did this as an experiment. There were six frames in the bell-glass. I kept them supplied with sugar syrup. In three days two bars, in six days five bars, were filled; they then brought in pollen fast for the time of year. On the twelfth day much of the comb containing syrup was sealed over; and so the hive has progressed to this day, the eighteenth day, when they are busy, noisy, and active as if it was June. I cannot help thinking that, with pains, very much may be done with late swarms, and such experiments as mine, and that, when successful, they will contain more late young bees than other stocks.

The 'missing link' in scientific bee-keeping appears now to be to me 'an artificial pollen' which bees will accept. At this time of the year, with a mild fall, with artificial pollen, breeding might be sustained. I hope you will devote attention to this in the *British Bee Journal*. Rye-flour I have never succeeded in getting bees to accept.—*F. W., West Bromwich*.

### A MODEL APIARY.—PROPOLISING. THE QUILT.

There are, I am sure, many enthusiastic apiarians who would, like myself, be very pleased to learn your idea of a model apiary, say extending over at least half an acre of land. I should like to see it laid out in an effective manner—query, whether with straight or serpentine walks, and how the shrubs, which should be flowery, should be dispersed? Many of your correspondents, better able than I, could give suggestions as to the peculiar details necessary to procure a model.

It strikes me that something might be invented to prevent the great annoyance of bees propolising the frames to the top-board or quilt. It does not appear to me to be at all natural to pile up a heap

of carpets, blankets, and feather-pillows; in fact, a bed complete on the top of hives, to keep in heat and perspiration. I am not wishing to advocate the board, but really I prefer, in this instance, the 'board to the bed.' I wish some inventive genius would try to remedy this unnatural evil. Has no one yet discovered that so much bed material engenders the moth?

Another query.—Is there any fixed standard for the width of frames? I found some at the late Exhibition were  $\frac{7}{8}$ , 1, and  $1\frac{1}{4}$  inches; so also with the interspace, some were  $\frac{1}{2}$ , some  $\frac{5}{8}$ , and some nearly an inch. Surely, if scientific rules are to guide us there ought to be a fixed standard for both stock hives and supers? Will some of your correspondents give me their experience on these matters?—CHAS. H. EDWARDS.

[NOTE.—Replying to our esteemed correspondent, we inquired as to the shape the proposed apiary should be. We also assured him that the quilt arrangement was intended to secure ventilation and not to prevent it; and further, that the width of frames had nothing to do with their relative value as comb receptacles, since it is the distance from centre to centre of them *alone*, which is important. His reply gives such an excellent outline of what an apiary should be that we append it.—ED.]

#### MODEL APIARY.

I think the shape should be either a square or parallelogram. It should also be laid out as a garden, in plots, holding the best flowers for the use of the bees, viz. borage, mignonette, &c., and instead of grass, clover (white) should be adopted. Flowering shrubs, fruit-trees, or hedges, should be so dispersed that ladies and persons frightened of bees could walk about the different paths without getting in the direct line of the bees' flight. Water is indispensable, round which the flowering palm, alder, &c. could be planted.

I have no doubt there are many apiarians residing in the country who would be pleased to devote at least half an acre to their favourite hobby.

As to the bed-cloths on top of the bar-frames, it appears to me the most unnatural mode of ventilating that could possibly be thought of. Adopt some means by which the bees cannot, or will not, propolise the top bars, and away goes the bedding.—CHAS. H. EDWARDS.

[We do not quite understand why doing away with propolising will render the quilt useless. Pray enlighten us.—ED.]

#### PRACTICAL VENTILATION OF HIVES GENERALLY.

Of all questions of interest and practical utility upon bees and bee-hives, either of wood or straw, there is not one of such magnitude and importance as that of ventilation. There have been from time to time many able theoretical articles written upon the all-important subject of ventilation, but not one gives, in a concise and practical manner, the best and simplest mode for ventilating our hives, both wood and straw, but especially the former.

I have for many years given my attention to this subject, and, through the want of employing a thorough means of ventilating without a direct draught, have, no doubt like many other apiarians, met with

great misfortune. To ventilate thoroughly, it is necessary to make provision to admit a regular supply of fresh air, and which should at all times be admitted at the lower part of the hive. It is proof beyond doubt to all practical minds that the air admitted from the usual contracted entrance is not sufficient for purifying purposes, therefore let four holes be cut out with an inch centre-bit two inches from each corner of the bottom board of the hive, over which place pieces of fine perforated wire or zinc. Here, then, at once we gain the admittance of pure air and upward ventilation, without a direct draught, and in sufficient quantity to keep the hive ventilated, without becoming chilled, which is the grand thing to guard against. These inch covered holes, acting as drains to carry off any condensation which runs down the hives on to the bottom board, tend to keep it thoroughly dry.

Now, for straw hives, I have generally found this sufficient, but for large wooden hives I place in addition over the feeding-hole a three-and-a-half inch square zinc dish, with a rim one inch high, having a two inch circular hole in the centre, also with an inch rim, and inverted upon this is a tin or zinc can (similar to a child's penny tin mug), three inches diameter and three inches high, having a small piece (half an inch) cut out of the rim, to enable the moisture, if any, to run down the sides of the can, and through this small hole into the square zinc dish.

By all means, avoid using glass in place of the tin can, for at least two important reasons: 1st, it admits too much cold air; and, 2ndly, the bees, seeing the light through the glass, are enticed or attracted up into it, they become chilled, drop into the moisture in the zinc dish, and meet their death by drowning.

To those, like our amiable Editor, who use and prefer the 'bedding' system, I quite think a pillow over the feeding-hole will answer the purpose, but let me advise those who adopt this plan to beware how they let the pillow get sopping wet, for if this happens, and a severe frost arrives, the pillow will become about the same thing as having a small block of ice placed upon the top of their hive, the result of which may be by an intelligent mind easily imagined.

I have now, in as plain language and simple a manner as possible, stated my views upon this important subject, and I am of opinion that if the readers of 'Our Journal' will fairly try this plan for themselves, they will no longer have to deplore the loss of their hives in winter, and, most probably, mouldy cobwebs and foul brood will become unknown in their apiaries.—CHAS. H. EDWARDS, Nov. 1874.

[We fear this system of admitting cold air into the coldest parts of the hive will not meet with general approval. The holes would, doubtless, carry off condensed vapour; but would they not tend to create it? Providing an exit for the wet is admitting the fact of its presence. WE want to get rid of the vapour before it condenses, and mean to do it, too, by some means or other.—ED.]

#### IVY HONEY.

I should be very greatly obliged if some bee-keeper of experience will kindly favour me in the next number, with their opinion as to the use of ivy



honey to the bees, that is, if they are able to make use of it in the winter and spring. With me it has been quite a second season: and in most of the hives there are two or more frames completely filled with it, which, as usual, crystallized at once, so that the combs are a solid mass when the hive was opened. As the hives were amply stored previously, this was considered useless by me and in most cases destroyed, but I have left a few combs to try the experiment. Is ivy honey considered unwholesome? As, although I would not eat it myself, there are many people will, but I have hesitated to give it away.—E. W., *Suffolk Street, Dublin, Nov. 23, 1874.*

#### MR. COWAN'S SYSTEM OF WORKING THE WOODBURY HIVES.

In your reprint from the *Times* of Mr. Cowan's extraordinary honey harvest, he (Mr. Cowan) offers a description of his system of working the Woodbury hives. Would he kindly give you his system for publication in the *British Bee Journal*, as I am sure your many readers would be highly pleased and only too glad to follow his instructions, if only to reap half (on an average in this part) of the super honey he has succeeded in doing?—A LAKE LANCASHIRE BEE-KEEPER, *Nov. 17, 1874.*

#### HEATHER HONEY AND THE EXTRACTOR.

In replying to the inquiry addressed to me, p. 124, concerning 'heather honey,' I will revert to the expression used,—it was, 'when beginning to cool down, and consequently to thicken.' Now I do not for a moment entertain the idea, that the same honey, when newly stored, will not 'sling'; it is when in that state, which may,—very aptly,—be compared to 'half-cold glue,' that it is above the ability of the Extractor. To prevent any misunderstanding as to the quality of the honey operated on, I will give you the details of one experiment (among others) which I tried. An empty super, which was put in on the 18th of August, was taken off on the 16th of September filled with comb, the cells of which were all nearly filled with pure heather honey, very few being sealed, and on that account not so marketable (I may explain that, three or four days after putting it on the weather came stormy, causing the bees to desert it); such, then, being the case, to sling the honey out and preserve the comb was the best policy. After repeated trials to sling it, I put the machine to what may be called 'high-pressure' speed, and on examination I found a good many nodules of beautiful amber-coloured honey projected about a third way out of the cells, with a very few empty. That heather honey does coagulate more readily than any others with which I am acquainted, and is also vastly more difficult to bring back,—if indeed possible, without damage to the comb, is quite in accordance with my experience, as also that of all my bee-keeping acquaintances.

Now I would ask, if it is implied in the second query, that it is possible to be dripped when of the consistence mentioned above? if so, the problem of

how to sling it is solved at once, and an ultimatum reached that is very much desired by—OCTAGON HIVE.

P.S.—I forgot to mention that the date at which I made the experiment above mentioned was the 24th of September.—O. H.

[Our query was intended to elicit information on the means by which heather-honey is obtained in a liquid state. There were some beautiful samples of it at the Crystal Palace as liquid as that from the white clover, which sufficiently proves that there is a time when it is in a condition capable of being acted upon by the Extractor. The above experiment proves nothing more than was already known since it took place eight days after the honey was removed. Our argument is, that as heather-honey can be drained from combs by the simple power of gravitation, so there must be a time when it can be extracted by the application of centrifugal force; and the inability of those who have not taken advantage of the *fact*, to get their honey from the combs, does not in the slightest degree detract from the value of the machine. As well might a carpenter who neglects to use his glue while it is hot, complain because it becomes so thick that he cannot use it.—ED.]

#### NOTICES TO CORRESPONDENTS & INQUIRERS.

D. W., *Ilfracombe*.—The hive you mention is in the same category with the Woodbury, and containing, as it does, the notches, racks, and rabbets, together with the stupid provision for the bees to pass above the frames, which space they invariably fill up, if they can find material to do it with, we feel obliged to object to it. There are plenty of good hives in the market, but the selection must be made in accordance with your taste and means, and the nature of the locality as a honey-yielding district in which you reside. A hive on the principle of the three-shilling cottager's hive would do well to begin with, and with an outer case round it, and dead air-space between, a substantial floor-board, a set of quilts and a roof, it would be equal to the very best as a bee domicile. If ornament is desired, or convenience in manipulation, then a more elaborate hive, and more expensive, may be had; but the bees do not require anything more than may be obtained for a few shillings. For gloves, veils, and feeders, please refer to advertisements.

We are favoured by Charles Edwards, Esq., of 29 Oakley Square, London, with the promise of a description of the means by which lateral movement of the frames in a hive may be obtained without the use of, or necessity for the movable dummy, which has proved so useful in manipulation. Mr. Edwards's arrangement will be fully explained in our next.

BUSY-BEE.—Quilts, as we have so often repeated, may be made of any material of hard texture. India matting is commonly used, but old carpet is generally recommended, because it puts to use a material which is otherwise useless. A straw pad would do very well if it did not permit too much ventilation; the rush fish-basket material is objectionable, because bees can bite it away, or if propolised, it will tear on removal; besides, it is of a stubborn nature, and will not lie flat. As a material for piling on the quilt it will do famously, as will other that is light and porous.

A LANARKSHIRE BEE-KEEPER.—We deeply regret that owing to the engravings being unfinished, the description of your excellent hive must remain till next month. Communications from—A Renfrewshire Bee-keeper; Busy Bee; C. E. P.; S. Arbroath; C. H. Edwards; B. M. B., Philipstown; J. W., Rochdale; A. D.; with articles on the Honey Market, the Latest Hive, &c., are unavoidably postponed.

We trust that those whose subscriptions are in arrear will oblige us by forwarding them during the month.

## BRITISH BEE-KEEPERS' ASSOCIATION.

A MEETING of the Committee took place on Thursday afternoon, Nov. 19. There were present, W. T. Cowan, Esq. in the chair, Messrs. Atlee, W. Abbott, Cheshire, Hooker, and Symington, with the Secretary and Treasurer. The minutes of preceding meeting were read and confirmed.

The Secretary reported that Mr. Cheshire had delivered a lecture on 'The Honey-bee' at Ealing, on Nov. 10, in behalf of the Association, which was listened to with extreme attention, and created much interest. J. M. Hooker, Esq. and the Treasurer were present.

The Secretary produced a statement of accounts, which showed a balance in favour of the Association of 57*l.* 1*s.* 2*d.*, which had been paid to the Treasurer's account.

A discussion then ensued with regard to the 16,000 circulars that it had been previously agreed should be sent out, the cost of which was said to be about 65*l.* to 67*l.* including postage and directing. Towards this amount about 35*l.* had been subscribed by advertisers; and it appearing possible to defray the whole cost by means of advertisements, on the motion of Mr. Hooker, of which the Secretary had received notice, seconded by the Treasurer, it was resolved that the sending out of the circulars should be deferred until sufficient advertisements were obtained to defray the whole cost. Exception was taken to this course by the Secretary on the ground that some of the advertisements promised were conditional, and that delay in publication would cause their withdrawal; but it appeared to the majority that if the thing could be sent out without impinging on the funds of the Association, the advertisers, some of whom had expressed great sympathy with the movement, would not object to a trifling delay, especially as the desire was to save the Association funds; and the Secretary was requested to write to the whole of the advertisers in that behalf, and explain the *reason* of the delay. The meeting then adjourned until Dec. 8, 1874.

### OUR WANT AND SALE COLUMN.

This column is open to Subscribers only, to enable them to purchase or dispose of surplus apicultural property.

There will be no charge for advertising articles for sale, but if they be not sold, the advertisement may remain for three months, after which it must be withdrawn, or the prices of the articles reduced.

WANTS may be advertised at 2*d.* per line of eight words, for one insertion, renewable in succeeding months, for three months, without alteration, for half price. Replies must contain stamped directed envelope, or they will not be forwarded.

The names of advertisers will not appear.

All monies must be deposited with the Editor, who will communicate with the vendor, when, if a sale be effected, one penny in the shilling will be charged on all amounts not exceeding one pound, and one halfpenny additional will be charged on every shilling beyond that amount, and the balance forwarded to the vendor.

Should no sale take place, the money deposited will be returned to the depositor, less a uniform charge of fourpence to cover postage.

The carriage of all articles sent, except such charges as are incurred in first placing them on a railway, must be paid for by the depositor, and if not equal to the description given, the advertiser must pay the cost of their return.

The postage of small articles, such as books, must be prepaid by the sender. This will not apply until after Jan. 1, 1875. The name of the town or country in which advertisers reside, and the name of their railway, should be mentioned as a guide to probable cost of carriage.

No advertisement must contain more than sixteen words. P. O. Orders to be made payable to C. N. ABBOTT, office of *British Bee Journal*, Hanwell, W., London.

### SALE COLUMN—CONTINUED.

No.		s. d.
96	Half a dozen strong well-made straw hives, flat tops, with hole in centre. Lincolnshire ...	12 0
97	Square queen-cages, perforated zinc, to release queens within the hive, the most simple ever made, 6 <i>d.</i> each ... .. per dozen	5 0
98	Wanted.—A large quantity of Puff Ball, undried.	
99	Wanted.—Evans' Poem on Bees, either to purchase, or on loan at per month. Security given.	
100	Wanted.—Vol. I. 'American Bee Journal.'	
101	Wanted.—Two healthy stocks of Black Bees. Good condition, low figure. Great Western Railway.	Good
103	Two of Taylor's dividing hives, stained and varnished, fitted up with 8 improved bar-frames ... .. each	10 6
104	Two Swiss bar-frame hives painted, with 8 bar-frames and floor-board ... .. each	8 0
105	Two Neighbour's zinc bee-feeders with floats each	2 6
106	Two Neighbour's fountain zinc bee-feeders with floats ... .. each	3 6
107	'The American Bee-keeper's Manual.' By J. B. Miner, 350 pages, with 35 engravings	6 6
108	'The Management of Bees.' By Samuel Bagster, 2nd edition, 240 pages with 40 engravings ... ..	6 6
109	'An Inquiry into the Nature, Order and Government of Bees.' By Rev. John Thorley, 2nd edition, 176 <i>s.</i> , 158 pages ... ..	4 6
110	Huish's 'Cottage's Manual,' 104 pages ...	2 6
111	'Boscawen on Bees; or, the Self-filling Money-box,' 16 pages ... ..	1 0
112	'Bees: their Management and Culture.' By Mrs. Tupper, 40 pages ... ..	1 6
113	Carr's improved mahogany observatory revolving bar-frame hive, second hand ...	60 0
114	I will exchange any of the above duplicate books (107-112) by Bonner on Bees, which I have read, but have not got a copy of my own.	
115	Wanted.—A Second-hand perfect Stewarton hive complete.	
116	'American Bee-keeper's Manual.' A practical work, 350 pages, numerous illustrations, post paid ... ..	6 6
117	'Langstroth on the Hive and Honey-bee.' Almost new, but has one plate missing ...	9 0
118	Wanted.—Any quantity of empty worker comb. State price to C. J. Smith, Stroud, Gloucestershire.	
119	Box Hive, containing 2 stock-boxes, 2 medium supers, and 4 small ditto, with access from stock-boxes to each or all of the supers, small window in each ... ..	15 0
120	Neighbour's improved bar and frame stock hive straw, with wood frame and one window ...	20 0
121	Wanted.—Dr. Dunbar on Bees. State condition and price post free.	
122	Two strong stocks of hybrid Italians in new hives, heavy enough to stand the winter, each	45 0

### ON SALE.

No.		s. d.
69	'Tayler's Manual of Beekeeping' ... ..	3 0
70	'Neighbour's Bee-book' ... ..	2 6
71	'Huish's Bee-book' ... ..	2 6
72	'The Female Monarchy.' By Rev. John Thorley	2 6
73	'Bevan on the Honey-bee,' last edition ... ..	5 0
74	Murphey's Honey-extractor ... ..	80 0
81	A Pettigrew hive, quite new, 18 in. dia. ...	4 0
82	Some beautifully white honey-comb of this year, per lb. Exeter ... ..	1 6
88	Super-boney from Palace, run into jars, any quantity, per lb. Droitwich ... ..	1 6
89	Eight of Neighbour's bee-feeders, mahogany floats, top glass, all complete, at ... each	2 0
90	Woodbury bar-hive, 10 frames, two windows, hinged covers and floor-board, complete ...	12 6
91	One straw ditto, 10 frames, one window and floor-board, good as new ... ..	14 0
94	A strong stock hybrid Italians, in straw hive	18 0
95	A strong stock black bees, in flat top straw or wood hive, with glass windows. Lincolnshire	15 0

# British Bee Journal,

## AND BEE-KEEPER'S ADVISER.

[No. 21. VOL. II.]

JANUARY, 1875.

[PUBLISHED MONTHLY.]

### Editorial, Notices, &c.

#### JANUARY.

Those who wisely took time by the forelock and gave their bees the attention and assistance necessary to prepare them against the effects of our changeable climate, will have little to fear in their behalf now that winter has come upon us in earnest, since if properly protected, cold alone will not be injurious to them. When bees are fairly strong, well provisioned, and well protected from the rain, one would think that if cold could not injure them, they would be secure from all danger, save accident, and in properly equipped hives this is so; but in very many instances, through inattention to their sanitary condition, the hive becomes the tomb of its inhabitants. The intense coldness of the present northern visitation, which has now continued, with greater or less severity, for more than a fortnight, will afford a splendid opportunity for comparing the various methods adopted in wintering bees; and when the thaw occurs the condition of hives should be immediately examined and noted, as experience thus gained will be most valuable, but, in many instances, it is to be feared, will be found extremely costly also.

SPACES ABOVE FRAMES.—The insanitary condition alluded to is caused by a fault in the construction of hives, by which space is provided between the frames and the crown-boards, ostensibly that the bees may find an easy means of transit above their nest, from one comb to another, or to any part of the hive, and the theory is a sufficiently plausible one to ensure a large following. It *does* seem convenient; and if the bees would accept it no one ought to say a word against it, but *they do not*, and *never will*, and their *protest* ought to be regarded; instinct teaches them to block the space with comb or propolis, which they do almost invariably, plainly telling us that the space is not required by them, and ought not to be allowed to exist. The matter has been repeatedly argued in this Journal, so need not be pursued here, as it is too late now to make much alteration in

inhabited hives; but what we wish our readers to do is to carefully note the conditions of their various hives, *when the frost comes to an end*, and to report thereon for the benefit of the bee-keeping world. The great point to which we would direct attention has regard to *the value of the space above the frames*. Has it *any* value except in theory? and if it has, which we cannot admit, are not the inconveniences which arise from it in manipulation, and the evils which it causes within the hive, sufficient to outweigh any good there may be in it, and condemn it altogether? Compare such a hive, when the space is really *open*, not one in which it has been crammed with comb by the bees, but one from which the bee-master has, as is usual, removed all such *impedimenta* to manipulation, with a hive covered with a close-fitting crown-board—a simple box hive will do, in which the crown is fixed, and to which the bees have attached their combs, and note the difference. In the former, the heated vapour which has been produced by the bees will have risen to the crown-boards, and dispersed itself all over the inner surface of the hive and outer combs, which will be dripping or sodden with moisture, the bees will be in a distended condition through having been obliged to consume enormous quantities of food to keep heat and life in their cluster, and the whole will bear a most melancholy appearance; whereas in the box hive, although there may be some signs of dampness such as would be caused by the influx of a moist atmosphere, and perhaps a trace of moisture at the corners through want of upward ventilation, the aspect of the bees will compare most favourably with the other stock, and it will be found that they have not consumed more than half as much honey, and consequently will not be so nearly worn out. The reason of this is easy to explain; in the box hive there being no space above the frames over which the heat of the clustering bees could escape, but the combs being built close up to the crown and some way down the sides of the hive, the interstices between them acted as (inverted) reservoirs for heat, which being thus economised, rendered inordinate consumption of food unnecessary,

and prevented the evolution of vapour and deposition of moisture consequent thereon.

**CROWN-BOARD AND QUILT.**—Comparison might also be usefully made between hives on which crown-boards and quilts are respectively used. Leaving out all question of the material of which quilts should be made, and only stipulating that they shall be non-conducting and porous, that they shall be of sufficient number and thickness to be protective, and that nothing shall be placed upon them which will hinder gentle upward ventilation, (we mention this because an erroneous opinion obtains, that the crown-board should be placed *on the top* of the quilt) there can be little doubt but that such comparison would be particularly instructive. Our own belief is that the quilt properly applied will prove the crown-board to be a huge mistake, and that it will lead to its entire removal. Better by far use the Stewarton slide to fill up the spaces *between* the top bars, as is usual with the Stewarton hive, for general use, which slides may be withdrawn during winter, and the bars covered with ventilating material after the manner recommended by 'A Renfrewshire Beekeeper' in his description of the Stewarton hive and system. But it is not now our purpose to vaunt the merits of any of the many means recommended for preserving hives in a healthy condition during winter, *they are on their trial*; and let us all strive to ascertain without prejudice, and judging only by results, which is the best, and most commendable for future use.

**WET HIVES.**—As it is a matter of certainty that many hives will, on the termination of the frost, be found reeking with moisture, which the bees will be quite unable to expel, it would be well to advise a means by which they may be assisted. Hives in this condition will be those in which, from absence of outer protection, or through no means being afforded for the escape of heat from the cluster, the bees have been compelled to *renew the wasting heat* by the consumption (combustion) of extra food (fuel), and such hives will not only be found miserably cold and damp, but the bees in them will be distended, and dysenteric also. In a fairly dry healthy hive, half-an-hour's warm sunshine would rouse the bees to a state of activity, and they would be enabled to take wing and cleanse themselves; but in a cold wet one, a whole day's solar heat, such as is possible in January, would scarcely affect the inhabitant bees, and consequently they would continue damp and disorganised, and dysenteric would certainly supervene, and death, in time, would be the result.

**DRYING HIVES.**—It may be accepted as a physiological fact, that dysenteric bees cannot relieve themselves, except when on the wing, and the puzzle is to give them an opportunity

for flight, yet to ensure their return to their hive. The Americans do this by placing the disorganised stocks in a heated room, and fixing a bee-proof wire cage of large dimensions to the entrance of their hives, so that bees may take short flights and yet not get from within crawling distance of their home, and it is usually found that when darkness comes on all the bees which have life return to their domicile. The cage, of course, under such circumstances requires thoroughly cleansing before being again used; but if carefully managed its use will not have been in vain, as in addition to the relief afforded to the bees, the hive and combs will have become much dryer and more healthy and the general tone of the stock improved. Another useful plan is to close the entrance of the hive with perforated zinc, take it into a warm, well-lighted room, near (but not too near) a brisk fire, and turn it about occasionally, so that it may be thoroughly warmed, remove the zinc from the feeding-hole, and place upon the hive a large propagating bell glass inverted on a large board, in which the bees can fly without escaping, when hundreds will obtain the necessary relief, and eventually return to their hive, which will be greatly benefited by the warming. It would be well to cover the open feeding-hole with a small concern like a toy table from a doll's house, so that bees may pass freely, yet the dropping filth be prevented falling into the hive. In all cases the substitution of dry floor-boards for wet ones is recommended; but when the hive itself is in a reeking condition the exchange of floor-boards will afford but little relief, and unless it be possible during a warm day to transfer the contents of wet hives to dry ones, resort *must* be had to some means of drying them artificially, see p. 151, vol. i.

**QUEEN CAGES.**—It is almost a pity that the discussion on queen-cages and uniting queens now going on in this *Journal* should take place at a time when it is almost impossible to experiment with them. At a Beekeepers' Convention in America some years since a member began to ask, 'Do bees invariably —?' when Mrs. Tupper cut him short with a trite remark which has become a proverb, '*Bees do nothing invariably,*' and in uniting queens this is especially true, 'So unaccountable and past finding out are the instincts and actions of our little favourites.'—*Vide letter on Queen-cages*, p. 154. What caused the death of the queen first placed in the cage kindly forwarded to us by 'A Renfrewshire Beekeeper' it is impossible to say; it is possible that '*her time had come,*' and that she would have died just as soon if she had been left with her own retinue. It was unfortunate that Mr. Hunter should have had a similar experience on his first attempt with a simi-

lar cage, but neither of these cases disproves the theory advanced, for in two instances during the past month we have proved beyond the possibility of a doubt that bees will *sometimes* feed alien queens, if not *invariably*. To try and save the life of two beautiful Ligurians two Royal Blacks were dethroned, and the queens, placed alone in the Renfrewshire cages, were thrust one upwards from below into the cluster of bees in a skep, the other, from above, amongst the bees in a Woodbury hive, and these two queens, although left nearly five days in their cages, were as blithe and sprightly when set free as when first engaged. Accepting, then, the principle that bees will feed alien queens,—a principle which until the appearance of the new cages, supported by the evidence of Mr. Carr and ‘ARenfrewshire Bee-keeper,’ we had not sufficient faith in, to intrust the life of valuable queens to the tender mercies of hostile bees, but which is so thoroughly borne out by the Rev. George Raynor as to be indisputable, we look upon the *modus operandi* of the latter as a most valuable contribution to the science of queen-uniting. Catching the queen to be deposed and imprisoning her until the attention of the bees is concentrated upon the cage which confines her, then, without any disturbance of hive or combs, but by simply opening the top of the cage and allowing her to come out of the hive, to be substituted by the *alien* queen, is a master-stroke in *bee-management* which must commend itself to all thinking beekeepers as the most likely means of ensuring her safety when released, particularly as the release is effected without any interference with the interior of the hive.

### THE NEW YEAR.

We cannot forget that by the time these pages are in the hands of our readers, a new year will have dawned upon us, and 1874, with all its associations, will be of the past. In looking back we see much cause for rejoicing, for great things have been accomplished, amongst which may be reckoned the Crystal Palace Show with the wonderful exhibition of live bees, the introduction of the Honey Extractor, and last, but not least, the establishment of the British Bee-keepers’ Association on, we trust, a firm basis. These events will make the past year great in the history of British bee-keeping, and will stamp it as the commencement of a new era, in which Apiculture has asserted itself, and taken rank with the sister sciences, with which we hope in the future it will always be associated.

And now, while elated with past successes, and filled with the holy pleasure which always

waits upon the commemoration of the advent of Him who blessed this happy Christmas time, by His coming bringing peace on earth, goodwill towards men, shall not we, in the charitable spirit begotten of the time, endeavour to forget any little injuries and annoyances which may have grieved us in the past, and throwing aside all its feeling, unite in a common brotherhood, as becomes Christian workers in a good and noble cause? We are on the threshold of another year; 1874 is past, and with it let us bury all unkindness; 1875 is before us, big with events which time only can bring to light, and upon ourselves will it depend whether they shall be precious or otherwise. Christmas is past, and we have all doubtless shared in the mirth and good wishes so rife during the merrie season; and now let us all in pure good fellowship join in heart and mind in wishing and striving to make the year just ensuing a happy one for all bee-keepers.

### APIARIAN MARKETS.

In the first No. of the *British Bee Journal*, p. 17, a far-seeing correspondent, ‘H. W. T.’ amongst the many useful proposals there made for the improvement of bee-culture, after recommending the formation of a Bee-guild, which has happily been established under the name of the British Bee-keepers’ Association, suggested, as ‘part and parcel of the same scheme,’ the establishment of ‘a central market or depôt for the sale and purchase of bees, honey-comb, honey, and every kind of bee-gear, which should insure to all members wishing to sell, honourable and practicable endeavours to obtain the highest market prices for their deposits, and likewise to those members buying, the assurance of being supplied at fair and honourable market prices.’

Now, although deeply sensible of the advantages that must necessarily result from increased competition in the production of bees, hives, and bee-gear, and from the establishment of means by which surplus bee-produce may be readily disposed of, we hesitate before accepting permanent centralization as the best means of their attainment. As regards hives and bee-gear, manufactured as they are in almost every part of the United Kingdom, and being, moreover, everywhere (?) required, a central market for their sale and purchase would be both disadvantageous and impracticable: disadvantageous because of the expense incurred in the transit of the goods to and fro, and impracticable because of the immense space which would be required for storage, and from the certainty that many hives would not find purchasers. The establishment of depôts or museums, where specimens of hives, &c., could

always be on view on payment of a small fee, and at which all necessary information could be obtained, would we think be sufficient for the purpose, and such museums could, we think, be easily established at all the great places of public resort—to wit, the Crystal Palace, the Alexandra Palace, and the Agricultural Hall—in or near London, and at corresponding institutions in the principal country towns. Furthermore, stalls might be appropriated for similar purposes at the great agricultural or horticultural meetings throughout the country, and such measures would soon work a radical reform in bee culture, and gimcrack bee necessities, which are simply traps for the unwary, and always produce disappointment and disgust, would soon be out of the market. A central market for bees would be still more impracticable, on account of the difficulties and dangers attending their transport, and the unwillingness of bee-keepers to entrust their bees in the keeping of strangers—added to which a permanent bee-market could not be held in a town for obvious reasons; it must, therefore, be sufficient for those who wish to dispose of their surplus stocks, and for those who wish to purchase bees, that a cheap means of advertising may be available, such as is offered by 'Our Want and Sale Column,' or may be found in the pages of the *Bazaar, Exchange, and Mart*, published in London.

The establishment of honey markets, as means by which the produce of bee-farming may find ready purchasers, is however not only practicable, but they are becoming absolutely necessary. From all parts of the kingdom the cry is raised, 'What are we to do with our honey?' not because honey is not in demand, but because the producers and the would-be consumers are not brought into contact. It was hoped that at the great Crystal Palace Show in September last, the honey-fair, which we had all along considered one of the most important features in the programme, would be thoroughly established, but it was practically nullified through its requirements not being understood, and the opportunity for stimulating bee-farming, by establishing a ready means of sale for its produce, was completely lost sight of in the glare and glitter of THE SHOW. Never before was such a splendid exhibition of honey produced in England as was on view and on sale at Sydenham during those three jubilant days; but the golden opportunity for gain was lost in the glitter; and the sale of honey, which ought to have been the chief consideration, was completely sacrificed to appearances, because it was 'a three days' show,' and therein lay the great mistake. Instead of a Bee and Honey show, it ought to have been called a Bee and Hive Show, and Honey Fair,

so that after a few hours devoted to exhibition purposes, the honey might have been sold and removed. Had it been possible to dispose of it in small quantities, there would have been few visitors who would not have taken home a taste. There were more than 25,000 persons who visited the Show during the three days, as will be seen from the statistical comparison shown on another page, and it is not unreasonable to compute that \* 25 per cent of them would have purchased on an average at least one pound of honey each, if they could readily have done so. But sales were restricted because the immediate removal of exhibits was interdicted, and it was only on the last day that any real business was done. It is true there were some of the exhibits sold, to be forwarded after the Show, but they were very few compared with what might have been disposed of if the sale of honey had been made, as it ought to have been, the leading feature. Another great error was the absence of salesmen, even on the third day. One exhibitor, slightly disgusted at finding his honey which had been ticketed at a really low figure, unsold, went into the avenue on the third day to make the price even lower than it was, but, judge of his surprise when immediately he began to handle it, it began to sell, and in less than twenty minutes, he had sold twenty-one jars of from four to seven pounds each. Another reason why so little honey was sold, might be found in the fact, that the supers which were principally of glass were neither portable nor convenient in size, and no provision had been made for breaking bulk. There were doubtless many who if they could have had one or two bars of the splendid honey from Ayrshire, would willingly have done so, but who could not afford to give from 35s. to 2l. for a whole super. Again, who would not have been glad to have taken a few pounds of Prize Honey? We must acknowledge to having had a very strong desire for a taste of a great many of the supers, and had it been possible would have sampled most of them for comparison, and probably many others would have done the same. But except the vessels in which the honey arrived at the Show there were no means by which it could be sent out again; and in the case of unfortunate exhibitors, whose supers or honey arrived in a broken and perhaps leaking condition, there were no means of preventing

\* The total amount received for commission on all sales at one penny in the shilling was about 7l., whereas, by the above computation, which is an exceedingly low one, and counting honey at one shilling per pound only, over 26l. would be realised by its sale alone; a sum which would well enable the Committee to provide an efficient staff of salesmen and clerks, and would guarantee the permanence of the institution.

the continued waste, whereas had they, been provided, the leaking honey which arrived might have been strained, and packed in jars, and sold, or returned to its owners. We know that great dissatisfaction has been felt at the smallness of the sales, and by many it is inferred that honey is not required,—that there is no market for it; but it is not so; if good honey is placed before the public there is a fair percentage who will buy it, and as a rule English honey is much preferred to any other; but, excepting at two or three large firms, London is without a means of obtaining it. The fruit and flowers which were exhibited side by side with the honey at the Palace were greedily purchased, and cleared away immediately on the close of the show, because they were portable, good prices being obtained, but the delicious honey that everybody delights in remained on hand.

There are egg, butter, and cheese markets, and there is no real reason why there should not be honey markets, and at the next Crystal Palace Show we hope the honey fair arrangements will be properly organised. It is manifest that except to the fortunate prize-winners, 'showing' honey which has to be returned unsold is an expensive and highly unsatisfactory proceeding; many doubtless were induced to send their supers to the Palace in the hope of selling them; and as it could not matter in such cases whether they were sold whole, or in small quantities, the committee had doubtless the option of so dealing with them. For such purposes, however, a staff of salesmen with weights and scales would be required, and some cheap boxes or jars in which the honey could be safely carried away. The senders of run or extracted honey might take a hint from preserve merchants, and send it in cheap vessels such as mugs, cups, cream-jugs, &c., so that, instead of the purchasers paying long prices for fancy jars or bottles which afterwards would be comparatively useless, they might for a few pence become possessed of an article of every day's use. Whatever in future is done with regard to the Show, judging from the experience of September last, we are thoroughly convinced that to make it a success a Honey Fair must be its most prominent feature.

#### OUR TRANSFERRING APPARATUS.

This novelty was invented to meet a necessity which often arises in transferring combs from skeps or box-hives, when from the weight of the honey they contain they cannot be fixed into the bar-frames without danger of collapsing. As is generally well understood, naturally built combs are *suspended* from the crown of a hive, and their attachments thereto are always

sufficiently strong to bear any weight of honey or brood which the bees are ever likely to put into them. It is also well known that honey is preferentially stored in the upper parts of the combs, and often renders them too heavy to be *supported* by the tender empty cells below. In such cases it is necessary, as in all cases of transferring it is advisable, to remove the honey from the combs before any attempt is made to fit or fix them into the frames. The only effectual mode of doing this is by the use of the Extractor; but before our apparatus was invented the repeated handling which such combs underwent in turning them over to unseal them and in introducing them into the machine, and reversing them while there, so that both sides of them should be operated on, so often rendered the combs useless, that some aid to transferring became a positive necessity. Honey extractors as a rule are so constructed that only one hand can be introduced into the revolving frame either to introduce or withdraw a comb, and it may therefore easily be imagined how with the fingers on one side of a heavy comb and a thumb only on the other, the cells would get squeezed and mutilated, and the comb itself rendered comparatively useless, as has oftentimes occurred. Our first idea was that a pair of wire frames to form a kind of sprat-gridiron, such as more luxurious delicacies than the name suggests are cooked in, in front of a fire, would answer the purpose, since, as is well known, the article cooking may be readily turned about without being touched. The first portion, therefore, was provided as above, consisting of a two-leaved frame, covered with wire netting on its outsides, and hinged at its

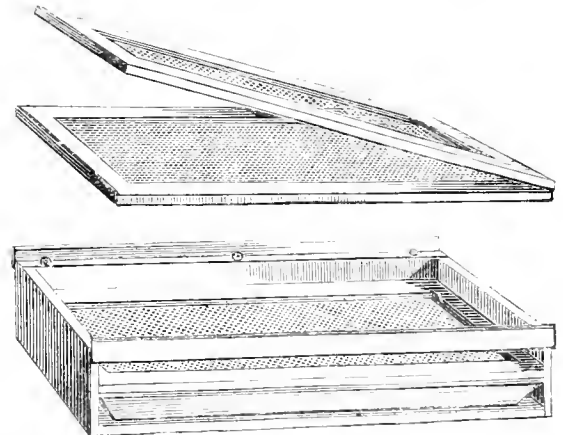

end, made of exactly a size to fit our Extractor, and by its use we were enabled to empty the smallest pieces of comb, and save them for future use. Once out of the skep, and laid in the wire frame, a comb need not be again touched with the hand, but may be unsealed,



emptied of its contents from both sides, fixed into a frame, and transferred to the bar-frame hive without it being necessary to handle it at all. As soon as the comb is laid upon the wirework, its upper side is unsealed, the frame is then closed, turned over, and opened, and the other side unsealed, the whole is then put into the extractor, whirled round, reversed, whirled again, and removed free of honey. The frame is then opened and the bar-frame applied, tapes are then laid upon the comb and frame, and the whole again reversed, when by the application of the necessary lath for the comb to rest on, the fixing may be completed, since the tapes will already be in their places. The lower part of the apparatus is not a positive necessity, since the wire frame may be laid upon an ordinary dish; but for comfort, and to prevent the bees getting into the honey, which *will* drip from the combs as it is being unsealed, a box, fitted with a tin dish, which is covered with bee-proof wire gauze, is provided, on which the wire frame rests, so that crumbs of comb may fall through, and bleeding honey find its way into the dish below without the possibility of injury to inquisitive bees. The comb space on the hinged frame is an inch in depth between the wires. The frame when placed on the box rests upon studs in its upper edges, which prevents the crushing of bees. A portion of the front of the box is removed to show the tin dish and wire-gauge protector.

### THE LANARKSHIRE HIVE.

Among the many excellent hives that were exhibited at the Crystal Palace Show in September last, there was one that through an unfortunate misunderstanding of and non-compliance with the rules by which the Show was governed, was not placed in competition; but since it contains several valuable features of approved utility, it decidedly merits attention and description. It was manufactured and sent to the Show for competition in Class 3, by our sometime correspondent 'A Lanarkshire Bee-keeper,' and with these credentials we need offer no apology for bringing it more closely before the bee-keeping public. In appearance it is somewhat like an enlarged Woodbury, but in construction it would seem that most of our objections to that hive had been foreseen many years since by the 'Lanarkshire Bee-keeper,' and avoided in the one under notice. It measures  $16\frac{3}{4}$  inches from front to rear, and  $17\frac{1}{2}$  inches from side to side, inside, its height is  $9\frac{1}{2}$  inches; and it contains eleven frames, and one division-board, or dummy. The crown-board is entirely dispensed with, and in lieu of it the tops of the frame-bars,

which are each fitted with the Stewarton slide, are made to do duty. The engraving will show how this is effected, for the Stewarton slides quite fill the spaces between the top bars of the frames and make the crown-board unnecessary. The ends of the frames rest on the

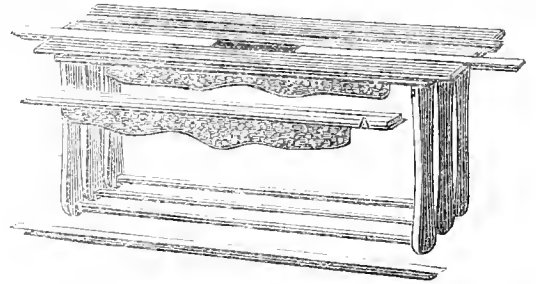

front and back of the hive, the top edges of the latter being deeply grooved along their centres to reduce their bearing surfaces, so that there may be less danger to bees when the frames are placed in correct position. The division-board is constructed with an elongated top, which rests upon the back and front of the hive in a similar way to the frames; and although of not more than half an inch in thickness its top edge is grooved on both sides to receive the Stewarton slide, so that it (the division-board) may be placed between any two of the frames, or outside the whole of them, and *fitted*, by running in the slides, in the most comfortable way possible.

The Stewarton slide when thus applied to bar-frames in hives of the Woodbury type, is particularly valuable, as it fulfils many duties, and dispenses with several of the *nuisances* of which we have always complained. It fills up the interstices between the frames and is removable at pleasure; it renders notches, racks, and distance-tacks unnecessary, as it preserves the distances between the combs in a most perfect manner, and ensures a rigidity not otherwise easily attainable. When cut in two, and each portion drawn outwards, it affords an easy means of administering food to the bees exactly over the cluster, and when supers are placed upon the hive the bees can be admitted to take them from any point between any of the combs. These observations will by many be looked upon as reminders only, since 'A Renfrewshire Bee-keeper' claimed all these advantages for the slide, in his able articles on the Stewarton hive and system, in the early numbers of the *Journal*, and their repetition is only incidental as showing the value of the slide when applied to the *ordinary* bar-frame hive.

As will be seen, *the sides of the frames are of greater width than the top bars*, and at their lower ends, where they touch and keep each other steady, they have exactly the width

which is required, for a comb covered on both sides with bees, the true distance of the combs from each other is always thus correctly kept, and by virtue of their peculiar shape the insertion of the division-board between any two of them, or outside the whole of them, forces them all firmly into their proper places. It will also be seen that the space *between* the sides (or ends) of the frames, is much less than usual, being only about a quarter of an inch; and as there is only about the same space between them (the frame-ends) and the front and back of the hive, there is little chance of comb-building going on anywhere except, where it is intended to be, within the frames. There is another feature connected with these frames, which is invaluable, and into which all hive-builders should stick 'the proverbial pin,' as it solves a difficulty which has stood in the way of the general introduction of wax-sheets for guides for combs, and will make their use a positive pleasure. Each of the frames is fitted with a false bar A, which is intended to lie close under the top bar proper: by taking a frame in the two hands in the ordinary way, and pressing against this false bar, the latter is pushed out into the fingers which grasp the top of frame; and when out it will be at once seen how simple and easy the whole arrangement is, and how valuable it must be as an aid, from its applicability, to every bar-frame in existence. This false bar, which may be reckoned a true friend, is of an inch in width and 5-16ths in thickness, it is of pine, and has a saw kerf down its centre, from one end to within about an inch of the other, and this saw kerf, when widened at its open end by the insertion of a key or a pencil permits the introduction of the wax-sheet guide, and the withdrawal of the same allows the wood to close, and hold the guide-sheet firmly in its place, when it is further and more firmly *fixed* by one or two fine wire-nails or screws which are passed through the bar, bringing its almost sundered parts as close together as is necessary to ensure the security of the wax guide sheet. The bar is then returned to its place under the top of the frame, and *the guide*, which is almost infallible, is fixed.\*

The false bars in addition to their duty as guideholders for the stock-hive, are also

adapted as *the bars* for the super, and rest in notches cut in the latter, similarly to those usual in the Woodbury bar super; and although we cannot approve of notches when a plain rabbet would answer as well, we cannot but admire the system by which the same sized bar is made available for the purposes of both hive and super, so that suitable comb may be exchanged from one to the other, almost without the knowledge of the bees, or hives or supers built up for exhibition or to order, by the selection of suitable combs from different hives in the apiary. No cutting-out combs just begun in a stock hive, and refixing them in the super to aid it, the bar itself with the comb upon it is available and ready, and simply requires transposing, and should a comb of brood appear in a super, what is easier than to transfer it to the stock-hive and replace it with a pure white side comb therefrom?

Then with regard to *manipulation*, the 'Lanarkshire Bee-keeper' in his 'Directions' says, 'The plan of this hive, as will be seen, does away with the crown-board, and admits of easy manipulation, any frame can be operated upon without disturbing the bees on those adjacent, as ample room can be given by withdrawing the dividing-board and sliding the intervening frames towards the opening thus made.' It matters not what part of the hive is to be inquired into, nor where the dividing-board is, if the hive be *full*, the board will be at the outside of the comb, but wherever it may be its withdrawal *will give lateral space*, and this we hold to be an imperative essential in a bar-frame hive, as without it there must always be danger of rolling or crushing some of the bees in extracting or returning the combs on making examination.

(To be continued.)

### THE BLIGH BEE QUIETER.

This favourite little affair, the invention of the Hon. and Rev. Henry Bligh, has just been rendered complete by the addition to it, of a means by which bee-quieting may be carried to any extent by fumigation. Originally the bellows was simply intended for use in procuring and directing a jet of smoke against obstreperous bees, but now, by removing the nozzle, and substituting 'the fumigator,' their quieting may be carried to such an extent

'That death and nature *will* contend about them,  
Whether they live, or die.'

The fumigator may be used without the bellows, by applying the lips and blowing through it; the tin tube in the centre is sealed so that heat will not cause it to burst, and the two wooden ends fit almost hermetically, yet

\* The beautiful symmetry of the honey-combs from Ayrshire which were exhibited at the Crystal Palace in September last, was said to have been entirely due to the use of embossed wax-sheets for guides; and Messrs. Anderson and Fergusson, the exhibitors, when asked whether the *preparation* of hives with such frail wax-guides was not a laborious work, answered, 'We'll d'ye mind, when we're a' ready we can jest do ten (hives) in an hour.' This was scarcely credible, but if the hives had fittings similar to the above, the wonder ceases. Ed.

are easy of insertion or withdrawal. The tube is first fixed on to the wooden delivery pipe, the puff-ball torn into small pieces is then crowded into the tube, a vesuvian (cigar-light)

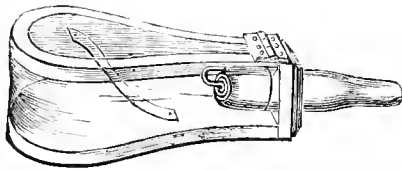

freshly ignited is thrust into the puff-ball, the wooden mouth-piece inserted, and the instrument is ready for use. As a means of readily producing the stupefying vapour, with the least possible waste of material, we have found nothing to equal this apparatus, which we think will commend itself to all bee-keepers.

**THE SLINDON HIVE.**

By the favour of F. R. Jackson, Esq., we are enabled to place before our readers engravings of this hive, which is considered by its inventor

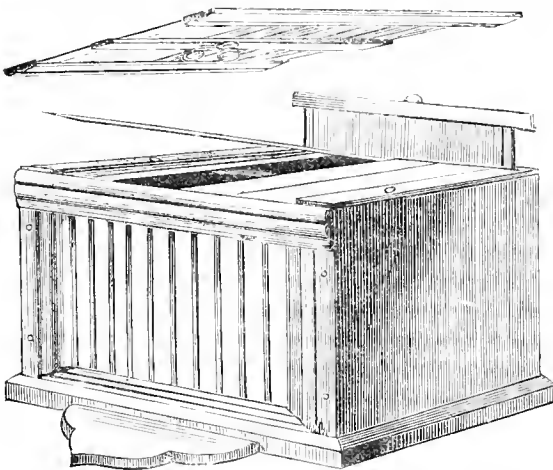

THE SLINDON HIVE.

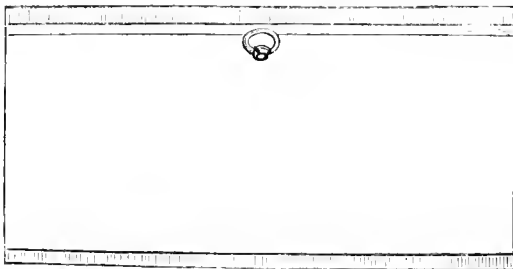

FRONT SHUTTER.

the best for all purposes throughout the year. Its front and back are of fixed glass, and its top is composed of glass plates, through which the

bees may be observed at their labours. One of the principal features is an arrangement by which any part of the hive can be operated on

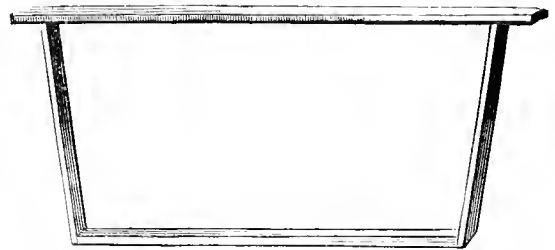

THE SLINDON FRAME.

without disturbing the remainder. The hive was fully described by its inventor on p. 120 of the *Journal* for November last.

**CRYSTAL PALACE SHOWS.**

Statistics of Flower and Bee Show of 1874, as compared with Flower Show only of 1873 :—

1873.		1874.	
FIRST DAY.		FIRST DAY.	
<i>(Saturday, 2s. 6d. day.)</i>		<i>(1s. day.)</i>	
Season Tickets . . . .	5024	Season Tickets . . . .	2850
Payments . . . . .	1255	Payments . . . . .	5638
	6279		8488
In Cash, 156 <i>l.</i> 17 <i>s.</i> 6 <i>d.</i>		In Cash, 281 <i>l.</i> 18 <i>s.</i>	
SECOND DAY.		SECOND DAY.	
<i>(Fireworks at Night.)</i>			
Season Tickets . . . .	2695	Season Tickets . . . .	2654
Payments (1 <i>s.</i> ) . . . .	6155	Payments (1 <i>s.</i> ) . . . .	5147
	8850		7801
In Cash, 307 <i>l.</i> 15 <i>s.</i>		In Cash, 257 <i>l.</i> 7 <i>s.</i>	
THIRD DAY.		THIRD DAY.	
Season Tickets . . . .	2238	Season Tickets . . . .	3336
Payments (1 <i>s.</i> ) . . . .	3996	Payments (1 <i>s.</i> ) . . . .	5779
	6234		9115
In Cash, 199 <i>l.</i> 16 <i>s.</i>		In Cash, 288 <i>l.</i> 19 <i>s.</i>	
TOTAL :—		TOTAL :—	
VISITORS.	CASH.	VISITORS.	CASH.
21,363	664 <i>l.</i> 8 <i>s.</i> 6 <i>d.</i>	25,404	828 <i>l.</i> 4 <i>s.</i>
Excess of Cash (1874), 163 <i>l.</i> 15 <i>s.</i> 6 <i>d.</i>			

The last day of the Show in 1873, when there was no extra attraction, multiplied by three would point to an extra profit brought by the bees of 228*l.* 16*s.*, added to 163*l.* 15*s.* 6*d.* = 392*l.* 11*s.* 6*d.*; as well as affording extra gratification to season-ticket holders, stall-keepers, and for visitors to Aquarium.

*Quantity of Food.*—A hive should contain at least twenty pounds of honey for the support of the bees during winter; but it is a mistake to suppose that if you increase the number in the hive by union, they will require a greater quantity of food. In fact, precisely the contrary is the case; the more abundant the stock of bees in autumn, the richer and better able to work they will be in the spring. The more forward, therefore, will they be in summer, and the greater will be your profits.—RICHARDSON.

## Correspondence.

\* \* \* These columns are open to Subscribers, so that their queries, replies, correspondence, and experiences, may be fully and faithfully recorded; and for the discussion of all theories and systems in Bee-culture, and of the relative merits of all hives and appurtenances, that the truth regarding them may be ascertained. The Editor, therefore, must not be expected to coincide with all the views expressed by the various writers. All Correspondence is addressed to the Editor.

### REMOVING BEES FROM BARNS, &c.

In the November number of the *Journal* a correspondent asks for a description of the means employed to obtain the bees and honey from a granary, alluded to on page 118. In this case the granary was a wooden building, composed of upright, square timbers, about a foot apart, with the usual diagonals, boarded on both sides, leaving empty air-spaces of about four inches depth between each pair of uprights, and in one of these the bees had taken up their position and built their combs. The granary being a nice building, the owner was unwilling to allow it to be damaged, and would only permit of the removal of two of the outside boards; and, fortunately, on these being taken down, the nesting-place of the bees was disclosed.

They had ensconced themselves between two of the uprights forming the framing of the granary walls, and had built their seven combs downward from one of the diagonals, each built diagonally in the 12-by-4 inch space between the uprights, and they all came down to an even depth at bottom, as I believe is usual. The bees were, as one might suppose, somewhat angry at the rude disturbance we were creating: they were very strong, and, being quite unassailable except from below, they appeared a ticklish lot to deal with. Had I been allowed to remove one or two other boards, so as to have exposed their whole nest, the work would have been easy, as the bees would then have been so frightened that I could have removed the combs one by one, and, brushing the bees off, could have allowed them to cluster as a natural swarm, and then hiving them, should have had them securely; but as it was, they could only be attacked from below, they appeared a ticklish lot to deal with. Had I been allowed to remove one or two other boards, so as to have exposed their whole nest, the work would have been easy, as the bees would then have been so frightened that I could have removed the combs one by one, and, brushing the bees off, could have allowed them to cluster as a natural swarm, and then hiving them, should have had them securely; but as it was, they could only be attacked from below, they appeared a ticklish lot to deal with. Had I been allowed to remove one or two other boards, so as to have exposed their whole nest, the work would have been easy, as the bees would then have been so frightened that I could have removed the combs one by one, and, brushing the bees off, could have allowed them to cluster as a natural swarm, and then hiving them, should have had them securely; but as it was, they could only be attacked from below, they appeared a ticklish lot to deal with.

Placing the skep on the ground I proceeded to

break out the combs with my hands, thrusting my right hand up amongst them, separating them from the walls of the granary, to which they were attached, and catching them with my left hand as they fell; the bees were then brushed off them into the skep, and they were placed upon a dish to be taken home. As might be expected, groping with my naked hands, and working in the dark, I received several stings, but having been already 'inoculated with bee-poison,' I am glad to say that very little uneasiness was thus caused. The bees in the skep, when they became quiet, were removed to Starford Mead, and successfully united by one of the gardeners to some bees of his own.—J. A. ABBOTT, Junior, Expert, *Hanwell, W.*

### THE OCTAGON HIVE.

Through the kindness of Miss Davidson of Tunbridge Wells, I am enabled to present the 'Renfrewshire Beekeeper' and others with the figure and description of the hive used by Sir Christopher

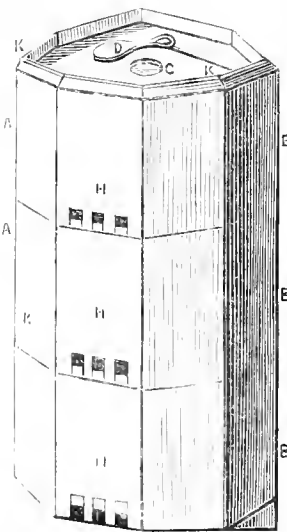

Wren. Some words which I am not sure of having deciphered correctly are underlined, and will, I hope, be printed in italics. I cannot at present verify the spelling—owing to a copy of Hartlibb, which I would have borrowed for the purpose, having been unfortunately used for waste paper—and the work is not to be found in the best libraries of either Edinburgh or Glasgow. As to the data on which I ventured to hint that Milton copied from Hartlibb, it is, perhaps, sufficient to say that there is no other *old bee book* that I know of in which he could have found Wren's letter.

Whether Milton copied incorrectly, or quotations are made from Milton incorrectly, I leave to others to determine. But the letter of Wren, as originally printed, is dated not 16th but 26th of February, 1631, and it concludes thus:—

'We must rather desire of you' (Hartlibb) 'farther light in this business, which, I presume, you can afford us from other men's observations that have tried the like experiment, for yet, you see, ours is imperfect, and we

know not what to make of it.—Sir, I am your most obedient humble servant, CHRIST. WREN.'

'A B three octagonal boxes in all particulars of one shape and size.

C a hole in the top which is the same in every.

D a cover the same to every hole turning upon a pin.

E a wire which pulls the cover to close it upon occasions.

G G G holes through which the ends of the wire appear.

H H H the doores every one to be opened or shut by little slides, the lower doores are open, the others shut.

K K K the upper edges of every box sloped away *lowerally*, the bottoms are likewise sloped away *correctly* that one box may fit to any of the other two.

M a little key made to screw on the ends of wires *yl* appear in the holes, by that means to close any of the holes in the sides. Behind opposite to the sides *h h* are doores that open with hinges and *bolts*, about four inches one way and six the other, and within each piece of clear glass cemented to the inside of the box to look in upon occasion.

Each box is lined with rush mat: it stands in a case of *these* that serves both as a stock and a covering to it.

'This is the sketch of the hive sent by Sir C. Wren to M. Harlibb.'

After examining all the evidence within my reach, I have reluctantly come to the conclusion that the claims of Wren to be the inventor of octagon hives are without foundation. Can the 'Renfrewshire Beekeeper' state whether the Dr. Wilkins, Bishop of Chester, to whom Rusden refers, was the same with Dr. Wilkins, Warden of Wadhams, at, or prior to, 1653; if so, there can be no difficulty in determining where he got his model. Apart from the slides invented by Kerr, what is original, and what is there in the Stewarton system as to principle and practice that was not in full operation before 1819? —QUESTIONER.

### THE BEST HIVE.

Although, as a member of the Bee-keepers' Association, I held a free pass to the Bee Show in the Crystal Palace early last September, business prevented me visiting it till within an hour or two of its closing.

I found enough of exhibits in the way of bee-furniture alone to have amply, and very profitably, repaid an entire day's examination, but with my limited time I had to deprive myself of this pleasure and hurry forward to see the *results* in the way of honey and honey-comb, the quality and quantity of which is, after all, the grand and crucial test of 'which is the best hive.'

It required no long time to decide on these points, as no one could have seen the splendid 'supers' from Ayrshire without being as I was, almost astounded at the marvellous display whether considered as to quantity or quality, and I, like young Norval,

'Longed to know

How battles there were fought and won.'

Well, getting all the numbers constituting your first volume, I have carefully read up all the letters of your correspondent, 'A Renfrewshire Beekeeper;' and I must say, that I think his reasoning is so close, and his arguments so founded on reason, that all unprejudiced persons must admit that if the 'Stewarton' be not the best hive, it is at any rate that which most readily facilitates the very best method of working bees, as so amply verified by the

splendid supers of Ayrshire honey, magnificent both as to quality and quantity.

And yet—and yet—though, as a bee-keeper in at present but an humble way, I do not intend to simply follow out all the working of the Stewarton plan; that is to say, bearing in mind the principles laid down by our 'Renfrewshire' friend, I shall vary the details, considering it the duty of every one to strike out some new path for himself, so as, if possible, to add to the general stock of knowledge; besides which I have, like perhaps many others, certain hives and other bee-furniture which I am by no means desirous either to abandon or throw away.

For instance, at the end of May last, I got home a strong first swarm, bees alone weighing fully 4 lbs., hived in a flat top straw hive, whose dimensions are 13½ in. diameter by 8½ in. height, both inside. The hive is fitted with a window at the back, a feeding-hole at the top 3 in. diameter, and the straw at the bottom is worked to a wooden hoop.

The bees showed no inclination to take to supers; and I have not deprived them of any honey whatever, preferring to give them their first year entirely to themselves, and, judging from the window and the weight of hive, I think they have laid up a pretty good store for themselves. For ventilation during winter I have had a glass saucer made with a hole in the middle with a rim standing upward, an inverted tumbler standing in the saucer, so that it is impossible for any condensed vapour to run back into the hive. Round the outside of the hive I have bound some old felt carpet. The entrance-door cut out of the floor-board, I have narrowed by perforated zinc ½-inch wide, thus securing ample supply of air to the inhabitants. The hive rests on a wooden stand, having a hinged roof, and, while airy, is well protected from all rain and wet.

Hoping, therefore, that all will go well with my bees, as also those of others, my first operation in spring after I see my bees fairly at work will be to place a nadir under my present hive, and then add supers as required, cutting out holes in the roof of my present hive towards the circumference so as to permit only the side comb-workers to pass upwards into the supers; and here, I should ask the 'Renfrewshire Beekeeper,' about what time or after what symptoms I should first place my nadir. These are little points he does not fully explain, see page 14 of your *Journal*, Vol. 1. Again, after the bees are well in the nadir, could I remove them away so as to form an artificial swarm; and in the event of the queen not being with those in the nadir, will those in the latter when removed from the parent hive be able to raise one for themselves, or should one be given then? Further, and *vice versâ*, suppose the queen be taken away in the nadir will those left in the parent hive raise a queen?

If both those will be done by the bees themselves, this removing of the nadir seems to me an easy way of forming artificial swarms.

Will the 'Renfrewshire Bee-keeper' permit me to point out to him how much better he would find it to work his entrances out of the floor-boards instead of cutting them out of the bodies of his hives, thus

saving the fitting of doors and the closing of them when he storifies, &c.

It seems to me that one style of hive is as good as another if it can be worked equally as well as shown by results.—A. D., *Penge, Nov. 26th, 1874.*

### HIVES.

Having one hive in a Woodbury, one in a Pettigrew, and five in other straw skeps, I am anxious to commence hive-building as soon as may be to prepare for getting all of them into *sensible* hives by the spring.

I have carefully studied all the articles in each number of the *Journal*, hoping to meet with a description of the *best* hive, but, alas! in vain. Here I am told straw, in another place wood, and last of all, Mr. Jackson tells me 'the best moveable comb-hive' is composed of glass. I think of having one upon this plan, but I do not seem to like it. I am inclined to adopt that which is so fully explained on page 134, Vol. I., the *oblong* shape, arranged for a partition in case a *smaller* space is desirable for a small stock.—A. W.

### QUEEN-CAGES.

By reading the letters of Mr. Carr and 'Renfrewshire Bee-keeper,' on their respective cages in this month's *Journal*, all bee-keepers will see that they have arrived at perfection in introducing alien queens to hives. Let the bees be in an amiable or irritable mood they do not lose a queen. At the end of forty-eight hours the one gentleman presses down a wire on the principle 'of Jack-in-the-box.' Presto! the prison-door flies open, out-steps her majesty, and commences her maternal duties at once; and he is so 'confident of' complete success, that he does not even take the trouble of ascertaining the condition of the queen. The other gentleman pulls up a wire, and royalty 'walks out at her leisure upon the comb in the centre of the brood-nest.'

Who will hesitate to introduce Ligurian queens now? There is no danger of a valuable queen's life now. The veriest tyro can manage it now. It does not matter what shape, make, or material his hive is, be it straw, wood, or adobe, be it flat-top, round-top, or conical-top, be it triangular, square, hexagon, or octagon, if it has a hole or space in the top; if it has not, a knife, auger, or gouge, will soon clear out the desired room. If he has a moveable comb hive he must get an 'improved cage.' It has a sliding door, is cent per cent cheaper, has been nine years in use, has a deal more wisdom in it, and when the queen is released it can be left in the hive till next time. Let him order a queen and procure one of those cages, it does not matter which, the one was invented ten years ago, and is a little longer than the other. The other is a more recent invention, but a Crystal Palace first-prize concern. Then dethrone his black queen, attend to the instructions, plainly given—mind, only seven attendants. Success is certain, for in two days you have only to press or pull the wire, forth steps the

Rhætian beauty, and the grateful blacks laugh a chorus of joy. But stop! is it not a most unfortunate thing that Mr. Hunter and 'our Editor' found both their queens dead next morning in the first prize cage! Two of the ablest bee-masters of the day. No wonder a greenhorn like me was unsuccessful. In a previous communication I said I found the 'Carr queen-cage' a veritable snare for despatching an alien queen. As I should like to get Mr. Carr and 'Renfrewshire Bee-keeper's' opinion on where I erred, I shall give detailed particulars.

Having a Ligurian queen ordered I took the first opportunity to remove the black queen from the hive; and so as to have so far a little practice, a 'Carr queen-cage' was procured, we—a friend and I—put the black queen into it along with the 'mystical number of workers,' according to the instructions kindly sent with the cage.

We found there was not room for the cage going down between the honey-combs at the top of the skep, so we took a knife and sliced enough of one side off a comb to let down the cage the full length. Seven days afterwards we pulled out the cage, 'the mystical number of workers' were all dead at the bottom of the cage, and her majesty only alive and quite well! Four or five days afterwards the Ligurian queen arrived. Both queen and bees being in first-rate 'order and condition' and plenty of food beside them, she was carefully caged along with 'seven workers,' put into the hive *à-la-mode*. Forty-eight hours afterwards the wire was pulled, and in a little time the cage gently drawn up, and, alas! the luck of odd numbers availed not here, for 'the mystical seven workers' became the 'seven sleepers;' and also my beautiful queen was 'gathered to her fathers,' all curled up dead at the bottom of the cage, to all appearance basely murdered by the ungrateful blacks! I caged, or rather confined for forty-eight hours, a second Ligurian queen, with two workers on the comb in the box, in which she was sent, according to 'our Editor's' advice and instructions; two hours after releasing her the bees were carrying in pollen, and in five weeks I had the pleasure of seeing the beautiful young Ligurian bees out airing themselves, and viewing their adopted country for the first time.—J. S., *Arbroath.*

It appears from a letter received from Mr. Carr that I am wrong in attributing to 'Renfrewshire Bee-keeper' the original idea of my queen-cage, as illustrated in your November issue, page 119.

But on reference to your *Journal* I find that it was only when this gentleman had suggested the idea, that Mr. Carr came forward and described his cage in your columns as having been invented some years previously. From the manner in which the 'Renfrewshire Bee-keeper' threw out the idea, it is evident that he had no knowledge of Mr. Carr's cage. As regards my own cage, the drawings were made and forwarded to the wire-worker for execution before I had seen or heard of the Carr-cage. I am sure, from my personal knowledge of Mr. Carr, that he will acquit both the latter gentleman and myself of any intention to infringe upon his inven-

tion, especially (*si parva licet componere magnis*) when he calls to mind that a Le Verrier and an Adams discovered the planet Neptune at the same moment of time! Moreover, although the end sought to be attained by each cage is the same, yet the mode of attaining it differs considerably—*e.g.*, the manner of ingress and egress, material and size of cage, &c.,—in each of which points Mr. Carr will pardon me for preferring my own cage.

‘A Renfrewshire Bee-keeper’ has kindly presented me with two of his cages, which at present I have not had an opportunity of proving, but in my judgment they are much too short. The length should not be less than five or six inches, in order to enable the imprisoned queen to come in contact with the brood. In nine cases out of ten success will depend upon this. When experimenting on the introduction of stranger queens, I have invariably found, except during the warmest weather, that the queens when imprisoned alone near the top of the hive, were deserted by the bees, and left to starve. Will not this fact account for your own and Mr. Hunter’s loss? There was no point on which the late Mr. Woodbury more strongly insisted than this,—that the queen should be imprisoned upon *the brood*; and when, relating his success in introducing several queens by immersion in honey, &c., without imprisonment, a novice stated to Mr. W. his belief that there was no difficulty in the matter at all, his reply was, that he also on his first attempt had formed the same opinion, but after ten years’ experience he believed the introduction of stranger queens to be the most uncertain of all bee operations. My experience, of at least ten years also, entirely tallies with his; and when relating the successful introduction of the twelve queens, in your November Number, with a view to brevity, I omitted to state that the motions of the bees were carefully observed, by means of a window at the back of each hive, and also on the alighting board, until the regicidal frenzy had passed away, before a single queen was liberated. Indeed, after writing the account, I had a queen encased, rescued, re-caged, released, and again encased, but finally successfully introduced. The imprisonment of the queen of the hive for a few hours, and the substitution of the new queen in her place, I believe to be an important element of success, inasmuch as the bees will not commence the formation of queen-cells during her presence in the hive, and on her removal the new queen, occupying her place, becomes impregnated with her odour.

The alarm evinced by the stranger queen, and displayed by her wildly rushing around the cage, will at times defeat every precaution; but when the paroxysms of fear are over, there is no manner of doubt (and this was repeatedly proved by Mr. Woodbury) that the alien bees do feed the stranger queen, however strange and contrary to *our* ideas the fact may be. When their intentions are most regicidal they feed the queen. In one case I had a queen encased for five days in the midst of a densely packed knot of bees, which queen had undoubtedly been well fed, since on emerging from durance vile she was in excellent condition and commenced ovipositing at once. So unaccountable and past

finding out are the instincts and actions of our little favourites. — GEORGE RAYNOR, *Hazeleigh Rectory, Maldon, Dec. 18, 1874.*

It is almost unnecessary that I should distinctly repudiate the insinuation of your correspondent, Mr. W. Carr, in last month’s *Journal*, that my idea of a queen-cage was borrowed from drawings and descriptions of his, more particularly when it is borne in mind that neither the material, form, nor principle of working are alike; and I can assure your correspondent, that for the first sight of his drawing and description I was indebted to the April Number of our own *Journal*, two months after I had published my remarks, this being the earliest intimation I had that Mr. Carr had ever turned his attention to the queen-cage question.

Then, again, as to both Messrs. Carr and Aston’s exception to my expression, ‘With all cages stuck into the combs,’ I must explain to your correspondents that the objectionable word ‘all’ applied merely to such cages as I had any experience of, *viz.*, the ‘Pipe-cover,’ and the little zinc one Messrs. Geo. Neighbour & Sons send out gratuitously along with imported queens, otherwise I would most certainly have qualified the expression. Indeed my recollection of the drawing of Mr. Carr’s No. 2 cage was that it was somewhat similar to No. 1; and it was not till after penning the last remarks that I referred to the May Number, and he may pardon me saying that the flat appearance, as he there represents it, does not convey a just conception of the form of cage or its value to the mind’s eye, without reference to the letterpress.

So much for my ‘two mistakes,’ and according to Mr. Carr, Mr. Raynor is ‘also mistaken’ in ascribing to ‘A Renfrewshire Bee-keeper’ the invention of queen-cages for introducing alien queens, &c. My correspondence for 1864 affords abundant evidence, from the sketches forwarded to apiarian friends that autumn, that the idea of the flat cage for insertion between the combs was then matured; and while Mr. Carr was dilating in November of that year in the *Journal of Horticulture* on ‘Joining Ligurian Queens and Bees to English and Black Bees,’ without the word ‘queen-cage’ being once alluded to, but, on the contrary, described how he placed queens *over* the stock, and cautiously admitted one bee at a time, one of the correspondents above referred to, Mr. Alex. Ferguson of Stewarton—same month I see—got made and forwarded to me—last day of it—the first queen-cage of that form I ever possessed, and which I still carefully preserve; and, curious enough, it was my communicating the then new idea to Mr. Woodbury, that drew forth his reply of Dec. 14, 1864, quoted from last month (there misprinted *February*), he having adopted the pipe-cover form.

Mr. Raynor is perfectly right in what he says, page 119, of cages made of fine wire being in his opinion ‘a decided advantage over those made of perforated zinc, allowing much freer communication between the alien queen and the bees, greater warmth, and the more free absorption of the odour of the hive,’ most important advantages of his and of mine; and ‘Questioner’ well describes, at page



It, the objectionable nature of queen-cages of zinc, from the poisonous exudations collecting on the surface of that material, for which reason it has long been banished from the apiary, dairy, and poultry-yard, here.

Your correspondent put himself to unnecessary trouble in reporting the mishaps with my cage; the scientific investigator is as much interested to chronicle his reverses as his successes. My publishing the former has had the effect of bringing to me reports of numerous instances where the cage was employed with complete success.

It did afford me pleasure to find, in our October Number, our Editor ranging Mr. Carr and me together as opponents of a principle. Strange, though no less true, that worker bees will invariably feed an alien queen imprisoned within their hive, and regretted to find last month I was fairly deserted by my ally. While I stake the alien queen alone in the cage, he provides—I presume in case of neglect—the mystical number of seven of her majesty's old subjects as a train; and not content with the honied store on either side the cage, tells us—now for the first time—he actually drops sugar-syrup every twelve hours through it, simultaneously, I am afraid, taking the gloss off the coats of the imprisoned party, and the argument, consequently with the shade of Woodbury I now stand alone! Although in fairness I did adduce last month the expressed opinion of 'our Editor,' the Hon. Sec., and Mr. Alfred Neighbour, it is consolatory to remember these gentlemen never, so far as I am aware, made the experiment, and when they do I trust their experience will coincide with the opinion expressed by—A RENFREWSHIRE BEE-KEEPER.

#### IVY HONEY.

Your correspondent, 'E. W.,' asks what influence ivy has on the value of honey? The inhabitants of Cuneo, in Piedmont, were formerly famous for their honey. To be able to guarantee that it was honey from Cuneo was to be assured of a high price. The place is surrounded by a perfect bed of Alpine flowers; but, unfortunately, the fortifications thrown down by the French in 1800 have become covered by ivy, which has flowered in profusion. Cuneo honey is now bitter, and the market is spoiled. The Italian, who takes a great interest in the produce of the bee, will not thank you if you offer him Cuneo honey.—J. S. A. HERFORD, *Tarrant Keynston, Blandford, December 2, 1874.*

In answer to your correspondent, 'E. W.,' of Dublin, I beg to say, for many years my apiary stood within twenty yards of a very large amount of ivy, which in its turn, true to the decrees of Nature, flowered most beautifully and profusely. It was an intense treat to stand on a fine sunny autumnal day to watch the busy movement of my bees, and listen to that peculiarly cheerful, merry hum of my little pets which so pleases both the eye and ear of the enthusiastic apiarian. In fine seasons the stores of food and honey from these trees of ivy would afford supplies to the bees for from two to three weeks, in which time it may easily be conjectured that much

honey was stored; yet I did not think it was at all necessary to touch the honey obtained, much less to rob my little favourites of their hard-earned supplies. Surely, however clever we may be as apiarians, we must never attempt to teach these wonderful little insects what 'they' ought to do in a state of nature, for the laws of Nature [N.B. the word Nature should always be read 'the Creator'], which are immutable and unalterable, teach 'the little busy bees' their lesson from the moment they emerge from the cell, what to eat, drink, and avoid; and I for one feel quite convinced that 'E. W.' did very wrong when he deprived his bees of the honey they had collected from the ivy; neither do I apprehend that any disagreeable consequence will result by leaving the few frames as an experiment, for I have not the least doubt that this ivy-honey will be consumed with equal avidity with the rest in the hive, when the bees take it in its turn for their consumption. I may add, that I am of opinion that the ivy is one of the very few flowers, through a wise provision of Nature given for the use of the bee to make up the supplies which have become deficient through consumption since the lapse of the warm weather till the arrival of so important a bee-food supply as the ivy, and thus enable the residents of the hive to commence a long, cold, and trying winter with well-provisioned stores.—CHAS. H. EDWARDS, *December, 1874.*

#### TRIGONA, OR BRAZILIAN STINGLESS HONEY-BEES.

At our great Bee Show at the Crystal Palace I exhibited a nest, with the bees, brood-comb, and honey-pots of these remarkable and smallest honey bees known in the world. They came to England in a hollow piece of logwood, and when being unloaded at Manchester, on Saturday, July 17th, 1869, the nest fell out of the hole on to the ground, and was carried into an office and placed on the desk. When they came to the office on the Monday morning following, they found the desk covered with the bees, (but they were thought to be ants at first). The gentleman in whose office they had been placed, being a scientific man, placed the bees and their nest in a box which he covered with a glass, and, knowing that I took a great interest in bees, brought them out to me to Newton Heath.

As I had never seen any of these Trigona bees before, I sent some of the live bees, with a piece of the brood-comb, in which young bees were just being hatched, also a section of the nest containing honey-pots, filled with pollen, &c., to Mr. Frederick Smith, of the British Museum, late President of the Entomological Society, and one of the Vice-Presidents of the British Bee-Keepers' Association, he being one of the greatest authorities we have in Great Britain on hymenopterous insects. Mr. Smith kindly wrote to me saying, 'The bees sent are the Brazilian honey-bees belonging to the genera Trigona; they being exotic, I do not imagine it will be possible to propagate them here. They do not construct honey-cells, but honey-pots; as you have the brood, the most important thing you can attend to is to secure the queen. I once obtained one from a brood

sent from Brazil in spirit. I cannot find that your bee is a described species, as it is not in the British Museum. You will have ascertained that these bees are the stingless bees of South America; they are found also in India and the islands of the Eastern Archipelago.

This nest of the *Trigona* is nearly the colour of logwood, with a smooth, hard, outside casing, in shape the same as the size of hole in the logwood, which measured  $8\frac{1}{4}$  inches long, and 5 inches long, and about  $1\frac{1}{2}$  inches diameter each of them, nearly round but joined together. The nest and insects weighed  $7\frac{1}{4}$  ounces, and the pots are filled with pollen and honey, which is of a greenish colour, thin, and tastes sour, or like fermented honey. The brood-combs contained brood in all stages of development.

On August 17th the thermometer went up to 98 degrees in the sun, and the *Trigona* were very busy flying about the box, so I placed it in the garden and allowed a number of the bees to fly out; but I did not see any of the bees return to the box, so I concluded they must have lost their queen, otherwise they would not have deserted her; and this afterwards proved to be the fact. As the brood-combs when brought to me contained eggs and brood in all stages of development, the queen must have been in the nest within a day or two from that time, so I think she must have got lost when the nest fell out upon the ground, or that she swarmed with the bees when left on the office-desk, and so got lost, so the bees gradually died away; but I think I could have kept them in a warm room over the winter if they had not lost their queen. It was very amusing to watch these beautiful active Lilliputians, as they were constantly brushing themselves and smoothing the hairs on their body with their hind feet, and sometimes with four feet at once, holding on with the two fore feet. I have no doubt they thought themselves great dandies, being so very particular about their dress. At night they all return into their nest. These *Trigona* were nearly shining black, less than  $\frac{3}{16}$  of an inch long, with wings of rainbow colours longer than the abdomen. I have had a number of them dissected and mounted for the microscope.

These were the only *Trigona* bees that ever arrived in England alive; the late Mr. Woodbury tried to import these bees into this country, and a nest was sent to him from Australia, which is now in the British Museum. The brood was fed with honey and water, but they all died before they arrived in England.—WILLIAM CARR, *Newton Heath, near Manchester.*

(To be continued).

### THE WOODPECKER.

I think the following may be worth insertion in your valuable *Journal*. In crossing my garden late this afternoon, I was horrified to see two large holes, cut in the most jagged way, through the front of my bee-house. I had a new one made this autumn (in spite of your objection to them) by my village carpenter. It holds six hives, and is strongly made of deal one inch thick. I had noticed a week ago one of the apertures for the bees had been cut,—I

thought then with some boy's knife, but to-day, besides the two holes which first caught my eye, the larger of which was  $2\frac{1}{2}$  inches long by 2 inches broad, all the apertures for the ingress of the bees are mutilated as though with a rough tool. I at first thought it was a rat's work, but on seeking my gardener, he said he surprised a woodpecker in the act. He had heard the thuds made by its beak all the afternoon, and thought it was a carpenter doing some work in the house. Of course I will shoot the bird if possible; but I should like to ask, Mr. Editor, what was his object? was it to catch bees or to get at the honey?—G. A. R., *Bishopstoke, Dec. 23.*

### THE QUILT.

For many years I have covered the crown-boards of my wooden hives (which are mostly in sheds or bee-houses) with two or three folds of carpeting or sacking, and since doing so, I have neither seen the evil of internal moisture arise, nor found any necessity for making use of ventilating appliances. This is an excellent winter for testing the value of quilts; and when the storm comes to an end, a statement of their merits, as contrasted with those of crown-boards protected by some warm material, would be interesting to a—QUESTIONER.

### THE PALACE SHOW—HONEY EXTRACTOR.

I was very sorry I could not come to London to the Bee Show, being in Devonshire, where I spent a nice three weeks among my bees and honey. They burn their bees there, so I drove many stocks, and put them together, so that I shall have some good stocks for next year. I read with interest the management of your Show. I am glad to know you have a junior who is clever and likes bees. I think that the operations on bee-driving and uniting might be managed better, not in a room but in a field, so that it would give the bees a chance. I do not see the public is so much interested in that as bee-keepers. Then I thought some one was rather hard on Mr. Pettigrew, as they condemned the old cottage hive; many think it best yet; Mr. Fox, from Kingsbridge, thinks so. I like the bar-hives best. I got a model from Mr. Woodbury. I must give you my opinion of the Slinger. I condemned it altogether, and had not the least faith in it. A friend of mine bought a Starling's Extractor, sent for me to try it, when I was quite convinced it would answer well, and that it will make a great change in bee-keeping; I am very much pleased with the principle, but think it may be much improved; it makes too much noise.

I am glad to see your *Journal* is getting on so well, I have got a good many to take it. I have done well with my bees and honey this year; also at the shows; but we do not get good judges, they do not take in the improvement, if they get a good weight of honey, they do not care how it is put into the hive; we never had a good judge but once, and that was Mr. Tegetmeier, of London. I have sold a deal of honeycomb at 2s. 6d., run honey, 1s. 9d. I have had about 100 lbs. of honeycomb in some nice supers.

I will try to come to London next year. You will see by the *Cottage Gardener*, that Mr. Pettigrew has been trying his hand at an Extractor. We shall see what he has to say; if the combs are old and the honey is stiff, it will not answer. I tried that. I am so far satisfied it will do its work well if the combs are young. I tried one comb that was very tender, it would hardly hold together, and it did not injure it at all; I look with pleasure next year to try it. I shall yet have other 50 lbs. this season, and shall try a comb or two.—J. W., *Rochdale*, November 3, 1874.

### THE SKEP VERSUS MOVEABLE COMB HIVE.

In June last one of my hives in a Neighbour's Cottage swarmed and rapidly increased for about a fortnight, and then began to decrease again and refused to enter supers, so thinking something was wrong I procured a Carr-Stewarton Hive, intending to turn them up and transfer them, first driving them into an empty hive, but after tapping the hive for about half-an-hour, I found the bees had not risen at all. This is the first time I have failed to drive bees, having done five or six; so concluding they had not a queen, I examined the combs and found they had not any brood, though plenty of meal and honey. I then put the hive back, thinking to give them a queen, as they were still strong, but in two days the hive was empty, except about 100 drones; the bees had dispersed themselves and were crawling up the posts of other hives, trying to enter, but best part of them were killed in the attempt. So good-bye to any more straw Cottage hives, nothing but bar-frames for me, then I can give the bees a bar of brood out of another hive if ever I have the misfortune to lose a queen again.

Please send me another Carr-Stewarton, I will try to turn No. 1 out of a Neighbour's Hive two years old, which has only filled the glasses once in two years; though very strong, they do not seem to be able to work in these glasses, I think they are too cold for them.—C. E. P., *City Road, E.C.*

### WHAT NOT TO DO.

I think you might find a good deal to say under a heading, 'What not to do.' In a little book published at the office of the *Journal of Horticulture*, London, instructions are glibly given for multiplying Ligurian swarms, somewhat thus:—Take a bar with comb containing eggs and brood, put it into an empty hive, set the hive on a fine day in the place of any strong stock of common bees that may be available, and the returning bees will raise a queen, &c. Now this may be all true, but what chance would she have of mating with a Ligurian drone? and what sort of comb would the bees fill the hive with? I say what chance of mating with a Ligurian drone, for you are supposed to be working in an apiary containing only one Ligurian stock, and several black ones.—B. M. B., *Philippstown, Ireland*.

[Doubtless many hundreds of bee-keepers have given up keeping Ligurian bees through following the direc-

tions above summarised, and for which the Editors of the Journal quoted are responsible. It is a rule, almost without exception, that a colony of bees without a queen will build drone comb only, if they build at all; yet here the directions to place the bees in that precise condition are unmistakable. Artificial swarms are to be made, which are to be left in an empty (?) hive to raise their own queens, 'and in three weeks time' they are supposed to 'replace their missing queen with a young artificially-reared Ligurian queen, whose progeny would in due course of time become the sole possessors of the hive.' Now, considering that during the greater part of the three weeks the bees would build drone-comb only, it is not difficult to imagine that the majority of such progeny would be drones, and as such would be useless as producers, and there is little doubt but that every stock so formed would perish during the ensuing winter months, if it did not previously fall a prey to robber bees. The chances of the young queens obtaining impregnation by Ligurian drones would be remote, since all the black drones existing at the time the swarms were made would remain with the queenless stocks; at least, until after the queens became fertile, while the chances would be very much against drones being bred in any number in the Ligurian hive, through its being so continually robbed of its brood-combs. There seems to have been some idea of this in the mind of the writer, for he later on recommends that 'one good Ligurian stock should be left pretty much to itself, so as to encourage the propagation of drones.' The whole plan is undoubtedly wrong, and urgently requires correction.—Ed.]

### WAX-SHEETS FOR GUIDE-COMBS.

With reference to the query put by Mr. John Hunter, the straight regularity of super-combs was a matter of chief importance in Stewarton supers, and attained by comb-points, possibly before the German inventor of the embossed wax-sheet was born; and I can quite fancy the supers of Robert Kerr's day would be still clearer and finer in shade than those exhibited at the Crystal Palace; the introduction of railways, and increase of coal and ironstone pits in Ayrshire, tending to throw a greyer shade over the pristine purity of white clover honey.

While saying so, I have no desire to disparage the above very capital invention, having beneficially employed it from the first, while Southern bee-masters were disputing over the utility of the device. Amusing stories could be told of how eagerly ingenuity was exerted to have the impress of the first imported sheet, stereotyped in stucco, lead, and gutta-percha, in these Northern regions; and when at last manufactured of the correct metal, and scarcely distinguishable from those of Continental origin, reports came to me of how neat-fingered faithful wives, warmed, and strong arms machine-pressed, the sheets on to the small hours of the morning.

I have taken good plain sheets from glass, aided by pure water, without either soap or oil,—but, I understand, wooden dippers to be the most advanced thing. Your valued contributor, 'A Lanarkshire Beer-keeper,' being, I believe, the most experienced manufacturer of these sheets in Great Britain, might kindly favour us with a contribution on the subject.—A RENFREWSHIRE BEE-KEEPER.

## FOREIGN INTELLIGENCE.

From the *Apiculture* of Milan we learn that the subscription raised in Italy with the object of presenting the well-known Mr. F. de Hruschka with a medal, and which was to have been closed some time since, has been left open to the end of the year.

The Italian Bee Association, having learned that General Garibaldi keeps bees, have sent him a copy of their monthly journal. In his acknowledgment, the illustrious General states that bee-keeping is now his favourite occupation.

The last Congress of Bee-keepers held at Naples was attended by a representative from the Italian Minister for Agriculture and Commerce, who, on hearing the report, addressed a letter to the President of the Italian Bee Association, congratulating him on the success, pointing out at the same time the benefits which apiculture is capable of rendering to the nation, and urging the members to persevere in their endeavours to promote bee-culture.

The Eighth Great Italian Honey and Bee Show took place at Milan during the early part of December last. The 1874 season, however, has been in Italy one of the poorest on record for honey-gathering, the result being that short supplies on the market, with the natural consequence of a rise in the prices, are already to be noticed.

Mr. M. Giridwoyn, a Pole, has presented the Paris Société d'Apiculture with a monograph on the 'Organs of the Honey Bee and their Construction.' This work comprises twenty-four large plates, the making of which occupied the author two years. The same will be published in French at an early date.

From the *American Bee Journal* we learn that the North American Bee-keepers' Society held their annual meeting at Pittsburgh, Pa, on November 11th, and had a most successful session. According to the census returns of 1850, the amount of wax and honey produced in the United States was 14,853,790 pounds, but after ten years only, of attention and cultivation of the bee, the amount produced in 1860 was over eight times larger, being 126,386,855 pounds. President Hoagland continues, 'With the increased attention given to the pursuit, together with the increase of colonies, we have no doubt but the present returns will show a vast increase of product. Many of the best men of our land are now employed in acquiring practical knowledge of the nature and habits of the honey bee. The science is advancing steadily, and the future is big with development in apiarian pursuits.'

Mrs. Tupper, a most successful lady bee-keeper of Des Moines, Iowa, claimed 'that bee-raising was specially advantageous to ladies, who were thus afforded pleasant and profitable occupation,' and urged 'that there was no other business which offered such strong inducements to those who wished to make money on small capital.' Regarding hives, the Rev. W. F. Clarke, the President elect, says, 'We have some principles pretty well established, which I think, by this time, ought to be pretty well understood. Leaving the movable comb principle, and the air-chamber, and one or two other conditions of successful bee-keeping out of sight, the rest is not of much account. We know bees are not particular, and will store honey in rough hives properly constructed, as well as in the most finely adorned palaces ever constructed.' Speaking of the Association, he says, 'We have, I think, escaped the greatest danger that menaced us at the outset, —the danger of the Society being made use of for other than broad disinterested purposes.'

We learn from the December Number of the *Apiculteur* that two new works are announced for publication: the first, 'Elevage des Abeilles,' advocates the American hive and system; the second, 'Mémoire et Dissertations sur l'Apiculture,' deals with the subject of bee-keeping generally.

The first portion of the Report on Apiculture at the Paris Exhibition of Insects has been issued.

## Queries and Replies.

QUERY No. 114.—Will you kindly give me your notion of the following mode of increasing the number of colonies and Ligurianising at the same time? As you will see, it varies little or none from what Langstroth recommends on page 180.

Having three hive-posts, marked 1, 2, and 3, and two full hives, marked A and B, and one empty hive, marked C. Assuming A has begun to hang out, open, drive it so as to secure every bee into C, and place C on No. 1 stand, having secured the black queen. Then excise all the queen-cells from A, and place it on No. 2 post, from which you have removed B, placing B (untouched) upon No. 3 post. Then you have a queenless stock in A with comb, but no queen-cells; a queenless stock in C, without any comb at all, and B complete, only removed. Finally, when Ligurian queens have been given to A and C, instead of having two common stocks, you will have two Ligurian and one black stock. I omitted to mention that A stood on 1, B stood on 2, and C stood on 3, before operating?

Is there any reason for always having an odd number of bars, or bar-frames, as 7 in Stewarton honey-boxes, 9 in Stewarton boxes, 13 in Pettitt's Dover hive, &c.?

Having read every word *pro* and *con re* Octagon (Renfrewshire) versus Square in your *Journal*, I confess I still lean towards Octagons. Do you really believe that the octagon shape of the Stewarton hive is of any great advantage over and above the square, *i.e.* if you were having a considerable quantity made would you go to the extra trouble of making them octagon or not? Supposing two sets of hives—one octagon, the other square—each of the same height, containing the same area, and in all other respects equal (except in shape), do you or do you not believe with 'Renfrewshire,' that the octagon colony would flourish better than the square, *i.e.*, sufficiently better to make it worth while to spend the extra time and money in making octagon hives?

Is the enclosed drawing exactly what you mean by the false bar-frame under Stewarton bar? Is it necessary that the wax-sheets should be embossed, or would a plain strip of wax let into groove, and projecting—say quarter of an inch below under side of bar—do? Years ago I went in for wax-flower making, and finding Minton's sheets of wax very expensive, I used to cast blocks of white wax (or coloured to any tint) in a tin mould three inches thick, and of the same superficial surface as the sheets sold. I then used to plane off the sheets by means of a very long spoke-shave. In this there was a certain amount of Canada balsam and olive oil to prevent the wax from cracking. Now, supposing a block of bees-wax, say 16 inches long and 1 x 3 thick, was shaved up into thin 1-inch strips 16 inches long, would that do for a guide? If so, such strips could be made far more rapidly than by dipping slips of glass into hot wax, recommended in the *Journal*, page 121. Again would bees object to wax being adulterated with Canadian balsam or olive oil to toughen it? And what depth of wax-sheet should hang below the under surface of the bar?

As Lee's bars have a rib down centre, and other makers have a piece of obtuse-angled wood to give the correct pitch to the comb, how is it that the Stewartons have a slot instead, which, if followed by the bees, would give a downward pitch to the mouths of the cells? I have all along adopted your knife plan, and find it answer well.—S. W., Tenbury, Worcestershire.

REPLY TO No. 114.—The beginning of the artificial swarming proposed would be quite right, but as the queen of A would be driven out with 'every bee' into C hive, there would only be one queenless stock unless a second was specially deprived. If the

intention is to introduce two Italian queens, it would be far better to introduce them to the hives containing combs than to hinder the progress of the newly swarmed bees, as would probably be the case if an attempt were made to introduce an alien queen at that time. Besides, the driven swarm is supposed to be queenless; which could not be, as bees without a queen would not stay in a combless hive for any length of time, but, weather permitting, would try to find out where she had gone to.

When swarms are put into a naked hive it is *always* bad policy to hinder them, or in any way to interfere with the comb-building impulse which is sure to be engendered by their clustering together; but at such times it should be encouraged to the utmost by a continuous gentle supply of food. Swarms seldom breed many drones during their first season, particularly if they have young and fertile queens, so that when ligurianizing, they, although headed by black queens, do little harm, and for the purpose of building up stocks they are as useful as any, and as they may be deposed and Ligurians substituted late in the season when imported queens are cheaper, we seldom interfere with them at swarming time.

There is no special reason for having an odd number of frames in a hive, the dimensions of the hive are the only guide, and 'even' numbers occur quite as often as 'odd' ones. The 'Woodbury' has 10, 'Langstroth' 8 or 10, 'Quinby' 8, our own 'Frame-bar hive' 8, and so on; but as each frame in the body of a hive requires  $1\frac{1}{2}$  inches of its width (nearly), the number is governed by the measurement of the 'sides' on which the frames rest,—usually the back and front of the hive.

The battle between the circular form of hive and the square has raged for many years, and each, with its various modifications, has doubtless its advantages. As stated last month, p. 125, the circular form has an advantage, inasmuch as the globe of bees during winter are enabled to continue in close proximity to their stores, as they may in the Stewarton, which, being an octagon, is a near approach to the circle; but as we are pointedly asked an opinion, we feel bound to say that we do not think the Octagon has any advantages over the square (rectangular), all things being considered. We hold that hives, in these days of *bee culture*, should be convenient for the bee-master as well as for the bees; in fact, due regard being had to the *comfort* of the bees, the question of convenience is one for the bee-master only, for it is tolerably certain that so long as bees are not hindered in their labour, they will, other things being equal, work as well in one hive as in another. There is a sad delusion amongst amateur bee-keepers that a hive of this or that pattern, or of any particular material, will induce bees to 'make' most honey; but it is not so, bees do not 'make' honey at all, they simply gather and store it, and they will do this on all suitable occasions as well and as freely, whether their domicile be an old chimney-pot or an elaborate hive of French-polished mahogany and glass. Therefore we say, Study the comfort of the bees, and make the hive as convenient for the bee-master as possible. We have nothing to say against

the Stewarton hive when taken with the Stewarton system, as results prove that together they are *excellent*; we deal with the question as it is brought before us, and avow our conviction that *in the same locality*, side by side, a stock of bees in a rectangular hive (we will not say a *perfect square*), will yield as good results as a similar stock in a hive of octagon shape, the cubical contents being the same, and therefore *we would not* incur any extra cost in providing the latter.

There is little doubt but that a quarter-inch line of plain wax-sheet would be as good, as a guide, as if the same were embossed; but it is claimed that by giving a depth of some inches of the embossed material the labour of the bees is greatly economised, as not only are the *foundations* of their combs thereby already 'set out,' but that being of extra thickness to that required by them, they, in paring it away, are furnished with material for the construction of the *walls* of the cells also, and knowing that bees will economise material which is as it were 'put into their mouths' we should prefer the latter in all cases. Expense must however be considered in such matters, and doubtless will as usual govern the selection. In all operations of the kind we should prefer perfectly pure wax; but for guides only, inferior and dirty wax will answer well, the bees accepting and utilizing it freely, and therefore we do not think the small quantity of oil or balsam would be disagreeable to them. The groove in the Stewarton bar is for the insertion of the wax-sheet, which is part of the famous 'Stewarton system.'—Ed.

#### NOTICES TO CORRESPONDENTS & INQUIRERS.

B. A., Plymouth.—The method of making barley-sugar described last month, is infallible if strictly followed. If you re-read the directions you will be better able to judge where you erred than we can,—perhaps you tried to improve upon them.

PECCHIONI.—The Crystal Palace Hive mentioned by Mr. Fox is one of the 6s. 6d. Cottager's hives. We undertook to illustrate and describe Mr. Cheshire's Crystal Palace Prize Hive on the faith of his promise to supply a hive for the purpose, and are simply waiting his pleasure.

G. W. A.—Treacle is not good winter food for bees.

J. A.—Ligurian queens can only be obtained during the breeding season, or immediately on its conclusion. They may occasionally be had through it being necessary to unite stocks in winter, but such a source of supply cannot be depended on. It would be unwise to attempt to transfer stocks now.

INFERTILE.—Why hesitate? Bad writing does not appear in print. Send us your ideas, and you shall not be made 'ashamed.'

ROXBURGHIAN.—Queenlessness, the result of a late accident, does not necessitate immediate uniting. A queen may be found some time within a month, whose life it may be a pleasure to save. Inquire amongst your friends, or advertise in 'Want and Sale Column.'

INQUIRER.—It *was* an extraordinary proceeding; *our* columns are open.

Communications from—A Renfrewshire Bee-keeper; Busy Bee; B. H.; W. Carr; with articles on the Hive-Pin Bee-Trap, the Latest Hive, &c., are unavoidably postponed.

\* \* \* Several of the Nos. forming Vol. I. are now out of print. No. 14 also is exhausted. Covers for binding may be had from our Office for 1s. in stamps, post-free.

## BRITISH BEE-KEEPERS' ASSOCIATION.

THE Committee met by adjournment at Beaufort Buildings, Strand, on the 8th ultimo. There were present—T. W. Cowan, Esq. (Chairman), Messrs. Hooker, W. Abbott, Atlee, Cheshire, Hunter (Hon. Secretary), and C. N. Abbott, (Treasurer). The *business* of the Meeting was the discussion of a Set of Rules, brought forward by the Chairman, for the guidance of the Committee, and much time was usefully spent in their consideration. Some alterations from the original were made, and the result, proposed by Mr. Atlee, seconded by Mr. Hooker, and carried unanimously, was as follows:—

## COMMITTEE BYE-LAWS.

1.—All persons whom it is proposed to add to the Committee as Members shall be nominated at one meeting, and proposed, seconded, and voted for at the following meeting.

2.—Three shall form a quorum.

3.—The order of business at meetings shall be as follows:

1. Minutes of previous meeting.
2. Secretary's report.
3. Notices of motion.
4. Reports of Sub-Committees (if any).
5. Other business.

But the Chairman shall at any time be at liberty to vary the order of subjects upon the Agenda paper.

4.—Motions may be brought forward by a Sub-Committee or by the Hon. Sec. without notice, but other members shall give notice, in writing, at previous meeting, of any motion which they propose to submit, provided that motions of which no notice has been given may, if no objection be made, be at once brought under discussion, but shall not be put to the vote until the following meeting, if any member of the Committee object.

The Hon. Secretary then read a Memorial from Mr. Anderson of Ayrshire, which had been sent to the President, requesting the Committee's reconsideration of their determination to charge the full commission on the sale of the honey which he had exhibited, and which he alleged was not sold at the Palace Show, but afterwards. The Committee considered they had acted in accordance with their rules; but this being a special case in which the Memorialist had been at great trouble and expense, and had been of material assistance at the Show, on the motion of Mr. Hooker, seconded by Mr. W. Abbott, the amount was remitted. The Circular was again the subject of discussion, but nothing definite was arranged. All future Meetings will be under the above Bye-Laws.

5.—The Chairman, if called upon, shall rule that in discussion of resolutions each Member shall only have the right to speak once to each separate question, the proposer having the right to reply.

6.—The Hon. Sec. shall be an *ex-officio* Member of all Sub-Committees.

7.—One or more Auditors shall be appointed to audit the accounts each year, either by the Members at the General Meeting, or, failing such appointment, by the Committee, and that the accounts be made up to 31st December in each year.

8.—It shall be the duty of the Chairman to record in the Agenda Book all orders passed by the Committee.

9.—It shall be the duty of the Hon. Sec. to direct and supervise the paid officers; to obtain estimates for all contemplated expenditure; and generally to prepare the business for the Committee, to see that their instructions are recorded and carried into effect, and to call all meetings.

## WANT AND SALE COLUMN.

Communications to be addressed to C. N. Abbott, Havreell.

No.		s.	d.
69	Taylor's Manual of Beekeeping' ... ..	3	0
70	'Neighbour's Bee-book' ... ..	2	6
71	'Huish's Bee-book' ... ..	2	6
72	'The Female Monarchy,' By Rev. John Thorley	2	6
73	'Bevan on the Honey-bee,' last edition ...	5	0
74	Murphy's Honey-extractor ... ..	80	0
81	A Pettigrew hive, quite new, 18 in. dia. ...	4	0
82	Some beautifully white honey-comb of this year, per lb. Exeter ... ..	1	6
88	Super-honey from Palace, run into jars, any quantity, per lb. Droitwich ... ..	1	6
89	Eight of Neighbour's bee-feeders, mahogany floats, top glass, all complete, at ... each	2	0
90	Woodbury bar-hive, 10 frames, two windows, hinged covers and floor-board, complete ...	12	6
91	One straw ditto, 10 frames, one window and floor-board, good as new ... ..	14	0
94	A strong stock hybrid Italians, in straw hive	18	0
95	A strong stock black bees, in flat top straw or wood hive, with glass windows. Lincolnshire	15	0
96	Half a dozen strong well-made straw hives, flat tops, with hole in centre. Lincolnshire ...	12	0
97	Square queen-cages, perforated zinc, to release queens within the hive, the most simple ever made, 6d. each ... .. per dozen	5	0
98	Wanted.—A large quantity of Puff Ball, undried.		
99	Wanted.—Evans' Poem on Bees, either to purchase, or on loan at per month. Security given.		
100	Wanted.—Vol. I. 'American Bee Journal.'		
101	Wanted.—Two healthy stocks of Black Bees. Good condition, low figure. Great Western Railway.		
103	Two of Taylor's dividing hives, stained and varnished, fitted up with 8 improved bar-frames ... .. each	10	6
104	Two Swiss bar-frame hives painted, with 8 bar-frames and floor-board ... .. each	8	0
105	Two Neighbour's zinc bee-feeders with floats each	2	6
106	Two Neighbour's fountain zinc bee-feeders with floats ... .. each	3	6
107	'The American Bee-keeper's Manual.' By J. B. Miner, 350 pages, with 35 engravings	6	6

No.		s.	d.
108	'The Management of Bees.' By S. Bagster, 2nd edition, 240 pages with 40 engravings ...	6	6
109	'An Inquiry into the Nature, Order and Government of Bees.' By Rev. John Thorley, 2nd edition, 1765, 158 pages ... ..	4	6
113	Carr's improved mahogany observatory revolving bar-frame hive, second hand ...	60	0
114	I will exchange any of the above duplicate books (107-109) for Bonner on Bees, which I have read, but have not got a copy of my own.		
115	Wanted.—A Second-hand Stewarton hive complete.		
117	'Langstroth on the Hive and Honey-bee.' Almost new, but has one plate missing ...	9	0
118	Wanted.—Any quantity of empty worker comb. C. J. Smith, Stroud, Gloucestershire.		
119	Box Hive, containing 2 stock-boxes, 2 medium supers, and 4 small ditto, with access from stock-boxes to each or all of the supers, small window in each ... ..	15	0
120	Neighbour's improved bar and frame stock hive straw, with wood frame and one window ...	20	0
121	Wanted.—Dr. Dunbar on Bees. State condition and price post free.		
122	Two strong stocks of hybrid Italians in Abbott's new frame-bar hives, heavy enough to stand the winter ... .. each	45	0
123	Wanted.—'Guide de l'Apiculteur,' par M. De-beauvoys, 6e édition.		
124	Wanted.—'Journal of Horticulture,' from 1st January to end of November 1874.		
125	Wanted.—Some stocks of black bees, for cash, or will give in exchange pure bred black Spanish cockerels. Great Western Railway.		
126	A Langstroth hive, in first-rate order, never been used, outer case inch thick ... ..	40	0
127	Two Pettigrew ekes, fit 18 in. hive ... .. each	1	0
128	Wanted.—20 stocks of black bees, in skeps, must be healthy. S. W. Railway preferred. Weight no object, but should have plenty of bees.		
129	Virgil's Æneid and Georgics. 4 vols. Good preservation, Per rail ... ..	4	6
130	Several second-hand hives for patterns, from	5	0
131	Several tin fumigators, quite new ... .. each	2	0
132	Aston's drone-trap, new ... ..	4	0

THE  
**British Bee Journal,**  
AND BEE-KEEPER'S ADVISER.

[No. 22. VOL. II.]

FEBRUARY, 1875.

[PUBLISHED MONTHLY.]

Editorial, Notices, &c.

FEBRUARY.

Before proceeding to the business of the present month, it would perhaps be well to take a retrospective glance, and bring under view the state of 'the apiary' generally at the beginning of January, when, after sixteen days of continuous severe frost and snow, during which the various methods of preparing hives for winter were 'on trial,' a thaw took place, a brilliant day ensued, and the much-desired opportunity for an examination of hives arrived. The frost began on the 16th of December last, and continued until the evening of January 1st, when a cold rain set in, which, through the intense coldness of the earth, froze as it fell; but on the next day the sun asserted its power and awakened the bees which had been properly cared for to life and activity, enabling them to take an airing and cleanse themselves and their domiciles after their protracted confinement.

WINTERING.—On the first pages of the *January Journal* we called attention to the terrible weather (which culminated on the 31st of December, when the thermometer registered nineteen degrees of frost), and begged our readers to note the state of their hives under their various methods of treatment, when the frost came to an end; particularly with regard to the 'spaces above the frames' and to the respective values of the 'crown-board and quilt' as winter coverings. The effects of the cold weather confined us to our *domicile* on the 16th of December, whence, like the bees, we did not emerge until the 2nd of January; but on the 31st of December we were roused from our torpor and filled with consternation by the appearance in the *Journal of Horticulture* of the following from the pen of John Hunter, Esq., the Hon. Sec. of the British Bee-Keepers' Association:—

'Many bee-keepers have, at the recommendation of a well-known bee-master, this winter thrown away their crown-boards and substituted a square of carpet, supplemented by what one disgusted bee-keeper styles "a pile of marine stores to complete the quilt;" the result proves

what was long ago discovered in America. The whole, from internal and external moisture, becomes a rotten, mouldy mass, neither good for man nor bees, and the followers of this new fashion are fast discovering this. True, it is that bought experience is most appreciated, but it is a pity that payment should be made by the lives of the poor bees.'

After such a statement it would be esteemed a favour if Mr. Hunter would publish his authority for his assertion as regards the use of the quilt in America; we will not dispute that in certain cases the quilt may become wet, and mouldy, and rotten also, but it can only be in those where the rain or snow is allowed to get *into* into it, or where the moisture of the hive has been prevented getting *out* of it. As regards America, *The American Bee Journal*, with which is consolidated *The National Bee Journal* (edited by the Rev. W. F. Clarke and Mrs. E. S. Tupper), the highest authority in that vast continent of advanced bee-keepers, teems with the strongest recommendations of the quilt for winter-covering for hives, a few extracts from which will be found in the column for 'Foreign Intelligence.' We were, indeed, thrown into a state of consternation on reading the above extract, and on the 2nd January, with fear and trembling, we proceeded to overhaul our 'marine stores,' intending to succour our 'poor bees,' should they be in the dire strait prognosticated; but the 'fear and trembling' soon gave place to more pleasant feelings, for out of near forty stocks under quilts in no instance did we find anything to alter our opinion with regard to the quilt, which, we now feel certain, is the very best winter covering for hives. We have received many letters on the subject, every one in favour of the 'square of carpet,' or other material, in preference to the crown-board and space above the frames; and as the subject is *a most important one*, we trust it will be thoroughly ventilated.

STIMULATIVE FEEDING.—Towards the end of the month stimulative feeding should be commenced, that, if possible, a batch of brood may be coaxed into existence and some of the stored pollen consumed before the bees are able to gather and cucumber their cells with a new supply. Floor-boards should be cleaned or exchanged, vermin sought out and destroyed,



and all needy stocks fed with barley sugar. The value of barley sugar as a stimulant may be judged from the fact that just before the frost set in, two Carr-Stewarton hives had each been presented with a bottle of broken barley sugar, and on the frost breaking up they each contained *large quantities of eggs and brood in all stages!* These were the only hives in our apiaries which on the 2nd of January contained brood in any form, and something may be due to the hives themselves; but in the face of such evidence, the idea that bees remain torpid during severe frost is scattered to the winds, since, whilst the frost was most severe, the bees and their queens *must* have been both active and energetic. Barley sugar is famous food, both for stimulative feeding and feeding-up weak stocks, as it does not import water into the hive unseasonably; but later on towards the end of the month syrup should be given gently and continuously.

**OUR FEEDING STAGE.**—Hitherto those who have adopted the quilt have been somewhat puzzled for a means of feeding through it in a pleasant and cleanly manner. When giving barley sugar, nothing could be easier

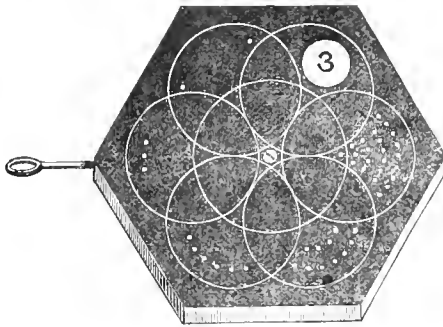

FEEDING STAGE.

than to turn up one edge or corner, and place some of the food upon or between the frames, but in giving liquid food with the bottle, the quilt would often become wet by capillary absorption, and so nullify the attempt to regulate the feeding as advised for stimulative purposes. To remedy this we have devised a stage on which feeding may be regulated with certainty; it is composed of a plate of wood of hexagonal shape, with a two-inch hole just within the angle marked by a pin, to correspond with the feeding-hole in hive or quilt, and is surmounted by a stout plate of vulcanite, also of hexagonal shape, having six feeding-places inscribed upon it.

These feeding-places are perforated with fine holes varying in numbers from two to twenty-four, (which may, however, be increased at the pleasure of the operator by means of a red-hot knitting-needle or hair-pin), for liquid feeding,

and one large hole of an inch in diameter for supplying barley sugar in bottles. There is another hole in the centre of the vulcanite, through which a screw is passed into the wood beneath, and on which the disc revolves, and as may easily be understood, when either of the angles of the vulcanite are brought to the point marked by the pin, one of the feeding circles is brought over the hole in the wood beneath, and consequently can be reached by the bees. If the large hole be brought to that point, the bees will of course be seen, but when it is turned to any other angle a number will become visible, inscribed on the wood beneath, which will indicate the number of holes under the bottle at the feeding-point. The hexagons are inscribed within a circle of six inches diameter, and as the vulcanite can be bought for sixpence, the feeding-stage may easily be made by any one of moderate ingenuity.

### APIARIAN MARKETS.

The article on the above subject has elicited, from a talented and earnest apiarian, the following remarks, which we hope will elicit the opinion of others on this most interesting question:—

Doubtless there will be at the Honey-fair a considerable sale of honey, but the fair will never become a safe market, and for these reasons:—1. It will take years to teach the public, both wholesale and retail purchasers, that the fair is the market for honey. 2. Wholesale buyers will not trouble themselves to visit the Crystal Palace to buy honey, seeing that the cheap foreign honey will answer their purpose as well or better than English. 3. Purchasers of honey for home use will only buy in small quantities, and they would prefer to take their chance of what they can get at the shop to laying in a stock once a-year at the fair. If 25,000 people attended the Show, and each bought a pound, this would not clear the fair of anything like the quantity of honey which might be sent, and which would be sent if a sale were certain. What is wanted is a place where honey—in the comb and run—can be sent by every one who has any to sell, and where it can *remain* till it is sold. This can only be effected by a depot for the sale of honey. The Honey-fair is a very good idea, and will no doubt answer the purpose of many; but what is to be done with that which fails to find a purchaser at the fair? Why should not the Association take the matter in hand, and work for the establishment in London of a honey-shop? A beginning might be made in a small way for next year. Surely there can be found in Oxford Street, about the Regent Circus, a shopkeeper who would for a percentage undertake the business. A grocer would find many a new customer from the number of those who came only to buy honey. It might, if thought desirable, be limited to members of the Association, which is now growing larger and larger. From this beginning depots might be established in other large towns. I feel certain that we must look for our customers amongst those who buy a pound or two at a time. Messrs. Neighbour in Regent Street sell a large quantity in this way, but are not, I believe, open to offers of small quantities. The public would gladly purchase honey in this way if it were offered. The demand at first would exceed the supply. Perhaps in

some future *Journal* you will make some remarks upon this suggestion of mine.

Possibly it *would* take years, or it would cost an enormous amount of money for advertising, before the public would become aware that the suggested honey-fairs were the honey-markets; but the same objection seems to exist with regard to a central depôt, for without extensive advertising the public would be entirely ignorant of its existence, and it is scarcely probable that purchasers of small quantities would go far out of their way to obtain at a distant shop what they could apparently as well get close at home. A knowledge of the fact that the majority of purchasers only buy small quantities induced our remarks in the *Journal* of last month, and such being the case, we gave preference to the Honey-fair, because the honey would thus be brought into immediate contact with *the public*. If 25,000 people would attend our next fair, and buy as many pounds of honey, we should think a grand success had been attained, and should quite expect to hear of similar experiments being tried in other great towns, and imitated in many of less pretensions, until honey-fairs would become as common as poultry-shows; and we have little doubt but that shortly such things will be. Already a honey-shop exists as mentioned in Regent Street, and another in Holborn, and few we think would have more faith in an Oxford Street tradesman than in the old firm whose houses of business are above mentioned? for there could be no security or warranty that he would not dabble in the foreign honey-market on his own account, and reap a rich harvest while under the patronage of the Association.

There need be little fear for the fate of any quantity of honey in any place where the public have assembled, if it be reasonable in price and in convenient and portable parcels, and if, after the *élite* have been supplied, the honey remaining is put up for sale by auction. And why should there not be such sales, not only of honey, but of hives and bee-furniture, after the shows? We do not hear of goods remaining on hand at Covent Garden or Billingsgate, where auction sales take place daily, except where reserved prices are put upon the articles. Buyers abound, and there is little doubt but that with honey, hives, and implements, as with other goods, if the upset prices are not prohibitory, ready sales by auction will easily be effected.

#### LEE'S CRYSTAL PALACE PRIZE SUPER.

This unique article rightly took the prize, in Class 33, "for the cheapest and best supers for

general use in an apiary," and in our remarks, after the Show, page 93, allusion is made to the price, which is recorded as 5s. 6d., but this is an error, as they are made to sell at 5s. 6d. *per pair*. It has very much the appearance of the original Woodbury super, having wooden framework, with glass panels; it is thirteen inches square and four inches deep, and is fitted with

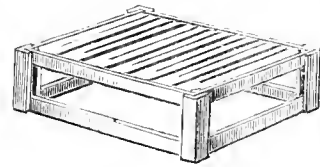

LEE'S SUPER.

seven bars, each of which may be sawn partly down, to admit of the wax-sheet guide as indicated. Its crown is purposely left off, to show its construction, which is a marvel of ingenuity. It is made almost entirely by means of a circular saw, and every one of its parts is cut to a mathematical nicety, so that they fit each other with great precision, and are all interchangeable with the parts of other supers of the kind. It is composed of two square frames and four ingeniously constructed pillars, each of which is a study in itself; one of the frames is laid upon the table, with the rabbeted side upwards and a pillar is pressed on to each corner, the glass is then slid into the grooves in the pillars, and the rabbets in the bottom frame; the top frame is then pressed on to the pillars, and the super is ready to receive the waxed bars, in fact, is practically complete. The pillars are most cleverly constructed, and in the hope that they may be understood we give an illustration of one of them occupying somewhat the position of that in the right-hand back corner of the diagram of super.

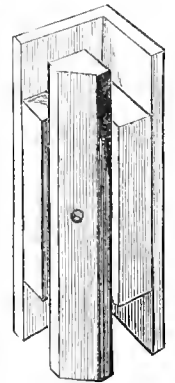

PILLAR ENLARGED.

#### OUR BUTTONS.

We have for many years been so deadly at war with the notched rabbet and rail, as distance guides for frames in hives, and have so often vented an adverse opinion regarding them that we have been charitably considered 'just a little touched, you know,' 'got a button off!' Now in general to be accounted 'short of one's buttons' is anything but complimentary, since it implies a 'something wanting' which few would care to acknowledge even to themselves; but in this particular instance we have long deplored the want of a 'something' which

should fulfil all the purposes of the Woodbury notched-rabbit, or Sibertswold metal-rack as distance guides, and yet be so far moveable as

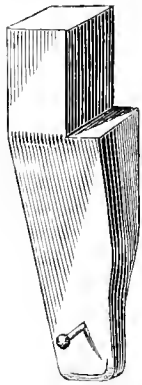

FIG. 1.

to permit of easy lateral movement of the frames without the necessity for first raising them out of the notches, which in practice are found objectionable, and this we think may be effected by our new buttons.

Fig. 1, illustrates one of the wooden buttons, which are intended to form distance blocks for hives of the Sibertswold pattern, whose frames, for convenience in handling, project through their front and back walls; but instead of their being fixed to the hive, they will be moveable on the frames,

and when raised from their position as guides, will permit the frames to be slightly crowded together, so that lateral space may be created, and the frames easily removed without the necessity for injuring a single bee. In fig. 2, the buttons are shown in use; A repre-

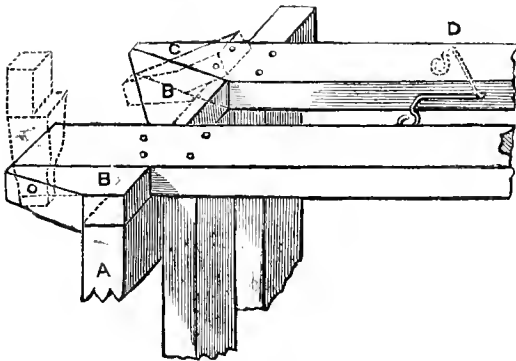

FIG. 2.

sents the top of the wall of the hive; B, the buttons, of two distinct forms, the front one being of the shape of fig. 1, while that at the back is arranged to double back within the parallels of the top bar, so that it shall offer no inconvenience when the frame is placed in the extractor. As will be seen, they not only fulfil the purpose of distance-blocks, but their shoulders (on the underside) when pressed down, come against the outside of the walls of the hive, and prevent also longitudinal movement of the frames.

For hives on the Woodbury principle, in which the frames do not run through the walls of the hive, and longitudinal movement is already prevented, the button may be made in a skeleton form, of wire, as indicated in fig. 2, at D, or a simple wire nail bent into the form of a crank (fig. 3), may be made to answer the purpose, one end to act as a spindle, being driven

into the frame near its end, while the other forms the distance-guide. These are so far superior to plain straight nails as distance-guides, and so easy of construction, that they will doubtless, presently, be brought into general use. In applying the buttons, one

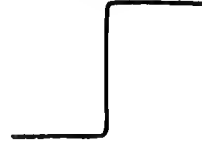

FIG. 3.

should be placed at each end, and on opposite sides of each frame, that they may be reversible, which they would not be if both buttons were on one side; and to make all comfortable within the hive a tack or pin should be driven into the two corners of the hive, corresponding with the outside frame-ends, which are not furnished with buttons, which pins should stand out into the hive about a quarter of an inch (half distance), while notches should be cut into the side walls of the hive at the other corners, to receive half the width of the buttons which will come against them; and if this be carefully done the much-abused Woodbury hive will be rendered as useful, and as easy of manipulation, as the most expensive hive of its class.

#### A SCRAPER, KNIFE, AND SUBSTITUTE FOR FEEDING-SHOVEL.

This handy little tool will be found very useful for scraping and cleaning hives, floorboards, and frames; its blade is of elastic steel, and is six inches long, and three inches broad at its wide end. Its handle is four inches long.



Originally it was straight, but seeing that with a cramped handle it would render the shovel unnecessary with the bottle-feeder, we caused ours to be bent at the shoulder and sharpened on one edge, so that it forms a knife, a scraper, a feeding-shovel, and a spatula for cutting or lifting honey-combs.

#### THE IMPROVED COTTAGE WOODBURY HIVE.

The first Cottage Woodbury was built about six years ago, and was first brought before the public in No. 350 of the *English Mechanic and Mirror of Science*, page 306, under the name of the Woodbury Bee-house, and then its most commendable features were its cheapness as compared with the original complete Wood-

bury, and the advantage which the closed dead-air spaces between its double walls and floor-board, gave it over the loose fitting Woodbury outer case, as a superior means of protection from the variations of climate, and the attacks of insects, for which it afforded no harbour whatever. Internally it was exactly the Woodbury type, and contained all the evils of that hive, which we have made conspicuous in these pages; but now we think it is purged of most of them, and in that belief we place it before the bee-keeping public and await its verdict. Its stock-box is double-walled, its floor-board is double and reversible, running on guides fixed to its legs, and fitted with wedges for raising and lowering it when necessary either

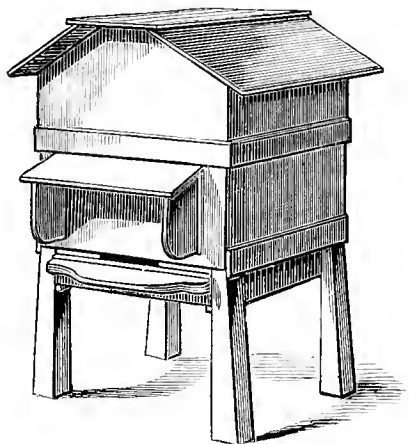

for ventilating purposes, or when its removal for cleaning or reversal is desirable. Like the Woodbury, it is  $14\frac{1}{2}$  inches square and 9 inches deep inside, and is furnished with ten frames; but, through the omission of the rabbets and notches at the top of the hive and the notched rack at the bottom, the comb-building area in the frames is so much increased that its 10 frames are equivalent to  $11\frac{1}{2}$  of the old pattern. It is intended for use with the quilt, which experience during the past rigorous weather has proved to be the right thing for winter wear, and consequently no space is left between the frames and crown. It is furnished with one of Lee's Crystal Palace Prize Supers, has weather-proof super cover and roof, and having four strong legs of its own, requires no stand. The mode of constructing this hive will be described in our next, so that every one who can use a saw and drive a nail may, with a little ingenuity, make them for themselves.

#### THE FIVE-PIN BEE-TRAP.

This admirable little article is the invention of our ingenious friend, F. Cheshire, Esq., and was awarded an extra prize at the Crystal Palace

show. Its great value consists in its being so simple that every one who can bore a hole or drive a nail, can make it for himself. It is used for permitting bees to escape from a super and barring their return. The best way to apply it is to take a box sufficiently large to contain the super; bore any number of quarter-inch holes through its sunny side, stick two pins nearly close together just above, and two others just below each hole, all inclining upwards, as shown in engraving, a fifth pin is

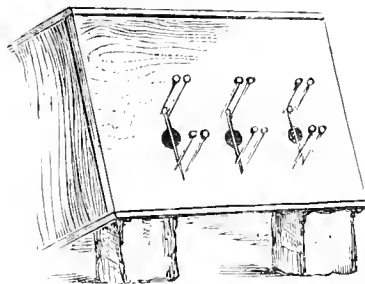

then dropped down across each hole and the trap is complete. In use, the front (sunny side) of the box should be raised on a couple of bricks, so that it may incline backward and cause the perpendicular pins to lie flat against the box, where unless bees push from behind to get out, they will lie closely, and securely bar the holes against all outside bees. Such inventions are specially commendable, as they greatly aid bee-keeping, and do not smack of the shop.

#### A NEW BEE SOCIETY.

A meeting of all those favourable to the formation of a Society for the cultivation of bees was held at Kerriemuir, on Monday night, December 14 last. Mr. David Low, Station Brae, occupying the chair. After partaking of an excellent supper, at which about twenty sat down, it was agreed to form a Bee Society, and all those present enrolled their names as members. It was resolved that the Society meet quarterly, and that an annual exhibition be held, and prizes given, so as to encourage the cultivation of the honey-bee.

Bees may have too much honey to winter well. Mr. Cary says bees will not winter well in solid honey. There must be a fair number of open cells for them to cluster in and keep their heat, by being in a compact mass. When the cells are all capped, they must necessarily occupy more space, and cannot withstand cold weather. Mr. Cary also observes that bees do better in a dairy region than where large numbers of sheep are kept. Sheep eat very close, and consume clover heads and flowers that cattle would leave; thus the bees are deprived of food. There is a marked difference, he says, in some parts of the country, where the farmers have changed cattle to sheep husbandry. —E. PARMLY, *New York*.

## Correspondence.

\* These columns are open to *Subscribers*, so that their *queries, replies, correspondence, and experiences, may be fully and faithfully recorded; and for the discussion of all theories and systems in Bee-culture, and of the relative merits of all hives and appliances, that the truth regarding them may be ascertained. The Editor, therefore, must not be expected to coincide with all the views expressed by the various writers. All Correspondence is addressed to the Editor.*

### SELECTED HONEY—HONEY FAIR— HIVES—THE QUILT, &c.

Notwithstanding the great success of the late show at the Crystal Palace, I felt at the time (and the opinion I then formed has been justified by your article in last month's *Journal*) that in one respect the affair was a comparative failure,—I allude to the sale of honey; and it will be readily acknowledged by all practical beekeepers, failure in this one feature will tell most forcibly against any amount of success in less important ones, for if no market can be found for our honey, it will become rather a nuisance than otherwise to obtain a good harvest.

So it becomes a positive necessity that we should consider how we can remedy the evil at the next show. Your proposal to have a staff of salesmen is an excellent one, but I think bee-keepers themselves may facilitate sales, by sending honeycomb in a marketable form, and not in immense supers for which 3*l.* or 4*l.* are asked. Of course, supers that are prepared expressly to compete for prizes will always be large and valuable, but I should like to have asked Mr. Neighbour how much he would give for the glass super exhibited at the Palace (and which aimed at being a counterpart of the Manchester sensation one). I do not believe any dealer would have given 10*l.* per lb. for it in bulk, for by the time it was cut and pulled out of that glass it would be almost unsaleable as 'comb-honey.' Again, a friend of mine exhibited a couple of Carr-Stewarton boxes, each containing about 20 lbs. of comb, and when told that he must 'price them as they stood,' he, of course, added the cost of the boxes to the value of the honey; and what purchaser would like to give 10*s. 6d.* for a box to carry home 20 lbs. of honey in, for we must remember that honey-buyers are seldom or never bee-keepers, and in their eyes a Carr-Stewarton box is simply a package of no value when empty. I therefore argue that we should make it a special feature in the next show to encourage the making of supers small enough to meet the requirements of ordinary purchasers, in which the cost of the super itself will be on a par with such boxes, glasses, and jars, as are used in the ordinary purposes of trade, and which may be tossed aside when empty. This brings us to the question of what is the most suitable article for the purpose, and I regret very much that my 'misfortune, not my fault' (as you, Mr. Editor, are aware), made me a non-exhibitor, for most of my supers were small glass ones, weighing from 5 to 17 lbs. when full, and the cost of which did not average 6*d.* each. They were simply the cuttings of glass

shades, with adapters cut from  $\frac{1}{4}$ -inch boards, which I purchase ready planed and cut off as I require them,—in fact, something like those you recommended in a former No. of the *Journal*, Vol. i. p. 135, and which I have used for three seasons with great success. I am sure no supers look better when filled, and the cost is merely nominal. I pay 3*s.* per dozen for the glasses, taking large and small, and the dealers are glad to sell them, for they only regard them as waste glass.

In an article in your November Number the Hon. and Rev. H. Blyth proposes that the place of honour in the next show shall be given to a class for the largest and best harvest from one stock; now while fully endorsing the opinion of the rev. gentleman, that the object of every bee-keeper is to obtain the largest harvest he possibly can from every stock he possesses, I venture to differ from him as to the desirability of our committee making this particular class a special feature for encouragement, because, though I should not like to be classed with those very cynical folk who would 'treat every man as a rogue till you prove him honest,' yet it is a well-known fact that where there is competition at exhibitions, there is, and always has been, and I suppose always will be, trimming, colouring, and doctoring, or, in other and plainer words, cheating; and I do not see that we bee-keepers can lay claim to any special virtues not possessed by others; so if a large harvest is to be shown, as obtained from one stock, it should, in my opinion, be above suspicion, that is, in a single box or glass. Suppose two or three Carr-Stewarton boxes are shown as from one stock, what is there (but a sense of right and wrong) to prevent them from having been partly filled on as many stocks, and placed on one for completion, and what judge could tell they had been so manipulated? and I think if the making of very large supers be encouraged, the sale of honeycomb will be retarded, or at least the labours of the salesmen be much increased.

Would it not be better to give the place of honour and prizes named by your contributor, to a class 'for the largest and best exhibition of super honey from one apiary, placed on the show table in the handsomest and most saleable form.' We should thus push forward that very important part of our work, the establishment of a 'Honey Fair.' It is not satisfactory to hear the question asked (as I did by a prize-winner at the Palace), 'What shall I do with my honey?' and though we were surrounded by bee-keepers,—for it was during our 'friendly dinner' after the show,—yet no one could say, so I suppose the expense would have to be incurred of taking it back home. If we would make bee-keeping profitable as well as pleasant, we must show a way of getting rid of the produce of our industrious little workmen, readily and at a fair price. This can be very considerably assisted by doing as you propose, and selling the comb in pounds, single bars, and cheap, small supers, value from 5*s.* to 20*s.* At the same time, I should like to see 'fancy prices' abolished from the next catalogue. If exhibitors do not wish to sell, leave out the price altogether, as it can only puzzle intending purchasers to see one person asking 3*s. 6d.* per lb., while another offers as good at about 1*s. 6d.* For my own part, I think our committee should frame a

scale of prices for the general sale department, and then we should have uniformity at least, while if I am content to sell my honey at 1s. 6d., and another values his at 3s. per lb., we cannot give satisfaction.

Now, Mr. Editor, will you allow me to say a few words on the hive question? The greatest pleasure I had at the late Show (next to that of shaking you by the hand for the first time, and making the acquaintance of many apiarians whose contributions to our *Journal* I had read) was the opportunity it afforded of overhauling and thoroughly examining the various hives, &c. which were shown; for you must know, sir, I am in a sort of transition state myself as a bee-keeper, and, after trying Pettigrew's and other hives, have determined to work a change in my 'dead-stock' department, and adopt moveable-comb hives of a uniform size throughout my apiary, so as to introduce our wonderful friend the 'Slinger,' and the many advantages it affords. But, as my present twenty stocks are not badly housed in 'Woodburys,' 'Pettigrews,' 'Neighbour Cottage,' and straw hives with flat wood tops, I could not think of making 'firewood' of these, so I resolved to work a change gradually. The hive I liked best was the double-walled one bearing your name: so I had a chat with Mr. Lee, of Windlesham, at the Palace, and got him to make me one with some of the features of Mr. Cheshire's hive added, viz., the porch and hinged roof. In due time I received the article, and am bound to say I consider it, if not the very best hive, one which will give satisfaction to any practical bee-keeper not given to 'whims;' at least, I am well pleased with it and shall use no other.

With an eye to economy I wrote Mr. Lee to give me an estimate of the materials for half-a-dozen hives similar to the one I had already. The wood-work to be ready planed and cut to fit (the dummy and bar-frames finished complete), so that I had merely to find screws and nails and put them together myself. The price was satisfactory, and I ordered them. They arrived, capitally packed, not the smallest breakage, and each of the parts tied together in lots, with instructions and suggestions written on each, so that the simplest amateur joiner, who could drive a nail straight, would have no difficulty in finishing them off; indeed, I cannot conceive a pleasanter job for an earnest bee-keeper than building up these hives: you seem to get on so quickly, and the various pieces go together like the wheels of a clock, without the necessity of using saw or plane. I really think I would not forego the pleasure the work gave me, if nothing was gained in the cost, but when I tell you that I got them, with six pairs of prize supers, six adapters, packing-case and carriage complete, for 7l. 12s. 7d., or an average of 1l. 5s. 5d. per hive, it will be seen the advantage is no slight one. Of course there are screws, nails, and paint to be added, but these do not cost a great sum; and what bee-keeper will grudge the price when a really good article is desired, such as will meet the wants of those who, like myself, desire to make bee-keeping profitable as well as pleasant, and *vice versa*?

Before I close, I must offer a hint regarding 'ventilation and the quilt,' which, if followed, will, I venture to say, do something towards solving the

much-disputed question of the suitability of the quilt as a winter covering, &c. I have tried several plans during the last four months, and the following has answered admirably. Let a single thickness of carpet be laid on the frames, and over this about four or five inches of soft oat straw, well broken and pressed down pretty closely, this is kept together by strings tied over it from side to side and back to front, and it has proved an excellent covering, simple and cheap, while the hive on which it has been tried is in the best possible condition.

The straw keeps in the heat, but retains none of the moisture passing through it; and for spring feeding the hole can be got at without disturbing the covering, except to open the straw that covers the feeding-hole.

I have lost no stocks as yet, though the winter has been most trying, as far as dampness is concerned.—W. BROUGHTON CARR, *Higher Bebington, Cheshire, Jan. 21st, 1875.*

#### AFTER THE FROST.

The 2d January was the day the thaw began in this district, and it was grievous to see the destruction amongst the bees, the snow being literally covered with them from ten to fifteen yards from the hives. I have no doubt a large proportion of them might have been saved had care been taken in time: but it was too late in the day when I first became aware of it, and then taking a few of them to the fire they soon rallied, and on opening the window took their departure, but I think it is rather doubtful if they regained their hives. Again, the next morning a great part of the snow was gone, but in one part of the garden some was still left, and on it several bees, from ten to fifteen yards from the hives. I took these to the fire, and sure enough two of them soon showed signs of life after being in the snow all night; but only one of them revived sufficiently to crawl about, the others were all dead. It would appear that bees will stand any reasonable amount of cold, much more than we generally give them credit for. As you asked for information when the frost was gone I send you this; it may be worth inserting in the *Journal*.—G. F. PERKINS, *Hillwootton, Warwick.*

As I see by your January number that you invite information respecting the manner in which various stocks have stood the late severe weather, I trouble you with a few remarks. I had three hives, good stocks, with sufficient food to take them on about six weeks from this. One a glass hive,  $11\frac{1}{2} \times 10\frac{1}{2} \times 7$  inside measure (not a bar-frame), with folding shutters on all sides, which opened to give a view of the interior; wood top, with hole in centre for feeding; also two straw hives (Neighbour's Improved Cottage, not bar-frame). A week before the frost set in these were apparently all healthy and in good condition. Anticipating frost, I put about the straw hives two thicknesses of old Brussels carpet: on the glass hive I put two thicknesses of carpet, and outside the carpet a thin wood-case about a quarter thick. On Sunday last, being a very bright morning, I went out to examine and see how they had all stood the severe frost. I

found the straw-hives all right, a few dead bees brought to the entrance, but nothing to cause any doubts about their health; for as soon as I cleared the dead bees away they came out very strong, the interior showing sufficient food for some time. Not observing any movement in the glass-hive, I opened the front shutters and found the bees all dead, no doubt frozen to death. On turning the hive up, I found the floor-board damp and mouldy, and one side of the hive quite wet. I had placed a feeding-bottle over the centre hole for ventilation, covering it with a small straw super, but it appears not to have had the desired effect. There were 9lbs. of honey in the hive.

I deduce from the above that glass-hives are not fit to winter bees in. The swarm was put into this hive June 1873, and stood the winter of 1873-74 all right, and threw out a very good swarm on July 2, 1874, but that winter was much milder.

This year I hope to try the bar-frame hive, and use the quilt. I have made one fourteen inches square inside, description as given in the *Bee Journal*, but does it not seem very large to what I have been used to, viz. 'Neighbour's improved cottage?' You will think I am very tedious, but I take very great interest in bees, so this must be my apology.—JOSEPH TORRY, *Lower Fant Road, Maidstone.*

['A South Lancashire Bee-keeper,' writing in the *Journal of Horticulture*, says, 'I have the Woodbury Glass Observatory hive with nine bars, and I must confess I would much rather have glass than wood; there is no moisture in it if you will take off the top, and put on the quilt to prevent the steam from condensing. The italics are our own.—Ed.]

### WINTERING.—THE QUILT.

My attention has just been directed to a letter in the *Journal of Horticulture*, from the pen of Mr. John Hunter, in which a very ungenerous, and to my mind, undeserved thrust is made, Mr. Editor, at yourself, in reference to your advocacy of the 'Quilt' as a winter covering. It appears from Mr. Hunter's note, some 'disgusted bee-keeper' and many others who are hinted at, have failed most dismally in their attempts to make the quilt answer the purpose intended; but I should like to ask, how many are there who, having carefully noted the instructions given in the *Bee Journal*, have followed them in a workmanlike manner, and yet have failed; or whose hives have become a 'rotten, mouldy mass.' I can only say, mine have not; and I think, if Mr. Hunter had given it a fair trial, his would not.

I must suppose he has tried the experiment in his own apiary and failed, otherwise he would surely have paused before he penned the latter part of the note referred to, in which he condemns the quilt with such hearty bitterness.

I remember when, some few years ago, the bottle-feeder was recommended (and who can name a feeder to compare with it for simplicity?) a bee-keeper (*sic*) wrote a very melancholy account of his failures in attempting to use it; he got the right sort of bottle, covered the mouth with the right sort of net, &c., &c., but it was no use the syrup *would* run out when he reversed the bottle; so he gave it up as a

failure. But we did not all give it up; and I trust we shall not all give up the quilt because some have not made it answer. Let us rather inquire into the causes of failure; and those of us who have succeeded with it will doubtless be glad to impart the *modus operandi* to such as desire information on the subject, so we shall forward the cause we all have at heart. And let us, Mr. Editor, for goodness' sake, give up this tendency to *sting*, which I have observed rather prevalent among our bee-keeping brethren; it is all very well for such as you, who are 'sting-proof,' but those of your humble followers in the art, like myself, who are apt to 'swell' a bit, cannot refrain from expressing regret that difference of opinion should be a drawback to the success of our favourite pursuit.

I do not suppose many apiarians will be induced to follow Mr. Hunter's lead, if he proposes to do away with the covering above the frames altogether, for this is going against the instincts of the poor bees with a vengeance, and a solitary instance of success such as he records does not prove the theory to be correct; for instance, I have a hive in my possession the sides of which are composed entirely of single pieces of thick plate glass, with brass uprights at the corners, and 1-inch mahogany crown-board.

This hive wintered exceedingly well in '73-4, and last season gave me between 40 and 50 lbs. of super honey, in addition to rebuilding and filling the side frames (which were removed in consequence of mouldiness). Now while the above occurred to the hive in question, I lost 7 stocks out of 19, all of which were in very much better hives (wood and straw), yet I never thought of rushing into print, and declaring that my glass hive was the best winter domicile; but it only proves that 'bees do nothing invariably,' and a solitary instance is nothing to go by.

If the disasters are as numerous as we are led to suppose, I fear, Mr. Editor, you will have a warm time of it, and your editorial chair will be anything but a comfortable seat; so I am anxious for the appearance of the *Journal* for next month, when we may expect a long list of complaints.

I question if the quilt could have had a more severe test than this winter has given it; and if it should come off victorious, as I believe it will, the time and trouble will not have been ill-spent, for we shall have made a long stride in the right direction; so if our worthy hon. sec. will forgive me for asking him not to give it up *yet*, but just try my plan of a thick covering of soft straw, laid on the carpet, as directed on another page, he may yet become a strong advocate of the much-abused quilt, and dispose of its opponents as readily as he did Mr. Pettigrew's failure with the Honey-slinger.—W. BROUGHTON CARR, *Highley Bebington, Cheshire, Jan. 25.*

### THE QUILT.

It may interest some of your readers to know that woollen tops, now called quilts, have had a five years' trial with me on wooden hives.

In the year 1870 I saw that Langstroth recommended carpet as winter covering.

My hives being all of wood, I found that the



accumulation of moisture in the winter was very injurious, and had tried various ways to ventilate the hives with more or less success. On getting the hint, I made frames the size of hives and stretched three or four laps of floor-cloth or house-flannel over them, and replaced the covering-boards with the tops so prepared. The result has been perfectly successful, and I have not seen the slightest sign of damp in one of my hives since, and the health of the bees has been all I could wish.

The only drawback I have found is that mice from outside, and the bees themselves from inside, gnaw holes in the cloth. The former I guard against by laying a square of pierced zinc over the quilt.—E. W., Jun., *Dublin*.

#### THE QUILT—BEES SLEEPING DURING THE WINTER—EXTRACTOR—WAX.

After seeing your request to bee-keepers to give their experience of the utility of the quilt, two days after the thaw had commenced, I examined my fourteen stocks from which I had entirely removed the crown-boards and substituted quilts, covering each with a folded rice-bag. They were all, without exception, quite dry, and the bees appeared brisk and all right. I consider it is first-rate for ventilation, and even for feeding, at this time of year. For some that were rather short of food, I have turned up the quilts and given the bees barley-sugar, and covered them up again almost before they had time to see what was the matter. There is no jarring like that connected with the removal of the crown-board, which sets the bees in commotion; and even if there was no other advantage, I consider *that* a most decided one, as it can be so easily, quietly, and quickly done.

'Do bees sleep?' is a question I have seen asked in another paper. A day or two after Christmas, I had a couple of bee friends called to see my bar-frame hives. I uncovered one of them that had a quilt, and found the bees as lively and as frisky as kittens—no sign of dormancy, as I had previously supposed. I did not jar or shake the hive (so that, supposing they were asleep, they would not be woke by that means), but if I had not quickly closed them up, they would soon have been on the wing, which was not advisable, as it was freezing sharply at the time.

Now for a word about the 'Extractor.' If I had not made mine I should scarcely have had any surplus, as the bees stored most of the honey in the stock-hives, but by laying them under contribution I was able to get a nice lot of honey. I had two stocks that I had given top stories filled with frames of drone-comb, which gave a large yield, considering that in July, when the comet appeared, our white clover was completely burnt up. I am now making an Extractor to take Woodbury frames that will take up but a small space, and will stand on a kitchen-table, as suggested by a writer in the *Standard* on the Crystal Palace Show. To those readers who had supers smashed in transit to said Show I would say, Stick to the Railway Company, as I have got compensation from the London and

North Western Railway for destroying the only super that I sent to the Show. I got third prize for wax, but I heard that it was hinted that my wax was coloured. Indeed Mr. Wood says, in the December number of the *Journal*, 'A doubt was also excited relative to the purity of some of the samples of wax, such as their not being quite free from colouring matter.' My better half, who had the management of it, was very much annoyed about it, when I told her the colour of the wax that took first prize; she declares the judges knew nothing at all about wax, and that it was no inducement to try to get pure wax on any future occasion. Mr. Wood also speaks about the honey exhibited in jars being so dark, and some having the appearance of not being free from fermentation. I exhibited fifty glass jars, ranging from 35 lbs. net to others, eight, six, four, and two pounds weight, some of which, not being quite full, and having gone by train one hundred miles, had frothed a little, but not fermented. I hope Mr. Cowan will be so good as to give us his plan of working the Woodbury hives, so that there will be a chance of preparing some hives before the long evenings have gone.—A WARWICKSHIRE BEE-KEEPER, *Neston, Leamington*.

#### THE QUILT.

I was very glad to read your description of the Quilt in the November number of the *Journal*, believing it was just the thing desired for wood hives, and lost no time in applying them, which I placed upon the hives about the middle of November, before the winter came upon us. My experience with wood hives had been almost a failure, which I attributed to the severity of the winter season and dampness of the atmosphere in this neighbourhood, especially during the winter and spring months, always finding them behind the straw ones, both in swarming and honey-gathering, although I used condensers of tin or zinc dishes, with  $1\frac{1}{2}$  inch hole in centre (and a rim round to prevent the condensed vapour returning into the hive), and an inverted tumbler or small bell-glass over the opening, so that it was impossible for the water to return; still they were damp and mouldy, so I was half inclined to disuse them altogether, and fall back upon the straw hives, as some of my bee-keeping friends have done; but now I think we have got over the difficulty, and believe that with the quilt wood will be equal, and in some respects superior, to straw for homes for our 'little favourites.' I examined my hives on Saturday, January 9th, in company with a friend (Mr. J. W. of Rochdale), and found those with quilts quite dry and healthy, and in every respect equal to the straw ones, after the very severe storm which had just passed away, when my friend expressed a wish that he had adopted them, and would do so as soon as convenient. Whilst upon this subject, allow me to say, that I do not intend to use any more crown-boards only as adapting boards for supers, or when removing the hives to the heather, and then I shall place the board, or boards—for they are in five sections—close to the bars, as I have found the inconvenience you speak of in allowing a space above them. The boards

will be fastened with screws, and the two sections on each side have slots for the screws, so that I can slide the outer one  $\frac{3}{16}$ ths, and the next  $\frac{3}{16}$ ths of an inch, so making four openings of  $\frac{3}{16}$ ths, or 2 of any width to  $\frac{3}{16}$ ths of an inch into the super, which may be closed at pleasure.

I also wish to state that I find the eleven-bar Saddleworth hive too large, and have just completed one with nine bars, which I think a nice size; in other respects it is like the one described on page 194, Vol. I. of *Journal*, with the exception of the Vs at the back, which I found inconvenient in manipulation, and have therefore discarded them, as the bars had to be lifted every time they were moved.—A SADDLEWORTH BEE-KEEPER, *Jan. 19, 1875.*

### THE OCTAGON HIVE.

It affords me pleasure to heartily thank your correspondent, 'Questioner,' and through him Miss Davidson, of Tunbridge Wells, for so kindly favouring us with the drawing of the transparent hive referred to by Wren, which, if we except the central communication being circular, instead of square, appears to be exactly the counterpart of the hives of Geddie, Rusden, and Thorley, and, as I strongly suspected, the 'splendid supers' of the 'Stewarton hive' of Kerr formed no part.

I must own to a feeling of disappointment that 'Questioner' did not step forward last month and clear up the mystery which shrouded the invention of the Octagon Hive, as, from the hints thrown out previously, he seemed in a position to do so.

Your correspondent throws a doubt on the accuracy of my quotation from Milton, which is recalled for, as I reproduced these exactly as they appeared in his work, and I previously hazarded the opinion that that author was a careless compiler, from his having omitted the name of the old book, together with the drawing and description of Wren's hive, as well as the name of the party to whom Wren's letter was addressed, through the columns of a contemporary. I have had recently an opportunity of comparing that letter, as extracted, along with the drawing, from Hartlibb's book, and find its date to be February 26, 1654, instead of February 16th, as given by Milton:—'Prompted by mine own ambition to find any way to show myself a *servant* to a person so eminent among the ingenious as yourself—the word '*servant*' in this sentence Milton translates into servant; then a little on, '*Last May, as I remember, we put in two swarms together.*' The first five words underlined by me do not appear in the original; but to pass over several other verbal changes, the most inexplicable alteration takes place in the closing sentence, 'You can afford us from other men's observations that have tried the like experiment, for yet you see ours is unperfect, and we know not what to make of it,' is altered by Milton into 'You can afford us from the observations of others who have tried the like experiment for us, yet you will see ours is imperfect.'

I some time ago proved that Rusden did not invent the Octagon Hive, neither did Geddie, although he was generally accredited with it, from having obtained a patent from Charles II. Both

these apiarians had first seen the hive in the possession of Dr. Wilkins, Bishop of Chester; this we had on the authority of Rusden. Then arose the question, Was the bishop the inventor, or who? as I put it at the time, I feared it would have to remain an open question. Then came Milton's account of the very old book on bees he purchased at the sale at Strawberry Hill, containing Wren's letter, with drawing and description of his Octagon Hive, twenty-two years before Geddie obtained his patent, and as the inventive genius of Wren was very great, and his biographers tell us, many of his inventions were subsequently pirated, and being too upright a man to describe the invention of another as 'Our three-storied bee-hive;' and according to Milton's version of the latter parties having 'tried the like experiment for us,' coupled with the hive being in the possession of Dr. Wilkins, Wren's early patron, all tended to the strong probability that Wren did invent the Octagon Hive; more particularly this view was materially strengthened by Milton leaning to the hypothesis while apparently familiar with Hartlibb's book, from which he quotes, placing the Octagon Storifiers in the following order: Wren, Geddie, Warden, and Thorley, which, too, lead to the inference that the very old bee-book he picked up at the sale was *not* Hartlibb's, still Wren's letter turning out to be addressed to Hartlibb, the likelihood, despite Milton's silence, it was the very book; and the latter author's motive for withholding this, and altering the text of Wren's letter, I am at a loss to conceive.

To a subsequent issue of the contemporary alluded above (*Agricultural Gazette*) I am indebted for the copy of a portion of a most interesting letter which throws much light on the point at issue written by Mr. William Mewe, minister of Eastington, in Gloucestershire, to Mr. Nathaniel Angelo-Fellow of Eaton College, and dated 19th September, 1653.

'Sir.—Being made known to you, I could wish it had been of a better character than a bee-master. 'Tis true, since I left the hot service of the City, I have an apiary in the country, wherein I find profit enough.

'I observed many rarities of their work and government by mine own experience upon Butler's observations.

'But when he told me of a gentleman in Plimie's time that endeavoured to make their works transparent (but as he thought improbable), I tried and finished that essay to the satisfaction of myself and others.

'The invention is a fancie that suits with the nature of that creature; they are much taken up with their grandeur, and double their tasks with delight.

'If you desire the model or description, I shall give the same to you I did to Dr. Wilkins, Warden of Waddham, and who bath with great curiosity set up one in his garden, and, as I hear, is setting up another with great augmentations, &c.

The writer of the article in the *Gazette* concludes from his examination of Hartlibb, a work I long much to see, that the invention of the Octagon Hive is due to Mewe, and concludes as follows:—

'That Mr. Mewe, therefore, divided the transparent Octagon Hives of Wren, Warden, Geddie, and Thorley, which were modified according to the different tastes of these older apiarians, we think there can scarcely be a doubt. He was recognised at the time he lived as the "father of the invention," and, I may add, his colonies in two-storied dwellings, &c.

A RENTREWSHIRE BEE-KEEPER.

## EARLY POLLEN GATHERING IN 1875.

A hive of Ligurian bees, the property of John Wilkie, Esq., Gonroch, commenced carrying pollen on the 10th January.

## WAX-SHEETS.

In compliance with a 'Renfrewshire Bee-keeper's' request as to the mode of making wax-sheets, I have to say, my knowledge of the above useful invention was derived at first through Messrs. G. Neighbour and Son, 149 Regent Street, London, in 1862, who forwarded me specimens of the wax-sheets as imported from Germany in that year, and exhibited at the Crystal Palace; and who still manufacture them, as well as supply plates for impressing the same. So well pleased was I with these sheets when I first saw them, that I at once determined to try the manufacturing of them myself. I accordingly set my brain to work and to carry out the same; and in a few hours after the arrival of the first sheets imported to Scotland, I had plain sheets of my own manufacture. Yet notwithstanding my success in producing the plain sheets, I was still far behind in not having the plates, nor the knowledge of how they were impressed. My brain was again called into action, and my first step was to be in possession of one plate that would do the work; once one, plenty more could be had. I then prepared a piece of composition, the same as is used for enriching mirrors and picture-frames; this I rolled out to a cake of equal thickness; then drawing the lines necessary for the formation of the cells, with a tool prepared for the purpose, I cut out the indentations. This occupied several days. After being finished, however, I had no difficulty in making obverses, and these were in gutta-percha and of composition. The plates now prepared, the impression was the next operation, which I managed in the following manner, viz., by first wetting the plates, then placing the sheet between, using my own weight as a press; concluding in my own mind that the manufacture of wax-sheets was only child's play. But I shall never forget my disappointment when showing Mr. A. Ferguson, Stewarton, the very easy mode of impressing these sheets, having previously failed to note particularly the state of the wax when impressing, and being so confident of my success, while he doubted. A trial was made, and with all the pressure I could put on, I failed to make an impression, provoking a hearty laugh from my friend as to my self-confidence. But after all, the reason of my failure was only owing to the coldness of the atmosphere at the time hardening the wax. How I overcame this will be explained in the following instructions.

Although there may be many different methods of making sheets, such as using a belt of oiled cloth, and turned with a spindle, or using glass dippers (the first I used), or wood, perhaps the latter for the amateur will be found to be the best. The first thing to procure is the genuine wax thoroughly cleaned; next obtain a vessel of sufficient size to dip the sheets, so that their length will be of the width of the vessel, which is best to be made on the same principle as a

glue-pot; and better if sufficient wax be had to keep the vessel to the proper fullness without having to fill up with water. Having now the wax melted, it is well that a supply be kept to fill up as the wax is exhausted in the dipping pot. A vessel should next be obtained of sufficient size to admit the dippers, which should be two in number, made of the best yellow pine, perfectly free from any stakes, knots, or rosin-galls, and not more than  $\frac{1}{4}$ -inch thick, tape red off at the point. The vessel must now be filled up with cold water and the dippers steeped therein for some time previous to dipping, and to be plunged in after every dip, to cool the dippers, so that an even surface of wax will adhere to them. Having got all in readiness, as described, the operator must now try his hand at dipping. The dipper must first be taken hold of by both hands, to shake the drip from it; then take hold of it by one hand, and give a sudden plunge and quick withdrawal, until the dipper clears the wax, let it hang for a second or two until the wax stops running, then give a gentle wave of the dipper with its two sheets for the purpose of cooling them. If the wax has been of the proper heat, two perfect sheets will be ready for lifting from the dipper with a common table knife. Lift the top edge of the sheet, then catch with both hands, and draw the sheet from the dipper, which will be found to separate from the wet dipper easily, then lay the sheet on a flat table, turn the other side, and repeat the process. If the sheets are not of a sufficient thickness with one dip, the dipping may be repeated. If the wax cracks or runs very thin, it is a sign the wax is too hot, it may be allowed to cool a little if this is the case. It will, perhaps, be as well to remark that the vessel holding the wax, and the dipper, must be of larger dimensions than the sheet is required, in order to allow of pruning, which may be done in the following manner: lay the sheet upon a flat board, having another piece of wood as a pattern the size the sheet is required, lay this on the top, then with a pocket-knife cut to the size.

The sheets at this stage are now ready for pressing, which may be done in the following manner:—Mix a little soap-suds in a basin, and with a sponge wet the plates; having now your sheet handed to you by an assistant, who has warmed it moderately at the fire, place it between the plates and apply the press, with a turn or two the work is done; now slack and separate the plates, and if they have been well soaped the perfect impressed and straight sheet is easily lifted. I must, however, add that a piece of thin wood must be used above the plates, well fitted, so that the press (a common copying one will do) catches it equally. Such, then, is a brief description of the manufacture of wax-sheets, which any person may carry on, although no doubt difficulties will come in, but perseverance will soon overcome all that, as was the case with—A LANARKSHIRE BEE-KEEPER.

P.S.—I forgot to add that shortly after I had my plates made, Mr. A. Neighbour sent me a pair of German-made ones, which have lasted me ever since, and which enable me to produce sheets equal to the imported ones.

### LOCATING HIVES—THE WOODPECKER— THE CONDENSER—A BEE VEIL, &c.

I have of late adopted the following plan, and should like to know whether you think it effectual for preventing the young queens mistaking their hives on returning from their wedding trips; also for preventing the other bees entering wrong hives. I have square, hexagon, octagon, and round floor-boards, for hives of the same shapes, and I have latterly adopted the uniform plan of painting and varnishing all the floor-boards jet-black (no matter what the colour of the hive may be), as black looks well with any colour, but I have varied the colours of the *alighting-boards* ONLY in every possible manner, some being painted with orange chrome, lemon chrome, ultramarine, emerald green, red lead, vermilion, carmine, white lead, drop black, and so on. Now do you consider this sufficient distinction or not? That is, suppose six circular hives were placed upon six circular boards in a line twelve feet apart, the hives being all bright yellow, the boards being all black, but the alighting-boards being various colours. Now you may say, But why range your hives in rows at all, even at twelve feet apart? My answer is that it is impossible to do otherwise without being compelled to walk over the beds to attend to the bees. I have some straight and some serpentine walks in my garden, but the plan I find most convenient is to place the hive posts twelve feet apart, but only fifteen inches from the box, so that in no case I need step off the walks to manipulate with my hives; again, I only place them on one side of the walk, so that the bees fly away from it and not across it. In Langstroth, page 216 (foot-note), John Mills directs 'the mouths of your colonies to be painted with different colours,' I presume he means the mouths of the hives, but, as bees naturally look down and not up (when alighting), I should think the alighting-boards would be the proper part to colour. Again you may say, Why put all the round hives together, the square ones together, and so on? My reason for doing this is that they may be the more easily operated on, as you would never want to exchange a V hive-bar for a square one, or a square bar-frame for a Stewarton bar, and so forth.

I was much perplexed to know what on earth could have gnawed holes in a new Improved Cottage hive and its wickerwork super cover, which stands perfectly clear of surrounding objects, for although I can imagine a rat or mouse running up a post eighteen inches high, I could hardly give him credit for turning an angle of ninety degrees, which he must do in order to run from the top of the post underneath the floor-board to get at the hive upon it. Your correspondent G. A. K., on page 156 of *Journal*, doubtless solves the mystery. But what is to be done if such depredations are always liable to be committed in well-regulated apiaries? My first operation on coming here was to enclose every portion of the garden with wire-netting, to exclude the rabbits; and if this sort of thing is to obtain, my next will be to cover all my hives with wirework to keep the birds out. In the super cover there is a hole the size of a halfpenny, and at the bottom of it

the edge is pecked away, though it is made of very close and strong wicker-work, covered with eight coats of paint and one of carriage varnish, and is lined with American cloth (also pecked through), with its glazed side to the wicker-work. The hive which is painted and varnished to match cover has been pecked in several places, though but slightly. It is all very fine to talk about shooting the rascally woodpecker, but how about the hive, bees, &c.? Besides woodpeckers are early risers, which I am not. Fortunately none of the other hives have been touched, but they soon may be. To-morrow I shall hang a cork stuck with feathers over the unfortunate hive, though experience teaches me that scarecrows of any kind are but nine-days' wonders to birds, and I firmly believe if a revolving steam-power automaton sportsman were fixed in the middle of my garden, the birds, soon discovering that he could not aim straight, would stuff wool in their ears and go about their maraudery as usual.

The whole of my bees were out very strong on Tuesday, owing, I think, to my having disturbed them by drawing a hooked wire over the floor-boards to get out the dead bees; there were few in any (in many none), except in my V hive, out of which I should think I poked a pint at least; and it was fortunate I did, for had I not, not a bee could have got out.

In every hive I have adopted what I call the condensing-pan-and-tumbler principle, and when sum-

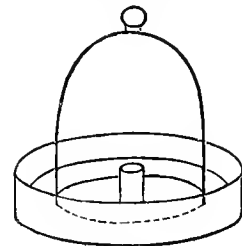

CONDENSER.

mer comes I will give you the result. I hope it will answer, as I hate the thought of the quilt system. Firstly, because it does not look well; secondly, because I detest anything that absorbs or harbours impurities, and that, in short, looks haggling and messy, preferring such materials as glass, porcelain, ivory, vulcanite, metal, and the like, which instantly become clean on the application of hot water. If it would answer, nothing would beat (for purity and non-absorptiveness) glass pans to match (in shape) my zinc ones, with small bell-glasses to fit them loosely, over which of course the super cover would be placed.

One thing I must mention is that during this late deep snow (cleven inches where it had not drifted), which lasted a fortnight, my V hive was the only one that never required touching, for there was not a trace of snow anywhere about it, except on the top of its super cover, and when that melted it fell clear of both the hive and alighting-board. And I may here remark that I attribute the high death-rate in that hive to two causes; firstly, it being a very poor swarm that I put into it, I fed it *ad lib.*, to fill it

with comb, which I succeeded in doing, though I gave the bees at least seventy pounds of *sugar*, and at the end of the season I put a skepful of smoked bees in with them; and I have *no faith* in *smoked* bees; I believe they are perfectly worthless, at any rate I have no intention of smoking any more.

I quite agree with your excellent observations on hive shapes, that after all the form of hive can matter little or none to the bees, therefore the best hive is that which looks handsome, gives the beekeeper the greatest facility for operating on his bees and honey, effectually defends the bees against sudden atmospheric changes, and may be made at a moderate cost. If this be so, Pope's words slightly altered would apply to bees as well as bipeds:

'For forms of hives let apiarians fight,  
Those can't be wrong wherein the bees keep right.'

When I first commenced bee-keeping I had a dress made of black leno, with black calico sleeves, as described by Taylor, page 176, with Neighbour's india-rubber gloves; but I soon found this such a fearful nuisance, involving as it did the necessity of some one's helping me on and off with it, besides almost suffocating me, that I started a veil of silk gossamer, 2 feet 8 in. long by 4 feet 6 in. in circumference, with elastic band for hat, as shown in your *Journal*; this was far better than the first abomination, but I was always in fear of the bees transfixing it to the end of my nose or tips of my ears in windy weather, so I discarded this also, and made a hat of fine wire-cloth, as described by Langstroth, on page 316, plate xi., fig. 25, but I found it heavy, and that in the sun it greatly dazzled my eyes and impeded my vision (especially after wearing it a short time). So I thought I'd start a new patent machine of my own, of which, as I find it to answer admirably, I will give you the particulars.

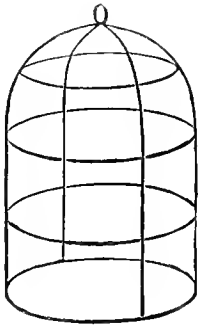

CAGE TO BE COVERED WITH NET.

Take ten yards of half-inch black sarsnet ribbon, two pieces of crinoline wire, each 3 feet long and  $\frac{3}{16}$ ths wide, four pieces of ditto, each 2 feet 9 inches long and  $\frac{1}{8}$ th inch wide, and one yard of black Brussels net. Cost, ribbon 6*d.*, net 1*s.* 8*d.*, crinoline wire (stole it). Total cost 2*s.* 2*d.* Form each of the four 2 feet 9 in. pieces of wire into a hoop by means of the small metal clasps taken off the crinoline. Mark each hoop into four equal sections, then with a bit of fine brass wire fix the two 3-foot wires together in their centres in the form of cross and bend down the four ends, to the points

of the bottom hoop, as indicated, secure each with a metal crinoline clip; then fix a second hoop four inches from the bottom (or first hoop); then a third hoop eight inches from the bottom hoop; and lastly a fourth hoop one foot from the bottom hoop, securing each hoop at the four points marked to the upright wires with the little clasps. You will then have a frame resembling in shape an ordinary glass shade, 2 feet 8 inches in circumference and 1 foot 3 inches in height, which, after being carefully wrapped all over with the black ribbon, must be tightly covered with the net, the bottom hoop again bound with velvet, to which must be attached a full flounce of the black net, 2 yards in circumference and 1 foot 6 inches deep; a small button or tassel at top completes the affair. As regards free respiration there is no perceptible difference between Langstroth's protector and my own. During rain, of course, his is preferable on account of the wet neither injuring the wire netting or calico. The advantages I claim for mine over his are that mine scarcely interferes with the vision at all, whereas his does so most materially when there is any sun or snow. Mine weighs  $3\frac{1}{2}$  ounces avoirdupois, his weighs  $20\frac{3}{4}$  ounces avoirdupois, and, finally, mine costs 2*s.* 2*d.* and his 2*s.* 1*d.* I should here mention that I carefully worked the wire-cloth at top into a dome, in shape exactly like the top of a glass shade, instead of using sole leather, as he recommends, and which, had I done it, must have increased the weight and clumsiness of Langstroth's greatly, but, as you now see, there is a difference of weight between his and my protector of seventeen ounces.

P.S.—There is just one other advantage in the crinoline protector, if accidentally struck it instantly resumes its original form, but if the wire one is struck it is put out of shape; it is, however, decidedly preferable in wet weather, and as the two can be made for less than a crown, all bee-masters and keepers had better provide themselves with one of each.—WESTBROOK, Jan. 9th, 1875.

### TRIGONA, OR BRAZILIAN STINGLES HONEY-BEES.

There are about seventy species of Trigonas, found principally in South America; there are also as many in Mexico, and they are found in India, Africa, Australia, and the islands of the Eastern Archipelago, &c. A few of these are black, but the majority are of different shades of yellow or reddish-brown. The Trigonas vary in length from about two to four lines. Their wings are longer than the abdomen; the stigma is distinct, with its inferior margin rounded; the abdomen is short, somewhat triangular, compressed beneath, and forming a carina or sharp edge down the centre; the mandibles are serrated, denticulate, or sometimes edentate.

The form of the palpi differs considerably in the various species; in some, the two elongate basal joints of the labial palpi are narrow, and only slightly widened at their base; others are more widened at the base, and have also a broad, thin, semi-transparent, flattened margin. The tongue also

varies greatly in its relative proportion to the labial palpi, being longer or shorter in different species.

The arrangement of their brood-cells resembles those of wasps, horizontal combs and vertical cells at one side of the comb only. These are about one and a half inches diameter, and used for brood only. The honey-pots in the nest exhibited are from three-eighths to half-an-inch diameter and are coated with rosin, with an opening at the entrance large enough, so that only one bee can pass through at a time; these pots are filled with pollen and honey. Some of the *Trigona* construct their nest in the hollow trunks of trees, others in banks on the ground; some suspend their nests from the branches of trees, whilst one species constructs its nest of clay, it being of a large size. Mr. Stretch found a nest of *Trigona* at Panama, several feet in length, in the hollow of a tree, containing thousands of individuals. Mr. Peckolt, of Cantagallo, in Brazil, kept four species of *Trigona* in his garden, to study their habits. He had one hive of *Trigona mosquito*, one of *Trigona ruficus*, one of *Trigona manducata*, and one of *Trigona Uruca*. He says he has observed *Trigona ruficus* swarm, just like the European honey-bees, about the end of March, when the cold time begins, whilst in April, May, June, and July, they appear to increase very scantily, I suppose in order not to raise too many useless feeders. Their mode of life appears almost identical with those of *Apis mellifica*. I have found only one queen in a hive.

The quality of the honey varies considerably in the different species of *Trigona*; of one it is said to be very good, that of another tolerably so, of another it is poor and rather tasteless, whilst that of some is said to be unpalatable. This may be accounted for by the different species of the genus *Trigona* visiting different flowers caused by the different relative length of their tongue, adapted for reaching the nectaries of the particular flowers which they usually frequent. Those species of *Trigona* that have their tongue short frequent flowers having open corollas, whilst others, furnished with an elongated tongue, extract their food from elongated tubular flowers.

Although the *Trigonas* cannot sting, an apiarian would be compelled to beat a hasty retreat if he should attempt to meddle with their nest. For such an offence the little fellows will make a terrible attack on any person, and in a second the hair and clothes of the attacking party are filled, and with an offensive squeaking they will cut off his hair. It is therefore impossible to succeed in any way with such a species, and the natives can only get possession of a taste of the honey which is found in their nests, by threatening them with death and destruction by building a large straw fire. All of these stingless bees, and also the better qualities which do not make an attack on the hair, and which are in some respects similar to ours, only resemble ours in outward appearance, but in nature have nothing in common with the *Apis mellifica*.

The wax-like material of the comb is rosin, which is gathered from trees and leaves, and according to its kind is more or less greasy, black, grey, and yellow. The hind part of their body, in consequence of the missing organism for the secretion of wax, is

comparatively too small, therefore this wax is not of animal origin, as is the case with ours, but a vegetable substance. For this reason these bees need less honey for their nourishment; they do not live together in large families, and have small houses and little work.—WILLIAM CARR, *Newton Heath, near Manchester.*

## HIVES AND BEES.

Upon looking over the *Journal* I see a letter from 'J. W., Rochdale,' after giving some notes on his visit into Devonshire, and his reading the account of the great Show at the Crystal Palace, he says, some one was rather hard upon Mr. Pettigrew, condemning the Cottage hive. Now I for one can say much in favour of the straw hive, Pettigrew's 18-inch, and I am quite sure anyone keeping bees for profit will gain more by them than any other kind; but at the same time I do not despise all other kinds of hives. My next in favour is Woodbury's 10-bar straw hive. I keep my bees in Woodbury, Nutt's, Huber; also in the Woodbury Glass Observatory; also the globular-shaped glass hive—the one that took the first prize at the Great International Show at Manchester in 1873. At the time it was thought it would be useless only for exhibition purposes: I am glad to say it did well, after throwing out two swarms, it is well provisioned, and well stocked with bees. I may just say that there are three glasses, one upon another, with  $\frac{1}{4}$ -inch cavity between each glass. I keep the above-named hives for ornament, but never take the honey only in supers.

'J. W.' goes on to say he has done well at shows, but they don't get good judges. In that he is not far from the mark if he is alluding to exhibitions in the north of England. He says he never had a good judge but once; that was Mr. Tegetmeier. So far so good. I can also tell him that at one of the shows at which I entered my bees, but did not take them owing to it being a wet day, but went myself; when upon the ground one of the judges of the bees asked me if I had brought my bees. I said, 'No.' He then said, 'If you had you would not have had a prize.' 'Oh, indeed, then I am glad I have not brought them.' That Society will never see me there again.

'J. W.' then goes on to say, 'Mr. Pettigrew has been trying his hand with an Extractor.' So he has, and I was present, and tried my hand too (and tried it years ago with one I have—an American make), and it was a great failure as far as we were concerned. It would sting out the clover honey, but would not stir the heather honey; but the combs were of no use after we had done with them; how they might have been if they had been in bar-frames is another thing; but I have poor faith in tender combs in any form.

'J. W.' goes on to say, 'If the combs are old, and honey stiff, it will not answer.' So say I. But if the combs are old, and the honey clover-honey, it will come out much cleaner than new comb. He also says he has tried one comb very tender, and it answers very well. If 'J. W.' will allow me to take a lesson from him next season I shall be very glad, and will avail myself of the many invitations he has given me to call upon him at Rochdale.

Now that there is so much controversy about the different kind of hives, I would suggest that a public trial be made next season:—1st. Hives of different make. 2nd. Five swarms each Ligurian and black bees. 3rd. Five swarms hybrids and black bees. That will be the best test which hives are the best, and which bees are the best; the honey to be taken the first or second week in August.—SOUTH LANCASHIRE BEE-KEEPER.

[We could not choose a more agreeable task than organising a trial between the straw skep and the moveable comb hive would impose. The difficulty we see is in arranging preliminaries and determining how a fair trial shall be conducted. We hope brother bee-masters will aid in endeavouring to bring about this wished-for consummation.—ED.]

#### WILAT NOT TO DO.

The article with the above heading by B. M. B. in the number for this month of the *British Bee Journal* is a very interesting one to apiculturists. The objections made by the writer of that article, supported by the views of the Editor, I consider correct as far as they go, but it appears to me that the great injury likely to result from the method of making swarms as suggested in *Bee-keeping for the Many* may very easily be prevented, and the plan be made most useful.

On first reading the article in the manual referred to the same dangers in its accomplishment suggested themselves to me, but after well turning it over in my mind, I came to the conclusion that one or two frames of comb containing both worker and drone brood recently laid should be transferred from the Ligurian to the empty new hives; that the rest of the hive should be fitted up with frames filled with empty comb, containing a sufficient amount of empty drone comb, or the outer frame on each side of the hive might be without comb or might be supplied with wax guide-sheets only. In this way I should presume that we should prevent the bees making all drone-cells. Then to meet the difficulty of the young queen being impregnated by the black drones, which would be almost certain to go with the black workers from the old hive about to be robbed, I should suggest that the night before the operation a drone-trap should be securely fixed to the entrance of the old hive, so as to prevent any drones flying from it. I should like to know what our obliging Editor says to this plan. If it can be made available and sure, a great deal of time and labour will be saved as compared with driving.

At the same time I cannot see how the suggester can by any means expect to keep his young Ligurian queens pure, when his solitary Ligurian hive is in company with and surrounded by hives of black bees, for in proportion to the number of the latter to the former so must be the proportion of cross impregnation.

Two years ago the young queens from my first Ligurian hive were all, except one, cross impregnated with my black drones, though the two kinds were a full quarter of a mile apart.

Next spring I intend to test the making swarms on the above plan, for I have two very strong hives

in the old straw hives, of black bees, a full mile from my apiary, which I keep on purpose to supply workers for my young Ligurian queens, when I require swarms. When the empty new hive has stood a day in the place of the old black hive, I bring it away to my apiary with the black bees in it.

I am glad to say my hives after the frost are hearty and strong. Those topped with carpet and quilts are quite dry and comfortable, but one on which I kept a wooden top is damp and wet, and the outer combs mouldy. I have taken the mouldy frames out, put fresh frames and combs in their places, and topped the hive with carpets and a quilt; some of the quilts are filled with well-dried ash-wood sawdust and some with fine pine shavings. Both kinds seem to do well, but I think the sawdust seems to answer best.—SOLWAY, Jan. 6, 1874.

[The method suggested above would be an improvement if it were always practicable, but as few bee-keepers have the necessary supply of empty combs, and there would be an immense loss of time in each newly-formed stock being obliged to raise its own queen, we cannot recommend it. Besides, as the season advanced, and honey became abundant, the bees in the stock hive would replace abstracted combs with store comb, and so become depreciated, and the method would fail. The original plan suggests the possession of a number of common black stocks; and the best possible way of multiplying Ligurians in such a case would be to make an artificial swarm from one of them by driving, and then to unite the queen of the Ligurian stock to the bees remaining in the driven hive. Six days afterwards, the Ligurian stock should be examined, the number of queen-cells noted, and as many black stocks, *less one*, should then be swarmed artificially. Two days afterwards, when the bees left in the black stocks have missed their queens, they should each be presented with a queen-cell from the Ligurian stock, which they will gladly accept, and in about seven days the whole of them will have hatched out, and the old black stocks will thus be headed with young Ligurian queens. Whilst this is going on, the black drones may be captured, if any exist, that the chances of pure impregnation may be increased; but the chances are very much against young queens mating with blood relations, if other drones can be found. Please to read Reply to Query by 'Tenax,' p. 177.—ED.]

#### BEEES IN AN OLD GRANARY.

The account of the removal of comb and bees from the granary, communicated by J. A. Abbott, jun., of Hanwell, induces me to forward my experience in a very similar operation in November last. The above 'expert' and the writer appear to have been equally successful. For several years in succession, swarms have taken possession of a portion of the space between the outer and inner boarding of an old granary in the grounds of Portlemouth Rectory, near Salcombe, Devon; and, on two previous occasions we have dislodged them, the boards being replaced without any care in removing adhering portions of comb. This summer two fine swarms located themselves in different parts of the building. The first swarm operated upon yielded a quantity of fine honey of 40 lbs. weight, and a moderate lot of bees; but the other colony gave a fine harvest of between 50 and 60 lbs. of honey-comb, the bees being very numerous. The combs occupied the space between two uprights, and were attached



to a cross-piece, the depth of the combs being 3 ft. 6 in., and the width 1 ft. 6 in., the space between the boards being occupied by five fine combs. We were allowed to saw through, and remove, several of the boards, so as to expose the whole of the combs, consequently there was no difficulty in extracting them, without any waste of honey. Up to the 9th of November there was a quantity of sealed brood. Had this old building been in my own premises I should have made a fine observatory hive, by cutting away the thin inner boards, and letting in a sheet of glass. As almost a matter of certainty, year after year, swarms are expected to take possession of the same spot as was occupied a previous season, the bits of attached comb, being purposely allowed to remain to tempt them. A few years since we removed bees and comb from the roof of an old farm-house in our neighbourhood, presenting the owner (to his surprise), with two bucketsful of comb (probably 75 or 80 lbs. weight), appropriating the bees, and a quantity of sealed brood ourselves.—*GEORGE FOX, Kingsbridge, Devon.*

### THE QUEEN PIPER.

While sweltering under the heat of the noonday sun driving the ascending myriads of an unswarmed stock, or carefully searching among the clustering masses on the frames of my many-storied Octagon colonies, in quest of an audience with royalty, it has often occurred to me the feasibility of inventing a little instrument to imitate so closely the plaintive call-note of the queenly 'Peep, peep,' as would send a thrill through the royal bosom, causing her to respond and hasten with alacrity to the spot from whence the sound proceeded, be it bung-hole or entrance. The bee-master would thus possess a spell as potent to charm as that portrayed by our national bard of the feelings of his 'Heart's Queen,' in the words of the song,—

'O whistle, and I'll come to you, my lad,  
Tho' father and mither and a' should gae mad.'

I throw out the suggestion in the hope some such little contrivance may appear at the next Crystal Palace Show, and win a special prize; and I hereby give fair warning I shall not compete in the class, but hope the winner may as handsomely acknowledge as did the Rev. George Raynor in the matter of the queen-cage, that the Queen Piper was the 'original idea' of—*A RENFREWSHIRE BEEKEEPER.*

There is much said about bees cutting or making centre passages. It is found that in some hives there are many such passages, in others but few. Many are at a loss to understand this. My opinion is, that all such passages are made by the bees in their attempts to remove the larvæ of the moth. Hence those hives which are the most affected have the most centre passages.—*J. H. THOMAS.*

Among all the creatures which our bountiful God hath made for the use and service of man, in the respect of great profit with small cost, of their ubiquity, or being found in all countries, and of their continual labour and comely order, the bees are most to be admired.—*BUTLER.*

## Foreign Intelligence.

### FROM THE 'AMERICAN BEE JOURNAL.'

#### LATEST OPINIONS ON 'THE QUILT.'

*Extracts, 'Notes and Queries' (Editorial Reply), Nov. 1874, p. 261.*—'Send to . . . Cincinnati for a mat as a sample. . . . We use quilts instead of mats, but dare say the latter are best. Put on quilts or mats at once.' (N.B. These mats are of sewn straw.—*Ed. of B. B. J.*)

*Second reply, Nov. 1874, p. 264.*—'Winter none but strong colonies . . . Plenty of bees with enough honey . . . Give space between each comb for air to pass at top, putting on quilts over the spaces; nearly close the entrance.'

*'Seasonable Hints,' Nov. 1874, p. 265.*—'Some upward ventilation is necessary; but if quilts are placed over the frames enough air is given at the top, and yet there is no draught of air through the hive.'

*Extract, Dec. 1874, p. 270, 'Packing Bees for Winter.'*—'. . . Put on quilt, mat, carpet, or anything woollen, to keep in the bees. . . . We manufacture a straw mat as recommended in (Novice's) *Gleanings*. We put on next to the bees a woollen blanket and the mat on top. . . . Brother Towmley wintered fifty swarms last winter in this way to perfection; he did not use the mats, but woollen and cotton cloths.—*J. BUTLER, Mich.*

*Extract, Dec. 1874, p. 288, from a notice of 'The Death of Dr. Dallas,'* (two years President of the Kansas State Association) who had tried many modes of wintering. He (Dr. Dallas) 'placed a quilt on the top of the frames, filling in with hay or straw on the top of it and under the cap . . . By this plan he claimed that his success was perfect, as his colonies were all vigorous and strong in numbers in the spring, having no signs of dysentery and no mouldy combs.—*M. A. O'NEILL, Kansas.*

*Extract, Jan. 1875, p. 7 (Editor's reply to query).*—'We would keep the hive as tight and close as possible, with quilt, carpet, or mats on the top of the frames.'

*A second reply, p. 8.*—'We are inclined to think that when the quilts are on they require less ventilation than we supposed formerly.'

*A third reply, p. 8.*—'Close the entrance except a passage for a bee or two at a time. . . . Then with the quilts on there will be no draught.'

*Extract, Jan. 1875, p. 18, 'Failures in Wintering Bees: the Proposed Remedies.'*—'The blankets and mats appear to be good because they are non-conductors, and not because they ventilate the hive, or absorb the moisture.' (p. 19.) 'Use as many blankets and other non-conductors as you please, they are generally very useful, and strong swarms can stand a good deal of ventilation.'

*Extract, p. 20, 'Hives for the South.'*—'Keep the frames covered with a "honey quilt" made out of gunny bagging.'—*J. P. H. BROWN, Augusta, Georgia.*

### FRANCE.

The French Central Bee Association intends (finances permitting) establishing this year a bee-station, to which would be attached an experimental apiary and an apicultural museum.

Various local apicultural meetings to take place during the year at several Departments, at fixed dates, are already determined upon.

In last month's *Apiculteur* appears a letter from Mous. Gaurichon, putting forth his recent discoveries in connexion with the conveyance of queen's eggs by the workers.

### ITALY.

A bill has been drawn up and approved at the second Congress of Italian Bee-keepers, held at Florence, the object of which is to place bee-culture under the protection of the civil law, on the same footing as her sister sciences.

## Queries and Replies.

QUERY No. 115.—I have three stocks of black bees which are respectively contained in three different kinds of hive; the first is a large stock in a large flat-topped straw skep, about twenty inches in diameter; the second is in a wooden box-hive, something of the pattern of 'Edwards' American bee-boxes, and the third is in an old Woodbury bar-frame hive. Now I am thinking of making a lot of bar-frame hives, of the pattern you give in the January number of the *Bee Journal* for 1874, only I shall make the frames flush with the top, to work with quilts, unless there is any better hive out since; and as I intend going in for half a dozen, I do not want them too expensive, as expensive furniture and the little *et-ceteras* make bee-keeping anything but profitable, and that I believe is the reason so many have given up bee-keeping in disgust. Now, Mr. Editor, to the subject, will you please inform me how is my best means of procedure to transfer the bees from the old hives into the new ones? as you see, they are not all the same size and shape. I also am anxious to Ligurianise them, how shall I manage that? and when is the best time? Would you recommend me to commence feeding the bees? I think they have a large quantity of honey in their hives, as they are very heavy, weighing, I dare say, over forty pounds each. Any information on the subject will be thankfully received by—TEXAS, *Ilfracombe, Jan. 15, 1875.*

REPLY to No. 115.—We quite agree with your remarks on expensive hives and their *et-ceteras*, and never use or recommend them. Individually we wish every one would make his own hives, and in proof of our sincerity have given ample directions by which any one with a very little ingenuity may do so. The difference in the sizes of your present hives is of little consequence in transferring, and does not increase the difficulty in any degree, since in the most ordinary operation of the kind two combs are seldom found of the same size or shape, and it very rarely happens that any one comb will exactly fit the frame it is intended for. In transferring in spring it is not necessary to fill all the frames with combs, nor is it necessary to absolutely *fill* any one of them; the main thing to do on the first day is to take care that all the brood-combs are safely fixed within the frames and touching them as much as possible, so that the attachments may be more securely made, for wherever a comb touches a frame the bees will add wax and fasten it to the frame. Another important feature is the keeping the brood-combs in their natural positions as regards each other, so that *one cluster* of bees may cover and take care of them. In some instances amateurs spread the patches of brood and thus spread likewise the bees in the hive and render double the number of nurses necessary to keep the brood warm (often indeed an impossibility), which is very bad policy. The method of 'transferring' is described in Vol. I., p. 25, or may be gathered from our description of Mr. Cheshire's Transferring-board, Vol. II., p. 111.

LIGURIANISING may be done at any time when it is proper to operate on bees and the necessary means are at hand, and in the present case it might safely be included in the transferring operations. The method, whether by the introduction of a queen to each stock or by one queen only, and subsequently by queen-cells raised on her brood, must be at your

option. In the former case the black queens must be removed, and after the combs have been tied into the frames, the admirable plan adopted by the Rev. George Raynor, and described by him on page 119 of the *Journal* for November last, or any of the many methods elsewhere described, may be proceeded with. If by one queen only, then only one stock should be transferred, and the queen united as above directed; and six days after her liberation, when the combs are well stored with eggs, a second should be similarly treated, and the queen of No. 1 removed and united to it. A further period of six days should again be allowed to elapse, when the third stock should be transferred; and two days afterwards one or two sealed queen-cells should be cut out of No. 1 and spliced into one of the central combs of No. 3, and left to hatch out. If it should happen that only one queen-cell has been raised in No. 1 (which is a bare possibility), then the *queen* must be taken from No. 2 and given to No. 3, and the bees of No. 2 left to raise a queen for themselves. There is, however, little doubt but that No. 1, being a strong stock, will raise quite sufficient queen-cells for your purpose, and probably several to spare, so that, if in fitting condition and it is desired, an artificial swarm might be made out of No. 2, which would be headed by the imported Ligurian queen, and this being done when the 'transfer' of No. 3 is effected, the old stock No. 2 could be furnished with queen-cells at the same time, and in the same way, that No. 3 is so treated.

The raising of young queens by these means is a particularly easy matter, but their impregnation is at present not under control. If there should be Ligurian drones in the neighbourhood the chances are perhaps equal that the impregnation will be pure; but if not, the worker progeny of the young queen will be what are called 'hybrids,' but the *drone* progeny, according to the theory of Dzierzon (which we do not entirely agree with), will be pure and unaffected by their mother's black husband, and on a repetition of the operations, always using queen-cells from the progeny of the pure queen, will probably be more successful.

FEEDING.—There will be no occasion to disturb strong, heavy stocks until the middle of this month, when, if it be possible to unseal some of the honey-cells every day and cause the honey to leak, considerable excitement will ensue and probably breeding will be begun: but *feeding*, when stocks are already full, should be cautiously proceeded with, or the cells will become rather blocked and breeding hindered. In such cases thin syrup, very sparingly supplied through one small pin-hole on vulcanite or zinc, will be ample, but the supply ought to be continuous. What is wanted is to induce the bees to consume their old store of pollen and honey in breeding *young bees*, so that there may be room in the combs and plenty of young bees to go to work when the flowers and blossoms make their appearance.—ED.

QUERY, No. 116.—What is the best plan of moving some seven hives, consisting of three Woodburys, one Collateral, one Marriott's Observatory, and two ordinary straw hives (sixteen inches in diameter)? They will be required to be transferred, if possible, from a garden some thirty miles from London, on the north-east side

of the Thames, to a garden some thirty miles from town, on the south-east side of the Thames?—BE-REAVED, Jan. 16, 1875.

REPLY TO No. 116.—If the *route* were given, so that one might judge of the means of conveyance likely to be used, it would be far easier to give directions for the bees' safe transport. By road-waggon or carriers' cart arrangements could be made for slinging the hives, by which much jolting would be prevented, but if given into the hands of railway servants, too much care cannot be taken to guard them against the effects of rough usage. As a rule the upper part of the hive is the heavier, and where the greatest weight is in the comb there it will be found that the bees have built it most firmly against the top and sides of the hive or frames. It must not be forgotten that the combs in hives are *suspended*, and having their heaviest parts at the top it is highly dangerous to transport them in that position, because a very little jolting will sometimes cause a comb to fall, which, being top-heavy, will lean against and break others, so that there will be, if the jolting continue, very speedily a general collapse. To obviate this danger as far as possible, it is usual to carry hives in an inverted position, the floor-boards being removed and substituted by covers made of perforated zinc or strained canvass, nailed or tied over them, to prevent the egress of the bees and at the same time afford them an abundance of air and ventilation. The combs in the Woodbury hives may be afforded additional security, if the weather will permit of their being handled, as laths might be tightly sprung into the frames under their bottom edges, the laths being kept *up* in their places by means of wedges of cork thrust between them and the bottom rails of the frames. The combs in the box-hive may be supported in a somewhat similar way, but the laths would have to be put in whilst the hive was inverted, and fastened at their ends by small nails driven into the hive itself. The skeps, if not furnished with sticks already, may have one or two thrust through the hive and cross-wise through the combs. Such sticks should be about half an inch in diameter, quite straight and smooth and of an even size; one end should be sharpened to a bayonet point by three long cuts, to leave three sharp edges on its side, so that when being thrust steadily through the combs, turning it round gently will *bore holes* in them of sufficient size to admit the full-sized stick. If tapering sticks be used the probability is that the combs will be pushed together to one side of the hive and many bees crushed and destroyed. The Marriott Observatory hive is, we presume, of glass, somewhat like a flat-topped glass-super; and if so it will have cross-sticks or bars in it, and if preserved from jolting will travel safely, provided attention be paid as in the other cases to air and ventilation.

Having arranged the bees, how shall the hives be packed to prevent the effects of a railway journey? If the porters would only be ordinarily careful in taking up and setting down such parcels, bees packed as described would travel well; but, whether from hurry or inattention, it too often happens that they are not careful in either respect, and parcels which should be handled 'WITH CARE' are generally those

which are most ill-used. Some of this may be due to the parcels being of an awkward shape, with no facilities for handling, too heavy to be easily carried, or too cumbersome to be moved without being '*up-ended and made to walk*,' i.e. turned up on end, and by a wobbling movement made to 'gain ground' at every motion, and oh! pity the case of bees so treated. We suggest as an ordinary security that each hive should be placed in a box of double its own depth, the lower half being filled with shavings or some such elastic material, the sides of the hives being also well packed, to prevent shaking, and that each box be clearly labelled and furnished with a rope handle *across the top*, so that it may easily be picked up; if furnished with handles at either end, one only will probably be used, and, one box in each hand, the porter will carry and set them down '*anyhow*.' We have, however, devised a special means, by the use of which damage to bees or supers in transit may almost be considered wilful, so certainly, with care, may all jarring be prevented, and that, too, at a small cost, probably not more than would be incurred in the ordinary mode of box-packing, and it is equally applicable in all cases where boxes are used as outside protection for glass or other fragile ware. It consists in fixing a number of india-rubber air-balls at such points as are likely to receive damage; three, value sixpence, placed under an inverted hive of forty pounds weight, will prevent all jarring in travelling on an ordinary railroad; four would render sixty pounds secure, and the ease with which parcels will ride on these highly elastic cushions is really pleasant to contemplate. Where articles, such as the Observatory hive named, are packed *inside* a box for additional security, some balls might be placed all round and under them, and we think railway porters would be fairly puzzled. Packing hives for the moors would be much facilitated by the use of these elastic aids, which may readily be fixed under a hive by laying a square piece of sacking over each ball and tacking it securely at its corners. With hives to travel as above the balls should be thus fastened to the crown-board before they are inverted.—Ed.

#### NOTICES TO CORRESPONDENTS & INQUIRERS.

IVY HONEY.—That forwarded arrived safely. We never saw honey so much like cheese; it shall be offered to our bees and the result reported on. It is singular that ivy honey is so little understood.

J. SADLER.—Many thanks for the Berkshire hive and supers, they shall be duly illustrated and described in our next.

B. W.—Mr. Edwards's arrangement in lieu of hive dummies consists of two small hinges, fixed one at each end of the hive side against which when opened they lie flat; when folded into the form of an L, the raised flaps press against the outside frame and keep the whole rigid; and it was considered that pressing the flap back against the side of the hive, would give the lateral space required. It seems to have been forgotten that the bees will elongate the cells on the *space* side and so leave no room for the lateral movement desired.

Communications from—A Renfrewshire Bee-keeper; Busy Bee; B. H.; C. C.; with articles on the Lancashire Hive, the Latest Hive, &c., are unavoidably postponed.

THE

# British Bee Journal,

AND BEE-KEEPER'S ADVISER.

[No. 23. VOL. II.]

MARCH, 1875.

[PUBLISHED MONTHLY.]

## Editorial, Notices, &c.

### MARCH.

March is one of the most important months to an apiarian, and should be one of the busiest, as upon the careful management of the bees during its 'many weathers' depends, in a great measure, the probability of a successful autumn result. It must not be inferred from this that good management at the present time will ensure full supers during the ensuing summer; because the honey yield depends on influences over which man has no control, except in so far as the scattering of seeds and the planting of flowering shrubs and trees may tend in that direction. Before a harvest can be reaped there must be a seed-time; and the spade, the plough, and the harrow, must be freely used in their season, or the result will not be satisfactory; and in apiculture, if a good harvest is to be expected, there must be a season of preparation; and that season, we emphatically say, is *the present*. The one great essential to profitable bee-keeping is the having large populations in all the hives when the *honey* season arrives, so that there may be plenty of labourers to collect and store it. If a landed proprietor knew that at certain seasons his domains would be visited by innumerable flocks of wild fowl or game; would he wait until they arrived before making preparations for their capture? Does the fisher wait until the shoals of fish are seen, ere he makes preparation for taking them? Most emphatically, No! Yet there are thousands of bee-keepers in this country who never dream of preparing for the honey season until it has arrived; and while they are then making ready, the opportunity passes away, and is lost. Many people who keep bees for profit talk and write much that is ridiculous on the subject of 'letting bees alone': they argue that 'bees, in a state of nature, never require to be interfered with—never want manipulating; always do well, and seldom die in winter,'—to which we agree: but where bees are kept for profit they are *not* in a state of nature; so the argument is not tenable. Many seem to think that bees fetch honey home for their masters

as a dog hunts and retrieves game; but it is not so: the bees gather honey for the purposes of their own existence, and the perpetuation of their race, *and have no other object in view*, although, in pursuing their avocation, they involuntarily, by the fertilisation of flowers, effect a most important part in the economy of nature. Bees, in their natural condition, store honey and pollen in the proportions necessary for their own special use, and, if '*left alone*,' would be able to fulfil the purposes of their existence without let or hindrance; but the bee-keeper deprives them in the autumn of a large proportion of their honey, and thus destroys the equilibrium of the hive. But for this, they would, in early spring, commence their breeding—at any rate—soon enough for the *purposes of their existence*—and would ere this have largely consumed their store of pollen; but from their honey store having been stolen, they dare not begin to increase in numbers until the opening blossoms afford a prospect of continued supply, and then the increased population is often *too late*, either for swarming, or super purposes. It is remarkable how these facts are borne out by others:—bee-keepers of 'the old smotheration school' usually keep only their *best swarms* through the winter, which swarms, being '*in a state of nature*,'—not having been deprived, or in any way interfered with,—*always do well*. They breed early, swarm early, cast, and furnish some good supers; and, at the end of their second season, are 'murdered for their pains;' and this process finds many defenders. Now, however, our object is to point out the means by which the hives may become populous as the honey and swarming season approaches; and this every bee-keeper may do, provided his stocks are healthy, and sufficiently strong to keep up the heat necessary for the evolution of brood in the hive, and the means are,—gentle, continuous feeding.

GENTLE FEEDING for stimulative purposes, inducing breeding during untoward seasons, and in weak stocks, has been our *hobby* for some years; and so positive did we become as to its efficacy that we dared to dispute the point with all the authorities, from Langstroth downwards, asserting that rapid feeding at any

time was wrong in principle, and ought to be abolished; and *now* so strongly is the slow stimulative process generally insisted on, that the days of rapid feeding under any conditions appear to be numbered.

Every bee-keeper knows at about what time the various honey-yields may be expected in his particular neighbourhood, and we most strongly urge that at least six weeks beforehand, every stock of bees in his apiary should be induced to commence and continue breeding to their utmost capability. Stocks heavy with stores should, if the combs be moveable, be relieved of some of their honey by means of the extractor; but in a fixed-comb hive, where extraction is not possible, some pains should be taken to shave off the seals of some honey-cells every day, until a considerable amount of brood is observed, when an eke should be placed under it, and gentle feeding proceeded with and continued. The effect will be that the bees will not only continue their breeding, but will also commence comb-building, and thus increase their breeding space; and when the blossoms appear, supers should be placed on the top, and if swarming does not take place: weather permitting, they will almost inevitably be filled with early flower honey. Stocks that are weak should have their space contracted, to economise the heat of their cluster, and, after a fortnight's stimulation, should be examined to see if their breeding promises rapid increase; and if not, they should be united, with the usual precautions, and the feeding continued, or they may be aided by exchanging one or more of their empty combs for others filled with sealed brood from stronger stocks which can spare them. We do not *recommend* this latter proceeding in all cases, but sometimes strong stocks may be brought to swarming condition *before* the blossoms appear, in which case they can well afford to lose a comb of brood; otherwise we would strengthen weak stocks by union only, and allow the strong ones to do their very best on the blossoms and flowers. During this period of stimulative feeding, care must be taken that there shall be no draught through the hive: the entrances should be kept narrow to admit of the passage of not more than two bees at a time, and the crowns secured by additional thicknesses of quilt to prevent the waste of heat and vapour, both of which are necessary for the well-being of brood; but when the weather opens and bees are able to go out to work the entrances may be opened and the adapting-boards placed *under* the quilts in readiness for the supers which will shortly be placed upon them. Those who do not care to purchase vulcanite for feeding purposes should punch a row of pin-holes in a strip of plain

zinc of sufficient width to cover the perforated zinc on the feeding-holes in their hives. The holes should be so placed that they can be brought under the feeding-bottle and over the feeding-holes, in any number from one to six or more, although from one to two will generally be sufficient, and it will surprise many to find how rapidly bees can take the food through such a limited number of apertures. For stimulative purposes the food should be thinner than usual, made of four pounds of loaf sugar boiled in two pints of water.

QUEENLESS STOCKS should be united to others having queens, as there is little hope of saving them in useful condition until drones appear; or it may happen that a neighbour may through uniting two weak stocks have a queen to part with, in which case she should be united to them, and they may, if strong, be allowed to remain on their own stand.

FERTILE WORKERS.—Should a queenless stock be troubled with a fertile worker, she should be got rid of with all despatch. The best way is to take the hive on a fine warm day to a distance of 20 or 30 yards from its stand, drive or shake *all* the bees out of it on to a dry part of the garden, then replace the hive on its stand. All the bees, having flown before, will go back to the hive, but the fertile worker, not having flown, will almost inevitably be lost.

HONEY MARKET.—As will be seen from an advertisement, a gentleman at Forest Hill offers to negotiate the sale of honey, and so pave the way to the establishment of a regular agency, as suggested on page 162. We have the fullest reliance on the advertiser's *bona fides*, and hope the attempt will be successful. It is singular, however, what apathy exists amongst those who have honey for sale and 'can't find a market.' There has been an advertisement in Our Want and Sale Column for the past month asking for supers, yet the advertiser has only *heard* of one, of 19 lbs., which he instantly purchased. Can it be that 'every body' supposes 'every body else' will have replied to such an advertisement? or is the want of a honey market a myth?

THE CALEDONIAN BEE ASSOCIATION.—On another page will be found a copy of the prospectus of the newly-formed Caledonian Apiarian and Entomological Society, presumably an offshoot from the Association of British Beekeepers, whose success at the Crystal Palace seems to have electrified the whole bee world. We gladly give space to the full prospectus, since its promoters have evidently profited by the experience gained at the Palace Show, and because some of their ideas may be of service to us Southerners in framing our programme for the Show of 1875. Beside this, such an Association deserves the widest publicity, and in aid of it we cheerfully offer our services.

### THE BERKSHIRE BEEHIVE.

By the kind permission of Mr. Sadler, of Sonning, Berks, we are enabled to place before our readers an illustration of this hive, which, from its inventor's description, has been for some ten years before the public. He says:—

'It is universally acknowledged to be the most useful and interesting hive yet invented, to which the highest testimonials are constantly being received. It combines the advantages of glass with the utility of wood, consisting of store-box and two supers: each super will hold 20 lbs. of honey, and by removing full ones and replacing them empty, unlimited room is given, and swarming prevented.

'The original hive, with bees, as exhibited in 1865 (to which the silver medal was awarded), may still be seen in good working condition, never having swarmed.'

We are quite willing to acknowledge that it is a really useful hive, and a model of excellent workmanship, cheapness, and good taste, but we cannot go all the way with the inventor, and give it the first place amongst bee domiciles,

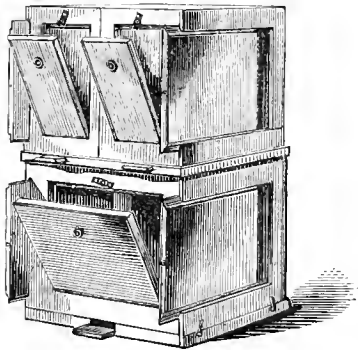

because there are one or two features in it which do not quite come up to our standard. It is a most ingenious composition of wood and glass, and is a great favourite with ladies, so much so indeed as to entitle it to be considered a boudoir hive. It is essentially an indoor hive, and is intended to stand on a table with its plain wooden back against an outer wall, through a hole in which the bees may find a passage to the open air; but in the illustration the floor-board is reversed to show the entrance, which is cut in its upper surface. The stock-box is rather smaller than the ordinary Woodbury hive, and measures  $11\frac{1}{4}$  inches from front to rear,  $11\frac{1}{2}$  inches in width, and  $10\frac{1}{4}$  inches in depth, inside, having a capacity of a little more than 1300 cubic inches. One side of the hive is of plain pine, but the three other sides, *i. e.*, those intended to be exposed to view, are framed and glazed, having three large windows, each measuring  $9\frac{1}{2}$  inches by  $7\frac{1}{2}$  in the clear. Each of these windows is furnished with a shutter of clear pine, those at the sides sliding in grooves, while that in the front is grooved in at the bottom only, and fastens up with a brass button. The

interior of the hive is empty, having no frames or other provision for rendering the combs moveable, and the crown-board is a fixture. These are two of the objectionable points to which allusion is made above; but on our pointing them out to the inventor some months since, he assured us that the hive did so well as it is, that he could not think of making any alteration in it; added to which, if bar-frames were to be introduced into it, it would be no longer the 'Berkshire Hive.' The floor-board is of pine, one inch in thickness, and is neither tongued nor clamped, which we think an omission; as such a floor-board is liable to split, and might cause an unfortunate accident during the hive's removal. The entrance is sunk in the floor-board, and is furnished with a grooved wedge as a plug, which when put into the entrance will permit of ventilation, but will effectually bar the passage of the bees. The crown-board has not the usual central feeding-hole, but has two sets of wooden gratings, each containing three passages of three-sixteenth width only, to keep queen and drones from the supers. These gratings are sunk in the crown-board and are covered with wooden slides, which when in their places are flush with the surface of the floor-board.

The supers are two in number, each having two sides of glass, with shutters fitted as in the stock-hive. They measure  $11\frac{1}{2}$  inches from front to rear and  $5\frac{1}{2}$  inches in width, and they are of, what appears to us, the excessive depth of 10 inches. It is possible, however, that their narrowness may overcome the evil which is generally produced by the use of tall supers, since a body of bees need not hang suspended from the crown of such an one, but could take advantage of the wall as a means of support. The crowns of the supers are ribbed to induce the bees to build crosswise, and are arranged to contain six combs each, making a total of about twenty pounds weight in each super when completed.

### THE LANARKSHIRE HIVE.

In the *Journal* for January we called attention to some of the leading features in this excellent hive, and it now devolves upon us to describe a few of the details which add to its value. One of the most important features is the arrangement for introducing an alien queen, which is somewhat on the principle explained on p. 23, but involves also the method of caging the queen to be dethroned, set forth on p. 119, and at the same time exhibits to her anxious sorrowing subjects the new queen which is to be imposed upon them. The engraving is intended to represent a box with glass let into its sides. It is four inches high, five and three-quarters long on the top, three at the bottom,



and two and a quarter inches wide, having a lid which slides in grooves at either end of the box. The interior is divided lengthways (by a piece of perforated zinc) into two compartments, one of which (the front) is an inch and a quarter wide, and the other (the back) three-quarters of an inch only. The front compartment, which is intended for the reception of the new queen and her courtiers, has a square hole at the bottom, which is covered with a moveable strip of perforated zinc sliding in grooves, by means of which her majesty may be introduced to the personal acquaintance of her new subjects when the proper time arrives. The back compartment is open at the bottom, and is intended as a receptacle for the queen to be dethroned, her unfortunate majesty being confined

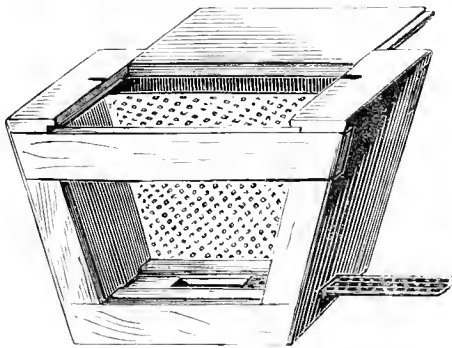

therein in a small zinc or wire cage from which she cannot escape. 'A Lanarkshire Bee-keeper' in his own description says:—'When a queen is to be substituted, place the stranger queen with a few workers in the wide space (front) and the queen to be dethroned in the loose cage on the other side, (to prevent the queens attacking each other through the zinc the side of the loose cage placed next to the zinc partition has stout paper pasted on it). Draw a slide in the stock hive and place the box over the opening, when the bees will immediately come up into the narrow compartment (the back) to attend upon their queen. In a short time the strange queen will have in some degree acquired the odour of the hive; the caged queen may now be removed and the bees will immediately attend upon the stranger whose liberation must be determined by watching the operations of the bees through the glass, and may be effected by gently drawing the zinc slide which covers the hole in the bottom of her compartment.' This method has been in operation for more than twenty years!

The box is also intended to enable the apiarian to witness the operation of queen-raising. Its inventor says, 'When a hive is queenless, cut a piece of comb containing eggs and larvæ, of a size to fit the box (lengthwise), remove the perforated zinc partition (which will give the size

the comb should be) and the bottom slider; fix the comb along the centre of the box, and set it over an aperture made by withdrawing a slide in the crown of the hive, when the bees will immediately commence to raise queens, the progress of which can be interestingly watched by the bee-keeper.'

It has been already mentioned that the false bars of the frames will exactly fit and fall into the notches in the supers; but the number of bars contained in them is only eight, each of one inch width, while the super is seventeen inches wide. This of course leaves a space of more than an inch between each of the false bars which must be covered; but our 'Lanarkshire' friend, wise in his generation, having seen the evil of the 'space above the frames,' has contrived that his shall not furnish his bees with so extravagant a means of waste, and, consequently, the slats which form the crown-board are made to rest closely on the tops of the super bars. Each slat is grooved on both sides, and fitted with slides which, when withdrawn, open exactly between the combs, and so permit of storifying *à la* Stewarton; and the super is furnished with a dividing-board, should the smallness of the honey harvest render the full size unnecessary. The back of the hive has a circular revolving disc of wood, of half thickness, let into it, in which are three three-quarter inch holes, covered with perforated zinc, by means of which ventilation can be easily controlled. The entrance is regulated by two slides, one at either side, by means of which the hive may be closed if required; and the alighting-board is made to slide in grooves beneath the floor-board, so that, in case of robbing, the assailants may not have the benefit of a landing for their forces. Taken altogether the hive is an excellent one, too advanced perhaps for the cottager, but exactly the thing that a skilful amateur would delight in.

#### THE IMPROVED COTTAGE WOOD-BURY HIVE.—HOW TO MAKE IT.

Having in our last given some description of this neat little hive, we now proceed, according to promise, to give directions by which the veriest tyro at carpentering may make one for himself, and having made one may increase the number at pleasure. We would advise all who propose to do this, to cut two patterns of every piece of the work as it is described, so that when one hive has been completed, a set of patterns may remain by which to cut others, to prevent any difficulty arising from incorrect measurement, and to ensure that the hives shall be of uniform size, and the frames, covers, and adapting-boards interchangeable with each



other. As before described, the walls of the hive are double, and except at the corners there is nothing between them but *dead air*, which is acknowledged to be the best non-conductor of heat at present known. Dead, *i.e.*, *still* air being the best material for the walls of hives, it must be manifest that the less there is of the substance with which it (the air) is confined, the more non-conducting will the walls of the hive be, and therefore the Cottage Woodbury is made of boards as thin as is consistent with the strength requisite for the security of the hive and its contents.

But to proceed. Procure a piece of inch board, two feet long and of the ordinary width of nine inches, and cut it into four strips, each of which will be over two inches in width, and these will form the legs of the hive. Take two of them when squared by planing, and lay them flat on a bench or table, parallel to each other and with their outside edges exactly 17 inches from each other; cut a piece of board 17 inches long, 9 inches wide and  $\frac{1}{4}$  inch thick, plane its outside and fasten it securely by bradding to the top ends of the two legs by driving a double row of inch brads diagonally at different angles. Take the other pair of legs, and treat them the same, but don't forget to cut and set aside separate patterns as you go on, marking them, that their position in the hive may be easily recognised. These pairs of legs must now be turned over, and two pieces of board 14 $\frac{1}{2}$  inches long, 9 inches wide and  $\frac{1}{4}$  thick, accurately cut, but unplanned, should be provided and bradded to the legs, as shown in engraving, so that they (the legs) form the means by which double boards are kept exactly an inch asunder. In fixing these latter boards, which are to become the inner skin of the hive, care must be taken that they are put on evenly, *i.e.* that there shall be an equal amount of leg exposed at either end of them; in other words, one and a quarter inches. When these are done, the double *sides* of the hive will be formed, but they will not be dead-air receptacles until the openings at the top and bottom are closed, the top need not be closed at present for reasons which will appear, but the bottom apertures may be filled with strips one inch wide, one-quarter thick and of length sufficient; and in fixing them they should be driven upward an eighth of an inch into the opening and then securely bradded from both sides. While in this state the runners for the floor-board should be put on, these are made of strips of deal about three-quarters inch square and seventeen inches long which are nailed or screwed to the legs about two inches below the boards last fixed, and to ensure the floor-board travelling correctly, when slid backwards or forwards, light pieces of thin deal are bradded to the back of them, between the legs, as shown in engraving,

when the sides of the hive will be ready for the addition of its back and front.

The inner walls of these are of 9 inches width,  $\frac{1}{4}$ -inch thick, and 15 inches long, unplanned; but before they are nailed into their places, it would be well to fix the pieces on their upper and lower sides which are to confine the air when the front and back are completed. For this purpose, three strips of wood an inch wide, a quarter thick, and 15 inches long; and one piece 1 x 1 $\frac{1}{4}$  in., and of the same length, will be required, and should be fixed as follows:—Two of the thin strips, one each at a quarter-inch distance from the top of both front and back, as at D, one ditto at the same distance from the bottom of the back, and the inch-square piece at the *bottom* of the front, as indicated at E, the brads being driven so as to permit of the entrance being cut, as shown, without disturbing *them* or injuring the tools.

The sides of the hive already prepared, as Fig. 1, should now be placed opposite to each other, facing inwards, at a distance of 14 $\frac{1}{2}$  in. from each other (to simplify the matter, it would be as well with the first hive to plant

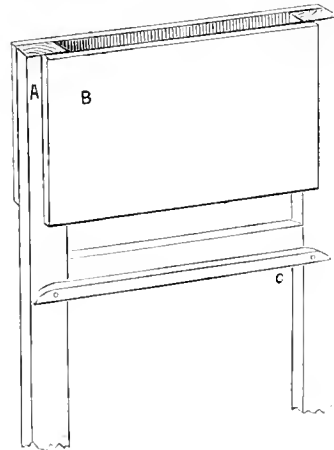

FIG. 1.

their legs in the ground and ram the earth tightly round them), their upper parts and their ends being level, and corresponding, and then to apply the front and back, keeping all their upper parts level, and drive the brads, which should be 1 $\frac{1}{2}$  inches in length through the lines F G diagonally into the legs. As will be seen at a glance, when F is applied to A, D and E will project as far forward as the leg at A, so that they will be in the same plane, and will only require the front outer board to be nailed on to complete the arrangement. Before that is done, it would, however, be better to prevent the possibility of F G becoming warped by the

heat or moisture of the bees when the hive is in use, and for this purpose strips of wood about 6 inches long and  $\frac{3}{4}$  square, are nailed on to the legs, so that they form backings to F and G, and fix them securely. (This may not perhaps be easy to follow while reading, but if put in practice will be found perfectly lucid and workable.)

We have now our stock-hive complete, minus the outer front and back, the tops of the sides, the floor-board, and the frames; and here the hive-maker must determine on the thickness which the top bars of the frames are to be, and whether *our bugbear*, a space above, between them and the adapting-board,

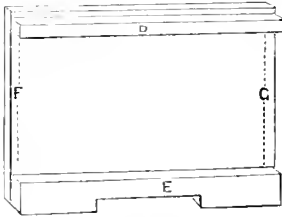

FIG. 2.

shall be permitted. Taking the thickness of the bars to be 5-16ths of an inch, and no space above them, the side-pieces to confine the air in the cheeks of the hive will be 5-16ths also; but if space between the frames and crown-board be permitted, the thickness of the top side-pieces must be increased in the same degree, and the outer front and back of the hive kept up even with them. Both front and back will present a width of  $17\frac{1}{2}$  inches when finished, but in cutting the boards it would be well to allow an extra quarter of an inch in length, so that, when all is nailed together, the corners of the hive may be nicely 'cleaned off' with a smoothing plane.

(To be concluded in our next.)

[We are confident that all the measurements given are exact:—there is no dovetailing, no intricacy, and nothing special required beyond squareness and correct measurement. An amateur may copy out the size and number of the pieces and can get the stuff properly cut at any carpenter's shop, and may go home and make one of the best hives ever put before the public for as many pence as such a one would formerly cost shillings. In our next full instructions will be given for finishing the work, so as to be in plenty of time for the swarming season.—ED.]

*Feeding.*—Some people defer feeding until the bees are absolutely in want. This is very wrong. The assistance should be rendered several weeks before the hive is in a state of positive want, otherwise, when you feed, the bees will be too weak to avail themselves of your bounty.

When bees are in want of honey, or when they have lost their queen, or when besieged on all sides by moth-worms, they will occasionally desert their hives.

## THE CALEDONIAN APIARIAN AND ENTOMOLOGICAL SOCIETY.

AUTUMN EXHIBITION, 8th September, 1875.  
CITY HALL, GLASGOW.

### Patrons.

His Grace the DUKE OF ARGYLL,  
Colonel D. C. R. C. BUCHANAN, of Drumpellier.

### President.

The Honourable the LORD PROVOST OF GLASGOW.

### Vice-President.

ROBERT J. BENNETT, Esq., 59 Gordon Street, Glasgow.

Instituted 28th October, 1874, for the improvement, advancement, and encouragement of bee-culture, entomology, and natural history; for diffusing information amongst its members as to the best means of obtaining the produce of the bees, and to provide a market for the sale thereof.

For awarding prizes to the most meritorious specimens of the productions of the bee; for new inventions calculated to be of real service in the apiary; for essays on bees, their diseases, cause, and cure, and their proper management in health and disease.

For the reading of essays on the best means of destroying or nullifying the ravages of insects injurious to the field or garden, or on the introduction of new and rare kinds of useful insects, &c., &c.

The Society shall, as soon as practicable, form a library of all the standard works treating on entomological subjects, and each member shall be entitled to the perusal of one such book at a time: 14 days being allowed for its perusal.

The Society proposes making arrangements to procure for members, at a small percentage over wholesale prices, every description of bees and bee-furniture; and for a moderate commission the Society will dispose of whatever bees, hives, or honey, any of the members may wish to part with.

The Society will hold quarterly meetings in the months of March, June, September, and December, for the reading of essays, discussions, &c., &c. Office-bearers to be elected annually at the September meeting.

Annual subscription to be 2s. 6d.

Parties willing to become members will please forward at once their names to the secretary or treasurer. Also, a list of bee-keepers in their neighbourhood who are likely to take an interest in the Society.

WILLIAM THOMSON, *Secretary*,

Blantyre.

FRANC. GIBB DOUGALL, *Treasurer*,

167 Canning Street, Calton, Glasgow.

## SCHEDULE OF PRIZES,

OPEN TO ALL COMERS.

CLOVER OR FLOWER HONEY.

(Exclusive of Heather.)

Class A.	Prizes.		
	1st.	2nd.	3rd.
1. For the largest and best display of honey and honey-comb . . . . .	40/	30/	20/
2. For the two best supers above 18 lbs. each . . . . .	30/	20/	10/
3. For the two best supers above 12 lbs. and under 18 lbs. . . . .	20/	10/	5/
4. For the best single super above 20 lbs. . . . .	15/	10/	5/
5. For the best single super above 12 lbs. and under 20 lbs. . . . .	12/6	7/6	3/
6. For the best sample of not less than 10 lbs. of run honey . . . . .	12/6	7/6	5/
7. For the finest super or glass, any size . . . . .	10/	5/	2/6
8. For the best straw super, any size . . . . .	10/	5/	2/6

HEATHER HONEY.

Class B.	Prizes.		
	1st.	2nd.	3rd.
1. For the largest and best display of honey and honey-comb	40/	30/	20/
2. For the two best supers above 18 lbs. each	30/	20/	10/
3. For the best two supers above 12 lbs. and under 18 lbs.	20/	10/	5/
4. For the best single super above 20 lbs.	15/	10/	5/
5. For the best single super above 12 lbs. and under 20 lbs.	12/6	7/6	3/
6. For the best sample of not less than 10 lbs. of run honey	12/6	7/6	5/
7. For the finest super or glass, any size	10/	5/	2/6
8. For the best straw super, any size	10/	5/	2/6

HIVES AND WAX.

Class C.	Prizes.		
1. For the best and most perfect bar-frame hive	10/	2nd & 3rd Cert.	
2. For the cheapest bar-frame hive	10/	"	"
3. For the best and most perfect hive on the storifying principle	10/	"	"
4. For the cheapest hive on the storifying principle	10/	"	"
5. For the cheapest and most efficient honey-extractor	20/	"	"
6. For the best straw hive of any description	5/	"	"
7. For the best sample of wax, not less than 1 lb.	7/6	5/	2/6
8. For the best sample of wax-sheets, not less than six sheets	7/6	5/	2/6

LADIES' PRIZE.

Class D.	
1. For the best executed model or ornament in wax	GOLD RING.

CONFECTIONERS' PRIZE.

Class E.	
1. For the best comfits made from honey	CERTIFICATE.

The Society will hold its exhibition on the same day, and in conjunction with the Glasgow and West of Scotland Horticultural Society, at their September show.

All exhibitors will be subject to the rules and regulations of the Horticultural Society.

All articles intended for exhibition, competition, or sale, must have a card attached distinctly marked with class and number for which they are intended. If for exhibition only, must be so declared, and if for sale only, selling price must be given.

Five per cent commission will be charged on all sales effected at exhibition.

Entries must be made with the secretary not later than the 1st day of September.

Entry money (which must be paid at time of entry), one shilling for each exhibit.

All honey must be the *bona fide* property of the exhibitors, produced from their own apiaries, and to have been gathered by the bees in the natural way within the United Kingdom and all to be the produce of 1875.

No prizes will be awarded where three lots have not been entered for competition, unless specially recommended by the judges.

Judges are empowered to withhold prizes if exhibits are not of a sufficiently meritorious character, or to award prizes for any appliances which may be exhibited, and are calculated to be of real service in the apiary.

Old queens, or such as are becoming superannuated, not unfrequently lay a few drone-eggs in worker-cells, so that drones are occasionally found maturing among worker-brood. When this occurs, a young fertile queen should be substituted for the old ones.

Correspondence.

\* \* \* These columns are open to Subscribers, so that their queries, replies, correspondence, and experiences, may be fully and faithfully recorded; and for the discussion of all theories and systems in Bee-culture, and of the relative merits of all hives and appurtenances, that the truth regarding them may be ascertained. The Editor, therefore, must not be expected to coincide with all the views expressed by the various writers. All Correspondence is addressed to the Editor.

MR. COWAN'S SYSTEM OF WORKING THE BAR AND FRAME HIVE.

It is with much pleasure that I now comply with the request of some of your correspondents to give them my system of working the Woodbury hives, which has enabled me to obtain such large supers of honeycomb. The method is very simple, but is one that requires much attention, which is, however, well repaid by the extra quantity of honey obtained. The hives I use are the 10-frame Woodbury and 13-frame on the Woodbury plan, only longer. In the autumn I transfer the bees into clean hives, and leave them seven to eight frames, and should they be short of food or of bees I add those that I may take from the cottagers in the neighbourhood. I feed with sugar and water of the strength of 2 lbs. of sugar to a pint of water boiled up for a few minutes. They are fed up to weigh about 30 lbs. During the winter they have ample ventilation, the hives being raised about one-eighth of an inch from the floor-board, and the top board is also raised about the same height, so that there is a constant current of air through the hive. While I am on the subject of wintering, I may mention that I have tried several plans. With the above I have always been free from mouldy combs. I have also tried wintering without crown-boards, by merely placing an empty super on the top, and I have done so successfully,—in fact, the hive which produced the largest quantity of honey last year was wintered in this way. Condensers I have tried, but give the preference to crown-boards without them. I am trying the quilts this winter on some of my hives, but must reserve my opinion about them until later on. I generally supply my bees with plenty of food in the autumn, so that they require no further attention until about the end of February, when, if the weather is fine, the bees are all thoroughly roused into activity, and induced to commence and to continue breeding until the honey-gathering season commences, by which time every frame in the hive is filled with brood, and the hives are so strong, that it is easy to make an artificial swarm, and to insure a good supply of honey besides. If the weather is fine about the end of February (or, if cold then, I defer it a little longer), the bees are transferred into clean hives; and in this way I get to know the exact state of the community. Now, suppose it is a 10-frame Woodbury hive, I do not return the whole of the eight frames which the bees had for wintering on, but only from five to six of the centre ones, and contract

the size of hive to the six frames. I then unseal the honey-cells of two of the frames, and allow the honey to run down inside the hive. This thoroughly rouses the bees; and the queen at once begins to lay. The running honey is very soon collected and stored; and in a few days I do the same with a couple more frames, and so on, until all the frames have been unsealed. I find this a great advantage, as much of the honey that has granulated, and which the bees will not touch, is removed by them out of the hive, and gives them increased space. I now commence very gentle feeding, for which purpose I use the very fine strainers found in Loysell's coffee percolators, and allow each hive from a quarter to half a pint of food a-day, of the strength of about three pounds of sugar to one quart of water. When there is sealed brood in three or four of the frames, I add two more—making eight—and serve them in the same manner as the rest, then when there are six with sealed brood, the colony will be sufficiently strong to have the remaining frames added. The same plan is adopted with the 13-frame hive. They must be constantly watched, so as not to allow them to store too much food, which would diminish the space available for egg-laying; and if such is found to be the case, food should be withheld for a day or two, or until they are getting short of it. In this way I keep them going from day to day, watching them carefully, or it might happen that a hive full of bees—and at swarming point—might, if not watched and supplied with requisite food for existence, starve or decamp. So, by the time there is an abundance of honey abroad, the hives are completely filled with bees, and contain brood in every frame in the hive; and then it is that I put on my supers, and discontinue stimulative feeding.

In the place of the crown-board, I place a sheet of ~~5/16~~ <sup>5/16</sup> in ~~the~~ perforated zinc, and supers same size as hive, and 5 inches deep. The supers are provided with bars, which are sawn down the centre, enabling me to fix a strip of impressed wax-sheet without any difficulty. The bees generally take to these supers at once; and in a day or two the crown-board of super is removed, and I place a second super on the top of first, or sometimes I interpose a second super without top-board between the first one and stock-hive. The supers are also provided with traps to enable bees to leave them after they have deposited their load, instead of passing through stock-hive. Now it sometimes happens that for some days the weather is fine, and the bees begin storing a large quantity of honey in the supers (as they have no room in stock-hive), then suddenly the weather changes and cold and wet set in. As soon as this happens I remove supers and watch the bees, and if they require small quantities of food I give it to them, and when the fine weather returns they go on again in the supers when replaced on top. In this way it sometimes takes only a week to fill a 38 lb. or 40 lb. super with some of the best honey that can be obtained in this part of the country. If I have not made myself sufficiently clear I shall be pleased to answer any questions that may be put to me. There is one thing I forgot to mention, and that is, that I discard old queens, and generally select young and prolific egg-layers.—T. W. COWAN, *Horsham, February 22.*

## BEEES IN CASHMIRE.

The name of the beautiful valley which is separated from India by a range of barren mountains, and which is justly called by the Persians 'the unequalled,' is no doubt familiar to most of the readers of the *British Bee Journal*. For,

'Who has not heard of the vale of Cashmere,

With its roses the brightest the earth ever gave;

Its temples, and grottoes, and fountains, as clear

As the love-lighted eyes that hang over the wave?'

In this 'valley of bliss,' with its wilderness of flowers, the bees live, as it may be supposed, a happy life. But what is more, they are allowed to die a natural death; for the abomination of their suffocation, and their consequent wholesale destruction by the hand of man, are there unknown. The skilful management by the Cashmirians of their bees was noticed by Mr. Moorcroft, who visited the country in 1823, at which date bee-farming in that remote region was far more merciful in its practice than it was with us fifty years ago, or than it is even now in many districts of England. Mr. Moorcroft relates that he counted as many as ten hives in one house, and that when the house is building provision is made for the hives in the following manner: 'The cavities that are left in the walls differ in size, but they agree in their general form, each being cylindrical, and extending quite through the wall. This tube is lined by a plastering of clay mortar, about an inch in thickness, and the mortar is worked up with the husk of rice, or with the down of thistles. The dimensions of a hive are on an average about fourteen inches in diameter, and when closed at both ends, about twenty or twenty-two inches in length. The walls of farmhouses and cottages differ in respect to their materials, but are commonly constructed of rough stones or bricks, and of clay or lime mortar, along with a large admixture of wood. The end of the cylinder nearest to the apartment is closed by a round platter of red pottery ware, a little convex in the middle, but the edges are made flush with the wall by a luting of clay mortar; and the other extremity is shut by a similar dish, having a circular hole, about the third of an inch in diameter in its centre.' It seems there is no particular rule for the height of the hives from the ground, as the hives are sometimes confined to the walls of the basement or lower story, at others they are inserted in those of the first floor, and they are frequently seen in both situations in the same house. The manner in which the old swarm is preserved when the honey is taken, is described as follows: 'Having in readiness a wisp of dry rice straw, and a small quantity of burning charcoal in an earthen dish, the master of the house, with a few strokes with the point of a short sickle, disengages the inner plate of the tube, bringing into view the combs suspended from the roof of the hive, and almost wholly covered with bees, none of which, however, offer to resent the aggression, or to enter the room. Having placed the straw on the charcoal, and holding the dish close to the mouth of the hive, he blew the smoke strongly against the combs, but removed the straw the instant it took fire, to prevent it burning

the bees, and quenched the flame before he employed it again. Almost stifled by the smoke, the bees hurried through the outer door with such rapidity, that the hive was cleared of its inhabitants within a few minutes, when the farmer introduced the sickle, cut down the combs nearest to him, which were received into a dish previously slidden underneath them, and left undisturbed about one third of the combs which were almost close to the outer door. He then replaced the inner platter, and brushing off hastily a few bees that clung to the combs, though apparently in a state of stupefaction, threw them out of the house.\* Observing many other bees motionless on the floor of the hive, Mr. Moorcroft asked whether these were dead or only stupefied, and was answered they would recover. He does not, however, seem to have been wholly satisfied that this recovery would take place. But it may be presumed, on the other hand, that the Cashmire bee-master, who evidently knew what he was about, had some grounds for saying what he did, in reply to the traveller's inquiry. 'The whole business,' Mr. Moorcroft adds, 'was completed within ten minutes.' No one was stung, and the bees returned immediately the cavity was freed from smoke. The bee-farmers seemed well acquainted with the existence of the queen-bee, but gave themselves no trouble as to her majesty's doings inside the hive.

The Cashmirians, it appears, take the honey every year, and the end of September or beginning of October is found to be the best season, as with us, for the operation. About one-third of the whole produce is left; and this seems to suffice, as swarms, Mr. Moorcroft says, seldom die, and the Cashmirians substitute no other material as food. An old swarm is said to yield more honey than a young one.

Mr. Moorcroft was informed, that the same community was preserved for ten and even fifteen years, and that it rarely perished except of old age. He justly remarks, that in consequence of the bees being thus literally domiciliated, they acquire a mildness of conduct more decided than those of Europe. To this mildness of conduct thus acquired, the taps of the sickle necessary to disengage the inner plate of the hive, no doubt added, when the inner plate of the hive was removed. The bees, alarmed at this knocking at their door, had no doubt filled themselves with sweets, and though suddenly invaded were in no humour to fight.

With the style of building at present in vogue in England, it would be hard to find walls of sufficient thickness to admit of cylinders of from 20 to 22 inches in length being inserted in them in the way they are placed in the walls of the Cashmire dwellings. But could we so locate our bees, there is no question they would be thus most comfortably protected against the inclemencies of a winter, such as we are at present enjoying —C. C., *North Camp, Aldershot.*

### THE QUILT.

Until yesterday I have not had time to look at our *Bee Journal* for this month, and am sorry to see so able and earnest a worker as Mr. Hunter in the

cause of apiculture attempting to write down the Quilt system, so strongly advocated by you in our monthly. As I see others have given their testimony to its success, I know you will allow me to add my own. I have used boxes with fixed tops for eight years past, by the side of straw hives, and have frequently lost my bees in the boxes from dampness of the combs; and even those that have lived through the winter, their combs have compared most unfavourably with the straw skeps. Having read your remarks from time to time in 'our excellent Journal,' I have now altered all my boxes by making the tops moveable and using bar-frames: this done, I transferred a stock to one of these in the autumn, fed to the required weight, and placed three thicknesses of common floor flannel, with a sheet of blotting-paper to assist in absorbing damp between. After the late frost I removed what I shall now call a quilt, finding the bees quite healthy, the combs almost free from dampness, but the quilt and paper wringing wet\*—these latter I removed at once, placing a similar set instead. Several of my stocks, when the frost left, bore marks of being the worse for their long confinement; but those in the box took their flight and returned thoroughly cleansed, not leaving a mark upon their floor-board. These, I argue, are strong evidences in favour of the quilt system. I am so satisfied with its success that I am having a large supply of boxes made, upon which I intend putting a 'marine store,' as one of your correspondents has facetiously named your quilt. Do not, Mr. Editor, be discouraged nor retaliate in any way. Mr. Hunter on second thoughts will no doubt consider that he was too hasty in condemning a well-tried system because he had found one failure; and that most probably would not have occurred if he had replaced the wet quilt with a dry one. I may add that I shall not lose sight of a plan so reasonably advocated by yourself and so well supported by our friend 'A Warwickshire Bee-keeper.' If printed, please subscribe me—A HAMPSHIRE BEE-KEEPER, *Feb. 9.*

### BLANKETS OR QUILTS.—WINTERING BEES.

I am very sorry to see our clever honorary secretary, Mr. Hunter, condemning quilts being put on to the top of hives in the place of crown-boards, for wintering bees. And I am also sorry to see our clever, practical Editor going to the other extreme with the quilt, and doing away entirely with crown-boards.

Now, perhaps, I was the first in England to adopt blankets, or woollen cloths (not linen, Brussels carpeting), for covering hives made of either wood, straw, or glass, during the winter months; and I can assure Mr. Hunter, and all bee-keepers, from my long experience, that there is nothing equal to these blankets for safely wintering bees, except, perhaps, putting

\* Being anxious to clear up the reason for the wet condition of the quilt, we begged our correspondent to inform us more fully of his mode of applying the quilt, and from his reply, which came too late for publication in this month's *Journal*, it appears that he had kept a crown board on the top of the quilt.

them into an ice-house, or a building made expressly for wintering bees, which is often done in America. The bees being kept all winter in about one temperature, consume only about half the quantity of food ; but I have no experience in wintering bees in these houses.

Since I adopted the blankets I have never lost a stock of bees during the winter, and I try all kinds of hives, wood, straw, and glass, every winter, to prove by actual experience which winter the best.

This winter I left the covers on some wood hives, but raised them at the back with a lucifer match, and when I cleaned the floor-boards in January I found about ten times the number of dead bees on them that there were on those that had only the blanket on.

In November (see *British Bee Journal*, December 1873, p. 118) I remove the covers of my hives, and tie pieces of blankets, one or two folds in thickness, on the hives in place of the covers, and leave them on the hive all the spring; but, in February, I put the cover on the top of the blankets, and make all tight and warm, to encourage breeding ; and, further, to stimulate the bees and queens, I give each hive about half a pound of sugar syrup each week, taken down through just the number of holes under the bottle, so that the half pound just lasts them a week.

I do not approve of a bundle of rags, or, as Mr. Hunter has styled them, 'a pile of marine stores placed on top of the quilt,' as they prevent the damp from escaping; and I can easily imagine it becoming a rotten, mouldy mass, something like I once saw Mr. Pettigrew's hives, which he had covered with rhubarb-leaves, &c. as their only protection; and when I saw them they were one mass of damp decomposition. But with one or two folds of blanket the fresh air plays upon them, and always keeps them dry. I do not like the appearance of carpets or blankets on hives in summer; and they are not only slovenly and unsightly, but injurious, not retaining the heat sufficiently without the crown-board, as they will not lie close to the hives, neither are they as convenient to manipulate with as the covers.—WILLIAM CARR, *Clayton Bridge Apiary, Newton Heath, near Manchester.*

WINTERING.

Taking advantage of a fine sunny day last week, I examined my stocks for the fir t time since Christmas, and found them all in a very satisfactory condition, indeed very much better than I anticipated; there were not a dozen dead bees in the whole. The alighting boards of two of the number were much soiled by exuvia, and in fact the front of the hives as well. Concerning this pair I have a few remarks to make. Each of them comprises the united population of four straw skeps. Last October a neighbouring apiarian—one of the old smotheration school—gave me the offer of eight hives of bees, provided I would fumigate them,—in other words, save him the trouble of 'taking up.' In order to save the lives of the poor bees I at once accepted the offer. I divided them into two lots, about two gallons in each, and put them into a couple of spare boxes,

each furnished with *two* feeding-holes on top. Thinking I could not do better, the lateness of the season considered (October 28), I fed both *ad lib.*, night and day, with a couple of 1½-pint feeding bottles a-piece. The amount of syrup consumed was about 80 lbs. at a cost of 28s. As far as appearances go at present I cannot but consider the outlay in the light of money well invested. The speculation may yet return cent per cent. Fortunately the weather during November was of unusual mildness, and comb-building went on vigorously without a check until both boxes were nearly filled with comb and the syrup sealed. These are now the strongest stocks in my apiary. In former years I have observed that the floor-boards of stocks which have been artificially fed is sure to be soiled by excrement, while not a trace can be seen where the bees feed on honey gathered in the natural manner. Has this any unfavourable influence on the health of the stocks subsequently?

*Apropos* of the 'quilt,' I have this season for the first time discarded condensers altogether, in lieu of which I use pieces of old cloth, matting, and blanket, and I find it much more to the purpose; even the outside combs are, for the first time in my experience, altogether free from mouldiness or damp.—ALFRED RUSBRIDGE, *Sillesham, near Chichester, Feb. 7.*

CROWN BOARDS.

I send you a rough sketch and description of the top arrangement of some hives I had made last summer, and which I have now in use. I find them very convenient in manipulation, and the bees have

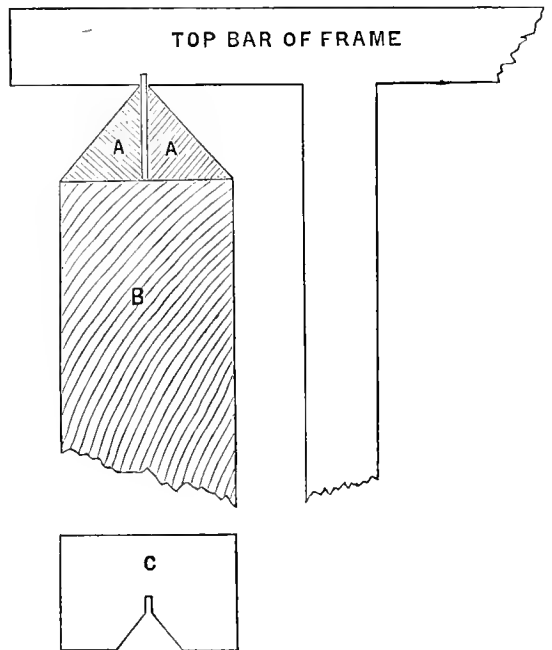

done well in them this winter. I use a crown-board in three or four pieces, with a Cheshire vulcanite plate over the feeding-hole. I have used these plates on the whole of my hives this winter as ventilators,

with the blotting-paper and bell-glass arrangement, as described in a former *Journal*.

I have not had the slightest appearance of damp or mouldiness in any of my hives—even on those with the space over the frames. I have only seen this quilt on one hive this winter, in the apiary of a friend, and that was *very damp*. It was well protected from the weather and arranged in the most approved fashion.

B front and back of hive, with two triangular pieces of hard wood, AA, nailed thereon, with a piece of zinc between one-sixteenth of an inch wider than the thickness of the pieces AA. This zinc projection fits into a saw-cut made in the underside of the top bar of the frames, and prevents any longitudinal movement of them. C is a block of wood half an inch in thickness; one of these at each end between the frames keeps them at a proper distance apart, and on removing them from between three or four of the frames, sufficient space is given, by moving the frames laterally, for taking any one out, and obviates the necessity of a dummy. The double chanifer renders it almost an impossibility to crush a bee in placing the frame on the hive.

J. CLEVERE JONES.

Marley Villas, Market Drayton.

### GLASS HIVES.

I see in your February Number a letter by Mr. J. Torry, giving a description of his hives after the frost, and I see that he has lost his bees out of his glass hive—frozen to death. He does not say if it was simply a glass hive with only one thickness of glass; if so I am not surprised at his loss. I may again say that my glass hives are all of three thicknesses with a cavity between each. I looked at mine for the first time yesterday, February 18th, since I put them down for the winter, which was in November. I took off the quilts and found them all in first-rate order and very strong, with very few dead bees in any of them. I remember my first loss of bees through damp was in an old Nutt's Hive; I wrote to the *Journal of Horticulture* to ask the cause, telling them at the same time that the combs were damp and mouldy; the reply was that that was the evil of wood hives, they not being a non-conductor, and would not do without ventilation in the winter. I took the hint, and ever after used the quilt in form of cotton swans-down, four thicknesses; I also use it to my Pettigrew's straw hives which have a four-inch hole on the top, and I find that it keeps the combs sweet and fresh. With my Glass Exhibition Hive I have a tube with a flange inside, which runs through all three glasses, and before I put the second glass on I put an india-rubber ring, as also on the second and third, to keep it air-tight until the bees make the joints right inside. The tube stands about 3 inches above the outer glass, and I have the top of the tube covered with zinc. I hope to hear of Mr. Torry being more successful another year. Try, try again!—SOUTH LANCASHIRE BEE-KEEPER.

### BUTTONS.

Since sending my last, I have read the article headed '*Our Buttons*' in the *Journal*. Although a novice in bee manipulation, I can readily understand

the distance tacks in bar-frame hives are objectionable and can see your reason for wishing to supply a *button* where others think you are *minus* one. I have no doubt the little contrivance you suggest will answer the purpose well; but as I know, Mr. Editor, you are always ready to give others' suggestions a fair trial or an impartial opinion, will you allow me to submit a simple contrivance to serve as a distance guide to bar-frames such as I am using in a set of new hives? I procure a sheet of tin, cut it into strips the same width as the bars are in thickness; I then cut these strips to a uniform length, of say two inches, I then punch a small hole in one end of each and bend the other end up like the letter L, I then tack or screw one of these thus on each edge of the bar within three inches of the end.

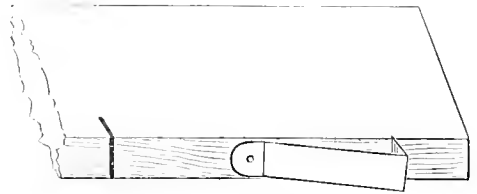

After fixing them on the position as shown, I pivot this contrivance round so that A comes to B, where I make a saw-cut deep enough to admit the bent part; it thus packs in completely out of the way if not required, but answers the purpose of a distance guide besides giving steadiness to the bars when in use.

If you think this suggestion worth calling a *button*, I beg you will accept it as a small contribution from—A HAMPSHIRE BEE-KEEPER, Feb. 12th, 1875.

### APIARIAN MARKETS AND THE HONEY-FAIR.

It has been said, 'that without profit there can be little or no pleasure.' I sometimes doubt whether this really applies to bee-keeping; for it is quite certain that many apiarians experience the greatest gratification in studying the 'queen of the insect world,' who have not, nor do they desire, any more profit than that gained by reaping increased stores of knowledge upon a subject redundant with so distinguished and great a pleasure. However, there are, no doubt, many who accept bee-keeping as 'the thing to pay,' and hence 'go in' for it. If successful, their first cry is for a market to sell their surplus honey. If this cannot be obtained easily and readily, disappointment and discontent rule together that keeping bees is a great mistake. What a satisfaction it ought to be to this section of bee-keepers, that so magnificent a store has been found for them as the Crystal Palace, which opens on the 21st and the 23rd of September next. If well advertised as a honey-fair, it will, without doubt, have a world-wide connexion, and whose goodwill in a few years will be worth a fortune. Well, to the British Bee-keepers' Association, the connexion will prove the more valuable, as all its customers will be of the



retail or money-over-the-counter class. The honey, if charged at a fair price, will insure its sale, only provided that proper means are adopted to enable purchasers to carry it away in a perfectly cleanly manner, and in as small a compass as possible. To do this effectually, I would propose that boxes made of card (which may be obtained very cheaply) be used to pack or put the honey-in-the-comb into; these boxes could be made the size to contain from one pound to five pounds. By their adoption there will be no necessity for getting or inducing the bees to fill small supers. On the contrary, my advice is to get the bees to fill as large supers as possible, and 'go in' for the prize, when, after the award of the judges, each layer or part of each layer of comb could be cut out, and placed in one of the card-boxes. Now, all this by an experienced bee-master could be done without any spilling of the honey or a sticky mess being made; and when all the comb has been taken from the supers, be they large or small, the owners (to whom they are most valuable) will retain possession of them to again replace them upon their lives, to be refilled for the next Show, should a sufficient quantity be left after the Show 'not sold.' It is just possible that Mr. Marriott, who has at all times a stall at the Crystal Palace for the sale of apiarian furniture, might be prevailed upon to enter into an arrangement for the sale of the honey left, at a small commission.

And now that the honey-extractor has met with such decided success, I would propose that the run-honey by this means be put into large glass, earthenware, or wooden barrels, and run out by a tap in the usual way into glass jars or other vessels, as advised by our Editor in the January number of 'our Journal,' letting all the articles used have small openings or mouths, to prevent the spilling of the honey when carried by the purchaser; these jars, &c. could also be obtained to hold from a pound upwards. I will now add, I do not approve of the idea of selling honey by auction. If this were done many would be induced to wait for the auction, and this would probably interfere with the prompt sale of the honey for the first two days, for the auction would, I presume, take place upon the last day. Now, I for one fear the auction would tend to depreciate and bring down the value of the honey, though I apprehend the desire of all good apiarians is, and ought to be, to keep the price of genuine honey at a fixed and a standard price; at all events, not to bring it to a low figure. Indeed, I am of opinion that, if proper means are adopted, such as I have suggested, there will be no occasion to resort to an auction of honey at all.

It will be a great improvement if the table upon which the hives and bee-furniture are placed is made at least one foot higher than it was last year, to enable apiarians to examine with ease the many valuable specimens of hives, &c. placed thereon; and allow no rope to impede the means of carefully inspecting them.—CHAS. H. EDWARDS, Feb. 1875.

#### A SEASONABLE HINT.

Will you kindly allow me, through the medium of 'our excellent Journal,' to advise all apiarians, for

their own interests and advantage, at the close of this month and early in April, to be on the look-out for the 'queen-wasps,' whom they will find upon a warm day lying exposed to the benign influences of the sun's rays upon the leaves of the gooseberry, currant, and ivy trees. Having spied one, the best mode of capturing 'her majesty' is by discharging a garden syringe, garden engine, or hydropult, full at her, which will bring her to the ground, there to perish by being crushed to death by the foot. It must be remembered, that every queen-wasp now killed is really equal to, and will be the means of there being one wasp's nest the less. By a little attention at this season of the year, in the middle of each warm sunny day for a short time, the bee-master will be enabled to rid himself of a very disagreeable annoyance in the autumn.—CHAS. H. EDWARDS, Feb. 1875.

#### THE FIVE-PIN TRAP.

In the *Journal* of last month, it is recommended to arrange the trap in the end of a box of sufficient capacity to contain the super, and then to raise it, *i. e.* the box, on two bricks, so that the side carrying the traps shall be thrown out of the perpendicular, thus causing the guard-pin to fall fully into position after a bee has passed out; but does not the arrangement involve some risk, for I am disposed to think that, in warm weather, combs in supers, not very shallow, would be likely to bend from the form in which they had been worked, and perhaps even break and fall, if placed for a few hours out of the horizontal position, unless, indeed, their length be carefully kept in the direction of the incline, which is not possible where we have irregular buildings? While getting ready for the Bee Show last year a partially filled Woodbury super was forgetfully placed on a slope, and, in consequence, utterly spoiled, so far as appearance went.\* Could the difficulty not be overcome without any very considerable expenditure of trouble, by making the traps on a slip about an inch wide, and planed to, say  $\frac{1}{4}$  in. on one edge and  $\frac{1}{2}$  in. on the other? Three rough holes, of less diameter than the slip's width, might be cut into the side of the box, at the requisite distance from each other, and the slip, by a couple of screws, be fixed over them. The desirable (I do not say the requisite) slope for the trap which I have found to work when perpendicular, by a little modification, presently to be described, is thus obtained. The box will need no prop, and the supers when within it will be *in situ*, as on the hive. I would suggest the nailing edgewise of several slips of thin stuff on the bottom of the box, so that they run towards the traps, admitting between them the light to which the traps give ingress, and at the same time giving exit to the bees from the supers by the openings they have been accustomed to use while labouring upon them. The modification referred to consists in supplying the place of the two upper pins, by one bent into the form of a staple, and inserting this over the hole, pointing downwards, *i. e.*

\* Had the super been filled and sealed out and out, it would no doubt have suffered less. This I am bound to say in fairness, but *partially* filled supers have at times to be cleared of bees even in well-managed apiaries.

taking the reverse incline to that commonly given to a wall-nail. The support to the head being on the part near to the wood, and the pin putting itself (according to a well-known law) under the point of support, closely covers the hole. I have found three traps empty a box of bees very quickly, and do not think more than three desirable.—F. CHESHIRE, *Acton, Middlesex.*

#### HIVING UNDER DIFFICULTIES.

For several years I had in my employment a garden labourer, who after a little training proved a very serviceable assistant in the apiary, during the first introduction and subsequent propagation of the Italian bee and the extirpating the ravages of that fell destroyer 'Foul Brood,' which, unfortunately, was carried along with them.

With the exception of one or two particularly irascible hybrid stocks, for which he entertained a salutary dread—and they knew it—he stood fire remarkably well. I remember one particular morning it became necessary to overhaul one of the Tartars, with the view of ascertaining the progress of several maturing royal cells; and on calling him, he seemed so reluctant to lend a hand, even to give them a puff from his pipe, that I told him to stand back out of the way altogether till I had it through. He then took up his position on the garden walk several yards in front, closely veiled, his pipe in his mouth, and his hands deeply thrust into his breeches-pockets, and puffed away most complacently, evidently prepared to enjoy the fun of the master getting his punishment. The cover was gently removed, but at the first pull at the slides, out darted the little furies, and striking out straight as an arrow, threw themselves stinging savagely on the front of the veil of my assistant. But, ah! increasing numbers weighed down the veil on the most prominent feature, causing a cluster of stings on that sensitive organ. Down dropped the pipe in shivers, off went the veil and wide-awake; and the pæan note of victory once sounded, fresh detachments poured forth to the charge, and, need I add, after a short spell of wild tearing at hair and whiskers, and a volley of invectives, he fled down the walk as hard as his legs could carry him, followed by a stream of his merciless assailants. The examination over, the frames replaced, and cover set on, without as much as a single sting, I set off in search of the runaway. And where did I find him? Stretched on a lawn, his face buried in the grass, his head and neck thrust underneath the spreading branches of an old yew, fairly *hors de combat*, while a little crowd of his tormentors hovered over his prostrate form watching his slightest movement. I got him off to a retired place, and as we picked out the stings he did not join as heartily in the merriment as he afterwards did on any allusion to his inglorious stampede.

A few good 'beat-outs,' fed as liberally as were his pigs, at his home in the neighbouring village, put my assistant into stock, and he declared they paid him the better of the two. Prize poultry were added, a quey which grew up into a valuable cow, the returns from those, and the earnings of an industrious family, placed him independent of working

for his weekly wage, and a small business was established. With more leisure at command, he was appealed to by both the cottager and village proprietor, and soon became the acknowledged village authority in all bee-keeping matters.

To extend the business, removal to the market town was projected and carried out, and the live stock disposed of, with, most regretted of all, the bee portion of it. While sorely missing these, one summer day he was travelling towards his new home when a pleasant hum caught his ear from the wayside hedge, where, lo! a fine swarm was fairly established. But how was the prize to be secured? 'There was the rub,' to ask for a hive at the nearest farm-house might raise unpleasant questions as to his right of property in the treasure trove. Here was no Crystal Palace applauding throng to nerve the operator to his task, but the perfect solitude of the quiet country road. 'Where there's a will there's a way,' never, I believe, in apian matters received a better illustration. What did he do, gentle reader, think you? he quickly doffed his *shirt*, and the combs and bulk of the clustering bees safely secured therein, when off he trudged to town a happy man. A skep procured, liberty obtained to set it down in a vacant feu near his dwelling, and on my inquiring how the fresh start was getting on, 'They are doing splendidly, sir,' was the reply received by—A RENFREWSHIRE BEE-KEEPER.

#### MY FIRST SWARM.

A 'Cockney' born, but still passionately fond of rural pursuits, the ambition of my boyhood was to live in the country, and have my fill of all its delightful pleasures; and fortune, at an early age, enabled me to gratify my earnest wish, and shake the dust of London from my feet. The ways and doings of all live things had ever been a favourite study with me; and often had I vowed that, as soon as I could get a garden, I would keep *Bees*.

It was the spring of 1861 when first I was enabled to sit under my own vine and cherry-tree (I don't think I had a fig-tree), and I proceeded at once to seek a hive of bees. The preceding winter had, as perhaps some of my readers may remember, been terribly destructive, and it was only with considerable difficulty I persuaded an old cottager to part with a stock at the long price of two guineas; but then I was almost promised it would swarm in a week or two. Oh, how this swarm was watched for! One of Tegetmeier's new hives all ready, and a straw skep for temporary hiving, books were consulted, and I soon got well up in bee-lore, often treating the old man who served me for gardener to a lecture on the superiority of modern bee-keeping to the death-and-brimstone method. Fear of stings I had none; somewhere or another I had read, 'Bees never sting whilst swarming.' I need hardly say I did not doubt for a moment this assertion.

At length, one bright warm May-day the joyful cry was raised, 'The bees are swarming!' Down went rake and spade, and man and master looked eagerly on at the noisy, humming host of bees, waiting the moment of their quiet settling, which at length took place at the bottom of the stem of a gooseberry-

bush. Without a coat, shirt-sleeves rolled up, and my hat carefully deposited on a flower-bank, so that it should not incommode me, I advanced, with skep in hand, to hive the swarm; but a warning question from my man arrested me, 'What are you going to do, sir?' 'Hive the bees.' 'What! like that?' 'Oh, yes; bees never sting when swarming!' 'Oh! don't they? I thought they did sometimes.' 'Oh, no! quite a mistake.'

The swarm hung very awkwardly, quite touching the ground, so there was no shaking them into the hive; but a moment's consideration solved the problem. With my hands passed into and behind the bees, I could lift them into the hive. No sooner said than done; in went my hands, at right and left, and in went the bees into the hive—at least some of them. But the rest,—oh! ye gods! *Bees never sting when swarming!* Don't they? Put not your faith in books! With heroic courage I placed the hive on its appointed brick; then, with a yell of agony—arms, face, and neck spotted like a plum-pudding, with bees and bee-stings, to say nothing of some dozens entangled in my hair—did I not run,—into the stable, down among the straw, rolling, kicking, and shouting for some one to pick the little wretches off; which being at length done, and willing hands vigorously rubbing with sweet oil, at last restored me to my equanimity, feeling horribly bruised and sore, but otherwise not much the worse for my rather sharplessen—that bees *sometimes* sting when swarming. But the most aggravating part of the matter was that, when at length able to look after my swarm, there they were, still on the same old gooseberry-bush, and all my pain and trouble bootless. I had had enough for one day; so, rather crestfallen, I had to eat humble-pie, and ask my man to be good enough to hive them, which he, more successful than his master, accomplished.—**BUSY BEE.**

#### WOULD-BE REGICIDES.

A remarkable occurrence took place the other evening in my apiary. On opening the shutter to window of a bar-frame hive containing one of your queens, with numerous of her brood hatched, I found her majesty densely encased against the glass, her subjects (?) being evidently bent on murder. I puzzled myself for an explanation, which ended in the supposition, that another queen must have entered the hive from some reason or other; it was too late to open the hive, so I gave them sufficient tobacco-smoke to drive them from her, and gave ventilation by means of penny-pieces inserted beneath the hive, and waited anxiously until morning. On opening the hive next day, I found the queen all right, except that she had sadly torn wings, which will, I think, prevent her flying for swarming. No other queen was in the hive, and the neighbouring hives possessed theirs all right. If any one can explain this I shall be glad.—B. H., *Market Drayton, Salop.*

*Water for Bees.*—The majority of insects either imbibing their food in a liquid state or feeding on succulent substances, require no aqueous fluid to dilute it. Water, however, is essential to bees, ants, and some other tribes, which drink it with avidity.

## Foreign Intelligence.

### FROM THE 'AMERICAN BEE JOURNAL.'

Writing of Sir John Lubbock's observations on bees, a correspondent says, 'We can only say that Sir John's discoveries are at variance with the experience of bee-hunters and bee-keepers on this side the great Atlantic fish-pond. In hunting for bee-trees, dependence is put on the instinct and communicative power which Sir John denies to the bees, while the robbery of isolated hives and the gathering of honey in all sorts of out-of-the-way places, point to conclusions the very reverse of those arrived at by the scientific baronet.'

The British Bee-keepers' Association is extensively noticed and its objects commended 'to the careful attention of all those who have anything to do with Fairs and Exhibitions in this country.' The specimens exhibited at the Palace by our esteemed friend, Mr. William Carr, are specially noticed, and the question asked, 'Who will begin now to make a collection of equal value and interest for our Centennial Exhibition?'

At a meeting of the Michigan Beekeepers' Association on December 16th, 1874, a most interesting paper was read by Professor A. J. Cook, of the State Agricultural College, on 'Feeding and the Extractor in relation to Profits on Apiculture.' He says: 'Science teaches that to have honey stored we must have not only bees but honey secreted by the flowers, and room in the hive to store the same, and we must keep the queen laying eggs. Suppose we have an excessive yield of honey from the fruit blossoms during May, the workers will in two weeks fill every cell in the hive. What then? the queen, like Othello, finds her occupation gone. And thus autumn finds us with feeble colonies, small returns, and long faces, when nature has been most propitious. After September we have no gathering, brood rearing ceases, we approach winter with what few bees we have,—old, torn, and grey with labour; and ere spring, even these succumb, and what wonder if we say "bee-keeping is played out?" for in just such ways does it far too often become a source of vexation and discouragement.' He then goes on, speaking in the highest terms of the Extractor as a means by which relief may be given to dyspeptic colonies and late breeding promoted, and says 'Here then in the use of the Extractor and by judicious feeding, the apiarist has power to leap one of the greatest obstacles in the way of success. And just here let me say that I fully believe that in this use we receive the greatest benefits of this indispensable machine.'

Regarding ventilation, Mr. A. C. Balch said:—'Bees do not need upward ventilation at any season of the year, much less in winter. If the conditions are just right, you can seal them up air-tight, and they will live. I prefer a tight barrel to a ventilated hive.'

Mr. F. F. Bingham immediately 'wished he had had a hundred swarms bottled up last winter.'

The New Idea Hive.—'Will the Secretary give us his experience with the New Idea Hive?'—Mr. H. A. Burch: 'It is very valuable,—makes tip-top kindling wood,—for a bee-hive it is worthless!—[This is a testimonial with a vengeance.—Ed. B. B. J.]

Mr. J. D. Kruschke, of Berlin, Wisconsin, in describing a meeting of bee-keepers, says:—'We spent the day in talking bees, and topped off with a fine supper. While we were in council assembled, the wives of the sturdy manipulators talked bonnets, &c., &c., below. This was a model bee-keepers' convention, for we agreed at least on one thing, that 45 degrees is about the right temperature to keep bees in winter.' The meetings in future are to be half-yearly, and 'there is no initiation, no fees, no blow, but a good social time,' and he adds, 'we hope this may give others a hint.'

FRANCE.

The general topic of interest among bee-keepers at present is the important collection which apiculturists have contributed to the Paris Exhibition of Insects, the result of which seems to have given general satisfaction.

An upward tendency has prevailed during last month in the price of honey at all the French markets, and it is computed that in the event of improved markets, last year's yield would not suffice. Wax has not yet followed this course, but an early move in the same direction is already anticipated. The tenders for the supply of white honey to the hospitals during 1875 have been closed at 118 francs per 100 kilos.

A report published by Mr. E. Drory, of Bordeaux, shows that last year, the average production of his model apiary, consisting of 51 stocks, has been 26 kilos, 571 grammes of honey and wax per stock—a much larger yield than 1873.

A general competition, brought forward by the Minister for Agriculture, is being held at the Palais de l'Industrie in Paris. The entries for competition comprise 5 kos. of honey and 5 kos. of wax.

At Erize-Saint-Didier obstacles are being placed in the way of the advancement of bee-culture, no hives being allowed without the authorisation of the local magistrates.

ITALY.

With a view to assist those of such bee-keepers as may require sealed honey in bar-frames to feed their stocks with through the winter months, the Central Italian Bee Association has undertaken the purchase and supply of this article amongst its members. The uniformity observed throughout the country as regards the dimensions of the bar-frame, seems peculiarly advantageous to the undertaking.

A considerable amount of uneasiness is being created among bee-keepers in consequence of a spread of foul brood—a disease but very little known in Italy hitherto.

As hinted in a previous number, the Italian Honey and Bee Show, just held at Milan, has been under the mark, owing to unfavourable yield of last year.

ECHOES FROM THE HIVES.

*Ivybridge, Devon.*—'My eight stocks of bees are healthy and well, feeding, when fine, on a large bed of purple heath and crocus in the front of them.'

*Wigton, Cumberland.*—'I am delighted with the quilts on my hives; I believe they are a grand success.'

*Liverpool.*—'I beg here to add my humble testimony to the efficiency of the quilt, having it in use on six of my bar-frame hives.'

*Bridlington, Yorkshire.*—'The past season has been most unfavourable in this neighbourhood. I had forty-nine hives standing, but have not taken any honey; and fed before the end of September 65 lbs. of sugar. I have now, Jan. 18, six hives dead, with some honey, but to which I suppose they were unable to advance during the cold weather. I manage my bees partly in Dzierzon's twin-cases, partly in 'Dathes' hives, with a few of all descriptions.'

*J. R. C., Kjøbenhavn, Denmark.*—'We are enjoying (?) a regular northern winter, and I am anxious for my poor bees. Since the end of October last they have not had a chance of flight, and I fear now they must be seriously inconvenienced—Feb. 13th, 1875.'

*West Bromwich, Feb. 17th.*—'My quilts have answered admirably, the bees, whenever I have inspected them, being lively and clean. You need not fear the stinging criticism; your principle is the right one, and will prevail.'

Queries and Replies.

QUERY No. 117.—I shall feel obliged if you will reply to the following questions. I enclose a stamped envelope.

How many hives may be safely and advantageously placed side by side on one stand?

Is it desirable to have glass windows in each compartment of a hive? Should they be in the sides, and so parallel with the comb, or in front and back, and therefore at right angles with the comb? I suppose there should always be two windows at least, and these opposite each other.

I suppose deal and oak are both, on account of their smell, unsuitable for hive-making, the honey during at least the first season would absorb the flavour. Is this supposition correct?

It is said that the deeper the stock-boxes are the greater the danger of crushing bees when inverting the bar-frames. Is this so, and what should be the proportion of depth to area?

What are storifying hives as distinguished from hives with supers?

I suppose a solution of glucose would be a better bee-food than a solution of ordinary sugar. Has experience shown this to be the case?

Are Ligurian bees less inclined to sting than the common variety as is asserted in Langstroth?

What are said to be the peculiarities of Egyptian and Greek bees?

Is the honey in those immensely heavy supers, &c., which are said to have been filled by one stock, mere flavoured syrup, transferred by the bees from the feeding apparatus to the comb, or is it undoubtedly gathered from flowers; the taste would, I should expect, be insufficient to prove the source from which it was derived? Is the declaration of the owner the only evidence required of its origin, or are both kinds considered legitimate honey?

Would the honey of one enormous colony, produced by the union of two ordinary stocks, be equal in weight to that collected by these same two stocks had they not been united?

Is a west aspect bad for a hive? Is the super of your Cottage Woodbury furnished with bar-frames?

Are bees more comfortable in a tall stock-box, say, double the height of its length from front to back?

Are Langstroth's temperatures Centigrade?—J. H. E., *Earlham Road, Norwich, January 23, 1875.*

REPLY TO No. 117.—1st. It is most advantageous to place every hive on a separate stand, as otherwise operating on one will often disturb the others on the same stand, and cause them to commence fighting or robbing. It is a sound maxim which says, 'Every hive should stand on its own pedestal.'

2nd. Windows in hives are not by any means necessary, and are generally of very little use. If at the sides the bees will build their combs parallel to them, and at three-sixteenths of an inch distance; and if at the front and back, the ends of the frames will obstruct all view of the hive, or, if there are no frames, the bees will build combs against them, leaving not more than three-eighths, and often not more than a quarter of an inch between to peep through.

3rd. Oak being a hard wood is not good for hives, since its density makes it too cold. Deal, on the other hand, is generally used. It is a mistake to suppose the odour of the wood would flavour the honey. A very few days' occupation by the bees drives out all odours but their own. Bees are

partial to the odour of yellow deal, and often may be detected stealing freshly-made sawdust from timber-yards.

4th. Undoubtedly there is more danger in lifting a deep comb in or out of a hive than there is with a shallow one, because it is not so well under command, and if thrown slightly out of perpendicular, it would be so much more likely to drag against other combs, and cause injury. We cannot determine the proportion of depth to area; it is a debatable question. In America they are discussing the propriety of establishing one gauge for frames, and 12 in. x 12 in. is mooted as about the correct thing. We prefer frames of from 9 to 10 inches deep to those of less size, but have not tried any deeper.

5th. Storifying hives are those which are increased in size by the addition of horizontal sections, placed above or below the boxes forming the stock hive, as in the Stewarton and Carr-Stewarton hives. Hives with supers are in a sense storified, but the systems of management are different, and hence they are designated the storifying and supering systems.

6th. Glucose is one of the constituents of honey; mixed with sugar, bees will take it freely, but they will leave pure glucose, and take pure sugar syrup in preference. When honey is scarce they will take glucose alone, but not in very large quantities.

7th. Pure Ligurian bees are less inclined to sting than any others, and when carefully handled are as harmless as flies. When irritated by a nervous operator they are capable of resentment and can sting as hard as the fiercest hybrids. In defending their stores against robbing bees they are exceedingly active and vigilant, and generally hold their own against great odds in numbers.

8th. We have had no experience with Egyptian or Greek bees. Perhaps a brother bee-keeper will reply to this query.

9th. The immense supers are supposed to be filled by one stock of bees, with honey gathered from flowers in the natural way. Unfortunately, however, the *contrary* has been *proved*, and monster supers are now generally objects of suspicion. The declaration of a man of probity ought to be sufficient, and such an one would take care to have his assertion backed, if necessary, by witnesses to his mode of management. In our opinion the declaration of an owner ought not to be considered sufficient, but the honey should be carefully analysed and tested if possible. Bee-keepers are so greedy for honour that they are sometimes tempted to steer rather near the wind. Take, for instance, the Manchester monster super of 1873, which was filled in accordance with the letter of the regulations, but was not what it seemed; and from the nature of the season we felt certain it was a made-up affair, and such it proved to be. Legitimate honey is the natural secretion of flowers and blossoms gathered and stored by bees in the natural way. Anything else *cannot* be honey, nor would it, if detected, be *considered* honey, under any circumstances.

10th. Undoubtedly a doubled stock could gather a much larger quantity of honey in a given time than the same bees would if not united, for the simple reason that, having only one queen, there would only be one set of brood to attend to (after the

first few days), consequently there would be a vastly increased surplus population which would have nothing to do but gather and store honey. It must, nevertheless, not be forgotten that at the end of the season there would be only one stock left, which would be sure to dwindle to about the ordinary strength.

11th. The aspect for hives is of little consequence. Turn their backs to the most prevalent winds. The Cottage Woodbury is described in the February number of *Journal*.

12th. We have faith in Langstroth's notion that a tall hive laid down, *i.e.*, a hive longest from front to rear, is the best for bees. Langstroth's temperatures, as far as we can gather from his book, are Fahrenheit, see p. 46, reference to Dr. Hunter.

#### NOTICES TO CORRESPONDENTS & INQUIRERS.

W. J. W.—There is no danger of honey leaking from sealed cells unless they get crushed or bruised. The object in turning the hive upside down when travelling is, that the heaviest parts of the combs shall be resting *on* its crown instead of hanging suspended *from* it. It is possible that honey may leak from unsealed cells when the hive is inverted, but in that case it will do no harm to the bees, because they will be in the then upper part of the hive, near the cheese-cloth or strainer; and when the hive is returned to its natural position they will set to work and clear up and re-deposit it in the cells.

J. W., Stanbury.—If you refer to p. 169, vol. i. of the *Journal* you will find the Cheshire Nucleus Frames illustrated and described. Both top bars lock together and form one length for use in a large hive; and when the bottom rails are fastened together the whole forms one double, or twin frame. Wire netting for holding pieces of comb in frames may be of finest gauge, and about 2½ or 3-inch mesh; but for use in transferring apparatus as described in No. for January, it should not have more than a three-quarter inch mesh, or it might cause damage to the combs.

A. B.—There is no harm in the barley-sugar being 'lemon-flavoured' if the bees will take it, but flavouring is quite unnecessary. The barley-sugar usually sold by confectioners does not readily deliquesce, hence our special receipt in December *Journal*.

BEE-FLOWER SEEDS.—We are daily expecting a selection of bee-flower seeds from Germany, which we shall be happy to share with any who care to have some. The selection will be that of an English gentleman well acquainted with our soil and climate, and will doubtless be interesting. We will give the list in April. Packets will be about 1s., which will include some seeds of the whole collection.

'NORTH HANTS.'—The Stewarton Hive and System were fully described by 'A Renfrewshire Bee-keeper' in the early numbers of vol. i. The mode of making wax-sheets was described in last month's *Journal*.

G. H.—The very prevalent adoption of the word 'hybrid,' as applied to the produce of Italian and black bees, is not strictly correct. The law of nature is that creatures of every kind shall increase and multiply by propagating their own kind and no other. There are no strictly hybrid races. The word 'hybrid,' in its common acceptance by bee-keepers, cannot be supported. The bees should more properly be described as 'mongrel,' though this word has lately fallen into bad repute. We should not perpetuate a mistake.

*Covers for Binding the BRITISH BEE JOURNAL may be had, price 1s., at the Office, Hanwell, W.*

# BRITISH BEE-KEEPERS' ASSOCIATION.

COMMITTEE MEETING, FEB. 11, 1875.

Present—Messrs. MELLADREW, COWAN, C. N. ABBOTT, CHESHIRE, ATLEE, and Hon. Sec. Mr. COWAN in the Chair.

THE Committee gave instructions for the immediate printing and issue of the long contemplated circular. Balance Sheet for 1874 was read, and W. Hughes, Esq. appointed Auditor to audit the same.

Mr. J. Smith Turner having left England for three or four years, his place on the Acting Committee was declared vacant, and a gentleman was nominated by Mr. Cheshire for election next meeting to fill the vacancy.

A discussion then ensued, and the Hon. Sec. was directed to arrange if possible for a *conversazione* of Bee-keepers to be held in the early spring where friendly discussion and interchange of ideas may take place, as well as the Exhibition of scientific objects of interest both Apiarian and general.—JOHN HUNTER, Hon. Sec.

NOTE.—In order to carry out the intention expressed in the last paragraph, the Hon. Sec. will be glad to receive suggestions likely to further the object in view, and particularly any information which would enable the Committee to obtain the loan of a suitable room for the evening at little or no expense. Probably some other scientific society may be found who would be willing (as is usual) to accommodate the Association with the use of their Meeting-room for the occasion.

## OUR WANT AND SALE COLUMN.

WANTS may be advertised at 2d. per line of eight words, for one insertion, renewable in succeeding months, for three months, without alteration, for half price. Replies must contain stamped directed envelope, or they will not be forwarded.

All monies must be deposited with the Editor, who will communicate with the vendor, when, if a sale be effected, one penny in the shilling will be charged on all amounts not exceeding one pound, and one halfpenny additional will be charged on every shilling beyond that amount, and the balance forwarded to the vendor.

Should no sale take place, the money deposited will be returned to the depositor, less a uniform charge of fourpence to cover postage.

The carriage of all articles sent, except such charges as are incurred in first placing them on a railway, must be paid for by the depositor, and if not equal to the description given, the advertiser must pay the cost of their return.

The postage of small articles, such as books, must be prepaid by the sender. The name of the town or country in which advertisers reside, and the name of their railway, should be mentioned as a guide to probable cost of carriage.

No advertisement must contain more than sixteen words.

P. O. Orders to be made payable to C. N. ABBOTT, office of *British Bee Journal*, Hanwell, W., London.

No.		s.	d.
71	'Huish's Bee-book' ... ..	2	6
72	'The Female Monarchy.' By Rev. John Thorley	2	6
74	Murphey's Honey-extractor ... ..	80	0
89	Eight of Neighbour's bee-feeders, mahogany floats, top glass, all complete, at ... each	2	0
90	Woodbury bar-hive, 10 frames, two windows, hinged covers and floor-board, complete ...	12	6
91	One straw ditto, 10 frames, one window and floor-board, good as new ... ..	14	0
96	Half a dozen strong well-made straw hives, flat tops, with hole in centre. Lincolnshire ...	12	0
97	Square queen-cages, perforated zinc, to release queens within the hive, the most simple ever made, 6d. each ... .. per dozen	5	0
98	Wanted.—A large quantity of Puff Ball, dried.		
99	Wanted.—Evans' Poem on Bees, either to purchase, or on loan at per month. Security given.		
101	Wanted.—Two healthy stocks of Black Bees. Good condition, low figure. Great Western Railway.		
103	Two of Taylor's dividing hives, stained and varnished, fitted up with 8 improved bar-frames ... .. each	10	6
104	Two Swiss bar-frame hives painted, with 8 bar-frames and floor-board ... .. each	8	0
105	Two Neighbour's zinc bee-feeders with floats ... .. each	2	6
106	Two Neighbour's fountain zinc bee-feeders with floats ... .. each	3	6
107	'The American Bee-keeper's Manual.' By J. B. Miner, 350 pages, with 35 engravings	6	6
108	'The Management of Bees.' By S. Bagster, 2nd edition, 240 pages with 40 engravings ...	6	6
109	'An Inquiry into the Nature, Order and Government of Bees.' By Rev. John Thorley, 2nd edition, 1767, 158 pages ... ..	4	6

## SALE COLUMN—CONTINUED.

No.		s.	d.
113	Carr's improved mahogany observatory revolving bar-frame hive, second hand ...	60	0
115	Wanted.—A Second-hand Stewarton hive complete.		
118	Wanted.—Any quantity of empty worker comb. C. J. Smith, Stroud, Gloucestershire.		
119	Box Hive, containing 2 stock-boxes, 2 medium supers, and 4 small ditto, with access from stock-boxes to each or all of the supers, small window in each ... ..	15	0
120	Neighbour's improved bar and frame stock hive straw, with wood frame and one window ...	20	0
121	Wanted.—Dr. Dunbar on Bees. State condition and price post free.		
122	Two strong stocks of hybrid Italians in Abbott's new frame-bar hives, heavy enough to stand the winter ... .. each	45	0
123	Wanted.—'Guide de l'Apiculteur,' par M. Debeauvoys, 6e édition. Will give 3s. 6d. for clean, perfect copy, post-free.		
125	Wanted.—Some stocks of black bees, for cash, or will give in exchange pure bred black Spanish cockerels. Great Western Railway.		
126	A Langstroth hive, in first-rate order, never been used, outer case inch thick ... ..	40	0
127	Two Pettigrew ekes, fit 18 in. hive ... .. each	1	0
128	Wanted.—20 stocks of black bees, in skeps, must be healthy. S. W. Railway preferred. Weight no object, but should have plenty of bees.		
130	Several second-hand hives for patterns, from	5	0
131	Several tin fumigators, quite new ... .. each	2	0
133	'The Management of Bees, with Description of the Ladies' Safety, and many other kinds of Hives.' By Samuel Bagster. 244 pages and 40 illustrations. Free by post ... ..	6	0
134	Wanted.—A clean copy of the <i>British Bee Journal</i> for June 1874.		
135	Wanted.—Three or four supers of last year's honey. Good. Eight to twelve pounds each.		
136	Three hives of hybrid Italian bees, in boxes with glass windows on three sides—very healthy—with young queens of last summer, will travel any distance, Somersetshire, each	40	0
137	Wanted.—The October No. of the <i>British Bee Journal</i> for 1873, 6d. sent on receipt of post-card		
138	For Sale.—One or more strong stocks of pure Ligurian bees, in Woodbury frame hives, Dublin ... .. each	50	0
139	'American Nest Hives' (by K. B. Edwards), set of four, with ekes, &c., complete, new ...	12	6
140	Aston's drone trap, new ... ..	3	6
141	'Full and Plain Directions for the Management of Bees to the greatest Advantage.' By the old and able author, John Keys. Post free, in excellent preservation ... ..	7	6
142	Wanted.—A fertile queen-bee, to introduce to a queenless stock. Pure Ligurian preferred. Chichester.		
143	Two 10-frame hives, projecting ends to frames, one window with three glasses, outer cases, super-cover and roof, floor-boards, crown-boards, and quilt ... .. each	25	0



## BEES, HIVES, BEE FURNITURE.

**T**WO First Prizes and Certificates were awarded to Mr. C. N. ABBOTT, at the late Crystal Palace Show, in Class II. 'For the best Skep, or Box hive, for depriving purposes, for Cottager's use, that can be supplied for 3s.' That exhibited by the Editor of the *British Bee Journal* was awarded First Prize and Certificate.

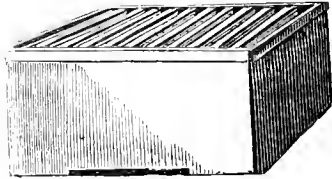

Crystal Palace Cottager's Hive, price 3s.

**I**N Class VI. 'For the most economical (best and cheapest) complete Hive, on the moveable comb principle, for cottager's use,' that exhibited by the Editor of the *British Bee Journal* was also awarded First Prize and Certificate.

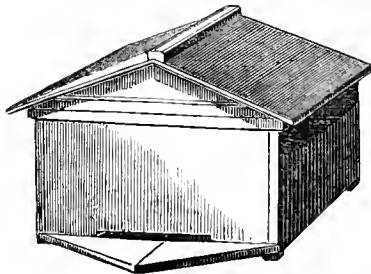

Crystal Palace Cottager's Hive, No. 2, price 6s. 6d.

As it is probable that these Hives will be in great demand in the Spring, it is hoped, to prevent disappointment, that orders will be at once forwarded to Mr. C. N. ABBOTT, Bee-Master, Hanwell.

**O**RDERS will also be received for the WOODBURY HIVE, at 6s. 6d. unplanned, and without crown-board, for use with quilt; with crown-board, 8s. 6d. If nicely planned, 10s. 6d. Adapting board, 1s. extra. Roof similar to No. 2, but stouter, 3s. extra.

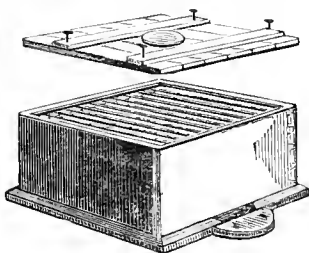

**A**LSO, the NEW FRAME BAR HIVE which has more conveniences for amateur bee-keepers than any other, as advertised on preceding page, well painted, 35s. It has none of the inconveniences of other hives; no notches, rabbets, racks, distance-tacks, or other impedimenta, no metal inside. It has the improved dummies, which on removal give space laterally, and is generally pronounced a 'well-nigh perfect hive.' It includes two bar, glass and wood supers, super cover and roof, moveable reversible floor board on runners, and has four strong legs attached, forming a moveable yet permanent stand.

**I**NDIA RUBBER GLOVES, to be worn over woollen gloves, sting-proof, 6s. 6d. per pair, post-free.

**P**LEASE order also ABBOTT'S Cottage Woodbury Hive double walled, no notches, racks, or rails, frames flush with top, for use with quilt, double reversible floor-board, wood and glass bar-super, super cover, and roof. It is a complete hive, and needs no protection during either summer or winter. Price, well painted, 25s. The cheapest and best hive of the Woodbury kind ever offered to the public.

**V**EILS for protecting the face, fasten round garden-hat by elastic band, price from 1s. 6d.

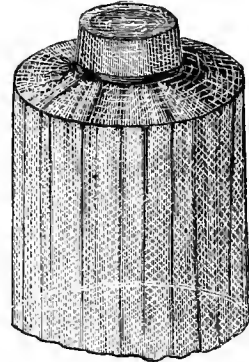

**T**IN SHOVELS 8d. each, post free, our own invention, for use with the Feeding Bottles.  
FEEDING BOTTLES, 6d. and 1s. each.



**V**ULCANITE SHEETS for Division Boards, non-conducting, non-condensing, non-absorbent. Occupy scarcely any space; fit close in hive and form inner walls which render double sides to hives unnecessary. Cut to fit any hive on dimensions being given. Price 2s. per superficial foot. A large reduction where a quantity is taken.

**T**HE BEE QUIETER, the invention of the Hon. and Rev. Henry Bligh. Price 2s. 6d. Fumigator to match, 1s. 6d.

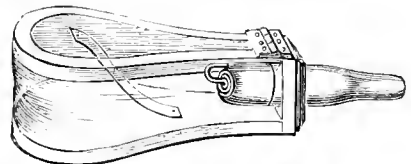

**P**URE imported LIGURIAN QUEEN BEES, at various prices as usual.

**O**RDERS also received for the famous CARR-STEWARTON HIVE, which obtained First Prize and Certificate at Crystal Palace, as the best hive on the storifying system. For particulars see last page of Journal.

**O**RDERS received also for 'Langstroth on the Hive and Honey Bee,' price 10s. 6d. post free.

**S**WARMS of Bees, headed by imported Ligurian Queens, 42s. each, in the Spring.



THE  
**British Bee Journal,**  
AND BEE-KEEPER'S ADVISER.

[No. 21. VOL. II.]

APRIL, 1875.

[PUBLISHED MONTHLY.]

Editorial, Notices, &c.

APRIL.

The past month of March has been particularly unkind to apiarians, the temperature, with snow, rough winds, sleet, and rain, having compelled our pets to keep within doors during nearly the whole period. The temperature during the first four weeks has been considerably below the average, frost prevailing to a great extent until Good Friday, March 26, with very occasional gleams of sunshine, which, while it enabled the bees to gather a little pollen from the crocus, aconite, and laurustinus, tempted many to their death, the chilling east wind which prevailed having paralysed them with its icy coldness ere they could return with their precious burdens to their hives. In strong stocks, which have been well supplied with stores, this has done little actual mischief, but in those ill supplied and weak in numbers, its effects have been disastrous. The strong stocks will be found to have been breeding rapidly, so that their numbers will not be appreciably diminished by the daily losses which may have occurred, and they will presently have the advantage of being well populated by young bees only; but weaker stocks which have been unable to generate the heat necessary for the production of brood, will, in many instances, be found to have dwindled away.

RENEWAL OF POPULATIONS.—Until the introduction of Ligurian bees and the moveable-comb hive, when the internal economy of a bee colony was imperfectly understood through its being impossible to invade the hive and ascertain its condition on fitting occasions, it was thought that the bees left in a hive in the autumn survived until the ensuing spring, and then by breeding produced a large population of young bees to form the swarms for future hives; but the Ligurians have shown us the errors of our fathers in this respect, and have taught us that in a normal colony the population will have been entirely renewed between the closing days of autumn and the merry spring-time next ensuing. The moveable-comb hive has enabled bee-keepers to introduce Ligurian queens in

autumn, when their stocks were being prepared for wintering, and when those beautiful specimens of royalty could be obtained at the cheapest rate; and not a few have been surprised beyond measure at finding in the ensuing spring that their populations have not only been (often) more than doubled, but that nearly every bee in the hive was of the highly valued Ligurian type, and gentle as beautiful. In making this experiment there could be no possible mistake, since the black or brown English bees could not, by any conjuring of the Ligurian queen, be induced to change their colour, but must have been her own progeny, which, during the silence and quiet of the winter and early spring months, the black bees had worn themselves out in perfecting, for it is not pretended that this vast increase of population is brought about without wear and tear to the bees that act as nurses, as such is not the case. But let us see what occurs with stocks which from any cause have been prevented breeding during the five or six months of autumn and winter. It will be admitted that not having laboured in producing brood as in the other case, they have not become so exhausted, but it must be borne in mind that they will have become older, and old bees are of very little use as nurses in raising brood—it is not their *forte*; their duty and business is honey-gathering and the defence of the hive, and it would seem they are unfitted for any other labour. Young bees are required for nursing (and for comb-building also), as experience proves, and it is a striking fact that a hive which has bred no bees during the winter months has often a severe struggle to live through the first three weeks after breeding has commenced in the spring, no matter from what cause the increase has been delayed. If, through poverty, as is too often the case, the breeding is suspended until the spring-blossoms open, the majority of old bees will seek provision as the first essential, and many will be lost in doing so; and although the queen may be stimulated to activity, and willing to stock the hive with eggs, she can only deposit as many as the cluster will cover and hatch, and then comes the difficulty of feeding. It is necessary that the food should be prepared in the stomachs of young bee-nurses, and as before hinted, old ones are not

fully equal to the task, preferring, rather, the outdoor labour, which is more congenial to their instincts. That old bees can and do raise brood from eggs, no intelligent and experienced bee-keeper will deny; but it may safely be affirmed that for every young bee raised in a colony of old ones under these circumstances, at least five of the old ones die; and in how many thousands of cases, at this time of year, has it been discovered that the old bees have died too rapidly, leaving the queen and barely a handful of bees to attend to five times as much brood as they could cover, much of which, just on the point of hatching, required only, perhaps, one or two more days' warmth to bring it to perfection and thus re-establish the colony? This will explain, beforehand, what will otherwise be a puzzle to many, and will, perhaps, remind them of our autumn directions, p. 66, &c., Vol. I, and many times since reiterated; see, also, pp. 99, 100, Vol. II.

#### PREPARING BAR-FRAME HIVES FOR SWARMS.

—Although the weather does not hold out much promise of early swarming, it may be presumed that there will, as usual, be some swarms in May, and to those who will probably use the bar-frame hive for the first time this year, and many hundreds will do so, a few hints on hiving may be useful in preserving them from the miseries which result from having crooked or ill-shapen combs in them. In the preparation of the hive, the chief thing is to fix a guide of wax along the centre of the under-side of the top bar of each frame, fix the frames rigidly in the hive in their exact positions, so that they cannot be displaced by moving the hive, lay a piece of carpet on the frames, and screw on the adapting board, stopping all cracks, and taking every precaution to prevent loss of heat by upward ventilation.

**GUIDES FOR FRAMES.**—The best are undoubtedly strips of worker comb, no matter how old or black, provided they are free from wax-moth, and quite healthy. To apply them, lay the frame wrong side up, and place a couple of hot laundry irons (flat-irons) upon it, making the under-side of frame-bar as hot as possible without burning, then apply a coat of melted wax, and, whilst still liquid, lay the strips of comb upon it, gently pressing them with the hand until the wax sets. The strips of comb need not be more than three cells deep, and they should be laid so that their mid-rib comes along the centre of the frame-bar. Another mode is to paint a rim of hot wax along the frame, and strike off all inequalities with a gauge made of an old knife, or cut out of a piece of stout tin.

A third plan is to brad a small triangular strip of wood, in section like an open V, along

the frame, its point being in the centre, and to paint it with hot wax; a fourth, to cut a groove in the centre of the bar, place a strip of wax-sheeting about half-an-inch wide along it, and then pour melted wax along both sides of it, but this requires the aid of a wax-smelter. A fifth plan is to fix a triangular strip of wood along the bar, one side, a right angle, being close to its central line, then place a strip of wax-sheeting close against it, and nail a second triangular strip on the other side of the wax-sheet, forming a guide exactly as if the open V had been cut down its centre and the strip of wax-sheeting placed between its two halves. There are various other ways of forming the guides, but they must when finished assume one of the forms here pointed out, or a modification or combination of some of them, and so that guides are properly fixed, it is quite immaterial which method (save the first, which is the best) is adopted. What is peremptorily required is, that the centres of the guides shall be not more than an inch and a half apart, and not less than an inch and nine-twentieths, and that they shall be perfectly parallel to each other.

#### HIVING SWARMS IN BAR-FRAME HIVES.—

There is no branch of the bar-frame system of bee-culture which requires more attention than the hiving of swarms, nor is there any part of the science which has received so little attention. Usually it is thought sufficient to place the hive on the ground, with or without the floor-board; and, so that the bees are in it, no thought or care is bestowed until it is put on its stand in the evening, when the spirit-level and plumb-rule are assiduously applied, and the hive is *then* adjusted to its orthodox position. It is true it is *recommended* that as soon as the queen and the majority of her followers have taken possession, the hive should be placed upon its permanent stand; but that is advised, to prevent bees which have 'marked the new location' of the swarm wasting their time in searching for it after its removal to its stand; and although the advice is good, it is seldom followed. Indeed it often happens that it cannot be followed, because thousands of bees being gorged with honey, as they all ought to be in a natural swarm, are, after they have clustered for a short time, physically incapable of taking flight, from the honey undergoing a chemical change, and turning into wax in their bodies. This condition of things may be observed when a swarm has issued on a hot day, and has hung on a branch for some time; the bees become lazy, they have no desire to sting; they may be treated with positive indignity, rolled over and over in tangled masses, yet they seem too sleepy and stupid to resent the liberty taken; and often

clots of bees will be found detached from the main body, and hanging outside the hive, or lying in little heaps about it, quite satisfied with being within hearing of the joyous hum of loyalty within; and such bees, supposing the swarms were removed only a moderate distance, would, if left on the ground, probably be unable to find it when they recovered, and would thereupon return to their old stand. Now from the fact that swarms convert their honey into wax in so short a time while clustering, how important is it that they should have instant opportunity for commencing their comb-building; and how doubly important is it that they should be enabled to *begin correctly*. Therein lies a moral which applies to bee-keepers as well as to bees, and doubtless they will apply it each in his own way; nevertheless, it *is* worth remembering that 'what is well begun is half accomplished.' Notwithstanding all the care that may have been bestowed in preparing a bar-frame hive for the reception of a swarm, it may be taken for granted that as soon as the bees are put into it, the clever little architects will immediately discover if there is anything wrong or unsuitable to their natural habits and reject it. It may safely be asserted that a swarm on being placed in a hive will congregate and cluster for comb-building at the highest part of it. Now if the highest part happens to be one of its corners, the bees will arrange themselves and begin building diagonally across the frames in the direction of the lowest point of the crown; and, seeing that they so rapidly turn their honey into wax, it will be but a very short time before they will have laid the foundations of their combs, and these, as may be understood, will not be along the guides which have been placed with so much care in the frames. After the lapse of a few hours, the bees being all within the hive, the bee-keeper lifts it, and places it on the pedestal it is to occupy, and then with the rule and level it is placed in correct position, much to the annoyance of the bees. They had taken their survey, had congregated at their work, and were hanging and working at a certain angle with the side of the hive; but now the change in the position of the hive changes also the position of their cluster, and they find that their foundations are not right, but that the guides are now in correct position for them to work upon, and without leaving the foundations they have built, they endeavour to bring them into use in conjunction with the guide, and so the combs become twisted and irregular through the hive having been improperly *placed* in the first instance. The moral of this is, that the greatest care should be exercised in keeping the hive in an accurate position whilst left

temporarily upon the ground for the convenience of the swarm's housing.

**PLACING THE HIVE.**—Lay the floor-board on the ground, near the clustering swarm, press it firmly down, and take care that it is perfectly level, take a sheet, or a large newspaper (and if the latter *The Standard* ought to be chosen as the most agreeable, for to its able advocacy of humane bee-culture in September last both bees and bee-keepers owe it an everlasting debt of gratitude), and spread it over the floor-board, placing some stones or clods upon it to prevent it being disturbed by the wind; then place the hive upon the floor-board with its back raised about an inch, and supported by a wedge or stone at both corners. The raising of the back in preference to the front places the hive in the exact position it should occupy when placed on its stand, and permits of greater facility for straggling bees as they can use the entrance also, and obtain admission on all sides. The use of the sheet or newspaper is to prevent the queen and her escort rushing under the floor-board, which they are liable to do in their hurry to hide anywhere out of the way of their disturber.

**CATCHING THE SWARM.**—This is usually effected by shaking the bees from the tree into a straw skep and bringing them to the hive, but we very much prefer a tin pail as it may often be used without the hands being underneath, and in descending a ladder is much more easy to carry, and is also much easier to dislodge the bees from. If the bees are on a branch that cannot be shaken, a bunch of grass (not a lightly bound wisp), or half-a-dozen new sprigs from raspberry-canes (or something similar), should be used as a brush, and the greater part of the cluster rapidly but gently brushed into the pail and carried to the hive, when they should be poured out on to the sheet as close as possible to the back that they may run under it into the hive, which as a rule they will readily do.\*

### THE IMPROVED COTTAGE WOODBURY HIVE—HOW TO MAKE IT.

Continuing our description of the means of manufacturing this useful hive, we venture to hope that our readers will determine to avoid *the space above the frame*, or at any rate that they will keep the tops of the frames perfectly flush with the top of the walls of the hive. There can be no harm in doing this, even supposing the *space* should be hereafter considered necessary, for by tacking fillets of 3-inch deal either round the top of the hive or

\* The conclusion of this article must be deferred to our next.—ED.

the bottom of the crown or adapting-board, the desired result will be attained. This kind of provision is made in the Carr-Stewarton hive, whose crown-board is either close or open fitting, according as one side or the other is turned downwards. If flush frames are determined on, the same material of which their top bars are formed will be required to cover the openings at the sides of the hive, H, K; and for

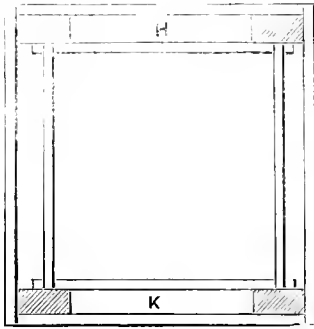

HORIZONTAL SECTION OF HIVE.

these purposes a piece of board, of 17 inches length, 14 inches wide (nearly), and five-sixteenths of an inch in thickness, is required. It may be in two widths, if more convenient, as it is intended to be cut into ten 1-inch strips for the top bars, and two 1½-inch strips for the sides at H, K. Being exactly 17 inches long, these latter, when nailed on the tops of the *hive-sides*, will cover both of them flush with the front and back of the legs, and will enclose the requisite dead air in the spaces marked H K. The front and back may now be put on, and should be made to come up even with the top of the frame-bars. Being only of 9 inches

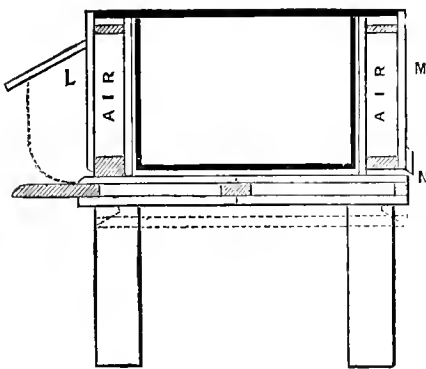

VERTICAL SECTION OF HIVE.

width, these boards will not be found of sufficient depth when on to reach quite to the floor-board, nor is it intended that they should, for the less wall there is that actually touches the floor, the less opportunity will there be of crushing the bees between them, and, as will be seen at N, and understood with reference to the *sides* of the hive, only the inner walls ex-

cept in the front will touch the floor-boards when in position.

The floor-board is very strongly made, being composed of a frame three quarters of an inch thick, covered on both sides with ¼-inch boards well bradded to the frame. The frame is made of two strips, A B, 18½ inches long and 1 inch wide, one strip, E, 13 inches long, of the same width, one ditto, c, of equal length, but a trifle wider, and a piece, D, also 13 inches long and about 4 inches wide, which may be cut to any shape, as an alighting board. These are nailed together as indicated; and so that D is fixed two inches within A and B, as shown by dotted line, and c is about central between D and E; there can be no mistake in the nailing, but the frame, before the boards are nailed on to it, should be 'offered' into its place in the hive, so that if any easing is necessary it may

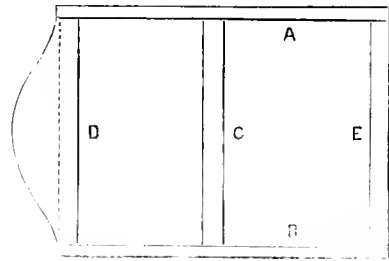

be done before the floor-board is completed. The casing of the frame will require four pieces of board 15 inches long, 9 inches wide, and a quarter of an inch thick, unplanned, and care should be taken to cut them square, so that the frame may be kept square by them. The first piece should be laid on A B E, and to go half way on to c, the next should go close to the other at c, and as far on to D as its width will allow, its top edge, which comes near the dotted line, being rounded off to make the ascent to the hive entrance more easy for the bees: the other side of the frame should then be similarly treated, and the floor-board will be complete. In bradding some pains should be taken to drive the brads at different angles if possible, no two being alike, and a careful workman will punch them into the wood, to increase their holding power and prevent them becoming rusty. To give stability to the legs of the hive, and prevent them sinking into soft ground, or to hold them down, if planted to prevent being turned over, a wedge-shaped piece of wood, of the same width as the legs and of any thickness desirable, is screwed, with its thick end downwards, on to the outside of each leg, thus forming a set of club-feet, which will not easily sink into or draw out of solid earth. To complete the stock-box, three strips of ¼-inch board about 2 inches wide are now nailed on to its bottom edges as plinths, to prevent the rain

finding its way between the bottom of the hive and the floor-board; those at the sides being  $17\frac{1}{2}$  inches and that at the back 18 inches in length, and all having their outside top edges and their inside bottom edges planed away to throw off the water, as indicated at *x*. Two wedge-shaped pieces are also required, as shown, to go between the floor-board and the runners, to keep the former in position; they should be  $14\frac{3}{4}$  inches long, 2 inches wide, and of sufficient thickness for the purpose. A porch is also required, which may be left to the taste of the hive-builder, that exhibited on the hive illustrated, being made of  $\frac{1}{2}$ -inch stuff, with a thin rail running across its back, through which, a screw is driven into the front of the hive, holding the porch firmly, yet rendering it removable at pleasure.

The roof or super cover is now the only part undescribed (except the frames), and this being of single board is made of stouter material than that which forms the walls of the hive, being nearly half an inch in thickness before planing. The 'foundation' of the thing is, like the hive, a perfect square, but is a little larger on all sides, to admit of its easy removal and replacing. The front and back are of  $17\frac{3}{8}$  inches in length and 9 inches high in the centre, and are cut of the shape indicated within the clear lines surrounding *o*. This

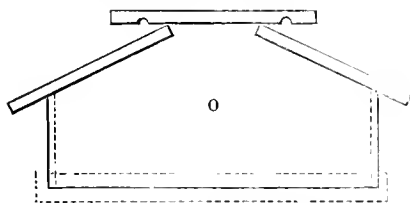

prevents the necessity for chamfering the top edges of the side or eave-boards, which fit solidly on to the front and back. The flat top or ridge-board also comes solidly upon the wide piece left at the top, which, instead of being a narrow strip with short grain to nail to, has plenty of strength to stand any amount of fair wear and nailing. The top-board is grooved on both under edges, to secure a drip and prevent moisture soaking inwards. Before putting on the roof, however, the sides of the 'foundation' should be nailed between the front and back, as indicated by the dotted lines to the right and left of *o*. These sides will be of about  $16\frac{3}{4}$  inches in length; it is impossible to give accurate measurement, because one can never know how much the front and back will be reduced in thickness by planing. Suffice it, then, that the sides must be of sufficient length to cause the front and back each to project 1-16th of an inch outside the hive, and must themselves project as much at the sides, making the

foundation, as before said, a little too big. The roof we have already nailed on, but there remains to put a couple of screws inside up through each of the top edges of the side or eave-boards into the flat ridge-board, to prevent 'buckling,' and to run a plinth all round the bottom edge, to break the joint, keep out the weather, and prevent the whole roof from moving from its place on the hive. There is a very great advantage in having flat tops to roofs, as they offer tables to lay anything upon. Many a knife, screw-driver, &c. have been lost through being placed upon the ground, sloping roofs offering no convenience of the kind, and those who have felt the comforts of such aids in an apiary are likely ever to eschew the fanciful and ornamental in favour of the practical.

There now only remains the making of the bar-frames to complete our hive, and they must (or should) be made of a size that will leave *not more* than a quarter of an inch of space between them and the front, back and bottom of the hive, and *not less* than three-sixteenths. These are most important dimensions, as upon them hinges success or otherwise in manipulation. Where there is more than a quarter of an inch space, bees will build comb; where less than three-sixteenths, they will cram propolis into it, either of which proceedings will cause useless labour to the bees, and consequently their master.

In making frames, it is essential that they be true in shape, so that they shall exactly preserve the spaces round them; and to ensure this we have made a frame-block, in which the parts of the frames are placed before being nailed together. It is very simple and exceedingly useful, but we must defer its description to our next number.\*

#### SUPERS FOR THE HONEY MARKET.

The experience gained at the late Palace Show, coupled with the opinions which have since been expressed regarding the necessity for making honey-combs stored in supers portable, have caused a little working of our wits to produce a means by which that desirable object may be accomplished, and the result has been the production of a super of which the accompanying engraving represents one section only.

Our first idea was to make a large number of frames of suitable dimensions of an inch in width all round (except that a few should have a slot left in their bottom rails to admit the bees, as will be presently explained), and of

\* Since writing the above we have received a description of a frame-block made by our ingenious and valued friend J. M. Hooker, Esq. of Sevenoaks, which threatens to beat ours hollow. May we hope that he will kindly favour us with a drawing that we may illustrate it for the benefit of our mutual friends.—Ed.

exactly the same size, so that any one of them could be used alone in a super adapted for frames; or every two could be placed together, with wax-sheets between, to form sections which could be placed side by side to form a super capable of expansion to almost any extent, and which, being *divisible between each sealed honey-comb*, would afford easy means of depriving *at any time*. After lengthened consideration, however, we determined that the sections would be stronger, more manageable, and more simple, yet equally effective in the form illustrated.

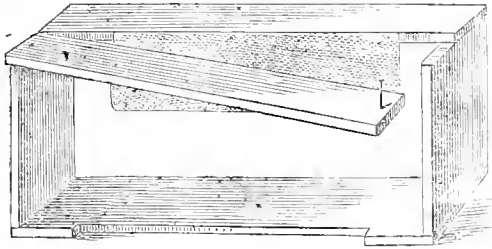

For size, we would recommend that they be 8 inches in length,  $4\frac{1}{2}$  inches in height, and 2 inches in width, all outside measure, so that being uniform they may always be readily put together, or stowed away like bricks. The material used should, for the top and bottom, be a quarter of an inch thick; but for the ends, as they will have to receive the nails, and as upon their squareness and firmness will depend the stability of the structure, half an inch of thickness will be required. To complete a super composed of these sections it will only be necessary to place a piece of glass at either end when all the advantages claimed for glass supers will be obtained, with this in addition, that the super may be increased or diminished in size at will to suit all circumstances. Already, in imagination, we see a hive covered with these sections, each of which stands close upon the frames; and according to the strength of the stock and the yield of honey, so are the bees being admitted by slots cut out of such sections as rest on the outsides of the brood-nest to admit 'all the honey-gatherers of the end (outside) combs, without in the least disturbing the queen or train of nurses and pollen-collectors of the central section,'—a facility claimed to be one of the leading features of the far-famed Stewarton system, see p. 54, Vol. I., where its able exponent, *A Renfrewshire Bee-keeper*, carried away by his affectionate admiration of the system by which hives and supers may be adapted, 'telescope fashion, to exactly focus all seasons and districts, be they good or bad,' says, as if prophetically pleading the cause of the present invention, 'The shallowness of the supers, too, ensures the better classification of the honey with the progressive filling, as

alluded to above, ensuring the thorough completion of each, which enhances very much their pecuniary value.' In our mind's eye we are watching the sections through the glass ends; and as they approach completion, and symptoms of over-crowding are exhibited, are delighted with the idea of opening the super in the centre, and, moving its parts to the right and left, insert an additional section into the space created; or, by transposing them, bring the outside unfinished sections to the centre, where they may stand a better chance of being completed, and thus prevent, as far as possible, the inducement to swarm out; or, what is equally fatal to the prosperity of a colony, the choking of the breeding apartment with honey, and thus preventing the all-important increase of its population. Or, if tempted to abstract a comb of pure honey—*nectar newly gathered from the blossoms of favourite fruit-trees, or selected flowers, in their season*—how easy is it to do so without injury or undue disturbance of the bees! The sealed section is simply *removed*, those remaining are closed up, and the bees are little, if any, the wiser or worse. There is no gaping void in this case, no cheek in the honey-gathering, through it being necessary for the bees to fill the vacancy by clustering to build comb there; but they are, if anything, more concentrated, and more likely to finish their delightful labour.

Again, we see, in a visionary way, the end of the season, and the second Crystal Palace Bee Show and Honey Fair (?), and we feel sorry for those who have adhered to the super of 'auld lang syne.' They cannot remove an unfinished comb from a super without creating a disqualifying void; they may have an immensely superior weight of sealed honey, but there is *a blot*, in the form of an empty or imperfect comb, which seals the fate of what may have been 'a study' during the whole summer, but is now an unfinished work: and, with a shudder, we see it 'left out in the cold.' The sectional super is, however, in an entirely different category. Such sections as contain combs which are unfinished are not exhibited, they are set aside as decoys for next year, or are set over weak stocks, or over colonies which are subject to the 'Extractor,' or they are at once brought under the influence of that powerful aid, that they may be relieved of their contents before the honey becomes granulated in the cells. Will it not be charming to be able to exhibit sealed combs only, finished work, each comb as exact and true in its sectional frame, as were those exhibited, in September last, in the Octagon supers which were brought from Ayrshire to win the admiration of the Southern English world? But stop, Mr. Editor! if these sections are all to be fac-similes and interchangeable, who is

to know where they may have been produced when exhibited in the form of a magnificent pile, 'the produce of one stock of bees?' Well, we take the hint; but for the sake of having the last word, would remind our readers that the Schedule of Prizes, and rules of the next Show, *are not yet promulgated*.

In preparing these sections for use, on small nail, the head of which is left sticking up, would require to be withdrawn, and the top bar parted as shown; a strip of the wax sheeting, invaluable in such cases, and, indeed, in all supers, is placed between as indicated; the moveable half of the top bar is restored to its place, and the nail driven home into its old hole, thereby effectually securing the strip of wax-sheeting, and rendering the section fit for placing on the hive.

The strip of wax should project downwards into the section about an inch, although less will do; and for additional security, and to save the bees some labour, a little hot wax from the wax-smelter may be trickled along both sides of it, to glue it to the wood, and form the waxen angle so agreeable to the bees.\*

#### SEEDS OF BEE-FLOWERS FROM GERMANY.

These seeds are now on their way to England by the good ship *Virgo*, and comprise the following, amongst which may be recognised several which are well known here:—First on the list is the recognised 'King of bee-flowers,' *Borago Officinalis*, an annual whose lovely blue bells yield a profusion of delicious honey, often nearly the whole year round, while its leaves remind one of sultry days and sparkling icy beverages. The next on the list is the rampant-growing *Melilot* or *Bokhara Clover*; this takes two years to come to perfection—sown one year, it forms a trefoil plant a few inches in height, and during winter slinks almost out of sight, but in the ensuing spring it rushes to a height of from four to eight feet, growing and spreading its pretty foliage till it becomes as large as an ordinary lilac, becoming in autumn almost white with its innumerable spikes of blossom, yielding honey largely and a most delicious perfume. The next is our old favourite, *Phacelia Tenacetifolia*, an annual which has very pretty fern-like foliage, and bears a series of lilac spikes, yielding much honey, and affording great amusement and occupation to bees. *Reseda luteola* is also an annual of whose habits we

know little, but from its description it bears a yellowish buff flower, and grows to a height of from two to four feet. *Mignonette* is an old favourite, and, as is well known, an annual. *Balm of Gilead* is the next, and needs little description; it grows two feet high, and bears a blue flower, perennial. *Althea Rosea Nigra* grows to a height of six feet, also perennial, bearing a black-brown flower. *Cynoglossum Officinale*, like the *Melilot* clover, takes two years to come to maturity, and bears a flower of 'violet-brown-red colour;' it grows two feet in height. *Hyoscyamus Niger* is an annual, grows three to four feet in height, and bears a yellowish flower. *Centaurea cyanus* bears a blue flower, is an annual, and grows 1½ feet high. *Dracocephalum Moldavicum* is also an annual, grows one foot in height, and bears a whitish flower; and the last on the list is *Gutierrezia gymnospermoides*, an annual with a pretty name (?), but whose habit or nature we cannot describe. It may, however, be accepted as a first-class bee-plant. Our esteemed correspondent says, 'While I was in England the man who had to attend to my garden was one of the tidy sort, and ridded nearly all away that did not look like cabbages or potatoes.' He had several trial-seed-beds, but they were destroyed through not being recognised and understood, and the young plants were hoed up as weeds, that with the 'pretty name' being amongst the number.

#### PLATES FOR IMPRESSING WAX-SHEETS.

In this matter we hope we shall not be treading on any one's privileges, but from the desire on the part of bee-keepers generally to obtain the wax-sheet as a means of rivalling the far-famed *Stewarton* supers produced at the *Crystal Palace* (1874), coupled with the fact that they cannot now be bought 'for love nor money,' we have been induced to look upon the wax-sheet principle as a monopoly, and therefore, in the interest of bee-keeping, and with a view to give every humane bee-keeper who wishes for straight combs in his supers, an opportunity of ensuring them at the smallest possible expense, we have, by the kindness of 'A Lanarkshire Bee-keeper,' and Messrs. Geo. Neighbour and Sons, of Regent Street, obtained a pair of plates after four months of promises from others, which only ended in disappointment. The plates are, as usually made, about 12½ by 6½ inches superficial—a size perfectly unwarrantable for any purpose connected with bee-keeping, because under no circumstances is it necessary or safe to use the impressed wax-sheet of a greater depth than

\* And now, dear readers, after all our labour, we find our invention has been 'invented' before, has been used in America, and is highly recommended.—*Ed. British Bee Journal*.



from  $\frac{3}{4}$  to  $1\frac{1}{2}$  inches either in supers or stock-hives. It appears to us that the size of the plates, and the necessity for corresponding vessels for wax-melting and presses to enable one to obtain impressed wax-sheets  $12 \times 6$  in., have been the obstruction to the general introduction of the principle, added to which the price of the sheets when made has doubtless been a helping hindrance.

From the present time, however, we hope the aspect of things will be changed; there is no real reason why any one who requires wax-sheets less than two inches wide should be compelled to purchase MACHINERY for making them three times that width, and therefore having obtained the plates, we beg to say we have multiplied them, and, having peculiar facilities, can supply them of any reasonable size at  $2\frac{1}{2}d.$  per square inch super measure. At this price a pair of plates six inches long and two inches wide, long and deep enough for any super, will cost five shillings only.

#### ARTIFICIAL POLLEN.

In districts where, through the protracted cold weather, natural pollen is not yet to be found in any quantity, the flour of wheat, rye, oats, or peas, may be offered to the bees; we say *offered*, for it is by no means certain that they will take it. Stocks that *need* pollen will do so, provided it is offered in a tempting way; but when the natural food comes in it will be useless to place it before them. The plan we have found simplest and best is to procure some stout shavings from new yellow deal, the balsamic odour from which has a peculiar attraction for bees, cut them into shreds, place them in a dish, and dust the artificial pollen upon them. An inverted Woodbury super (wood and glass) forms an excellent dish, as its high sides prevent the pollen being blown away by the wind, and it is most amusing (and instructive too) to watch the earnest little workers preparing the flour, and loading their thighs with their baby food. There are many other ways of administering the substitute, one of which, by putting it into flower-cups, is both novel and interesting, *vide* letter on p. 206.

#### SYRUP CAN.

At this time of year, when visiting an apiary, it is often necessary to give immediate relief by feeding, and many are at a loss to know how to do so in a cleanly and efficient manner. The engraving exhibits an ordinary toilet-can, costing from 2s. to 3s. 6d., according to size, similar to those we have had in use for several years. To render it per-

fect (?), and according to sample engraved, it requires a cork for its nozzle, into which are fitted three or four quills. In use, if a bottle

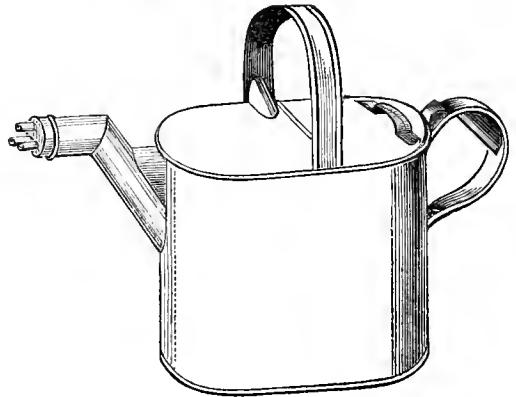

requires filling in haste, the cork must be removed, but when empty combs require to be filled, which in practical bee-keeping is not seldom, then commend us to the toilet-can and its three quills. As a sprinkler to be used *à la Langstroth* it is unequalled, and has the advantage of being perfectly safe from the visitation and consequent drowning of bees.

#### ITALIAN OFFICIAL BAR-FRAME.

The bar adopted by the bee-keepers throughout Italy at the first Congress of Italian apiculturists, on December 7, 1871, measures 11.7 in. in length, and is 1 in. wide; it has two straight wire pins, as distance-guides, one on each side, at 1.5 distance from either end.

#### THE CALEDONIAN BEE SOCIETY.

The Caledonian Apiarian and Entomological Society held its first quarterly meeting on 24th March, in McInnes's hotel, Hutcheson Street, Glasgow. There was a very large attendance; the Vice-President was called to the chair: the minutes of last meeting being read and approved, the constitution of the Society was then submitted to the meeting, and after some discussion was finally approved of. The Vice-President exhibited specimens of *Halictus morio*, *Halictus minutus*, *Halictus flavipes*, *Halictus villosus*, and *Halictus rubicundus*. The next meeting will take place in June, when several of the members are to read papers.

In turning hives bottom upwards, for any purpose, they should be turned in the direction of their combs, so that they may not be thrown out of perpendicular. A hive should not be turned over so that the combs lie even for a moment in horizontal planes, as their weight will render them liable to fall from their supports and crush the bees and queen into a mass of pudding.

## Correspondence.

\* \* \* These columns are open to Subscribers, so that their queries, replies, correspondence, and experiences, may be fully and faithfully recorded; and for the discussion of all theories and systems in Bee-culture, and of the relative merits of all hives and appurtenances, that the truth regarding them may be ascertained. The Editor, therefore, must not be expected to coincide with all the views expressed by the various writers. All Correspondence is addressed to the Editor.

### A VISIT TO HANWELL.

(From the *Journal of Horticulture*.)

Not to the Asylum, although some would perhaps say I was mad enough over flowers to be qualified for it; not to the Central Schools, although I did go there, and should be quite prepared to take the defendant's side in 'Senior v. Tufnell;' but to the Editor of the *Bee Journal*, the well-known Hanwell bee-master, Mr. Charles Abbott: for amongst my cultures I have for many years, in a bungling sort of way, kept the busy little things. But I have been very much dissatisfied with my keeping. I had built a bee-house, into which the wax-moth had come and destroyed two of my best hives, and which I had demolished accordingly. I have long thought that if I kept bees at all it should be in not quite so unscientific a way as I had done: and this feeling was intensified by seeing the wonderful exhibition at the Crystal Palace last year, and hearing, and indeed beholding, the amazing results produced by bee-keepers in various parts of the kingdom, more especially in Scotland. And so, as business led me to Hanwell, I determined to utilise the visit for this purpose; and having corresponded with Mr. Abbott, felt sure, from the tone of his letters, that I should be received with courtesy and initiated into everything that I as a novice might require information upon. There were some three or four things I wished to get evidence upon:—1st, What sort or hives were the best, wood or straw; 2nd, whether the use of the quilt was advisable or not; and 3rd, the value, or otherwise, of the Ligurian bees.

I found, as I have often done with the most successful growers of flowers, that the place where Mr. Abbott cultivates his favourites was not at all a likely place to look for them. There was no fine and open space, no fragrant dell or brilliant parterre, but I turned into a small cottage yard in the street of the long straggling village of Hanwell; and there, in a small square back garden, were in all directions hives of all sorts, and here have the experiments been made which have been recorded in the *Bee Journal*, and which, while they have produced so much controversy, have also led to such good practical results.

And now as to the question of hives. Of course now-a-days nothing but bar-hives will do; but the question is, What sort of bar-hives shall they be—of straw or wood? and if of wood which is the best? The wooden bar-hives are all more or less a modification of the old Woodbury hive; and as I am not inviting a buzz about my ears, and probably a sting or two into the bargain—for writers on bees seem

sometimes as if they had stolen some of the poison-bags of their little pets and dipped their pens in them)—by disparaging this or that hive, I am only going to say what I saw that pleased me. There was, first of all, the wonderfully cheap Woodbury that gained the prize at the Crystal Palace, and which is made for 3s.: this ought to be largely used for the purpose of trying to induce our cottagers to give up their barbarous practice of destroying the bees. Then there was Mr. Abbott's own hive, which struck me as being a most admirable one, and which is made for 25s. complete, or with some further improvements for 35s. This hive seems to me to have all the advantages of a Woodbury, and to be superior to it in some points, which it will hardly be necessary for me to enter upon here. So highly did I think of it that I am going to have one for my new start in bees this year.

And now as to the quilt. I have seen some very hard things said against it, while others have been equally loud in its praise. Now I examined several hives here, and I saw no trace whatever of the damp which is said to be engendered by it. The corners of the hives were perfectly dry, and there if anywhere damp would collect. I had, too, an opportunity of contrasting it with the ordinary board covering. A hive had been sent to Mr. Abbott in which the combs were all crooked, and which he was going to straighten. This had not been opened; and so, as there was a gleam of sunshine, he opened it in my presence. A great deal of damp had collected on the floorboards and on the crowns: so that on this point, therefore, I was quite satisfied. And then in the facility which it afforded for examining the bees I think there is a great advantage: there is no unscrewing of boards, but by just simply lifting up the piece of carpet you have a complete command of the hive. So here again my visit had the effect of determining me to adopt the quilt—which, by-the-by, is a queer name to give it, for it is in reality simply a tidy square of carpet. You can of course put anything else on this for warmth, and either cover with a board or the old cottagers' plan of an inverted pan.

And now with regard to Ligurians. It would ill become one who is a novice to enter into any dispute on this point, or to decide between Mr. Pettigrew, who I see has strongly decried them, and others who approve of them; and yet I gather from his letter that greater results have been obtained from them than from the Britishers. There is one advantage they possess—they are so much more gentle, and to timid bee-keepers this is an advantage not to be despised: and from what I could see with Mr. Abbott I should decidedly give a vote in their favour. They are also very pretty, but I do not think my decision was influenced by the 'prisoner at the bar being of a very prepossessing appearance.'

There is no doubt that bee-keeping is entering on a new phase in England. We have had stores which we have wasted, and continued practices which are barbarous and wasteful; but care must be taken that we do not go to the other extreme by over-refinement. Bee-palaces such as I saw at the Crystal Palace are, I think, abominations; and if this is avoided, and a kindly and teaching spirit manifested by those who are adepts, I am sure great benefit to

the community at large will be the result, and amongst those who are helping to this end we may safely reckon Mr. Abbott and his *Bee Journal*.—*D., Deal.*

#### ARTIFICIAL POLLEN.

Having heard so much lately about supplying bees in early spring with artificial pollen, and knowing that some of my stocks were deficient in their stores of that all-necessary article of baby-food, I resolved, the other day, to consult the 'authorities,' and try the plan of supplying flour in lieu of pollen. The 'instructions' given, both by 'our own Journal' and others, were so explicit that no one could err in carrying them out, and when all was ready I placed the trays or boxes of 'artificial' in conspicuous places about the garden. The day was fine, our favourites were out in thousands; but they would alight everywhere but on the flour.

I dropped a little honey on one of the trays, and some oil of anise on another, as recommended by a scientific 'authority' in a contemporary. They soon came and licked up the honey, but they would not go near the *perfume*, but seemed to give it a wide berth, although it is said they are 'very fond of it.'

When the honey was all sucked up they left the box also, so after a time I gathered in all my trays, and in passing a bed of crocuses in full flower, I incidentally pitched the contents among them and thought no more of it. In watching a bee on a yellow crocus to-day, I was surprised to see the little pellets on her legs were white instead of yellow, and at first I could not understand how the pollen of a crocus could be white; but a little closer observation showed the little sprite was collecting some of my discarded flour off the inside of one of the flowers. The hint was not lost, and I at once got a handful of flour and dropped a pinch into every open bloom; and the consequence was that in an hour or so my bees were crowding into every hive in that garden loaded with white pellets in their baskets, and they have finished up this day with a hum of mirth and gladness that spring has returned with peace and plenty over all the land.

Happy motto of all this is—If you cannot get your bees to take 'artificial' pollen out of a tray, box, or any form of artificial receptacle, put it into the cup formed by nature in the beautiful flower of the crocus, or into the flower of any other plant from which bees collect pollen, and if they do not take it rest assured they do not require any artificial nitrogenous matter.—*J. S., March 23, 1875.*

#### THE WEATHER IN AMERICA— SECTIONAL SUPERS.

Seeing in the February No. of *British Bee Journal* just received the effect of the cold weather you have had in England on the bees, how would the weather we have had in America suit you? From the 1st of January until the 20th of February, the temperature would average about 10° Fahr. below zero, and several times it has been as low as 26° below zero. It has been a hard winter here for bees left on their summer stands, and in winter depositories also where

the temperature went much below the freezing-point, and continued so for any length of time; but where the temperature has been from 30° to 40° Fabr., the bees have done well so far as I know. The weather has not been so that bees could have a good fly here, since the 20th of November, 1874, and since the 10th of January the roads have been badly blocked with snow; and the ground is frozen from 3 to 5 feet deep, according to the exposure, and there is ice on the Mississippi river 30 inches in thickness. I see you have had some difficulty in selling your surplus honey, I think if you would adopt the American style of boxes or frames for comb-honey, that is, small frames to hold from 1½ to 2 lbs. each, and enough of them put together to form a continuous box across the hive, you would do better. The frames are made out of stuff 1½ inches wide, for top and ends; and bottom 1 inch wide, the frame when nailed together is about 6 inches square, the material about ¾ inch thick. When the frames are made true, the edges come together nicely, so by having a glass in the two end frames it is similar to a large box; but for sale purposes can be divided to suit the customers. By placing guide-combs in the under-side of top piece of frame, you get most all of the comb built in the frames nicely, so they will separate without having the honey run out. Such frames sell with the honey without any deduction, so the apianian gets the cost of frames back as well as having his honey in a more saleable shape for the masses of honey purchasers, and fifty such frames will be sold to one box holding 20 lbs. or more, and the honey will sell at higher prices as it is in shape to suit purchasers.

The Extractor is also a very necessary implement in the apiary, if for nothing more than to keep the honey out of the brood apartment of the hive, so the queen will have all the room necessary to keep up the strength of the stock, to gather the surplus honey, as if there is so much honey in the hive that the queen cannot deposit eggs, there is not enough bees raised to gather much surplus in any shape.—*R. R. Murray, Fulton, Ill., U. S. A. March 2, 1875. 24° North latitude.*

[From the above it would appear that *our* sectional super is not a new idea, as we supposed when writing the description of it on another page. It has been the subject of much thought for a long time, and the engraving, p. 202, cut from a model, has been in hand for nearly six weeks. We mention this lest we might be mistaken for *robbers of other men's ideas*, a class of persons too common just now.—*Ed.*]

#### DANISH QUEEN-CAGES.

Your seeds having been forwarded along with those ordered for my own use for the flower-garden, I have opened the box, and packed in one or two small articles of utility that may amuse you in the bee-keeping way. I have put one queen-cage for frame-hives; one for dome-hive or skep, but which can be used for frame-hive where a round feeding-hole is in the cover-board; one solitary or small cage for confining queens in the hive, when wanting to stop breeding, as in foul brood-hives, or it may be used twenty different ways as will suggest themselves in practical bee-keeping; one cell-knife for examining single cells in case of sickness in the hive, &c.; two

honey-tasters of bone, one for fluid; the other for stiffened honey; one feeding-plate for bottle-feeding.

In the first place, let us speak of queen-cages; those that I saw at the Crystal Palace did not suit my fancy in any way, first, as regards the material, they were made of copper, or coppered wire, or zinc, any of which are bad in a hive. Secondly, there was no security to the poor queen inside, as the wires and holes were so wide and large that the bees would have little difficulty in stinging her through or between them; and every bee-keeper, who has watched the little vixens, must have seen how ready and quick they sometimes are with their stings on a queen being put to them, at others receiving her well; besides being so very inconvenient for the bees and queen to walk over. Thirdly, the apparatus for opening is not simple, quiet, and without danger of crushing bees or disturbing the queen inside. Fourthly, what I have wondered at is, that there were none provided with a honey-pot, in which the queen and her consorts could have a short supply in the cage, for there is no doubt a three days' hunger tour is neither agreeable nor good for a queen, and it is quite certain that many get this tour, and are perhaps so weak when released, that they succumb to it, or the bees reject them; and if it is intended that the outsiders shall feed her it is at times a mistake, for if they are at enmity with her at first, they will not feed her,—nay, good as they are, they are not such good Samaritans. Again, if the cage is made so narrow as to go just between two combs so that the inmates can cater for themselves, then there is but little room for the outsiders to make her acquaintance.

Now for my own, first, the material is tinned, and has no poisoning effect, even if the bees lick it. Secondly, the net is open enough for ventilation, but not so open as to allow them to sting through without great difficulty, besides being so arranged, that the confined queen can find security on the top or bottom, where she is quite safe and the net is not difficult for her to travel over. Thirdly, the opening arrangement is so simple and quiet in its working, that, if done slowly, the bees would not notice it, and no bee can be crushed or hurt. And fourthly, though not least, there is a small bone honey-pot in each cage, which will hold a supply for more days or hours than necessary, so that there is no fear of the queen suffering, for, if even her own consorts are so ungallant, she can help herself: and who knows, if it is not the same with bees as with men, that they are always readiest to help those who can help themselves, and so receive her with a better welcome. Again, in putting a new queen in a hive, it is necessary to examine the hive first to see how the brood is, or at least what stage; and when this takes place two of the frames can be left a little apart, and make clear way for the cage, and room all round for the bees to walk round the cage, and indulge their small talk regarding the events of the times, and give more scope for them making her acquaintance; no doubt some of the lower class only wishing her released, and luck with her, that they might clean the honey-pot out after her departure.—J. S. WOOD, *Denmark*.

#### MR. COWAN'S SYSTEM OF WORKING THE BAR AND FRAME HIVE.

Will you allow me to correct an error in my letter to you describing my method of working the bar and frame hive? On p. 186, instead of 'sheet of  $\frac{5}{16}$  perforated zinc,' it should be  $\frac{3}{16}$  perforated zinc, as the worker-bees cannot pass through the former, but do so readily through the  $\frac{3}{16}$ -inch perforations. One of the advantages of using this zinc is that pollen cannot be stored in supers, as it is rubbed off the workers' legs as they push their way through the holes. The weather has been so very cold here that I have only commenced operations on two hives, both of which had a good sprinkling of brood and had not a single mouldy comb. I have provided my bees with artificial pollen, which they seem to enjoy amazingly.—T. W. COWAN, *Horsham*, March 20.

As one of the first correspondents who asked Mr. Cowan how he worked his hives to obtain such a large quantity of super honey (viz. 707 lbs. from twelve stocks of bees), it now becomes my duty as well as pleasure, to return him my hearty thanks for his very valuable communications given to this *Journal*, which will, I have no doubt, have been read and studied over with the greatest pleasure by its subscribers, together with your able leading article. Perhaps it would be presumption on my part to ask Mr. Rusbridge for his mode of management (as he objects to small openings being given to the supers), seeing that in your advertising columns, he is the manufacturer of specially made hives, only the purchasers of which will receive those particulars. However, I think that with your leading article and Mr. Cowan's system, bee-keepers in general need not despair of obtaining a good supply of fine super-honey, weather and district being suitable.—A LAKE LANCASHIRE BEE-KEEPER.

#### THE QUILT.

(See p. 187.)

I may say, in answer to your question, that I always winter my bees under a shed, that is, merely a roof, but open on all sides, against which I place wicker hurdles, or anything which comes to hand, whenever I expect a driving rain or snow; and, as an additional protection, I generally cover each hive with superphosphate or guano-bags, after they have been carefully washed and bleached. But, in the case of the hive alluded to, I may say that the flannel, with folds of blotting between, I lay on the bars; on this I place a board, with a hole in the middle for top feeding, if required, and upon this I keep a bell-glass, to assist in ventilating the hive, upon which I always keep a little bolster, partly filled with feathers, pushing one end into the other, so that it acts like an old-fashioned nightcap. This combination appears to have answered admirably. You will understand that I use the board on the top of this hive to prevent the wind blowing my quilt off. You ask if I can account for the quilt being so wet? Yes; it was just as the severe frost

was leaving us that I discovered it, and have no doubt the very severe frost iced the moisture in the quilt; but, to prevent a recurrence of this, I intend adopting the hint in 'our *Journal*' of placing a layer of straw upon them, upon which I shall throw the bags. This, I think, will allow moisture to escape, and prevent the frost reaching it while escaping.

My chief reason for writing was, that I thought you and your system had been misrepresented, and that, without, as I consider, a fair trial. Accept my apology for troubling you to write, and allow me to remain,—A HAMPSHIRE BEE-KEEPER, *Warnborough, Hants.*

[A FORTNIGHT LATER.]

I much regret to tell you that although I sent you so flattering an account of the well-being of my bees in the bar-frame hives, with quilt over, I have just found that they are dead. I have removed the covering, found it quite dry, have removed the bars, and the combs are free from dampness or discoloration of any kind. The centre comb has brood in it, only recently dead, the hives are bright, and there is an absence of that death-like smell which we usually find in a hive with disease. Part of the bees were clustered on the brood, and extended to one side of the hive where they have consumed all their food, but they had a quantity of their own stored food in the bars on the side of the hive, in addition to which they had a feeder on the top of the quilt filled with honey, with a very small opening in quilt through which they could get at it. I am quite at a loss to show the cause of death, unless it was that the severity of the weather had so benumbed them, that they could not shift round to their reserved store.

I hope you will excuse my troubling you for your opinion in this matter. I so much the more regret the loss of them as I had hoped to point to them as an evidence of the success of the quilt system; and I am far from thinking that the quilt had anything to do with their failure. I dare say this case (if known) to those opposed to the quilt, would give some apparent support to their notions.—A HAMPSHIRE BEE-KEEPER.

[NOTE.—This is just such a case as we had in our mind when penning a few words on hives, which appeared in p. 125 of the *Journal* for December last. It is not necessary to do more than refer to the paragraph near top of right-hand column.—ED.]

I am pleased to find our Editor's 'quilts' have come off so triumphant during this very trying winter, and that many others have been in like happy case; but if several gentlemen who have personally spoken to me on the subject of hive-coverings, would relate their experience it would be found such good luck is not universal. Now with the coverings used by Mr. W. Broughton-Carr, I don't think there is anything to disagree. I do not call them quilts at all, such as our Editor recommends; a simple square of carpet, supplemented by nice soft straw, is a very different affair from a bed of carpets or such-like material, though even this is not likely to be amiss in a well-made, close-covered hive, such as Messrs.

Abbott's or Cheshire's; but where such a covering is on any form of hive exposing the edge of the textile fabrics to the atmosphere, capillary attraction of the moisture of our climate will probably convert the whole into the rotten mouldy mass, such as I found the only one so covered in my garden; and the above words not being originally mine, prove my case was not unique. The extracts from the *American Bee Journal*, given in our *Journal* of February, if carefully read, I think tend to confirm my opinion, the Americans using in preference to a quilt a mat of straw or such-like material, which are advertised and sold there. I can conceive nothing better for a hive-covering than a nice firm-made straw mat with a square piece of Brussels carpet underneath; and this, I think, would give all the advantages claimed for the straw hive over the wooden one. I should like to see Mr. Lee or other hive-makers turn out such an article for our next Show; and if at a low price I think they would sell readily, various sizes could of course be made. Mr. W. B. Carr is in error to suppose I have made any lead to do away with hive-covering altogether; but the case I quoted is not a solitary instance of success. How often do stray bees, located in roofs and such-like places, have their combs closely covered and surrounded? Only this very week I was asked by a gentleman to advise him how to utilize a stock of bees that had been on his premises for many years; and on inspecting them, found the combs built between a kind of double wall of a stable, several feet from the roof, and many more from the ground. Some one had broken into them from the front, leaving a gap of several feet in the wall, the bees merely moved a few inches laterally, where they had flourished for years, with the cold east wind blowing full into the gap, and any amount of open space, three sides out of six. Now I will go so far as to say, that I firmly believe bees will winter quite as safely, without any covering whatever (of course properly protected from rain), but I have no doubt that they would require much more food, and therefore I do not recommend it.—JOHN HUNTER, *Eaton Rise, Ealing.*

[We have never recommended 'a bed of carpet,' our general directions have been to use a square, layer, or thickness of carpet, surmounted by some kind of porous material. 'A well-made, close-covered hive' is exactly the thing which will cause the mischief Mr. Hunter deprecates. The capillary-attraction theory is a myth. Straw is much more capillary than carpet, yet we don't hear of wheat-ricks becoming rotten by 'capillary attraction of the moisture of our climate.'—ED. *British Bee Journal.*]

#### WINTERING BEES IN GLASS OBSERVATORY HIVES.

Mr. Joseph Torry, on page 148, *British Bee Journal*, says, from finding his bees dead in his glass-hive last January, 'I deduce from the above that glass-hives are not fit to winter bees in.' Now, for a great number of years I have kept bees in my improved glass observatory revolving bar-frame hives; the four sides and top of which are composed of layers of glass, and I have never lost a stock of bees in one of them yet.

I think I cannot do better, for the benefit of bee-

keepers, than to send you a copy of an article I wrote for the *Gardener's Chronicle*, of Feb. 15th, 1868, page 157: 'My observatory hives are kept in an open latticed arbour, and are always exposed, winter and summer, to the light and cold, and are the warmest hives in winter of any kind of hive I have tried, either made of wood or straw. The thermometers in the hives (observations of which have been taken for a number of years, three times each day, all the year round) indicate a mean temperature of about four degrees in December and January, and four and a half degrees in February, higher than the mean temperature inside my other wood or straw hives.

The bees do better in these glass hives in winter and summer than in any other I have ever tried, and I have never lost a stock in one of them yet, and fewer bees die in them during the winter than in any of my other hives. The great success of these glass hives is caused by their being made with several layers of glass, with a space of confined air between each, as confined air is a better non-conductor of heat than anything else we know of; and the reason I adopted this plan was, that I noticed the bees (in some hives with one glass side each my father got made in 1806) always went the farthest from the glass side in winter.

In 1844 a gentleman went to Russia, and when he returned he told me, that it was so cold there in winter, that in their cotton factories they put double windows, otherwise they could not spin their cotton yarn. I said to myself, This is what my hives want, and I tried them with two glasses, which was a great improvement; but I afterwards increased them to four, as I then got three spaces of confined air instead of one, and the result has been most satisfactory.

A great many bee-keepers have tried to keep bees over the winter in Unicomb-hives, made of thick wood, and also of glass, and they have been placed in green-houses and all other situations where the temperature is kept uniform, but I have not heard of a single stock that did not die before spring, or so many of the bees died that they did no good afterwards.

It seems to be essential for bees to be able to cluster together to survive the winter; and in the Unicomb hive they cannot, as both sides of the combs are exposed to an outer surface.

In November I remove the glass cover of my observatory hives, and tie one or two folds of blanket over the top of the hive, and never have any dampness in the hives, the outside combs being as free from mould as the centre ones. I leave the blankets on during spring, but in February I put the glass covers on the blankets, and make all tight and warm.

To encourage breeding, and to further stimulate the bees, I give them about half a pound of sugar-syrup each week, taken down through just the number of holes under the bottle, so that the half-pound just lasts the bees a week.—WILLIAM CARR, *Clayton Bridge Apiary, Newton Heath, near Manchester.*

## HONEY EXTRACTOR.

Enclosed I have the pleasure in handing you a rough tracing of a honey extractor, as promised. I propose to have two boxes, about 4 inches wide, and of sufficient length and depth to take a comb each, and to give greater facility for taking them in and out, I would have one side of them about 4 or 5 inches deep only. The ordinary wire rest for comb may be placed in these boxes, or, what I think would be better, they may be adapted to receive two transferring frames, as shown in a late issue of the *Journal*, so that when the combs are enclosed in the frames they may be placed in the boxes, provision being made to keep them at such an angle, that the bottom of the cells may be about horizontal. These boxes I place in a light frame, mounted on a spindle, which I make revolve by a pair of pulleys and an endless band, as shown in sketch. The honey would be emptied from the boxes by taking them out of the frames and turning them up after each operation, or holes could be made in the bottom of each box to be closed by corks. I should place it on a table to use it, but as all that is required to extract honey is to make the combs partake of a circular motion, a much more simple means than the above may be adopted where cost is an object. Take a piece of board, say about two feet long, and nail pieces across each end

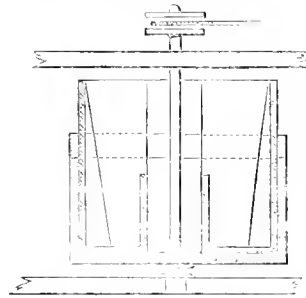

Nail two ribs to the top edges of these end pieces to keep them in their places, then fasten four cords to the bottom board, as far from the centre as is convenient, by boring four holes through it and tying knots under as in a child's swing, the whole to be suspended by these cords brought to one point. If the two boxes described above are then placed one at each end of the board, and the whole thrown round so as to wind up the cords, on its being released it would unwind very rapidly, especially if there was a weight placed in the centre of the board. The speed could be regulated by the extent the cords were wound up and the amount of the weight placed on the board. The honey, being thrown out of the comb, could be poured off from the boxes.—GEO. M. FORD, *St. David's, Exeter, March 9, 1875.*

## EARLY DEVELOPMENT OF BEES.

Looking over old numbers of the *Bee Journal*, I lighted upon Mr. Cheshire's letter at p. 75 of vol. i., in which he relates an instance of workers emerging from their cells in 19 days and 8 hours after the liberation of a newly introduced queen.

It would be interesting to know whether a common queen-cage was used for the introduction, and, if so,

whether the queen was caged over open worker cells, as, in that case, and especially if the bees were friendly, there seems no reason why she should not at once have proceeded to deposit eggs in such cells as she could reach, which would add one day to the time mentioned above as occupied in the development of the workers. It rather favours this idea that the number of bees observed on the nineteenth day, viz., nine, is not more than the number of cells an ordinary queen-cage would cover.

I merely throw this out as a possible and partial explanation of the observations made.—H. JENNER-FUST, Jun., *Hill Cottage, Falfield, Gloucestershire.*

### WHAT ARE THE FUNCTIONS OF THE GENERAL COMMITTEE?

May I ask for information on the following points:—

1. Are the Vice-Presidents of the Association, who, as I take it, also form the General Committee, entitled to be present at meetings of the Acting Committee; and if so, should they apply to the honorary Secretary to be informed when and where these meetings are held?

2. Is it entirely in the hands of the Acting Committee to arrange the Schedule of Prizes and other matters connected with this year's annual Show; or will the General Committee be called to consider and settle these matters so important to bee-keepers in general, and the Association in particular?

As a copy of the rules which has just reached me does not appear to be clear on this point, and Rule 6 (a very important one) does not to my mind define the Committee it refers to, I am induced to ask these questions, but at the same time desire it should be understood that I do so without any intention of wishing the powers of the Acting Committee to be limited, in whose hands I feel certain the interests of the Association may be safely entrusted.—R. W. PARTRIDGE, 10 *New Square, Lincoln's Inn, March 27, 1875.*

## Foreign Intelligence.

### FRANCE.

The French Agricultural Society held its annual meeting early in February last, and among the various subjects discussed were important resolutions for the encouragement of bee-culture. During the sittings of the above-named Society it was incidentally demonstrated that bee-culture contributes towards the wealth of the country by over 21,000,000 of francs annually. It is further computed that this figure might be doubled, were the rational system of bee-keeping more extensively spread and understood.

The price of honey has been well maintained throughout France in the course of last month. Supplies are running out fast, and it is surmised that at the present rate of consumption none, or very little, of last year's yield will remain by the time the next season sets in.

### ITALY.

A prospectus has appeared of the Industrial Bee-keeping Company, with a capital not under 16,000 lire, in shares of 200 lire each; 90 to be paid on allotment, and the remainder by three different calls.

The object is to establish a grand model apiary in the vicinity of Milan, for the production of honey and wax under the most advanced system of management. The Company will be directly under the patronage and supervision of the Italian Central Bee Association, although it will not form part of it, the Association being prevented from taking part in any undertaking having profit for its object.

The Industrial Bee-keeping Company will also buy and sell on commission all kind of bee-produce and furniture, teach the art, and grant certificates to successful pupils, and generally assist private and public apiculturists in their undertakings. The subscription list was to be closed on 31st March ult.

### GERMANY.

According to statistics published by our contemporary, the *Apiculture* of Milan, it would appear that in 1867 there were in Prussia—exclusive of Hanover and Hessen-Cassel—937,224 stocks of bees, 138,934 of which were in Silesia, and 92,940 in Saxon-Prussia. Comparing these figures with the census of 1864, it shows an increase made in three years, of 174,940 stocks, a figure sufficiently indicative of the importance of bee-culture in Germany.

Finally, in 1873, the aggregate number of stocks—including Hanover and Hessen-Cassel, was found to be 1,453,764.

In 1873, Bavaria alone had 338,897 stocks of bees.

### ECHOS FROM THE HIVES.

*Liverpool.*—My experience with the quilt on all my bar-frame hives is highly satisfactory. I consider your vulcanite feeding-stage a great acquisition.—Feb. 27.

*Forton, Gosport.*—I enjoyed my visit very much, and had good evidence as to the value of the quilt, all your hives being quite dry and free from damp.—March 1.

*Anchenraith, Blantyre.*—The weather is bitterly cold, and has lasted a very long time. It is now snowing again. The bees are not getting a good chance, but we must hope for the best.—March 1.

*Alexandra Park, Manchester.*—This winter I have lost one stock in a Woodbury hive (but it had no quilt on) from damp and mould. None of my straw hives were so affected, although in the same bee-house. I had one swarm made 105lbs., one 85lbs., in Pettigrew's large straw hives. I cut 40lbs. of comb out of one, and 20lbs. out of the other, and now they are so full of honey, I do not know what to do with them.

*A. J. A., Tallochsleys Clatt.*—I commenced feeding yesterday. The weather was fine, and my bees were out very strong; but to-day, Tuesday, March 9, we have three or four inches of snow on the ground.

*J. W., Gourock.*—The Ligurian swarm you sent me, May 28 last, did extremely well. At the beginning of September last the net weight of bees, honey, and comb was 97lbs., and they are now very strong and healthy; but the weather is so cold that they are kept close prisoners.

[These bees travelled 440 miles by rail before commencing their labours, so that it was beginning of June (?) ere they could get to work; yet in three months they appear to have *strongly protested* against the aspersions now going the rounds, that Ligurians are but 'indifferent honey-gatherers.'—ED.]

*Edyware.*—I am much pleased with your directions respecting the manufacture of the Improved Cottage Woodbury. The directions being so plain, I progress happily.

*Droitwich.*—I have been trying artificial pollen the last week; the bees carry it in famously. I filled a square of old comb with the flour, instead of putting chaff or bran with it, for them to stand on, and they dived in after it, and soon emptied the cells.—March 21.



## Queries and Replies.

QUERY NO. 118.—I have just discovered the loss of a stock of bees in a Woodbury hive. It appeared very populous and strong in autumn, but my inspection of it at that time was very imperfect in consequence of the immovability of the frames out of the abominable notches. I have now found it quite untenanted, with three frames full of sealed honey, and the other seven with two inches of honey at top, and all besides, one sheet of sealed *empty* comb, of which I send a sample. Surely ova were deposited in these cells! Can you suggest a cause for the failure of the stock under circumstances which seemed to promise such an abundant increase of population? There are nearly three square feet of comb the same as sample, there is not the least appearance or smell of foul brood; yet brood must have perished in those cells.

2. Referring to the *revata questio*, whether frames should be flush with the top of box, or otherwise, it strikes me that in the former case you will find much greater difficulty in removing the top-board, which will be propolized to every frame as well as to the box, than if you have only to cut through the  $\frac{1}{4}$  inch of comb which would fill the space between frames and top; and as to loss of time, they would occupy as much in propolizing, as in the other case. I should be glad to have your ideas of this suggestion.

3. Can you recommend, from experience of its utility, the 'bee-quieter and fumigator?' Can it be used with any other combustible material except fuzz-ball? I have a fumigator of London make; but nothing will keep afloat in it. Can the above be sent by post?

4. In fixing wax-sheets in frames what depth should I leave them under the top rail?—*Colonel, Ireland, March 8, 1875.*

REPLY TO NO. 118.—On minute examination of the comb, we have not the least doubt but that foul brood of a malignant type has caused the death of your bees. If you take a comb, and with a sharp knife slice off the seals from the cells, then, with your back to the light, and holding the frame by its projections, allow the light to shine into the bottom angles of the cells in which the grubs would naturally lie, you will see a dried-up shell of the larva in each of those which was sealed. There must have been a bad case of the villanous disease in the neighbourhood last autumn, which evidently your bees robbed, and so at once poisoned the whole of their brood. Here is another proof of the value of the moveable comb hive. Had you been able to inspect them, the mischief would have been discovered; but as it was, appearances were most deceptive since the bees could only exist *between* the combs. They could not creep *into* them, because the cells were already occupied with the rotting brood, and so they seemed strong. The dryness of the foul brood may easily be attributed to the bees, which, as long as they stopped in the hive, had nothing to do but help to evaporate its moisture. If you take the trouble to find a dried larva, and bring it to the nostrils on the point of a penknife, the *odour* will be found unmistakable.

Regarding frames flush with the top of the hive, if the frames are *flush*, as they ought to be, so that the adapting-board can lie flatly and closely upon them, there will be the smallest (and least appreciable) amount of propolization. The best

argument against the theory you propound, and which many believe in, may be found in the use of the Stewarton slide, which is one of the boasts of the far-famed Stewarton system. It will from this be evident that there can be no more propolizing

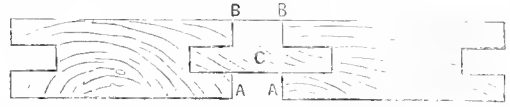

at the angles B B under a crown or adapting-board than there would be at A A under the Stewarton slide, of which C is a section; so that if the said board be divided into sections—say, for argument as many sections as there are openings between the frames—they would be equivalent to the slides being laid upon instead of between them. Now if slides be so laid that a slight twist sideways will release them, I am led to contend that, thus placed, they are in an improved position, and while fulfilling *all* the conditions of the Stewarton slides, may be more easily moved, and consequently are less objectionable than 'that plague of a slide,' as an esteemed correspondent considers it (see p. 120, vol. i.). That slides are sometimes a nuisance must be admitted on all sides; but the slide, *as it ought to be*, cannot be so fixed with propolis as to be immovable, and therefore, like the close-fitting adapting-board, its value depends upon the quality of the workmanship bestowed upon it.

The point of contention really, is as to the value of the space above the frames, space left by the designer of the Woodbury hive, and retained by scores of other hive-builders as a convenience for the bees, and our argument is, that it is in opposition to their natural instinct and habit, as is evidenced in almost every hive so constructed by the bees building against the crown-boards. It is well known that bees will not,—indeed cannot build in spaces less than a  $\frac{1}{4}$ -inch high; but the space between the frames is usually more than this, and so they elongate their topmost cells, and continue them up the sides of the frame-bars, and reach the top, as we believe, to cut off the means of the leaf's escape from the brood-nest, thus—

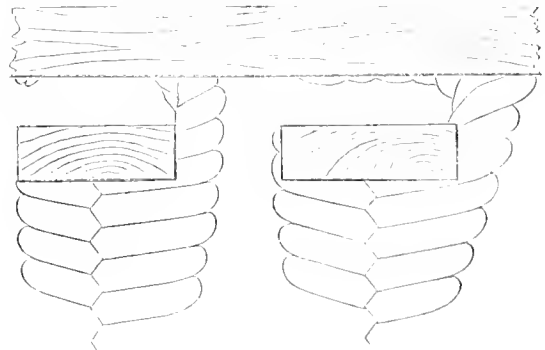

and leaving only holes here and there through which bees may pass.

If the close-fitting adapting-board is found to be a nuisance, and when made in four or five pieces we cannot see why it should be so, some other means

must be adopted, and in this respect it is probable that a few strips of india-rubber sheeting or macintosh would answer all the purposes and solve the difficulty. First, being flexible, it would strip off like a strip of plaster, and, secondly, it could be replaced without injuring a bee; thirdly, it would not during the breeding season permit the escape of vapour; fourthly, the bees could not tear it; and, fifthly, it would occupy little space, and the super boards could be placed upon it. It would, in fact, answer all the purposes of the Stewarton slide, without any of its inconveniences.

'The bee-quieter and fumigator' are very good indeed, but the material in them will not keep alight unless the bellows be kept gently moving, anything may be used in them, puff-ball, rags, tobacco, touchwood or fustian. They may be forwarded per post. In fixing wax-sheets, any depth may be given from half an inch to an inch and a half. An inch is however ample.—Ed.

QUERY NO. 119.—Is the system of driving, as described in the December number of the *Bee Journal* equally applicable to bar frame hives as to skeps? It seems to me that the bars not forming part of the solid body of the hive, but hanging loosely from the top, would not receive the vibration communicated by the tapping to the walls of the hive, especially when these last are double.—W. J. W., *Dublin*.

REPLY TO QUERY NO. 119.—Driving is not supposed to be necessary with bees in bar-frame hives, as, if properly arranged, it is so easy to lift out the frames of comb and shake the bees from them into another hive. It may happen, nevertheless, that the combs, through being crooked, or built diagonally, or across the frames, are not conveniently moveable, in which case we would *drum*, with the hive inverted, taking care that the top bars of the frames are first fixed, so as not to allow them to fall from their rabbets or notches, and to ensure the stability of the combs while drumming. One end of the hive should be set up higher than the other, or otherwise the bees will distribute themselves all round its edges; but if the hives be arranged like a half-open writing-desk, they will require very little drumming to induce them to leave their original dwelling-place. Double-cased hives should be struck sideways at the corners, or wherever the wood is most solid, with a mallet covered with felt or leather, to prevent splitting their outer casings.—Ed.

QUERY NO. 120.—Do you agree with the statement that 'Ligurians are first-rate breeders, but indifferent honey-gatherers?'—A. J.

REPLY TO QUERY NO. 120.—This absurd proposition is so contradictory that we almost wonder it can be seriously entertained for a moment. It would be as reasonable to charge a man, having only a small income, with being a *great spendthrift*.

The admission that the Ligurians are superior as breeders in our opinion quashes the charge against them, as it must be evident, that if they can produce more swarms than an equal number of blacks, they must have worked much harder both as honey-gatherers and as nurses. If there is any fault in their honey-storing, it must be caused by the folly of their owners, in not providing sufficient breeding-space (empty cells in fact) in the stock hive, in which the queen may indulge her extraordinary propensity

for egg-laying, and consequently they swarm out. The cry against them, as against the Extractor, is raised by those who have not the means, or the ability to control the one, or use the other, through a dogged persistence in the use of hives with fixed combs.—Ed.

#### NOTICES TO CORRESPONDENTS & INQUIRERS.

C. H. E., being greatly interested in the best mode for uniting condemned cottagers' bees, requests Mr. Alfred Rusbridge to be so obliging as to give an account *in extenso*, in next month's *Journal*, of his *modus operandi* for uniting four of the cottagers' hives of bees into one, and whether such method was successful in preventing the bees from fighting.

W.—This is a case illustrative of the folly of the skep system of nading. The combs in the lower (nadir) part are youngest, and probably contain less pollen than the upper part, or stock hive. The cause of the bees hanging out last year was their inability to increase in numbers, through being, what we call, *pollen-bound*. See Reply to Query 3, page 14, vol. I.—Invaluable to you. If you have determined to see what weight 'the stock' will achieve during the ensuing season, by no means place the newest combs above the pollen-bound part: but when the weather breaks encourage the bees by gentle feeding, and when fairly strong, place a super on top—storify in fact—and give the bees a chance of clearing out some of their pollen, by using it for the breeding which will ensue. Keep the newer combs lowest, let the bees build new combs in the super, and so cause them to use up their stores in the middle, or 'old' breeding-apartment, and thus relieve the hive. In the other case, the idea of driving out a swarm and mounting the *driven hive* on the top of another stock, for the purpose of obtaining 'honey,' is simply absurd. You may in the end find your 'top hamper' heavy, but it will not be with honey alone, as it will have a large admixture of pollen.

BEEES FROM ITALY.—Since the advertisement appeared in our last, the breeder mentioned therein has stipulated that when the bees arrive at their destination, they shall be examined by two gentlemen, who shall testify to their condition, and if 'bad or dead' the colonies were to be immediately returned with the 'attestation' of the two gentlemen, and another attestation from the Post Office, to prove that the bees were examined on the day of delivery; and all the costs of sending the bees back to Italy were to be paid (franed), and then he would send others.

Thinking it very probable that many would either have to pay triple cost of freight, &c., and perhaps be no better off at last, or that, to avoid the further outlay, they might be induced to keep first lots not worth half the money, we have declined to proceed further in the business, and have returned all the monies forwarded.

'Will Mr. Cowan kindly oblige me by stating how he applies his bee-traps to his supers during bad weather in summer, while they are on the hives?'—*Arley, near Bouldley*.

NOTICE.—As the Index and Title-page to Vol. II. occupy four pages, which, though valuable for reference, would, if forming part of present number, displace much valuable information, we have determined to issue them in a separate form, price 3d., and trust the arrangement will be agreeable to our subscribers and friends.

Covers for binding, including title-page and index, will therefore be sent post free for 1s. 3d.

We regret that, through pressure of matter, we have been obliged reluctantly to postpone some important letters to next month.

# BRITISH BEE-KEEPERS' ASSOCIATION.

COMMITTEE MEETING, MARCH, 27, 1875.

Present—Messrs. C. N. ABBOTT, HOOKER, CHESHIRE, and HON. SEC. Mr. HOOKER in the Chair.

THE Secretary produced the audited Balance Sheet, which had been printed and forwarded to all the Members. The thanks of the Committee were ordered to be given to W. H. Hughes, Esq., for the care and attention bestowed in auditing the accounts. The Secretary announced that on his application the Linnean Society had granted the use of their rooms to the Association for the contemplated *Conversazione*, subject to minor details of arrangement with the Secretaries. The Secretary also reported that he had had an interview with the General Manager of the Crystal Palace, and ascertained from him the terms on which the next Show could be held there, which the Committee, on consideration, resolved to accept. A letter from E. MELLADREW, Esq., was then read in which he placed at the disposal of the Committee the sum of 5*l.* for a Special Prize at the next Show. The Rev. Andrew Johnson, of Kidbrooke Park, Blackheath, was then elected Vice-President, and also placed on the Acting Committee, vice Mr. J. Smith Turner, resigned. Mr. Hooker gave notice of motion for an alteration of the 4th Bye-law of the Acting Committee; and the Secretary having been instructed to complete the arrangements for the contemplated *Conversazione*, the meeting separated.

CONVERSAZIONE.—The Hon. Sec. has the pleasure to announce that, as will be seen by the above minutes, the *Conversazione* will be held in the rooms of the Linnean Society, probably on or about the 6th day of May next, but the exact date is not yet fixed, but due notice will be given by post to all members. The Committee hope this arrangement will be appreciated by the members as a means of spending a pleasant evening—creating a friendly feeling amongst each other—as well as tending to the advancement of Bee-keeping, whose interest all have in view. The attendance of as many members as possible is earnestly invited, together with any friends interested in Apian matters. Short papers bearing on Bee-keeping may be read and afterwards discussed by the members, and the exhibition of portable objects of scientific interest, both apian and general, are specially desired; those gentlemen possessing microscopes are requested to bring them with lamp and objects likely to prove interesting. The Prize Schedule will also be discussed. Members intending to favour the Committee with their presence will please apply (enclosing postage) to the Hon. Sec. for tickets for selves and friends as early as possible, it being necessary to ascertain the number likely to be present. The hour of meeting is suggested to be 6 p.m.

EXHIBITION, CRYSTAL PALACE, Sept. 21st, 22nd, 23rd, 1875.—In order to enable the Committee to offer a goodly list of prizes, donations either towards the General Fund or for Special Prizes are earnestly solicited. As a nucleus the following are promised:—The Crystal Palace Company, 25*l.*; E. Melladew, Esq., Special Prize, 5*l.*

JOHN HUNTER, Hon. Sec., Ealing Rise, Ealing.

## OUR WANT AND SALE COLUMN.

For Particulars apply to C. N. ABBOTT, Hanwell, W. London.

No.		s.	d.
97	Square queen-cages, perforated zinc, to release queens within the hive, the most simple ever made, 6 <i>d.</i> each ... .. per dozen	5	0
98	Wanted.—A large quantity of Puff Ball, dried.		
99	Wanted.—Evans' Poem on Bees, either to purchase, or on loan at per month. Security given.		
101	Wanted.—Two healthy stocks of Black Bees. Good condition, low figure. Great Western Railway.		
103	Two of Taylor's dividing hives, stained and varnished, fitted up with 8 improved bar-frames ... .. each	10	6
104	Two Swiss bar-frame hives painted, with 8 bar-frames and floor-board ... .. each	8	0
105	Two Neighbour's zinc bee-feeders with floats each	2	6
106	Two Neighbour's fountain zinc bee-feeders with floats ... .. each	3	6
107	'The American Bee-keeper's Manual.' By J. B. Miner, 350 pages, with 35 engravings	6	6
108	'The Management of Bees.' By S. Bagster, 2nd edition, 240 pages with 40 engravings ...	6	6
109	'An Inquiry into the Nature, Order and Government of Bees.' By Rev. John Thorley, 2nd edition, 1765, 158 pages ... ..	4	6
113	Carr's improved mahogany observatory revolving bar-frame hive, second hand ...	60	0
118	Wanted.—Any quantity of empty worker comb. C. J. Smith, Stroud, Gloucestershire.		
119	Box Hive, containing 2 stock-boxes, 2 medium supers, and 4 small ditto, with access from stock-boxes to each or all of the supers, small window in each ... ..	15	0
120	Neighbour's improved bar and frame stock hive straw, with wood frame and one window ...	20	0
121	Wanted.—Dr. Dunbar on Bees. State condition and price post free.		
123	Wanted.—'Guide de l'Apiculteur,' par M. Debeauvoys, 6e édition. Will give 3 <i>s.</i> 6 <i>d.</i> for clean, perfect copy, post-free.		
126	A Langstroth hive, in first-rate order, never been used, outer case inch thick ... ..	40	0
127	Two Pettigrew ekes, fit 18 in. hive ... .. each	4	0
128	Wanted.—20 stocks of black bees, in skeps, must be healthy. S. W. Railway preferred. Wright no object, but should have plenty of bees.		
131	Several tin fumigators, quite new ... .. each	2	0
133	'The Management of Bees.' By Samuel Bagster. 244 pages and 40 illustrations. Free by post ... ..	6	0

## SALE COLUMN—CONTINUED.

No.		s.	d.
134	Wanted.—A clean copy of the <i>British Bee Journal</i> for June 1874.		
135	Wanted.—Three or four supers of last year's honey. Good. Eight to twelve pounds each.		
136	Three hives of hybrid Italian bees, in boxes with glass windows on three sides—very healthy—with young queens of last summer, will travel any distance, Somersetshire, each	40	0
137	Wanted.—The October No. of the <i>British Bee Journal</i> for 1873, 6 <i>d.</i> sent on receipt of post-card		
138	For Sale.—One or more strong stocks of pure Ligurian bees, in Woodbury frame hives, Dublin ... .. each	50	0
139	'American Nest Hives' (by K. B. Edwards), set of four, with ekes, &c., complete, new ...	12	6
140	Aston's drone trap, new ... ..	3	6
141	'Full and Plain Directions for the Management of Bees to the greatest Advantage.' By the old and able author, John Keys. Post free, in excellent preservation ...	7	6
142	Wanted.—A fertile queen-bee, to introduce to a queenless stock. Pure Ligurian preferred. Chichester.		
143	Two 10-frame hives, projecting ends to frames. one window with three glasses, outer cases, super-cover and roof, floor-boards, crown-boards, and quilt ... .. each	25	0
144	For Sale.—Four swarms of hybrid Italians, sometime in May ... .. each	20	0
145	Taylor's 'Manual of Bee-keeping' ... ..	2	6
146	Six stocks of black bees (Leamington), the whole or each ... ..	115	0
147	One stock of hybrids, Ligurian mother, double-cased hive, with stand, roof, and cover. Leamington ... ..	55	0
148	For Sale.—Strong swarms in straw hives in May and June. Lincolnshire ... .. each	15	0
149	Wanted.—To buy or borrow Vol. 1. of the <i>British Bee Journal</i> . Mr. Harvey Wall, Rushwood, Droitwich.		
150	Wanted.—Clean new straight worker comb—any quantity. J. E. Newland, Wandsworth Common.		
151	Good useful bar-frame hive, same size produced 70 lb. super honey last year (used) ... ..	7	6
152	Wood and straw hive, 9 frames, deeper than Woodbury (used) ... ..	7	0
153	Woodbury wood and glass super, hold 30 lbs., baitze cover included (used) ... ..	7	0

OUR WANT AND SALE COLUMN—Continued.

No.		s.	d.	No.		s.	d.
154	Queen-rearing nucleus hive, as used in Switzerland (used) ... ..	2	6	170	Large 13-frame hive, with frames, Quinby size, double-cased front and back, with glass front and 2 division boards ... ..	15	0
155	Good Woodbury hive, dovetailed, inch thick, 10 frames (used) ... ..	6	0	171	Glass unicomb hive, mahogany frame-work, to hold 3 frames, Woodbury size ... ..	25	0
156	Woodbury glass bar super, good condition, hold 30 lbs. ... ..	8	0	172	Nucleus hive, with Cheshire's twin frames ... ..	4	0
157	Transferring board, equal to the best ... ..	7	6	173	Small bee-house, to hold 2 hives, stands on four legs, and has doors at back ... ..	15	0
158	Roofs, simple but efficient, not new, one dozen ... ..	12	6	174	Woodbury super, with glass top and sides, mahogany frame, and adapting board ... ..	7	6
159	Woodbury floor-board, clamped ... ..	2	0	175	Two Octagonal supers, to hold 25 lbs. each, wood and glass ... ..	10	0
160	Honey slinger, takes Woodbury frames, not quite new ... ..	30	0	176	Neighbour's improved Cottage hive, second-hand, minus the 3 bell-glasses ... ..	15	0
161	'The Female Monarchy.' By Rev. John Thorley, 1744, 206 pages ... ..	3	6	177	Single frame unicomb hive, for exhibition purposes ... ..	7	6
162	Huish on Bees, 1844 ... ..	2	6	178	Seven pounds of bees-wax, took second prize at Palace ... ..	15	0
163	Murphey's Honey Extractor direct from the maker ... ..	70	0	179	Novice's tin corners, imported from America, per set ... ..	0	3
164	Plain Woodbury hive, with top and floor-board complete ... ..	5	0	180	Three Octagon boxes, each with glass window and shutter, to use on the storifying system ... ..	10	0
165	Second-hand Cottage Woodbury hive (Symington's) ... ..	15	0	181	Large Octagon box with 3 windows and shutters, has been used as a uadir ... ..	5	0
166	The Abbott hive, new shape, second-hand ... ..	17	6				
167	Second-hand hive, with 6 frames, Woodbury size, double-cased ... ..	5	0				
168	Forty queen-boxes, twopence each, or the lot ... ..	5	0				
169	Octagon super, wood and glass, to hold 25 lbs. ... ..	5	0				

BEES, HIVES, BEE FURNITURE.

TWO First Prizes and Certificates were awarded to Mr. C. N. ABBOTT, at the late Crystal Palace Show, in Class II. 'For the best Skep, or Box-hive, for depriving purposes, for Cottager's use, that can be supplied for 3s.' That exhibited by the Editor of the *British Bee Journal* was awarded First Prize and Certificate.

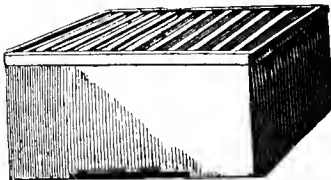

Crystal Palace Cottager's Hive, price 3s.

IN Class VI. 'For the most economical (best and cheapest) complete Hive, on the moveable comb principle, for cottager's use,' that exhibited by the Editor of the *British Bee Journal* was also awarded First Prize and Certificate.

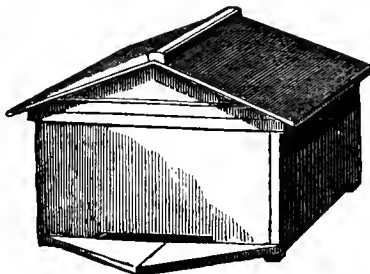

Crystal Palace Cottager's Hive, No. 2, price 6s. 6d.

As it is probable that these Hives will be in great demand in the Spring, it is hoped, to prevent disappointment, that orders will be at once forwarded to Mr. C. N. ABBOTT, Bee-Master, Hanwell.

VULCANITE SHEETS for Division Boards, non-conducting, non-condensing, non-absorbent. Occupy scarcely any space; fit close in hive and form inner walls which render double sides to hives unnecessary. Cut to fit any hive on dimensions being given. Price 2s. per superficial foot. A large reduction where a quantity is taken.

INDIA RUBBER GLOVES, to be worn over woollen gloves, sting-proof, 6s. 6d. per pair, post-free.

TIN SHOVELS, 8d. each, post free, our own invention, for use with the Feeding Bottles.

FEEDING BOTTLES, 6d. and 1s. each.



THE KNIFE SCRAPER, for cleaning floor-board hives, frames, &c., a speciality—spring steel, useful as a honey knife, or in lieu of a tin shovel for feeding. 2s. 6d. post free.



THE BEE QUIETER, the invention of the Hon. and Rev. Henry Bligh. Price 2s. 6d. Fumigator to match, 1s. 6d.

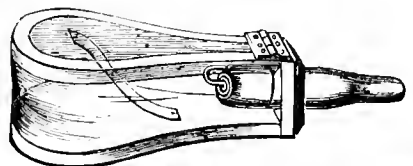

PURE imported LIGURIAN QUEEN BEES, at various prices as usual. See Special Advertisement.

ORDERS also received for the famous CARR-STEWARTON HIVE, which obtained First Prize and Certificate at Crystal Palace, as the best hive on the storifying system. For particulars see last page of Journal.

ORDERS received also for 'Langstroth on the Hive and Honey Bee,' price 10s. 6d. post free.

SWARMS of Bees, headed by imported Ligurian Queens, 42s. each, in the Spring.









